



# HCT CO., LTD.

## CERTIFICATE OF COMPLIANCE FCC Certification

**Applicant Name:**  
LG Electronics MobileComm U.S.A., Inc.

**Address:**  
10101 Old Grove Road, San Diego, CA 92131

**Date of Issue:**  
May 09, 2012

**Test Site/Location:**  
HCT CO., LTD., 105-1, Jangam-ri, Majang-Myeon,  
Icheon-si, Kyunggi-Do, Korea

**Report No.:** HCTR1204FR28-1

**HCT FRN:** 0005866421

**FCC ID : ZNFP940H**

**APPLICANT : LG Electronics MobileComm U.S.A., Inc.**

**FCC Model(s):** LG-P940h  
**EUT Type:** Cellular/PCS GSM/GPRS/EDGE & Cellular WCDMA/HSDPA/HSUPA Phone with Bluetooth and WLAN/NFC

**Max. RF Output Power:** 802.11a\_UNII-II Band(10.24 dBm), 802.11n\_UNII-II Band(8.71 dBm) /  
802.11a\_UNII-III Band(11.21 dBm), 802.11n\_UNII-III Band(10.36 dBm)

**Frequency Range:** 5260 MHz - 5320 MHz (UNII-II Band)  
5500 MHz - 5700 MHz (UNII-III Band)

**Modulation type** DSSS,OFDM

**FCC Classification:** Unlicensed National Information Infrastructure (UNII)

**FCC Rule Part(s):** Part 15.407

**Engineering Statement:**

The measurements shown in this report were made in accordance with the procedures indicated, and the emissions from this equipment were found to be within the limits applicable. I assume full responsibility for the accuracy and completeness of these measurements, and for the qualifications of all persons taking them.

HCT CO., LTD. Certifies that no party to this application has subject to a denial of Federal benefits that includes FCC benefits pursuant to section 5301 of the Anti-Drug Abuse Act of 1998,21 U.S. C.853(a)

**Report prepared by**

**: Jong Seok Lee**

**Test engineer of RF Team**

**Approved by**

**: Chang Seok Choi**

**Manager of RF Team**

This report only responds to the tested sample and may not be reproduced, except in full, without written approval of the HCT Co., Ltd.

FCC PT.15.247 TEST REPORT	FCC CERTIFICATION REPORT		<a href="http://www.hct.co.kr">www.hct.co.kr</a>
Test Report No. HCTR1204FR28-1	Date of Issue: May 09, 2012	EUT Type: Cellular/PCS GSM/GPRS/EDGE & Cellular WCDMA/HSDPA/HSUPA Phone with Bluetooth and WLAN/NFC	FCC ID: ZNFP940H

# Version

TEST REPORT NO.	DATE	DESCRIPTION
HCTR1204FR28	April 27, 2012	- First Approval Report
HCTR1204FR28-1	May 09, 2012	- Change the Max. RF Output Power(page1 and 3)

# Table of Contents

- 1. GENERAL INFORMATION ..... 4
- 2. EUT DESCRIPTION ..... 4
- 3. Scope ..... 5
- 4. INSTRUMENT CALIBRATION..... 5
- 5. FACILITIES AND ACCREDITATIONS ..... 5
  - 5.1 FACILITIES ..... 5
  - 5.2 EQUIPMENT ..... 5
- 6. SUMMARY OF TEST RESULTS ..... 6
- 7. DESCRIPTION OF DYNAMIC FREQUENCY SELECTION TEST..... 7
  - 7.1 APPLICABILITY ..... 7
  - 7.2 REQUIREMENTS..... 7
  - 7.3 DFS DETECTION THRESHOLD VALUES ..... 9
  - 7.4 PARAMETERS OF DFS TEST SIGNALS..... 9
  - 7.5 TEST AND MEASUREMENT SYSTEM ..... 1 1
  - 7.6 DESCRIPTION OF EUT..... 1 3
  - 7.7 UNII-II TEST RESULT ..... 1 4
  - 7.8 UNII-III TEST RESULT ..... 2 0
- 8. LIST OF TEST EQUIPMENT ..... 2 4

FCC PT.15.247 TEST REPORT		FCC CERTIFICATION REPORT		<a href="http://www.hct.co.kr">www.hct.co.kr</a>
Test Report No. HCTR1204FR28-1	Date of Issue: May 09, 2012	EUT Type: Cellular/PCS GSM/GPRS/EDGE & Cellular WCDMA/HSDPA/HSUPA Phone with Bluetooth and WLAN/NFC		FCC ID: ZNF940H



## 1. GENERAL INFORMATION

**Applicant:** LG Electronics MobileComm U.S.A., Inc.  
**Address:** 10101 Old Grove Road, San Diego, CA 92131  
**FCC ID:** ZNFP940H  
**EUT Type:** Cellular/PCS GSM/GPRS/EDGE & Cellular WCDMA/HSDPA/HSUPA Phone with Bluetooth and WLAN/NFC  
**Model Name:** LG-P940h  
**Date(s) of Tests:** April 20, 2012 ~ April 24, 2012  
**Contact person:** Name: Hee Joo An  
 Phone #: +82-2-2033-1123  
**Place of Tests:** HCT Co., Ltd.  
 105-1, Jangam-ri , Majang-Myeon, Icheon-si, Kyunggi-Do, 467-811, KOREA.  
 (IC Recognition No. : 5944A-3)

## 2. EUT DESCRIPTION

<b>EUT Type</b>	Cellular/PCS GSM/GPRS/EDGE & Cellular WCDMA/HSDPA/HSUPA Phone with Bluetooth and WLAN/NFC
<b>Model Name</b>	LG-P940h
<b>Power Supply</b>	DC 3.7 V
<b>Battery type</b>	Li-ion Battery(Standard)
<b>Frequency Range</b>	TX: 5260 MHz ~ 5320 MHz RX: 5500 MHz ~ 5700 MHz
<b>Max. RF Output Power:</b>	802.11a_UNII-II Band(10.24 dBm), 802.11n_UNII-II Band(8.71 dBm) / 802.11a_UNII-III Band(11.21 dBm), 802.11n_UNII-III Band(10.36 dBm)
<b>Modulation Type</b>	DSSS, OFDM
<b>Antenna Specification</b>	Manufacturer: Mobitech Antenna type: Planar Inverted F Antenna Peak Gain : 0.95 dBi (5.3 GHz Band), 0.35 dBi (5.6 GHz Band)

<b>FCC PT.15.247 TEST REPORT</b>	<b>FCC CERTIFICATION REPORT</b>		<a href="http://www.hct.co.kr">www.hct.co.kr</a>
<b>Test Report No.</b> HCTR1204FR28-1	<b>Date of Issue:</b> May 09, 2012	<b>EUT Type:</b> Cellular/PCS GSM/GPRS/EDGE & Cellular WCDMA/HSDPA/HSUPA Phone with Bluetooth and WLAN/NFC	<b>FCC ID:</b> ZNFP940H



### 3. Scope

This report has been prepared to demonstrate compliance with the requirements for Dynamic Frequency Selection(DFS) as stated in FCC 06-96. Testing was performed LG-P940h in accordance with the measurement procedure described in Appendix B of FCC 06-96. As of July 20, 2007 all devices operating in the UNII-II Band and /or the UNII-III Bands must comply with the DFS requirements. As the EUT does not have radar detection capability it was evaluated as a Client Only Device.

### 4. INSTRUMENT CALIBRATION

The measuring equipment, which was utilized in performing the tests documented herein, has been calibrated in accordance with the manufacturer's recommendations for utilizing calibration equipments, which is traceable to recognized national standards.

### 5. FACILITIES AND ACCREDITATIONS

#### 5.1 FACILITIES

The SAC(Semi-Anechoic Chamber) and conducted measurement facility used to collect the radiated data are located at the 105-1, Jangam-ri, Majang-Myeon, Icheon-si, Kyunggi-Do, 467-811, Korea. The site is constructed in conformance with the requirements of ANSI C63.4. (Version :2003) and CISPR Publication 22. Detailed description of test facility was submitted to the Commission and accepted dated March 02, 2011 (Registration Number: 90661)

#### 5.2 EQUIPMENT

Radiated emissions are measured with one or more of the following types of Linearly polarized antennas: tuned dipole, bi-conical, log periodic, bi-log, and/or ridged waveguide, horn. Spectrum analyzers with pre-selectors and quasi-peak detectors are used to perform radiated measurements. Conducted emissions are measured with Line Impedance Stabilization Networks and EMI Test Receivers. Calibrated wideband preamplifiers, coaxial cables, and coaxial attenuators are also used for making measurements.

All receiving equipment conforms to CISPR Publication 16-1, "Radio Interference Measuring Apparatus and Measurement Methods."

FCC PT.15.247 TEST REPORT		FCC CERTIFICATION REPORT		<a href="http://www.hct.co.kr">www.hct.co.kr</a>
Test Report No. HCTR1204FR28-1	Date of Issue: May 09, 2012	EUT Type: Cellular/PCS GSM/GPRS/EDGE & Cellular WCDMA/HSDPA/HSUPA Phone with Bluetooth and WLAN/NFC	FCC ID: ZNFP940H	

## 6. SUMMARY OF TEST RESULTS

Band	Parameter	Measured	Limit	Result
UNII-II	Channel Move Time	554.828 ms	10 seconds	PASS
	Channel Closing Transmission Time	< 200 ms + 866.56 $\mu$ s (aggregate)	200 ms + aggregate of 60 ms over remaining 10 second period	PASS
	Non-occupancy Period	Monitored > 30 minutes (No transmission occurred)	30 minutes	PASS
UNII-III	Channel Move Time	585.115 ms	10 seconds	PASS
	Channel Closing Transmission Time	< 200 ms + 891.36 $\mu$ s (aggregate)	200 ms + aggregate of 60 ms over remaining 10 second period	PASS
	Non-occupancy Period	Monitored > 30 minutes (No transmission occurred)	30 minutes	PASS

<b>FCC PT.15.247 TEST REPORT</b>	<b>FCC CERTIFICATION REPORT</b>		<a href="http://www.hct.co.kr">www.hct.co.kr</a>
<b>Test Report No.</b> HCTR1204FR28-1	<b>Date of Issue:</b> May 09, 2012	<b>EUT Type:</b> Cellular/PCS GSM/GPRS/EDGE & Cellular WCDMA/HSDPA/HSUPA Phone with Bluetooth and WLAN/NFC	<b>FCC ID:</b> ZNF940H

## 7. DESCRIPTION OF DYNAMIC FREQUENCY SELECTION TEST

### 7.1 APPLICABILITY

The following table from FCC 06-96 lists the applicable requirements for the DFS testing. The device evaluated in this report is considered a client device without radar detection capability.

Requirement	Operation Mode		
	Master	Client Without Radar Detection	Client With Radar Detection
Non-Occupancy Period	Yes	Not required	Yes
DFS Detection Threshold	Yes	Not required	Yes
Channel Availability Check Time	Yes	Not required	Not required
Uniform Spreading	Yes	Not required	Not required
U-NII Detection Bandwidth	Yes	Not required	Yes

Table 1-1. DFS Applicability

Requirement	Operation Mode		
	Master	Client Without Radar Detection	Client With Radar Detection
DFS Detection Threshold	Yes	Not required	Yes
Channel Closing Transmission Time	Yes	Yes	Yes
Channel Move Time	Yes	Yes	Yes
U-NII Detection Bandwidth	Yes	Not required	Yes

Table 1-2. DFS Applicability During Normal Operation

### 7.2 REQUIREMENTS

Per FCC 06-96 the following are the requirements for Client Devices:

- a) A Client Device will not transmit before having received appropriate control signals from a Master Device.
- b) A Client Device will stop all its transmissions whenever instructed by a Master Device to which it is associated and will meet the Channel Move Time and Channel Closing Transmission Time requirements.

The Client Device will not resume any transmissions until it has again received control signals from a Master Device.

<b>FCC PT.15.247 TEST REPORT</b>	<b>FCC CERTIFICATION REPORT</b>		<a href="http://www.hct.co.kr">www.hct.co.kr</a>
<b>Test Report No.</b> HCTR1204FR28-1	<b>Date of Issue:</b> May 09, 2012	<b>EUT Type:</b> Cellular/PCS GSM/GPRS/EDGE & Cellular WCDMA/HSDPA/HSUPA Phone with Bluetooth and WLAN/NFC	<b>FCC ID:</b> ZNF940H

- c) If a Client Device is performing In-Service Monitoring and detects a Radar Waveform above the DFS Detection Threshold, it will inform the Master Device. This is equivalent to the Master Device detecting the Radar Waveform and d) through f) of section 5.1.1 apply.
- d) Irrespective of Client Device or Master Device detection the Channel Move Time and Channel Closing Transmission Time requirements remain the same.

Channel Move Time and Channel Closing Transmission Time requirements are listed following table.

Parameter	Value
Non-occupancy period	Minimum 30 minutes
Channel Availability Check Time	60 seconds
Channel Move Time	10 seconds See Note 1.
Channel Closing Transmission Time	200 milliseconds + an Aggregate of 60 milliseconds over Remaining 10 second period. See Notes 1 and 2.
U-NII Detection Bandwidth	Minimum 80 % of the U-NII 99 % transmission Power bandwidth. See Note 3.
<p><b>Note 1: The instant that the Channel Move Time and the Channel Closing Transmission Time begins is</b> as follows:</p> <ul style="list-style-type: none"> <li>• For the Short Pulse Radar Test Signals this instant is the end of the Burst.</li> <li>• For the Frequency Hopping radar Test Signal, this instant is the end of the last radar Burst generated.</li> <li>• For the Long Pulse Radar Test Signal this instant is the end of the 12 second period defining the Radar Waveform.</li> </ul> <p><b>Note 2: The Channel Closing Transmission Time is comprised of 200 milliseconds starting at</b> the begging of the Channel Move Time plus any additional intermittent control signals required to facilitate a Channel move (an aggregate of 60 milliseconds) during the remainder of the 10 second period. The aggregate duration of control signals will not count quiet periods in between transmissions.</p> <p><b>Note 3: During the U-NII Detection Bandwidth detection test, Radar type 1 is used and for each</b> frequency step the minimum percentage of detection is 90 percent. Measurements are performed with no data traffic.</p>	

Table 1-3: DFS Response requirements

FCC PT.15.247 TEST REPORT		FCC CERTIFICATION REPORT		<a href="http://www.hct.co.kr">www.hct.co.kr</a>
Test Report No. HCTR1204FR28-1	Date of Issue: May 09, 2012	EUT Type: Cellular/PCS GSM/GPRS/EDGE & Cellular WCDMA/HSDPA/HSUPA Phone with Bluetooth and WLAN/NFC		FCC ID: ZNFP940H



### 7.3 DFS DETECTION THRESHOLD VALUES

The DFS detection thresholds are defined for Master devices and Client Devices with In-service monitoring. These detection thresholds are listed in the following table.

Maximum Transmit Power	Value (See Notes 1 and 2)
≥ 200 milliwatt	-64 dBm
< 200 milliwatt	-62 dBm
<p>Note 1: This is the level at the input of the receiver assuming a 0 dBi receive antenna.</p> <p>Note 2: Throughout these test procedures an additional 1 dB has been added to the amplitude of the test transmission waveforms to account for variations in measurement equipment. This will ensure that the test signal is at or above the detection threshold level to trigger a DFS response.</p>	

Table 1-4: Detection Thresholds for Master Devices and Client Devices with Radar Detection

### 7.4 PARAMETERS OF DFS TEST SIGNALS

As the EUT is a Client Device with no Radar Detection only one type radar pulse is required for the testing. Radar Pulse type 1 was used in the evaluation of the Client device for the purpose of measuring the Channel Move Time and the Channel Closing Transmission Time. Table 3-5 lists the parameters for the Short Pulse Radar Waveforms. A plot of the Radar pulse Type 1 used for testing is included in Section 5.0 of this report.

Radar Type	Pulse Width (µsec)	PRI (µsec)	Number Of Pulses	Minimum Percentage of Successful Detection	Minimum Number of Trials
1	1	1428	18	60 %	30
2	1-5	150-230	23-29	60 %	30
3	6-10	200-500	16-18	60 %	30
4	11-20	200-500	12-16	60 %	30
Aggregate (Radar Types 1-4)				80 %	120

Table 1-5: Parameters for Short Pulse Radar Waveforms

Radar Type	Pulse Width (μsec)	Chirp Width (MHz)	PRI (μsec)	Number Of Pulses Per Burst	Number Of Burst	Minimum Percentage of Successful Detection	Minimum Number of Trials
5	50 - 100	5 - 20	5 - 20	1 - 3	8 - 20	60 %	30
Table 1-6. Parameters for Long Pulse Radar Waveforms							

Radar Type	Pulse Width (μsec)	PRI (μsec)	Pulse Per Hop	Hopping Rate (kHz)	Hopping Sequence Length (msec)	Minimum Percentage of Successful Detection	Minimum Number of Trials
6	1	333	9	0.333	300	70 %	30
Table 1-7. Parameters for Long Pulse Radar Waveforms							

## 7.5 TEST AND MEASUREMENT SYSTEM

### General Test Setup Procedure:

1. Connect FCC approved Master AP to a network, via wired Ethernet, that allows connection to an FTP server.
2. Associate the EUT with the Master AP.
3. Launch the FTP application on the EUT.
4. Connect to the FTP server application to the FTP server hosting the file
5. Initiate an FTP download of the file from the host.
6. Monitor the channel loading during transfer.
7. Reduce the maximum allowed data rate for the Master AP, using the AP's GUI interface.
8. Repeat steps 5-7 until the channel loading is as close to 20 % as possible.
9. Record the data rate setting on the Master AP and the channel loading.
10. While the system is performing an FTP transfer using the settings from item 9 above, perform the Channel Closing Transmission Time and Channel Move Time Measurements as required by FCC 06-96 using a conducted test.

### PROCEDURE

The FCC 06-96 describes a radiated test setup and a conducted test setup. A radiated test setup was used for this testing. Figure 3-1 shows the typical test setup. Each one channel selected between 5260 and 5320 MHz, 5500 and 5700 is chosen for the testing.

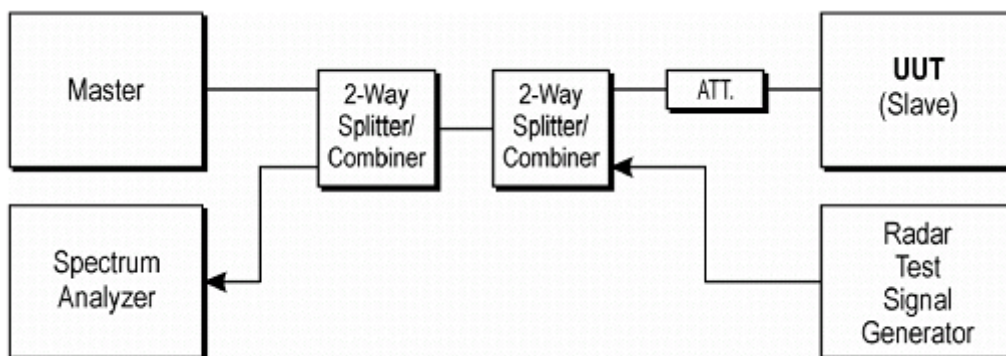

**Figure 3-1. Conducted Test Setup for DFS**

1. The radar pulse generator is setup to provide a pulse at the frequency that the Master and Client are operating. A Type 1 radar pulse with a 1  $\mu$ s pulse width and a 1428  $\mu$ s PRI is used for the testing.

FCC PT.15.247 TEST REPORT	FCC CERTIFICATION REPORT		<a href="http://www.hct.co.kr">www.hct.co.kr</a>
Test Report No. HCTR1204FR28-1	Date of Issue: May 09, 2012	EUT Type: Cellular/PCS GSM/GPRS/EDGE & Cellular WCDMA/HSDPA/HSUPA Phone with Bluetooth and WLAN/NFC	FCC ID: ZNFP940H



2. The vector signal generator is adjusted to provide the radar burst (18 pulses) at a level of approximately -62 dBm at the antenna of the Master device.
3. The Client Device (EUT) is set up per the diagram in Figure 3-1 and communications between the Master device and the Client is established.
4. The MPEG file specified by the FCC ("*6½ Magic Hours*") is streamed from the "file computer" through the Master to the Slave Device and played in full motion video using Media Player Classic Ver.6.4.8.6 in order to properly load the network.
5. The real time spectrum analyzer is set to record about 15 sec window to any transmissions occurring up to and after 10 sec.
6. The system is again setup and the monitoring time is shortened in order to capture the Channel Closing Transmission Time. This time is measured to insure that the Client ceases transmission within 200 ms and the aggregate of emissions occurring after 200 ms up to 10 sec do not exceed 60 ms.

(Note: the channel may be different since the Master and Client have changed channels due to the detection of the initial radar pulse.)

7. After the initial radar burst the channel is monitored for 30 minutes to insure no transmissions or beacons occur. A second monitoring setup is used to verify that the Master and Client have both moved to different channels.

## **SYSTEM CALIBRATION**

**A-50-ohm load is connected in place of the spectrum analyzer, and the spectrum analyzer is connected to a coaxial cable. The signal generator is set to CW mode. The amplitude of the signal generator is adjusted to yield a level of - 62 dBm as measured on the spectrum analyzer.**

**Without changing any of the instrument settings, the spectrum analyzer is reconnected to the common port of the spectrum analyzer combiner or divider.**

**The spectrum analyzer displays the level of the signal generator higher than the client TX level. Because we can not search the signal generator in the spectrum analyzer when the signal generator level is - 62 dBm. The spectrum analyzer will still indicate the level higher than the client TX level.**

<b>FCC PT.15.247 TEST REPORT</b>		<b>FCC CERTIFICATION REPORT</b>		<a href="http://www.hct.co.kr">www.hct.co.kr</a>
<b>Test Report No.</b> HCTR1204FR28-1	<b>Date of Issue:</b> May 09, 2012	<b>EUT Type:</b> Cellular/PCS GSM/GPRS/EDGE & Cellular WCDMA/HSDPA/HSUPA Phone with Bluetooth and WLAN/NFC		<b>FCC ID:</b> ZNFP940H



## 7.6 DESCRIPTION OF EUT

The EUT operates over the 5260 MHz - 5320 MHz and 5500 MHz - 5700 MHz ranges.

The EUT is a slave device without radar detection.

The highest power level within these bands is 11.09 dBm EIRP in the 5260 MHz - 5320 MHz band and 10.89 dBm EIRP in the 5500 MHz – 5700 MHz band.

The EUT antenna has a gain of 0.95 dBi in the 5260 MHz - 5320 MHz band and 0.35 dBi in the 5500 MHz- 5700 MHz band.

The EUT one transmitter/receiver chain connected to a coaxial cable to perform conducted tests.

TPC is not required since the maximum EIRP is less than 500 mW.

The EUT utilizes the 802.11a/n architecture. Two nominal channel bandwidth is implemented: 20 MHz

<b>FCC PT.15.247 TEST REPORT</b>	<b>FCC CERTIFICATION REPORT</b>		<a href="http://www.hct.co.kr">www.hct.co.kr</a>
<b>Test Report No.</b> HCTR1204FR28-1	<b>Date of Issue:</b> May 09, 2012	<b>EUT Type:</b> Cellular/PCS GSM/GPRS/EDGE & Cellular WCDMA/HSDPA/HSUPA Phone with Bluetooth and WLAN/NFC	<b>FCC ID:</b> ZNFP940H

## 7.7 UNII-II TEST RESULT

### RESULT PLOTS\_(UNII-II Band)

Type1 Radar Pulse Number

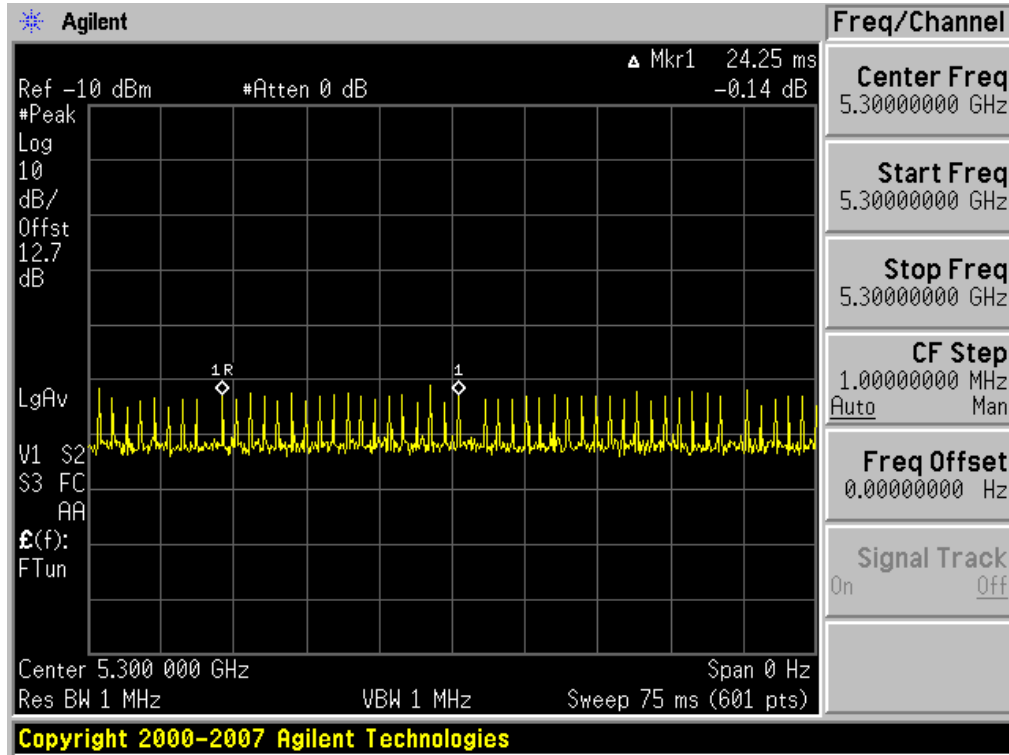

#### Marker Descriptions:

Number of Pulse Form M1R to M1 : 18

FCC PT.15.247 TEST REPORT	FCC CERTIFICATION REPORT		<a href="http://www.hct.co.kr">www.hct.co.kr</a>
Test Report No. HCTR1204FR28-1	Date of Issue: May 09, 2012	EUT Type: Cellular/PCS GSM/GPRS/EDGE & Cellular WCDMA/HSDPA/HSUPA Phone with Bluetooth and WLAN/NFC	FCC ID: ZNFP940H

Type1 PRI

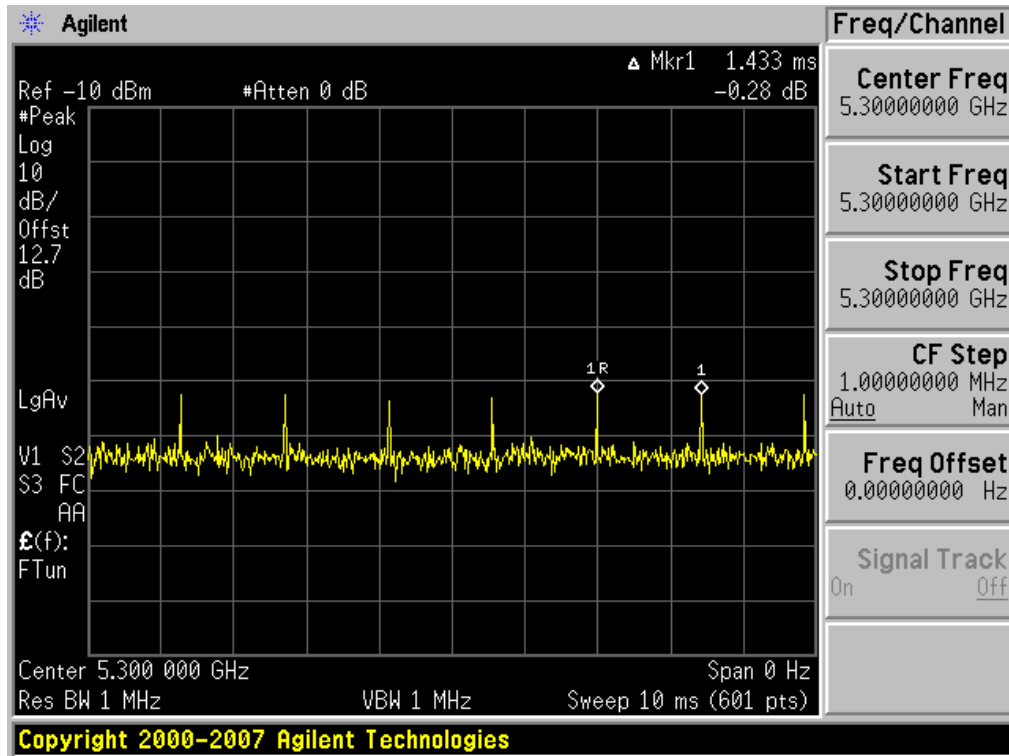

Time Display, Non WLAN Channel Traffic

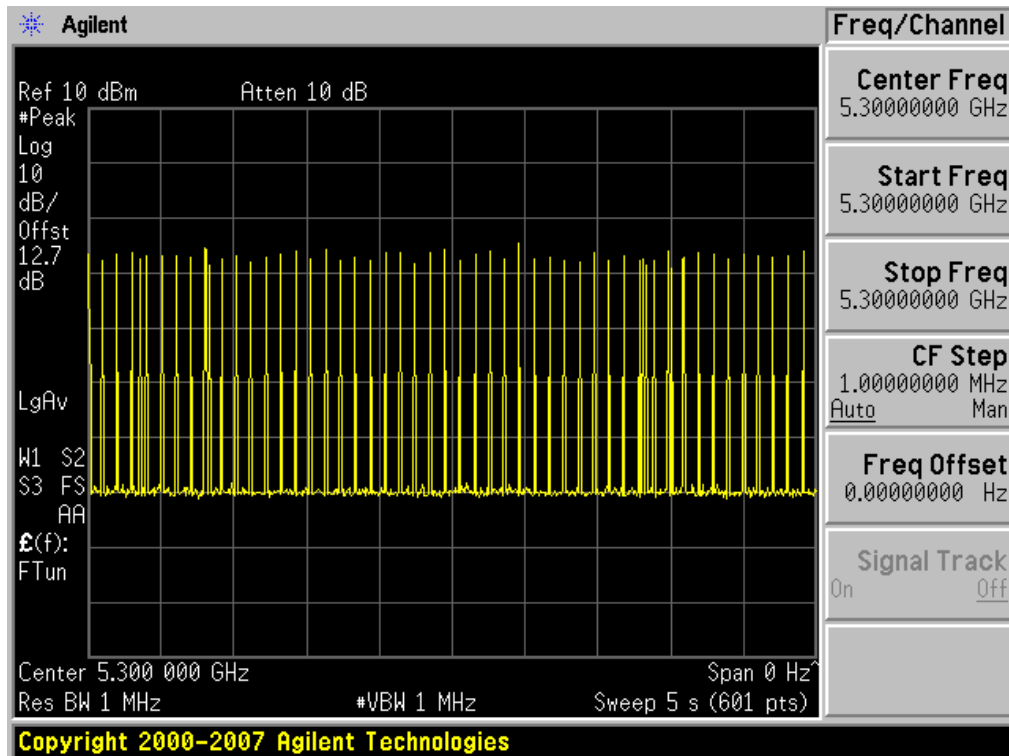

FCC PT.15.247 TEST REPORT		FCC CERTIFICATION REPORT		<a href="http://www.hct.co.kr">www.hct.co.kr</a>
Test Report No. HCTR1204FR28-1	Date of Issue: May 09, 2012	EUT Type: Cellular/PCS GSM/GPRS/EDGE & Cellular WCDMA/HSDPA/HSUPA Phone with Bluetooth and WLAN/NFC		FCC ID: ZNFP940H

Time Display, WLAN Channel Traffic (Streaming Video)

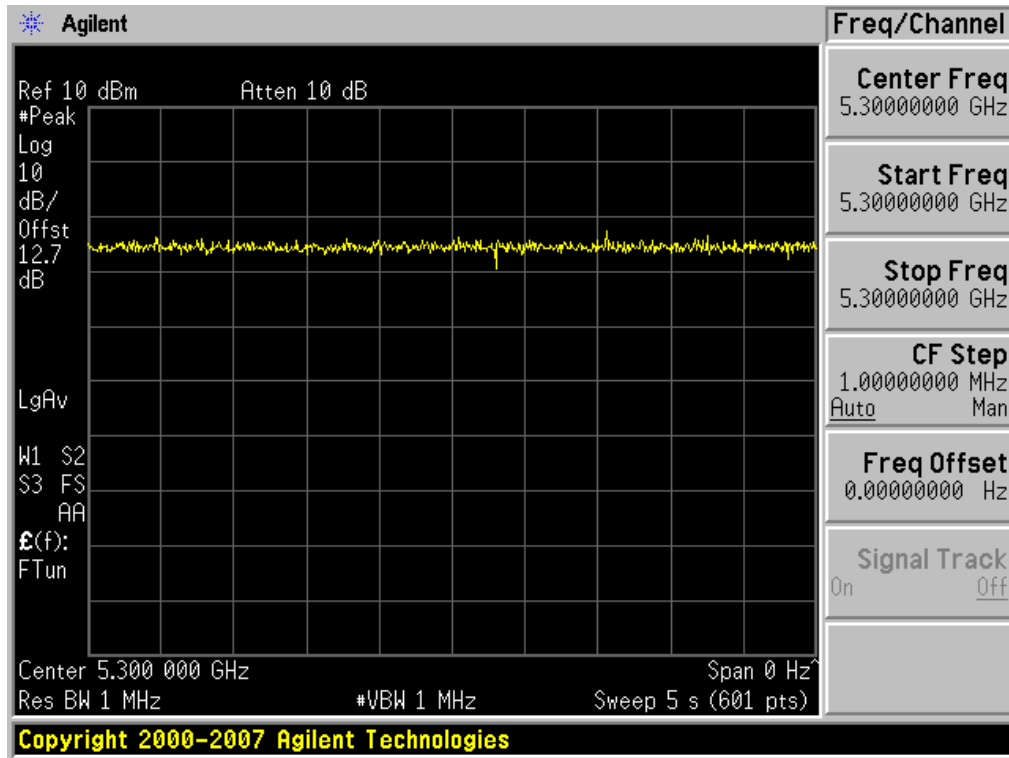

<b>FCC PT.15.247 TEST REPORT</b>	<b>FCC CERTIFICATION REPORT</b>		<a href="http://www.hct.co.kr">www.hct.co.kr</a>
<b>Test Report No.</b> HCTR1204FR28-1	<b>Date of Issue:</b> May 09, 2012	<b>EUT Type:</b> Cellular/PCS GSM/GPRS/EDGE & Cellular WCDMA/HSDPA/HSUPA Phone with Bluetooth and WLAN/NFC	<b>FCC ID:</b> ZNFP940H



Channel Move Time (< 10 sec)

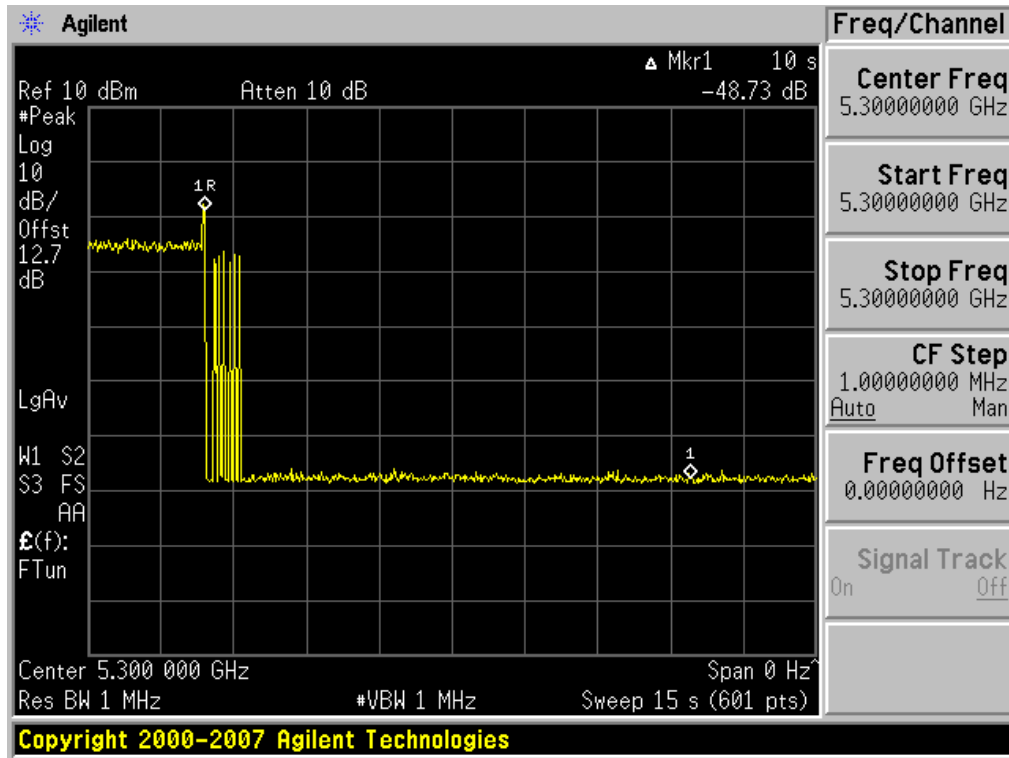

**Marker Descriptions:**

Time from M1R to M1 : 10 s

FCC PT.15.247 TEST REPORT		FCC CERTIFICATION REPORT		<a href="http://www.hct.co.kr">www.hct.co.kr</a>
Test Report No. HCTR1204FR28-1	Date of Issue: May 09, 2012	EUT Type: Cellular/PCS GSM/GPRS/EDGE & Cellular WCDMA/HSDPA/HSUPA Phone with Bluetooth and WLAN/NFC		FCC ID: ZNFP940H

Channel Closing Transmission Time, Aggregate Time After 200 ms

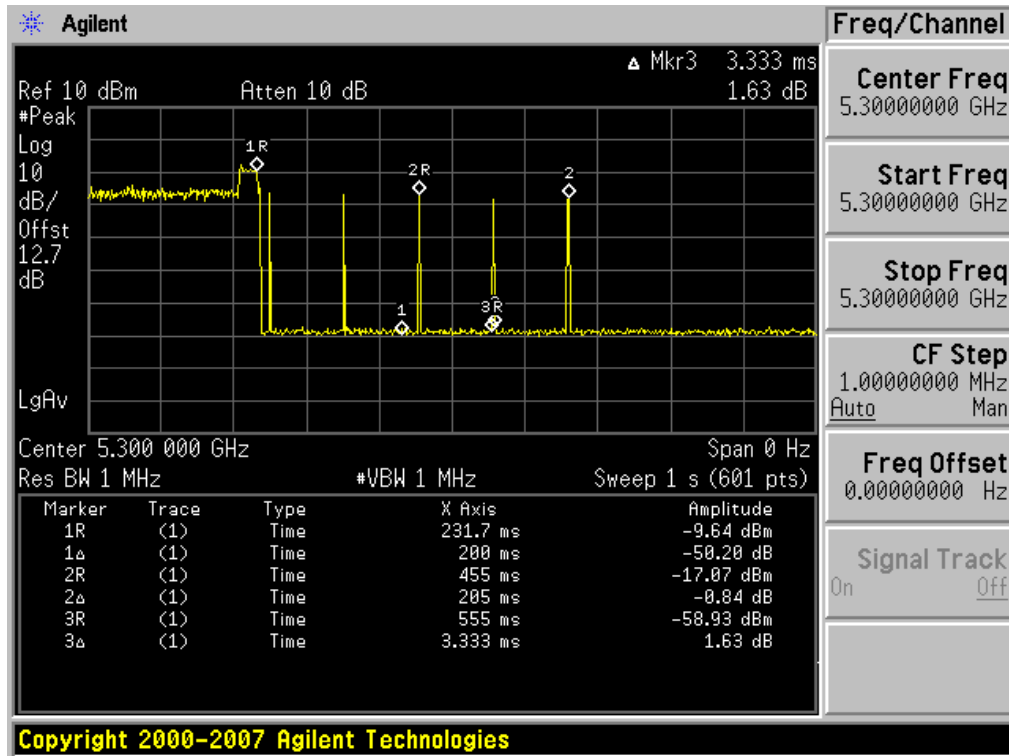

**Calculation of Aggregate Time:**

Pulse width = 3.333 ms (Delta Marker3)

Number of pulses occurring after 200 ms from end of burst = 3 ( Number from M2R to M2)

Aggregate time from 200 ms to 10 sec after burst = 3 x 3.333 ms = 9.999 ms

**Aggregate Time: 9.999 ms**

**Limit: 60 ms**

FCC PT.15.247 TEST REPORT		FCC CERTIFICATION REPORT		<a href="http://www.hct.co.kr">www.hct.co.kr</a>
Test Report No. HCTR1204FR28-1	Date of Issue: May 09, 2012	EUT Type: Cellular/PCS GSM/GPRS/EDGE & Cellular WCDMA/HSDPA/HSUPA Phone with Bluetooth and WLAN/NFC		FCC ID: ZNF940H

Non-occupancy Period – Monitoring live real time spectrum – Elapse time 30 minutes

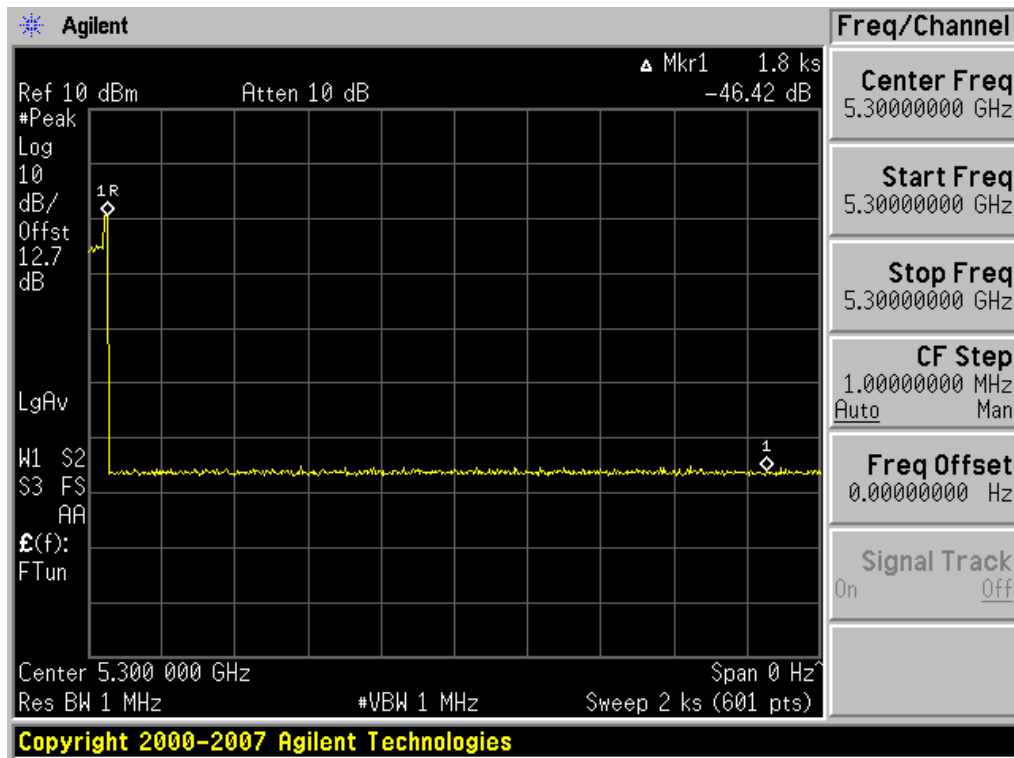

FCC PT.15.247 TEST REPORT		FCC CERTIFICATION REPORT		<a href="http://www.hct.co.kr">www.hct.co.kr</a>
Test Report No. HCTR1204FR28-1	Date of Issue: May 09, 2012	EUT Type: Cellular/PCS GSM/GPRS/EDGE & Cellular WCDMA/HSDPA/HSUPA Phone with Bluetooth and WLAN/NFC		FCC ID: ZNFP940H

## 7.8 UNII-III TEST RESULT

### RESULT PLOTS\_(UNII-III Band)

Time Display, Non WLAN Channel Traffic

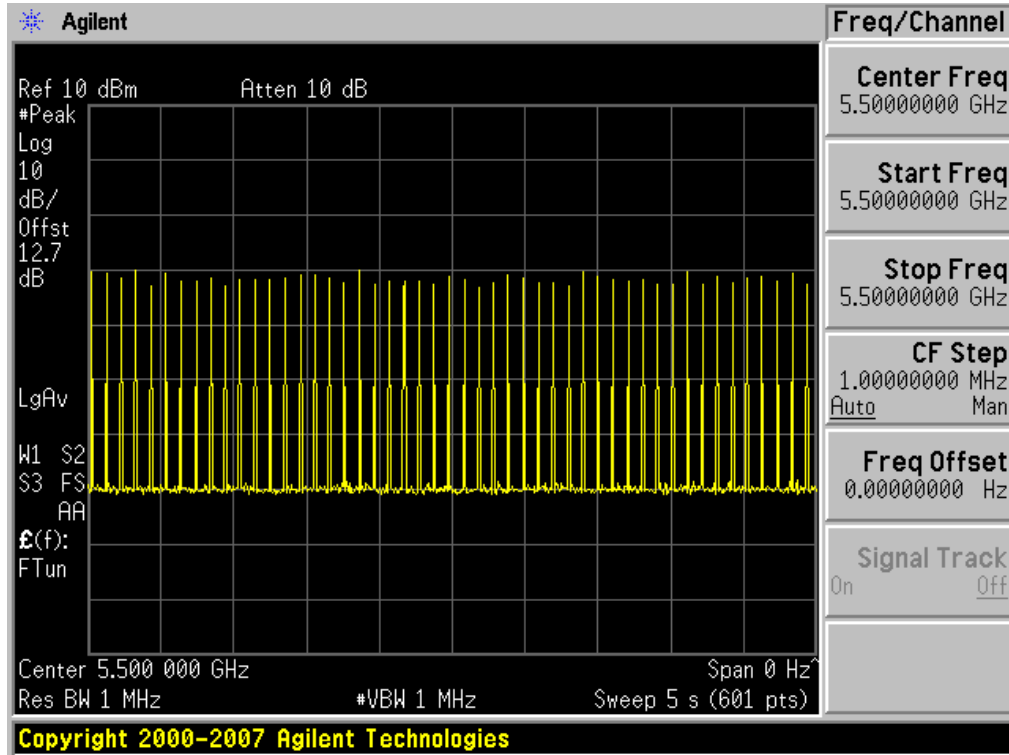

Time Display, WLAN Channel Traffic (Streaming Video)

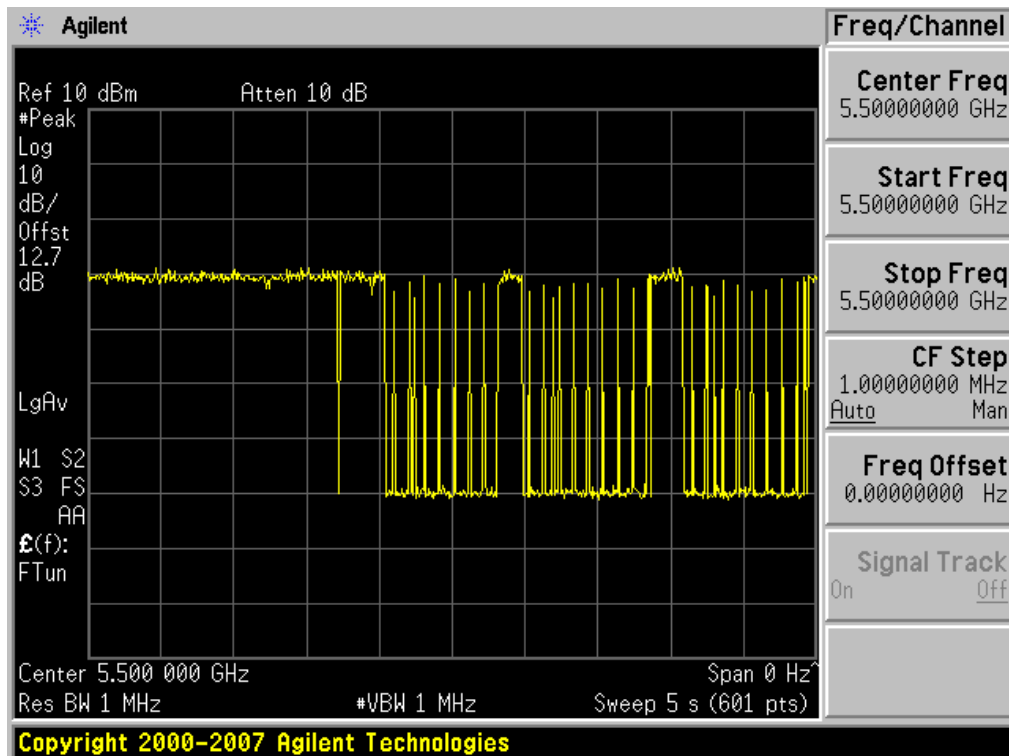

FCC PT.15.247 TEST REPORT	FCC CERTIFICATION REPORT		<a href="http://www.hct.co.kr">www.hct.co.kr</a>
Test Report No. HCTR1204FR28-1	Date of Issue: May 09, 2012	EUT Type: Cellular/PCS GSM/GPRS/EDGE & Cellular WCDMA/HSDPA/HSUPA Phone with Bluetooth and WLAN/NFC	FCC ID: ZNFP940H

Channel Move Time (< 10 sec)

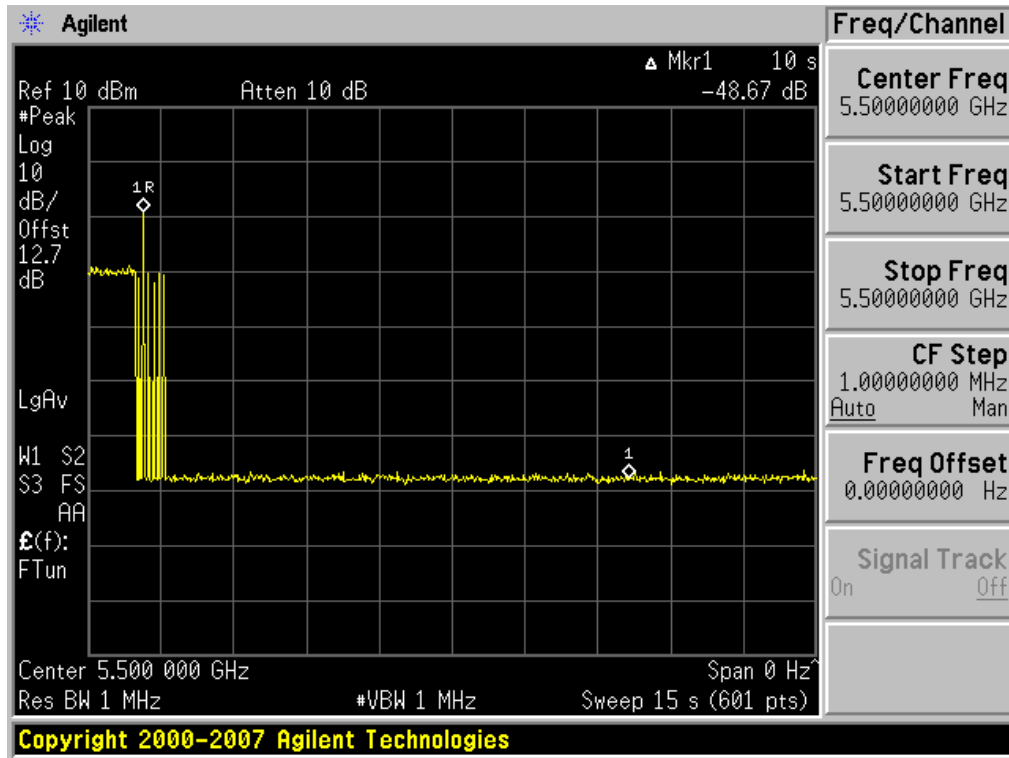

**Marker Descriptions:**

Time from M1R to M1 : 10 s

FCC PT.15.247 TEST REPORT		FCC CERTIFICATION REPORT		<a href="http://www.hct.co.kr">www.hct.co.kr</a>
Test Report No. HCTR1204FR28-1	Date of Issue: May 09, 2012	EUT Type: Cellular/PCS GSM/GPRS/EDGE & Cellular WCDMA/HSDPA/HSUPA Phone with Bluetooth and WLAN/NFC		FCC ID: ZNFP940H

Channel Closing Transmission Time, Aggregate Time After 200 ms

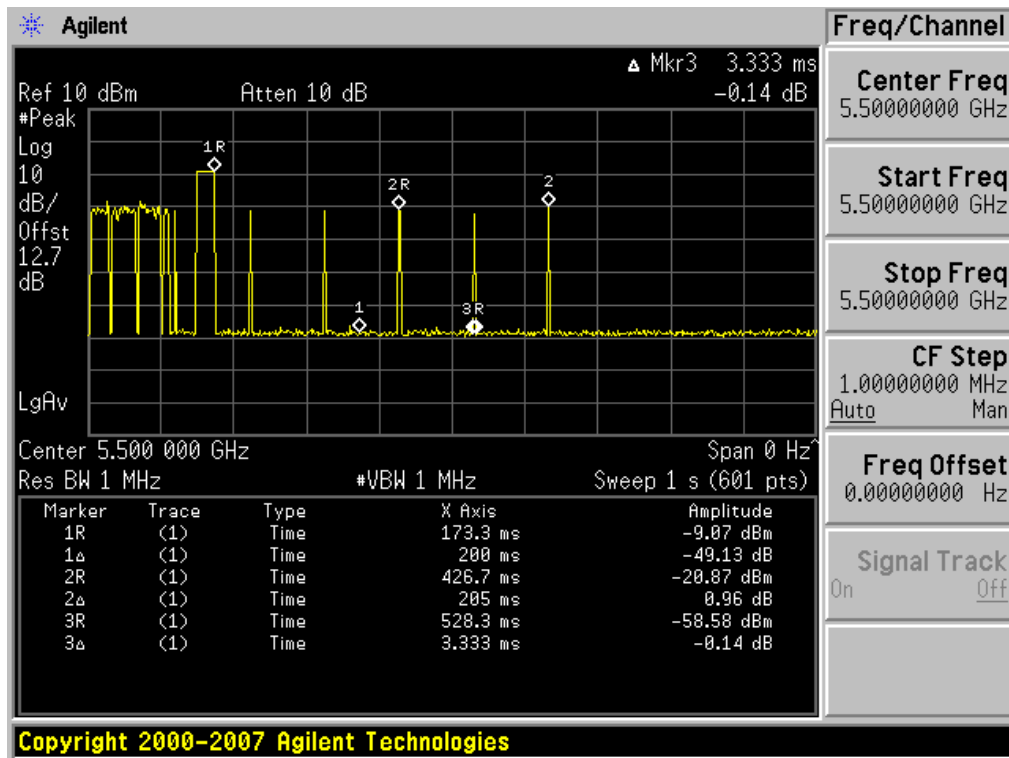

**Calculation of Aggregate Time:**

Pulse width = 3.333 ms (Delta Marker3)

Number of pulses occurring after 200 ms from end of burst = 3 ( Number from M2R to M2)

Aggregate time from 200 ms to 10 sec after burst = 3 x 3.333 ms = 9.999 ms

**Aggregate Time: 9.999 ms**

**Limit: 60 ms**

FCC PT.15.247 TEST REPORT		FCC CERTIFICATION REPORT		<a href="http://www.hct.co.kr">www.hct.co.kr</a>
Test Report No. HCTR1204FR28-1	Date of Issue: May 09, 2012	EUT Type: Cellular/PCS GSM/GPRS/EDGE & Cellular WCDMA/HSDPA/HSUPA Phone with Bluetooth and WLAN/NFC		FCC ID: ZNFP940H

Non-occupancy Period – Monitoring live real time spectrum – Elapse time 30 minutes

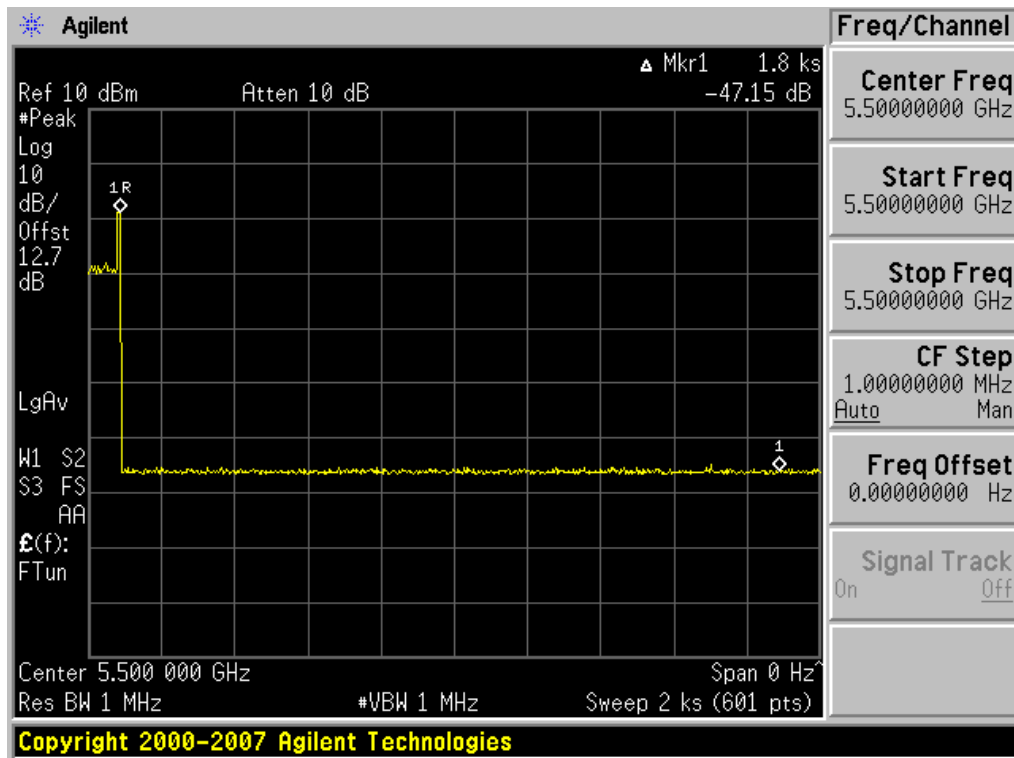

FCC PT.15.247 TEST REPORT		FCC CERTIFICATION REPORT		<a href="http://www.hct.co.kr">www.hct.co.kr</a>
Test Report No. HCTR1204FR28-1	Date of Issue: May 09, 2012	EUT Type: Cellular/PCS GSM/GPRS/EDGE & Cellular WCDMA/HSDPA/HSUPA Phone with Bluetooth and WLAN/NFC		FCC ID: ZNFP940H

## 8. LIST OF TEST EQUIPMENT

Manufacturer	Model / Equipment	Calibration Interval	Calibration Due	Serial No.
Cisco System	AIR-AP1242AG-K-K9 / Wireless AP (Master Device)	N/A	N/A	FCW1323U01K FCC ID: LDK102056
Rohde & Schwarz	SMBV 100A/ Signal Generator	Annual	11/08/2012	255727
Rohde & Schwarz	ESH2-Z5/ LISN	Annual	02/03/2013	861741/013
Schwarzbeck	VULB 9168/ TRILOG Antenna	Biennial	02/09/2013	200
Rohde & Schwarz	ESI 40 / EMI TEST RECEIVER	Annual	05/26/2012	831564103
Agilent	E4440A/ Spectrum Analyzer	Annual	05/02/2012	US45303008
Agilent	N9020A/ SIGNAL ANALYZER	Annual	09/23/2012	MY51110020
HD	MA240/ Antenna Position Tower	N/A	N/A	556
EMCO	1050/ Turn Table	N/A	N/A	114
HD GmbH	HD 100/ Controller	N/A	N/A	13
HD GmbH	KMS 560/ SlideBar	N/A	N/A	12
Rohde & Schwarz	ESH3-Z2/ PULSE LIMITER	Annual	08/01/2012	375.8810.352
Rohde & Schwarz	SCU-18/ Signal Conditioning Unit	Annual	09/19/2012	10094
MITEQ	AFS44-00102650-42-10P-44-PS/ POWER AMP	Annual	09/23/2012	1532439
Schwarzbeck	BBHA 9120D/ Horn Antenna	Biennial	10/17/2013	937
Rohde & Schwarz	FSP / Spectrum Analyzer	Annual	02/09/2013	839117/011
Agilent	E4416A /Power Meter	Annual	11/07/2012	GB41291412
Agilent	E9327A /POWER SENSOR	Annual	05/02/2012	MY4442009
Wainwright Instrument	WHF3.3/18G-10EF / High Pass Filter	Annual	05/02/2012	1
Wainwright Instrument	WRCJ2400/2483.5-2370/2520-60/14SS / Band Reject Filter	Annual	05/02/2012	1
Hewlett Packard	11636B/Power Divider	Annual	11/07/2012	11377
Hewlett Packard	11667B / Power Splitter	Annual	11/04/2012	10126
ITECH	IT6720 / DC POWER SUPPLY	Annual	11/07/2012	010002156287001199
TESCOM	TC-3000C / BLUETOOTH TESTER	Annual	11/14/2012	3000C000276
Rohde & Schwarz	CBT / BLUETOOTH TESTER	Annual	05/02/2012	100422
EMCO	6502.LOOP ANTENNA	Biennial	01/11/2014	9009-2536

<b>FCC PT.15.247 TEST REPORT</b>	<b>FCC CERTIFICATION REPORT</b>		<a href="http://www.hct.co.kr">www.hct.co.kr</a>
<b>Test Report No.</b> HCTR1204FR28-1	<b>Date of Issue:</b> May 09, 2012	<b>EUT Type:</b> Cellular/PCS GSM/GPRS/EDGE & Cellular WCDMA/HSDPA/HSUPA Phone with Bluetooth and WLAN/NFC	<b>FCC ID:</b> ZNFP940H