

This EUT is not intended for sale in the U.S.A

Part 15.21 statement

" Change or Modifications that are not expressly approved by the manufacturer could void the user's authority to operate the equipment.

Part 15.105 statement

This equipment has been tested and found to comply with the limits for a class B digital device, pursuant to Part 15 of the FCC Rules. These limits are designed to provide reasonable protection against harmful interference in a residential installation. This equipment generates uses and can radiate radio frequency energy and, if not installed and used in accordance with the instructions, may cause harmful interference to radio communications. However, there is no guarantee that interference will not occur in a particular installation. If this equipment does cause harmful interference or television reception, which can be determined by turning the equipment off and on, the user is encouraged to try to correct the interference by one or more of the following measures:

- Reorient or relocate the receiving antenna.-Increase the separation between the equipment and receiver.
- Connect the equipment into an outlet on a circuit different from that to which the receiver is connected.
- Consult the dealer or an experienced radio/TV technician for help.

FCC Part 15 Class B Compliance

This device and its accessories comply with part 15 of FCC rules and ICES-003 Class B digital apparatus requirements for Industry Canada. Operation is subject to the following two conditions:(1) This device and its accessories may not cause harmful interference, and (2) this device and its accessories must accept any interference received, including interference that may cause undesired operation.

Body-worn Operation

This device has been tested for body-worn operations with the distance of 1.0cm (0.39 inches) between the user's body and the phone. To comply with FCC RF exposure requirements, a minimum separation distance of 1.0cm (0.39 inches) must be maintained from the user's body. Third-party belt-clips, holsters, and similar accessories containing metallic components should not be used. Body-worn accessories that cannot maintain 1.0cm (0.39 inches) separation distance between the user's body and the phone, and have not been tested for typical body-worn operations may not comply with FCC RF exposure limits and should be avoided.

Wi-Fi Caution.

Within the 5.15–5.25 GHz band, U-NII devices will be restricted to indoor operations to reduce any potential for harmful interference to co-channel MSS operations.

The device shall automatically discontinue transmission in case of either absence of information to transmit or operational failure. These provisions are not intended to preclude the transmission of control or signaling information or the use of repetitive codes used by certain digital technologies to complete frame or burst intervals.

| LG-P940 | USER GUIDE

This guide helps you to get started using your phone.

- Some of the contents of this manual may not apply to your phone, depending on the software and your service provider.
- This handset is not suitable for people who have a visual impairment due to the touch screen keyboard.
- Copyright ©2011 LG Electronics, Inc. All rights reserved. LG and the LG logo are registered trademarks of LG Group and its related entities. All other trademarks are the property of their respective owners.
- Google™, Google Maps™, Gmail™, YouTube™, Google Talk™ and Android Market™ are trademarks of Google, Inc.

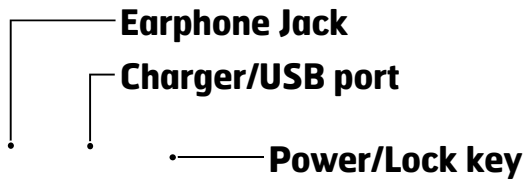

Volume keys

- In the Home screen: Control ringer volume.
- During a call: Control your earpiece volume.
- When playing a track: Control volume continuously.

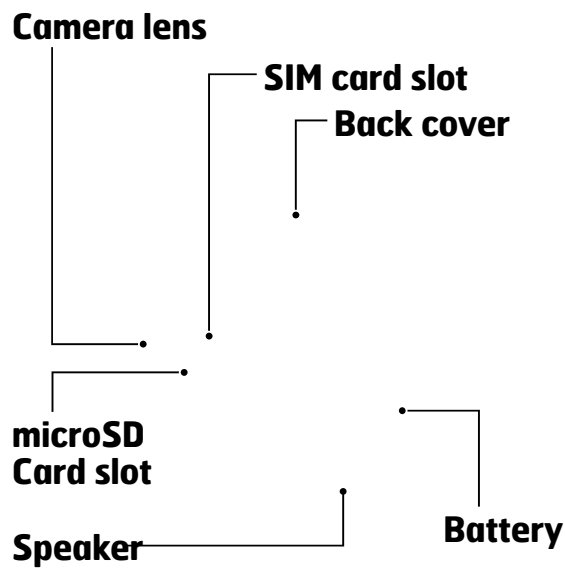

Installing the SIM card and battery

Before you can start exploring your new phone, you'll need to set it up. To insert the SIM card and battery:

1. To remove the back cover, hold the phone firmly in one hand. With your other hand, firmly press your thumb on the back cover. Use the fingertip cutout to pull off the back cover with your forefinger.

2. Slide the SIM card into the SIM card slot. Make sure the gold contact area on the card is facing downwards.

3. Insert the battery into place by aligning the gold contacts on the phone and the battery (1) and pressing it down until it clicks into place (2).



4. Align the back cover over the battery compartment (1) and press it down until it clicks into place (2).

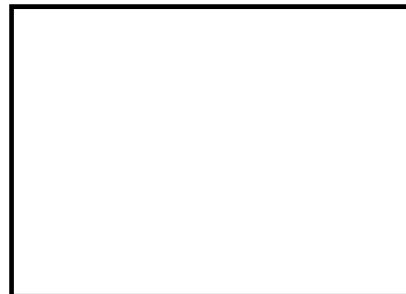

Charging your phone

Open the cover of the charger connector on the top. Insert the charger and plug it into an electrical outlet.

The battery must be fully charged initially to improve battery lifetime.

Using the memory card

To insert a memory card:

Insert the memory card into the slot. Make sure the gold contact area is facing downwards.

To remove the memory card safely:

Applications > Settings > Storage > Unmount SD card.

To format the memory card:

Your memory card may already be formatted. If it isn't, you must format it before you can use it.

All files on your memory card are deleted when it is formatted.

1. On the Home screen, touch the **Applications** tab  to open the applications menu.
2. Scroll and touch **Settings** > **Storage**.
3. Touch **Unmount SD card** and touch OK to confirm it.
4. Touch **Erase SD card** > **Erase SD card** > **Erase everything**, then confirm your choice.
5. If you have set a pattern lock, input the pattern lock then select **Erase Everything**.

If there is content on your memory card, the folder structure may be different after formatting as all the files will have been deleted.

Locking and unlocking the screen

If you do not use the phone for a while, the screen is turned off and locked automatically. This helps to prevent accidental touches and saves battery power.

When you are not using the LG-P940, press the Power/Lock key

 to lock your phone.

If there are any programs running when you set lock screen, they may be still running in Lock mode. It is recommended that you exit all programs before entering Lock mode to avoid unnecessary charges (e.g. phone calls, web access and data communications).

To wake up your phone, press the Power/Lock key. The lock screen will appear. Touch and slide the lock screen upwards to unlock your home screen. The last screen you viewed will open.

Secure your lock screen

You can lock your screen so that only you can unlock it to access your phone.

To set an Unlock Pattern, PIN or Password for the first time:

- **Applications > Settings > Location & security > Set up screen lock > Pattern, PIN or Password**

Once it is set, you can change it on the **Change screen lock** menu.

Precautions to take when using pattern lock.

It is very important to remember the unlock pattern you set.

You will not be able to access your phone if you use an incorrect pattern 5 times. You have 5 opportunities to enter your unlock pattern, PIN or password. If you have used all 5 opportunities, you can try again after 30 seconds.

YOUR HOME SCREEN

Touch screen tips

Here are some tips on how to navigate around your phone.

Touch – To choose a menu/option or open an application, touch it.

Touch and hold – To open an options menu or grab an object you want to move, touch and hold it.

Drag – To scroll through a list or move slowly, drag across the touch screen.

Flick – To scroll through a list or move quickly, flick across the touch screen (drag quickly and release).

- **To select an item, touch the centre of the icon.**
- **Do not press too hard; the touch screen is sensitive enough to pick up a light, firm touch.**
- **Use the tip of your finger to touch the option you want. Be careful not to touch any other keys.**

Home

Simply swipe your finger to the left or right to view the panels. You can customise each panel with widgets, shortcuts (to your favourite applications), folders and wallpaper.

Some screen images may be different depending on your phone provider.

On your Home screen, you can view quick keys at the bottom of the screen. Quick keys provide easy, one-touch access to the functions you use the most.

 Touch the **Phone** icon to bring up the touch screen dialpad to make a call.

 Touch the **Contacts** icon to open your contacts.

 Touch the **Messaging** icon to access the messaging menu. This is where you can create a new message.

 Touch the **Applications** tab at the bottom of the screen. You can then view all your installed applications. To open any application, simply touch the icon in the applications list.

Customising the Home screen

You can customise your Home screen by adding widgets, shortcuts, folders or wallpapers. For more convenience using your phone, add your favourite widgets to the Home screen.

To add items on your Home screen:

1. **Home screen > Menu > Add**

OR

Touch and hold the empty part of the Home screen.

2. In the **Add Mode** menu, select items you want to add. You will then see added items on the Home screen.

3. Drag it to the location you want and lift your finger.

To remove an item from the Home screen:

- **Home screen > touch and hold the icon you want to remove > drag it to **

To add an application icon to the Home screen from the Applications menu, touch and hold the application you want to add.

Returning to recently-used applications

1. Touch and hold the **Home** key. The screen displays a pop-up with icons of applications you used recently.
2. Touch an icon to open the application. Or touch the **Back** key to return to your current application.

Notification drawer

The notification drawer runs across the top of your screen.

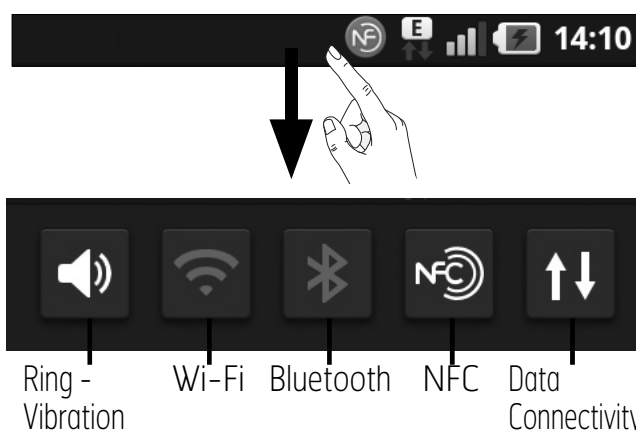







Touch and slide the notification drawer down with your finger. Or, on the Home screen, press the **Menu** key and select **Notifications**. Here you can check and manage sound, Wi-Fi, Bluetooth and NFC as well as other notifications.

















Viewing the status bar

















The status bar uses different icons to display phone information such as signal strength, new messages, battery life, active Bluetooth and data connections.



Below is a table explaining the meaning of icons you're likely to see in the status bar.

Icon	Description
	No SIM card
	No signal
	Airplane mode
	Connected to a Wi-Fi network
	Wi-Fi Direct is on
	Wired headset

Icon	Description
	Call in progress
	Call hold
	Speakerphone
	Phone microphone is muted
	Missed call
	Bluetooth is on
	Connected to a Bluetooth device
	NFC is on
	System warning
	Alarm is set
	New voicemail
	Ringer is silenced
	Vibrate mode
	Battery fully charged
	Battery is charging
	Data in and out
	Phone is connected to PC via USB cable

Icon	Description
	Downloading data
	Uploading data
	GPS is acquiring
	Receiving location data from GPS
	On-Screen Phone connected
	3 more notifications not displayed
	Data is syncing
	Download finished
	New Gmail
	New Google Talk message
	New message
	Song is playing
	Upcoming event
	FM radio turned on in the background
	USB tethering is active
	Portable Wi-Fi hotspot is active



Icon	Description
	Both USB tethering and portable hotspot are active

Onscreen keyboard

You can enter text using the onscreen keyboard. The onscreen keyboard appears automatically on the screen when you need to enter text. To manually display the keyboard, simply touch a text field where you want to enter text.

Using the keypad & entering text

 Tap once to capitalise the next letter you type. Double-tap for all caps.

  Tap to switch to the numbers and symbols keyboard. You can also touch and hold this tab to view the Settings menu.

 Tap to view or press and hold to change the writing language.

 Tap to insert an emoticon when writing a message.

 Tap to enter a space.

 Tap to create a new line in the message field.

 Tap to delete the previous character.

⏏ Tap to hide the onscreen keyboard.

Entering accented letters

When you select French or Spanish as the text entry language, you can enter special French or Spanish characters (e.g. "á").

For example, to input "á", touch and hold the "a" key until the zoom-in key grows bigger and displays characters from different languages.

Then select the special character you want.

CONNECTING TO NETWORKS AND DEVICES

Wi-Fi

With Wi-Fi, you can use highspeed Internet access within the coverage of the wireless access point (AP). Enjoy wireless Internet using Wi-Fi, without extra charges.

Connecting to Wi-Fi networks

To use Wi-Fi on your phone, you need to access a wireless access point or "hotspot". Some access points are open and you can simply connect to them. Others are hidden or use security features; you must configure your phone to be able to connect to them.

Turn off Wi-Fi when you're not using it to extend the life of your battery.

If you are out of the Wi-Fi zone or set Wi-Fi to OFF, additional charges may be applied by your mobile operator for mobile data use.

Turning Wi-Fi on and connecting to a Wi-Fi network

1. **Applications > Settings > Wireless & networks > Wi-Fi settings.**
2. Touch **Wi-Fi** to turn it on and start scanning for available Wi-Fi networks.
 - A list of available Wi-Fi networks is displayed. Secured networks are indicated by a lock icon.
3. Touch a network to connect to it.
 - If the network is open, you are asked to confirm that you want to connect to that network by touching **Connect**.
 - If the network is secured, you are prompted to enter a password or other credentials. (Ask your network administrator for details)
4. The status bar displays icon that indicate Wi-Fi status.

Bluetooth

You can use Bluetooth to send data by running a corresponding application, not from the Bluetooth menu as on most other mobile phones.

Turning on Bluetooth and pairing up your phone with a Bluetooth device

1. **Applications > Settings > Wireless & networks > Bluetooth > ON**
2. Go to **Bluetooth settings > Scan for devices**
3. Choose the device you want to pair up with from the list.

Once the pairing is successful, your device will connect to the device. If the device you want to pair up with is not on the list, make sure that target device is set to be

Discoverable, then scan again.

Sending pictures using Bluetooth

1. **Select a picture > Menu > Share > Bluetooth**
2. Check whether **Bluetooth** is **ON**, then select **Scan for devices**.
3. Choose the device you want to send data to from the list.

Sharing your phone's data connection

USB tethering and portable Wi-Fi hotspot are great features when there are no wireless connections available. You can share your phone's mobile data connection with a single computer via a USB cable (USB tethering). You can also share your phone's data connection with more than a single device at a time by turning your phone into a portable Wi-Fi hotspot.

When your phone is sharing its data connection, an icon appears in the status bar and as an ongoing notification in the notifications drawer.

For the latest information about tethering and portable hotspots, including supported operating systems and other details, visit <http://www.android.com/tether>.

To change USB tethering & portable Wi-Fi hotspot settings:

- **Applications > Settings > Wireless & networks > Tethering & portable hotspot** > Choose options that you want to adjust.

To rename or secure your portable hotspot

You can change the name of your phone's Wi-Fi network name (SSID) and secure its Wi-Fi network.

1. On the Home screen, touch the **Applications** tab  and select **Settings**.
2. Touch **Wireless & networks** and select **Tethering & Portable**

hotspot.

3. Ensure **Portable Wi-Fi hotspot** is ticked.
4. Touch **Portable Wi-Fi hotspot** settings.
5. Touch **Configure Wi-Fi hotspot**.
 - The **Configure Wi-Fi hotspot** dialog box will open.
 - You can change the network SSID (name) that other computers see when scanning for Wi-Fi networks.
 - You can also touch the **Security** menu to configure the network with Wi-Fi Protected Access 2 (WPA2) security using a pre-shared key (PSK).
 - If you touch the **WPA2 PSK** security option, a password field is added to the **Configure Wi-Fi hotspot** dialog. If you enter a password, you will need to enter that password when you connect to the phone's hotspot with a computer or other device. You can touch **Open** in the **Security** menu to remove security from your Wi-Fi network.

ATTENTION!

If you set the security option as **Open**, you cannot prevent unauthorised usage of online services by other people and additional charges can be incurred. To avoid unauthorised usage, you are advised to keep the security option active.

6. Touch **Save**.**Using the Wi-Fi Cast**

You can share your music, picture and video content between users who use Android Phones connected via the same Wi-Fi & Wi-Fi Directed network.

Check your Wi-Fi & Wi-Fi Directed network in advance and make sure the users are connected to the same network.

1. **Applications > Settings > Wireless & networks > Wi-Fi Direct Settings > Wi-Fi Direct > ON**
2. Select a device to connect from the scanned device list.
3. Touch **Connect**.

Enabling Wi-Fi Direct to share through SmartShare

Wi-Fi Direct automatically scans nearby Wi-Fi Direct devices and the searched devices are listed as they are found and you can select a specific device to share multimedia data through Smart Share.

Wi-Fi Direct cannot be enabled while using other Wi-Fi functions.

1. **Applications > Settings > Wireless & networks > Wi-Fi Direct Settings**
2. Ensure **Wi-Fi Direct** is **ON**.
3. Select a device to connect from the scanned device list.

Forced Group owner mode – Touch to activate group owner mode, which enables the legacy Wi-Fi devices to connect by scanning your phone. In this case you must enter the password that is set in the **Menu > Advanced > Password**.

Using SmartShare

SmartShare uses DLNA (Digital Living Network Alliance) technology to share digital content through a wireless network.

Both devices must be DLNA certified to support this feature.

To turn SmartShare on and allow sharing contents

1. Touch **Applications** tab  and select **SmartShare**.
2. Press the **Menu** key and select **Settings**.
3. Touch Discoverable checkbox to turn on.
 - Touch **Always accept request** if you would like to automatically accept sharing requests from other devices.
 - Touch **Receive files** if you would like to automatically allow upload

files to my phone from other devices.

1. Under the Sharing contents section, touch to checkmark the types of content you would like to share. Choose from **Pictures**, **Videos** and **Music**.
2. **SmartShare** is now activated and ready to share contents.

To share contents from remote content library to other devices





Let your renderer device (e.g. TV) play multimedia contents from your remote content library (e.g. PC).

Make sure that the DLNA functionality of your devices is properly configured (e.g. TV and PC).

1. Touch the top right button to or select the device from renderer lists.
2. Touch the top left button and select the device of the remote content library.
3. You can browse the content library.
4. Touch a content thumbnail or press the Menu key and select Play button.

CALLS

Making a call

1. Touch  to open the keypad.
2. Enter the number using the keypad. To delete a digit, touch the .
3. Touch the  to make a call.
4. To end a call, touch the **End** icon .

To enter "+" to make international calls, touch and hold .

Calling your contacts

1. Touch  to open your contacts.
2. Scroll through the contact list or enter the first few letters of the contact you want to call by touching **Search**.
3. In the list, touch the contact you want to call.

Answering and rejecting a call

When you receive a call in Lock state, drag the  to the right to answer incoming call.

Drag the  to the left to reject an incoming call.

Drag the **Excuse messages** bar from the bottom if you want to send one.





Excuse messages

You can send a message quickly using this function. This is useful if you need to reply the message during a meeting.

Adjusting call volume

To adjust the in-call volume during a call, use the Volume up and down keys on the left-hand side of the phone.

Making a second call

1. During your first call, touch **Dialpad**  and dial the number. Also, you can search your contacts by touching **Contacts**  and select the number you want to call.
2. Touch the  to make the call.
3. Both calls are displayed on the call screen. Your initial call is locked and put on hold.
4. Touch the displayed number to toggle between calls. Or touch  **Merge calls** to make a conference call.

5. To end active calls, touch **End** or press Home Key and slide the notification bar down and select **End call**.

You are charged for each call you make.

Viewing your call logs

On the Home screen, touch  and choose the **Call log** tab.

View a complete list of all dialled, received and missed voice calls.

Touch any call log entry to view the date, time and duration of the call.

Press the Menu key, then touch Delete all to delete all the recorded items.

Call settings

You can configure phone call settings such as call forwarding and other special features offered by your carrier.

1. On the Home screen, touch the **Applications** tab  to open the applications menu.

2. Scroll and touch **Settings**.
3. Tap **Call settings** and choose the options that you want to adjust.

CONTACTS



Add contacts to your phone and synchronise them with the contacts in your Google account or other accounts that support contact syncing.

Searching for a contact

In the Home screen

1. Touch  to open your contacts.
2. Touch **Search** and enter the contact name using the keyboard.

Adding a new contact

1. Touch , enter the new contact's number, then press the **Menu** key. Touch **Add to contacts** and then **Create new contact**.
2. If you want to add a picture to the new contact, touch the image area. Choose from **Capture picture** or **Pick from Gallery**.
3. Select the contact type by touching .
4. Touch a category of contact information and enter the details about your contact.
5. Touch **Save**.

Favourite contacts

You can classify frequently called contacts as favourites.

Adding a contact to your favourites

1. Touch  to open your contacts.
2. Touch a contact to view their details.
3. Touch the star to the right of the contact's name. The star turns blue.

Removing a contact from your favourites list

1. Touch  to open your contacts.
2. Touch the **Groups** tab, select **Favourites** at the top of the list and choose a contact to view its details.
3. Touch the blue star to the right of the contact's name. The star turns grey and the contact is removed from your favourites.

Moving contacts from your old phone to your new phone

Export your contacts as a CSV file from your old phone to your PC using a PC sync program.

1. Install PC Suite IV on the PC first. Run the program and connect your Android mobile phone to the PC using a USB cable.

2. Select the . Go to **File > Import** and select the CSV file saved on your PC.
3. If the fields in the imported CSV file are different from those in PC Suite IV, you need to map the fields. After mapping the fields, click OK. The contacts are then added to PC Suite IV.
4. If PC Suite IV detects the connection of your LG-P940 phone (using the USB cable), click Sync or Sync contacts to synchronise the contacts saved on your PC with your phone.

MESSAGING

Your LG-P940 combines SMS and MMS into one intuitive, easy-to-use menu.

Sending a message

1. Touch  icon on the home screen, and touch **New message** to open a blank message.
2. Enter a contact name or contact number in the **To** field. As you enter the contact name, matching contacts appear. You can touch a suggested recipient. You can add multiple contacts.

You will be charged for a text message for every person you send the message to.

1. Touch Enter message field and start to compose your message.
2. Press the **Menu** key to open the Options menu. Choose from **Add subject**, **Attach**, **Send** and **More**.
3. Touch **Send** to send your message.
4. The message screen opens, with your message after Recipient Name/Number. Responses appear on the screen. As you view and send additional messages, a message thread is created.

> WARNING:
The 160-character limit may vary from country to country depending on the language and how the SMS is coded.

> WARNING:
If an image, video or audio file is added to an SMS message, it is automatically converted into an MMS message and you are charged accordingly.

Threaded box

Messages (SMS, MMS) exchanged with another party can be displayed in chronological order so that you can conveniently see an overview of your conversation.

Using Smilies

Liven up your messages using Smilies.

When writing a new message, press the **Menu** key, then choose **Insert smiley**.

Changing your message settings

Your LG-P940 message settings are predefined, so you can send messages immediately. You can change the settings based on your preferences.

Touch **Messaging** icon on the home screen and touch the **Menu** key, then tap **Settings**.

EMAIL

You can use the Email application to read emails from services other than Google Mail. The Email application supports the following account types: POP3, IMAP and Exchange.

Your service provider or system administrator can provide the account settings you need.

Managing an email account

The first time you open the **Email** application, a setup wizard opens to help you to set up an email account.

To add another email account:

- **Applications > Email >** in the account screen, touch **Menu > Add account**

After the initial setup, Email displays the contents of your inbox. If you have added more than one account, you can switch among accounts.

To change an email account's setting:

- **Applications > Email >** in the account screen, touch **Menu > Settings**

To delete an email account:

- **Applications > Email >** in the account screen, touch **Menu > Settings >** touch an account you want to delete > **Remove account**

Email account screen

You can touch an account to view its Inbox. The account from which you send email by default is indicated with a tick.

 – Touch to open your Combined Inbox, with messages sent to all of your accounts.

Messages in the Combined Inbox are colour coded on the left, by account, using the same colours used for your accounts in the Accounts screen.

 – Touch the folder icon to open the account folders.

Only the most recent emails in your account are downloaded to your phone. To download more (earlier) email messages, touch **Load more emails** at the bottom of the emails list.

Working with account folders

Each account has an Inbox, Outbox, Sent and Drafts folder. Depending on the features supported by your account's service provider, you may have additional folders.

Composing and sending email

To compose and send a message

1. While in the **Email** application, touch the **Menu** key, then touch **Compose**.
2. Enter an address for the message's intended recipient. As you enter text, matching addresses are offered from your Contacts. Separate multiple addresses with semicolon.
3. Add Cc/Bcc and add attachment files if required.
4. Enter the text of the message.

5. Touch the **Send** button.

If you aren't connected to a network, for example, if you're working in airplane mode, the messages that you send are stored in your Outbox folder until you're connected to a network again. If it contains any pending messages, the Outbox is displayed on the Accounts screen.

When a new email arrives in the inbox, you will receive a notification by sound or vibration. Tap the email notification to stop notifications.



CAMERA

Getting to know the viewfinder



- ❶ **Switch lenses** – Switch between the rear-facing camera lens and the front-facing camera lens.
- ❷ **Zoom** – Zoom in or zoom out. Alternatively you can use the side volume keys.
- ❸ **Brightness** – This defines and controls the amount of sunlight entering the image.
- ❹ **Scene mode** – Choose from **Auto**, **Portrait**, **Landscape**, **Sports**, **Night** and **Sunset**.
- ❺ **Settings** – Touch this icon to open the Settings menu.
- ❻ **Video mode** – Slide this icon down to switch to video mode.
- ❼ **Taking a photo**
- ❽ **Gallery** – Touch to view the last photo you captured. This enables you to access your gallery and view saved photos within camera mode.

Taking a quick photo

1. Open the **Camera** application.
2. Hold the phone, point the lens towards the subject you want to photograph.
3. Touch and hold the  lightly and a focus box will appear in the centre of the viewfinder screen.
4. When the focus box turns green, the camera has focused on your subject.
5. Take your finger off the .

Once you've taken the photo



Your captured photo appears on the screen.

Share Touch to share your photo using **SmartShare**, **Bluetooth**, **E-mail**, **Facebook**, **Gmail**, **Messaging**, **Picasa**, **Social+**, **Twitter** or **Wi-Fi Cast**.

If you have an SNS account and set it up on your phone, you can share your photo with the SNS community.





Set as Touch to use the image as a **Contact icon** or **wallpaper**.







Rename Touch to edit the name of the selected picture.

-  Touch to delete the image.
-  Touch to take another photo immediately. Your current photo is saved.

Using the advanced settings

In the viewfinder, touch  to open all advanced options.

-  – Restore all camera default settings.
-  – Touch whenever you want to know how this function operates. This provides you with a quick guide. Change camera settings by scrolling through the list. After selecting the option, touch the **Back** key.
-  – Focuses on the specific spot.
-  – Select the image resolution. If you choose the high resolution, the file size will increase, which means you will be able to store fewer photos in the memory.
-  – The ISO rating determines the sensitivity of the camera's light sensor. The higher the ISO, the more sensitive the camera is. This is useful in darker conditions when you cannot use the flash.

-  – Improves colour qualities in different lighting conditions.
-  – Applies artistic effects to the pictures.
-  – Set a delay after the capture button is pressed. This is ideal if you want to be in the photo.
-  – Select various shot modes.
-  – It automatically shows you the picture you just took.
-  – Activate to use your phone's location-based services. Take pictures wherever you are and tag them with the location. If you upload tagged pictures to a blog that supports geotagging, you can see the pictures displayed on a map.

This function is only available when GPS is active.

When you exit the camera, some settings return to their defaults, such as white balance, colour tone, timer and scene mode. Check these before you take your next photo.

The Settings menu is superimposed over the viewfinder so, when you change elements of the image colour or quality, you see a preview of the image change behind the Settings menu.



VIDEO CAMERA

Getting to know the viewfinder



- ❶ **Switch lenses** – Switch between the rear-facing camera lens and the front-facing camera lens.
- ❷ **Zoom** – Zoom in or zoom out. Alternatively you can use the side volume keys.
- ❸ **Brightness** – This defines and controls the amount of sunlight entering the video.
- ❹ **Video size** – Touch to set the size (in pixels) of the video you record.
- ❺ **Settings** – Touch this icon to open the settings menu.
- ❻ **Camera mode** – Slide this icon up to switch to camera mode.
- ❼ **Start recording**
- ❽ **Gallery** – Touch to view the last video you recorded. This enables you to access your gallery and view your saved videos from within video mode.



Shooting a quick video

1. Slide the **Camera** mode button down and the icon changes to .
2. The video camera viewfinder appears on the screen.
3. Holding the phone, point the lens towards the subject you want to capture in your video.
4. Press the Record  button once to start recording.
5. REC appears at the bottom of the viewfinder with a timer showing the length of the video.
6. Touch  on the screen to stop recording.

After shooting a video







A still image representing your video will appear on the screen.

- Play** Touch to play the video.
- Share** Touch to share your photo using **SmartShare**, **Bluetooth**, **E-mail**, **Facebook**, **Gmail**, **Messaging**, **Wi-Fi Cast** or **Youtube**.
- Rename** Touch to edit the name of the selected video.

-  Touch to shoot another video straight away. Your current video is saved.
-  Touch to delete the video you just made. Confirm by touching **OK**. The viewfinder reappears.

Using the advanced settings

Using the viewfinder, touch  to open all the advanced options.

-  – Restore all video camera default settings.
-  – Touch if you want to know how this function operates. This provides you with a quick guide. Adjust the video camera setting by scrolling through the list. After selecting the option, touch the **Back** key.
-  – Improves colour qualities in different lighting conditions.
-  – Choose a colour tone to use for your new view.
-  – Set a duration limit for your video. Choose between Normal and MMS to limit the maximum size to send as an MMS message.
-  – Choose **Mute** to record a video without sound.
-  – Auto review automatically shows you the video you just recorded.

Adjusting the volume when viewing a video

To adjust the volume of a video while it is playing, use the volume keys on the left-hand side of the phone.

MULTIMEDIA



You can store multimedia files on a memory card for easy access to all your image and video files.

Gallery

Touch the **Applications** tab , then select **Gallery**. Open a list of catalogue bars that store all your multimedia files.

Make sure you install a memory card in the phone to save photos and access all your pictures. Without a memory card, the phone does not display photos or videos without Picasa images, which are in your Picasa album.

Timeline view

LG-P940 **Gallery** provides a timeline view of your photos and videos. In grid view mode, drag   to the right and the date you took your photos is displayed, starting with the most recent. If you select a specific date, all the photos you took on that day are grouped.

Music

Your LG-P940 has a built-in music player that lets you play all your favourite tracks. To access the music player, touch **Music**.

Transferring music files using USB mass storage devices







1. Connect the LG-P940 to a PC using a USB cable.
2. If you haven't installed LG Android Platform Driver on your PC, you need to change the settings manually. Choose **Settings** > **Storage**, then select **Mass storage only**.
3. Touch **Turn on USB storage**.
4. You can view the mass storage content on your PC and transfer the files.

You need to install an SD card first. Without an SD card, you cannot use USB mass storage.

If you installed LG Android Platform Driver, you will immediately see a pop-up saying Turn on USB storage.

Playing a song

1. In the Home screen, touch the **Applications** tab  and select **Music**.
2. Touch **Songs**.
3. Select the song you want to play.

	Touch to pause playback.
	Touch to resume playback.
	Touch to skip to the next track in the album, playlist or shuffle.
	Touch to skip to the previous track in the album, playlist or shuffle.
	Touch to see music library screen.
	Touch to set repeat mode.
	Touch to play the current playlist in shuffle mode.
	Touch to see the current playlist.
	Touch to see lyrics. This option is on only if the song includes the lyrics.

To change the volume while listening to music, press the up and down volume keys on the left-hand side of the phone.

Touch and hold any song in the list. It displays **Play**, **Add to playlist**, **Use as ringtone**, **Delete**, **Share**, **Search** and **Details** as options.

Music file copyrights may be protected by international treaties and national copyright laws.

Therefore, it may be necessary to obtain permission or a licence to reproduce or copy music.

In some countries, national laws prohibit private copying of copyrighted material. Before downloading or copying the file, check the national laws of the relevant country concerning the use of such material.

FM Radio

Your LG-P940 has a built-in FM Radio so you can tune in to your favourite stations and listen on the go.

You need to use your headphones to listen to the radio. Insert them into the headphone jack.

Searching for stations

You can tune in to radio stations by searching for them manually or automatically. They are then saved to specific channel numbers, so you don't have to find them again. You can store up to 48 channels on your phone.

Tuning in automatically

1. In the Home screen, touch the **Applications** tab  and select **FM Radio**.
2. Press the **Menu** key, then touch **Auto scan**.
3. If there are preset channels, you will see a pop-up asking "Reset all channels and start auto scan?". If you choose OK, all the preset channels are deleted and **Auto scan** starts.
4. During auto scanning, touch **Stop** if you want to stop scanning. Only scanned channels are saved before you stop scanning.

You can also manually tune in to a station using the on-screen wheel.

To improve radio reception, extend the headset cord as this also functions as the radio antenna.

If you connect a headset not specifically made for radio reception, radio reception may be poor.

NFC

Your LG-P940 is NFC-enabled mobile phone. NFC (Near Field Communication) is a wireless connectivity technology that enables two-way communication between electronic devices. It operates over a distance of a few centimeters. You can share your contents with a NFC tag or another device via simple touch with your device. If you touch a NFC tag with your device, it will display the tag contents on your device.

To switch NFC on or off

From the Home screen, touch and slide the notification drawer down with your finger, then select the NFC icon  to turn it on.

When the Flight mode is activated, NFC application can be used.

Using NFC

To use NFC, make sure your device is switched on and activate the NFC setting, if disabled.

Using Tag writing

1. Launch the main menu and select the NFC application NFC .
2. Select New tab, and select the desired option: Contact, URL, Memo, Call, Text message and Schedule.
3. Key in the informations to write to a tag or a device and select **Share**.
4. Touch the back of your device to a tag or a device to share.

Using Tag reading

1. To read a service tag, touch the service tag or other NFC device with the back of your device.
2. When a tag or device is recognised, corresponding information is displayed.

UTILITIES

Setting your alarm

1. **Applications > Alarm/Clock >  > New alarm**
2. After you set the time, the LG-P940 lets you know how much time is left before the alarm will sound.
3. Set **Snooze duration**, **Vibration**, **Alarm tone** and **Puzzle lock** then add a label to name the alarm. Touch **Save**.

Using your calculator

1. **Applications > Calculator**
2. Touch the number keys to enter numbers.
3. For simple calculations, touch the function you want (+, -, x or $\frac{\square}{\square}$) followed by =.
4. For more complex calculations, press the **Menu** key, touch the **Advanced panel**, then choose sin, cos, tan, log and so on.

Adding an event to your calendar

1. **Applications > Calendar**
2. To check the event, touch the date. Touch the **Menu** key if you want to add a new event. Touch **New event**.
3. Touch **What** then enter the event name. Check the date and enter the time you want your event to start and finish.
4. Also touch **Where** then enter the location.
5. If you want to add a note to your event, touch **Description** and enter the details.
6. If you want to repeat the alarm, set **Repetition**, and set **Reminders**, if necessary.
7. Touch **Save** to save the event in the calendar.

Changing your calendar view

1. **Applications > Calendar**
2. On the top of the screen, you can find the different view types of the Calendar (Day, Week, Month, Agenda).

Polaris Office

Polaris Office is a professional mobile office solution that lets users conveniently view various types of office documents, including Word, Excel and PowerPoint files, anywhere, anytime, using their mobile devices.

Managing files

Polaris Office provides mobile users with convenient file management features, including copying, cutting and pasting, and deleting files and folders right on the device.

Viewing files

Mobile users can now easily view a wide variety of file types, including Microsoft Office documents and Adobe PDF, right on their mobile devices. When viewing documents using Polaris Office, the objects and layout remain the same as in their original documents.





THE WEB

Browser

Browser gives you a fast, full-colour world of games, music, news, sport, entertainment and much more, right on your mobile phone. Wherever you are and whatever you enjoy.







Additional charges apply when connecting to these services and downloading content. Check data charges with your network provider.

Using the web toolbar

-  Touch to go back a page.
-  Touch to go forwards a page, to the page you connected to after the current one. This is the opposite of what happens when you press the **Back** key, which goes to the previous page.
-  Touch to show all your open windows.
-  Touch to add a new window.
-  Touch to change web browser settings.

Using options

Press the **Menu** key to view options.







-  **Bookmarks** – View your current bookmarks and add a new bookmark. You can also view your browser history.
-  **Add bookmark** – Add the current web page as a bookmark.
-  **Read it later** – Added in **Read it later**.
-  **Add RSS Feed** – Add the current web page to the RSS feed.
-  **Share page** – Allows you to share the web page with others.
-  **More**
 - **Find on page:** Allows you to find letters or words on the current web page.
 - **Select text:** Allows you to copy any text from the web page.
 - **Add shortcut to Home:** Add the shortcut for the current web page to the Home screen.
 - **Page info:** Displays the web page information.
 - **Downloads:** Displays your download history.

LG ON-SCREEN PHONE 2.0

LG On-Screen Phone 2.0 allows you to view your mobile phone screen from a PC via a USB, Bluetooth, or Wi-Fi connection.

You can also control your mobile phone from your PC using the mouse or keyboard.

On-Screen Phone 2.0 icons

-  Connects your mobile phone to your PC, or disconnects it.
-  Rotates the On-Screen Phone window (only available at applications that support rotation).
-  Launches LG Home Panorama or changes the On-Screen Phone preferences.
-  Exits the On-Screen Phone program.
-  Maximises the On-Screen Phone window.
-  Minimises the On-Screen Phone window.

On-Screen Phone 2.0 features

- **Real-time transfer and control:** Displays and controls your mobile phone screen when connected to your PC.
- **Mouse control:** Allows you to control your mobile phone by using the mouse to click and drag on your PC screen.
- **Text input with keyboard:** Allows you to compose a text message or note using your computer keyboard..
- **File transfer (mobile phone to PC):** Sends a file from your mobile phone (e.g. Gallery, Video Player, Music and Polaris Office) to your PC. Simply right-click and drag to send a file to your PC.
- **File transfer (PC to mobile phone):** Sends files from your PC to your mobile phone. Simply select the files you wish to transfer and drag and drop into the On-Screen Phone window. The files you send are stored on OSP folder.
- **Real-time event notifications:** Prompts a pop-up to inform you of any incoming calls or text, as well as alarm and event notifications.

- **LG Home Panorama:** Shows the whole workspaces of LG Home. You can easily organise icons or widgets and run an application by double-clicking the shortcut.

Please make sure LG Home is a default launcher.

Installing On-Screen Phone on your PC

If you install LG PC Suite IV, the On-Screen Phone program will also be downloaded on your PC. Then you can install the On-Screen Phone on your PC.

Connecting your phone to your PC

On-Screen Phone 2.0 provides USB, Bluetooth and Wi-Fi connection. Please follow the instruction on Connection Wizard of OSP program.

Please make sure that On-Screen Phone check box in Settings > Wireless & network > On-Screen Phone settings is selected. Please make sure that the battery may run out more quickly due to the current consumption if On-Screen Phone is connected via Wi-Fi.

Checking the On-Screen Phone connection

Once the devices have been connected, drag down the status bar at the top of the home screen to check the On-Screen Phone connection status.

Disconnecting your phone from your PC

Click  in the top left of the On-Screen Phone window. Or drag down the notification bar at the top of the home screen and select "On-Screen Phone connected". Touch "Ok" in the disconnect dialog.

SETTINGS

In the Home screen, touch the **Applications** tab  then scroll to and touch **Settings**.

Wireless & networks

Here, you can manage Wi-Fi and Bluetooth. You can also set up mobile networks and switch to airplane mode.

Airplane mode – After switching to airplane mode, all wireless connections are disabled.

Wi-Fi – Turns on Wi-Fi to connect to available Wi-Fi networks.

Wi-Fi settings – Allows you to set up and manage wireless access points. Set network notification or add a Wi-Fi network. The advanced Wi-Fi settings screen is accessed from the Wi-Fi settings screen. Press the **Menu** key and touch **Advanced**.

Wi-Fi Direct Settings – Set Wi-Fi Direct device name and scan for other devices.

How to obtain the MAC address
To set up a connection in some wireless networks with MAC filters, you may need to enter the MAC address of your LG-P940 into the router.

You can find the MAC address in the following user interface:
Touch Application > Settings > Wireless & networks > Wi-Fi settings and press the Menu key. Then select Advanced > MAC Address.

Bluetooth – Turns on Bluetooth to connect to Bluetooth devices.

Bluetooth settings – Set device name & discoverable mode, scan for other devices. Alternatively, check a list of Bluetooth devices that you've previously configured as well as those detected when the phone last scanned for Bluetooth devices.

Tethering & portable hotspot – You can configure the USB tethering and portable Wi-Fi hotspot settings.

VPN settings – Displays the list of Virtual Private Networks (VPNs) that you've previously configured. Allows you to add different types of VPN.

Mobile networks – Set options for data roaming, network mode & operators, access point names (APNs) and so on.

On-Screen Phone settings – Allows you to turn on On-Screen Phone and to change the On-Screen Phone password (the default password is "0000").

Call settings

< Fixed Dialing Numbers >

Select **Fixed Dialing Numbers** to turn on and compile a list of numbers that can be called from your phone. You'll need your PIN2, which is available from your operator. Only numbers within the fixed dial list can be called from your phone.

< Voicemail >

Voicemail service – Allows you to select your carrier's voicemail service.

Voicemail settings – If you are using your carrier's voicemail service, this option allows you to enter the phone number to use for listening to and managing your voicemail.

< Other call settings >

Call barring – Select when you would like calls to be barred. Enter the call barring password. Please check with your network operator about this service.

Call reject – Allows you to set the call reject function. Choose from **Off**, **Reject on list** or **Reject all calls**.

Excuse messages – When you want to reject a call, you can send a quick message using this function. This is useful if you need to reject a call during a meeting.

Video call settings – Change your video call settings.

Call forwarding – Choose whether to divert all calls, when the line is busy, when there is no answer or when you have no signal.

Call duration – View the duration of calls including all calls, dialled calls, received calls and last call.

Call costs – View the charges applied to your calls. (This service is network dependent; some operators do not support this function)

Additional settings – This lets you change the following settings:

- **Caller ID:** Choose whether to display your number on an outgoing call.

- **Call waiting:** If call waiting is activated, the handset will notify you of an incoming call while you are on the phone (depending on your network provider).

Sound

< General >

Silent mode – Allows you to silence all sounds (including call and notification ringtones) except the audio from music and videos and any alarms you have set. Media and alarms must be silenced in their own applications.

Vibrate – Allows you to set your phone to vibrate when you receive an incoming call.

Volume – allows you to set the volume for ringtones, media and alarms. If you uncheck the option "use incoming call volume for notifications" you can set the volume for incoming calls and notifications separately.

< Incoming calls >

Phone ringtone – Allows you to set your default incoming call ringtone.

< Notifications >

Notification ringtone – Allows you to set your default notification ringtone.

< Feedback >

Audible touch tones – Allows you to set the phone to play tones when using the dialpad to dial numbers.

Audible selection – Allows you to set your phone to play a sound when you touch buttons, icons and other onscreen items that react to your touch.

Screen lock sounds – Allows you to set your phone to play a sound when locking and unlocking the screen.

Haptic feedback – Allows you to set your phone to vibrate briefly when you touch the soft keys and carry out other actions.

Display

Brightness – Adjust the screen brightness.

Auto-rotate screen – Set to switch orientation automatically when you rotate the phone.

Animation – Set to display an animation.

Screen timeout – Set the time for screen timeout.

Display font – Change the display font.

Gesture

Use motion gestures – Adjust the gesture settings for the text input field, incoming call, alarm, gallery and video player.

Reset gesture sensor – Calibrate the motion sensor with the phone placed on a flat surface.

Location & security

Use wireless networks – If you select **Use wireless networks**, your phone determines your approximate location using Wi-Fi and mobile networks. When you select this option, you're asked whether you consent to allowing Google to use your location when providing these services.

Use GPS satellites – If you select **Use GPS satellites**, your phone determines your location to street level accuracy.

Set up screen lock – Set an unlock pattern to secure your phone. Opens a set of screens that guide you through drawing a screen unlock pattern. You can set a **PIN** or **Password** instead of a **Pattern** or leave it as **None**.

When you turn on your phone or wake up the screen, you're asked to draw your unlock pattern to unlock the screen.

Set up SIM/RUIM card lock – Set up SIM/RUIM card lock or change the SIM/RUIM PIN.

Visible passwords – Select to show passwords as you type them or deselect to hide passwords as you type them.

Select device administrators – Add one or more administrators.

Use secure credentials – Allows you to access secure certificates.

Install from SD card – Choose to install encrypted certificates from your SD card.

Set password – Set or change the credential storage password.

Clear storage – Clear credentials for all content and reset password.

Applications

You can view and manage the applications.

Unknown sources – Default setting to install non-Market applications.

> WARNING:

Depending on the applications you install, the mobile phone may not operate correctly and could be illegally used to establish your location and gain access to personal information via the Internet.

To protect your phone and personal data, only download applications from trusted sources such as Android Market.

Manage applications – Manage and remove installed applications.

Running services – Check services that are currently running.

Storage use – View storage used by applications.

Battery usage – See what has been using the battery.

Development – Set options for application development.

Accounts & sync

< General sync settings >

Background data – Permits applications to synchronise data in the background, whether or not you are actively working in them. Deselecting this setting can save battery power and lowers (but does

not eliminate) data usage.

Auto-sync – Permits applications to synchronise, send and receive data to their own schedule.

< Manage accounts >

List of all Google accounts and other accounts you have added to your phone.

If you touch an account in this screen, its account screen opens.

Privacy

Factory data reset – If you select Factory data reset, it will erase all of your personal data from the internal phone storage, including information about your Google account, any other accounts, your system/application data and settings, any downloaded applications and your DRM licence.

Resetting the phone will not erase any system software updates you have downloaded or any files on your microSD card, such as music or photos. If you reset the phone in this way, you are prompted to re-enter the same information that you entered when you first started Android.

Storage

< USB connection mode >

Mass storage only – Your phone can be used as a mass storage device if you have a memory card inserted. You can set **Mass storage only** as a default setting for USB connection mode.

< SD card >

Check total available SD card space. Touch **Unmount SD card** for safe removal. **Erase SD card** if you want to delete all data from the SD card.

< Internal storage >

Checks the available space.

Language & keyboard

Use the Language & keyboard settings to select the language and region for the text on your phone and for configuring the on-screen keyboard, including words you've added to its dictionary.

Voice input & output

< Voice input >

Voice recognition settings – Use the **Voice recognition settings** to configure the Android voice input feature.

- **Language:** Opens a screen where you can set the language you use speech to enter text.
- **SafeSearch:** Opens a dialog box where you can set whether you want the Google SafeSearch filter to block certain results.
- **Block offensive words:** When deselected, Google voice recognition will recognise and transcribe words many people consider offensive, when you use speech to enter text. When selected, Google voice recognition replaces those words in transcriptions with a placeholder comprised of hash symbols (#).

< Voice output >

Text-to-speech settings – Use the **Text-to-speech settings** to configure the Android text-to-speech synthesiser for applications that can use this feature.

If you don't have speech synthesiser data installed, only the Install voice data setting is available.

- **Listen to an example:** Plays a brief sample of the speech synthesiser, using your current settings.

- **Always use my settings:** Check to use the settings on this screen rather than the speech synthesiser settings available in other applications.
- **Default Engine:** Opens a dialog where you can set the text-to-speech application you want to use, if you have more than one installed.
- **Install voice data:** If your phone does not have speech synthesiser data installed, this connects to Android Market and guides you through the process of downloading and installing the data. This setting is not available if the data is already installed.
- **Speech rate:** Opens a dialog where you can select how quickly you want the synthesiser to speak.
- **Language:** Opens a dialog where you can select the language of the text you want the synthesiser to read. This is particularly useful when combined with **Always use my settings** to ensure text is spoken correctly across a variety of applications.
- **Pico TTS:** Configure the **Pico TTS settings**.

Accessibility

Use the **Accessibility** settings to configure accessibility plug-ins you have installed on your phone.

Requires additional plug-ins.

Date & time

Use **Date & time** settings to set how dates are displayed. You can also use these settings to set your own time and time zone rather than obtaining the current time from the mobile network.