



English

LG-P768g User Guide

This guide helps you get started using your phone.

If you need more information, please visit www.lg.com.

- Some of the contents of this manual may not apply to your phone. This depends on your phone's software and your service provider.
- This handset is not recommended for the visually impaired because of its touch screen keyboard.
- Copyright ©2012 LG Electronics, Inc. All rights reserved. LG and the LG logo are registered trademarks of LG Group and its related entities. All other trademarks are the property of their respective owners.
- Google™, Maps™, Gmail™, YouTube™, Google Talk™ and Play Store™ are trademarks of Google, Inc.

This device is not intended for sale in the U.S.A

Part 15.21 statement

" Change or Modifications that are not expressly approved by the manufacturer could void the user's authority to operate the equipment.

Part 15.105 statement

This equipment has been tested and found to comply with the limits for a class B digital device, pursuant to Part 15 of the FCC Rules. These limits are designed to provide reasonable protection against harmful interference in a residential installation. This equipment generates uses and can radiate radio frequency energy and, if not installed and used in accordance with the instructions, may cause harmful interference to radio communications. However, there is no guarantee that interference will not occur in a particular installation. If this equipment does cause harmful interference or television reception, which can be determined by turning the equipment off and on, the user is encouraged to try to correct the interference by one or more of the following measures:

- Reorient or relocate the receiving antenna.
- Increase the separation between the equipment and receiver.
- Connect the equipment into an outlet on a circuit different from that to which the receiver is connected.
- Consult the dealer or an experienced radio/TV technician for help.

FCC Part 15 Class B Compliance

This device and its accessories comply with part 15 of FCC rules and ICES-003 Class B digital apparatus requirements for Industry Canada. Operation is subject to the following two conditions:(1) This device and its accessories may not cause harmful interference, and (2) this device and its accessories must accept any interference received, including interference that may cause undesired operation.

Body-worn Operation

This device has been tested for body-worn operations with the distance of 1.0cm (0.39 inches) between the user's body and the phone. To comply with FCC RF exposure requirements, a minimum separation distance of 1.0cm (0.39 inches) must be maintained from the user's body. Third-party belt-clips, holsters, and similar accessories containing metallic components may not be used. Body-worn accessories that cannot maintain 1.0cm (0.39 inches) separation distance between the user's body and the phone, and have not been tested for typical body-worn operations may not comply with FCC RF exposure limits and should be avoided.

WIFI Caution

This device is capable of operating in 802.11a/n mode. For 802.11a/n devices operating in the frequency range of 5.15 - 5.25 GHz, they are restricted for indoor operations to reduce any potential harmful interference for Mobile Satellite Services (MSS) in the US. WIFI Access Points that are capable of allowing your device to operate in 802.11a/n mode(5.15 - 5.25 GHz band) are optimized for indoor use only.

If your WIFI network is capable of operating in this mode, please restrict your WIFI use indoors to not violate federal regulations to protect Mobile Satellite Services.

For Your Safety

What does “SAR” mean?

In 1996, the FCC, working with the FDA, the U.S. Environmental Protection Agency, and other agencies, established RF exposure safety guidelines for wireless phones in the United States. Before a wireless phone model is available for sale to the public, it must be tested by the manufacturer and certified to the FCC that it does not exceed limits established by the FCC. One of these limits is expressed as a Specific Absorption Rate, or “SAR.” SAR is a measure of the rate of absorption of RF energy in the body. Tests for SAR are conducted with the phone transmitting at its highest power level in all tested frequency bands. Since 1996, the FCC has required that the SAR of handheld wireless phones not exceed 1.6 watts per kilogram, averaged over one gram of tissue.

Although the SAR is determined at the highest power level, the actual SAR value of a wireless phone while operating can be less than the reported SAR value. This is because the SAR value may vary from

call to call, depending on factors such as proximity to a cell site, the proximity of the phone to the body while in use, and the use of hands-free devices. Before a phone model is available for sale to the public, it must be tested and certified to the FCC that it does not exceed the limit established by the government-adopted requirement for safe exposure. The tests are performed in positions and locations (e.g., at the ear and worn on the body) as required by the FCC for each model.

The highest SAR value for this model phone when tested for use at the ear is 0.55 W/kg and when worn on the body, as described in this user guide, is 1.18 W/kg (body-worn measurements differ among phone models, depending upon available accessories and FCC requirements).

While there may be differences between SAR levels of various phones and at various positions, they all meet the government requirement for safe exposure.

The FCC has granted an Equipment Authorization for this model phone with all reported SAR levels evaluated as in compliance with the FCC RF emission guidelines. SAR information on this model

phone is on file with the FCC and can be found under the Display Grant section of <http://www.fcc.gov/oet/ea/fccid/> after searching on FCC ID *ZNFP768g*

For more information about SARs, see the FCC's OET Bulletins 56 and 65 at http://www.fcc.gov/Bureaus/Engineering_Technology/Documents/bulletins or visit the Cellular Telecommunications Industry Association website at http://www.ctia.org/consumer_info/index.cfm/AID/10371. You may also wish to contact the manufacturer of your phone.

For Your Safety

- Do not expose the phone to liquid or moisture.
- Use the accessories like earphones cautiously. Do not touch the antenna unnecessarily.
- Do not use, touch or attempt to remove or fix broken, chipped or cracked glass. Damage to the glass display due to abuse or misuse is not covered under the warranty.
- Your phone is an electronic device that generates heat during normal operation. Extremely prolonged, direct skin contact in the absence of adequate ventilation may result in discomfort or minor burns. Therefore, use care when handling your phone during or immediately after operation.
- Some hearing aids might be disturbed by mobile phones.
- Minor interference may affect TVs, radios, PCs, etc.
- Road safety
- Check the laws and regulations on the use of mobile phones in the area when you drive.
- Do not use a hand-held phone while driving.
- Give full attention to driving.
- Pull off the road and park before making or answering a call if driving conditions so require.
- RF energy may affect some electronic systems in your vehicle such as car stereos and safety equipment.
- When your vehicle is equipped with an air bag, do not obstruct with installed or portable wireless equipment. It can cause the air bag to fail or cause serious injury due to improper performance.

Efficient phone operation

Electronics devices

All mobile phones may get interference, which could affect performance.

- Do not use your mobile phone near medical equipment without requesting permission. Avoid placing the phone over pacemakers, for example, in your breast pocket.
-

- If you are listening to music whilst out and about, please ensure that the volume is at a reasonable level so that you are aware of your surroundings. This is particularly imperative when near roads.

Avoid damage to your hearing

Damage to your hearing can occur if you are exposed to loud sound for long periods of time. We therefore recommend that you do not turn the handset on or off when close to your ear. We also recommend that music and call volumes are set to a reasonable level.

- When using headphones, turn the volume down if you cannot hear the people speaking near you, or if the person sitting next to you can hear what you are listening to.

NOTE: Excessive sound pressure from earphones can cause hearing loss.

Glass Parts

Some parts of your mobile device are made of glass. This glass could break if your mobile device is dropped on a hard surface or receives a substantial impact. If the glass breaks, do not touch or attempt to remove. Stop using your mobile device until the glass is replaced by an authorised service provider.

Blasting area

Do not use the phone where blasting is in progress. Observe restrictions, and follow any regulations or rules.

Potentially explosive atmospheres

- Do not use the phone at a refuelling point.
- Do not use near fuel or chemicals.
- Do not transport or store flammable gas, liquid, or explosives in the same compartment of your vehicle as your mobile phone and accessories.

For Your Safety

In aircraft

Wireless devices can cause interference in aircraft.

- Turn your mobile phone off before boarding any aircraft.
- Do not use it on the ground without permission from the crew.

Children

Keep the phone in a safe place out of the reach of small children. It contains small parts which may cause a choking hazard if detached.

Emergency calls

Emergency calls may not be available under all mobile networks. Therefore, you should never depend solely on the phone for emergency calls. Check with your local service provider.

Battery information and care

- You do not need to completely discharge the battery before recharging. Unlike other battery systems, there is no memory effect that could compromise

the battery's performance.

- Use only LG batteries and chargers. LG chargers are designed to maximise the battery life.
- Do not disassemble or short-circuit the battery pack.
- Keep the metal contacts of the battery pack clean.
- Replace the battery when it no longer provides acceptable performance. The battery pack may be recharged hundreds of times until it needs replacing.
- Recharge the battery if it has not been used for a long time to maximise usability.
- Do not expose the battery charger to direct sunlight or use it in high humidity, such as in the bathroom.
- Do not leave the battery in hot or cold places as this may deteriorate the battery performance.
- There is risk of explosion if the battery is replaced by an incorrect type.
- Dispose of used batteries according to the manufacturer's instructions. Please recycle when possible. Do not dispose

as household waste.

- If you need to replace the battery, take it to the nearest authorised LG Electronics service point or dealer for assistance.
 - Always unplug the charger from the wall socket after the phone is fully charged to save unnecessary power consumption of the charger.
 - Actual battery life will depend on network configuration, product settings, usage patterns, battery and environmental conditions.
-

Getting to know your phone

Before you start using the phone, please read this!

Please check to see if any problems you have encountered with your phone are described in this section before taking the phone in for service or calling a service representative.

1. Phone Memory

In order to make more memory available, you will have to manage your applications and delete some data, such as applications or messages.

Managing Applications

- 1 From the Home screen, tap the **Menu/Search Key**  and tap **App settings**.
- 2 When the list of applications appears, scroll and tap the application you want to disable.
- 3 Tap **Uninstall** and then tap **OK** to confirm that you want to uninstall the desired application.

2. Optimizing Battery Life

You can extend your battery's life between charges by turning off features that you don't need to run constantly in the background. You can also monitor how applications and system resources consume battery power.

To extend the life of your battery

- Turn off radio communications that you aren't using, such as Wi-Fi, Bluetooth, or GPS.
- Lower screen brightness and set a shorter screen timeout.
- Turn off automatic syncing for Gmail™, Calendar, Contacts, and other applications.
- Some applications you have downloaded may cause your battery power to be reduced.
- While using downloaded applications, check the battery charged level.

To view the battery charge level

- 1 From the Home screen, tap the **Menu/Search Key**  and tap **System settings > About phone > Battery**.
- 2 The battery status (charging or not charging) and level are displayed on the

top menu of the screen.

To monitor and control what uses the battery

- 1 From the Home screen, tap the **Menu/Search Key**  and tap **System settings** > **Power Saver** > **Battery use**.
- 2 The bottom of the screen displays battery usage time. Either how long since last connected to a power source, or if connected to a power source, how long you were last running on battery power. The screen also lists applications or services using battery power from greatest amount to least.

3. Installing an Open Source Operating System

Installing an open source operating system on your phone and not using the operating system provided by the manufacturer can cause your phone to malfunction.

Warning

- If you install and use an OS other than the one provided by the manufacturer, your phone is no longer covered by the warranty.
- To protect your phone and personal data, download applications only from trusted sources, such as Play Store. If some applications are not properly installed on your phone, your phone may not work properly- or serious errors may occur. You will need to uninstall those applications and all of its data and settings from the phone.

4. Using the Swipe, Face Unlock, Pattern, PIN, or Password

Set the Face unlock, or an unlock Pattern, PIN, or Password to secure your phone. To set the screen lock, follow the process below.

From the Home screen, tap the **Menu/Search Key** , tap **System settings** > **Lock screen** > **Select screen lock** and



Getting to know your phone

select among **None, Swipe, Pattern, PIN** or **Password**.

NOTE

In case that you would have trouble with Face Unlock, you can unlock the screen with the unlock pattern and/or PIN as a backup.

Warning

Take precautions when using an Unlock Pattern, PIN, or Password. It is very important that you remember the screen unlock information you set. You are allowed 5 attempts to enter your screen unlock information. If you used up all 5 opportunities, you will have to wait 30 seconds to attempt unlocking the phone again.

When you can't recall your Unlock Pattern, PIN, or Password:

If you logged into a Google account on the phone and failed to use the correct pattern 5 times, tap **Forgot pattern?** You will be required to sign in with your Google account and prompted to create a new unlock pattern.

If you have set a backup PIN, you can unlock the screen with keying in the backup PIN.

If you haven't created a Google account on the phone or you forgot your PIN or Password, you need to perform a hard reset. Or, you can unlock the phone with the Backup pin.

5. Using Hard Reset (Factory Reset)

If your phone needs to be restored to its original condition, use a **Hard Reset** to initialize your phone.



- 1 Turn the power off.
- 2 Press and hold the following keys at the same time for 8 seconds: **Power/Lock Key + Up Volume Key**.
- 3 When FACTORY HARD RESET screen is displayed, release the keys.
- 4 Press the **Power/Lock Key** to confirm -- delete all user data, and press the Volume Keys to cancel.

Warning

If you perform a Hard Reset, all user applications and user data will be deleted. Please remember to back up any important data before performing a **Hard Reset**.

6. Using Safe Mode

To recover your phone when malfunctioning.

- 1 Turn off your phone and reboot. When you see the booting animation press and hold the **Menu/Search Key** . Your main screen will then be displayed with the words "Safe mode" in lower left corner.
- 2 From the Home screen, tap the **Menu/Search Key**  and tap **App settings**.
- 3 Tap one of the available tabs at the top of the screen and select the application you wish to uninstall.
- 4 Tap **Uninstall** and **OK** to confirm.
- 5 After uninstalling the application, turn off and reboot your phone.

7. Using a micro SD Card

Pictures, Music and Video files, can be saved to external memory. Before saving these files to external memory, you need to insert a micro SD card. If you have not inserted a micro SD card, you will not be able to save these items on external memory.

Warning

Do not remove the micro SD card without unmounting it first. Otherwise, it may damage the micro SD card as well as your phone, and the data stored on the micro SD card may be corrupted. To remove the micro SD card safely, from the Home screen, tap the **Menu/Search Key**  and tap **System settings > Storage > Unmount SD card > OK**.

Getting to know your phone

8. Connecting your phone to a computer via USB

- 1 Use the USB cable that was provided with your phone to connect the phone to a USB port on your computer. You'll receive a notification that the USB is connected and can see USB connection mode popup.
- 2 Tap **Media sync (MTP)** to confirm that you want to transfer files between your phone's micro SD card and the computer.

When the phone is connected as USB storage, you receive a notification. Your phone's micro SD card is installed as a drive on your computer. You can now copy files to and from the micro SD card.

TIP

You cannot access the micro SD card from your phone while connected as USB storage. So you cannot use applications that rely on the micro SD card, such as Music.

9. Opening and switching applications

Multitasking is easy with Android because you can keep more than one application running at the same time. There's no need to quit an application before opening another. Use and switch between several open applications. Android manages each application, stopping and starting them as needed to ensure that idle applications don't consume resources unnecessarily.

To stop applications:

- 1 Touch **Apps Key**  > **Settings** > **Apps** > **Running** tab.
- 2 Scroll to the desired application and touch **Stop** to stop it.

TIP

To return to a recent application, press and hold the **Home Key**  . The screen then displays a list of applications you have recently used.

10. Installing PC Software(LG PC Suite)

“LG PC Suite” PC Application is a program that helps you connect your device to a PC via a USB cable and Wi-Fi. Once connected, you can use the functions of your device from your PC.

With your “LG PC Suite” PC Application, You Can...

- Manage and play your media contents (music, movie, pictures) on your PC.
- Send multimedia contents to your device.
- Synchronises data (schedules, contacts, bookmarks) in your device and PC.
- Backup the applications in your device.
- Update the software in your device.
- Backup and restore the device.
- Play multimedia content in your PC from another device.

NOTE

You can use the Help menu from the application to find out how to use your “LG PC Suite” PC application.

Installing “LG PC Suite” PC Application

“LG PC Suite” PC application can be downloaded from the LG website.

- 1 Go to www.lg.com and select a country of your choice.
- 2 Go to **Support > MOBILE SUPPORT > LG Mobile Phones** > Select the Model (LG-P768g) or Go to **Support > Mobile Phone Support** > Select the Model (P768g).
- 3 Click **PC Sync** from **MANUALS & DOWNLOAD**, and click **DOWNLOAD to download “LG PC Suite” PC software** or Click **PC Sync** from **Downloads**, and click **WINDOW PC Sync Download** to download “LG PC Suite” PC software.

System Requirements for “LG PC Suite” PC software

- OS: Windows XP 32 bit(Service pack 2), Windows Vista 32 bit/64 bit, Windows 7 32 bit/64 bit
- CPU: 1GHz or higher processor
- Memory: 512MB or higher RAM
- Graphic card: 1024 x 768 resolution, 32 bit color or higher
- HDD: 100 MB or more free hard disk space (More free hard disk space may be needed depending on the volume of

Getting to know your phone

data stored.)

- Required software: LG integrated drivers.

NOTE

LG Integrated USB Driver

LG integrated USB driver is required to connect an LG device and PC and installed automatically when you install “LG PC Suite” PC software.

11. Unlock screen when using data connection

Your screen will go dark if untouched for a period of time when using a data connection. To turn on your LCD screen, press the **Power/Lock Key** .



12. Hold the phone straight up

Please hold the mobile phone straight up as a regular phone.

While making/receiving calls or sending/receiving data, try to avoid holding the lower part of the phone where the antenna is located. It may affect call quality.

13. When the screen freezes

If the phone does not respond to user input or the screen freezes:

Press and hold the **Power/Lock Key**  for 12 seconds to turn it off. Then, press and hold the **Power/Lock Key**  again for 3 seconds to reboot the phone.

14. Do not connect your phone when you power on/off your PC

Make sure to disconnect your phone from the PC when powering your PC on or off as it might result in PC errors.

Your Phone

To turn on the phone, press and hold the Power/Lock Key for 3 seconds.

To turn off the phone, press the Power/Lock Key for 3 seconds and tap **Power off** and **OK** to confirm.





Front view

Earpiece

Front-Facing Camera Lens

- Use to take a picture of yourself or to video chat on supported applications.

Quick Keys

- Phone Key 
- Contacts Key 
- Messaging Key 
- Applications Key 

Back Key

- Returns to the previous screen.
- Closes pop-up menus and dialog boxes.

Home Key

- Returns to the Home screen from any screen.

Power/Lock Key

- Powers your phone on/off by pressing and holding the key.
- Turns your screen on and off and locks it.

Proximity Sensors

- Senses proximity toward other objects, such as your head during a call, so that you do not accidentally activate unwanted features.

Menu/Search Key

- Displays available options for the current screen.
- Touch and hold to activate the search function.



Side view

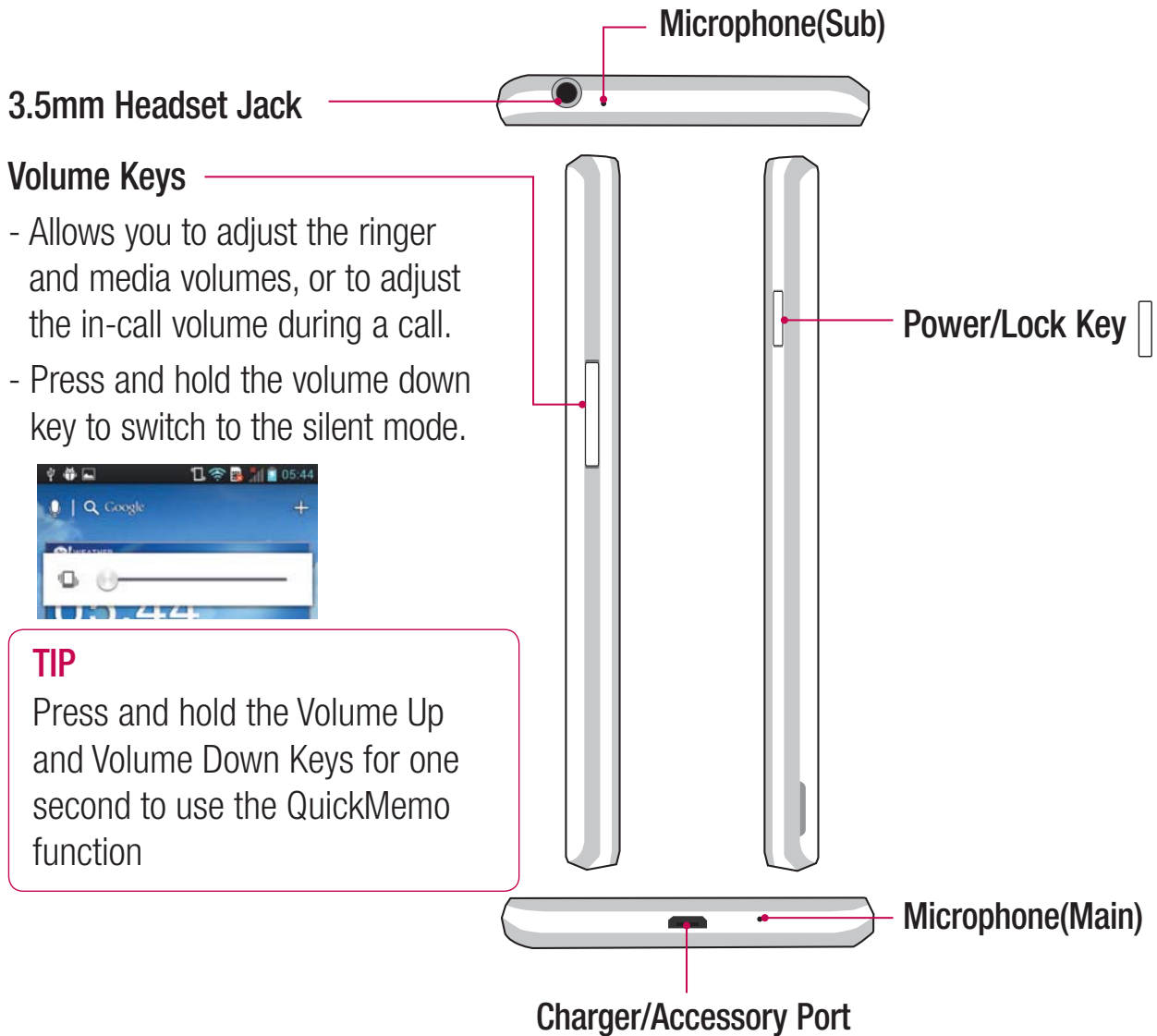

Your Phone

Rear view

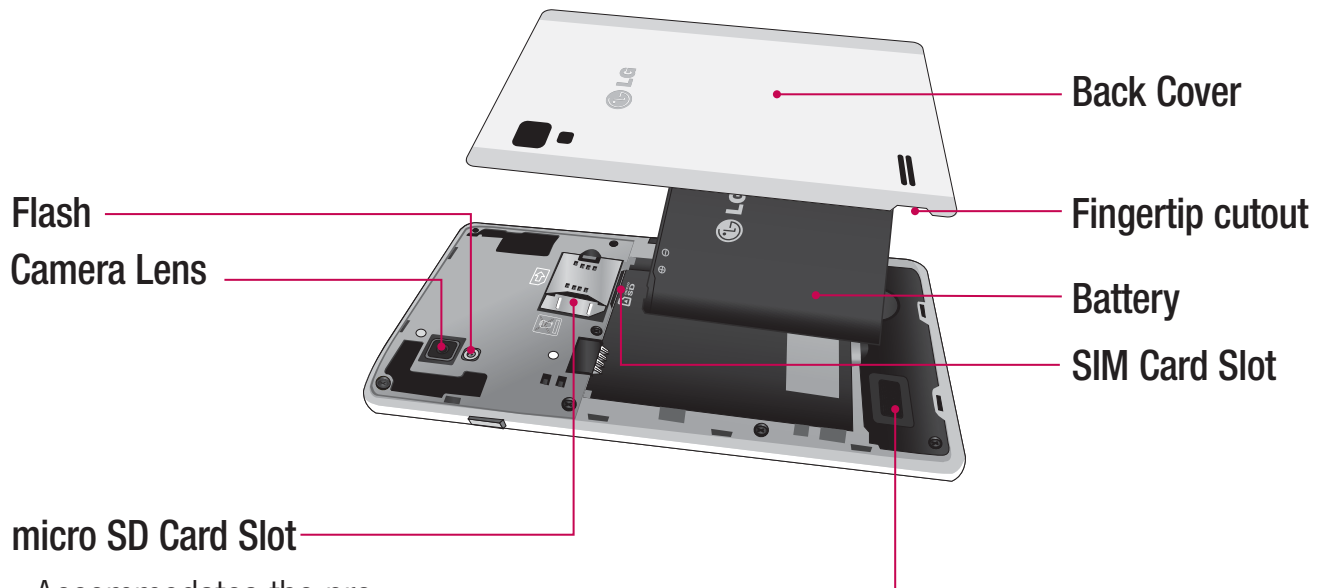

micro SD Card Slot

- Accommodates the pre-installed 16GB micro SD™ card (expandable up to 32GB).

External speaker

- Allows you to listen to sounds on your phone such as ringtones and music.

Getting Started

Installing the Micro SIM card and battery

Before you can start exploring your new phone, you'll need to set it up. To insert the Micro SIM card and battery:

- 1** Hold the phone on your hand firmly. With the other hand, lift the back cover using the fingertip cutout located on the bottom of the cover and remove it.
 - 2** Slide the Micro SIM card into the Micro SIM card slot. Make sure the gold contact area on the card is facing downwards.
 - 3** Insert the battery into place by aligning the gold contacts on the phone and the battery **1** and press the battery down until it clicks into place **2**.
 - 4** Replace the back cover of the phone (as demonstrated below). Apply a steady downward pressure until the battery cover clicks into place.
-

Getting Started

Charging your phone

A rechargeable Li-ion battery is used to power your phone. In addition, A wall charger, which is included with your phone can be used to charge the battery. Ask your local LG dealer for further details regarding approved batteries and chargers.

Before first time use of your phone, make sure the battery is fully charged.

An uncharged battery will fully recharge after 4 hours.

NOTE

Make sure the battery is installed before connecting the wall charger. If the battery is not installed and the wall charger is connected, the phone will not operate properly due to prolonged power cycling. If you do not unplug the wall charger before removing the battery, the device may get damaged as a result.

Important!

It is best to charge the battery fully before using the phone for the first time.

1. Connect the USB cable to the charger usb input.
2. Find the Charger/accompanying jack (1).
3. Insert the USB cable into the device's Charger/accompanying jack (2).
4. Plug the charger into a regular AC power outlet. The phone will automatically turn on with the screen showing as locked. Both the phone's charge state and percent of charge will be displayed.
5. When charging is completed, first disconnect the charger plug from the AC wall outlet, then disconnect the charger cable

Warning!

If the touch screen does not function while the phone's in the process of charging, this may be due to an unstable power supply. As a result, disconnect the USB cable from the device or unplug the USB power adapter from the power outlet.

- 1 Connect the cables wall adapter and USB cable.
- 2 Plug the USB cable (as shown below) into the phone's charger/accessory port. Make sure the USB symbol is facing upwards.

NOTE

Your phone has an internal antenna. Be careful not to scratch or damage this rear area, as that will cause loss of performance.

If the phone is turned off as the battery is fully discharged, the battery is called a weak battery. In this case when the phone connect to the charger(TA or USB) cable, the keypad LED at the bottom of the phone will be blinking. This is normal operation in the weak battery to prevent over-current flowing because the phone is designed to provide reasonable protection algorithm for against damage of battery. And after a few minutes, the LCD is turned on normally.

NOTE

The battery must be fully charged initially to improve battery lifetime.

Your Home screen

Touch screen tips

With the touch of your finger, you can access available applications, make menu selections, and access data saved to your phone. The following terms are used for describing the different available actions using the touchscreen:

Tap - A single finger tap selects items, links, shortcuts and letters on the on-screen keyboard.

Touch and hold - Touch and hold an item on the screen by touching it and not lifting your finger until an action occurs. For example, to open a contact's available options, touch and hold the contact in the Contacts list until the context menu opens.

Drag - Touch and hold an item for a moment and then, without lifting your finger, move your finger on the screen until you reach the target position. You can drag items on the Home screen to reposition them.

Swipe or slide - To swipe or slide, quickly move your finger across the surface of the screen, without pausing when you first touch it (so you don't drag an item instead). For example, you can slide the screen up or down to scroll through a list, or browse

through the different Home screens by swiping from left to right (and vice versa).

Double-tap - Double-tap to zoom on a Web page or a map. For example, quickly double-tap a section of a Web page to adjust that section to fit the width of the screen. You can also double-tap to zoom in and out when taking a picture (using the Camera), and when using Maps.

Pinch-to-Zoom - Use your index finger and thumb in a pinch or spread motion to zoom in or out when using the browser, Maps, or browsing pictures. You can also double-tap to zoom in and out when taking a picture (using the Camera).

Rotate the screen - From many applications and menus, the orientation of the screen adjusts to the device's physical orientation.

NOTE

- To select an item, tap the centre of the icon.
- Do not press too hard; the touch screen is sensitive enough to pick up a light, firm touch.
- Use the tip of your finger to tap the option you want. Be careful not to tap any other keys or icons.

Proximity sensors

When receiving and making calls, this sensor automatically turns the backlight off and locks the touch keypad by sensing when the phone is near your ear. This extends battery life and prevents the touch keypad from activating unintentionally during calls.

Lock your phone

When you are not using the LG-P768g, press the **Power/Lock Key**  to lock your phone. This helps prevent accidental presses and saves battery power.

Also, if you do not use the phone for a while, the Home screen or other screen you are viewing, is automatically replaced with the lock screen after 30 seconds of inactivity to conserve the battery and prevent pocket dialling.

To wake up your phone, press the **Power/Lock Key** . The lock screen will appear. Slide the lock screen up. The last screen you were working on opens.

Your Home screen

NOTE

- The automatic screen timeout can be configured manually in Settings.
- If there are any programs running when you lock the phone, they may still be running in lock mode. It is recommended that you exit all programs before entering the lock mode to avoid unnecessary charges (e.g., phone call, web access and data communications).

Setting Swipe, Face Unlock, Pattern, PIN, Password to unlock your phone

You can slide the screen without entering any information, utilize facial recognition, draw your own unlock Pattern or enter a PIN or Password to add more security to your device. To set Swipe, Face Unlock, Pattern, PIN, or Password, from the Home screen tap the **Menu/Search Key**  > **System settings** > **Lock screen** > **Select screen lock**. Then choose from **Swipe**, **Pattern**, **PIN**, or **Password** and enter the desired information.

Caution

You are allowed 5 attempts to enter your screen unlock information. If you used up all 5 opportunities, you will have to wait 30 seconds to attempt unlocking the phone again.

Quick Switch to Silent Mode

To quickly set your phone to silent mode, press and hold the **Volume Down Key** until you see  on the screen.

QuickMemo

Use QuickMemo to practically and efficiently create memos during a call, with a saved picture or on the current phone screen.

- 1 Push and hold in the Volume Up and Volume Down buttons for one second to use the **QuickMemo** function



- 2 Select the desired menu option from **Pen type**, **Color**, **Eraser**, and create a memo.









- 3 Touch  to save the memo with the current screen.

NOTE

Please use a fingertip while using the QuickMemo function. Do not use your fingernail.

Using the QuickMemo options

While using the QuickMemo function, you can easily use the QuickMenu options.

-  – Select if you want to use the background screen or not.
-  – Undo or Redo.
-  – Select the pen type and the colour.
-  – Erase the memo that you created.
-  – Send or share the current QuickMemo to others.
-  – Save the memo with the current screen.

Viewing the saved QuickMemo

Touch **Gallery** and select the QuickMemo album.

Your Home screen

Home

Simply swipe your finger to the left or right to view the different panels.

You can also customize each panel with shortcuts, and folders. You can also customize each panel with widgets, which are shortcuts to your Favourite applications.

NOTE

On the Home screen, you can view quick keys at the bottom of the screen. The quick keys provide easy, one-tap access to the functions you use the most.

Customizing your Home screen

You can customize your Home screen by adding quick access elements, such as shortcuts, widgets, folders to it, or changing the wallpaper.

- **Widgets:** Add dynamically updating widgets to your Home screen to allow quick access to applications without opening the full application.
 - **Wallpapers:** Change the Home screen wallpaper.
- To add shortcuts to Apps or Widgets on the Home screen:**
- 1 Select a location (Home screen panels) to add an item by swiping the Home screen from left to right or vice versa.
 - 2 Tap the  (on the top right of the screen) and click an item. Or, touch and hold an empty part of the Home screen.
 - 3 Tap the type of item you want to add on the screen: **Apps, Downloads, Widgets, or Wallpapers.**
 - 4 Tap an available apps, downloads, or widget.
 - 5 You will see a new icon on the Home screen. To place it on a different panel, touch and hold it to drag it to the desired location on the desired panel and release your finger from the screen.
- **Apps:** Add shortcuts to applications on the Home screen.
 - **Downloads:** Add shortcuts to downloaded applications on the Home screen.

TIP

To add a preloaded application or an application you have downloaded from Play Store to the Home screen, simply touch and hold the icon you want in the Applications Screen to add to the Home screen.

NOTE

If there is no available space on a particular Home screen panel, you must delete or remove an item before you can add another item. In this case, you have the option of switching to another Home screen panel.

To delete an application icon from the Home screen, touch and hold the shortcut icon you want to delete and drag to the **Remove** icon at the top of the screen. You cannot delete the preloaded applications. (Only their icons can be deleted from the screen).

Customizing Apps Icons on Home screen

You can customize each application icon.

- 1 Touch and hold an app icon until the editing icon .





- 2 Tap the app again and select the a desired icon design. Or tap Create photo icon to take a new picture or select a picture from the Gallery.

Your Home screen



Getting back to a recently used application

- 1 Touch and hold the **Home Key** . The screen will display the icons of applications that you have used recently.
- 2 Tap an icon to open its application or tap the **Back Key**  to return to the current application.

Notifications panel

Notification icons on the Status Bar report the arrival of new messages, calendar events, alarms, as well as ongoing events, such as when you are in a call. You can view and edit a list of all recent notifications. The Notifications panel runs across the top of your screen.

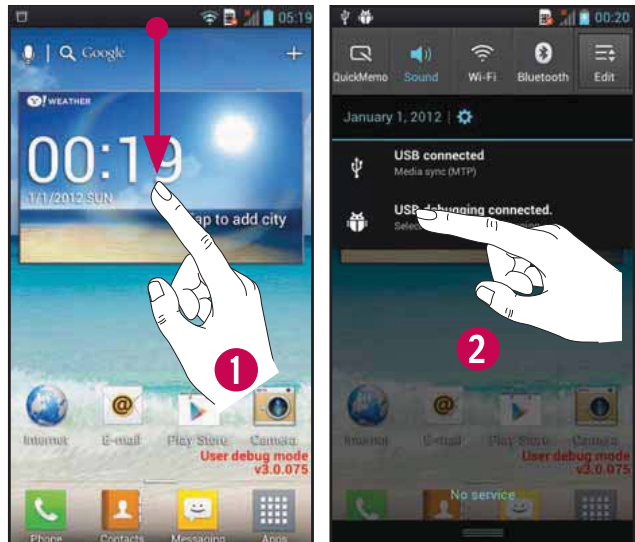

- 1 Touch the status bar to show the Notifications tab, then drag the tab to the bottom of the screen to open the Notifications panel.
- 2 Touch **Clear**. The notifications will be erased from the panel.



Touch and hold the Status Bar and slide it down with your finger to open the Notifications Panel. From here, you can check and quickly turn on and off Sound mode, QuickMemo, Wi-Fi, Bluetooth, and any other options you add.















Viewing the Status bar

The Status bar uses different icons to display phone information, such as signal strength, new messages, battery life, and active Bluetooth and data connections.















Below is a table explaining the meaning of icons you are likely to see in the Status bar.

[Status bar]



Icon	Description
	No SIM card inserted
	No network signal available
	Airplane mode is on
	Connected to a Wi-Fi network
	Wired headset connected
	Call in progress
	Call on hold
	Speakerphone is on
	Phone microphone is muted
	Missed call
	Bluetooth is on
	Connected to a Bluetooth device
	Alarm is set
	New voicemail available

Your Home screen

Icon	Description
	Ringer is silenced
	Vibrate mode is on
	Battery fully charged
	Battery is charging
	Phone is connected to PC via USB cable
	Downloading data
	Uploading data
	GPS is on
	Receiving location data from GPS
	On-Screen Phone connected
	3 more notifications not displayed
	Data is synchronizing
	Download finished
	New email available
	New Gmail available

Icon	Description
	New Google Talk message available
	New text/multimedia message available
	Song is playing
	Upcoming event
	USB tethering is active.
	Portable Wi-Fi hotspot is active
	USB tethering & Portable Wi-Fi hotspot are active.
	Data in and out
	SmartShare On
	SmartShare music playing

On-screen Keyboard

You can enter text using the on-screen keyboard. The on-screen keyboard displays automatically on the screen when you need to enter text. To manually display the keyboard, simply tap a text field where you want to enter text.

There are two types of keypads that you can use: Google voice typing and LG keyboard.

To select the keyboard:

1 Tap the **Menu/Search Key**  > **System settings** > **Language & input** > **Default (Under KEYBOARD & INPUT METHODS)**.

2 Select the default keyboard between Google voice typing and LG Keyboard.

OR

1 While entering text, drag the Status Bar down and tap **Select input method**.

2 Select the desired input method from **Google voice typing**, or **LG Keyboard**.

LG keyboard - QWERTY - Letters Entry

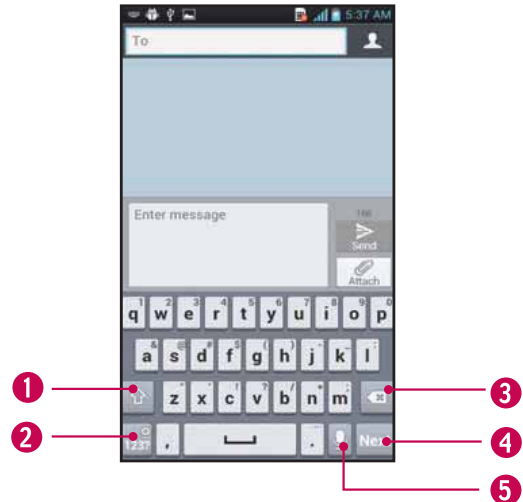

1 **Shift Key** - Tap once to capitalize the next letter you type. Double-tap for all caps.

2 **Number and Symbols/ Settings Key** - Tap to change input to number and symbol entry. Touch and hold to set various LG keyboard settings.

3 **Delete Key** - Tap to delete characters to the left of the cursor.

4 **Next Key** - Tap to move the cursor to the next field.

5 **Voice to Text Key** - Tap to use the voice input function.

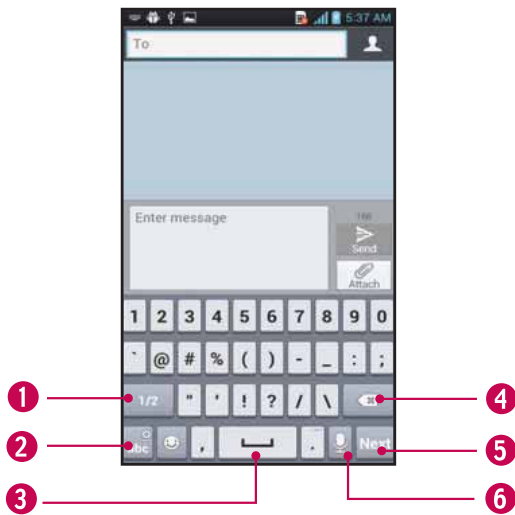

Your Home screen

LG keyboard - QWERTY - Numbers and Symbols Entry



- 1 **Alt Key** - Tap to enter additional symbols. The keyboard will change to alternate characters.
- 2 **Letters/ Settings Key** - Tap to change input to letters entry. Touch and hold to set various LG keyboard settings.
- 3 **Space Key** - Tap to enter space.
- 4 **Delete Key** - Tap to delete characters to the left of the cursor.
- 5 **Next Key** - Tap to move the cursor to the next field.
- 6 **Voice to Text Key** - Tap to use the voice input function.

LG keyboard – Phone keypad

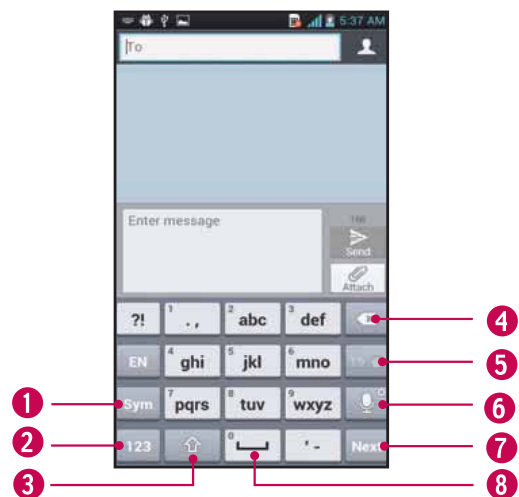

To switch to the phone keypad on LG keyboard, touch and hold . Tap **Input language & type > touch ** for setting, then tap **Phone keyboard**. The Phone keyboard allows you to enter letters by tapping the key labelled with the desired letters, similar to how you would on a traditional 12 key phone. You may have to tap a key up to four times to type the desired letter or number.





- 1 **Symbol Key** - Tap to change input to symbol.
- 2 **Number Key** - Tap to change input to number.
- 3 **Shift Key** - Tap once to capitalize the next letter you type. Double-tap for all caps.

- 4 **Delete Key** - Tap to delete characters to the left of the cursor.
- 5 **T9 Key** - Tap to turn on the T9 entry mode.
- 6 **Voice to Text/ Settings Key** - Tap to use the voice input function. Touch and hold to set various LG keyboard settings.
- 7 **Next Key** - Tap to move the cursor to the next field.
- 8 **Space Key** - Tap to enter space.

Entering text

 **Shift Key** - Tap once to capitalize the next letter you type. Double-tap for all caps. The coloured circle on the button tells you if uppercase is locked on  or if it is just on for one character .

 **Number and Symbols/ Settings Key** - Tap to change to 123 Mode and enter numbers and symbols. Touch and hold to set various LG keyboard settings.

 **Enter Key**- Adds another line when entering text.

 **Delete Key**- Deletes any text you have entered.

To enter a space, tap .

123 Mode

This mode allows you to enter numbers in a text message (a telephone number, for example) more quickly. Tap the keys corresponding to the required digits before manually switching back to the appropriate text entry mode by tapping the  key.

Entering accented letters

The on-screen keyboard allows you to enter special characters (e.g., “á”).

From Phone Keypad (LG Keyboard)

Tap the key that corresponds to the desired character repeatedly until you see the special character you want.

From Qwerty keyboard

To input the accent, press and hold the desired key (press the “a” key for example). After the accented character appears, slide your finger over it and lift it off it to enter it.

Google Account Set-up

The first time you open a Google application on your phone, you will be required to sign in with your existing Google account. If you do not have a Google account, you will be prompted to create one.

Creating your Google account

- 1 From the Home screen, tap **Apps Key** .
- 2 Tap **Gmail** > **Next** to start the Gmail™ setup wizard.
- 3 Tap a text field to open the keyboard and enter your name and tap **Next**.
- 4 Enter your username and tap **Next**. Your phone will communicate with Google servers and check for username availability.
- 5 Enter and re-enter your password. Then follow the instructions and enter the required and optional information about the account. Wait while the server creates your account.

Signing into your Google account

- 1 Enter your email address and password, then tap **Sign in** (If accessing Gmail for the first time, tap **Existing** prior to this step).
- 2 Enter your username and password and tap **Sign in**.
- 3 After signing in, you can use Gmail™ and take advantages of Google services on your phone.
- 4 Once you have set up your Google account, your phone will be automatically synchronized with your Google account on the web. (Depending on your synchronization settings.)

After signing in, your phone will sync with your Google services, such as Gmail™, Contacts, Google Calendar, and Picasa photo albums. You can also use Google Maps™, download applications from Play Store™, back up your settings to Google servers, and take advantage of other Google services on your phone.

Google Account Set-up

IMPORTANT

- Some applications, such as Calendar, work only with the first Google Account you add. If you plan to use more than one Google Account with your phone, be sure to sign into the one you want to use with such applications first. When you sign in, your contacts, Gmail messages, Calendar events, and other information from these applications and services on the web are synchronized with your phone. If you don't sign into a Google Account during setup, you will be prompted to sign in or to create a Google Account the first time you start an application that requires one, such as Gmail or Play Store™.
 - If you have an enterprise account through your company or other organization, your IT department may have special instructions on how to sign into that account.
-

Connecting to Networks and Devices

Wi-Fi

To use Wi-Fi on your phone, you need access to a wireless access point, or “hotspot.” Some access points are open and you can simply connect to them. Others are hidden or implement other security features, so you must configure your phone in order to connect to them.

Turn on Wi-Fi

From the Home Screen, Touch and hold the Status Bar And slide it down with your finger open and tap  to turn Wi-Fi on.

OR

Tap the **Menu/Search Key**  and tap **System settings > Wi-Fi** .

To connect to a Wi-Fi Network

Turn off Wi-Fi when you’re not using it to extend the life of your battery.

1 From the Home screen, tap the **Menu/Search Key**  and tap **System settings > Wi-Fi**.

2 Tap **Wi-Fi** to turn it on and begin scanning for available Wi-Fi networks.

- A list of available Wi-Fi networks will be displayed. Secured networks are indicated by a lock icon.

3 Tap a network to connect to it.

- If the network is secured, you are prompted to enter a password or other credentials. (Ask your network administrator for details).

4 The Status Bar at the top of your screen will display an icon that indicates your Wi-Fi status.

TIP

If you are not in range of a Wi-Fi network and use a network connection. Additional data charges may apply.

Connecting to Networks and Devices

NOTE

This device supports WEP, WPA/WPA2-PSK, WPA PSK, WPA2 Only PSK and 802.1x EAP. (Some EAP methods are not supported.) If your Wi-Fi service provider or network administrator sets encryption for network security, enter the key in the pop-up window. If encryption is not set, this pop-up window will not be shown. You can obtain the key from your Wi-Fi service provider or network administrator.

TIP

Please consult documentation included with Bluetooth device for information on pairing mode and passcode (typically 0 0 0 0 – four zeroes).

Bluetooth



Using Bluetooth

- 1 From the Home screen, tap the **Menu/Search Key**  and tap **System settings** > **Bluetooth** to turn on the Bluetooth setting.
- 2 Tap **Bluetooth icon** > **Search for devices**.
- 3 Tap the name of the device you wish to pair with and connect.

How to send data from your phone via Bluetooth

You can send data via Bluetooth by running a corresponding application, not from Bluetooth menu, unlike regular mobile phones.

- * **Sending pictures:** Open the Gallery application and tap a picture. Then tap the share icon at the top  > **Bluetooth**. Check if Bluetooth is turned on and tap **Search for devices**. Then tap the device you want to send data to from the list.
- * **Exporting contacts:** Open the Contacts application. Tap the contact you want to share, tap the **Menu/Search Key**  and tap **Share** > **Bluetooth**. Check if Bluetooth is turned on and tap **Search for devices**. Then tap the device you want to send data to from the list.

- * **Sending multi-selected contacts:** Open the Contacts application. To select more than one contact, tap the **Menu/Search Key**  and tap **Share**. Tap the contacts you want to send or tap **Select all, done**. Then tap **Bluetooth**. Check if Bluetooth is turned on and tap **Search for devices**. Then tap the device you want to send data to from the list.
- * **Connecting to FTP (Only the FTP server is supported on this handset):** From the Home screen, tap the **Menu/Search Key**  and tap **System settings > Bluetooth**. Make sure Bluetooth is turned on. Tap make phone visible. Then search for other devices. Find the service you want and connect to the FTP server.

TIP

The supported Bluetooth version is Bluetooth 3.0 and certified by Bluetooth SIG. It is compatible with other Bluetooth SIG certified devices.

- If you want to search for this phone from other devices, from the Home screen, tap the **Menu/Search Key**  and tap **System settings > Bluetooth**. Make sure Bluetooth is turned on. Tap Make phone visible to other Bluetooth devices for 120 seconds.
- Supported profiles are HFP/HSP, A2DP, AVRCP, OPP, FTP(Server) and PBAP.

Data Tethering

You can use your phone to provide a data connection to a computer by activating data tethering and connecting them with a USB cable.

To tether your phone with your computer using the USB

- 1 Connect your phone to your computer with a USB cable.

Connecting to Networks and Devices

- 2 You can see USB connection mode popup and tap USB tethering and OK to confirm then tap USB tethering.
- 3 A blue check mark will appear, indicating that the function is activated.

NOTE

- Data Tethering requires an appropriate DataPro data plan. Devices connected by tethering use data from your DataPro plan. Plans are not unlimited and significant charges may be incurred if the included data allowance is exceeded. Performance may vary depending on the number of devices connected and other factors.
- You cannot access your phone's micro SD card on your computer when using USB tethering.
- From the Home screen, tap the **Menu/Search Key**  and tap **System settings > More > Portable Wi-Fi hotspot**. Check to turn on.

Mobile Hotspots

You can also use your phone to provide a mobile broadband connection for up to 8 other devices. Create a hotspot and share your connection.

To create a portable hotspot, tap the **Menu/Search Key**  > **System settings > Portable Wi-Fi hotspot > Configure Wi-Fi hotspot**. Set a password upon first use.

NOTE

Performance may vary depending on the number of devices connected and other factors. If you do not use a password, others will be able to use your Mobile Hotspot connection.

Wi-Fi Direct

Learn to use the WLAN Direct feature to connect two devices via a WLAN without requiring an access point.

Connect your device to another WLAN device

- 1 **System settings > More > Wi-Fi Direct**.
- 2 Press **Search**.
- 3 Select a device and then select **Connect**.
When the owner of the other device

accepts the connection, pairing is complete.

- 4 To deactivate the WLAN Direct feature, select **Disconnect Wi-Fi Direct**.

FileShare

Fileshare is a file sharing application which is provided auto connection based on Wi-Fi Direct. Choose the types of content you would like to share. Choose from Pictures, Videos, Music and Document.

Send data

- 1 **Apps Key**  > **FileShare** .
- 2 Select one of images, videos, music or documents category to send.
- 3 Finish sending files by tapping the  button to send selected files to scanned devices.





Use **Menu/Search Key**  to use more of its functions.

Receive data

When prompted, select **OK** to confirm that you are willing to receive data.

Calls



Making a call

- 1 Tap  to open the keypad.
- 2 Enter the number on the keypad. To delete a digit, tap the **Clear** icon .
- 3 Tap the **Call** icon  to make a call.
- 4 To end a call, tap the **End** icon .

TIP

To enter “+” to make international calls, touch and hold .



Calling your contacts

- 1 From the Home screen, tap the **Apps Key**  and then tap **Contacts**  to open your contacts.
- 2 Scroll through the contact list or tap the **Search contacts** box and enter the first letter(s) of the contact you want to call.
- 3 In the list that is displayed, tap the contact you want to call.
- 4 In the Contact Info screen, tap the phone number you wish to call.



Answering and rejecting a call

When the screen is locked

When your phone rings, swipe the **Answer**  icon in any direction to answer the incoming call.

Swipe the **Decline** icon  in any direction to reject an incoming call. Swipe the Quick msg icon  in any direction if you want to send a message to the caller. If the caller is unknown, the **Quick msg** icon is not available.

When the screen is unlocked





When your phone rings, tap the **Answer** icon . Tap **Decline** icon  to reject an incoming call.

Tap the Quick msg Key  if you want to send a message to the caller. If the caller is unknown, the **Quick msg Key** is not available.

Adjusting the in-call volume

To adjust the in-call volume during a call, use the volume up and down keys on the left side of the phone.

Making a second call

- 1 During your initial call, tap the **Menu/Search Key**  and select **Add call**.
- 2 Dial the number or search your contacts.
- 3 Tap the **Call icon**  to connect the call.
- 4 Both calls will be displayed on the call screen. Your initial call will be put on hold.
- 5 Tap the Call entry on the screen to toggle between active calls or tap **Merge call**  to merge the calls.
- 6 To end active calls, tap the **End icon** . If there is no active call, it will end the call on Hold.

NOTE

You will be charged for each call you make.

Ending a Call

Tap the  key to end a call.

NOTE

To redial recent numbers, touch  at the end of the call or find the number within the Logs list, touch the entry and touch **Call**.

If you end the current call screen and return to the Home screen, You will be notified that you are still on an active call by the green phone icon within the Status bar.

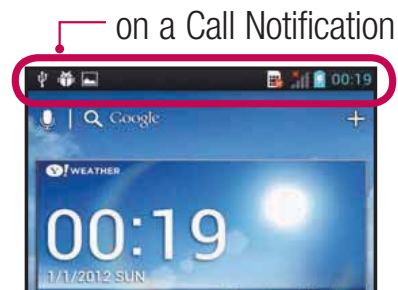

Calls

Ending a Call from the Status Bar

- 1 Tap the Status bar to show the Notifications tab, then drag the tab to the bottom of the screen to open the Notifications panel (1).
- 2 Tap **End** to end the currently active call (2).



Viewing your call logs

From the Home screen, tap the **Call icon**  and the **Call log**  tab.

View a complete list of all dialed, received, and missed voice calls.

TIP

Tap any single call log entry to view the date, time, and duration of the call.

TIP

Tap the **Menu/Search Key** , then tap **Delete all** to delete all the recorded items.

Call settings



You can configure phone call settings, such as call forwarding, and other special features offered by your carrier.

- 1 From the Home screen, tap the **Menu/Search Key**  and tap **System settings**.
- 2 Tap **Call**.
- 3 Set any of the available options.





Contacts

You can add contacts on your phone and synchronize them with the contacts in your Google Account or other accounts that support syncing contacts.

Searching for a contact

- 1 From the Home screen, tap **Apps Key**  and then tap **Contacts**  to open your contacts.
- 2 Tap the **Search contacts** and enter the contact name using the keypad.



Adding a new contact

- 1 Tap **Phone key**  and enter the new contact's number. Tap the **Menu/Search Key** , tap **Add to contacts** and then **Create new contact**.
- 2 If you want to add a picture to the new contact, tap . Choose from **Take photo** or **Select from Gallery**. Then browse for an image and select it.
- 3 Tap  to enter more specific name information.
- 4 Enter the details about your contact.
- 5 Tap **Save** to save the contact entry.



Favourite Contacts

You can classify frequently called contacts as favourites.

To add a contact to your favourites

- 1 From the Home screen, tap **Apps Key**  and then tap **Contacts**  to open your contacts.
- 2 Tap a contact to view its details.
- 3 Tap the star to the right of the contact's name. The star turns gold and the contact is added to your favourites.

To remove a contact from your favourites list

- 1 From the Home screen, tap **Apps Key**  and then tap **Contacts**  to open your contacts.
- 2 Tap the **Groups** tab and tap **favourites**.
- 3 Tap a contact to view its details.
- 4 Tap the gold star to the right of the contact's name. The star turns grey and the contact is removed from your favourites.

Messaging/E-mail



Messaging

Your phone combines SMS and MMS into one intuitive, easy-to-use menu.

Threaded box

Messages (SMS and MMS) exchanged with another party can be displayed in chronological order so that you can conveniently see an overview of your conversation.

Sending a message

- 1 Tap the  icon on the Home screen, then tap  icon on the top right to create a new message.
- 2 Enter a contact name or phone number in the **To** field. As you enter the contact name, matching contacts appear. You can tap a suggested recipient. You can also add multiple contacts.

NOTE

You will be charged for a text message for every person you send the message to.

- 3 Tap the text field to start entering your message.

- 4 Tap the **Menu/Search Key**  to open the options menu. Choose from **Discard**, **Add subject**, **Insert smiley** and **All messages**.

- 5 Tap **Send** to send your message.

- 6 The message screen opens, with your message after recipient name/number. Responses appear on the screen. As you view and send additional messages, a message thread is created.

Warning

The 160-character limit may vary from country to country depending on how the SMS is coded and the language used in the message.

Warning

If an image, video, or audio file is added to an SMS message, it will be automatically converted into an MMS message and you will be charged accordingly.

NOTE

When you get an SMS message during a call, there will be an audible notification.



Using smilies

Liven up your messages using smilies.

When writing a new message, tap the **Menu/Search Key** , then tap **Insert smiley**.

Changing your message settings

Your phone's message settings are predefined, so you can send messages immediately. You can change the settings based on your preferences.

- ▶ From the Home screen, tap **Messaging**  > **Menu/Search Key**  > **Settings**.

E-mail

You can use the **E-mail** application to read E-mail from providers other than Gmail. The E-mail application supports the following account types: POP3, IMAP and Microsoft Exchange ActiveSync (for Enterprise users).

To open the E-mail application

- ▶ From the Home screen, tap **Apps Key**  > **E-mail** .

The first time you open the **E-mail** application, a setup wizard opens to help you add an E-mail account.

Microsoft Exchange E-mail Account

E-mail address – Enter the account email address.

User name – Enter the account username.

Password – Enter the account password.

Domain – Enter the account domain (optional)

Server address – Enter the server address

Use SSL – Choose whether or not to use SSL for Microsoft Exchange.

Messaging/E-mail

Other (POP3, IMAP) E-mail Account

E-mail address – Enter the account email address.

Password – Enter the account password. Setup complete page will appear and you will need to enter “name”. The account will now appear in the list of accounts in your E-mail folder.

Incoming Server Settings

POP3 / IMAP4 – Select protocol type, either POP3 or IMAP4.

Incoming server – Enter the incoming email server address.

Secure type – TLS/SSL/Off.

Port number – Normally each account’s default number will be displayed.

Advanced Server Settings (Outgoing)

Outgoing server – Enter the outgoing email server address.

SMTP secure type – TLS/SSL/Off.

SMTP Port number – Normally each account’s default number will be displayed.

Tap the **Next** button to connect the server.

Setup Completed page will appear. You will

need to enter “name” for account display and My name. Then, tap **Done**.

The account will now appear in the list of accounts in your E-mail folder.

The Accounts Screen

The **Accounts** screen lists your **Combined Inbox** and each of your email accounts.

▶ Tap **Apps Key**  > **E-mail** . The Account list appears.

TIP

To make a shortcut to the Inbox of an account:

In the accounts list, touch and hold an email account. Then, tap **Add to homescreen**.

You can tap an account to view its **Inbox**. The default account from which you send email is indicated with a checkmark.

To open your Combined Inbox

If you have configured email to send and receive email from more than one account, you can view all messages sent to all accounts in your Combined Inbox.

- ▶ Tap **E-mail** > **Combined Inbox** (on the **Accounts** screen).

Messages in the **Combined Inbox** are colour coded on the left, by account, using the same colours used for your accounts in the **Accounts** screen.

When a new email arrives in the inbox, there will be sound and vibration notification. Tap the email notification to end it.

Composing and Sending E-mail

- 1 In the **E-mail** application, tap the **Compose**.
- 2 Enter an address for the message's intended recipient. As you enter text, matching addresses will be offered from your contacts.
- 3 Tap the **Cc/Bcc** field to copy or blind copy to other contacts/email addresses.

- 4 Enter the text of the message.
- 5 Tap **Attach** to attach the file you want to send with your message.
- 6 Tap **Send**.

Touch a message in the **Drafts** folder to resume working on it. Your message will also be saved as a draft if you touch the **Back** key before sending it.

If you are not connected to a network, for example if you're working in airplane mode, the messages you send are stored in your **Outbox** folder until you're connected to a network. If it contains any pending messages, the **Outbox** will be displayed on the **Accounts** screen.

NOTE

The messages sent using an Exchange account will not be stored on the phone; they will be stored on the Exchange server itself. If you want to see your sent messages in the **Sent** folder (or with the **Sent** label), you may need to open the **Sent** folder/label and select **Refresh** from the options menu.

Messaging/E-mail

Working with Account Folders

Each account has **Inbox**, **Outbox**, **Sent**, **Drafts**, **Trash** and **Junk folders**. Depending on the features your account service provider supports, you may have additional folders.

Adding and Editing E-mail Accounts

To add an email account

- 1 Tap **Apps Key**  > **E-mail** .
- 2 Select **Microsoft Exchange** or **Other**.

If an email account is already set up, the wizard is not activated automatically.

In this case, tap the **Menu/Search Key**  > **Add account**.

To change account settings

- 1 Open the **Accounts** screen.
- 2 Tap the **Menu/Search Key**  > **Settings**.

To delete an email account

- 1 Open the **Accounts** screen.
- 2 Touch and hold the account you want to delete.
- 3 Tap **Delete account** in the menu that opens and tap **OK** in the dialogue box to confirm.

Social Networking

With your phone, you can enjoy social networking and manage your micro-blog in on-line communities. You can update your current status, upload photos, and view your friends' status updates in real-time. You can add your Facebook, Twitter accounts to your phone. If you don't have an account, you can visit their sites to set one up.

NOTE

Additional costs may be incurred when connecting and using online services. Check your data charges with your network provider.

Adding an account to your phone

- 1 From the Home screen, tap the **Menu/Search Key**  > **System settings** > **Account & sync**.
- 2 Tap **ADD ACCOUNT**.
- 3 Tap any social networking service you want to use.
- 4 Enter your email address and password that you set up for your social networking account, then tap **Log in**.

Adding a social networking widget on the home screen

If you add a social networking widget on your Home screen, the widget will show your status when your phone receives updates from the network.

You can also access the social community directly by tapping the widget.

- 1 Touch and hold an empty spot on the Home screen.

NOTE

If there is no available space on a particular Home screen panel, you won't be able to add any widget; you must delete or remove an item before you can add another item. In this case, you have the option of switching to another Home screen panel.

- 2 Tap the Widgets tab and scroll to the right until you see Social+.
- 3 Tap Social+ to add it to the Home screen panel.

Social Networking

Viewing and updating your status



- 1 Go to the Home screen panel where the **Social+** widget is. You can see the current status of social applications you set.
- 2 You can select each social application you'd like to view. Tap the arrow (for example,  on the upper left corner of the widget) and tap the social application you'd like to display.
- 3 Tap “**What are you doing?**” field to update your status with comments or upload pictures.
 - Check all the social applications you'd like to update. It will simultaneously update all.
- 4 After entering comments with attachment (if any), tap Post.

TIP

You can use information about friends only in your social network(s) or sync all data to Contacts.

Syncing accounts on your phone

You can sync information from your social networking accounts with your Contacts and other functions on your phone, if applicable.

- 1 From the Home screen, tap the **Menu/Search Key**  > **System settings** > **Accounts & sync**. Choose the account you want to synchronize and enter the necessary information.
- 2 Check **Update data** to sync.
- 3 Tap the account to sync.
- 4 Check sync options such as **Sync Contacts**.
“” indicates that synchronization has been enabled.

Removing accounts on your phone

- 1 From the Home screen, tap the **Menu/Search Key**  > **System settings** > **Accounts & sync**.
- 2 Tap the account(s) you want to delete, then tap **Delete account** (twice).

Camera

To open the Camera application, tap **Apps Key**  > **Camera** .

Getting to know the viewfinder

Brightness – This defines and controls of the amount of sunlight entering the lens. Slide the brightness indicator along the bar, towards “-” for a lower brightness image, or towards “+” for a higher brightness image.

Voice Shutter – Say Cheese when you get ready to take a photo.

Camera Switch - Allows you to switch between the front-facing and back-facing cameras.

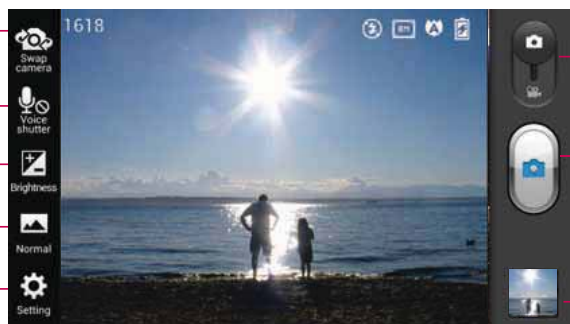

Camera mode – Slide this icon down to switch to video mode.

Capture – Allows you to take a photo.

Gallery – This enables you to access your saved photos and videos within the camera mode. Simply tap and your Gallery will appear on the screen.

Zoom (Volume keys) – Zoom in or zoom out.

Settings – Tap this icon to open the settings menu.

Shot mode – Choose from **Normal**, **Panorama** or **Continuous shot**.

Camera

Taking a photo

- 1 Open the Camera application.
- 2 Hold the phone, point the lens towards the subject you want to photograph.
- 3 Touch the screen and a focus box will appear in the viewfinder screen.
- 4 When the focus box turns green, the camera has focused on your subject.
- 5 Click on the  to capture the image.

NOTE

A shading issue may occur when you take a picture indoors, due to the characteristics of the camera. (Shading means a colour difference between the centre and sides.)

Once you've taken the photo

Your captured photo will appear on the screen if Auto review is set to On.

Share Tap to share the picture via various methods such as **Bluetooth, E-mail, Gmail, Google+, Memo, Messaging, MobileLife Album, Picasa,**

Social+, or any other downloaded applications that is supported.

NOTE

Additional charges may apply when MMS messages are sent while roaming.

Set as Tap to use the image as **Contact photo, Home screen wallpaper, Lock screen wallpaper.**



Tap to delete the image.



Tap to take another photo immediately. Your current photo will be saved.



Tap to view the Gallery of your saved photos.

Using the advanced settings

In the viewfinder, tap  to open the advanced options.

You can change the camera settings by scrolling the list. After selecting the option, tap the **Back key** .

Flash – Turn Off / On / Auto.

Focus – Tap to select the focus mode.

- **Auto** : Allows the camera to focus automatically. (The camera continuously focuses on the objects in the photo)
- **Face tracking** : The camera detects and focuses on human faces automatically.

Image size – Tap to set the size (in pixels) of the picture you take. Select a pixel value from the following options: **5M(2592X1944)**, **3M(2048X1536)**, **W3M(2240X1344)**, **1M(1280X1024)**, **W1M(1280X768)**.

Scene mode – Select the colour and light settings appropriate for the current environment.

- **Normal** : Automatically adjusts according to the environment.
- **Portrait** : It's good to capture people.
- **Landscape** : It's good to capture natural scenery such as trees, flowers and sky.
- **Sunset** : It's good to capture the sunset scenery.

ISO - Control the camera's sensitivity to light. Choose from **Auto**, **400**, **200** and **100**.

White balance – The white balance ensures any the white areas in your picture are realistic. To enable your camera to

adjust the white balance correctly, you may need to determine the light conditions.

Choose from **Auto**, **Incandescent**, **Sunny**, **Fluorescent**, and **Cloudy**.

Colour effect – Choose a colour tone for your new photo.

Timer – The self-timer allows you to set a delay after the shutter is pressed. Select **Off**, **3 sec**, **5 sec** or **10 sec**. This is ideal if you want to be included in a photo.

Geotagging – Activate to use your phone's location-based services. Take pictures wherever you are and tag them with the location. If you upload tagged pictures to a blog that supports geotagging, you can see the pictures displayed on a map.



NOTE

This function is only available when GPS is active.

Camera

NOTE

This function uses wireless networks. You need to checkmark Use wireless networks.

From the Home screen, tap the **Menu/Search Key**  > **System settings** > **Location services**. Check Google's location service .

Shutter sound – Select one of the four shutter sounds.

Auto review – If you set **Auto review on**, it will display the picture that was just taken automatically.

Storage – Choose from SD card, Internal memory.

Reset – Restore all camera default settings.

Camera help guide – Touch whenever you want to know how some function operates. This provides you with a quick guide.

NOTE

- When you exit the camera, some settings will return to their defaults. Check the camera settings before you take your next photo.
- The settings menu is superimposed over the viewfinder, so when you change elements of the image colour or quality, you will see a preview of the image change behind the settings menu.

Viewing your saved photos

You can access your saved photos from within the camera mode. Just tap the Gallery button  and your Gallery will be displayed.

TIP

Flick left or right to view other photos or videos.

Tap a photo to display other options menus.



– Tap to see a Smart Share list of your images (Connecting to other devices show the photos).



– Tap to take a new photo.



– Tap to share the photo via various methods such as Bluetooth, or Messaging.



– Tap to delete the photo.

Menu/Search Key  – Tap to access Set image as, Move, Rename, Rotate left, Rotate right, Crop, Edit, Slideshow, or Details.

Setting a photo as wallpaper

- 1 Tap the photo you want to set as wallpaper to open it.
- 2 Tap the screen to open the options menu.
- 3 Tap **Menu/Search Key**  > **Set image as** > **Home screen wallpaper**.
- 4 Crop the image as desired and tap **OK**.

Video Camera

Getting to know the viewfinder

Brightness – This defines and controls of the amount of sunlight entering the lens. Slide the brightness indicator along the bar, towards “-” for a lower brightness video, or towards “+” for a higher brightness video.

Zoom – Zoom in or zoom out.

Camera Switch - Allows you to switch between the front-facing and back-facing cameras.



Camera mode – Slide this icon up to switch to camera mode.



Start recording – Allows you to start recording.

Gallery – This enables you to access your saved photos and videos from within the video camera mode. Simply tap and your Gallery will appear on the screen.

Settings – Tap this icon to open the settings menu.

Live effect – Live effect provides various visual effects when taking a video.

Recording a video

- 1 From the Home screen, tap **Camera** and tap the **Camera mode** button to change to Video mode. The capture icon will change to .
- 2 The video camera's viewfinder will appear on the screen.
- 3 Holding the phone horizontally, point the lens towards the subject of the video.
- 4 Tap the **Record** icon  once to start recording.
- 5 A timer showing the length of the video is displayed at the top left corner of the screen.
- 6 Tap the **Stop** icon  on the screen to stop recording.

After recording a video

A still image representing your video will appear on the screen if Auto review is set to On.



Play Tap to play the video.

Share Tap to share the picture via various methods such as **Bluetooth, E-mail, Gmail, Google+, Messaging, MobileLife Album, YouTube**, or any other

downloaded applications that is supported.

NOTE

Additional charges may apply when MMS messages are downloaded while roaming.

-  Tap to delete the video you just recorded. Tap **OK** to confirm it. The viewfinder will reappear.
-  Tap to record another video right away. Your current video will be saved.
-  Tap to view the Gallery of your saved videos.

Using the advanced settings

Using the viewfinder, tap  to open the advanced options.

Adjust the video camera settings by scrolling the list. After selecting the option, tap the **Back key** .

Flash – Allows you turn on the flash when recording video in a dark place.

Video Camera

Video size – Tap to set the size (in pixels) of the video you record. Select the video size from Full HD(1920x1080), HD(1280x720), TV(720x480), VGA(640x480), MMS(QVGA-320x240) and MMS(QCIF-176x144).

White balance – The white balance ensures any the white areas in your video are realistic. To enable your camera to adjust the white balance correctly, you may need to determine the light conditions. Choose from **Auto**, **Incandescent**, **Sunny**, **Fluorescent** and **Cloudy**.

Colour effect – Choose a colour tone to use for your new video.

Geotagging – Activate to use your phone's location-based services. Take videos wherever you are and tag them with the location. If you upload tagged videos to a blog that supports Tag location, you can see the videos displayed on a map.

Audio recording – Choose off to record a video without sound.

Auto review – If you turn Auto review on, it will play back the video you just recorded automatically.

Storage – Choose from SD card, Internal memory.

Reset – Restore all video camera default settings.

Video help guide – Touch if you want to know how this function operates. This provides you with a quick guide.

Watching your saved videos

- 1 In the viewfinder, tap .
- 2 Your Gallery will appear on the screen.
- 3 Tap a video to play it automatically.

Adjusting the volume when viewing a video

To adjust the volume of a video while it is playing, use the Volume Keys on the left side of the phone.

Multimedia

You can store multimedia files to a micro SD card to have easy access to all your image and video files.

Gallery

Tap **Apps Key**  > **Gallery** .

View mode

When you open the Gallery, your photos will be presented in Folder view. Once you open a folder, your photos will be in Grid view. When you tap a photo from Grid view, it will be displayed in Full view.

Calendar View

In Folder view, tap  **Albums** to view **Albums, Locations, Timestamp**.

Gallery menu options

Tap a photo and tap the **Menu/Search Key**  to see the following available options: **Set image as, Move, Rename, Rotate left, Rotate right, Crop, Edit, Slideshow, Details**.

Sending a photo

- 1 To send a photo, touch the photo you want.
- 2 Tap  and choose from **any of the available applications**.
- 3 When you choose **E-mail, Gmail** or **Messaging**, your photo will be attached to a message, which you can then write and send normally.

TIP

If you have a social networking account set up on your phone, you can share your photo with that social networking community.

Sending a video

- 1 To send a video, touch and hold the video you want.
- 2 Tap **Share** and choose from **any of the available applications**.
- 3 When you choose **E-mail, Gmail** or **Messaging** your video will be attached to a message, which you can then write and send normally.

Multimedia

Using an image

Choose images to use as wallpaper or identify callers.

- 1 Touch a photo then tap **Menu/Search Key**  > **Set image as**.
- 2 Choose from **Contact photo**, **Home screen wallpaper** and **Lock screen wallpaper**.

Viewing a slideshow

To view a slideshow of your photos, open the Gallery and tap a photo. Once the photo is displayed, tap the screen to see the menu. Tap **Menu/Search Key**  > **Slideshow** to begin the slideshow of all your photos.

View photo details

You can view a photo's detailed information, such as the name, date, time, size, and type.

While viewing a photo, tap **Menu/Search Key**  > **Details**.

Transferring files using USB Media sync (MTP)

To transfer files using a USB device:

- 1 Connect the phone to a PC using a USB cable.
- 2 You can see USB connection mode popup. (From the Home screen, tap the **Menu/Search Key**  and tap **System settings** > **Connectivity** > **USB connection type** > **Media sync (MTP)**).
- 3 Tap **Media sync** to confirm.
- 4 You can view the phone content on your PC and transfer the files.

NOTE

If you don't want to see USB connection mode popup, uncheck **Don't ask again on USB connection mode popup** or turn off **ask on connection**. (**Menu/Search Key**  and tap **System settings** > **Connectivity settings** > **Ask on connection**).

Music Player

Your phone has a music player that lets you play all your favourite tracks. To access the music player from the Home screen, tap **Apps Key**  and tap **Music Player**.

How to save music/video files to the phone

Connect your phone to the PC using the USB cable

You'll receive a notification that the USB is connected and can see USB connection mode popup. Tap Media sync (MTP) to confirm. Then open the folder you wish to view from your computer.

Save music or video files from the PC to the phone's removable storage

- You may copy or move files from the PC to the phone's removable storage using a card reader.
- If there is a video file with a subtitle file (.smi file with the same name as the video file), place them in the same folder

to display the subtitle automatically when playing the video file.





- When downloading music or video files, copyright must be secured. Please note that a corrupted file or file with a wrong extension may cause damage to the phone.

How to play video files on the phone

Playing video files

Locate the file you want in the Gallery and tap it to play it.

Playing a song

- 1 From the Home screen, tap **Apps Key**  and tap **Music Player**.
- 2 Tap the **Songs** tab.
- 3 Tap the song you want to play.
- 4 Tap  to pause the song.
- 5 Tap  to skip to the next song.
- 6 Tap  to go back to the beginning of the song. Tap  twice to go back to the previous song.

Multimedia

To change the volume while listening to music, press the up and down Volume Keys on the left side of the phone.

To display the options for a song, touch and hold any song in the list. You will see the following options: **Play**, **Add to playlist**, **Set as ringtone**, **Delete**, **Share**, **Search** and **Details**.

Working with Playlists

You can create playlists to organize your music files into sets of songs, which you can play in the order you set or in a shuffle.

To create a playlist

- 1 When viewing the library tap the **Playlists** tab.
- 2 Tap **Add to playlist**.
- 3 Tap **New playlist**.
- 4 Enter a name for the playlist, then tap **Save**. The new playlist is added to the **Playlists** library.

You can also add the song that is playing in the Playback screen as the first song in a playlist by pressing the **Menu/Search Key** , then tapping **Add to playlist** or

tapping **Save as playlist** to save all the songs in an album that you're playing as a playlist.

To remove a song from a playlist

- 1 Open a playlist.
- 2 Touch and hold the song you want to remove, then tap **Remove from playlist** or when viewing the currently playing playlist, tap the **Menu/Search Key** , then tap **Remove from playlist** to remove all the songs from the current playlist.

To rename or delete a playlist

- 1 Open the **Playlist** library.
- 2 Touch and hold the playlist to display the menu, then tap **Delete** or **Rename**.

Google Applications



About Google applications

Google applications, including mobile versions of Gmail, Google Talk, Google Calendar, and Google Maps, are loaded on your phone.

- 1 To set up a Google account, tap any Google application, enter your user name and password and sign in.
- 2 After signing in, your contacts, email, and calendar in your Google account will automatically synchronize with your phone.

Google Maps™

To open Google Maps and view your location

- 1 From the Home screen, tap **Apps Key**  and tap **Maps**.
- 2 Tap the **My location** icon  on the map. The map centers on a blue dot that indicates your location. A blue circle around the dot indicates that your actual location is within the circle.

To get an address and additional information for a location

- ▶ Touch and hold a location on the map. A balloon with the address and a thumbnail from Street View (if available) opens over the location.
- ▶ Tap the balloon to access additional options.



To view map, satellite, or traffic layers

- ▶ Tap the **Layers** icon  on the map and select a layer option. You can choose from Traffic, Satellite, Terrain, Latitude and others.

Searching For Locations and Places

You can search for a location and view it on a map. You can also search for places on the map that you're viewing.

To search for a location



- 1 While viewing a map, tap  at the bottom of the screen. You can also touch and hold the **Menu/Search Key** .
- 2 In the search box, enter the place you're looking for. You can enter an address, a city, or a type of business or establishment. For example, "theater in New York".
- 3 Tap the **Search** icon . Markers with letter labels indicate search matches on the map.

NOTE

Location information might be inaccurate if GPS and Wi-Fi is turned off. Please make sure that GPS and Wi-Fi is turned on.

Getting Directions

To get directions

- 1 While viewing a map, tap .
- 2 Enter a starting point in the top text box and your destination in the bottom text box. To reverse directions, tap the **Menu/Search Key**  and tap **Reverse Start & End**.

- 3 Tap the icon for car, public transit, bicycling, or walking directions.
- 4 Tap **Get directions**. The directions to your destination appear in a list.

To view turn-by-turn directions in a list

You can view each turn in your route as a list of written directions.

When viewing a list of directions, tap the **Navigation** icon  to view turn-by-turn directions in Navigation View.

To search for locations along your route

You can search for businesses, points of interest, and other features along your route. When you search while navigating, your results include locations along your route, rather than locations that are near your current location.

- ▶ Touch and hold the **Menu/Search Key**  and search for locations of interest. The results are displayed as markers along your route; the first result is labeled. You can tap a label for more information about the marker.

Google Applications

► When you're finished, tap the **Navigation** icon  to return to Navigation View.

Places

Places bookmarks your favourite places, such as addresses or local businesses, to be able to find them quickly later.

To view My Places

While viewing a map, tap .

Clear Map

Clear any information, such as routes and search results, from the map.

To clear a map

While viewing a map, tap the **Menu/Search Key**  and tap **Clear Map**.

Latitude

Finding Your Friends with Google Latitude™

Google Latitude lets you and your friends view each others' locations on maps and get directions to your friends' locations using Google Latitude. Your location is not shared automatically. It is by invitation only. You must join Latitude and then invite your friends to view your location or accept invitations from your friends.

To join Latitude

► While viewing a map, tap  and tap **Join Latitude**.

The first time you join Latitude, you're prompted to accept or reject the Google privacy policy. After you've joined Latitude, the Join Latitude option changes to **Latitude**.

To open Latitude

After you join Latitude, you can open it to find your friends and view their updates.

► While viewing a map, tap  and tap **Join Latitude**.

To invite friends to share their locations

After you join Latitude, you can start sharing your location with your friends. Only friends whom you have explicitly invited or accepted can see your location.

- 1 Open **Latitude** and tap .
- 2 Tap **Select from Contacts** or **Add via email address** in the menu that opens.
- 3 Tap **Add friends** at the bottom of the screen. If your friends already use Latitude, they receive an email request and a notification on Latitude. If they have not yet joined Latitude, they receive an email inviting them to sign in to Latitude with their Google Account.

Places

To find places

Tap the **Places** icon  while in Google Maps to find different venues, such as gas stations, coffee shops, bars, restaurants, etc.

Once you select a category, you will see a list of closest matches, including their distance, compass bearing, description and even user reviews. You can customize your own location search categories, and even add the Places icon to your Home screen.

Tip

While viewing a map, tap the **Menu/Search Key**  for the following options: **Clear map, Search, Directions, Layers, Settings** and **Help**.

Play Store™

Play Store™ lets you browse through and download thousands of fun and useful applications and games. You can check other users' comment regarding an application or you can post your own comments. If you install applications and games from Play Store™, they appear in the phone's menu below the preloaded applications, and you can find them by scrolling down with your finger. You can open downloaded applications from the Play Store by tapping the **Menu/Search Key**  > **My apps**.

To download applications and games

- 1 From the Play Store home page, tap a category near the top of the screen.
- 2 Scroll to view subcategories and tap the one you want to explore.
- 3 Tap an application to open its details screen, or further sort the subcategory by tapping Top paid, Top free, Top Grossing, Top New paid, Top New Free, Trending.
- 4 Tap the application you desire to install. The descriptions and the prices of the application will be displayed.

Google Applications

5 Tap the **price** button at the top right of the screen for paid applications. For free applications, tap the **FREE** button. The applications will then be downloaded and installed.

NOTE



To purchase a paid app, you'll need to set up a payment method with Google Checkout™. You have the option to use a credit card or charge to your carrier bill.

NOTE

When you want to exit a game or application, use the Home or Back Key, which will return you to the Home screen. Or select Menu (or Options) within the game or application and select Exit. (Exit option may vary by game/application). Ending applications that continue to run in the background (after going back to the Home screen) will help conserve battery life and reduce unwanted data usage.

Gmail™

Gmail™ can be configured when you first set up your phone. Depending on your synchronization settings, Gmail™ on your phone is automatically synchronized with your Gmail™ account on the web. The inbox conversations list is your default Gmail™ view.

Tap the **Menu/Search Key** , then tap  to send or receive new email and to synchronize your email with your Gmail™ account on the web. Tap the **Menu/Search Key**  for the following additional options: **Label settings**, **Settings**, **Help**, and **Send feedback**.

Compose  - Allows you to compose a new message.

Search  - Allows you to search your account.

Labels  - Allows you to view the account's labels.



Refresh  - Allows you to refresh the account to view new activity.

Utilities

Setting the alarm

- 1 From the Home screen, tap **Apps Key**  and tap **Alarm/Clock** .
- 2 To add a new alarm, tap the  at the bottom left and set the alarm time.
- 3 Set any other desired options and tap **Save**.
- 4 Tap the **Menu/Search Key**  to delete all alarms or adjust the alarm settings.



Using the calculator

- 1 From the Home screen, tap **Apps Key**  and tap **Calculator** .
- 2 Tap the number keys to enter numbers.
- 3 For simple calculations, tap the function you want (+, -, x, or ÷), followed by =.
- 4 For more complex calculations, tap the **Menu/Search Key** , tap the **Advanced panel**, then choose an option.

Adding an event to your calendar

NOTE

You must create a Google account to use Calendar.

- 1 From the Home screen, tap **Apps Key**  and tap **Calendar** .
- 2 To view an event, tap the date. The events occurring on that date are displayed below the Calendar in Month view. Tap the event to view its details. If you want to add an event, tap  at the top right corner of the Calendar.
- 3 Tap the **Phone** field and enter the event name. Check the date and enter the start and end time you want your event to begin and finish.
- 4 Tap the **Location** field to enter the location.
- 5 To add a note to your event, tap the **Description** field and enter the details.
- 6 To repeat the event, set **Repetition**, and set **Reminders**, if necessary.
- 7 Tap **Save** to save the event in the calendar. A coloured square in the calendar will mark all days that have saved events. An alarm will sound at the event start time if you set it.



Utilities

Changing your calendar view

- 1 From the Home screen, tap **Apps Key**  and tap **Calendar** .
- 2 At the top left of the Calendar, tap  which shows the **Day**, **Week**, **Agenda** or **Month**.



Downloads

Allows fast access to tabs containing a list of your recent internet and other downloaded files.

- 1 From the Home screen, tap **Apps Key**  → **Downloads** .
- 2 Touch an available file category tab (Internet downloads or Other downloads) then select the needed file. Polaris Office can also open compatible format documents.

File Manager

Enables you to manage in one location your sounds, images, videos, bluetooth files, Android files, and other memory card data. This application enables you to open associated file types if already on your phone such as MP4.

- From the Home screen, tap **Apps Key**  → **Files** .

FM Radio

Your LG-P768g has a built-in FM Radio so you can tune in to your favourite stations and listen on the go.

NOTE



You need to use your headset to listen to the radio. Insert them into the headset jack.

LG Tag+

What is LG Tag+

LG Tag+ allows easy saving and loading to NFC(Near Field Communication) tag, which can be customized to suit certain environments.

Using Tag+ writing

- 1 From the Home screen, tap **Apps Key**  → **LG Tag+** .
- 2 Select the desired mode (**Car/Office/Sleep/User mode**) and tap **Write on NFC tag**.
- 3 Touch the back of your device to a tag, then launching application and changing settings can be set.

Using Tag+ reading

When touching the set tag, mode will be activated right away.



LG Tag+ Example





Utilities

Polaris Office

With Polaris Office, you can view, create and edit document files on your device. The loaded files can be from micro SD cards of your device, or from downloaded email attachments. The Polaris Office application supports the following file formats: txt, doc, docx, xls, xlsx, ppt, pptx, pdf.

- 1 From the Home screen, tap **Apps Key**  > **Polaris Office** .
- 2 Register your name and email address on the User Registration page. If you want to skip the registration process, tap **Later**.
- 3 Tap **My Files** for folders and documents on your micro SD card.
- 4 Tap the **Menu/Search Key**  > **New File** to start a new document.
- 5 Tap a document type.
- 6 Enter contents in the document using the tools at the bottom of the screen and the on-screen keyboard.
- 7 When you're done working on the document, tap the **Menu/Search Key**  > **Save** > **Save** (or **Save as** to enter a new document name) to save.
- 8 Tap the **Back Key**  to exit.



View and edit a document on your device

- 1 From the Home screen, tap **Apps Key**  > **Polaris Office** .
- 2 Tap **My Folders** for folders and documents on your micro SD card.
- 3 Move to the folder that contains the file that you want to open if it is not in the root directory.
- 4 Tap the document that you want to view or edit.

NOTE

You can also open an attachment in an email by tapping the attachment in the message.

- 5 The document opens for you to view. If you want to edit it, Tap the **Menu/Search Key**  then select **Edit Mode**.
 - ▶ To move between pages or pan through the document, scroll in the corresponding direction.

- ▶ To change the zoom level, tap the **Menu/Search Key**  > **Zoom**, then tap the zoom level you want or simply pinch-to zoom to achieve the zoom level you want.
 - ▶ Use the toolbar at the bottom of the screen to edit the document (Word, Excel, or PowerPoint file).
 - ▶ Tap the **Menu/Search Key**  for additional menu options such as **Save**, **Read mode**, **View**, **Insert**, **Format**, **Customize toolbar**, **Brightness**, and **Settings**.
- 6 When you're finished editing, tap Save. Then, tap the **Back Key**  to exit.



Polaris Office document tools

The Polaris Office application has a toolbar that appears automatically when you create a document.

- 1 To display the toolbar in an existing document, Tap the **Menu/Search Key**  then select **Edit Mode**.
- 2 Tap a toolbar icon and the corresponding tool options will be displayed in a pop-up balloon for you to tap and use.

- 3 To hide the tool options pop-up balloon, tap the toolbar icon again. Left and right arrows on the toolbar indicate that you can scroll horizontally for more icons. The tools in the toolbar vary depending on the document type.

Manage documents online

- 1 From the Home screen, tap **Apps Key**  > **Polaris Office** .
- 2 Tap **Add account** > **Box.net** for access to your online account.
- 3 Enter your Email account and password to access your account then tap **Add**.
- 4 View and manage your documents on the server as desired.

LG SmartWorld

LG SmartWorld offers an assortment of exciting content - games, applications, wallpaper and ringtones - giving LG phone users the chance to enjoy richer “Mobile Life” experiences.



How to Get to LG SmartWorld from Your Phone

- 1 From the Home screen, tap **Apps Key**  > **LG SmartWorld** .
- 2 Tap Sign in and enter ID/PW for LG SmartWorld. If you have not yet signed up, tap Register and get a LG SmartWorld membership.
- 3 Download the content you want.

NOTE: What if there is no icon?

- 1 Using a mobile Web browser, access LG SmartWorld (www.lgworld.com) and select your country.
- 2 Download LG SmartWorld App.
- 3 Execute and install the downloaded file.
- 4 Access LG SmartWorld by tapping the  icon.

How to use LG SmartWorld

- Participate in monthly LG SmartWorld promotions.
 -  – Search Content.
 -  – Find contents by category(e.g. Games, Education, Entertainment etc).
 -  – List of downloaded/to-be updated contents.
- Try the easy “Menu” buttons to find what you’re looking for fast.
 - Apps for you** – Recommended content based on your previous choices.
 - Settings** – Set Profile and Display.
 - Sign in** – Set your ID and Password.
- Try other useful functions as well. (Content Detail screen)

NOTE

LG SmartWorld may not be available in all carriers or countries.

Task Manager

You can manage your programs with Task Manager.

- 1 You are allowed to see the currently using applications by tapping on the **Running** tab. The applications with high consumption of resource will have descriptions in red. Tap **stop** icon to terminate the applications.
- 2 You are allowed to see the installed applications by tapping on the **Installed** tab.
- 3 You are allowed to see the capacity of System memory and SD card by tapping the **Storage** tab.
- 4 You can place the Task Manager widget on the homescreen.

Video Player

The built-in Video Player application plays videos directly from files on your SD card. This application is able to playback DivX videos.





- 1 From the Home screen, tap **Apps Key**  → **Video Player** . A list of sorted videos on the SD card will be shown in the Video list.

- 2 Tap a video file to begin watching.

Voice recorder

Use the voice recorder to record voice memos or other audio files.

Recording a sound or voice

- 1 From the Home screen, tap **Apps Key**  and tap **Voice Recorder**.
- 2 Tap  to begin recording.
- 3 Tap  to pause recording.
- 4 Tap  to end recording.

NOTE

Tap  to access your voice recordings. You can listen to the saved recordings.



Sending the voice recording

- 1 Once you have finished recording, you can send the audio clip. Tap **Share** .
- 2 Choose from **Bluetooth**, **E-mail**, **Gmail**, **Memo** and **Messaging**. When you select **E-mail**, **Gmail** or **Messaging** the voice recording will be added to a message that you can write and send normally.

Utilities

YouTube

YouTube is an online public communications website that allows users to upload and have available for the public their videos for viewing. Users can share videos and view them in MPEG-4 format.

- 1** From the Home screen, tap **Apps Key**  → **YouTube** .
 - 2** Tap **Accept** if you accept the Terms and Conditions, or tap **Exit**.
 - 3** When the screen loads you can start searching and viewing posted videos.
 - 4** Press  → **Settings** → **General** → **High quality on mobile** if you prefer a higher quality output.
-

The Web

Browser

The Browser gives you a fast, full-colour world of games, music, news, sports, entertainment, and much more, right on your mobile phone.



NOTE

Additional charges apply when connecting to these services and downloading content. Check data charges with your network provider.

< Tool bar >

The icons bar on the screen below makes it easier to use the browser.

The browser that allows you to look at webpages similarly to how you would on a computer.

-  **Back** – Moves to the previous web page.
-  **Forward** – Used in conjunction with the Back Key. This allows you to go back and forth between web pages without opening multiple windows.
-  **Zoom** - Use to zoom in and out. To utilize this feature, touch and hold the Zoom icon and tilt the phone up to zoom in or down to zoom out.

 **New tab** – Opens a new tab.

 **Bookmarks** - Allows you to view, add, edit, and delete your bookmarks.

Using options

Tap the **Menu/Search Key**  to view the following options:

Refresh - Allows you to reload the current web page.

Save to bookmarks - Allows you to bookmark the current web page.

Go to Homepage - Allows you to open the home page.

Share page - Allows you send the web address (URL) of the web page to others.

Find on page - Allows you to search for text on the web page.

Request desktop site - Allows you to change the current mobile page to a desktop page.

Save for offline reading - Allows you to save the current page for offline reading.

Brightness - Allows you to adjust the brightness.

Settings - Opens the Browser settings.

Exit - Allows you to exit the browser.

The Web

TIP

To return to the previous web page, tap the **Back key** .

Adding bookmarks

- 1 Tap  next to the URL field.
 - From **Thumbnail view**, tap **Add**, enter a name and URL, and tap **OK**.
 - From **List view**, tap **Add bookmark**, enter a name and URL, and tap **OK**.

Changing the Browser settings





Tap  and set any desired options.

On-Screen Phone

LG SOFTWARE

On-Screen Phone allows you to view your mobile phone screen from a PC via a USB or Bluetooth. You can also control your mobile phone from your PC, using the mouse or keyboard.

On-Screen Phone 2.0 icons

-  Launches LG Home Panorama or changes the On-Screen Phone preferences.
-  Connects your mobile phone to your PC, or disconnects it.
-  Minimizes the On-Screen Phone window.
-  Maximizes the On-Screen Phone window.
-  Exits the On-Screen Phone program.

On-Screen Phone features

- **Real-time transfer and control:** displays and controls your mobile phone screen when connected to your PC.
- **Mouse control:** allows you to control your mobile phone by using the mouse to click and drag on your PC screen.
- **Text input with keyboard:** allows you to

compose a text message or note using your computer keyboard.

- **File transfer (mobile phone to PC):** sends a file from your mobile phone (e.g. Gallery, Video Player, Music and Polaris Office) to your PC. Simply right-click on the file and drag it to send it to your PC.
- **File transfer (PC to mobile phone):** sends files from your PC to your mobile phone. Just select the files you wish to transfer and drag and drop them into the On-Screen Phone window. The sent files are stored in the OSP folder.
- **LG Home Panorama:** shows all of the work spaces of LG Home. You can easily organize icons or widgets and run an application by double-clicking the shortcut.

NOTE

Please make sure that LG Home is the default launcher. Some widgets may not work properly on the LG Home Panorama.

- **Real-time event notifications:** prompts a pop-up to inform you of any incoming calls or text messages, as well as alarm and event notifications.

On-Screen Phone

How to install On-Screen Phone on your PC

Visit **LG.com** (<http://www.lg.com/us>).

Locate the search box in the upper right corner and enter the model number. From the **SUPPORT** list, select your model. Scroll down and select the **OSP** tab and click on **DOWNLOAD**. When prompted, select **Run** to install On-Screen Phone on your PC.

How to connect your mobile phone to your PC

On-Screen Phone 2.0 provides USB, Bluetooth and Wi-Fi connection. Please follow the instruction on Connection Wizard of OSP program.

NOTE

Please make sure that On-Screen Phone check box in **System settings > Connectivity > On-Screen Phone > On-Screen Phone** is selected. Please make sure that the battery may run out more quickly due to the current consumption if On-Screen Phone is connected via Wi-Fi.

When you connect your mobile phone to

your PC via Mobile Hotspot and access to the Internet on the PC, additional data charges may be incurred depending on your DataPro data plan.

Access to the Internet using Wi-Fi networks may not work well depending on the network's traffic. When you enlarge the On-Screen Phone window, the display on the screen might become slow.

To check the phone-to-PC connection

Once the devices have been connected, drag down the Status Bar at the top of the Home screen to check the On-Screen Phone connection status.

To disconnect your phone from your PC

Click  in the top left of the On-Screen Phone window. Alternatively, drag down the Status Bar at the top of the Home screen and select **On-Screen Phone connected > Disconnect On-Screen Phone**. Tap **Disconnect** in the disconnect dialog.

Developer options

USB debugging - Checkmark to set Debug mode when USB is connected.

Development device ID - Displays the development device ID.

Stay awake - If activated, the screen will

never sleep while charging.

Allow mock locations - Checkmark to allow mock locations.

Desktop backup password - Allows you to set a desktop backup password.

USER INTERFACE

Enable strict mode - Checkmark to flash the screen when apps operate for a long time on the main thread.

Show touch data - Checkmark to make touch data visible on the screen.

Show touches - Checkmark to show visual feedback when the screen is touched.

Show screen updates - Checkmark to flash areas of the screen when they update.

Show CPU usage - Checkmark to display a screen overlay showing current CPU usage.

Force GPU rendering - Checkmark to use 2D hardware acceleration in applications.

Window animation scale - Select to set the window animation scale.

Transition animation scale - Select to set transition animation scale.

APPS

Don't keep activities - Checkmark to quit every activity as soon as the user leaves it.

Background process limit - Set the preferred Background process limit.

Show all ANRs Checkmark to show App Not Responding dialog for background apps.



About phone

View legal information, check phone status and software versions, and perform the software update.

Settings

The Settings application contains most of the tools for customizing and configuring your phone. All of the settings in the Settings application are described in this section.

To open the Settings application

- From the Home screen, tap the **Apps Key**  > **Settings** .
- From the Home screen, tap the **Menu/Search Key**  > **System settings**.

WIRELESS & NETWORKS

This menu allows you to manage Wi-Fi and Bluetooth connections, portable hotspot and data tethering, airplane mode and VPN connections.



Wi-Fi

To use Wi-Fi on your phone, you need access to a wireless access point, or “hotspot.” Some access points are open and you can simply connect to them. Others are hidden or implement other security features, so you must configure your phone in order to connect to them.

Turn on Wi-Fi



From the Home Screen , open the Notifications panel and tap  to turn Wi-Fi on. A blue colored icon indicates that Wi-Fi is on.

OR

Tap the **Menu/Search Key**  and tap **System settings** > **Wi-Fi**. Then drag  to the right.

To connect to a Wi-Fi Network

Turn off Wi-Fi when you’re not using it to extend the life of your battery.

- 1 From the Home screen, tap the **Menu/Search Key**  and tap **System settings** > **Wi-Fi**.
- 2 Drag  to the right to turn it on and begin scanning for available Wi-Fi networks.
 - A list of available Wi-Fi networks will be displayed. Secured networks are indicated by a lock icon.
- 3 Tap a network to connect to it.
 - If the network is secured, you are prompted to enter a password or other credentials. (Ask your network administrator for details).

- 4 The Status Bar at the top of your screen will display an icon that indicates your Wi-Fi status.

TIP

If you are not in range of a Wi-Fi network and use a network connection. Additional data charges may apply.

NOTE

This device supports WEP, WPA/WPA2-PSK and 802.1x EAP. (Some EAP methods are not supported.) If your Wi-Fi service provider or network administrator sets encryption for network security, enter the key in the pop-up window. If encryption is not set, this pop-up window will not be shown. You can obtain the key from your Wi-Fi service provider or network administrator.

Bluetooth

Using Bluetooth

- 1 From the **WIRELESS & NETWORKS** section, tap Bluetooth, then drag  to the right to turn on the Bluetooth functionality.
- 2 Tap **Search for devices** at the bottom of the screen.
- 3 Tap the name of the device you wish to pair with, and then tap **Pair** to pair and connect.



TIP

Please consult documentation included with Bluetooth device for information on pairing mode and passcode (typically 0 0 0 0 – four zeroes).

Settings

How to send data from your phone via Bluetooth



You can send data via Bluetooth by running a corresponding application, not from Bluetooth menu.

- * **Sending pictures:** Open the **Gallery** application and tap a picture. Then tap  > **Bluetooth**. Check if Bluetooth is turned on and tap **Search for devices**. Then tap the device you want to send data to from the list.
- * **Sending contacts:** Open the **Contacts** application. Tap the contact you want to share, then tap the **Menu/Search Key**  > **Share** > **Bluetooth**. Check if Bluetooth is turned on and tap **Search for devices**. Then tap the device you want to send data to from the list.
- * **Sending multi-selected contacts:** Open the **Contacts** application. To select more than one contact, tap the **Menu/Search Key**  > **Share**. Tap the contacts you want to send or tap **Select all at the top left corner of the screen**. Tap **Done** > **Bluetooth**. Check if Bluetooth is turned on and tap **Search for devices**. Then tap the device you want to send data to from the list.

- * **Connecting to FTP (Only the FTP server is supported on this handset):** From the Home screen, tap the **Menu/Search Key**  > **System settings** > **Bluetooth**. Make sure Bluetooth is turned on. Tap **Make phone visible** to make the device visible to other Bluetooth devices. Then search for other devices. Find the service you want and connect to the FTP server.

TIP

The supported Bluetooth version is Bluetooth 3.0 and certified by Bluetooth SIG. It is compatible with other Bluetooth SIG certified devices.

- If you want to search for this phone from other devices, from the Home screen, tap the **Menu/Search Key**  > **System settings** > **Bluetooth**. Make sure Bluetooth is turned on. Tap **Make phone visible** to make the device visible to other Bluetooth devices. Being visible for 2 minutes is set by default.
- To change the visibility time length, tap the **Menu/Search Key**  > **Visibility timeout**. Choose from 2 minutes, 5 minutes, 1 hour, or Never time out.

- Supported profiles are HFP/HSP, A2DP, AVRCP, OPP, FTP(Server) and PBAP.

Data usage

You can check the current data usage, set to enable/disable mobile data, or set the mobile data limit.

Mobile data - Slide the button to the right to enable mobile data.

Set mobile data limit - Checkmark to set mobile data limit.

Call

You can set **Fixed dialing numbers**, **Voicemail** and **Other call settings** including **Call reject**, **Quick messages**, **TTY mode**, **Hearing aids**, **Call forwarding**, **Wi-Fi Calling**, **Call duration** and **Additional settings**.

More...

Airplane mode

Airplane mode allows you to quickly turn off all wireless connections.

- 1 From the **Wireless & networks** screen, tap More then turn Airplane mode on in the checkbox.(a blue checkmark will appear).
- 2 Tap again to turn it off.

OR

- 1 Press and hold the **Power/Lock Key** and tap **Airplane**.
- 2 Press and hold the **Power/Lock Key** and tap **Airplane** again to turn it off.

Wi-Fi Direct

Tick the check box to make Wi-Fi Direct active. Set Wi-Fi Direct device name and scan for other devices.

Wi-Fi Calling

Important!

Wi-Fi Calling requires that you use the SIM card that is shipped with your phone.

Also, you must register your address for 9-1-1. Wi-Fi Calling will not work until you have registered for 9-1-1 by logging into your account at **www.T-Mobile.com**. Go to your profile and click **Customer Info** and continue on to enter your address.

Settings

About Wi-Fi Calling

Wi-Fi Calling can improve your coverage and allows you to make phone calls and send messages over a Wi-Fi network (when a Wi-Fi network is available).

Unless your rate plan provides otherwise, Wi-Fi Calling minutes count the same as T-Mobile cellular calling minutes on your phone bill.

- To use Wi-Fi Calling, you must first turn on Wi-Fi, connect to a Wi-Fi network, and then turn on Wi-Fi Calling.
- When the Wi-Fi Calling feature is on, your phone displays the **Wi-Fi Calling** icon on the **Status** bar.
- To stay on a Wi-Fi call, you must remain within range of the Wi-Fi network. Your call will drop as you leave the Wi-Fi range. When your Wi-Fi signal weakens, your phone will beep and display a warning message alerting you that your call will drop if the signal gets weaker.

Wi-Fi Calling offers three connection options:

- **Wi-Fi Preferred:** All calls are made over an available Wi-Fi network. If there are no available Wi-Fi networks calls are made over the cellular network.
- **Cellular Preferred:** All calls are made over the cellular network unless the cellular network is not available, then calls are made over an available Wi-Fi network.
- **Wi-Fi Only:** All calls are made over an available Wi-Fi network. If there are no available Wi-Fi networks, your calls will not connect.

Turn on Wi-Fi Calling

NOTE

Wi-Fi must be turned on before Wi-Fi Calling can be turned on.

1. From any Home screen, tap the **Menu**  key.
2. Tap **Settings**.
3. Tap **More....**
4. Tap to select or clear the **Wi-Fi Calling** check box to turn it on or off.

When you see the **Wi-Fi Calling** icon on your **Status** bar, you are ready to make phone calls and send messages over the Wi-Fi network.

If you choose to turn off Wi-Fi Calling, you can still stay connected to Wi-Fi for data usage.

Set connection preferences

NOTE

Wi-Fi Calling must be turned on to change connection preferences.

1. From any Home screen, tap the **Menu**  key.
2. Tap **Settings**.
3. Tap **More...**
4. Tap to select the **Wi-Fi Calling** icon to turn it on, if necessary.
5. Tap **Wi-Fi Calling Settings**.
6. Tap **Connection Preferences**.
7. Tap **Wi-Fi Preferred**, **Wi-Fi Only**, or **Cellular Preferred**.
8. Tap **OK**.

Portable Wi-Fi hotspot

You can also use your phone to provide a mobile broadband connection for up to 8 other devices. Create a hotspot and share your connection.

To create a portable hotspot, from the Home screen tap the **Menu/Search Key**  > **System settings**. From the **WIRELESS & NETWORKS** section, tap **More** > **Portable Wi-Fi hotspot**. Then tap **Portable Wi-Fi hotspot** once more to activate the feature. A checkmark indicates that the feature is active. Tap **Configure Wi-Fi hotspot** to change the **SSID, security type, and password**.

Settings

NOTE

Mobile Hotspots requires an appropriate DataPro data plan. Devices connected to your Mobile Hotspot use data from your DataPro plan. Plans are not unlimited and significant charges may be incurred if the included data allowance is exceeded. Performance may vary depending on the number of devices connected and other factors. If you do not use a password, others will be able to use your Mobile Hotspot connection.

Data Tethering

You can use your phone to provide a data connection to a computer by activating data tethering and connecting them with a USB cable.

To tether your phone with your computer using the USB

- 1 Connect your phone to your computer with a USB cable.
- 2 The USB connection type prompt is displayed. Tap **USB tethering** to confirm.

NOTE

- Data Tethering requires an appropriate DataPro data plan. Devices connected by tethering use data from your DataPro plan. Plans are not unlimited and significant charges may be incurred if the included data allowance is exceeded. Performance may vary depending on the number of devices connected and other factors.
- You cannot access your phone's microSD card on your computer when using USB tethering.

VPN

Displays the list of Virtual Private Networks (VPNs) that you've previously configured. Allows you to add different types of VPN.

Mobile networks

Set options for data roaming, network mode & operators, access point names (APNs) and so on.

DEVICE

Sound

Adjust sound, notification default settings and vibrate mode. You can also manage audible and Haptic feedback.

Sound profile - Allows you to set the sound profile to Sound, Vibrate only, or Silent.

Volumes - Adjust the phone's volume settings to suit your needs and your environment.

RINGTONE & NOTIFICATIONS

Phone ringtone - Select the ringtone for incoming calls.

Notification sound - Select the ringtone for notifications such as new messages receipt or calendar events.

Ringtone with vibration - Checkmark for vibration feedback for calls and notifications.

Quiet time - Slide the button to set times to turn off all sounds except alarm and media.

TOUCH FEEDBACK & SYSTEM

Dial pad touch tones - Select whether to hear tones when you use the dialpad.

Touch sounds - Select whether to hear sound when you tap buttons, icons, and other onscreen items.

Screen lock sounds - Select whether to hear sound when the screen is locked or unlocked.

Vibrate on touch – Select whether to vibrate when touching buttons and keys.

Display

Brightness – Adjust the brightness of the screen.

Auto-rotate screen – Set to switch orientation automatically when you rotate the phone.

Screen timeout – Set the time delay before the screen automatically turns off.

Font type - Select the desired font type.

Font size - Select the desired font size.

Front key light – Tap to set the Front key light options.

Turn on front key light: Checkmark this to set the the front keys (Menu/Search Key, Home Key, Back Key) are turned on, when you use the device.

Settings

Front key light duration: Select how long the front keys remain backlit while the screen is turned on.

Home screen

Animation - Set whether you want to enjoy animated transitions for all supported effects (including when navigating from screen to screen) or to use the phone without any optional animation effects (this setting does not control animation in all applications).

Screen swipe effect - Allows you to select the type of effect to display when you swipe from one Home screen canvas to the next.

Wallpaper - Allows you to set the wallpaper.

Scroll wallpaper - Checkmark to allow the wallpaper to scroll with the screen instead of having it as a static image.

Scroll screens circularly - Checkmark to show the first screen after last screen when scrolling.

Home backup & restore - Select to backup and restore app/widget configurations and the theme.

Lock screen

SCREEN

Select screen lock - Select the desired option to secure your phone from the below.

None - No lock screen.

Swipe - Swipe any part of the screen to unlock screen.

Face Unlock - Unlocks the screen through facial recognition. Follow the prompts. You are asked to select Pattern and/or PIN as a backup.

Pattern - Opens a set of screens that guide you through drawing a screen unlock pattern. It's recommended that you enter backup PIN as well in case that you might lost the pattern. Then, you can set the wallpaper on the lock screen, whether to show the owner information, the lock timer, vibrate on touch, or whether to make the pattern visible.

PIN - Enter a numeric PIN to unlock screen.

Password - Enter a password to unlock screen.

Wallpaper - Select the wallpaper to display for your lock screen.

Clocks & shortcuts - Customize clocks and shortcuts on the lock screen.

Owner info - Display the owner info on the lock screen.

LOCK TIME

Lock timer - While your phone is at sleep mode, your phone will be locked after the time you set here has elapsed. But, if None or Swipe is selected at Select screen lock menu, your phone will not be locked.

Power button instantly locks - Regardless of Lock timer setting, your phone will be locked immediately when Power button is pressed. But, if None or Swipe is selected at Select screen lock menu, your phone will not be locked.

Storage

INTERNAL STORAGE

You can monitor the used and available space on the system memory.

Total space - Lists the total amount of space on any microSD card installed in your phone. It is divided by the type of files stored.

SD CARD

You can monitor the used and available space on your microSD card.

Unmount SD card - Tap this to unmount the microSD card from your phone so that you can format the card or safely remove.

Erase SD card - Permanently erases everything on the microSD card and prepares it for use with your phone. You must unmount the microSD card before you can format it.

Power saver

Turn Power saver on - Select the level you want to turn on the Power saver.

Power saver tips - Touch to access some tips for Power saver.

POWER SAVING ITEMS - Select to turn off features when battery is low.

Auto-sync - Turn off Auto-sync.

Wi-Fi - Turn off Wi-Fi if data is not in use.

Bluetooth - Turn off Bluetooth if not connected.

Vibrate on touch - Turn off touch feedback.

Brightness - Adjust the brightness.

Screen timeout - Adjust screen timeout of screen.

Settings

Front key light - Adjust Front key light timeout.

BATTERY INFORMATION - View the amount of power consumed by your device.

Apps

You use the Applications settings menu to view details about the applications installed on your phone, manage their data, force them to stop, and to set whether you want to permit installation of applications that you obtain from websites and email. Tap the Downloaded, On SD card, Running or All tabs to view information about your installed apps.

PERSONAL

Accounts & sync

Use the Accounts & sync settings menu to add, remove, and manage your Google™ and other supported accounts. You also use these settings to control how and whether all applications send, receive, and sync data on their own schedules and whether all applications can synchronize user data automatically. Gmail™, Calendar, and other applications may also have their own settings to control how they synchronize

data; see the sections on those applications for details. Slide  right to enable adding account or sync. Touch ADD ACCOUNT to add new account.

Location services

Use the Location services menu to set your preferences for using and sharing your location when you search for information and use location-based applications, such as Maps.

Google's location service - Checkmark to use information from Wi-Fi and mobile networks to determine your approximate location, used while searching in Google Maps and other applications. When you checkmark this option, you're asked whether you consent to sharing your location anonymously with Google's location service.

GPS satellites - Checkmark to enable your phone's standalone global positioning system (GPS) satellite receiver to pinpoint your location to within an accuracy as close as several meters ("street level"). Actual GPS accuracy depends on a clear view of the sky and other factors.

Location & Google search - Let Google use your location to improve search results and other services.

Security

Use the Security settings to configure how to help secure your phone and its data.

ENCRYPTION

Encrypt device - Opens a screen that encrypts data on the device for security. You will be required to enter a PIN or password to decrypt your phone each time you power it on.

SIM CARD LOCK

Set up SIM card lock - Opens a screen to set if you want to require a PIN to use or, if set, allows you to change the PIN.

PASSWORDS

Password typing visible - Checkmark to briefly show each character of passwords as you enter them so that you can see what you enter.

DEVICE ADMINISTRATION

Device administrators - Add or remove device administrators.

Unknown sources - Allow installation of non-Play Store applications.

CREDENTIAL STORAGE

Trusted credentials - Checkmark to allow applications to access your phone's encrypted store of secure certificates and related passwords and other credentials. You use credential storage to establish some kinds of VPN and Wi-Fi connections. If you have not set a password for the secure credential storage, this setting is dimmed.

Install from storage - Touch to install a secure certificate from a microSD card.

Clear credentials - Deletes all secure certificates and related credentials and erases the secure storage's own password, after prompting you to confirm that you want to do this.

Settings

Language & input

Select the language for the text on your phone and for configuring the on-screen keyboard, including words that you've added to its dictionary.

Language - Choose a language to use on your phone.

Personal dictionary - Allows you to view, edit, and add words to your personal dictionary.

KEYBOARD & INPUT METHODS

Default - Shows the default keyboard type.

Checkmark the keyboard you want to use from Google voice typing, LG Keyboard. And tap  to configure each keyboard's settings.

SPEECH

Voice Search - Touch to configure the Voice Search settings.

Text-to speech output - Touch to set the preferred engine or general settings for text-to-speech output.

MOUSE/TRACKPAD

Pointer speed - Adjust the pointer speed.

Backup & reset

BACKUP & RESTORE

Back up my data - Back up app data, Wi-Fi passwords, and other settings to Google servers.

Backup account - Displays the accounts that are currently being backed up.

Automatic restore - When reinstalling an app, restore backed up settings and data.

PERSONAL DATA

Factory data reset - Erases all data on the phone.

SYSTEM

Date & Time

Set your preferences for how the date and time is displayed.

Accessibility

Use the Accessibility settings to configure any accessibility plug-ins you have installed on your phone.

NOTE

Requires additional plug-ins to become selectable.

Connectivity

USB CONNECTION

USB connection type - Opens a dialog box to choose the default connection mode when connecting your phone to a PC via USB. Choose from **Charge only**, **Mass storage**, **Media sync (MTP)**, **USB tethering**, **LG software**, or **Camera (PTP)**.

Ask on connection - Checkmark to have the phone ask you to choose which USB connection mode it should connect with to a PC.

Help - Touch to get information on the different types of USB connections.

Developer options

USB debugging- Checkmark to set Debug mode when USB is connected.

Development device ID - Displays the development device ID.

Stay awake- If activated, the screen will never sleep while charging.

Allow mock locations- Checkmark to allow mock locations.

HDCP check

Desktop backup password- Allows you to set a desktop backup password.

USER INTERFACE

Enable strict mode - Checkmark to flash the screen when apps operate for a long time on the main thread.

Show touch data - Checkmark to make touch data visible on the screen.

Show touches - Checkmark to show visual feedback when the screen is touched.

Show screen updates - Checkmark to flash areas of the screen when they update.

Show CPU usage - Checkmark to display a screen overlay showing current CPU usage.

Force GPU rendering - Checkmark to use 2D hardware acceleration in applications.

Window animation scale - Select to set the window animation scale.

Transition animation scale - Select to set transition animation scale.

Settings

APPS

Don't keep activities - Checkmark to quit every activity as soon as the user leaves it.

Background process limit - Set the preferred Background process limit.

Show all ANRs - Checkmark to show App Not Responding dialog for background apps.

About phone

View legal information, check phone status and software versions, and perform the software update.

Software Update

Phone Software Update

This feature allows you to update the firmware of your phone to the latest version conveniently from the internet without the need to visit a service center.

For more information on how to use this function, please visit:

<http://www.lg.com>

As the mobile phone firmware update requires the user's full attention for the duration of the update process, please make sure to check all instructions and notes that appear at each step before proceeding. Please note that removing the USB cable or battery during the upgrade may seriously damage your mobile phone.

LG Mobile Phone Software update via Over-the-Air (OTA)

This feature allows you to update the firmware of your phone to the newer version conveniently via OTA without connecting the USB data cable. This feature is only available if and when LG makes the newer version of the firmware available for your device.

First, you can check the software version on your mobile phone:

Tap the **Menu/Search Key**  > **System settings** > **About phone**. You can check the software version at the bottom of the list.

To perform the phone software update, tap the **Menu/Search Key**  > **System settings** > **About phone** > **Software update** > **Check now for update**.

NOTE

LG reserves the right to firmware updates available only for selected models at its own discretion and does not guarantee the availability of the newer version of the firmware for all handset models.

Software Update

NOTE

Your personal data—including information about your Google account and any other accounts, your system/application data and settings, any downloaded applications and your DRM licence —might be lost in the process of updating your phone's software. Therefore, LG recommends that you back up your personal data before updating your phone's software. LG does not take responsibility for any loss of personal data.