

SAR TEST REPORT

Test item : Cellular/PCS GSM/GPRS/EDGE Phone with Bluetooth, WLAN and NFC
Model No. : LG-P692, P692, LGP692
Order No. : 1106-00873
Date of receipt : 2011-06-23
Test duration : 2011-07-06 ~ 2011-07-08
Date of issue : 2011-07-21
Use of report : FCC Original Grant

Applicant : LG Electronics, Inc.
60-39, Gasan-Dong, Gumchon-Gu, Seoul 153-023, Korea

Test laboratory : Digital EMC Co., Ltd.
683-3, Yubang-Dong, Cheoin-Gu, Yongin-Si, Kyunggi-Do, 449-080, Korea

Test specification : §2.1093, FCC/OET Bulletin 65 Supplement C[July 2001]
Test environment : See appended test report
Test result : Pass Fail

The test results presented in this test report are limited only to the sample supplied by applicant and the use of this test report is inhibited other than its purpose. This test report shall not be reproduced except in full, without the written approval of DIGITAL EMC CO., LTD.

Tested by:



Engineer
N.K.Lim

Witnessed by:

N/A

Reviewed by:



Manager
W.J. Lee

Table of Contents

1. INTROCUCTION	3
2. DESCRIPTION OF DEVICE.....	4
3. DESCRIPTION OF TEST EQUIPMENT	5
3.1 SAR MEASUREMENT SETUP.....	5
3.2 EX3DV4Probe Specification	6
3.3 Probe Calibration Process	7
3.3.1E-Probe Calibration	7
3.4 Data Extrapolation	8
3.5 SAM PHANTOM.....	9
3.6Device Holder for Transmitters.....	9
3.7 Brain & Muscle Simulation Mixture Characterization	10
3.8 SAR TEST EQUIPMENT	11
4. TEST SYSTEM SPECIFICATIONS.....	12
5. SAR MEASUREMENT PROCEDURE.....	13
6. DESCRIPTION OF TEST POSITION.....	14
6.1 HEAD POSITION	14
6.2 Positioning for Cheek/Touch	15
6.3 Positioning for Ear / 15 ° Tilt.....	15
6.4 Body Holster /Belt Clip Configurations	16
7. IEEE P1528 –MEASUREMENT UNCERTAINTIES.....	17
8. ANSI / IEEE C95.1-2005 RF EXPOSURE LIMITS	18
9. SYSTEM VERIFICATION.....	19
9.1 Tissue Verification	19
9.2 Test System Validation	19
10. Multiple TRANSMITTERS SAR CONSIDERATIONS.....	20
10.1 SAR for Simultaneous Transmission	21
11. Configuring 802.11 a/b/g Transmitters for SAR Measurement.....	22
12. SAR CONSIDERATIONS.....	23
12.1 SAR Test Configurations	23
12.2 Antenna Distance	23
13. SAR TEST DATA SUMMARY AND POWER TABLE.....	24
14. SAR TEST DATA SUMMARY	26
14.1 Measurement Results (GSM850 Head SAR Touch).....	26
14.2 Measurement Results (GSM850 Head SAR Tilt).....	27
14.3 Measurement Results (PCS1900 Head SAR Touch).....	28
14.4 Measurement Results (PCS1900 Head SAR Tilt)	29
14.5 Measurement Results (W-LAN(802.11b) Head SAR Touch)	30
14.6 Measurement Results (W-LAN(802.11b) Head SAR Tilt)	31
14.7 Measurement Results (GSM850 GPRS Hotspot Body SAR).....	32
14.8 Measurement Results (PCS1900 GPRS Hotspot Body SAR).....	33
14.9 Measurement Results (W-LAN(802.11b) Body SAR)	34
15.CONCLUSION.....	35
16. REFERENCES	36
Attachment 1. – Dipole Validation Plots.....	38
Attachment 2. – SAR Test Plots	45
Attachment 3. – Probe Calibration Data	118
Attachment 4. – Dipole Calibration Data	130

1. INTROCUCTION

The FCC has adopted the guidelines for evaluating the environmental effects of radio frequency radiation in ET Docket 93-62 on Aug. 6, 1996 to protect the public and workers from the potential hazards of RF emissions due to FCC-regulated portable devices. The safety limits used for the environmental evaluation measurements are based on the criteria published by the American National Standards Institute (ANSI) for localized specific absorption rate (SAR) in IEEE/ANSI C95.1-2005 Standard for Safety Levels with Respect to Human Exposure to Radio Frequency Electromagnetic Fields, 3 kHz to 300 GHz. 1992 by the Institute of Electrical and Electronics Engineers, Inc., New York, New York 10017. The measurement procedure described in IEEE/ANSI C95.3-1992 Recommended Practice for the Measurement of Potentially Hazardous Electromagnetic Fields - RF and Microwave is used for guidance in measuring SAR due to the RF radiation exposure from the Equipment Under Test (EUT). These criteria for SAR evaluation are similar to those recommended by the National Council on Radiation Protection and Measurements (NCRP) in Biological Effects and Exposure Criteria for Radio frequency Electromagnetic Fields," NCRP Report No. 86 NCRP, 1986, Bethesda, MD 20814. SAR is a measure of the rate of energy absorption due to exposure to an RF transmitting source. SAR values have been related to threshold levels for potential biological hazards.

SAR Definition

Specific Absorption Rate (SAR) is defined as the time derivative (rate) of the incremental energy (dU) absorbed by (dissipated in) an incremental mass (dm) contained in a volume element (dV) of a given density (ρ) It is also defined as the rate of RF energy absorption per unit mass at a point in an absorbing body (see Fig. 1.1)

$$SAR = \frac{d}{dt} \left(\frac{dU}{dm} \right) = \frac{d}{dt} \left(\frac{dU}{\rho dV} \right)$$

Figure 1.1
SAR Mathematical Equation

SAR is expressed in units of Watts per Kilogram (W/kg).

$$SAR = \frac{\sigma \cdot E^2}{\rho}$$

Where:

- σ = conductivity of the tissue-simulant material (S/m)
- ρ = mass density of the tissue-simulant material (kg/m³)
- E = Total RMS electric field strength (V/m)

NOTE: The primary factors that control rate of energy absorption were found to be the wavelength of the incident field in relations to the dimensions and geometry of the irradiated organism, the orientation of the organism in relation to the polarity of field vectors, the presence of reflecting surfaces, and whether conductive contact is made by the organism with a ground plane.

2. DESCRIPTION OF DEVICE

Environmental evaluation measurements of specific absorption rate (SAR) distributions in emulated human head and body tissues exposed to radio frequency (RF) radiation from wireless portable devices for compliance with the rules and regulations of the U.S. Federal Communications Commission (FCC).

General Information

Equipment type	Cellular/PCS GSM/GPRS/EDGE Phone with Bluetooth, WLAN and NFC
FCC ID:	ZNFP692
Equipment model name	LG-P692
Equipment add model name	P692, LGP692
Equipment serial no.	Identical prototype
Mode(s) of Operation	GSM850, PCS1900, W-LAN(802.11b)
TX Frequency Range	824.2 ~ 848.8 MHz(Cellular Band) 1850.2 ~ 1909.8 MHz(PCS Band) 2412 ~ 2462 MHz(802.11b)
RX Frequency Range	869.2 ~ 893.8 MHz(Cellular Band) 1930.2 ~ 1989.8 MHz(PCS Band) 2412 ~ 2462 MHz(802.11b)
Max. SAR Measurement	0.691 W/kg GSM850 Head SAR 1.190 W/kg GSM850 Body SAR 1.080 W/kg PCS1900 Head SAR 0.764 W/kg PCS1900 Body SAR 0.500 W/kg W-LAN Head SAR 0.119 W/kg W-LAN Body SAR
FCC Equipment Class	Licensed Portable Transmitter Held to Ear (PCE)
Date(s) of Tests	2011-07-06 ~ 2011-07-08
Antenna Type	Internal Type Antenna

3. DESCRIPTION OF TEST EQUIPMENT

3.1 SAR MEASUREMENT SETUP

Measurements are performed using the DASY4 automated dosimetric assessment system. The DASY4 is made by Schmid & Partner Engineering AG (SPEAG) in Zurich, Switzerland and consists of high precision robotics system (Staubli), robot controller, Pentium III computer, near-field probe, probe alignment sensor, and the generic twin phantom containing the brain equivalent material. The robot is a six-axis industrial robot performing precise movements to position the probe to the location (points) of maximum electromagnetic field (EMF) (see Fig. 3.1).

A cell controller system contains the power supply, robot controller teach pendant (Joystick), and a remote control used to drive the robot motors. The PC consists of the Micron Pentium IV 500 MHz computer with Windows NT system and SAR Measurement Software DASY4, A/D interface card, monitor, mouse, and keyboard. The Staubli Robot is connected to the cell controller to allow software manipulation of the robot. A data acquisition electronic (DAE) circuit that performs the signal amplification, signal multiplexing, AD-conversion, offset measurements, mechanical surface detection, collision detection, etc. is connected to the Electro-optical coupler (EOC). The EOC performs the conversion from the optical into digital electric signal of the DAE and transfers data to the PC plug-in card.

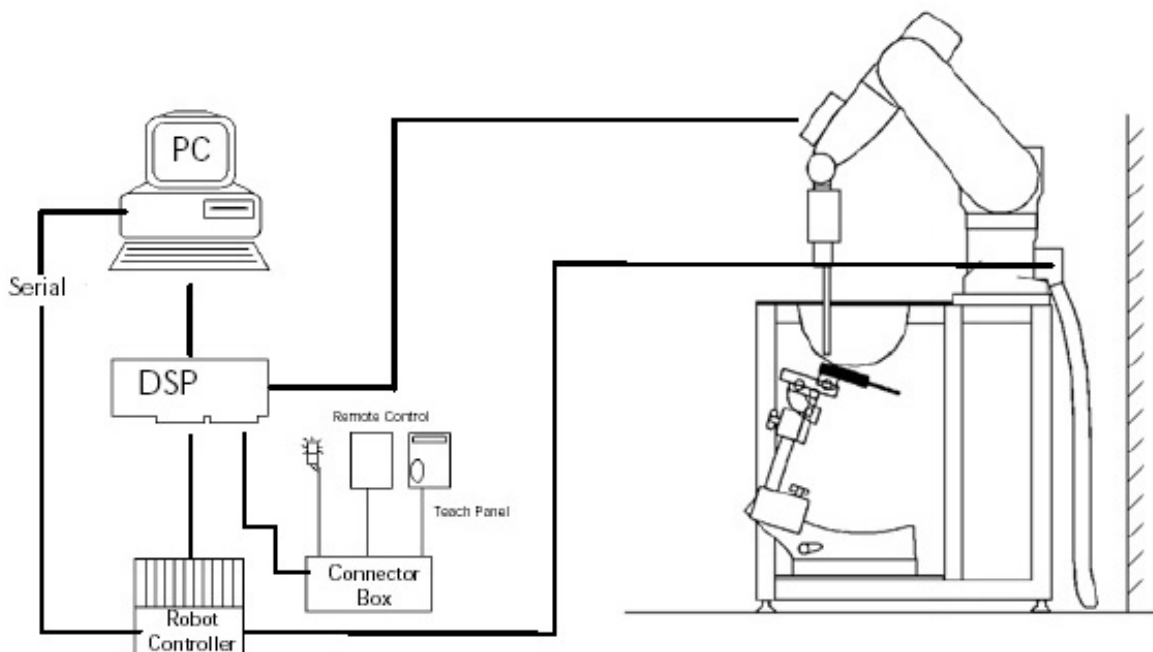

Figure 3.1 SAR Measurement System Setup

The DAE3 consists of a highly sensitive electrometer-grade preamplifier with auto-zeroing, a channel and gain-switching multiplexer, a fast 16 bit AD-converter and a command decoder and control logic unit. Transmission to the PC-card is accomplished through an optical downlink for data and status information and an optical uplink for commands and clock lines. The mechanical probe mounting device includes two different sensor systems for frontal and sidewise probe contacts. They are also used for mechanical surface detection and probe collision detection. The robot uses its own controller with a built in VME-bus computer. The system is described in detail.

3.2 EX3DV4Probe Specification

Calibration:	In air from 10 MHz to 6.0 GHz In brain and muscle simulating tissue at Frequencies of 450 MHz, 835 MHz, 1750 MHz, 1900 MHz, 2450 MHz, 2600 MHz, 3500 MHz, 5200 MHz, 5300 MHz, 5600 MHz, 5800 MHz
Frequency:	10 MHz to 6 GHz
Linearity:	$\pm 0.2\text{dB}$ (30 MHz to 6 GHz)
Dynamic:	10 mW/kg to 100 W/kg
Range:	Linearity: $\pm 0.2\text{dB}$
Dimensions:	Overall length: 330 mm
Tip length:	20 mm
Body diameter:	12 mm
Tip diameter:	2.5 mm
Distance from probe tip to sensor center:	1 mm
Application:	SAR Dosimetry Testing Compliance tests of mobile phones



DAE System

The SAR measurements were conducted with the dosimetric probe EX3DV4, designed in the classical triangular configuration (see Fig. 3.2) and optimized for dosimetric evaluation. The probe is constructed using the thick film technique; with printed resistive lines on ceramic substrates. The probe is equipped with an optical multi fiber line ending at the front of the probe tip (see Fig. 3.3). It is connected to the EOC box on the robot arm and provides an automatic detection of the phantom surface. Half of the fibers are connected to a pulsed infrared transmitter, the other half to a synchronized receiver. As the probe approaches the surface, the reflection from the surface produces a coupling from the transmitting to the receiving fibers. This reflection increases first during the approach, reaches maximum and then decreases. If the probe is flatly touching the surface, the coupling is zero. The distance of the coupling maximum to the surface is independent of the surface reflectivity and largely independent of the surface to probe angle. The DASY4 software reads the reflection during a software approach and looks for the maximum using a 2nd order fitting. The approach is stopped at reaching the maximum.

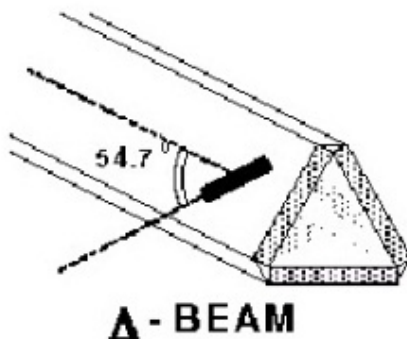

Figure 3.2 Triangular Probe Configurations



Figure 3.3 Probe Thick-Film Technique

3.3 Probe Calibration Process

3.3.1E-Probe Calibration

Dosimetric Assessment Procedure

Each probe is calibrated according to a dosimetric assessment procedure with accuracy better than +/- 10%. The spherical isotropy was evaluated with the procedure and found to be better than +/-0.25dB. The sensitivity parameters (NormX, NormY, NormZ), the diode compression parameter (DCP) and the conversion factor (ConvF) of the probe is tested.

Free Space Assessment

The free space E-field from amplified probe outputs is determined in a test chamber. This is performed in a TEM cell for frequencies below 1 GHz, and in a waveguide above 1GHz for free space. For the free space calibration, the probe is placed in the volumetric center of the cavity at the proper orientation with the field. The probe is then rotated 360 degrees.

Temperature Assessment *

E-field temperature correlation calibration is performed in a flat phantom filled with the appropriate simulated brain tissue. The measured free space E-field in the medium, correlates to temperature rise in a dielectric medium. For temperature correlation calibration a RF transparent the rmist or based temperature probe is used in conjunction with the E-field probe.

$$SAR = C \frac{\Delta T}{\Delta t}$$

where:

Δt = exposure time (30 seconds),

C = heat capacity of tissue (brain or muscle),

ΔT = temperature increase due to RF exposure.

$$SAR = \frac{|E|^2 \cdot \sigma}{\rho}$$

where:

σ = simulated tissue conductivity,

ρ = Tissue density (1.25 g/cm³ for brain tissue)

SAR is proportional to $\Delta T / \Delta t$, the initial rate of tissue heating, before thermal diffusion takes place. Now it's possible to quantify the electric field in the simulated tissue by equating the thermally derived SAR to the E- field;

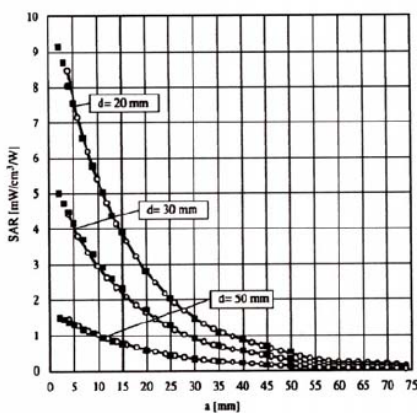

Figure 3.4E-Field and Temperature Measurements at 900MHz

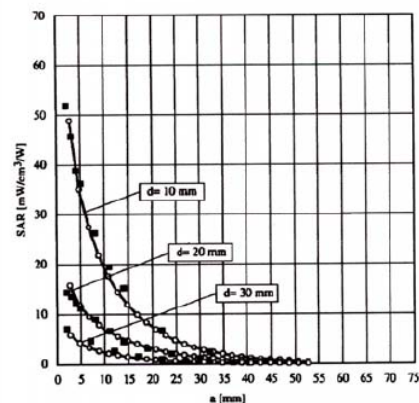

Figure 3.5 E-Field and Temperature Measurements at 1800MHz

3.4 Data Extrapolation

The DASY4 software automatically executes the following procedures to calculate the field units from the microvolt readings at the probe connector. The first step of the evaluation is a linearization of the filtered input signal to account for the compression characteristics of the detector diode. The compensation depends on the input signal, the diode type and the DC-transmission factor from the diode to the evaluation electronics. If the exciting field is pulsed, the crest factor of the signal must be known to correctly compensate for peak power. The formula for each channel can be given like below;

$$V_i = U_i + U_i^2 \cdot \frac{cf}{dcp_i}$$

with V_i = compensated signal of channel i (i=x,y,z)
 U_i = input signal of channel i (i=x,y,z)
 cf = crest factor of exciting field (DASY parameter)
 dcp_i = diode compression point (DASY parameter)

From the compensated input signals the primary field data for each channel can be evaluated:

E-field probes:

$$E_i = \sqrt{\frac{V_i}{Norm_i \cdot ConvF}}$$

with V_i = compensated signal of channel i (i = x,y,z)
 $Norm_i$ = sensor sensitivity of channel i (i = x,y,z)
 $\mu V/(V/m)^2$ for E-field probes
 $ConvF$ = sensitivity of enhancement in solution
 E_i = electric field strength of channel i in V/m

The RSS value of the field components gives the total field strength (Hermetian magnitude):

$$E_{tot} = \sqrt{E_x^2 + E_y^2 + E_z^2}$$

The primary field data are used to calculate the derived field units.

$$SAR = E_{tot}^2 \cdot \frac{\sigma}{\rho \cdot 1000}$$

with SAR = local specific absorption rate in W/g
 E_{tot} = total field strength in V/m
 σ = conductivity in [mho/m] or [Siemens/m]
 ρ = equivalent tissue density in g/cm³

The power flow density is calculated assuming the excitation field to be a free space field.

$$P_{pwe} = \frac{E_{tot}^2}{3770}$$

with P_{pwe} = equivalent power density of a plane wave in W/cm²
 E_{tot} = total electric field strength in V/m

3.5 SAM PHANTOM

The SAM Twin Phantom V4.0 is constructed of a fiberglass shell integrated in a wooden table. The shape of the shell is based on data from an anatomical study designed to determine the maximum exposure in at least 90% of all users. It enables the dosimetric evaluation of left and right hand phone usage as well as body mounted usage at the flat phantom region. A cover prevents the evaporation of the liquid.

Reference markings on the Phantom allow the complete setup of all predefined phantom positions and measurement grids by manually teaching three points in the robot. (see Fig. 3.6)



Figure 3.6 SAM Twin Phantom

3.6 Device Holder for Transmitters

In combination with the SAM Twin Phantom V4.0 the Mounting Device(see Fig. 3.7),enables the rotation of the mounted transmitter in spherical coordinates whereby the rotation point is the ear opening. The devices can be easily, accurately, and repeatedly be positioned according to the FCC specifications. The device holder can be locked at different phantom locations (left head, right head, flat phantom).

Note: A simulating human hand is not used due to the complex anatomical and geometrical structure of the hand that may produce infinite number of configurations. To produce the worst-case condition (the hand absorbs antenna output power), the hand is omitted during the tests.



Figure 3.7 Mounting Device

3.7 Brain & Muscle Simulation Mixture Characterization



Figure 3.8 SimulatedTissue

The brain and muscle mixtures consist of a viscous gel using hydrox-ethyl cellulose (HEC) gelling agent and saline solution (see Table 3.1). Preservation with a bactericide is added and visual inspection is made to make sure air bubbles are not trapped during the mixing process. The mixture is calibrated to obtain proper dielectric constant (permittivity) and conductivity of the desired tissue. The mixture characterizations used for the brain and muscle tissue simulating liquids are according to the data by C. Gabriel and G. Harts grove.

Table3.1 Composition of the Tissue Equivalent Matter

INGREDIENTS	835MHz Brain	835MHz Muscle	1800MHz Brain	1800MHz Muscle	1900MHz Brain	1900MHz Muscle	2450MHz Brain	2450MHz Muscle
WATER	40.19%	50.75%	55.24%	69.04%	55.24%	70.23%	71.88%	73.4%
SUGAR	57.90%	48.21%	-	-	-	-	-	-
SALT	1.48%	0.94%	0.31%	2.72%	0.31%	0.29%	0.16%	0.06%
DGBE	-	-	44.45%	28.24%	44.45%	29.48%	7.99%	26.54%
Triton X-100	-	-	-	-	-	-	19.97%	-
BACTERIACIDE	0.18%	0.10%	-	-	-	-	-	-
HEC	0.25%	-	-	-	-	-	-	-
Dielectric Constant Target	41.5	55.2	40	53.3	40	53.3	39.2	52.7
Conductivity Target (S/m)	0.9	0.97	1.4	1.52	1.4	1.52	1.8	1.95

Salt: 99 % Pure Sodium Chloride Sugar: 98 % Pure Sucrose

Water: De-ionized, 16M resistivity HEC: Hydroxyethyl Cellulose

DGBE: 99 % Di(ethylene glycol) butyl ether,[2-(2-butoxyethoxy) ethanol]

Triton X-100(ultra pure): Polyethylene glycol mono[4-(1,1,3,3-tetramethylbutyl)phenyl]

3.8 SAR TEST EQUIPMENT

Table 3.2 Test Equipment Calibration

	Type	Manufacturer	Model	Cal.Date (dd/mm/yy)	Next.Cal.Date (dd/mm/yy)	S/N
<input checked="" type="checkbox"/>	SEMITEC Engineering	SEMITEC	N/A	N/A	N/A	Shield Room
<input checked="" type="checkbox"/>	Robot	SCHMID	RX90BL	N/A	N/A	F02/5Q85A1/A/01
<input checked="" type="checkbox"/>	Robot Controller	SCHMID	CS7MB	N/A	N/A	F02/5Q85A1/C/01
<input checked="" type="checkbox"/>	Joystick	SCHMID	N/A	N/A	N/A	D221340031
<input checked="" type="checkbox"/>	Hicron Computer Pentium Celeron 1.1GHz Window2000	N/A	N/A	N/A	N/A	N/A
<input checked="" type="checkbox"/>	Probe Alignment Unit LB	N/A	N/A	N/A	N/A	321
<input checked="" type="checkbox"/>	Mounting Device	SCHMID	Holder	N/A	N/A	N/A
<input checked="" type="checkbox"/>	Sam Phantom	SCHMID	TP1223	N/A	N/A	N/A
<input type="checkbox"/>	Sam Phantom	SCHMID	TP1224	N/A	N/A	N/A
<input type="checkbox"/>	Head/Body Equivalent Matter(450MHz)	N/A	N/A	01/01/11	01/01/12	N/A
<input checked="" type="checkbox"/>	Head/Body Equivalent Matter(835MHz)	N/A	N/A	01/01/11	01/01/12	N/A
<input type="checkbox"/>	Head/Body Equivalent Matter(1800MHz)	N/A	N/A	01/01/11	01/01/12	N/A
<input checked="" type="checkbox"/>	Head/Body Equivalent Matter(1900MHz)	N/A	N/A	01/01/11	01/01/12	N/A
<input checked="" type="checkbox"/>	Head/Body Equivalent Matter(2450MHz)	N/A	N/A	01/01/11	01/01/12	N/A
<input checked="" type="checkbox"/>	Data Acquisition Electronics	SCHMID	DAE3V1	28/01/11	28/01/12	519
<input type="checkbox"/>	Data Acquisition Electronics	SCHMID	DAE3V1	23/11/10	23/11/11	520
<input checked="" type="checkbox"/>	Dosimetric E-Field Probe	SCHMID	EX3DV4	24/01/11	24/01/12	3643
<input type="checkbox"/>	Dummy Probe	N/A	N/A	N/A	N/A	N/A
<input type="checkbox"/>	450MHz System Validation Dipole	SCHMID	D450V2	24/01/11	24/01/13	1011
<input checked="" type="checkbox"/>	835MHz System Validation Dipole	SCHMID	D835V2	22/03/10	22/03/12	464
<input type="checkbox"/>	1800MHz System Validation Dipole	SCHMID	D1800V2	16/07/10	16/07/12	2d047
<input checked="" type="checkbox"/>	1900MHz System Validation Dipole	SCHMID	D1900V2	23/03/10	23/03/12	5d029
<input checked="" type="checkbox"/>	2450MHz System Validation Dipole	SCHMID	D2450V2	18/03/10	18/03/12	726
<input type="checkbox"/>	2600MHz System Validation Dipole	SCHMID	D2600V2	27/05/10	27/05/12	1016
<input type="checkbox"/>	3500MHz System Validation Dipole	SCHMID	D3500V2	27/05/10	27/05/12	1018
<input checked="" type="checkbox"/>	Network Analyzer	HP	8753D	08/03/11	08/03/12	3410J01204
<input checked="" type="checkbox"/>	Signal Generator	HP	ESG-3000A	01/07/11	01/07/12	US37230529
<input checked="" type="checkbox"/>	Amplifier	EMPOWER	BBS3Q7ELU	04/10/10	04/10/11	1020
<input checked="" type="checkbox"/>	Power Meter	HP	EPM-442A	07/03/11	07/03/12	GB37170267
<input checked="" type="checkbox"/>	Power Sensor	HP	8481A	07/03/11	07/03/12	3318A96566
<input checked="" type="checkbox"/>	Power Sensor	HP	8481A	07/03/11	07/03/12	3318A90918
<input checked="" type="checkbox"/>	Dual Directional Coupler	Agilent	778D-012	11/01/11	11/01/12	50228
<input checked="" type="checkbox"/>	Directional Coupler	HP	773D	01/07/11	01/07/12	2389A00640
<input checked="" type="checkbox"/>	Low Pass Filter 1.5GHz	Micro LAB	LA-15N	11/01/11	11/01/12	N/A
<input checked="" type="checkbox"/>	Low Pass Filter 3.0GHz	Micro LAB	LA-30N	04/10/10	04/10/11	N/A
<input checked="" type="checkbox"/>	Attenuators(3dB)	Agilent	8491B	02/07/11	02/07/12	MY39260700
<input checked="" type="checkbox"/>	Attenuators(10dB)	WEINSCHL	23-10-34	11/01/11	11/01/12	BP4387
<input type="checkbox"/>	Step Attenuator	HP	8494A	04/10/10	04/10/11	3308A33341
<input checked="" type="checkbox"/>	Dielectric Probe kit	Agilent	85070D	N/A	N/A	US01440118
<input checked="" type="checkbox"/>	8960 Series 10 Wireless Comms. Test Set	Agilent	E5515C	07/03/11	07/03/12	GB43461134
<input type="checkbox"/>	Bluetooth Tester	TESCOM	TC-3000B	01/07/11	01/07/12	3000B640046

NOTE: The E-field probe was calibrated by SPEAG, by temperature measurement procedure. Dipole Validation measurement is performed by Digital EMC before each test. The brain simulating material is calibrated by Digital EMC using the dielectric probe system and network analyzer to determine the conductivity and permittivity (dielectric constant) of the brain-equivalent material.

4. TEST SYSTEM SPECIFICATIONS

Automated Test System Specifications

Positioner

Robot: Stäubli Unimation Corp. Robot Model: RX60L
Repeatability: 0.02 mm
No. of axis: 6

Data Acquisition Electronic (DAE) System Cell Controller

Processor: Pentium 4 CPU
Clock Speed: 3 GHz
Operating System: Window 2000
Data Card: DASY4 PC-Board

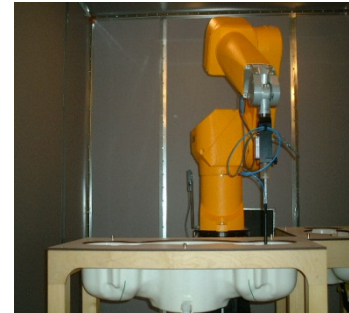

Figure 4.1 DASY4 Test System

Data Converter

Features: Signal, multiplexer, A/D converter. & control logic
Software: DASY4
Connecting Lines: Optical downlink for data and status info
 Optical uplink for commands and clock

PC Interface Card

Function: 24 bit (64 MHz) DSP for real time processing
 Link to DAE 3
 16 bit A/D converter for surface detection system
 serial link to robot
 direct emergency stop output for robot

E-Field Probes

Model: EX3DV4 S/N: 3643
Construction: Triangular core fiber optic detection system
Frequency: 10 MHz to 6 GHz
Linearity: ± 0.2 dB (30MHz to 6GHz)

Phantom

Phantom: SAM Twin Phantom (V4.0)
Shell Material: Vivac Composite
Thickness: 2.0 ± 0.2 mm

5. SAR MEASUREMENT PROCEDURE

The evaluation was performed using the following procedure:

1. The SAR measurement was taken at a selected spatial reference point to monitor power variations during testing. This fixed location point was measured and used as a reference value.
2. The SAR distribution at the exposed side of the head was measured at a distance of 3.9mm from the Inner surface of the shell. The area covered the entire dimension of the head and the horizontal grid spacing was 15 mm x 15 mm.
3. Based on the area scan data, the area of the maximum absorption was determined by sp line interpolation. Around this point, a volume of 32 mm x32 mm x 30 mm (fine resolution volume scan, zoom scan) was assessed by measuring 5 x 5 x 7 points. On this basis of this data set, the spatial peak SAR value was evaluated with the following procedure (see Sample SAR Area Scan):
 - a. The data at the surface was extrapolated, since the center of the dipoles is 2.5 mm away from the tip of the probe and the distance between the surface and the lowest measuring point is 1.2mm. The extrapolation was based on a least square algorithm. A polynomial of the fourth order was calculated through the points in z-axis. This polynomial was then used to evaluate the points between the surface and the probe tip.
 - b. The maximum interpolated value was searched with a straight-forward algorithm. Around this maximum the SAR values averaged over the spatial volumes (1g or 10g) were computed using the 3D-Spline interpolation algorithm. The 3D-spline is composed of three one-dimensional sp lines with the "Not a knot" condition (in x, y, and z directions). The volume was integrated with the trapezoidal algorithm. One thousand points (10 x 10x 10) were interpolated to calculate the average.
 - c. All neighboring volumes were evaluated until no neighboring volume with a higher average value was found.
4. The SAR reference value, at the same location as procedure #1, was re-measured. If the value changed by more than 5%, the evaluation is repeated.

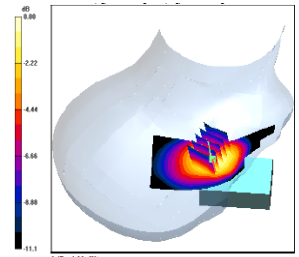

Sample SAR Area Scan

Specific Anthropomorphic Mannequin (SAM) Specifications

The phantom for handset SAR assessment testing is a low-loss dielectric shell, with shape and dimensions derived from the anthropometric data of the 90th percentile adult male head dimensions as tabulated by the US Army. The SAM Twin Phantom shell is bisected along the mid-sagittal plane into right and left halves (see Fig. 5.1). The perimeter side walls of each phantom halves are extended to allow filling with liquid to a depth that is sufficient to minimized reflections from the upper surface. The liquid depth is maintained at a minimum depth of 15cm to minimize reflections from the upper surface.



Figure 5.1 Sam Twin Phantom shell

6. DESCRIPTION OF TEST POSITION

6.1 HEAD POSITION

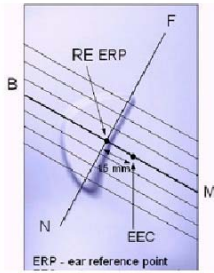

Figure 6.2 Close-up side view of ERPs

Figure 6.1 shows the front, back and side views of the SAM Twin Phantom. The point “M” is the reference point for the center of the mouth, “LE” is the left ear reference point(ERP), and “RE” is the right ERP. The ERPs are 15mm posterior to the entrance to the Ear canal (EEC) along the B-M line (Back-Mouth), as shown in Figure 6.5. The plane Passing, through the two ear canals and M is defined as the Reference Plane. The line N-F (Neck- Front) is perpendicular to the reference plane and passing through the RE (or LE) is called the Reference Pivoting Line (see Figure 6.2). Line B-M is perpendicular to the N-F line. Both N-F and B-M lines are marked on the external phantom shell to facilitate hand set positioning.



Figure 6.1 Front, back and side view SAM Twin Phantom

Handset Reference Points

Two imaginary lines on the handset were established: the vertical centerline and the horizontal line. The test device was placed in a normal operating position with the “test device reference point” located along the “vertical centerline” on the front of the device aligned to the “ear reference point” (See Fig. 6.3). The “test device reference point” was then located at the same level as the center of the ear reference point. The test device was positioned so that the “vertical centerline” was bisecting the front surface of the handset at it’s top and bottom edges, positioning the “ear reference point” on the outer surface of the both the left and right head phantoms on the ear reference point.

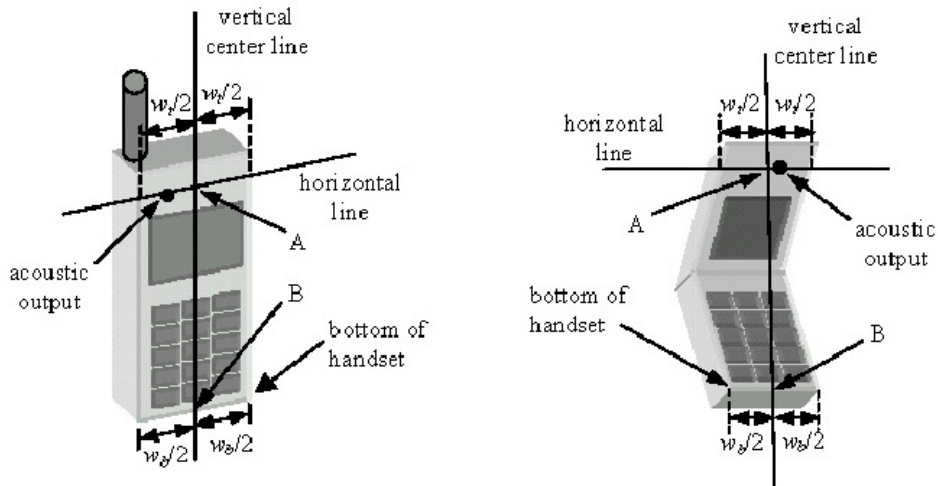

Figure 6.3 Handset Vertical Center & Horizontal Line Reference Points

6.2 Positioning for Cheek/Touch

1. The test device was positioned with the handset close to the surface of the phantom such that point A is on the (virtual) extension of the line passing through points RE and LE on the phantom (see Figure 6.4), such that the plane defined by the vertical center line and the horizontal line of the phone is approximately parallel to the sagittal plane of the phantom.

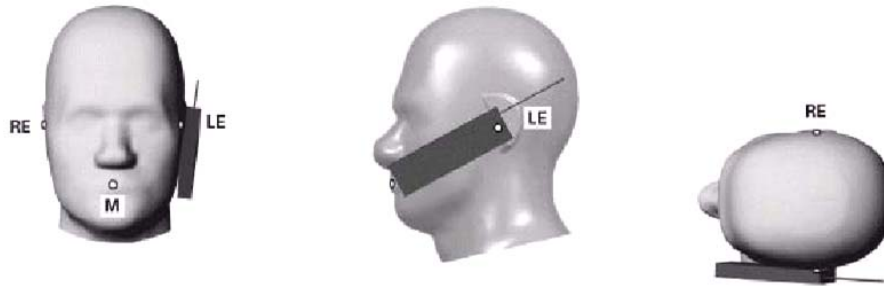

Figure 6.4 Front, Side and Top View of Cheek/Touch Position

2. The handset was translated towards the phantom along the line passing through RE & LE until the handset touches the ear.

3. While maintaining the handset in this plane, the handset was rotated around the LE-RE line until the vertical centerline was in the plane normal to MB-NF including the line MB (reference plane).

4. The phone was then rotated around the vertical centerline until the phone (horizontal line) was symmetrical with respect to the line NF.

5. While maintaining the vertical centerline in the reference plane, keeping point A on the line passing through RE and LE, and maintaining the phone contact with the ear, the handset was rotated about the line NF until any point on the handset made contact with a phantom point below the ear (cheek). (See Figure 6.5)

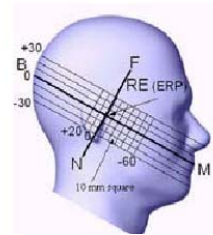

Figure 6.5 Side view w/relevant markings

6.3 Positioning for Ear / 15 ° Tilt

With the test device aligned in the "Cheek/Touch Position":

1. While maintaining the orientation of the phone, the phone was retracted parallel to the reference plane far enough to enable a rotation of the phone by 15 degree.

2. The phone was then rotated around the horizontal line by 15 degree.

3. While maintaining the orientation of the phone, the phone was moved parallel to the reference plane until any part of the phone touches the head. (In this position, point A was located on the line RE-LE). The tilted position is obtained when the contact is on the pinna. If the contact was at any location other than the pinna, the angle of the phone would then be reduced. The tilted position was obtained when any part of the phone was in contact of the ear as well as a second part of the phone was in contact with the head (see Figure 6.6).

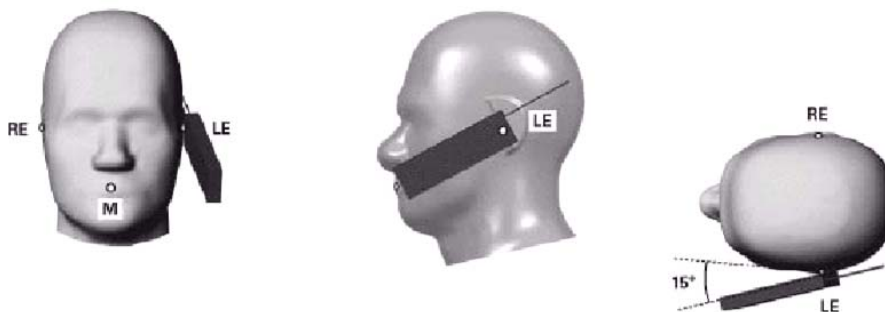

Figure 6.6 Front, Side and Top View of Ear/15° Position

6.4 Body Holster /Belt Clip Configurations

Body-worn operating configurations are tested with the belt-clips and holsters attached to the device and positioned against a flat phantom in a normal use configuration (see Figure 6.8). A device with a headset output is tested with a headset connected to the device. Body dielectric parameters are used.

Accessories for Body-worn operation configurations are divided into two categories: those that do not contain metallic components and those that do contain metallic components. When multiple accessories that do not contain metallic components are supplied with the device, the device is tested with only the accessory that dictates the closest spacing to the body. Then multiple accessories that contain metallic components are supplied with the device, the device is tested with each accessory that contains a unique metallic component. If multiple accessories share an identical metallic component(i.e. the same metallic belt-clip used with different holsters with no other metallic components) only the accessory that dictates the closest spacing to the body is tested.



Figure 6.8 Body Belt Clip & Holster Configurations

Body-worn accessories may not always be supplied or available as options for some.

Devices intended to be authorized for body-worn use. In this case, a test configuration where a separation distances between the back of the device and the flat phantom is used. All test position spacing is documented.

Transmitters that are designed to operate in front of a person's face, as in push-to-talk configurations, are tested for SAR compliance with the front of the device positioned to face the flat phantom.

For devices that are carried next to the body such as a shoulder, waist or chest-worn transmitters, SAR compliance is tested with the accessory (ies), including headsets and microphones, attached to the device and positioned against a flat phantom in a normal use configuration.

In all cases SAR measurements are performed to investigate the worst-case positioning. Worst-case positioning is then documented and used to perform Body SAR testing. In order for users to be aware of the body-worn operating requirements for meeting RF exposure compliance, operating instructions and cautions statements are included in the user's manual.

7. IEEE P1528 –MEASUREMENT UNCERTAINTIES

Error Description	Uncertain value ±%	Probability Distribution	Divisor	(Ci) 1g	Standard (1g)	vi 2 or Veff
Measurement System						
Probe calibration	± 4.8	Normal	1	1	± 4.8 %	∞
Axial isotropy	± 4.7	Rectangular	√3	0.7	± 2.7 %	∞
Hemispherical isotropy	± 9.6	Rectangular	√3	0.7	± 5.5 %	∞
Boundary Effects	± 0.8	Rectangular	√3	1	± 0.5 %	∞
Probe Linearity	± 4.7	Rectangular	√3	1	± 2.7 %	∞
Detection limits	± 0.25	Rectangular	√3	1	± 0.14 %	∞
Readout Electronics	± 1.0	Normal	1	1	± 1.0 %	∞
Response time	± 0.8	Rectangular	√3	1	± 0.5 %	∞
Integration time	± 2.6	Rectangular	√3	1	± 1.5 %	∞
RF Ambient Conditions	± 3.0	Rectangular	√3	1	± 1.7 %	∞
Probe Positioner	± 0.4	Rectangular	√3	1	± 0.2 %	∞
Probe Positioning	± 2.9	Rectangular	√3	1	± 1.7 %	∞
Algorithms for Max. SAR Eval.	± 1.0	Rectangular	√3	1	± 0.6 %	∞
Test Sample Related						
Device Positioning	± 2.9	Normal	1	1	± 2.9 %	145
Device Holder	± 3.6	Normal	1	1	± 3.6 %	5
Power Drift	± 5.0	Rectangular	√3	1	± 2.9 %	∞
Physical Parameters						
Phantom Shell	± 4.0	Rectangular	√3	1	± 2.3 %	∞
Liquid conductivity (Target)	± 5.0	Rectangular	√3	0.64	± 1.8 %	∞
Liquid conductivity (Meas.)	± 5.0	Normal	1	0.64	± 1.6 %	∞
Liquid permittivity (Target)	± 5.0	Rectangular	√3	0.6	± 1.7 %	∞
Liquid permittivity (Meas.)	± 5.0	Normal	1	0.6	± 1.5 %	∞
Combined Standard Uncertainty					± 11.8 %	330
Expanded Uncertainty (k=2)					± 23.6 %	

The above measurement uncertainties are according to IEEE P1528 (2003)

8. ANSI / IEEE C95.1-2005 RF EXPOSURE LIMITS

Uncontrolled Environment

UNCONTROLLED ENVIRONMENTS are defined as locations where there is the exposure of individuals who have no knowledge or control of their exposure. The general population/uncontrolled exposure limits are applicable to situations in which the general public may be exposed or in which persons who are exposed as a consequence of their employment may not be made fully aware of the potential for exposure or cannot exercise control over their exposure. Members of the general public would come under this category when exposure is not employment-related; for example, in the case of a wireless transmitter that exposes persons in its vicinity.

Controlled Environment

CONTROLLED ENVIRONMENTS are defined as locations where there is exposure that may be incurred by persons who are aware of the potential for exposure, (i.e. as a result of employment or occupation). In general, occupational/controlled exposure limits are employment, who have been made fully aware of the potential for exposure and can exercise control over their exposure. This exposure category is also applicable when the exposure is of a transient nature due to incidental passage through a location where the exposure levels may be higher than the general population/uncontrolled limits, but the exposed person is fully aware of the potential for exposure and can exercise control over his or her exposure by leaving the area or by some other appropriate means.

Table 8.1.SAR Human Exposure Specified in ANSI/IEEE C95.1-2005

	HUMAN EXPOSURE LIMITS	
	General Public Exposure (W/kg) or (mW/g)	Occupational Exposure (W/kg) or (mW/g)
SPATIAL PEAK SAR * (Brain)	1.60	8.00
SPATIAL AVERAGE SAR ** (Whole Body)	0.08	0.40
SPATIAL PEAK SAR *** (Hands / Feet / Ankle / Wrist)	4.00	20.0

NOTES:

* The Spatial Peak value of the SAR averaged over any 1 g of tissue

(defined as a tissue volume in the shape of a cube) and over the appropriate averaging time.

** The Spatial Average value of the SAR averaged over the whole-body.

*** The Spatial Peak value of the SAR averaged over any 10 g of tissue

(defined as a tissue volume in the shape of a cube) and over the appropriate averaging time.

Uncontrolled Environments are defined as locations where there is the exposure of individuals who have no knowledge or control of their exposure.

Controlled Environments are defined as locations where there is exposure that may be incurred by persons who are aware of the potential for exposure, (i.e.as a result of employment or occupation).

9. SYSTEM VERIFICATION

9.1 Tissue Verification

MEASURED TISSUE PARAMETERS								
Freq. [MHz]	Date(s)	Liquid	Liquid Temp.[°C]	Parameters	Target Value	Measured Value	Deviation [%]	Limit [%]
835	Jul. 06, 2011	Head	22.6	ϵ_r	41.50	43.00	3.61	± 5
				σ	0.900	0.890	-1.11	± 5
835	Jul. 06, 2011	Body	22.6	ϵ_r	55.20	54.10	-1.99	± 5
				σ	0.970	0.960	-1.03	± 5
1900	Jul. 07, 2011	Head	22.7	ϵ_r	40.00	39.80	-0.50	± 5
				σ	1.400	1.450	3.57	± 5
1900	Jul. 07, 2011	Body	22.7	ϵ_r	53.30	53.90	1.13	± 5
				σ	1.520	1.540	1.32	± 5
2450	Jul. 08, 2011	Head	22.3	ϵ_r	39.20	38.60	-1.53	± 5
				σ	1.800	1.850	2.78	± 5
2450	Jul. 08, 2011	Body	22.3	ϵ_r	52.70	52.90	0.38	± 5
				σ	1.950	2.000	2.56	± 5

9.2 Test System Validation

Prior to assessment, the system is verified to the $\pm 10\%$ of the specifications at 835 MHz, 1900 MHz and 2450 MHz by using the system validation kit(s). (Graphic Plots Attached)

SYSTEM DIPOLE VALIDATION TARGET & MEASURED (835 MHz / 1900 MHz / 2450 MHz values are normalized to a forward power of 1/4 W)								
Freq. [MHz]	Date(s)	Liquid	Liquid Temp.[°C]	SAR Average	Targeted SAR _{1g} (W/kg)	Measured SAR _{1g} (W/kg)	Deviation [%]	Limit [%]
835	Jul. 06, 2011	Head	22.6	1g	2.44	2.37	-2.87	± 10
835	Jul. 06, 2011	Body	22.6	1g	2.48	2.55	2.82	± 10
1900	Jul. 07, 2011	Head	22.7	1g	9.85	10.1	2.54	± 10
1900	Jul. 07, 2011	Body	22.7	1g	10.15	9.88	-2.66	± 10
2450	Jul. 08, 2011	Head	22.3	1g	13.08	12.5	-4.43	± 10
2450	Jul. 08, 2011	Body	22.3	1g	12.83	12.4	-3.35	± 10

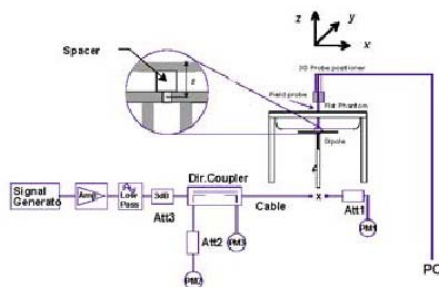

Figure 9.1 Dipole Validation Test Setup

10. Multiple TRANSMITTERS SAR CONSIDERATIONS

The following procedures adopted from "FCC SAR Evaluation Considerations for Handsets with Multiple Transmitters" v01r05 #648474 on September 2008 are applicable to handsets with built-in unlicensed transmitters such as 802.11 a/b/g and Bluetooth devices which may simultaneously transmit with the licensed transmitter.

	2.45	5.15-5.35	5.47-5.85	GHz
P_{Ref}	12	6	5	mW
Device output power should be rounded to the nearest mW to compare with values specified in this table				

Table 10.1 Output Power Thresholds for Unlicensed Transmitters

	Individual Transmitter	Simultaneous Transmission
Licensed Transmitters	<u>Routine evaluation required</u>	SAR not required: <u>Unlicensed only</u> o when stand-alone 1-g SAR is not required and antenna is > 5 cm from other antennas <u>Licensed & Unlicensed</u> o when the sum of the 1-g SAR is <1.6 W/kg for all simultaneous transmitting antennas o when SAR to antenna separation ratio of simultaneous transmitting antenna pair is < 0.3
Unlicensed Transmitters	<p>When there is no simultaneous transmission –</p> <ul style="list-style-type: none"> o output < 60/f: SAR not required o output ≥ 60/f: stand-alone SAR required <p>When there is simultaneous transmission –</p> <p><u>Stand-alone SAR not required when</u></p> <ul style="list-style-type: none"> o output ≤ 2.P_{Ref} and antenna is > 5.0 cm from other antennas o output ≤ P_{Ref} and antenna is > 2.5 cm from other antennas, each either output power output ≤ P_{Ref} or 1-g SAR < 1.2 W/Kg <p><u>Otherwise stand-alone SAR is required</u></p> <p>When stand-alone SAR is required</p> <ul style="list-style-type: none"> o test SAR on highest output channel for each wireless mode and exposure condition o if SAR for highest output channel is > 50% of SAR limit, evaluate all channels according to normal procedures 	<p>SAR required:</p> <p><u>Licensed & Unlicensed</u></p> <p>antenna pairs with SAR to antenna separation ratio ≥ 0.3; test is only required for the configuration that results in the highest SAR in standalone configuration for each wireless mode and exposure condition</p> <p>Note: simultaneous transmission exposure conditions for head and body can be different for different style phones; therefore, different test requirements may apply</p>

Table 10.2 SAR Evaluation Requirements for Cell phones with Multiple Transmitters

FCC ID: ZNFP692

W-LAN Max. RF output power: 15.453 dBm (35.099 mW)

BT Max. RF output power: 7.836 dBm (6.076 mW)

Antenna separation distance: 78.7 mm

- Note 1: unlicensed transmitters stand alone SAR is not required when following condition.
- Output power ≤ P_{Ref}, antenna distance from other antennas >2.5cm each with either output power ≤ P_{Ref} or 1-g SAR < 1.2 W/kg

Therefore Bluetooth stand alone SAR is not required.
Therefore W-LAN(802.11b)stand alone SAR is required.

10.1 SAR for Simultaneous Transmission

Simult TX	Configuration	GSM850 SAR (W/kg)	W-LAN SAR (W/kg)	Σ SAR (W/kg)	Simult TX	Configuration	PCS1900 SAR (W/kg)	W-LAN SAR (W/kg)	Σ SAR (W/kg)
Head SAR	Left Touch	0.577	0.500	1.077	Head SAR	Left Touch	1.080	0.500	1.580
	Right Touch	0.691	0.218	0.909		Right Touch	0.572	0.218	0.790
	Left Tilt	0.380	0.219	0.599		Left Tilt	0.231	0.219	0.450
	Right Tilt	0.335	0.109	0.444		Right Tilt	0.256	0.109	0.365

Table 10.1 Simultaneous Transmission Summation for Held to Ear Voice Call with Hotspot Active Scenario

Simult TX	Configuration	GSM850 SAR (W/kg)	W-LAN SAR (W/kg)	Σ SAR (W/kg)	Simult TX	Configuration	PCS1900 SAR (W/kg)	W-LAN SAR (W/kg)	Σ SAR (W/kg)
Body SAR	Top	-	0.019	0.019	Body SAR	Top	-	0.019	0.019
	Bottom	0.095	-	0.095		Bottom	0.307	-	0.307
	Front	0.874	0.066	0.940		Front	0.764	0.066	0.830
	Rear	1.190	0.119	1.309		Rear	0.636	0.119	0.755
	Right	0.719	0.076	0.795		Right	0.110	0.076	0.186
	Left	0.635	-	0.635		Left	0.235	-	0.235

Table 10.2 Simultaneous Transmission Scenario Hotspot – 1.0 cm

Note: “-”, SAR results above shown in the table are zero for summation purposes. SAR was not required to be measured due to exclusions mentioned in Section “12.1 SAR Test Configuration”.

The above numerical summed SAR was below the SAR limit. Therefore, the above analysis is sufficient to determine that simultaneous transmission cases will not exceed the SAR limit. Therefore, no volumetric SAR summation is required per FCC KDB Publication 648474.

11. Configuring 802.11 a/b/g Transmitters for SAR Measurement

SAR Testing with IEEE 802.11 a/b/g Transmitters

Normal network operating configurations are not suitable for measuring the SAR of 802.11 a/b/g transmitters. Unpredictable in network traffic and antenna diversity conditions can introduce undesirable variations in SAR results. The SAR for these devices should be measured using chipset based test mode software to ensure the results are consistent and reliable.

General Device Setup

Chipset based test mode software is hardware dependent and generally varies among manufacturers. The device operating parameters established in test mode for SAR measurements must be identical to those programmed in production units, including output power levels, amplifier gain settings and other RF performance tuning parameters. The test frequencies should correspond to actual channel frequencies defined for domestic use. SAR for devices with switched diversity should be measured with only one antenna transmitting at a time during each SAR measurement, according to a fixed modulation and data rate. The same data pattern should be used for all measurements.

Frequency Channel Configurations

802.11 a/b/g and 4.9 GHz operation modes are tested independently according to the service requirements in each frequency band. 802.11 b/g modes are tested on channels 1, 6 and 11. 802.11a is tested for UNII operations on channels 36 and 48 in the 5.15-5.25 GHz Band; channels 52 and 64 in the 5.25-5.35 GHz band; channels 104, 116, 124 and 136 in the 5.470-5.725 GHz BAND; and channel 149 and 161 in the 5.8 GHz band. When 5.8 GHz § 15.247 is also available, channels 149, 157 and 165 should be tested of the UNII channels. 4.9 GHz is tested on channels 1., 10 and 5 or 6, whichever has the higher output power, for 5 MHz channels; channels 11, 15 and 19 for 10 MHz channels; and channels 21 and 25 for 20 MHz channels. These are referred to as the “default test channels”. 802.11g mode was evaluated only if the output power was 0.25 dB higher than the 802.11b mode.

Table 11.1 802.11 Test channels per FCC Requirements

Mode	GHz	Channel	Turbo Channel	“Default Test Channels”				
				§15.247		UNII		
				802.11b	802.11g			
802.11 b/g	2.412	1*		√	∇			
	2.437	6	6	√	∇			
	2.462	11*		√	∇			
802.11a	5.18	36				√		
	5.20	40	42 (5.21 GHz)				*	
	5.22	44					*	
	5.24	48	50 (5.25 GHz)			√		
	5.26	52				√		
	5.28	56	58 (5.29 GHz)				*	
	5.30	60					*	
	5.32	64				√		
	5.500	100	Unknown				*	
	5.520	104				√	*	
	5.540	108					*	
	5.560	112					*	
	5.580	116					√	
	5.600	120					*	
	5.620	124					√	
	5.640	128					*	
	5.660	132					*	
	5.680	136					√	*
	5.700	140				*		
	UNII or §15.247	5.745	149		√		√	
5.765		153	152 (5.76 GHz)		*		*	
5.785		157		√			*	
§15.247	5.805	161	160 (5.80 GHz)		*	√		
§15.247	5.825	165		√				

12. SAR CONSIDERATIONS

12.1 SAR Test Configurations

Mode	Mobile Hotspot Sides for SAR Testing					
	Top	Bottom	Front	Rear	Right	Left
GSM850	X	O	O	O	O	O
PCS1900	X	O	O	O	O	O
W-LAN(802.11b)	O	X	O	O	O	X

Table 12.1 Mobile Hotspot Sides for SAR Testing

12.2 Antenna Distance

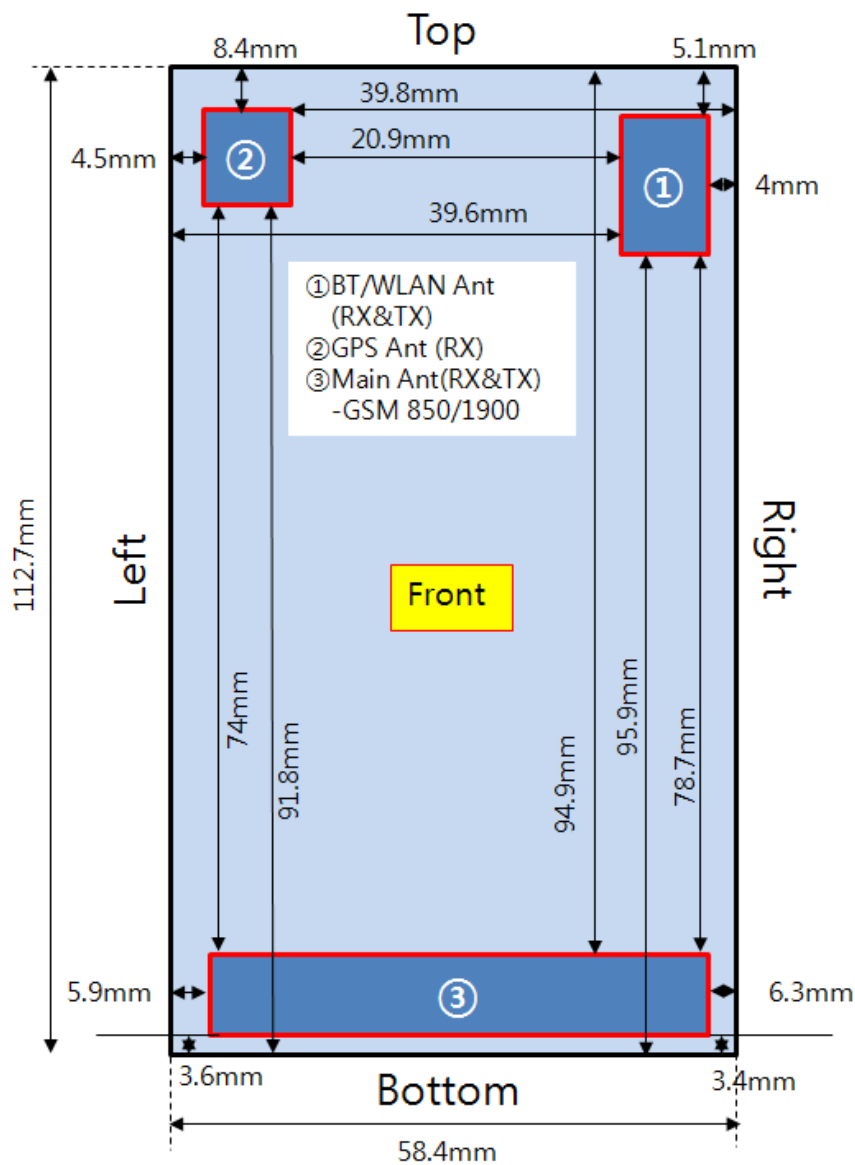

Figure 12.1 Identification of Sides for SAR Testing

Note: Per FCC KDB Publication 941225 D06, The edges with antennas within 2.5 cm are required to be evaluated for SAR. See Figure 12.1 distances of the actual device.

13. SAR TEST DATA SUMMARY AND POWER TABLE

See Measurement Result Data Pages

Procedures Used To Establish Test Signal

The EUT was placed into simulated call mode (GSM850, PCS1900, W-LAN (802.11b)) using manufacturers test codes. Such test signals offer a consistent means for testing SAR and are recommended for evaluating SAR. When test modes are not available or inappropriate for testing a EUT, the actual transmission is activated through a base station simulator or similar equipment. See data pages for actual procedure used in measurement.

Also this EUT was tested WLAN test program to control DUT. The channel was selected at Low, Middle, and High channel. The output power level was set to rated max output power using the WLAN test program. This output power level was measured and recorded on the report as a begin power.

Device Test Conditions

The EUT is battery operated. Each SAR measurement was taken with a fully charged battery.

In order to verify that the device was tested at full power, conducted output power measurements were performed before and after each SAR measurement to confirm the output power. If a conducted power deviation of more than 5% occurred, the test was repeated.

Max. Power Output Table for LG-P692 (GSM)

Band	Channel	Output Power (dBm)								
		GSM	GPRS 1 TX Slot	GPRS 2 TX Slot	GPRS 3 TX Slot	GPRS 4 TX Slot	EDGE 1TX Slot	EDGE 2TX Slot	EDGE 3TX Slot	EDGE 4TX Slot
GSM 850	128	33.1	33.1	30.9	28.9	28.0	27.6	25.5	23.5	22.5
	190	32.9	32.9	30.7	28.7	27.8	27.3	25.4	23.4	22.3
	251	32.8	32.7	30.6	28.5	27.6	27.2	25.2	23.2	22.2
GSM 1900	512	30.2	30.2	28.0	26.0	24.9	26.7	24.5	22.6	21.6
	661	30.1	30.1	27.5	25.5	24.6	26.1	24.1	22.1	21.1
	810	29.8	29.7	27.2	25.2	24.3	25.7	23.7	21.7	20.7

Table 13.1 The power was measured E5515C

Calculated Max Frame-Averaged Output Table for LG-P692 (GSM)

Band	Channel	Output Power (dBm)								
		GSM	GPRS 1 TX Slot	GPRS 2 TX Slot	GPRS 3 TX Slot	GPRS 4 TX Slot	EDGE 1TX Slot	EDGE 2TX Slot	EDGE 3TX Slot	EDGE 4TX Slot
GSM 850	128	24.07	24.07	24.88	24.64	24.99	18.57	19.48	19.24	19.49
	190	23.87	23.87	24.68	24.44	24.79	18.27	19.38	19.14	19.29
	251	23.77	23.67	24.58	24.24	24.59	18.17	19.18	18.94	19.19
GSM 1900	512	21.17	21.17	21.98	21.74	21.89	17.67	18.48	18.34	18.59
	661	21.07	21.07	21.48	21.24	21.59	17.07	18.08	17.84	18.09
	810	20.77	20.67	21.18	20.94	21.29	16.67	17.68	17.44	17.69

Max. Power Output Table for LG-P692 (W-LAN)

Mode	Frequency (MHz)	Channel No.	Output Power (dBm) Using the Average Power Meter
802.11b	2412	1	15.023
	2437	6	15.054
	2462	11	15.453
802.11g	2412	1	13.068
	2437	6	13.237
	2462	11	13.613
802.11n	2412	1	11.518
	2437	6	11.621
	2462	11	11.929

Table 13.2 The power was measured the Average Power Meter

Max. Power Output Table for LG-P692 (Bluetooth)

channel	Frequency	Output Power(1Mbps)		Output power (2Mbps)		Output power (3Mbps)	
	(MHz)	(dBm)	(mW)	(dBm)	(mW)	(dBm)	(mW)
Low	2402	7.435	5.540	5.250	3.350	5.249	3.349
Mid	2441	7.836	6.076	5.650	3.673	5.647	3.670
High	2480	7.492	5.613	5.272	3.367	5.271	3.366

Table 13.3The power was measured the Average Power Meter

14. SAR TEST DATA SUMMARY

14.1 Measurement Results (GSM850 Head SAR Touch)

FREQUENCY		Modulation	Begin Power (dBm)	Drift Power (dB)	Battery	Phantom Position	Antenna Type	SAR (W/kg)
MHz	Ch							
836.6	190(Mid)	GSM850	32.9	0.016	Standard	Left Ear	Internal	0.577
824.2	128(Low)	GSM850	33.1	0.227	Standard	Right Ear	Internal	0.332
836.6	190(Mid)	GSM850	32.9	0.363	Standard	Right Ear	Internal	0.691
848.8	251(High)	GSM850	32.8	0.081	Standard	Right Ear	Internal	0.635
ANSI / IEEE C95.1-2005– SAFETY LIMIT Spatial Peak Uncontrolled Exposure/General Population Exposure						Head 1.6 W/kg (mW/g) averaged over 1 gram		

NOTE:

1. The test data reported are the worst-case SAR value with the antenna-head position set in a typical configuration. Test procedures used are according to FCC/OET Bulletin 65, Supp.C [July 2001].
2. All modes of operation were investigated, and worst-case results are reported.
3. Prior to testing the conducted output power was measured.
4. The EUT is tested 2nd hot-spot peak, if it is less than 2dB below the highest peak.
5. Test Signal Call Mode Continuous Tx On Manu. Test Codes Base Station Simulator
6. Tissue parameters and temperatures are listed on the SAR plots.
7. Liquid tissue depth is 15.0cm.±0.1
8. Justification for reduced test configurations: per FCC/OET Supplement C (July, 2001), if the SAR measured at the middle channel for each test configuration (Left, right, cheek/touch, tilt/ear, extended and retracted) is at least 3.0 dB lower than the SAR limit, testing at the high and low channels is optional for such test configuration(s).

14.2 Measurement Results (GSM850 Head SAR Tilt)

FREQUENCY		Modulation	Begin Power (dBm)	Drift Power (dB)	Battery	Phantom Position	Antenna Type	SAR (W/kg)
MHz	Ch							
836.6	190(Mid)	GSM850	32.9	0.001	Standard	Left Tilt 15°	Internal	0.380
836.6	190(Mid)	GSM850	32.9	-0.027	Standard	Right Tilt 15°	Internal	0.335
ANSI / IEEE C95.1-2005– SAFETY LIMIT Spatial Peak Uncontrolled Exposure/General Population Exposure						Head 1.6 W/kg (mW/g) averaged over 1 gram		

NOTE:

1. The test data reported are the worst-case SAR value with the antenna-head position set in a typical configuration. Test procedures used are according to FCC/OET Bulletin 65, Supp.C [July 2001].
2. All modes of operation were investigated, and worst-case results are reported.
3. Prior to testing the conducted output power was measured.
4. The EUT is tested 2nd hot-spot peak, if it is less than 2dB below the highest peak.
5. Test Signal Call Mode Continuous Tx On Manu. Test Codes Base Station Simulator
6. Tissue parameters and temperatures are listed on the SAR plots.
7. Liquid tissue depth is 15.0cm.±0.1
8. Justification for reduced test configurations: per FCC/OET Supplement C (July, 2001), if the SAR measured at the middle channel for each test configuration (Left, right, cheek/touch, tilt/ear, extended and retracted) is at least 3.0 dB lower than the SAR limit, testing at the high and low channels is optional for such test configuration(s).

14.3 Measurement Results (PCS1900 Head SAR Touch)

FREQUENCY		Modulation	Begin Power (dBm)	Drift Power (dB)	Battery	Phantom Position	Antenna Type	SAR (W/kg)
MHz	Ch							
1850.2	512(Low)	PCS1900	30.2	-0.011	Standard	Left Ear	Internal	0.900
1880.0	661(Mid)	PCS1900	30.1	-0.110	Standard	Left Ear	Internal	0.757
1909.8	810(High)	PCS1900	29.8	-0.030	Standard	Left Ear	Internal	1.080
1880.0	661(Mid)	PCS1900	30.1	-0.301	Standard	Right Ear	Internal	0.572
ANSI / IEEE C95.1-2005– SAFETY LIMIT Spatial Peak Uncontrolled Exposure/General Population Exposure						Head 1.6 W/kg (mW/g) averaged over 1 gram		

NOTE:

1. The test data reported are the worst-case SAR value with the antenna-head position set in a typical configuration. Test procedures used are according to FCC/OET Bulletin 65, Supp.C [July 2001].
2. All modes of operation were investigated, and worst-case results are reported.
3. Prior to testing the conducted output power was measured.
4. The EUT is tested 2nd hot-spot peak, if it is less than 2dB below the highest peak.
5. Test Signal Call Mode Continuous Tx On Manu. Test Codes Base Station Simulator
6. Tissue parameters and temperatures are listed on the SAR plots.
7. Liquid tissue depth is 15.0cm.±0.1
8. Justification for reduced test configurations: per FCC/OET Supplement C (July, 2001), if the SAR measured at the middle channel for each test configuration (Left, right, cheek/touch, tilt/ear, extended and retracted) is at least 3.0 dB lower than the SAR limit, testing at the high and low channels is optional for such test configuration(s).

14.4 Measurement Results (PCS1900 Head SAR Tilt)

FREQUENCY		Modulation	Begin Power (dBm)	Drift Power (dB)	Battery	Phantom Position	Antenna Type	SAR (W/kg)
MHz	Ch							
1880.0	661(Mid)	PCS1900	30.1	0.131	Standard	Left Tilt 15°	Internal	0.231
1880.0	661(Mid)	PCS1900	30.1	0.026	Standard	Right Tilt 15°	Internal	0.256
ANSI / IEEE C95.1-2005– SAFETY LIMIT Spatial Peak Uncontrolled Exposure/General Population Exposure						Head 1.6 W/kg (mW/g) averaged over 1 gram		

NOTE:

1. The test data reported are the worst-case SAR value with the antenna-head position set in a typical configuration. Test procedures used are according to FCC/OET Bulletin 65, Supp.C [July 2001].
2. All modes of operation were investigated, and worst-case results are reported.
3. Prior to testing the conducted output power was measured.
4. The EUT is tested 2nd hot-spot peak, if it is less than 2dB below the highest peak.
5. Test Signal Call Mode Continuous Tx On Manu. Test Codes Base Station Simulator
6. Tissue parameters and temperatures are listed on the SAR plots.
7. Liquid tissue depth is 15.0cm.±0.1
8. Justification for reduced test configurations: per FCC/OET Supplement C (July, 2001), if the SAR measured at the middle channel for each test configuration (Left, right, cheek/touch, tilt/ear, extended and retracted) is at least 3.0 dB lower than the SAR limit, testing at the high and low channels is optional for such test configuration(s).

14.5 Measurement Results (W-LAN(802.11b) Head SAR Touch)

FREQUENCY		Modulation	Begin Power (dBm)	Drift Power (dB)	Battery	Phantom Position	Antenna Type	SAR (W/kg)
MHz	Ch							
2412	1(Low)	802.11b	15.023	-0.146	Standard	Left Ear	Internal	0.415
2437	6(Mid)	802.11b	15.054	0.384	Standard	Left Ear	Internal	0.384
2437	11(High)	802.11b	15.453	0.193	Standard	Left Ear	Internal	0.500
2437	6(Mid)	802.11b	15.054	-0.332	Standard	Right Ear	Internal	0.218
ANSI / IEEE C95.1 2005 – SAFETY LIMIT Spatial Peak Uncontrolled Exposure/General Population Exposure						Head 1.6 W/kg (mW/g) averaged over 1 gram		

NOTE:

- The test data reported are the worst-case SAR value with the antenna-head position set in a typical configuration. Test procedures used are according to FCC/OET Bulletin 65, Supp.C [July 2001].
- All modes of operation were investigated, and worst-case results are reported.
- Prior to testing the conducted output power was measured.
- The EUT is tested 2nd hot-spot peak, if it is less than 2dB below the highest peak.
- Test Signal Call Mode Continuous Tx On Manu. Test Codes Base Station Simulator
- Tissue parameters and temperatures are listed on the SAR plots.
- Liquid tissue depth is 15.0cm.±0.1
- Justification for reduced test configurations: per FCC/OET Supplement C (July, 2001), if the SAR measured at the middle channel for each test configuration (Left, right, cheek/touch, tilt/ear, extended and retracted) is at least 3.0 dB lower than the SAR limit, testing at the high and low channels is optional for such test configuration(s).
- Justification for reduced test configurations for WIFI channels per KDB Publication 248227 and April 2010 FCC/TCB Meeting Notes: Highest average RF output power channel for the lowest data rate were selected for SAR evaluation. Other IEEE 802.11 mode (including 802.11n) were not investigated since the average output power were not greater than 0.25 dB than that of the corresponding channel in the lowest data rate IEEE 802.11b mode.

14.6 Measurement Results (W-LAN(802.11b) Head SAR Tilt)

FREQUENCY		Modulation	Begin Power (dBm)	Drift Power (dB)	Battery	Phantom Position	Antenna Type	SAR (W/kg)
MHz	Ch							
2437	6(Mid)	802.11b	15.054	0.338	Standard	Left Tilt 15°	Internal	0.219
2437	6(Mid)	802.11b	15.054	0.113	Standard	Right Tilt 15°	Internal	0.109
ANSI / IEEE C95.1 2005 – SAFETY LIMIT Spatial Peak Uncontrolled Exposure/General Population Exposure						Head 1.6 W/kg (mW/g) averaged over 1 gram		

NOTE:

- The test data reported are the worst-case SAR value with the antenna-head position set in a typical configuration. Test procedures used are according to FCC/OET Bulletin 65, Supp.C [July 2001].
- All modes of operation were investigated, and worst-case results are reported.
- Prior to testing the conducted output power was measured.
- The EUT is tested 2nd hot-spot peak, if it is less than 2dB below the highest peak.
- Test Signal Call Mode Continuous Tx On Manu. Test Codes Base Station Simulator
- Tissue parameters and temperatures are listed on the SAR plots.
- Liquid tissue depth is 15.0cm.±0.1
- Justification for reduced test configurations: per FCC/OET Supplement C (July, 2001), if the SAR measured at the middle channel for each test configuration (Left, right, cheek/touch, tilt/ear, extended and retracted) is at least 3.0 dB lower than the SAR limit, testing at the high and low channels is optional for such test configuration(s).
- Justification for reduced test configurations for WIFI channels per KDB Publication 248227 and April 2010 FCC/TCB Meeting Notes: Highest average RF output power channel for the lowest data rate were selected for SAR evaluation. Other IEEE 802.11 mode (including 802.11n) were not investigated since the average output power were not greater than 0.25 dB than that of the corresponding channel in the lowest data rate IEEE 802.11b mode.

14.7 Measurement Results (GSM850 GPRS Hotspot Body SAR)

FREQUENCY		Modulation	Begin Power (dBm)	Drift Power (dB)	Configuration	Phantom Position	Antenna Type	SAR (W/kg)
MHz	Ch							
836.6	190(Mid)	GPRS Class 12	27.8	0.235	Bottom	1.0 cm without Holster	Internal	0.095
824.2	128(Low)	GPRS Class 12	28.0	-0.065	Front	1.0 cm without Holster	Internal	0.874
836.6	190(Mid)	GPRS Class 12	27.8	-0.003	Front	1.0 cm without Holster	Internal	0.828
848.8	251(High)	GPRS Class 12	27.6	0.058	Front	1.0 cm without Holster	Internal	0.670
824.2	128(Low)	GSM850	33.1	0.008	Rear	1.0 cm without Holster	Internal	0.647
836.6	190(Mid)	GSM850	32.9	-0.044	Rear	1.0 cm without Holster	Internal	0.926
848.8	251(High)	GSM850	32.8	0.008	Rear	1.0 cm without Holster	Internal	0.786
824.2	128(Low)	GPRS Class 8	33.1	-0.039	Rear	1.0 cm without Holster	Internal	0.625
836.6	190(Mid)	GPRS Class 8	32.9	0.001	Rear	1.0 cm without Holster	Internal	0.885
848.8	251(High)	GPRS Class 8	32.7	-0.029	Rear	1.0 cm without Holster	Internal	0.748
824.2	128(Low)	GPRS Class 10	30.9	-0.028	Rear	1.0 cm without Holster	Internal	1.190
836.6	190(Mid)	GPRS Class 10	30.7	0.033	Rear	1.0 cm without Holster	Internal	1.120
848.8	251(High)	GPRS Class 10	30.6	0.007	Rear	1.0 cm without Holster	Internal	0.916
824.2	128(Low)	GPRS Class 11	28.9	-0.061	Rear	1.0 cm without Holster	Internal	1.180
836.6	190(Mid)	GPRS Class 11	28.7	-0.037	Rear	1.0 cm without Holster	Internal	1.070
848.8	251(High)	GPRS Class 11	28.5	0.054	Rear	1.0 cm without Holster	Internal	0.892
824.2	128(Low)	GPRS Class 12	28.0	0.036	Rear	1.0 cm without Holster	Internal	1.160
836.6	190(Mid)	GPRS Class 12	27.8	-0.136	Rear	1.0 cm without Holster	Internal	1.130
848.8	251(High)	GPRS Class 12	27.6	0.042	Rear	1.0 cm without Holster	Internal	1.020
836.6	190(Mid)	GPRS Class 12	27.8	0.122	Right	1.0 cm without Holster	Internal	0.719
836.6	190(Mid)	GPRS Class 12	27.8	-0.077	Left	1.0 cm without Holster	Internal	0.635
ANSI / IEEE C95.1-2005 – SAFETY LIMIT						Body		
Spatial Peak						1.6 W/kg (mW/g)		
Uncontrolled Exposure/General Population Exposure						averaged over 1 gram		

NOTE:

- The test data reported are the worst-case SAR value with the antenna-body position set in a typical configuration. Test procedures used are according to FCC/OET Bulletin 65, Supp.C [July 2001].
- All modes of operation were investigated, and worst-case results are reported.
- Prior to testing the conducted output power was measured.
- The EUT is tested 2nd hot-spot peak, if it is less than 2dB below the highest peak.
- Battery is fully charged for all readings.
- Test Signal Call Mode Continuous Tx On Manu. Test Codes Base Station Simulator
- Tissue parameters and temperatures are listed on the SAR plots.
- Liquid tissue depth is 15.0cm.±0.1
- Justification for reduced test configurations: per FCC/OET Supplement C (July, 2001), if the SAR measured at the middle channel for each test configuration (Left, right, cheek/touch, tilt/ear, extended and retracted) is at least 3.0 dB lower than the SAR limit, testing at the high and low channels is optional for such test configuration(s).
- Top was not tested since the antenna distance from the edge was greater than 2.5cm per FCC KDB Publication 941225 D06 guidance (see Section 12.1).

14.8 Measurement Results (PCS1900 GPRS Hotspot Body SAR)

FREQUENCY		Modulation	Begin Power (dBm)	Drift Power (dB)	Configuration	Phantom Position	Antenna Type	SAR (W/kg)
MHz	Ch							
1880.0	661(Mid)	GPRS Class 12	24.6	0.029	Bottom	1.0 cm without Holster	Internal	0.307
1880.0	661(Mid)	PCS1900	30.1	-0.034	Front	1.0 cm without Holster	Internal	0.538
1880.0	661(Mid)	GPRS Class 8	30.1	0.017	Front	1.0 cm without Holster	Internal	0.518
1880.0	661(Mid)	GPRS Class 10	27.5	-0.020	Front	1.0 cm without Holster	Internal	0.656
1880.0	661(Mid)	GPRS Class 11	25.5	0.012	Front	1.0 cm without Holster	Internal	0.632
1850.2	512(Low)	GPRS Class 12	24.9	-0.038	Front	1.0 cm without Holster	Internal	0.764
1880.0	661(Mid)	GPRS Class 12	24.6	0.077	Front	1.0 cm without Holster	Internal	0.705
1909.8	810(High)	GPRS Class 12	24.3	0.053	Front	1.0 cm without Holster	Internal	0.641
1880.0	661(Mid)	GPRS Class 12	24.6	-0.058	Rear	1.0 cm without Holster	Internal	0.636
1880.0	661(Mid)	GPRS Class 12	24.6	0.052	Right	1.0 cm without Holster	Internal	0.110
1880.0	661(Mid)	GPRS Class 12	24.6	-0.002	Left	1.0 cm without Holster	Internal	0.235
ANSI / IEEE C95.1-2005– SAFETY LIMIT Spatial Peak Uncontrolled Exposure/General Population Exposure						Body 1.6 W/kg (mW/g) averaged over 1 gram		

NOTE:

- The test data reported are the worst-case SAR value with the antenna-body position set in a typical configuration. Test procedures used are according to FCC/OET Bulletin 65, Supp.C [July 2001].
- All modes of operation were investigated, and worst-case results are reported.
- Prior to testing the conducted output power was measured.
- The EUT is tested 2nd hot-spot peak, if it is less than 2dB below the highest peak.
- Battery is fully charged for all readings.
- Test Signal Call Mode Continuous Tx On Manu. Test Codes Base Station Simulator
- Tissue parameters and temperatures are listed on the SAR plots.
- Liquid tissue depth is 15.0cm.±0.1
- Justification for reduced test configurations: per FCC/OET Supplement C (July, 2001), if the SAR measured at the middle channel for each test configuration (Left, right, cheek/touch, tilt/ear, extended and retracted) is at least 3.0 dB lower than the SAR limit, testing at the high and low channels is optional for such test configuration(s).
- Top was not tested since the antenna distance from the edge was greater than 2.5cm per FCC KDB Publication 941225 D06 guidance (see Section 12.1).

14.9 Measurement Results (W-LAN(802.11b) Body SAR)

FREQUENCY		Modulation	Begin Power (dBm)	Drift Power (dB)	Configuration	Phantom Position	Antenna Type	SAR (W/kg)
MHz	Ch							
2437	6(Mid)	802.11b	15.054	0.281	Top	1.0 cm without Holster	Internal	0.019
2437	6(Mid)	802.11b	15.054	-0.003	Front	1.0 cm without Holster	Internal	0.066
2412	1(Low)	802.11b	15.023	0.073	Rear	1.0 cm without Holster	Internal	0.075
2437	6(Mid)	802.11b	15.054	0.270	Rear	1.0 cm without Holster	Internal	0.093
2462	11(High)	802.11b	15.453	0.366	Rear	1.0 cm without Holster	Internal	0.119
2437	6(Mid)	802.11b	15.054	-0.026	Right	1.0 cm without Holster	Internal	0.076
ANSI / IEEE C95.1-2005– SAFETY LIMIT Spatial Peak Uncontrolled Exposure/General Population Exposure						Body 1.6 W/kg (mW/g) averaged over 1 gram		

NOTE:

- The test data reported are the worst-case SAR value with the antenna-body position set in a typical configuration. Test procedures used are according to FCC/OET Bulletin 65, Supp.C [July 2001].
- All modes of operation were investigated, and worst-case results are reported.
- Prior to testing the conducted output power was measured.
- The EUT is tested 2nd hot-spot peak, if it is less than 2dB below the highest peak.
- Battery is fully charged for all readings.
- Test Signal Call Mode Continuous Tx On Manu. Test Codes Base Station Simulator
- Tissue parameters and temperatures are listed on the SAR plots.
- Liquid tissue depth is 15.0cm.±0.1
- Justification for reduced test configurations: per FCC/OET Supplement C (July, 2001), if the SAR measured at the middle channel for each test configuration (Left, right, cheek/touch, tilt/ear, extended and retracted) is at least 3.0 dB lower than the SAR limit, testing at the high and low channels is optional for such test configuration(s).
- Justification for reduced test configurations for WIFI channels per KDB Publication 248227 and April 2010 FCC/TCB Meeting Notes: Highest average RF output power channel for the lowest data rate were selected for SAR evaluation. Other IEEE 802.11 mode (including 802.11n) were not investigated since the average output power were not greater than 0.25 dB than that of the corresponding channel in the lowest data rate IEEE 802.11b mode.
- Bottom and Right were not tested since the antenna distance from the edge was greater than 2.5cm per FCC KDB Publication 941225 D06 guidance (see Section 12.1).

15.CONCLUSION

Measurement Conclusion

The SAR measurement indicates that the EUT complies with the RF radiation exposure limits of the FCC. These measurements are taken to simulate the RF effects exposure under the worst-case conditions. Precise laboratory measures were taken to assure repeatability of the tests. The tested device complies with the requirements in respect to all parameters subject to the test. The test results and statements relate only to the item(s) tested.

Please note that the absorption and distribution of electromagnetic energy in the body are very complex phenomena that depend on the mass, shape, and size of the body, the orientation of the body with respect to the field vectors, and the electrical properties of both the body and the environment. Other variables that may play a substantial role impossible biological effects are those that characterize the environment (e.g. ambient temperature, air velocity, relative humidity, and body insulation) and those that characterize the individual (e.g. age, gender, activity level, debilitation, or disease).

Because innumerable factors may interact to determine the specific biological outcome of an exposure to electromagnetic fields, any protection guide shall consider maximal amplification of biological effects as a result of field-body interactions, environmental conditions, and physiological variables.

16. REFERENCES

- [1] Federal Communications Commission, ET Docket 93-62, Guidelines for Evaluating the Environmental Effects of Radiofrequency Radiation, Aug. 1996.
- [2] ANSI/IEEE C95.1 - 1992, American National Standard safety levels with respect to human exposure to radiofrequency electromagnetic fields, 300kHz to 100GHz, New York: IEEE, April 2006.
- [3] ANSI/IEEE C95.3 - 2002, IEEE Recommended Practice for the Measurement of Potentially Hazardous Electromagnetic Fields - RF and Microwave, New York: IEEE, December 2002.
- [4] Federal Communications Commission, OET Bulletin 65 (Edition 97-01), Supplement C (Edition 01-01),Evaluating Compliance with FCC Guidelines for Human Exposure to Radiofrequency Electromagnetic Fields, July 2001.
- [5] IEEE Standards Coordinating Committee 34 — IEEE Std. 1528-2003, Recommended Practice for Determining the Peak Spatial-Average Specific Absorption Rate (SAR) in the Human Body Due to Wireless Communications Devices: Experimental Techniques.
- [6] NCRP, National Council on Radiation Protection and Measurements, Biological Effects and Exposure Criteria for Radio Frequency Electromagnetic Fields, NCRP Report No. 86, 1986. Reprinted Feb., 1995.
- [7] T. Schmid, O. Egger, N. Kuster, Automated E-field scanning system for dosimetric assessments, IEEE transaction on Microwave Theory and Techniques, vol. 44, Jan. 1996, pp. 105-113.
- [8] K. Pokovic, T. Schmid, N. Kuster, Robust setup for precise calibration of E-field probes in tissue simulating liquids at mobile communications frequencies, ICECOM97, Oct. 1997, pp. 120-124.
- [9] K. Polovč, T.Schmid, and N. Kuster, E-field Probe with improved isotropy in brain simulating liquids. Proceedings of the ELMAR, Zadar, Croatia, June 23-25, 1996, pp. 172-175.
- [10] Schmid & Partner Engineering AG, Application Note: Data Storage and Evaluation, June 1998, p2.
- [11] V. Hombach, K. Meier, M. Burkhardt, E. Kuhn, N. Kuster, The Dependence of EM Energy Absorption upon Human Head Modeling at 900 MHz, IEEE Transaction on Microwave Theory and Techniques, vol. 44 no. 10,Oct. 1996, pp. 1865-1873.
- [12] N. Kuster and Q. Balzano, Energy absorption mechanism by biological bodies in the near field of dipole antennas above 300MHz, IEEE Transaction on Vehicular Technology, vol. 41, no. 1, Feb. 1992, pp. 17-23.
- [13] G. Hartsgrove, A. Kraszewski, A. Surowiec, Simulated Biological Materials for Electromagnetic Radiation Absorption Studies, University of Ottawa, Bio electromagnetics, Canada: 1987, pp. 29-36.
- [14] Q. Balzano, O. Garay, T. Manning Jr., Electromagnetic Energy Exposure of Simulated Users of Portable Cellular Telephones, IEEE Transactions on Vehicular Technology, vol. 44, no.3, Aug. 1995.
- [15] W. Gander, Computer mathematick, Birkhaeuser, Basel, 1992.
- [16] W.H. Press, S.A. Teukolsky, W.T. Vetterling, and B.P. Flannery, Numerical Receptions in C, The Art of Scientific Computing, Second edition, Cambridge University Press, 1992.

[17] Federal Communications Commission, OET Bulletin 65, Evaluating Compliance with FCC Guidelines for Human Exposure to Radiofrequency Electromagnetic Fields. Supplement C, Dec. 1997.

[18] N. Kuster, R. Kastle, T. Schmid, Dosimetric evaluation of mobile communications equipment with known precision, IEEE Transaction on Communications, vol. E80-B, no. 5, May 1997, pp. 645-652.

[19] CENELEC CLC/SC111B, European Pre standard (prENV 50166-2), Human Exposure to Electromagnetic Fields High-frequency: 10kHz-300GHz, Jan. 1995.

[20] Prof. Dr. Niels Kuster ,ETH,Eidgenössische Technische Hochschule Zürich,Dosimetric Evaluation of the Cellular Phone.

[21] FCC SAR Measurement Procedures for 3G Devices v02, October 2007

[22] SAR Measurement procedures for IEEE 802.11 a/b/g KDB Publication 248227

[23] Guidance PBA for 3GPP R6 HSPA v02r01, December 2009

[24]SAR Test Reduction GSM GPRS EDGE vo1, December 2008

[25]SAR for GSM E GPRS Dual Xfer Mode v01, January 2010

[26]SAR for LTE Devices v01, December 2010

[27] Hot Spot SAR v01, April 2011

[28] UMPC Mini Tablet Devices v01, April 2011

[29] FCC SAR Considerations for Cell Phones with Multiple Transmitters v01r02 #648474, April 2008

[30] 447498 D01 Mobile Portable RF Exposure v04, Published on: Nov 13 2009

[31] 447498 D02 SAR Procedures for Dongle Xmtr v02, Published on: Nov 13 2009