



PCTEST ENGINEERING LABORATORY, INC.

6660-B Dobbin Road, Columbia, MD 21045 USA
Tel. +1.410.290.6652 / Fax +1.410.290.6654
<http://www.pctestlab.com>



SAR COMPLIANCE EVALUATION REPORT FCC CFR § 2.1093 / INDUSTRY CANADA RSS-102

Applicant Name:
LG Electronics MobileComm USA, Inc.
10101 Old Grove Road
San Diego, CA 92131
USA

Date of Testing:
07/18/11 - 08/01/11
Test Site/Location:
PCTEST Lab, Columbia, MD, USA
Test Report Serial No.:
0Y1107191260.ZNF

FCC ID: ZNFP690B
IC CERTIFICATION NO.: 2703C-P690B
APPLICANT: LG ELECTRONICS MOBILECOMM USA, INC.

EUT Type: 850/1900 GSM/GPRS/EDGE/WCDMA Phone with Bluetooth and WLAN
Application Type: Certification
FCC Rule Part(s): CFR §2.1093; FCC/OET Bulletin 65 Supplement C [June 2001]
IC Specification(s): RSS-102 Issue 4; Health Canada Safety Code 6, IEEE 1528, IEC 62209-1, IEC 62209-2
Radio Equipment Type: Cellular Communications Apparatus
Model(s): P690B, LG-P690B, P690b, LG-P690b, LGP690B, LGP690b
IC Model(s): P690b, P690B, LG-P690B, LG-P690b, LGP690B, LGP690b
Test Device Serial No.: Pre-Production [S/N: 1, 3]

Band & Mode	Tx Frequency	Conducted Power [dBm]	SAR		
			1 gm Head (W/kg)	1 gm Body-Worn (W/kg)	1 gm Hotspot (W/kg)
GSM 850	824.20 - 848.80 MHz	33.29	0.33	0.69	0.69
GSM 1900	1850.20 - 1909.80 MHz	30.33	0.34	0.39	0.39
WCDMA 850	826.40 - 846.60 MHz	23.27	0.46	0.61	0.61
WCDMA 1900	1852.4 - 1907.6 MHz	23.31	1.12	0.67	0.67
2.4 GHz WLAN	2412 - 2462 MHz	15.14	0.52	0.09	0.09

All models are confirmed to be identical per the manufacturer.

This wireless portable device has been shown to be capable of compliance for localized specific absorption rate (SAR) for uncontrolled environment/general population exposure limits specified in ANSI/IEEE C95.1-1992 and has been tested in accordance with the measurement procedures specified in FCC/OET Bulletin 65 Supplement C (2001), IEEE 1528-2003 and in applicable Industry Canada Radio Standards Specifications (RSS); for North American frequency bands only.

I attest to the accuracy of data. All measurements reported herein were performed by me or were made under my supervision and are correct to the best of my knowledge and belief. I assume full responsibility for the completeness of these measurements and vouch for the qualifications of all persons taking them. Test results reported herein relate only to the item(s) tested.

PCTEST certifies that no party to this application has been subject to a denial of Federal benefits that includes FCC benefits pursuant to Section 5301 of the Anti-Drug Abuse Act of 1988, 21 U.S.C. 862.



Randy Ortanez
President



FCC ID: ZNFP690B IC Cert No.: 2703C-P690B		SAR COMPLIANCE REPORT INDUSTRY CANADA TECHNICAL REPORT (RSS-102)		Reviewed by: Quality Manager
Filename: 0Y1107191260.ZNF	Test Dates: 07/18/11 - 08/01/11	EUT Type: 850/1900 GSM/GPRS/EDGE/WCDMA Phone with Bluetooth and WLAN		Page 1 of 44

T A B L E O F C O N T E N T S

1	INTRODUCTION	3
2	TEST SITE LOCATION	4
3	SAR MEASUREMENT SETUP	5
4	DASY E-FIELD PROBE SYSTEM	7
5	PROBE CALIBRATION PROCESS	8
6	PHANTOM AND EQUIVALENT TISSUES.....	9
7	DOSIMETRIC ASSESSMENT & PHANTOM SPECS.....	10
8	DEFINITION OF REFERENCE POINTS	11
9	TEST CONFIGURATION POSITIONS	12
10	FCC AND HEALTH CANADA SAFETY CODE 6 RF EXPOSURE LIMITS	15
11	FCC 3G MEASUREMENT PROCEDURES	16
12	SAR TESTING WITH IEEE 802.11 TRANSMITTERS	19
13	FCC PERSONAL WIRELESS ROUTER CONFIGURATIONS.....	22
14	SYSTEM VERIFICATION.....	24
15	SAR DATA SUMMARY	26
16	FCC MULTI-TX AND ANTENNA SAR CONSIDERATIONS.....	36
17	EQUIPMENT LIST.....	40
18	MEASUREMENT UNCERTAINTIES	41
19	CONCLUSION.....	42
20	REFERENCES	43

FCC ID: ZNFP690B IC Cert No.: 2703C-P690B		SAR COMPLIANCE REPORT INDUSTRY CANADA TECHNICAL REPORT (RSS-102)		Reviewed by: Quality Manager
Filename: 0Y1107191260.ZNF	Test Dates: 07/18/11 - 08/01/11	EUT Type: 850/1900 GSM/GPRS/EDGE/WCDMA Phone with Bluetooth and WLAN		Page 2 of 44

1 INTRODUCTION

The FCC and Industry Canada have adopted the guidelines for evaluating the environmental effects of radio frequency (RF) radiation in ET Docket 93-62 on Aug. 6, 1996 and Health Canada Safety Code 6 to protect the public and workers from the potential hazards of RF emissions due to FCC-regulated portable devices. [1]

The safety limits used for the environmental evaluation measurements are based on the criteria published by the American National Standards Institute (ANSI) for localized specific absorption rate (SAR) in IEEE/ANSI C95.1-1992 Standard for Safety Levels with Respect to Human Exposure to Radio Frequency Electromagnetic Fields, 3 kHz to 300 GHz [3] and Health Canada RF Exposure Guidelines Safety Code 6 [24]. The measurement procedure described in IEEE/ANSI C95.3-2002 Recommended Practice for the Measurement of Potentially Hazardous Electromagnetic Fields - RF and Microwave [4] is used for guidance in measuring the Specific Absorption Rate (SAR) due to the RF radiation exposure from the Equipment Under Test (EUT). These criteria for SAR evaluation are similar to those recommended by the International Committee for Non-Ionizing Radiation Protection (ICNIRP) in "Biological Effects and Exposure Criteria for Radiofrequency Electromagnetic Fields," Report No. Vol 74. SAR is a measure of the rate of energy absorption due to exposure to an RF transmitting source. SAR values have been related to threshold levels for potential biological hazards.

1.1 SAR Definition

Specific Absorption Rate is defined as the time derivative (rate) of the incremental energy (dU) absorbed by (dissipated in) an incremental mass (dm) contained in a volume element (dV) of a given density (ρ). It is also defined as the rate of RF energy absorption per unit mass at a point in an absorbing body (see Fig. 1-1).

$$SAR = \frac{d}{dt} \left(\frac{dU}{dm} \right) = \frac{d}{dt} \left(\frac{dU}{\rho dv} \right)$$

Figure 1-1
SAR Mathematical Equation

SAR is expressed in units of Watts per Kilogram (W/kg).

$$SAR = \frac{\sigma \cdot E^2}{\rho}$$

where:

- σ = conductivity of the tissue-simulating material (S/m)
- ρ = mass density of the tissue-simulating material (kg/m^3)
- E = Total RMS electric field strength (V/m)

NOTE: The primary factors that control rate of energy absorption were found to be the wavelength of the incident field in relation to the dimensions and geometry of the irradiated organism, the orientation of the organism in relation to the polarity of field vectors, the presence of reflecting surfaces, and whether conductive contact is made by the organism with a ground plane.[6]

FCC ID: ZNFP690B IC Cert No.: 2703C-P690B		SAR COMPLIANCE REPORT INDUSTRY CANADA TECHNICAL REPORT (RSS-102)		Reviewed by: Quality Manager
Filename: 0Y1107191260.ZNF	Test Dates: 07/18/11 - 08/01/11	EUT Type: 850/1900 GSM/GPRS/EDGE/WCDMA Phone with Bluetooth and WLAN	Page 3 of 44	

2 TEST SITE LOCATION

2.1 INTRODUCTION

The map at the right shows the location of the PCTEST LABORATORY in Columbia, Maryland. It is in proximity to the FCC Laboratory, the Baltimore-Washington International (BWI) airport, the city of Baltimore and Washington, DC.

These measurement tests were conducted at the PCTEST Engineering Laboratory, Inc. facility in New Concept Business Park, Guilford Industrial Park, Columbia, Maryland. The site address is 6660-B Dobbin Road, Columbia, MD 21045. The test site is one of the highest points in the Columbia area with an elevation of 390 feet above mean sea level. The site coordinates are 39° 11'15" N latitude and 76° 49' 38" W longitude. The facility is 1.5 miles north of the FCC laboratory, and the ambient signal and ambient signal strength are approximately equal to those of the FCC laboratory. There are no FM or TV transmitters within 15 miles of the site. The detailed description of the measurement facility was found to be in compliance with the requirements of § 2.948 according to ANSI C63.4 on January 27, 2006 and Industry Canada. PCTEST facility is an IC registered (2451-A) test laboratory with the site description filed to Industry Canada in accordance with Radio Standards Specifications (RSS).

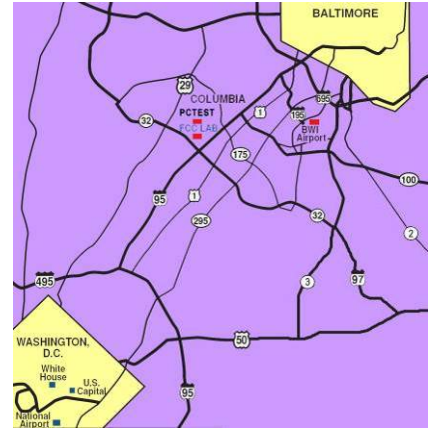

Figure 2-1
Map of the Greater Baltimore and Metropolitan Washington, D.C. area

2.2 Test Facility / Accreditations:

Measurements were performed at an independent accredited PCTEST Engineering Lab located in Columbia, MD 21045, U.S.A.



- PCTEST Lab is accredited to ISO 17025-2005 by the American Association for Laboratory Accreditation (A2LA) in Specific Absorption Rate (SAR) testing, Hearing-Aid Compatibility (HAC), Battery Safety, CTIA Test Plans, and wireless testing for FCC and Industry Canada Rules.
- PCTEST Lab is accredited to ISO 17025 by U.S. National Institute of Standards and Technology (NIST) under the National Voluntary Laboratory Accreditation Program (NVLAP Lab code: 100431-0) in EMC, FCC and Telecommunications.
- PCTEST facility is an FCC registered (PCTEST Reg. No. 90864) test facility with the site description report on file and has met all the requirements specified in Section 2.948 of the FCC Rules and Industry Canada (IC-2451).
- PCTEST Lab is a recognized U.S. Conformity Assessment Body (CAB) in EMC and R&TTE (n.b. 0982) under the U.S.-EU Mutual Recognition Agreement (MRA).
- PCTEST TCB is a Telecommunication Certification Body (TCB) accredited to ISO/IEC Guide 65 by the American National Standards Institute (ANSI) in all scopes of FCC Rules and all Industry Canada Standards (RSS).
- PCTEST facility is an IC registered (IC-2451) test laboratory with the site description on file at Industry Canada.
- PCTEST is a CTIA Authorized Test Laboratory (CATL) for AMPS and CDMA, and EvDO mobile phones.
- PCTEST is a CTIA Authorized Test Laboratory (CATL) for Over-the-Air (OTA) Antenna Performance testing for AMPS, CDMA, GSM, GPRS, EGPRS, UMTS (W-CDMA), CDMA 1xEVDO Data, CDMA 1xRTT Data

FCC ID: ZNFP690B IC Cert No.: 2703C-P690B	 SAR COMPLIANCE REPORT INDUSTRY CANADA TECHNICAL REPORT (RSS-102)			Reviewed by: Quality Manager
Filename: OY1107191260.ZNF	Test Dates: 07/18/11 - 08/01/11	EUT Type: 850/1900 GSM/GPRS/EDGE/WCDMA Phone with Bluetooth and WLAN	Page 4 of 44	

3 SAR MEASUREMENT SETUP

3.1 Robotic System

Measurements are performed using the DASY4 automated dosimetric assessment system. The DASY4 is made by Schmid & Partner Engineering AG (SPEAG) in Zurich, Switzerland and consists of a high precision robotics system (Staubli), robot controller, desktop computer, near-field probe, probe alignment sensor, and the SAM phantom containing the head or body equivalent material. The robot is a six-axis industrial robot, performing precise movements to position the probe to the location (points) of maximum electromagnetic field (EMF) (see Figure 3-1).

3.2 System Hardware

A cell controller system contains the power supply, robot controller, teach pendant (Joystick), and a remote control used to drive the robot motors. The PC consists of the SAR Measurement Software DASY4, A/D interface card, monitor, mouse, and keyboard. The Staubli Robot is connected to the cell controller to allow software manipulation of the robot. A data acquisition electronic (DAE) circuit that performs the signal amplification, signal multiplexing, A/D conversion, offset measurements, mechanical surface detection, collision detection, etc. is connected to the Electro-optical coupler (EOC). The EOC performs the conversion from the optical into digital electric signal from the DAE and transfers data to the PC card.

3.3 System Electronics

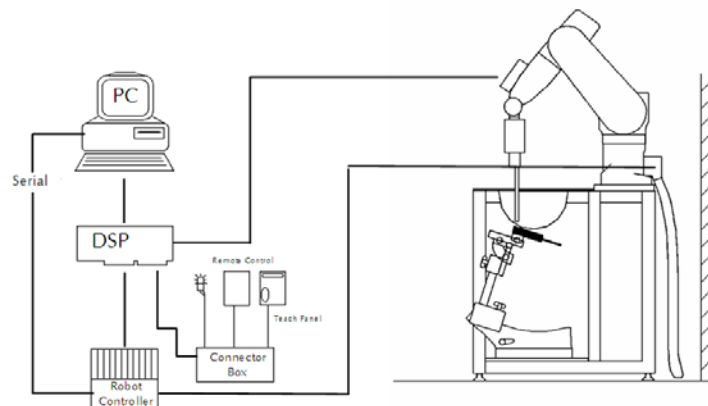

Figure 3-1
SAR Measurement System Setup

The DAE consists of a highly sensitive electrometer-grade auto-zeroing preamplifier, a channel and gain-switching multiplexer, a fast 16 bit AD-converter and a command decoder and control logic unit. Transmission to the PC-card is accomplished through an optical downlink for data and status information and an optical uplink for commands and clock lines. The mechanical probe mounting device includes two different sensor systems for frontal and sidewise probe contacts. They are also used for mechanical surface detection and probe collision detection. The robot uses its own controller with a built in VME-bus computer.

FCC ID: ZNFP690B IC Cert No.: 2703C-P690B	 PCTEST ENGINEERING LABORATORY, INC.	SAR COMPLIANCE REPORT INDUSTRY CANADA TECHNICAL REPORT (RSS-102)	 LG	Reviewed by: Quality Manager
Filename: 0Y1107191260.ZNF	Test Dates: 07/18/11 - 08/01/11	EUT Type: 850/1900 GSM/GPRS/EDGE/WCDMA Phone with Bluetooth and WLAN		Page 5 of 44

3.4 Automated Test System Specifications

Test Software: SPEAG DASY4 version 4.7 Measurement Software
 Robot: Stäubli Unimation Corp. Robot RX60L
 Repeatability: 0.02 mm
 No. of Axes: 6

Data Acquisition Electronic System (DAE)

Data Converter

Features: Signal Amplifier, multiplexer, A/D converter & control logic
 Software: SEMCAD software
 Connecting Lines: Optical Downlink for data and status info
 Optical upload for commands and clock

PC Interface Card

Function: Link to DAE
 16-bit A/D converter for surface detection system
 Two Serial & Ethernet link to robotics
 Direct emergency stop output for robot

Phantom

Type: SAM Twin Phantom (V4.0)
 Shell Material: Composite
 Thickness: 2.0 ± 0.2 mm



Figure 3-2
SAR Measurement System

FCC ID: ZNFP690B IC Cert No.: 2703C-P690B		SAR COMPLIANCE REPORT INDUSTRY CANADA TECHNICAL REPORT (RSS-102)	 Reviewed by: Quality Manager
Filename: OY1107191260.ZNF	Test Dates: 07/18/11 - 08/01/11	EUT Type: 850/1900 GSM/GPRS/EDGE/WCDMA Phone with Bluetooth and WLAN	Page 6 of 44

4 DASY E-FIELD PROBE SYSTEM

4.1 Probe Measurement System



**Figure 4-1
SAR System**

The SAR measurements were conducted with the dosimetric probe designed in the classical triangular configuration (see Figure 4-3) and optimized for dosimetric evaluation [9]. The probe is constructed using the thick film technique; with printed resistive lines on ceramic substrates. The probe is equipped with an optical multi-fiber line ending at the front of the probe tip. It is connected to the EOC box on the robot arm and provides an automatic detection of the phantom surface. Half of the fibers are connected to a pulsed infrared transmitter, the other half to a synchronized receiver. As the probe approaches the surface, the reflection from the surface produces a coupling from the transmitting to the receiving fibers. This reflection increases first during the approach, reaches maximum and then decreases. If the probe is flatly touching the surface, the coupling is zero. The distance of the coupling maximum to the surface is independent of the surface reflectivity and largely independent of the surface to probe angle. The DASY4 software reads the reflection during a software approach and looks for the

maximum using a 2nd order curve fitting (see Figure 5-1). The approach is stopped at reaching the maximum.

4.2 Probe Specifications

Model(s):	ES3DV2, ES3DV3, EX3DV4
Frequency Range:	10 MHz – 6.0 GHz (EX3DV4) 10 MHz – 4 GHz (ES3DV3, ES3DV2)
Calibration:	In head and body simulating tissue at Frequencies from 300 up to 6000MHz
Linearity:	± 0.2 dB (30 MHz to 6 GHz) for EX3DV4 ± 0.2 dB (30 MHz to 4 GHz) for ES3DV3, ES3DV2
Dynamic Range:	10 mW/kg – 100 W/kg
Probe Length:	330 mm
Probe Tip Length:	20 mm
Body Diameter:	12 mm
Tip Diameter:	2.5 mm (3.9mm for ES3DV3)
Tip-Center:	1 mm (2.0 mm for ES3DV3)
Application:	SAR Dosimetry Testing Compliance tests of mobile phones Dosimetry in strong gradient fields



**Figure 4-2
Near-Field Probe**

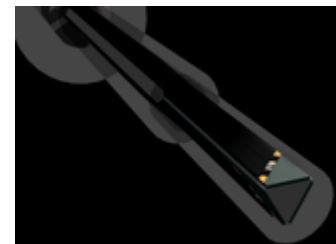

**Figure 4-3
Triangular Probe Configuration**

FCC ID: ZNFP690B IC Cert No.: 2703C-P690B	 PCTEST ENGINEERING LABORATORY, INC.	SAR COMPLIANCE REPORT INDUSTRY CANADA TECHNICAL REPORT (RSS-102)	 LG	Reviewed by: Quality Manager
Filename: OY1107191260.ZNF	Test Dates: 07/18/11 - 08/01/11	EUT Type: 850/1900 GSM/GPRS/EDGE/WCDMA Phone with Bluetooth and WLAN	Page 7 of 44	

5 PROBE CALIBRATION PROCESS

5.1 Dosimetric Assessment Procedure

Each E-Probe/Probe Amplifier combination has unique calibration parameters. A TEM cell calibration procedure is conducted to determine the proper amplifier settings to enter in the probe parameters. The amplifier settings are determined for a given frequency by subjecting the probe to a known E-field density (1 mW/cm²) using an RF Signal generator, TEM cell, and RF Power Meter.

5.2 Free Space Assessment

The free space E-field from amplified probe outputs is determined in a test chamber. This calibration can be performed in a TEM cell if the frequency is below 1 GHz and in a waveguide or other methodologies above 1 GHz for free space. For the free space calibration, the probe is placed in the volumetric center of the cavity and at the proper orientation with the field. The probe is rotated 360 degrees until the three channels show the maximum reading. The power density readings equates to 1 mW/cm².

5.3 Temperature Assessment

E-field temperature correlation calibration is performed in a flat phantom filled with the appropriate simulated head tissue. The E-field in the medium correlates with the temperature rise in the dielectric medium. For temperature correlation calibration a RF transparent thermistor-based temperature probe is used in conjunction with the E-field probe.

$$SAR = C \frac{\Delta T}{\Delta t}$$

where:

- Δt = exposure time (30 seconds),
- C = heat capacity of tissue (brain or muscle),
- ΔT = temperature increase due to RF exposure.

$$SAR = \frac{|E|^2 \cdot \sigma}{\rho}$$

where:

- σ = simulated tissue conductivity,
- ρ = Tissue density (1.25 g/cm³ for brain tissue)

SAR is proportional to $\Delta T/\Delta t$, the initial rate of tissue heating, before thermal diffusion takes place. The electric field in the simulated tissue can be used to estimate SAR by equating the thermally derived SAR to that with the E- field component.

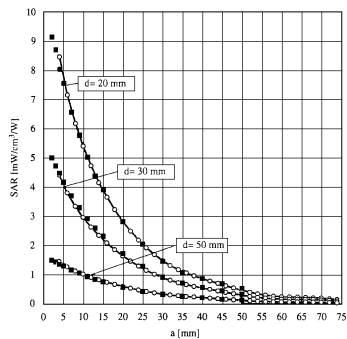

Figure 5-1 E-Field and Temperature measurements at 900MHz [9]

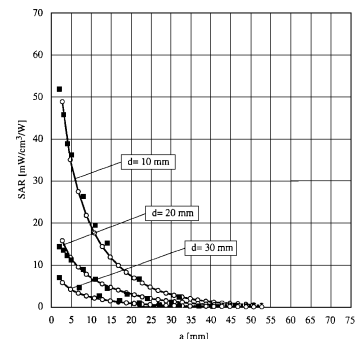

Figure 5-2 E-Field and temperature measurements at 1.9GHz [9]

FCC ID: ZNFP690B IC Cert No.: 2703C-P690B		SAR COMPLIANCE REPORT INDUSTRY CANADA TECHNICAL REPORT (RSS-102)		Reviewed by: Quality Manager
Filename: 0Y1107191260.ZNF	Test Dates: 07/18/11 - 08/01/11	EUT Type: 850/1900 GSM/GPRS/EDGE/WCDMA Phone with Bluetooth and WLAN		Page 8 of 44

6 PHANTOM AND EQUIVALENT TISSUES

6.1 SAM Phantoms



**Figure 6-1
SAM Phantoms**

The SAM Twin Phantom V4.0 is constructed of a fiberglass shell integrated in a table. The shape of the shell is based on data from an anatomical study designed to represent the 90th percentile of the population [12][13]. The phantom enables the dosimetric evaluation of SAR for both left and right handed handset usage, as well as body-worn usage using the flat phantom region. Reference markings on the Phantom allow the complete setup of all predefined phantom positions and measurement grids by manually teaching three points in the robot. The shell phantom has a 2mm shell thickness (except the ear region where shell thickness increases to 6 mm).

6.2 Tissue Simulating Mixture Characterization

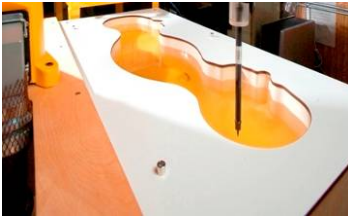

**Figure 6-2
SAM Phantom with
Simulating Tissue**

The mixture is characterized to obtain proper dielectric constant (permittivity) and conductivity of the tissue of interest. The tissue dielectric parameters recommended in IEEE 1528 and IEC 62209 have been used as targets for the compositions, and are to match within 5%, per the FCC recommendations.

**Table 6-1
Composition of the Tissue Equivalent Matter**

Frequency (MHz)	835	835	1900	1900	2450	2450
Tissue	Head	Body	Head	Body	Head	Body
Ingredients (% by weight)						
Bactericide	0.1	0.1				
DGBE			44.92	29.44	7.99	26.7
HEC	1	1				
NaCl	1.45	0.94	0.18	0.39	0.16	0.1
Sucrose	57	44.9				
Triton X-100					19.97	
Water	40.45	53.06	54.9	70.17	71.88	73.2

FCC ID: ZNFP690B IC Cert No.: 2703C-P690B		SAR COMPLIANCE REPORT INDUSTRY CANADA TECHNICAL REPORT (RSS-102)		Reviewed by: Quality Manager
Filename: OY1107191260.ZNF	Test Dates: 07/18/11 - 08/01/11	EUT Type: 850/1900 GSM/GPRS/EDGE/WCDMA Phone with Bluetooth and WLAN	Page 9 of 44	

7 DOSIMETRIC ASSESSMENT & PHANTOM SPECS

7.1 Measurement Procedure

The evaluation was performed using the following procedure:

1. The SAR distribution at the exposed side of the head was measured at a distance no greater than 5.0 mm from the inner surface of the shell. The area covered the entire dimension of the head and the horizontal grid spacing was 15mm x 15mm.
2. The point SAR measurement was taken at the maximum SAR region determined from Step 1 to enable the monitoring of SAR fluctuations/drifts during testing the 1 gram cube. This fixed point was measured and used as a reference value.
3. Based on the area scan data, the area of the maximum absorption was determined by spline interpolation. Around this point, a volume of 32mm x 32mm x 30mm (fine resolution volume scan, zoom scan) was assessed by measuring 5 x 5 x 7 points. On this basis of this data set, the spatial peak SAR value was evaluated with the following procedure (see references or the DASY manual for more details):
 - a. The data was extrapolated to the surface of the outer-shell of the phantom. The combined distance extrapolated was the combined distance from the center of the dipoles 2.7mm away from the tip of the probe housing plus the 1.2 mm distance between the surface and the lowest measuring point. The extrapolation was based on a least-squares algorithm. A polynomial of the fourth order was calculated through the points in the z-axis (normal to the phantom shell).
 - b. After the maximum interpolated values were calculated between the points in the cube, the SAR was averaged over the spatial volume (1g or 10g) using a 3D-Spline interpolation algorithm. The 3D-spline is composed of three one-dimensional splines with the "Not a knot" condition (in x, y, and z directions). The volume was then integrated with the trapezoidal algorithm. One thousand points (10 x 10 x 10) were obtained through interpolation, in order to calculate the averaged SAR.
 - c. All neighboring volumes were evaluated until no neighboring volume with a higher average value was found.
4. The SAR reference value, at the same location as step 2, was re-measured after the zoom scan was complete. If the value deviated by more than 5%, the evaluation was repeated.

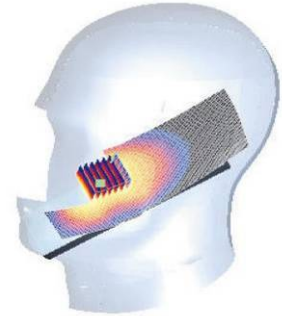

Figure 7-1
Sample SAR Area Scan

7.2 Specific Anthropomorphic Mannequin (SAM) Specifications

The phantom for handset SAR assessment testing is a low-loss dielectric shell, with shape and dimensions derived from the anthropometric data of the 90th percentile adult male head dimensions as tabulated by the US Army. The SAM Twin Phantom shell is bisected along the mid-sagittal plane into right and left halves (see Figure 7-2). The perimeter sidewalls of each phantom halves are extended to allow filling with liquid to a depth that is sufficient to minimize reflections from the upper surface. The liquid depth is maintained at a minimum depth of 15 cm.



Figure 7-2
SAM Twin Phantom Shell

FCC ID: ZNFP690B IC Cert No.: 2703C-P690B		SAR COMPLIANCE REPORT INDUSTRY CANADA TECHNICAL REPORT (RSS-102)		Reviewed by: Quality Manager
Filename: OY1107191260.ZNF	Test Dates: 07/18/11 - 08/01/11	EUT Type: 850/1900 GSM/GPRS/EDGE/WCDMA Phone with Bluetooth and WLAN		Page 10 of 44

8

DEFINITION OF REFERENCE POINTS

8.1 EAR REFERENCE POINT

Figure 8-1 shows the front, back and side views of the SAM Twin Phantom. The point “M” is the reference point for the center of the mouth, “LE” is the left ear reference point (ERP), and “RE” is the right ERP. The ERP is 15mm posterior to the entrance to the ear canal (EEC) along the B-M line (Back-Mouth), as shown in Figure 8-1. The plane passing through the two ear canals and M is defined as the Reference Plane. The line N-F (Neck-Front) is perpendicular to the reference plane and passing through the RE (or LE) is called the Reference Pivoting Line (see Figure 8-2). Line B-M is perpendicular to the N-F line. Both N-F and B-M lines are marked on the external phantom shell to facilitate handset positioning [5].

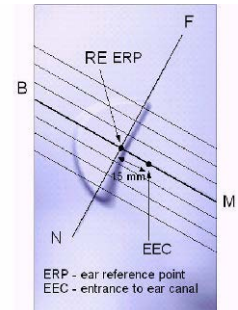

Figure 8-1
Close-Up Side view of ERP

8.2 HANDSET REFERENCE POINTS

Two imaginary lines on the handset were established: the vertical centerline and the horizontal line. The test device was placed in a normal operating position with the “test device reference point” located along the “vertical centerline” on the front of the device aligned to the “ear reference point” (See Figure 8-3). The “test device reference point” was then located at the same level as the center of the ear reference point. The test device was positioned so that the “vertical centerline” was bisecting the front surface of the handset at its top and bottom edges, positioning the “ear reference point” on the outer surface of the both the left and right head phantoms on the ear reference point.



Figure 8-2
Front, back and side view of SAM Twin Phantom

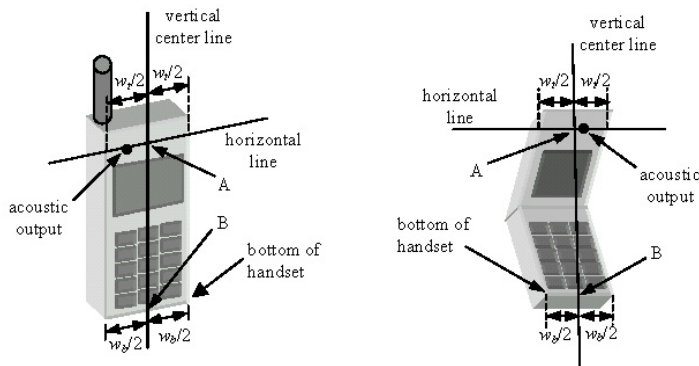



Figure 8-3
Handset Vertical Center & Horizontal Line Reference Points

FCC ID: ZNFP690B IC Cert No.: 2703C-P690B		SAR COMPLIANCE REPORT INDUSTRY CANADA TECHNICAL REPORT (RSS-102)		Reviewed by: Quality Manager
Filename: OY1107191260.ZNF	Test Dates: 07/18/11 - 08/01/11	EUT Type: 850/1900 GSM/GPRS/EDGE/WCDMA Phone with Bluetooth and WLAN		Page 11 of 44

9 TEST CONFIGURATION POSITIONS

9.1 Device Holder

The DASY device holder has been made out of low-loss POM material having the following dielectric parameters: relative permittivity $\epsilon = 3$ and loss tangent $\delta = 0.02$.

9.2 Positioning for Cheek/Touch

1. The test device was positioned with the handset close to the surface of the phantom such that point A is on the (virtual) extension of the line passing through points RE and LE on the phantom (see Figure 9-1), such that the plane defined by the vertical center line and the horizontal line of the phone is approximately parallel to the sagittal plane of the phantom.

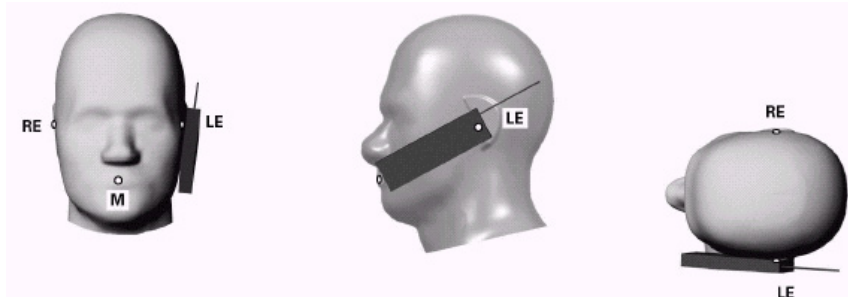

Figure 9-1 Front, Side and Top View of Cheek/Touch Position

2. The handset was translated towards the phantom along the line passing through RE & LE until the handset touches the ear.
3. While maintaining the handset in this plane, the handset was rotated around the LE-RE line until the vertical centerline was in the plane normal to MB-NF including the line MB (reference plane).
4. The phone was then rotated around the vertical centerline until the phone (horizontal line) was symmetrical with respect to the line NF.
5. While maintaining the vertical centerline in the reference plane, keeping point A on the line passing through RE and LE, and maintaining the phone contact with the ear, the handset was rotated about the line NF until any point on the handset made contact with a phantom point below the ear (cheek) (See Figure 9-2).

9.3 Positioning for Ear / 15° Tilt

With the test device aligned in the “Cheek/Touch Position”:

1. While maintaining the orientation of the phone, the phone was retracted parallel to the reference plane far enough to enable a rotation of the phone by 15 degree.
2. The phone was then rotated around the horizontal line by 15 degree.
3. While maintaining the orientation of the phone, the phone was moved parallel to the reference plane until any part of the phone touches the head. (In this position, point A was located on the line RE-LE). The tilted position is obtained when the contact is on the pinna. If the contact was at any location other than the pinna, the angle of the phone would then be reduced. The tilted position was obtained when any part of the phone was in contact of the ear as well as a second part of the phone was in contact with the head (see Figure 9-2).

FCC ID: ZNFP690B IC Cert No.: 2703C-P690B	 PCTEST ENGINEERING LABORATORY, INC.	SAR COMPLIANCE REPORT INDUSTRY CANADA TECHNICAL REPORT (RSS-102)	 LG	Reviewed by: Quality Manager
Filename: OY1107191260.ZNF	Test Dates: 07/18/11 - 08/01/11	EUT Type: 850/1900 GSM/GPRS/EDGE/WCDMA Phone with Bluetooth and WLAN	Page 12 of 44	

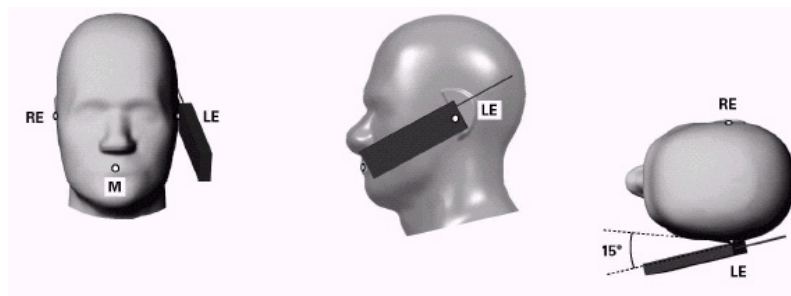

Figure 9-2 Front, Side and Top View of Ear/15° Tilt Position

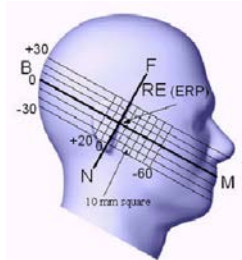

Figure 9-3 Side view w/ relevant markings



Figure 9-4 Body SAR Sample Photo (Not Actual EUT)

9.4 SAR Evaluations near the Mouth/Jaw Regions of the SAM Phantom

Antennas located near the bottom of a phone may require SAR measurements around the mouth and jaw regions of the SAM head phantom. This typically applies to clam-shell style phones that are generally longer in the unfolded normal use positions or to certain older style long rectangular phones. It has been known for some time that there are SAR measurement difficulties in these regions of the SAM phantom. SAR probes are calibrated in tissue equivalent liquids with sufficient separation between the probe sensors and nearby physical boundaries to ensure scattering does not affect probe calibration. When the probe tip is moved into tight regions with multiple boundaries surrounding its sensors, probe calibration and measurement accuracy can become questionable. In addition, these measurement locations often require a probe to be tilted at steep angles, where it may no longer comply with calibration requirements and measurement protocols, or satisfy the required measurement uncertainty. In some situations it is not feasible to tilt the probe or rotate the phantom, as suggested by measurement standards, to conduct these measurements.

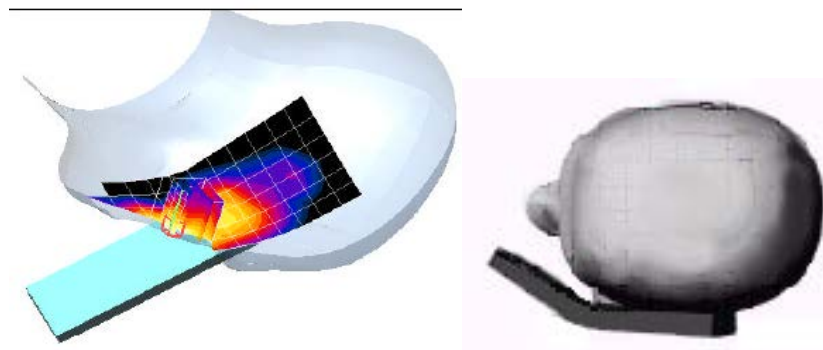



Figure 9-5 SAR Scans near the Jaw/Mouth

In order to ensure there is sufficient conservativeness for ensuring compliance until practical solutions are available, additional measurement considerations are necessary to address these technical difficulties. When measurements are required near the mouth, nose, jaw or similar tight regions of the SAM phantom,

FCC ID: ZNFP690B IC Cert No.: 2703C-P690B	 PCTEST ENGINEERING LABORATORY, INC.	SAR COMPLIANCE REPORT INDUSTRY CANADA TECHNICAL REPORT (RSS-102)	 LG	Reviewed by: Quality Manager
Filename: 0Y1107191260.ZNF	Test Dates: 07/18/11 - 08/01/11	EUT Type: 850/1900 GSM/GPRS/EDGE/WCDMA Phone with Bluetooth and WLAN	Page 13 of 44	

area or zoom scans are often unable to fully enclose the peak SAR location as required by IEEE 1528 and Supplement C, due to probe orientation and positioning difficulties. Even when limited measurements are possible, the test results could be questionable due to probe calibration and measurement uncertainty issues. Under these circumstances, the following procedures apply, adopted from the FCC guidance on SAR handsets document publication 648474. The SAR required in these regions of SAM should be measured using a flat phantom. **Rectangular shaped phones** should be positioned with its bottom edge positioned from the flat phantom with the same distance provided by the cheek touching position using SAM. The ear reference point (ERP, as defined for SAM) of the phone should be positioned ½ cm from the flat phantom shell. **Clam-shell phones** should be positioned with the hinge against a smooth edge of the flat phantom where the upper half of the phone is unfolded and extended beyond the phantom side wall. The lower half of the phone is secured in the test device holder at a fixed distance below the flat phantom determined by the minimum separation along the lower edge of the phone in the cheek touching position using SAM. Any case with substantial variation in separation distance along the lower edge of a clam shell is discussed with the FCC for best-to-use methodology.

The flat phantom data should allow test results to be compared uniformly across measurement systems, until suitable solutions are available in measurement standards to address certain probe calibration and positioning issues, due to implementation differences between horizontal and upright SAM configurations. These flat phantom procedures are only applicable for stand-alone SAR evaluation in tight regions of the SAM phantom, where measurement is not feasible or test results can be questionable due to probe calibration and accessibility issues. Details on device positioning and photos showing how separation distances are determined are included in the SAR report Photographs. SAR for other regions of the head must be evaluated using SAM; therefore, a phone with antennas at different locations may require flat and SAM phantom evaluation for the different antennas.

9.5 Body Holster /Belt Clip Configurations

Body-worn operating configurations are tested with the belt-clips and holsters attached to the device and positioned against a flat phantom in a normal use configuration (see Figure 9-4). A device with a headset output is tested with a headset connected to the device.

Accessories for Body-worn operation configurations are divided into two categories: those that do not contain metallic components and those that do contain metallic components. When multiple accessories that do not contain metallic components are supplied with the device, the device is tested with only the accessory that dictates the closest spacing to the body. Then multiple accessories that contain metallic components are tested with the device with each accessory. If multiple accessories share an identical metallic component (i.e. the same metallic belt-clip used with different holsters with no other metallic components) only the accessory that dictates the closest spacing to the body is tested.

Body-worn accessories may not always be supplied or available as options for some devices intended to be authorized for body-worn use. In this case, a test configuration with a separation distance between the back of the device and the flat phantom is used. Test position spacing was documented. Transmitters that are designed to operate in front of a person's face, as in push-to-talk configurations, are tested for SAR compliance with the front of the device positioned to face the flat phantom in head fluid. For devices that are carried next to the body such as a shoulder, waist or chest-worn transmitters, SAR compliance is tested with the accessories, including headsets and microphones, attached to the device and positioned against a flat phantom in a normal use configuration.

FCC ID: ZNFP690B IC Cert No.: 2703C-P690B		<p style="text-align: center;">SAR COMPLIANCE REPORT INDUSTRY CANADA TECHNICAL REPORT (RSS-102)</p> 	Reviewed by: Quality Manager
Filename: OY1107191260.ZNF			Test Dates: 07/18/11 - 08/01/11

10 FCC AND HEALTH CANADA SAFETY CODE 6 RF EXPOSURE LIMITS

10.1 Uncontrolled Environment

UNCONTROLLED ENVIRONMENTS are defined as locations where there is the exposure of individuals who have no knowledge or control of their exposure. The general population/uncontrolled exposure limits are applicable to situations in which the general public may be exposed or in which persons who are exposed as a consequence of their employment may not be made fully aware of the potential for exposure or cannot exercise control over their exposure. Members of the general public would come under this category when exposure is not employment-related; for example, in the case of a wireless transmitter that exposes persons in its vicinity.

10.2 Controlled Environment

CONTROLLED ENVIRONMENTS are defined as locations where there is exposure that may be incurred by persons who are aware of the potential for exposure, (i.e. as a result of employment or occupation). In general, occupational/controlled exposure limits are applicable to situations in which persons are exposed as a consequence of their employment, who have been made fully aware of the potential for exposure and can exercise control over their exposure. This exposure category is also applicable when the exposure is of a transient nature due to incidental passage through a location where the exposure levels may be higher than the general population/uncontrolled limits, but the exposed person is fully aware of the potential for exposure and can exercise control over his or her exposure by leaving the area or by some other appropriate means.

Table 10-1
SAR Human Exposure Specified in ANSI/IEEE C95.1-1992 and Health Canada Safety Code 6

HUMAN EXPOSURE LIMITS		
	UNCONTROLLED ENVIRONMENT <i>General Population</i> (W/kg) or (mW/g)	CONTROLLED ENVIRONMENT <i>Occupational</i> (W/kg) or (mW/g)
SPATIAL PEAK SAR Brain	1.6	8.0
SPATIAL AVERAGE SAR Whole Body	0.08	0.4
SPATIAL PEAK SAR Hands, Feet, Ankles, Wrists	4.0	20

1. The Spatial Peak value of the SAR averaged over any 1 gram of tissue (defined as a tissue volume in the shape of a cube) and over the appropriate averaging time.
2. The Spatial Average value of the SAR averaged over the whole body.
3. The Spatial Peak value of the SAR averaged over any 10 grams of tissue (defined as a tissue volume in the shape of a cube) and over the appropriate averaging time.

FCC ID: ZNFP690B IC Cert No.: 2703C-P690B	 PCTEST ENGINEERING LABORATORY, INC.	SAR COMPLIANCE REPORT INDUSTRY CANADA TECHNICAL REPORT (RSS-102)	 LG	Reviewed by: Quality Manager
Filename: 0Y1107191260.ZNF	Test Dates: 07/18/11 - 08/01/11	EUT Type: 850/1900 GSM/GPRS/EDGE/WCDMA Phone with Bluetooth and WLAN	Page 15 of 44	

11 FCC 3G MEASUREMENT PROCEDURES

Power measurements were performed using a base station simulator under digital average power.

11.1 Procedures Used to Establish RF Signal for SAR

The following procedures are according to FCC KDB Publication 941225 D01 "SAR Measurement Procedures for 3G Devices" v02, October 2007.

The device was placed into a simulated call using a base station simulator in a RF shielded chamber. Establishing connections in this manner ensure a consistent means for testing SAR and are recommended for evaluating SAR [4]. Devices under test were evaluated prior to testing, with a fully charged battery and were configured to operate at maximum output power. In order to verify that the device was tested throughout the SAR test at maximum output power, the SAR measurement system measures a "point SAR" at an arbitrary reference point at the start and end of the 1 gram SAR evaluation, to assess for any power drifts during the evaluation. Any power drifts of greater than 5% were repeated.

11.2 SAR Measurement Conditions for UMTS per FCC KDB Pub. 941225 D01

11.2.1 Output Power Verification

Maximum output power is measured on the High, Middle and Low channels for each applicable transmission band according to the general descriptions in section 5.2 of 3GPP TS 34.121, using the appropriate RMC or AMR with TPC (transmit power control) set to all "1s".

11.2.2 Head SAR Measurements for Handsets

SAR for head exposure configurations is measured using the 12.2 kbps RMC with TPC bits configured to all "1s". SAR in AMR configurations is not required when the maximum average output of each RF channel for 12.2 kbps AMR is less than 0.25 dB higher than that measured in 12.2 kbps RMC. Otherwise, SAR is measured on the maximum output channel in 12.2 AMR with a 3.4 kbps SRB (signaling radio bearer) using the exposure configuration that resulted in the highest SAR for that RF channel in the 12.2 kbps RMC mode.

11.2.3 Body SAR Measurements

SAR for body exposure configurations is measured using the 12.2 kbps RMC with the TPC bits all "1s".

11.2.4 SAR Measurements for Handsets with Rel 5 HSDPA

Body SAR for HSDPA is not required for handsets with HSDPA capabilities when the maximum average output power of each RF channel with HSDPA active is less than 0.25 dB higher than that measured without HSDPA using 12.2 kbps RMC and the maximum SAR for 12.2 kbps RMC is $\leq 75\%$ of the SAR limit. Otherwise, SAR is measured for HSDPA, using an FRC with H-Set 1 in Sub-test 1 and a 12.2 kbps RMC configured in Test Loop Mode 1, using the highest body SAR configuration measured in 12.2 kbps RMC without HSDPA, on the maximum output channel with the body exposure configuration that resulted in the highest SAR in 12.2 kbps RMC mode for that RF channel.

FCC ID: ZNFP690B IC Cert No.: 2703C-P690B		SAR COMPLIANCE REPORT INDUSTRY CANADA TECHNICAL REPORT (RSS-102)		Reviewed by: Quality Manager
Filename: OY1107191260.ZNF	Test Dates: 07/18/11 - 08/01/11	EUT Type: 850/1900 GSM/GPRS/EDGE/WCDMA Phone with Bluetooth and WLAN	Page 16 of 44	

The H-set used in FRC for HSDPA should be configured according to the UE category of a test device. The number of HS-DSCH/HSPDSCHs, HARQ processes, minimum inter-TTI interval, transport block sizes and RV coding sequence are defined by the applicable H-set. To maintain a consistent test configuration and stable transmission conditions, QPSK is used in the FRC for SAR testing. HS-DPCCH should be configured with a CQI feedback cycle of 2 ms to maintain a constant rate of active CQI slots. DPCCH and DPDCH gain factors of $\beta_c=9$ and $\beta_d=15$, and power offset parameters of $\Delta_{ACK} = \Delta_{NACK} = 5$ and $\Delta_{CQI} = 2$ is used. The CQI value is determined by the UE category, transport block size, number of HS-PDSCHs and modulation used in the FRC.

11.3 RF Conducted Powers

11.3.1 GSM Conducted Powers

		Maximum Burst-Averaged Output Power								
		Voice	GPRS/EDGE Data (GMSK)				EDGE Data (8-PSK)			
Band	Channel	GSM [dBm] CS (1 Slot)	GPRS [dBm] 1 Tx Slot	GPRS [dBm] 2 Tx Slot	GPRS [dBm] 3 Tx Slot	GPRS [dBm] 4 Tx Slot	EDGE [dBm] 1 Tx Slot	EDGE [dBm] 2 Tx Slot	EDGE [dBm] 3 Tx Slot	EDGE [dBm] 4 Tx Slot
Cellular	128	33.26	33.27	30.95	28.95	27.94	27.55	25.56	23.54	22.56
	190	33.29	33.30	30.97	28.98	27.97	27.59	25.60	23.57	22.59
	251	33.28	33.29	30.99	28.96	27.96	27.59	25.59	23.58	22.57
PCS	512	30.27	30.25	28.45	26.47	25.47	26.56	24.54	22.48	21.51
	661	30.33	30.32	28.54	26.55	25.55	26.67	24.63	22.60	21.60
	810	30.29	30.29	28.54	26.58	25.57	26.65	24.66	22.61	21.65

FCC ID: ZNFP690B IC Cert No.: 2703C-P690B		SAR COMPLIANCE REPORT INDUSTRY CANADA TECHNICAL REPORT (RSS-102)		Reviewed by: Quality Manager
Filename: OY1107191260.ZNF	Test Dates: 07/18/11 - 08/01/11	EUT Type: 850/1900 GSM/GPRS/EDGE/WCDMA Phone with Bluetooth and WLAN	Page 17 of 44	

		Calculated Maximum Frame-Averaged Output Power								
		Voice	GPRS/EDGE Data (GMSK)				EDGE Data (8-PSK)			
Band	Channel	GSM [dBm] CS (1 Slot)	GPRS [dBm] 1 Tx Slot	GPRS [dBm] 2 Tx Slot	GPRS [dBm] 3 Tx Slot	GPRS [dBm] 4 Tx Slot	EDGE [dBm] 1 Tx Slot	EDGE [dBm] 2 Tx Slot	EDGE [dBm] 3 Tx Slot	EDGE [dBm] 4 Tx Slot
Cellular	128	24.23	24.24	24.93	24.69	24.93	18.52	19.54	19.28	19.55
	190	24.26	24.27	24.95	24.72	24.96	18.56	19.58	19.31	19.58
	251	24.25	24.26	24.97	24.70	24.95	18.56	19.57	19.32	19.56
PCS	512	21.24	21.22	22.43	22.21	22.46	17.53	18.52	18.22	18.50
	661	21.30	21.29	22.52	22.29	22.54	17.64	18.61	18.34	18.59
	810	21.26	21.26	22.52	22.32	22.56	17.62	18.64	18.35	18.64

Note: Both burst-averaged and calculated frame-averaged powers are included. The bolded GPRS/EDGE modes were selected according to the highest frame-averaged output power table according to KDB 941225 D03.

The output conducted powers of GPRS/EDGE (GMSK) were measured with CS1 while EDGE (8-PSK) was measured with MCS7.

GSM Class: B
GPRS Multislot class: 12 (max 4 Tx Uplink slots)
EDGE Multislot class: 12 (max 4Tx Uplink slots)
DTM Multislot Class: N/A

11.3.2 HSDPA Conducted Powers

3GPP Release Version	Mode	3GPP 34.121 Subtest	WCDMA 850 [dBm]			WCDMA 1900 [dBm]			β_c	β_d	MPR
			4132	4183	4233	9262	9400	9538			
99	WCDMA	12.2 kbps RMC	23.33	23.27	23.15	23.15	23.31	23.23	-	-	-
99		12.2 kbps AMR	23.28	23.22	23.28	23.28	23.24	23.29	-	-	-
5	HSDPA	Subtest 1	23.31	23.14	23.02	23.18	23.26	23.22	2	15	0
5		Subtest 2	23.10	23.04	22.92	23.10	23.25	23.18	11	15	0
5		Subtest 3	22.61	22.58	22.50	22.61	22.81	22.75	15	8	0.5
5		Subtest 4	22.59	22.52	22.47	22.65	22.84	22.78	15	4	0.5

WCDMA mode in Body SAR was tested under RMC 12.2 kbps with HSDPA Inactive per KDB Publication 941225 D01. HSDPA SAR tests were not required since the average output power of the HSDPA subtests was not more than 0.25 dB higher than the RMC level and SAR was less than 1.2 W/kg.

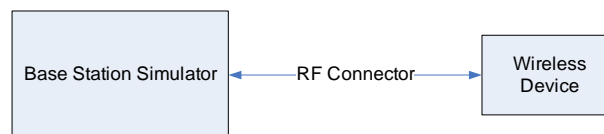

Figure 11-1
Power Measurement Setup

FCC ID: ZNFP690B IC Cert No.: 2703C-P690B		SAR COMPLIANCE REPORT INDUSTRY CANADA TECHNICAL REPORT (RSS-102)		Reviewed by: Quality Manager
Filename: OY1107191260.ZNF	Test Dates: 07/18/11 - 08/01/11	EUT Type: 850/1900 GSM/GPRS/EDGE/WCDMA Phone with Bluetooth and WLAN	Page 18 of 44	

12 SAR TESTING WITH IEEE 802.11 TRANSMITTERS

Normal network operating configurations are not suitable for measuring the SAR of 802.11 a/b/g/n transmitters. Unpredictable fluctuations in network traffic and antenna diversity conditions can introduce undesirable variations in SAR results. The SAR for these devices should be measured using chipset based test mode software to ensure the results are consistent and reliable.

12.1 General Device Setup

Chipset based test mode software is hardware dependent and generally varies among manufacturers. The device operating parameters established in test mode for SAR measurements must be identical to those programmed in production units, including output power levels, amplifier gain settings and other RF performance tuning parameters. The test frequencies should correspond to actual channel frequencies defined for domestic use. SAR for devices with switched diversity should be measured with only one antenna transmitting at a time during each SAR measurement, according to a fixed modulation and data rate. The same data pattern should be used for all measurements.

12.2 Frequency Channel Configurations [27]

802.11 b/g/n are tested independently according to the service requirements in each frequency band. 802.11 b/g modes are tested on channels 1, 6 and 11. These are referred to as the “default test channels”. 802.11g/n modes were evaluated only if the output power was 0.25 dB higher than the 802.11b mode.

**Table 12-1
802.11 Test Channels per FCC Requirements**

Mode	GHz	Channel	Turbo Channel	“Default Test Channels”				
				§15.247		UNII		
				802.11b	802.11g			
802.11 b/g	2.412	1		√	∇			
	2.437	6	6	√	∇			
	2.462	11		√	∇			
802.11a	5.18	36				√		
	5.20	40	42 (5.21 GHz)				*	
	5.22	44					*	
	5.24	48	50 (5.25 GHz)			√		
	5.26	52				√		
	5.28	56	58 (5.29 GHz)				*	
	5.30	60					*	
	5.32	64				√		
	UNII	5.500	100	Unknown				*
		5.520	104				√	*
		5.540	108					*
		5.560	112					*
		5.580	116				√	*
		5.600	120					*
		5.620	124				√	*
		5.640	128					*
		5.660	132					*
		5.680	136				√	*
	UNII or §15.247	5.700	140					*
		5.745	149		√		√	
5.765		153	152 (5.76 GHz)		*		*	
5.785		157		√			*	
5.805		161	160 (5.80 GHz)		*	√		
§15.247	5.825	165		√				

FCC ID: ZNFP690B IC Cert No.: 2703C-P690B		SAR COMPLIANCE REPORT INDUSTRY CANADA TECHNICAL REPORT (RSS-102)		Reviewed by: Quality Manager
Filename: OY1107191260.ZNF	Test Dates: 07/18/11 - 08/01/11	EUT Type: 850/1900 GSM/GPRS/EDGE/WCDMA Phone with Bluetooth and WLAN		Page 19 of 44

Table 12-2
IEEE 802.11b Average RF Power

Freq [MHz]	Channel	Data Rate [Mbps]	Measured Average Power [dBm]
2412	1	1	15
		2	14.97
		5.5	15.06
		11	14.89
2437	6	1	15.03
		2	15.15
		5.5	15.16
		11	15.14
2462	11	1	15.14
		2	15.05
		5.5	15.16
		11	15.05

Table 12-3
IEEE 802.11g Average RF Power

Freq [MHz]	Channel	Data Rate [Mbps]	Measured Average Power [dBm]
2412	1	6	13.14
		9	13.25
		12	13.29
		18	13.05
		24	13.14
		36	13.28
		48	13.17
		54	12.7
2437	6	6	13.09
		9	13.31
		12	13.35
		18	13.24
		24	13.21
		36	13.09
		48	13.18
		54	12.77
2462	11	6	12.9
		9	13.07
		12	13.04
		18	13.24
		24	13.19
		36	13.1
		48	13.23
		54	13.19

FCC ID: ZNFP690B IC Cert No.: 2703C-P690B		SAR COMPLIANCE REPORT INDUSTRY CANADA TECHNICAL REPORT (RSS-102)		Reviewed by: Quality Manager
Filename: OY1107191260.ZNF	Test Dates: 07/18/11 - 08/01/11	EUT Type: 850/1900 GSM/GPRS/EDGE/WCDMA Phone with Bluetooth and WLAN	Page 20 of 44	

**Table 12-4
IEEE 802.11n Average RF Power**

Freq [MHz]	Channel	MCS Index	Data Rate [Mbps]	Measured Average Power [dBm]
2412	1	0	6.5/7.2	11.91
		1	13/14.4	11.99
		2	19.5/21.7	11.87
		3	26/28.9	11.8
		4	39/43.3	11.72
		5	52/57.8	11.7
		6	58.5/65	11.83
		7	65/72.2	12
2437	6	0	6.5/7.2	11.97
		1	13/14.4	11.83
		2	19.5/21.7	11.7
		3	26/28.9	12.19
		4	39/43.3	12.04
		5	52/57.8	12.14
		6	58.5/65	12.12
		7	65/72.2	12
2462	11	0	6.5/7.2	12.03
		1	13/14.4	12.02
		2	19.5/21.7	12
		3	26/28.9	12.03
		4	39/43.3	11.93
		5	52/57.8	11.88
		6	58.5/65	12.11
		7	65/72.2	12.01

Justification for reduced test configurations for WIFI channels per KDB Publication 248227 and April 2010 FCC/TCB Meeting Notes:

- For 2.4 GHz WLAN, Highest average RF output power channel for the lowest data rate were selected for SAR evaluation. Other IEEE 802.11 modes (including 802.11g/n) were not investigated since the average output powers were not greater than 0.25 dB than that of the corresponding channel in the lowest data rate IEEE 802.11b mode.
- The bolded configurations were tested for SAR.

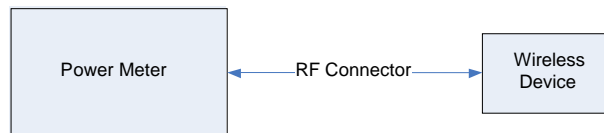

**Figure 12-1
Power Measurement Setup**

FCC ID: ZNFP690B IC Cert No.: 2703C-P690B		SAR COMPLIANCE REPORT INDUSTRY CANADA TECHNICAL REPORT (RSS-102)		Reviewed by: Quality Manager
Filename: OY1107191260.ZNF	Test Dates: 07/18/11 - 08/01/11	EUT Type: 850/1900 GSM/GPRS/EDGE/WCDMA Phone with Bluetooth and WLAN		Page 21 of 44

13 FCC PERSONAL WIRELESS ROUTER CONFIGURATIONS

13.1 Personal Wireless Router Considerations

Some battery-operated handsets have the capability to transmit and receive internet connectivity through simultaneous transmission of WIFI in conjunction with a separate licensed transmitter. The FCC has provided guidance in KDB Publication 941225 D06 where SAR test considerations are based on a composite test separation distance of 10 mm from the edges, front and back of the device ($L \times W \geq 9\text{cm} \times 5\text{cm}$) with antennas 2.5 cm or closer to the edge of the device, determined from general mixed use conditions for this type of devices. Since the hotspot SAR results may overlap with the body-worn accessory SAR requirements, the more conservative configurations can be considered, thus excluding some body-worn accessory SAR tests.

13.2 SAR Test Setup for Personal Wireless Router Features

When the user enables the personal wireless router functions for the handset, actual operations include simultaneous transmission of both the WIFI transmitter and another licensed transmitter. Both transmitters often do not transmit at the same transmitting frequency and thus cannot be evaluated for SAR under actual use conditions. Therefore, SAR must be evaluated for each frequency transmission and mode separately and summed with the WIFI transmitter according to KDB 648474 publication procedures. Therefore, the measurements were performed for each standalone transmitter for the required exposure conditions. The "Portable Hotspot" feature on the handset was NOT activated, to ensure the SAR measurements were valid within a single transmission frequency.

13.3 Power Reduction for Portable Hotspot Mode

This model does not support any power reduction for portable hotspot mode.

FCC ID: ZNFP690B IC Cert No.: 2703C-P690B		SAR COMPLIANCE REPORT INDUSTRY CANADA TECHNICAL REPORT (RSS-102)		Reviewed by: Quality Manager
Filename: 0Y1107191260.ZNF	Test Dates: 07/18/11 - 08/01/11	EUT Type: 850/1900 GSM/GPRS/EDGE/WCDMA Phone with Bluetooth and WLAN		Page 22 of 44

13.4 SAR Test Configurations

**Table 13-1
Mobile Hotspot Sides for SAR Testing**

Mobile Hotspot Sides for SAR Testing						
Mode	Back	Front	Top	Bottom	Right	Left
GPRS 850	Yes	Yes	No	Yes	Yes	Yes
GPRS 1900	Yes	Yes	No	Yes	Yes	Yes
WCDMA 850	Yes	Yes	No	Yes	Yes	Yes
WCDMA 1900	Yes	Yes	No	Yes	Yes	Yes
2.4 GHz WLAN	Yes	Yes	Yes	No	Yes	No

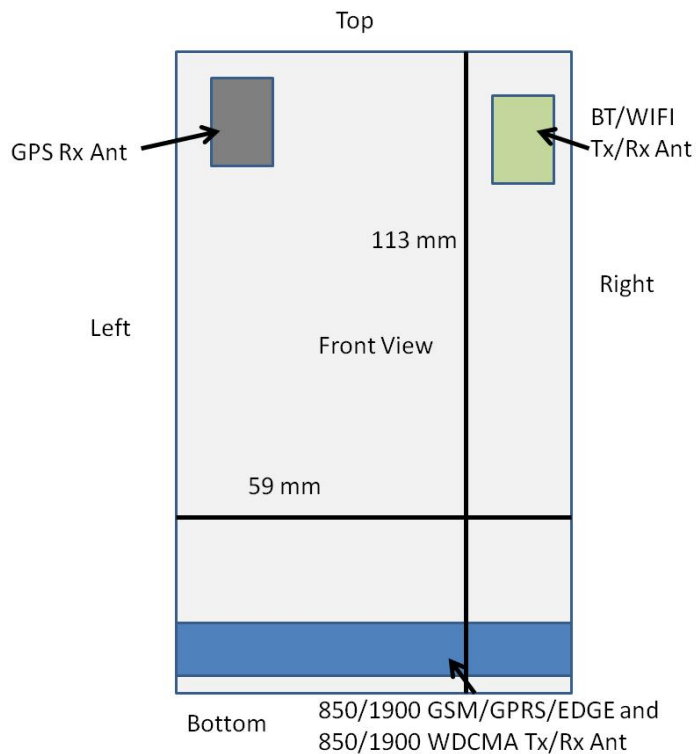

Figure 13-1 Identification of Sides for SAR Testing

Note: Per FCC KDB Publication 941225 D06, the edges with antennas within 2.5 cm are required to be evaluated for SAR. The antenna diagram contains the distances measured from the antennas to the edges of the device.

FCC ID: ZNFP690B IC Cert No.: 2703C-P690B	 PCTEST ENGINEERING LABORATORY, INC.	SAR COMPLIANCE REPORT INDUSTRY CANADA TECHNICAL REPORT (RSS-102)	 LG	Reviewed by: Quality Manager
Filename: 0Y1107191260.ZNF	Test Dates: 07/18/11 - 08/01/11	EUT Type: 850/1900 GSM/GPRS/EDGE/WCDMA Phone with Bluetooth and WLAN	Page 23 of 44	

14 SYSTEM VERIFICATION

14.1 Tissue Verification

**Table 14-1
Measured Tissue Properties**

Calibrated for Tests Performed on:	Tissue Type	Measured Frequency (MHz)	Measured Conductivity, σ (S/m)	Measured Dielectric Constant, ϵ	TARGET Conductivity, σ (S/m)	TARGET Dielectric Constant, ϵ	% dev σ	% dev ϵ
07/18/2011	835H	820	0.855	40.33	0.898	41.571	-4.79%	-2.99%
		835	0.867	40.09	0.900	41.500	-3.67%	-3.40%
		850	0.881	39.88	0.916	41.500	-3.82%	-3.90%
07/21/2011	835B	820	0.977	55.37	0.969	55.284	0.83%	0.16%
		835	0.993	55.29	0.970	55.200	2.37%	0.16%
		850	1.017	55.15	0.988	55.154	2.94%	-0.01%
07/21/2011	1900H	1850	1.403	38.31	1.400	40.000	0.21%	-4.22%
		1880	1.424	38.19	1.400	40.000	1.71%	-4.53%
		1910	1.453	38.03	1.400	40.000	3.79%	-4.93%
07/19/2011	1900B	1850	1.506	52.12	1.520	53.300	-0.92%	-2.21%
		1880	1.521	51.96	1.520	53.300	0.07%	-2.51%
		1910	1.560	51.76	1.520	53.300	2.63%	-2.89%
08/01/2011	2450H	2401	1.710	39.47	1.758	39.298	-2.73%	0.44%
		2450	1.784	38.63	1.800	39.200	-0.89%	-1.45%
		2499	1.856	39.00	1.852	39.135	0.22%	-0.34%
08/01/2011	2450B	2401	1.824	52.07	1.903	52.765	-4.15%	-1.32%
		2450	1.883	52.14	1.950	52.700	-3.44%	-1.06%
		2499	1.931	51.72	2.019	52.638	-4.36%	-1.74%

Note: KDB Publication 450824 was ensured to be applied for probe calibration frequencies greater than or equal to 50 MHz of the DUT frequencies.

The above measured tissue parameters were used in the DASY software to perform interpolation via the DASY software to determine actual dielectric parameters at the test frequencies (per IEEE 1528 6.6.1.2). The SAR test plots may slightly differ from the table above since the DASY software rounds to three significant digits.

14.2 Measurement Procedure for Tissue verification

- 1) The network analyzer and probe system was configured and calibrated.
- 2) The probe was immersed in the sample which was placed in a nonmetallic container. Trapped air bubbles beneath the flange were minimized by placing the probe at a slight angle.
- 3) The complex admittance with respect to the probe aperture was measured
- 4) The complex relative permittivity, for example from the below equation (Pournaropoulos and Misra):

$$Y = \frac{j2\omega\epsilon_r\epsilon_0}{[\ln(b/a)]^2} \int_a^b \int_a^b \int_0^\pi \cos\phi' \frac{\exp[-j\omega r(\mu_0\epsilon_r'\epsilon_0)^{1/2}]}{r} d\phi'd\rho'd\rho$$

where Y is the admittance of the probe in contact with the sample, the primed and unprimed coordinates refer to source and observation points, respectively, $r^2 = \rho^2 + \rho'^2 - 2\rho\rho'\cos\phi'$, ω is the angular frequency, and $j = \sqrt{-1}$.

FCC ID: ZNFP690B IC Cert No.: 2703C-P690B	 PCTEST ENGINEERING LABORATORY, INC.	SAR COMPLIANCE REPORT INDUSTRY CANADA TECHNICAL REPORT (RSS-102)	 LG	Reviewed by: Quality Manager
Filename: OY1107191260.ZNF	Test Dates: 07/18/11 - 08/01/11	EUT Type: 850/1900 GSM/GPRS/EDGE/WCDMA Phone with Bluetooth and WLAN	Page 24 of 44	

14.3 Test System Verification

Prior to assessment, the system is verified to $\pm 10\%$ of the manufacturer SAR measurement on the reference dipole at the time of calibration.

**Table 14-2
System Verification Results**

System Verification TARGET & MEASURED										
Date:	Amb. Temp (°C)	Liquid Temp (°C)	Input Power (W)	Tissue Frequency (MHz)	Dipole SN	Tissue Type	Measured SAR _{1g} (W/kg)	1 W Target SAR _{1g} (W/kg)	1 W Normalized SAR _{1g} (W/kg)	Deviation (%)
07/18/2011	23.3	21.5	0.063	835	4d047	Head	0.625	9.530	9.921	4.10%
07/21/2011	23.6	21.9	0.063	835	4d047	Body	0.636	9.850	10.095	2.49%
07/21/2011	24.8	23.1	0.040	1900	502	Head	1.6	40.200	40.000	-0.50%
07/20/2011	23.9	22.6	0.040	1900	502	Body	1.7	41.100	42.500	3.41%
08/01/2011	23.7	22.3	0.040	2450	797	Head	2.3	53.300	57.500	7.88%
08/01/2011	23.9	22.5	0.040	2450	797	Body	2.18	52.300	54.500	4.21%

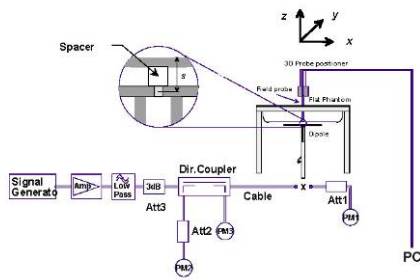

**Figure 14-1
System Verification Setup Diagram**



**Figure 14-2
System Verification Setup Photo**

FCC ID: ZNFP690B IC Cert No.: 2703C-P690B		SAR COMPLIANCE REPORT INDUSTRY CANADA TECHNICAL REPORT (RSS-102)		Reviewed by: Quality Manager
Filename: OY1107191260.ZNF	Test Dates: 07/18/11 - 08/01/11	EUT Type: 850/1900 GSM/GPRS/EDGE/WCDMA Phone with Bluetooth and WLAN		Page 25 of 44

15 SAR DATA SUMMARY

Table 15-1
GSM 850 Head SAR Results

MEASUREMENT RESULTS								
FREQUENCY		Mode/Band	Conducted Power [dBm]	Power Drift [dB]	Side	Test Position	Serial Number	SAR (1g)
MHz	Ch.							(W/kg)
836.60	190	GSM 850	33.29	-0.03	Right	Touch	1	0.334
836.60	190	GSM 850	33.29	0.02	Right	Tilt	1	0.194
836.60	190	GSM 850	33.29	0.00	Left	Touch	1	0.304
836.60	190	GSM 850	33.29	0.01	Left	Tilt	1	0.183
ANSI / IEEE C95.1 1992 - SAFETY LIMIT Spatial Peak Uncontrolled Exposure/General Population					Head 1.6 W/kg (mW/g) averaged over 1 gram			

Notes:

1. The test data reported are the worst-case SAR value with the position set in a typical configuration. Test procedures used were according to FCC/OET Bulletin 65, Supplement C [June 2001], IEEE 1528-2003 and RSS-102.
2. All modes of operation were investigated, and worst-case results are reported.
3. Batteries are fully charged for all readings. Standard battery was used.
4. Tissue parameters and temperatures are listed on the SAR plots.
5. Liquid tissue depth was at least 15.0 cm.
6. Justification for reduced test configurations: Per FCC/OET Bulletin 65 Supplement C (June 2001) and Public Notice DA-02-1438, if the SAR measured at the middle channel for each test configuration (left, right, cheek/touch, tilt/ear, extended and retracted) is at least 3.0 dB lower than the SAR limit, testing at the high and low channels is optional for such test configuration(s).
7. All samples tested were electrically identical per the applicant.

FCC ID: ZNFP690B IC Cert No.: 2703C-P690B	 PCTEST ENGINEERING LABORATORY, INC.	SAR COMPLIANCE REPORT INDUSTRY CANADA TECHNICAL REPORT (RSS-102)	 LG	Reviewed by: Quality Manager
Filename: OY1107191260.ZNF	Test Dates: 07/18/11 - 08/01/11	EUT Type: 850/1900 GSM/GPRS/EDGE/WCDMA Phone with Bluetooth and WLAN	Page 26 of 44	

**Table 15-2
GSM 1900 Head SAR Results**

MEASUREMENT RESULTS								
FREQUENCY		Mode/Band	Conducted Power [dBm]	Power Drift [dB]	Side	Test Position	Serial Number	SAR (1g)
MHz	Ch.							(W/kg)
1880.00	661	GSM 1900	30.33	0.02	Right	Touch	1	0.229
1880.00	661	GSM 1900	30.33	-0.04	Right	Tilt	1	0.133
1880.00	661	GSM 1900	30.33	0.02	Left	Touch	1	0.344
1880.00	661	GSM 1900	30.33	0.02	Left	Tilt	1	0.131
ANSI / IEEE C95.1 1992 - SAFETY LIMIT					Head			
Spatial Peak					1.6 W/kg (mW/g)			
Uncontrolled Exposure/General Population					averaged over 1 gram			

Notes:

1. The test data reported are the worst-case SAR value with the position set in a typical configuration. Test procedures used were according to FCC/OET Bulletin 65, Supplement C [June 2001], IEEE 1528-2003 and RSS-102.
2. All modes of operation were investigated, and worst-case results are reported.
3. Batteries are fully charged for all readings. Standard battery was used.
4. Tissue parameters and temperatures are listed on the SAR plots.
5. Liquid tissue depth was at least 15.0 cm.
6. Justification for reduced test configurations: Per FCC/OET Bulletin 65 Supplement C (June 2001) and Public Notice DA-02-1438, if the SAR measured at the middle channel for each test configuration (left, right, cheek/touch, tilt/ear, extended and retracted) is at least 3.0 dB lower than the SAR limit, testing at the high and low channels is optional for such test configuration(s).
7. All samples tested were electrically identical per the applicant.

FCC ID: ZNFP690B IC Cert No.: 2703C-P690B	 PCTEST <small>ENGINEERING LABORATORY, INC.</small>	SAR COMPLIANCE REPORT INDUSTRY CANADA TECHNICAL REPORT (RSS-102)		Reviewed by: Quality Manager
Filename: OY1107191260.ZNF	Test Dates: 07/18/11 - 08/01/11	EUT Type: 850/1900 GSM/GPRS/EDGE/WCDMA Phone with Bluetooth and WLAN		Page 27 of 44

**Table 15-3
WCDMA 850 Head SAR Results**

MEASUREMENT RESULTS								
FREQUENCY		Mode/Band	Conducted Power [dBm]	Power Drift [dB]	Side	Test Position	Serial Number	SAR (1g)
MHz	Ch.							(W/kg)
836.60	4183	WCDMA 850	23.27	-0.01	Right	Touch	1	0.330
836.60	4183	WCDMA 850	23.27	0.03	Right	Tilt	1	0.195
836.60	4183	WCDMA 850	23.27	0.07	Left	Touch	1	0.455
836.60	4183	WCDMA 850	23.27	0.08	Left	Tilt	1	0.256
ANSI / IEEE C95.1 1992 - SAFETY LIMIT					Head			
Spatial Peak					1.6 W/kg (mW/g)			
Uncontrolled Exposure/General Population					averaged over 1 gram			

Notes:

1. The test data reported are the worst-case SAR value with the position set in a typical configuration. Test procedures used were according to FCC/OET Bulletin 65, Supplement C [June 2001], IEEE 1528-2003 and RSS-102.
2. All modes of operation were investigated, and worst-case results are reported.
3. Batteries are fully charged for all readings. Standard battery was used.
4. Tissue parameters and temperatures are listed on the SAR plots.
5. Liquid tissue depth was at least 15.0 cm.
6. Justification for reduced test configurations: Per FCC/OET Bulletin 65 Supplement C (June 2001) and Public Notice DA-02-1438, if the SAR measured at the middle channel for each test configuration (left, right, cheek/touch, tilt/ear, extended and retracted) is at least 3.0 dB lower than the SAR limit, testing at the high and low channels is optional for such test configuration(s).
7. WCDMA mode was tested under RMC 12.2 kbps with HSDPA Inactive per KDB Publication 941225 D01.
8. All samples tested were electrically identical per the applicant.

FCC ID: ZNFP690B IC Cert No.: 2703C-P690B	 PCTEST <small>ENGINEERING LABORATORY, INC.</small>	SAR COMPLIANCE REPORT INDUSTRY CANADA TECHNICAL REPORT (RSS-102)	 LG	Reviewed by: Quality Manager
Filename: OY1107191260.ZNF	Test Dates: 07/18/11 - 08/01/11	EUT Type: 850/1900 GSM/GPRS/EDGE/WCDMA Phone with Bluetooth and WLAN		Page 28 of 44

**Table 15-4
WCDMA 1900 Head SAR Results**

MEASUREMENT RESULTS								
FREQUENCY		Mode	Conducted Power [dBm]	Power Drift [dB]	Side	Test Position	Serial Number	SAR (1g)
MHz	Ch.							(W/kg)
1880.00	9400	WCDMA 1900	23.31	0.02	Right	Touch	1	0.548
1880.00	9400	WCDMA 1900	23.31	0.03	Right	Tilt	1	0.319
1852.40	9262	WCDMA 1900	23.15	-0.05	Left	Touch	1	1.120
1880.00	9400	WCDMA 1900	23.31	0.02	Left	Touch	1	0.955
1907.60	9538	WCDMA 1900	23.23	-0.07	Left	Touch	1	0.786
1880.00	9400	WCDMA 1900	23.31	-0.03	Left	Tilt	1	0.294
ANSI / IEEE C95.1 1992 - SAFETY LIMIT						Head		
Spatial Peak						1.6 W/kg (mW/g)		
Uncontrolled Exposure/General Population						averaged over 1 gram		

Notes:

1. The test data reported are the worst-case SAR value with the position set in a typical configuration. Test procedures used were according to FCC/OET Bulletin 65, Supplement C [June 2001], IEEE 1528-2003 and RSS-102.
2. All modes of operation were investigated, and worst-case results are reported.
3. Batteries are fully charged for all readings. Standard battery was used.
4. Tissue parameters and temperatures are listed on the SAR plots.
5. Liquid tissue depth was at least 15.0 cm.
6. Justification for reduced test configurations: Per FCC/OET Bulletin 65 Supplement C (June 2001) and Public Notice DA-02-1438, if the SAR measured at the middle channel for each test configuration (left, right, cheek/touch, tilt/ear, extended and retracted) is at least 3.0 dB lower than the SAR limit, testing at the high and low channels is optional for such test configuration(s).
7. WCDMA mode was tested under RMC 12.2 kbps with HSDPA Inactive per KDB Publication 941225 D01.
8. All samples tested were electrically identical per the applicant.

FCC ID: ZNFP690B IC Cert No.: 2703C-P690B	 PCTEST <small>ENGINEERING LABORATORY, INC.</small>	SAR COMPLIANCE REPORT INDUSTRY CANADA TECHNICAL REPORT (RSS-102)	 LG	Reviewed by: Quality Manager
Filename: OY1107191260.ZNF	Test Dates: 07/18/11 - 08/01/11	EUT Type: 850/1900 GSM/GPRS/EDGE/WCDMA Phone with Bluetooth and WLAN		Page 29 of 44

**Table 15-5
2.4 GHz WLAN Head SAR Results**

MEASUREMENT RESULTS										
FREQUENCY		Mode	Service	Conducted Power [dBm]	Power Drift [dB]	Side	Test Position	Serial Number	Data Rate (Mbps)	SAR (1g)
MHz	Ch.									(W/kg)
2462	11	IEEE 802.11b	DSSS	15.14	0.01	Right	Touch	3	1	0.274
2462	11	IEEE 802.11b	DSSS	15.14	0.00	Right	Tilt	3	1	0.083
2462	11	IEEE 802.11b	DSSS	15.14	0.00	Left	Touch	3	1	0.521
2462	11	IEEE 802.11b	DSSS	15.14	-0.02	Left	Tilt	3	1	0.153
ANSI / IEEE C95.1 1992 - SAFETY LIMIT Spatial Peak Uncontrolled Exposure/General Population						Head 1.6 W/kg (mW/g) averaged over 1 gram				

Notes:

1. The test data reported are the worst-case SAR value with the position set in a typical configuration. Test procedures used were according to FCC/OET Bulletin 65, Supplement C [June 2001], IEEE 1528-2003 and RSS-102.
2. All modes of operation were investigated, and worst-case results are reported.
3. Batteries are fully charged for all readings. Standard battery was used.
4. Tissue parameters and temperatures are listed on the SAR plots.
5. Liquid tissue depth was at least 15.0 cm.
6. Justification for reduced test configurations for WIFI channels per KDB Publication 248227 and April 2010 FCC/TCB Meeting Notes: Highest average RF output power channel for the lowest data rate were selected for SAR evaluation. Other IEEE 802.11 modes (including 802.11g/n) were not investigated since the average output powers were not greater than 0.25 dB than that of the corresponding channel in the lowest data rate IEEE 802.11b mode.
7. WLAN transmission was verified using a spectrum analyzer.
8. All samples tested were electrically identical per the applicant.

FCC ID: ZNFP690B IC Cert No.: 2703C-P690B	 PCTEST ENGINEERING LABORATORY, INC.	SAR COMPLIANCE REPORT INDUSTRY CANADA TECHNICAL REPORT (RSS-102)	 LG	Reviewed by: Quality Manager
Filename: OY1107191260.ZNF	Test Dates: 07/18/11 - 08/01/11	EUT Type: 850/1900 GSM/GPRS/EDGE/WCDMA Phone with Bluetooth and WLAN	Page 30 of 44	

**Table 15-6
GSM/WCDMA Body-Worn SAR Results**

MEASUREMENT RESULTS										
FREQUENCY		Mode	Service	Conducted Power [dBm]	Power Drift [dB]	Spacing	Serial Number	# of GPRS Slots	Side	SAR (1g)
MHz	Ch.									(W/kg)
836.60	190	GSM 850	GPRS	30.97	0.01	1.0 cm	1	2	back	0.683
836.60	190	GSM 850	GPRS	28.98	0.01	1.0 cm	1	3	back	0.649
836.60	190	GSM 850	GPRS	27.97	0.01	1.0 cm	1	4	back	0.691
1880.00	661	GSM 1900	GPRS	28.54	-0.03	1.0 cm	1	2	back	0.379
1880.00	661	GSM 1900	GPRS	26.55	0.02	1.0 cm	1	3	back	0.365
1880.00	661	GSM 1900	GPRS	25.55	0.04	1.0 cm	1	4	back	0.393
836.60	4183	WCDMA 850	RMC	23.27	0.00	1.0 cm	1	N/A	back	0.605
1880.00	9400	WCDMA 1900	RMC	23.31	0.06	1.0 cm	1	N/A	back	0.667
ANSI / IEEE C95.1 1992 - SAFETY LIMIT						Body				
Spatial Peak						1.6 W/kg (mW/g)				
Uncontrolled Exposure/General Population						averaged over 1 gram				

Notes:

1. The test data reported are the worst-case SAR value with the position set in a typical configuration. Test procedures used were according to FCC/OET Bulletin 65, Supplement C [June 2001], IEEE 1528-2003 and RSS-102.
2. All modes of operation were investigated, and worst-case results are reported.
3. Tissue parameters and temperatures are listed on the SAR plots.
4. Batteries are fully charged for all readings. Standard battery was used.
5. Liquid tissue depth was at least 15.0 cm.
6. Device was tested using a fixed spacing. A separation distance of 10 mm is chosen because Grantee has determined that it supports the types of body-worn accessories available in the marketplace to users for this handset.
7. WCDMA mode in Body SAR was tested under RMC 12.2 kbps with HSDPA Inactive per KDB Publication 941225 D01. HSDPA SAR was not required since the average output power of the HSDPA subtests was not more than 0.25 dB higher than the RMC level and SAR was less than 1.2 W/kg.
8. Justification for reduced test configurations per KDB Publication 941225: The source-based time-averaged output power was evaluated for all multi-slot operations. In addition to the worst-case reported, all source-based time-averaged powers within 10% of the worst-case were additionally included in the evaluation.
9. Justification for reduced test configurations: Per FCC/OET Bulletin 65 Supplement C (June 2001) and Public Notice DA-02-1438, if the SAR measured at the middle channel for each test configuration is at least 3.0 dB lower than the SAR limit, testing at the high and low channels is optional for such test configuration(s).
10. All samples tested were electrically identical per the applicant.
11. Body-worn is generally intended for voice modes, but since the data modes show a higher frame-averaged output power, GPRS mode was tested in the body-worn condition since it was more conservative.
12. Per FCC KDB Publication 941225 D06, when the same wireless modes and device transmission configurations are required for body-worn accessories and hotspot mode, it is not necessary to additionally test body-worn accessory SAR for the same device orientation. Therefore, the hotspot data for the back side configuration additionally shows body-worn compliance.

FCC ID: ZNFP690B IC Cert No.: 2703C-P690B	 PCTEST ENGINEERING LABORATORY, INC.	SAR COMPLIANCE REPORT INDUSTRY CANADA TECHNICAL REPORT (RSS-102)	 LG	Reviewed by: Quality Manager
Filename: OY1107191260.ZNF	Test Dates: 07/18/11 - 08/01/11	EUT Type: 850/1900 GSM/GPRS/EDGE/WCDMA Phone with Bluetooth and WLAN	Page 31 of 44	

**Table 15-7
Body-Worn 2.4 GHz WLAN SAR Results**

MEASUREMENT RESULTS										
FREQUENCY		Mode	Service	Conducted Power [dBm]	Power Drift [dB]	Spacing	Serial Number	Data Rate (Mbps)	Side	SAR (1g)
MHz	Ch.									(W/kg)
2462	11	IEEE 802.11b	DSSS	15.14	0.03	1.0 cm	3	1	back	0.093
ANSI / IEEE C95.1 1992 - SAFETY LIMIT Spatial Peak Uncontrolled Exposure/General Population						Body 1.6 W/kg (mW/g) averaged over 1 gram				

Notes:

1. The test data reported are the worst-case SAR value with the position set in a typical configuration. Test procedures used were according to FCC/OET Bulletin 65, Supplement C [June 2001], IEEE 1528-2003 and RSS-102.
2. All modes of operation were investigated, and worst-case results are reported.
3. Batteries are fully charged for all readings. Standard battery was used.
4. Tissue parameters and temperatures are listed on the SAR plots.
5. Liquid tissue depth is was at least 15.0 cm.
6. Device was tested using a fixed spacing. A separation distance of 10 mm is chosen because Grantee has determined that it supports the types of body-worn accessories available in the marketplace to users for this handset.
7. Justification for reduced test configurations for WIFI channels per KDB Publication 248227 and April 2010 FCC/TCB Meeting Notes: Highest average RF output power channel for the lowest data rate were selected for SAR evaluation. Other IEEE 802.11 modes (including 802.11g/n) were not investigated since the average output powers were not greater than 0.25 dB than that of the corresponding channel in the lowest data rate IEEE 802.11b mode.
8. WLAN transmission was verified using a spectrum analyzer.
9. All samples tested were electrically identical per the applicant.

FCC ID: ZNFP690B IC Cert No.: 2703C-P690B	 PCTEST ENGINEERING LABORATORY, INC.	SAR COMPLIANCE REPORT INDUSTRY CANADA TECHNICAL REPORT (RSS-102)		Reviewed by: Quality Manager
Filename: OY1107191260.ZNF	Test Dates: 07/18/11 - 08/01/11	EUT Type: 850/1900 GSM/GPRS/EDGE/WCDMA Phone with Bluetooth and WLAN		Page 32 of 44

**Table 15-8
GPRS Hotspot SAR Results**

MEASUREMENT RESULTS										
FREQUENCY		Mode	Service	Conducted Power [dBm]	Power Drift [dB]	Spacing	Serial Number	# of GPRS Slots	Side	SAR (1g)
MHz	Ch.									(W/kg)
836.60	190	GSM 850	GPRS	30.97	0.01	1.0 cm	1	2	back	0.683
836.60	190	GSM 850	GPRS	28.98	0.01	1.0 cm	1	3	back	0.649
836.60	190	GSM 850	GPRS	27.97	0.01	1.0 cm	1	4	back	0.691
836.60	190	GSM 850	GPRS	27.97	-0.03	1.0 cm	1	4	front	0.384
836.60	190	GSM 850	GPRS	27.97	-0.02	1.0 cm	1	4	bottom	0.048
836.60	190	GSM 850	GPRS	27.97	0.00	1.0 cm	1	4	right	0.365
836.60	190	GSM 850	GPRS	27.97	0.02	1.0 cm	1	4	left	0.315
1880.00	661	GSM 1900	GPRS	28.54	-0.03	1.0 cm	1	2	back	0.379
1880.00	661	GSM 1900	GPRS	26.55	0.02	1.0 cm	1	3	back	0.365
1880.00	661	GSM 1900	GPRS	25.55	0.04	1.0 cm	1	4	back	0.393
1880.00	661	GSM 1900	GPRS	25.55	0.00	1.0 cm	1	4	front	0.340
1880.00	661	GSM 1900	GPRS	25.55	0.06	1.0 cm	1	4	bottom	0.289
1880.00	661	GSM 1900	GPRS	25.55	0.03	1.0 cm	1	4	right	0.074
1880.00	661	GSM 1900	GPRS	25.55	0.04	1.0 cm	1	4	left	0.120
ANSI / IEEE C95.1 1992 - SAFETY LIMIT Spatial Peak Uncontrolled Exposure/General Population						Body 1.6 W/kg (mW/g) averaged over 1 gram				

Notes:

- The test data reported are the worst-case SAR value with the position set in a typical configuration. Test procedures used were according to FCC/OET Bulletin 65, Supplement C [June 2001], IEEE 1528-2003 and RSS-102.
- All modes of operation were investigated, and worst-case results are reported.
- Tissue parameters and temperatures are listed on the SAR plots.
- Batteries are fully charged for all readings. Standard battery was used.
- Liquid tissue depth was at least 15.0 cm.
- Device was tested using a fixed spacing.
- Justification for reduced test configurations per KDB Publication 941225 D03: The source-based time-averaged output power was evaluated for all multi-slot operations. In addition to the worst-case reported, all source-based time-averaged powers within 10% of the worst-case were additionally included in the evaluation.
- Justification for reduced test configurations: Per FCC/OET Bulletin 65 Supplement C (June 2001) and Public Notice DA-02-1438, if the SAR measured at the middle channel for each test configuration is at least 3.0 dB lower than the SAR limit, testing at the high and low channels is optional for such test configuration(s).
- All samples tested were electrically identical per the applicant.
- Top Edge was not tested since the antenna distance from the edge was greater than 2.5 cm per FCC KDB Publication 941225 D06 guidance (see Section 13.4).
- SAR evaluation requires a single frequency of measurement for valid measurements using the SAR probe and tissue calibrated which are calibrated for specific limited frequency ranges. Therefore, during SAR evaluation it was ensured that the WIFI transmission was disabled by the manufacturer to assess the standalone SAR to be evaluated for SAR. WIFI SAR was separately evaluated to account for the WIFI SAR for portable hotspot exposure conditions (See Section 13).

FCC ID: ZNFP690B IC Cert No.: 2703C-P690B	 PCTEST <small>ENGINEERING LABORATORY, INC.</small>	SAR COMPLIANCE REPORT INDUSTRY CANADA TECHNICAL REPORT (RSS-102)		Reviewed by: Quality Manager
Filename: OY1107191260.ZNF	Test Dates: 07/18/11 - 08/01/11	EUT Type: 850/1900 GSM/GPRS/EDGE/WCDMA Phone with Bluetooth and WLAN	Page 33 of 44	

**Table 15-9
WCDMA Hotspot SAR Results**

MEASUREMENT RESULTS									
FREQUENCY		Mode	Service	Conducted Power [dBm]	Power Drift [dB]	Spacing	Serial Number	Side	SAR (1g)
MHz	Ch.								(W/kg)
836.60	4183	WCDMA 850	RMC	23.27	0.00	1.0 cm	1	back	0.605
836.60	4183	WCDMA 850	RMC	23.27	-0.05	1.0 cm	1	front	0.346
836.60	4183	WCDMA 850	RMC	23.27	0.02	1.0 cm	1	bottom	0.040
836.60	4183	WCDMA 850	RMC	23.27	0.00	1.0 cm	1	right	0.314
836.60	4183	WCDMA 850	RMC	23.27	0.01	1.0 cm	1	left	0.269
1880.00	9400	WCDMA 1900	RMC	23.31	0.06	1.0 cm	1	back	0.667
1880.00	9400	WCDMA 1900	RMC	23.31	0.00	1.0 cm	1	front	0.539
1880.00	9400	WCDMA 1900	RMC	23.31	0.05	1.0 cm	1	bottom	0.527
1880.00	9400	WCDMA 1900	RMC	23.31	-0.01	1.0 cm	1	right	0.135
1880.00	9400	WCDMA 1900	RMC	23.31	0.09	1.0 cm	1	left	0.207
ANSI / IEEE C95.1 1992 - SAFETY LIMIT						Body			
Spatial Peak						1.6 W/kg (mW/g)			
Uncontrolled Exposure/General Population						averaged over 1 gram			

Notes:

- The test data reported are the worst-case SAR value with the position set in a typical configuration. Test procedures used were according to FCC/OET Bulletin 65, Supplement C [June 2001], IEEE 1528-2003 and RSS-102.
- All modes of operation were investigated, and worst-case results are reported.
- Tissue parameters and temperatures are listed on the SAR plots.
- Batteries are fully charged for all readings. Standard battery was used.
- Liquid tissue depth was at least 15.0 cm.
- Device was tested using a fixed spacing.
- WCDMA mode in Body SAR was tested under RMC 12.2 kbps with HSDPA Inactive per KDB Publication 941225 D01. HSDPA SAR was not required since the average output power of the HSDPA subtests was not more than 0.25 dB higher than the RMC level and SAR was less than 1.2 W/kg.
- Justification for reduced test configurations: Per FCC/OET Bulletin 65 Supplement C (June 2001) and Public Notice DA-02-1438, if the SAR measured at the middle channel for each test configuration is at least 3.0 dB lower than the SAR limit, testing at the high and low channels is optional for such test configuration(s).
- All samples tested were electrically identical per the applicant.
- Top Edge was not tested since the antenna distance from the edge was greater than 2.5 cm per FCC KDB Publication 941225 D06 guidance (see Section 13.4).
- SAR evaluation requires a single frequency of measurement for valid measurements using the SAR probe and tissue calibrated which are calibrated for specific limited frequency ranges. Therefore, during SAR evaluation it was ensured that the WIFI transmission was disabled by the manufacturer to assess the standalone SAR to be evaluated for SAR. WIFI SAR was separately evaluated to account for the WIFI SAR for portable hotspot exposure conditions (See Section 13).

FCC ID: ZNFP690B IC Cert No.: 2703C-P690B	 PCTEST ENGINEERING LABORATORY, INC.	SAR COMPLIANCE REPORT INDUSTRY CANADA TECHNICAL REPORT (RSS-102)	 LG	Reviewed by: Quality Manager
Filename: OY1107191260.ZNF	Test Dates: 07/18/11 - 08/01/11	EUT Type: 850/1900 GSM/GPRS/EDGE/WCDMA Phone with Bluetooth and WLAN		Page 34 of 44

**Table 15-10
Hotspot 2.4 GHz Body SAR Results**

MEASUREMENT RESULTS										
FREQUENCY		Mode	Service	Conducted Power [dBm]	Power Drift [dB]	Spacing	Serial Number	Data Rate (Mbps)	Side	SAR (1g)
MHz	Ch.									(W/kg)
2462	11	IEEE 802.11b	DSSS	15.14	0.03	1.0 cm	3	1	back	0.093
2462	11	IEEE 802.11b	DSSS	15.14	0.08	1.0 cm	3	1	front	0.053
2462	11	IEEE 802.11b	DSSS	15.14	-0.07	1.0 cm	3	1	top	0.012
2462	11	IEEE 802.11b	DSSS	15.14	-0.09	1.0 cm	3	1	right	0.072
ANSI / IEEE C95.1 1992 - SAFETY LIMIT Spatial Peak Uncontrolled Exposure/General Population						Body 1.6 W/kg (mW/g) averaged over 1 gram				

Notes:

1. The test data reported are the worst-case SAR value with the position set in a typical configuration. Test procedures used were according to FCC/OET Bulletin 65, Supplement C [June 2001], IEEE 1528-2003 and RSS-102.
2. All modes of operation were investigated, and worst-case results are reported.
3. Batteries are fully charged for all readings. Standard battery was used.
4. Tissue parameters and temperatures are listed on the SAR plots.
5. Liquid tissue depth is was at least 15.0 cm.
6. Device was tested using a fixed spacing.
7. Justification for reduced test configurations for WIFI channels per KDB Publication 248227 and April 2010 FCC/TCB Meeting Notes: Highest average RF output power channel for the lowest data rate were selected for SAR evaluation. Other IEEE 802.11 modes (including 802.11g/n) were not investigated since the average output powers were not greater than 0.25 dB than that of the corresponding channel in the lowest data rate IEEE 802.11b mode.
8. WLAN transmission was verified using a spectrum analyzer.
9. All samples tested were electrically identical per the applicant.
10. Bottom and Left Edges were not tested since the antenna distance from the edge was greater than 2.5 cm per FCC KDB Publication 941225 D06 (see Section 13.4).

FCC ID: ZNFP690B IC Cert No.: 2703C-P690B	 PCTEST ENGINEERING LABORATORY, INC.	SAR COMPLIANCE REPORT INDUSTRY CANADA TECHNICAL REPORT (RSS-102)	 LG	Reviewed by: Quality Manager
Filename: OY1107191260.ZNF	Test Dates: 07/18/11 - 08/01/11	EUT Type: 850/1900 GSM/GPRS/EDGE/WCDMA Phone with Bluetooth and WLAN	Page 35 of 44	

16 FCC MULTI-TX AND ANTENNA SAR CONSIDERATIONS

16.1 Introduction

The following procedures adopted from “FCC SAR Considerations for Cell Phones with Multiple Transmitters” FCC KDB Publication 648474 are applicable to handsets with built-in unlicensed transmitters such as 802.11a/b/g and Bluetooth devices which may simultaneously transmit with the licensed transmitter. The RSS-102 Issue 4 §3.13 refers to this recommended procedure for such devices.

16.2 FCC Power Tables & Conditions

	2.45	5.15 - 5.35	5.47 - 5.85	GHz
P_{Ref}	12	6	5	mW
Device output power should be rounded to the nearest mW to compare with values specified in this table.				

Figure 16-1
Output Power Thresholds for Unlicensed Transmitters

	Individual Transmitter	Simultaneous Transmission
Licensed Transmitters	<u>Routine evaluation required</u>	SAR not required: <u>Unlicensed only</u>
Unlicensed Transmitters	<p>When there is no simultaneous transmission –</p> <ul style="list-style-type: none"> output $\leq 60/f$: SAR not required output $> 60/f$: stand-alone SAR required <p>When there is simultaneous transmission – <u>Stand-alone SAR not required when</u></p> <ul style="list-style-type: none"> output $\leq 2 \cdot P_{Ref}$ and antenna is ≥ 5.0 cm from other antennas output $\leq P_{Ref}$ and antenna is ≥ 2.5 cm from other antennas output $\leq P_{Ref}$ and antenna is < 2.5 cm from other antennas, each with either output power $\leq P_{Ref}$ or 1-g SAR < 1.2 W/kg <p><u>Otherwise stand-alone SAR is required</u></p> <p>When stand-alone SAR is required</p> <ul style="list-style-type: none"> test SAR on highest output channel for each wireless mode and exposure condition if SAR for highest output channel is $> 50\%$ of SAR limit, evaluate all channels according to normal procedures 	<ul style="list-style-type: none"> when stand-alone 1-g SAR is not required and antenna is ≥ 5 cm from other antennas <p><u>Licensed & Unlicensed</u></p> <ul style="list-style-type: none"> when the sum of the 1-g SAR is < 1.6 W/kg for all simultaneous transmitting antennas when SAR to peak location separation ratio of simultaneous transmitting antenna pair is < 0.3 <p>SAR required: <u>Licensed & Unlicensed</u></p> <p>antenna pairs with SAR to peak location separation ratio ≥ 0.3; test is only required for the configuration that results in the highest SAR in stand-alone configuration for each wireless mode and exposure condition</p> <p>Note: simultaneous transmission exposure conditions for head and body can be different for different style phones; therefore, different test requirements may apply</p>

Figure 16-2
SAR Evaluation Requirements for Multiple Transmitter Handsets

FCC ID: ZNFP690B IC Cert No.: 2703C-P690B		SAR COMPLIANCE REPORT INDUSTRY CANADA TECHNICAL REPORT (RSS-102)		Reviewed by: Quality Manager
Filename: OY1107191260.ZNF	Test Dates: 07/18/11 - 08/01/11	EUT Type: 850/1900 GSM/GPRS/EDGE/WCDMA Phone with Bluetooth and WLAN	Page 36 of 44	

16.3 Multiple Antenna/Transmission Information

The distance between the main antenna and the Bluetooth/WLAN antenna is 78.4 mm. RF Conducted Power of Bluetooth Tx is 7.993 mW. RF Conducted Power of WLAN is 32.81 mW.

16.4 Simultaneous Transmission Analysis

Based on the output power, antenna separation distance and the Body SAR of the dominant transmitter, a stand-alone Bluetooth SAR test is not required while for WLAN it is required.

Bluetooth and WLAN share the same antenna path and cannot transmit simultaneously.

**Table 16-1
Simultaneous Transmission Scenario (Held to Ear)**

Simult Tx	Configuration	GSM 850 SAR (W/kg)	WIFI SAR (W/kg)	Σ SAR (W/kg)	Simult Tx	Configuration	GSM 1900 SAR (W/kg)	WIFI SAR (W/kg)	Σ SAR (W/kg)
Head SAR	Right Cheek	0.334	0.274	0.608	Head SAR	Right Cheek	0.229	0.274	0.503
	Right Tilt	0.194	0.083	0.277		Right Tilt	0.133	0.083	0.216
	Left Cheek	0.304	0.521	0.825		Left Cheek	0.344	0.521	0.865
	Left Tilt	0.183	0.153	0.336		Left Tilt	0.131	0.153	0.284

Simult Tx	Configuration	WCDMA 850 SAR (W/kg)	WIFI SAR (W/kg)	Σ SAR (W/kg)
Head SAR	Right Cheek	0.330	0.274	0.604
	Right Tilt	0.195	0.083	0.278
	Left Cheek	0.455	0.521	0.976
	Left Tilt	0.256	0.153	0.409

Simult Tx	Configuration	WCDMA 1900 SAR (W/kg)	WIFI SAR (W/kg)	Σ SAR (W/kg)	SPLS Ratios per KDB Pub. 648474	Simultaneous Transmission (with Volume Scan) SAR (W/kg)
Head SAR	Right Cheek	0.548	0.274	0.822	N/A	N/A
	Right Tilt	0.319	0.083	0.402	N/A	N/A
	Left Cheek	1.120	0.521	see note 4	0.25	N/A
	Left Tilt	0.294	0.153	0.447	N/A	N/A

Notes:

1. SPLS – SAR Sum to peak location separation
2. The above tables represent held to ear voice calls with WLAN.
3. For numerical sums below 1.6 W/kg, no SAR ratio analysis or aggregate volumetric SAR evaluations for the transmitters were required.
4. No evaluation was performed to determine the aggregate 1-g SAR in this configuration as the SPLS ratio of all antenna pairs was below 0.3 per FCC KDB Publication 648474 D01 (see Section 16.5).

FCC ID: ZNFP690B IC Cert No.: 2703C-P690B		SAR COMPLIANCE REPORT INDUSTRY CANADA TECHNICAL REPORT (RSS-102)			Reviewed by: Quality Manager
Filename: OY1107191260.ZNF	Test Dates: 07/18/11 - 08/01/11	EUT Type: 850/1900 GSM/GPRS/EDGE/WCDMA Phone with Bluetooth and WLAN			Page 37 of 44

Table 16-2
Simultaneous Transmission Scenario (Body-Worn at 1.0 cm)

Configuration	Mode	2G/3G SAR (W/kg)	WIFI SAR (W/kg)	Σ SAR (W/kg)
Back Side	GPRS 850	0.691	0.093	0.784
Back Side	GPRS 1900	0.393	0.093	0.486
Back Side	WCDMA 850	0.605	0.093	0.698
Back Side	WCDMA 1900	0.667	0.093	0.760

Notes:

1. The above table represents a body-worn voice call with WLAN.
2. For numerical sums below 1.6 W/kg, no SAR ratio analysis or aggregate volumetric SAR evaluations for the transmitters were required.

Table 16-3
Simultaneous Transmission Scenario (Hotspot)

Simult Tx	Configuration	GPRS 850 SAR (W/kg)	WIFI SAR (W/kg)	Σ SAR (W/kg)	Simult Tx	Configuration	GPRS 1900 SAR (W/kg)	WIFI SAR (W/kg)	Σ SAR (W/kg)
Body SAR	Back	0.691	0.093	0.784	Body SAR	Back	0.393	0.093	0.486
	Front	0.384	0.053	0.437		Front	0.340	0.053	0.393
	Top	-	0.012	0.012		Top	-	0.012	0.012
	Bottom	0.048	-	0.048		Bottom	0.289	-	0.289
	Right	0.365	0.072	0.437		Right	0.074	0.072	0.146
	Left	0.315	-	0.315		Left	0.120	-	0.120

Simult Tx	Configuration	WCDMA 850 SAR (W/kg)	WIFI SAR (W/kg)	Σ SAR (W/kg)	Simult Tx	Configuration	WCDMA 1900 SAR (W/kg)	WIFI SAR (W/kg)	Σ SAR (W/kg)
Body SAR	Back	0.605	0.093	0.698	Body SAR	Back	0.667	0.093	0.760
	Front	0.346	0.053	0.399		Front	0.539	0.053	0.592
	Top	-	0.012	0.012		Top	-	0.012	0.012
	Bottom	0.040	-	0.040		Bottom	0.527	-	0.527
	Right	0.314	0.072	0.386		Right	0.135	0.072	0.207
	Left	0.269	-	0.269		Left	0.207	-	0.207

Notes:

1. Per FCC KDB Publication 941225 D06, the edges with antennas more than 2.5 cm are not required to be evaluated for SAR ("-").
2. The above tables represent a portable hotspot configuration.
3. For numerical sums below 1.6 W/kg, no SAR ratio analysis or aggregate volumetric SAR evaluations for the transmitters were required.

FCC ID: ZNFP690B IC Cert No.: 2703C-P690B	 PCTEST ENGINEERING LABORATORY, INC.	SAR COMPLIANCE REPORT INDUSTRY CANADA TECHNICAL REPORT (RSS-102)	 LG	Reviewed by: Quality Manager
Filename: OY1107191260.ZNF	Test Dates: 07/18/11 - 08/01/11	EUT Type: 850/1900 GSM/GPRS/EDGE/WCDMA Phone with Bluetooth and WLAN	Page 38 of 44	

16.5 SAR Sum to Peak Location Separation (SPLS) Ratio Analysis

Per FCC KDB Publication 648474 D01, when the sum of the standalone transmitters is more than 1.6 W/kg, the SAR sum to peak locations can be analyzed to determine SAR distribution overlaps. Based on the on the 1-g SAR limit and a separation distance of 5 cm, when the SAR peak to location ratio for each pair of antennas is < 0.3, simultaneous SAR evaluation is not required.

The sum of the standalone SAR values was above 1.6 W/kg for the left touch position of the held to ear voice call (WCDMA 1900) with WLAN.

Table 16-4
Zoom Scan Peak SAR Locations for Left Touch

Mode/Band	x (cm)	y (cm)	z (cm)
WCDMA 1900	7.00	25.61	-17.19
WLAN	3.80	31.33	-17.56

$$\text{Distance}_{\text{WCDMA 1900-WLAN}} = \sqrt{(7.00 - 3.80)^2 + (25.61 - 31.33)^2 + (-17.19 + 17.56)^2} = 6.56\text{cm}$$

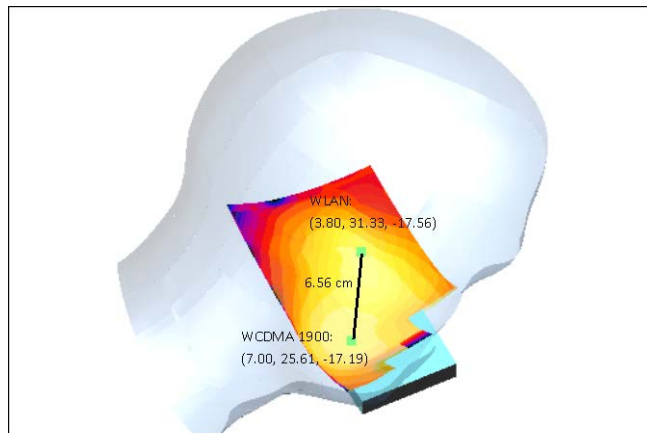

Figure 16-3
WCDMA 1900 and WLAN in Left Touch



Table 16-5
SAR Sum to Peak Location Separation Ratio Calculation

Antenna Pair		Standalone 1g SAR (W/kg)		Standalone SAR Sum (W/kg)	Peak SAR Separation Distance (cm)	SPLS Ratio
Ant "a"	Ant "b"	a	b	a+b	Da-b	(a+b) / (Da-b)
WCDMA 1900	WLAN	1.12	0.521	1.641	6.56	0.25

Since the SPLS Ratio for each antenna pair was less than 0.3, no volumetric simultaneous transmission scenario is required per FCC KDB 648474 Publication D01.



16.6 Simultaneous Transmission Conclusion

Per FCC KDB Publication 648474 D01, no aggregate volumetric simultaneous transmission is required for the device, since the sum of the standalone SAR values or the SAR Sum to peak separation ratios are < 0.3 for each antenna pair.

FCC ID: ZNFP690B IC Cert No.: 2703C-P690B		SAR COMPLIANCE REPORT INDUSTRY CANADA TECHNICAL REPORT (RSS-102)			Reviewed by: Quality Manager
Filename: OY1107191260.ZNF	Test Dates: 07/18/11 - 08/01/11	EUT Type: 850/1900 GSM/GPRS/EDGE/WCDMA Phone with Bluetooth and WLAN			Page 39 of 44

17 EQUIPMENT LIST

Manufacturer	Model	Description	Cal Date	Cal Interval	Cal Due	Serial Number
Agilent	85070B	Dielectric Probe Kit	8/22/2010	Annual	8/22/2011	US33020316
Agilent	8648D	(9kHz-4GHz) Signal Generator	10/13/2010	Annual	10/13/2011	3613A00315
Agilent	8753E	(30kHz-6GHz) Network Analyzer	4/21/2011	Annual	4/21/2012	JP38020182
Agilent	E5515C	Wireless Communications Test Set	10/11/2010	Annual	10/11/2011	GB46110872
Agilent	E5515C	Wireless Communications Test Set	10/8/2010	Annual	10/8/2011	GB46310798
Agilent	E5515C	Wireless Communications Test Set	7/6/2011	Annual	7/6/2012	GB41450275
Agilent	E8257D	(250kHz-20GHz) Signal Generator	4/8/2011	Annual	4/8/2012	MY45470194
Gigatronics	80701A	(0.05-18GHz) Power Sensor	10/11/2010	Annual	10/11/2011	1833460
Gigatronics	8651A	Universal Power Meter	10/11/2010	Annual	10/11/2011	8650319
Rohde & Schwarz	CMU200	Base Station Simulator	11/11/2010	Annual	11/11/2011	836371/0079
Rohde & Schwarz	CMU200	Base Station Simulator	6/1/2011	Annual	6/1/2012	833855/0010
Rohde & Schwarz	CMU200	Base Station Simulator	4/19/2011	Annual	4/19/2012	107826
Rohde & Schwarz	NRVD	Dual Channel Power Meter	4/8/2011	Biennial	4/8/2013	101695
SPEAG	D1765V2	1765 MHz SAR Dipole	6/16/2011	Annual	6/16/2012	1008
SPEAG	D1900V2	1900 MHz SAR Dipole	2/17/2011	Annual	2/17/2012	502
SPEAG	D1900V2	1900 MHz SAR Dipole	8/18/2009	Biennial	8/18/2011	5d080
SPEAG	D2450V2	2450 MHz SAR Dipole	8/27/2009	Biennial	8/27/2011	719
SPEAG	D2450V2	2450 MHz SAR Dipole	2/8/2011	Annual	2/8/2012	797
SPEAG	D2600V2	2600 MHz SAR Dipole	4/15/2011	Annual	4/15/2012	1004
SPEAG	D5GHzV2	5 GHz SAR Dipole	8/19/2009	Biennial	8/19/2011	1007
SPEAG	D5GHzV2	5 GHz SAR Dipole	2/11/2011	Annual	2/11/2012	1057
SPEAG	D835V2	835 MHz SAR Dipole	2/9/2011	Annual	2/9/2012	4d047
SPEAG	D835V2	835 MHz SAR Dipole	8/24/2009	Biennial	8/24/2011	4d026
SPEAG	DAE3	Dasy Data Acquisition Electronics	11/18/2010	Annual	11/18/2011	455
SPEAG	DAE4	Dasy Data Acquisition Electronics	3/17/2011	Annual	3/17/2012	704
SPEAG	DAE4	Dasy Data Acquisition Electronics	4/20/2011	Annual	4/20/2012	665
SPEAG	DAE4	Dasy Data Acquisition Electronics	2/21/2011	Annual	2/21/2012	649
SPEAG	ES3DV2	SAR Probe	9/21/2010	Annual	9/21/2011	3022
SPEAG	EX3DV4	SAR Probe	8/19/2010	Annual	8/19/2011	3561
SPEAG	EX3DV4	SAR Probe	2/14/2011	Annual	2/14/2012	3550
SPEAG	DAE4	Dasy Data Acquisition Electronics	5/19/2011	Annual	5/19/2012	859
SPEAG	D750V3	750 MHz Dipole	2/14/2011	Annual	2/14/2012	1003
SPEAG	ES3DV3	SAR Probe	3/24/2011	Annual	3/24/2012	3213
SPEAG	ES3DV3	SAR Probe	4/18/2011	Annual	4/18/2012	3209
Rohde & Schwarz	SMIQ03B	Signal Generator	4/6/2011	Annual	4/6/2012	DE27259
SPEAG	D1640V2	1640 MHz Dipole	8/17/2010	Annual	8/17/2011	321
Rohde & Schwarz	CMW500	LTE Radio Communication Tester	8/30/2010	Annual	8/30/2011	100976
Anritsu	MA2481A	Power Sensor	2/7/2011	Annual	2/7/2012	5318
Anritsu	MA2481A	Power Sensor	2/7/2011	Annual	2/7/2012	5442
Anritsu	ML2438A	Power Meter	2/7/2011	Annual	2/7/2012	1190013
Anritsu	ML2438A	Power Meter	2/7/2011	Annual	2/7/2012	98150041
Agilent	8648D	Signal Generator	4/5/2011	Annual	4/5/2012	3629U00687
Anritsu	ML2438A	Power Meter	2/7/2011	Annual	2/7/2012	1070030
Anritsu	MA2481A	Power Sensor	2/7/2011	Annual	2/7/2012	5821
Anritsu	MA2481A	Power Sensor	2/7/2011	Annual	2/7/2012	8013
Anritsu	MA2481A	Power Sensor	2/7/2011	Annual	2/7/2012	5605
Anritsu	MA2481A	Power Sensor	2/7/2011	Annual	2/7/2012	2400
Agilent	E5515C	Wireless Communications Test Set	7/6/2011	Annual	7/6/2012	GB43304447
Agilent	E5515C	Wireless Communications Tester	4/21/2011	Annual	4/21/2012	US41140256
Amplifier Research	5S1G4	5W, 800MHz-4.2GHz	N/A			21910
Mini-Circuits	BW-N20W5+	DC to 18 GHz Precision Fixed 20 dB Attenuator	N/A			N/A
Agilent	E5515C	Wireless Communications Test Set	2/8/2011	Annual	2/8/2012	GB45360985
SPEAG	D3700V2	3700 MHz SAR Dipole	2/16/2011	Annual	2/16/2012	1002
Rohde & Schwarz	CMW500	LTE Radio Communication Tester	3/11/2011	Annual	3/11/2012	103962
Control Company	61220-416	Long-Stem Thermometer	2/15/2011	Biennial	2/15/2013	111331322
Control Company	61220-416	Long-Stem Thermometer	2/15/2011	Biennial	2/15/2013	111331323
Control Company	61220-416	Long-Stem Thermometer	2/15/2011	Biennial	2/15/2013	111331330
Control Company	61220-416	Long-Stem Thermometer	2/15/2011	Biennial	2/15/2013	111331332
Control Company	61220-416	Long-Stem Thermometer	3/16/2011	Biennial	3/16/2013	111391601
SPEAG	ES3DV3	SAR Probe	4/8/2011	Annual	4/8/2012	3258
SPEAG	D1750V2	1750 MHz SAR Dipole	5/24/2011	Annual	5/24/2012	1051
MiniCircuits	SLP-2400+	Low Pass Filter	N/A			R8979500903
Narda	4772-3	Attenuator (3dB)	N/A			9406
Narda	BW-S3W2	Attenuator (3dB)	N/A			120



FCC ID: ZNFP690B IC Cert No.: 2703C-P690B		SAR COMPLIANCE REPORT INDUSTRY CANADA TECHNICAL REPORT (RSS-102)		Reviewed by: Quality Manager
Filename: OY1107191260.ZNF	Test Dates: 07/18/11 - 08/01/11	EUT Type: 850/1900 GSM/GPRS/EDGE/WCDMA Phone with Bluetooth and WLAN		Page 40 of 44

18 MEASUREMENT UNCERTAINTIES

Applicable for 750 – 3000 MHz.

a	b	c	d	e= f(d,k)	f	g	h = c x f/e	i = c x g/e	k
Uncertainty Component	IEEE 1528 Sec.	Tol. (± %)	Prob. Dist.	Div.	c _i 1gm	c _i 10 gms	1gm u _i (± %)	10gms u _i (± %)	v _i
Measurement System									
Probe Calibration	E.2.1	6.0	N	1	1.0	1.0	6.0	6.0	∞
Axial Isotropy	E.2.2	0.25	N	1	0.7	0.7	0.2	0.2	∞
Hemishperical Isotropy	E.2.2	1.3	N	1	1.0	1.0	1.3	1.3	∞
Boundary Effect	E.2.3	0.4	N	1	1.0	1.0	0.4	0.4	∞
Linearity	E.2.4	0.3	N	1	1.0	1.0	0.3	0.3	∞
System Detection Limits	E.2.5	5.1	N	1	1.0	1.0	5.1	5.1	∞
Readout Electronics	E.2.6	1.0	N	1	1.0	1.0	1.0	1.0	∞
Response Time	E.2.7	0.8	R	1.73	1.0	1.0	0.5	0.5	∞
Integration Time	E.2.8	2.6	R	1.73	1.0	1.0	1.5	1.5	∞
RF Ambient Conditions	E.6.1	3.0	R	1.73	1.0	1.0	1.7	1.7	∞
Probe Positioner Mechanical Tolerance	E.6.2	0.4	R	1.73	1.0	1.0	0.2	0.2	∞
Probe Positioning w/ respect to Phantom	E.6.3	2.9	R	1.73	1.0	1.0	1.7	1.7	∞
Extrapolation, Interpolation & Integration algorithms for Max. SAR Evaluation	E.5	1.0	R	1.73	1.0	1.0	0.6	0.6	∞
Test Sample Related									
Test Sample Positioning	E.4.2	6.0	N	1	1.0	1.0	6.0	6.0	287
Device Holder Uncertainty	E.4.1	3.32	R	1.73	1.0	1.0	1.9	1.9	∞
Output Power Variation - SAR drift measurement	6.6.2	5.0	R	1.73	1.0	1.0	2.9	2.9	∞
Phantom & Tissue Parameters									
Phantom Uncertainty (Shape & Thickness tolerances)	E.3.1	4.0	R	1.73	1.0	1.0	2.3	2.3	∞
Liquid Conductivity - deviation from target values	E.3.2	5.0	R	1.73	0.64	0.43	1.8	1.2	∞
Liquid Conductivity - measurement uncertainty	E.3.3	3.8	N	1	0.64	0.43	2.4	1.6	6
Liquid Permittivity - deviation from target values	E.3.2	5.0	R	1.73	0.60	0.49	1.7	1.4	∞
Liquid Permittivity - measurement uncertainty	E.3.3	4.5	N	1	0.60	0.49	2.7	2.2	6
Combined Standard Uncertainty (k=1)				RSS			12.1	11.7	299
Expanded Uncertainty (95% CONFIDENCE LEVEL)				k=2			24.2	23.4	

The above measurement uncertainties are according to IEEE Std. 1528-2003

FCC ID: ZNFP690B IC Cert No.: 2703C-P690B		SAR COMPLIANCE REPORT INDUSTRY CANADA TECHNICAL REPORT (RSS-102)		Reviewed by: Quality Manager
Filename: OY1107191260.ZNF	Test Dates: 07/18/11 - 08/01/11	EUT Type: 850/1900 GSM/GPRS/EDGE/WCDMA Phone with Bluetooth and WLAN		Page 41 of 44

19 CONCLUSION

19.1 Measurement Conclusion

The SAR evaluation indicates that the EUT complies with the RF radiation exposure limits of the FCC and Industry Canada, with respect to all parameters subject to this test. These measurements were taken to simulate the RF effects of RF exposure under worst-case conditions. Precise laboratory measures were taken to assure repeatability of the tests. The results and statements relate only to the item(s) tested.

Please note that the absorption and distribution of electromagnetic energy in the body are very complex phenomena that depend on the mass, shape, and size of the body, the orientation of the body with respect to the field vectors, and the electrical properties of both the body and the environment. Other variables that may play a substantial role in possible biological effects are those that characterize the environment (e.g. ambient temperature, air velocity, relative humidity, and body insulation) and those that characterize the individual (e.g. age, gender, activity level, debilitation, or disease). Because various factors may interact with one another to vary the specific biological outcome of an exposure to electromagnetic fields, any protection guide should consider maximal amplification of biological effects as a result of field-body interactions, environmental conditions, and physiological variables. [3]

FCC ID: ZNFP690B IC Cert No.: 2703C-P690B		SAR COMPLIANCE REPORT INDUSTRY CANADA TECHNICAL REPORT (RSS-102)		Reviewed by: Quality Manager
Filename: 0Y1107191260.ZNF	Test Dates: 07/18/11 - 08/01/11	EUT Type: 850/1900 GSM/GPRS/EDGE/WCDMA Phone with Bluetooth and WLAN	Page 42 of 44	

- [1] Federal Communications Commission, ET Docket 93-62, Guidelines for Evaluating the Environmental Effects of Radiofrequency Radiation, Aug. 1996.
- [2] ANSI/IEEE C95.1-2005, American National Standard safety levels with respect to human exposure to radio frequency electromagnetic fields, 300kHz to 100GHz, New York: IEEE, 2006.
- [3] ANSI/IEEE C95.1-1992, American National Standard safety levels with respect to human exposure to radio frequency electromagnetic fields, 300kHz to 100GHz, New York: IEEE, Sept. 1992.
- [4] ANSI/IEEE C95.3-2002, IEEE Recommended Practice for the Measurement of Potentially Hazardous Electromagnetic Fields - RF and Microwave, New York: IEEE, December 2002.
- [5] Federal Communications Commission, OET Bulletin 65 (Edition 97-01), Supplement C (Edition 01-01), Evaluating Compliance with FCC Guidelines for Human Exposure to Radiofrequency Electromagnetic Fields, June 2001.
- [6] IEEE Standards Coordinating Committee 34 – IEEE Std. 1528-2003, Recommended Practice for Determining the Peak Spatial-Average Specific Absorption Rate (SAR) in the Human Body Due to Wireless Communications Devices.
- [7] NCRP, National Council on Radiation Protection and Measurements, Biological Effects and Exposure Criteria for RadioFrequency Electromagnetic Fields, NCRP Report No. 86, 1986. Reprinted Feb. 1995.
- [8] T. Schmid, O. Egger, N. Kuster, Automated E-field scanning system for dosimetric assessments, IEEE Transaction on Microwave Theory and Techniques, vol. 44, Jan. 1996, pp. 105-113.
- [9] K. Pokovic, T. Schmid, N. Kuster, Robust setup for precise calibration of E-field probes in tissue simulating liquids at mobile communications frequencies, ICECOM97, Oct. 1997, pp. 120-124.
- [10] K. Pokovic, T. Schmid, and N. Kuster, E-field Probe with improved isotropy in brain simulating liquids, Proceedings of the ELMAR, Zadar, Croatia, June 23-25, 1996, pp. 172-175.
- [11] Schmid & Partner Engineering AG, Application Note: Data Storage and Evaluation, June 1998, p2.
- [12] V. Hombach, K. Meier, M. Burkhardt, E. Kuhn, N. Kuster, The Dependence of EM Energy Absorption upon Human Head Modeling at 900 MHz, IEEE Transaction on Microwave Theory and Techniques, vol. 44 no. 10, Oct. 1996, pp. 1865-1873.
- [13] N. Kuster and Q. Balzano, Energy absorption mechanism by biological bodies in the near field of dipole antennas above 300MHz, IEEE Transaction on Vehicular Technology, vol. 41, no. 1, Feb. 1992, pp. 17-23.
- [14] G. Hartsgrrove, A. Kraszewski, A. Surowiec, Simulated Biological Materials for Electromagnetic Radiation Absorption Studies, University of Ottawa, Bioelectromagnetics, Canada: 1987, pp. 29-36.
- [15] Q. Balzano, O. Garay, T. Manning Jr., Electromagnetic Energy Exposure of Simulated Users of Portable Cellular Telephones, IEEE Transactions on Vehicular Technology, vol. 44, no.3, Aug. 1995.
- [16] W. Gander, Computermathematik, Birkhaeuser, Basel, 1992.
- [17] W.H. Press, S.A. Teukolsky, W.T. Vetterling, and B.P. Flannery, Numerical Recipes in C, The Art of Scientific Computing, Second edition, Cambridge University Press, 1992.

FCC ID: ZNFP690B IC Cert No.: 2703C-P690B		SAR COMPLIANCE REPORT INDUSTRY CANADA TECHNICAL REPORT (RSS-102)		Reviewed by: Quality Manager
Filename: OY1107191260.ZNF	Test Dates: 07/18/11 - 08/01/11	EUT Type: 850/1900 GSM/GPRS/EDGE/WCDMA Phone with Bluetooth and WLAN	Page 43 of 44	

- [18] Federal Communications Commission, OET Bulletin 65, Evaluating Compliance with FCC Guidelines for Human Exposure to Radiofrequency Electromagnetic Fields. Supplement C, Dec. 1997.
- [19] N. Kuster, R. Kastle, T. Schmid, Dosimetric evaluation of mobile communications equipment with known precision, IEEE Transaction on Communications, vol. E80-B, no. 5, May 1997, pp. 645-652.
- [20] CENELEC CLC/SC111B, European Prestandard (prENV 50166-2), Human Exposure to Electromagnetic Fields High-frequency: 10kHz-300GHz, Jan. 1995.
- [21] Prof. Dr. Niels Kuster, ETH, Eidgenössische Technische Hochschule Zürich, Dosimetric Evaluation of the Cellular Phone.
- [22] IEC 62209-1, Human exposure to radio frequency fields from hand-held and body-mounted wireless communication devices - Human models, instrumentation, and procedures - Part 1: Procedure to determine the specific absorption rate (SAR) for hand-held devices used in close proximity to the ear (frequency range of 300 MHz to 3 GHz), Feb. 2005.
- [23] Industry Canada RSS-102 Radio Frequency Exposure Compliance of Radiocommunication Apparatus (All Frequency Bands) Issue 4, March 2010.
- [24] Health Canada Safety Code 6 Limits of Human Exposure to Radio Frequency Electromagnetic Fields in the Frequency Range from 3 kHz – 300 GHz, 2009
- [25] FCC Public Notice DA-02-1438. Office of Engineering and Technology Announces a Transition Period for the Phantom Requirements of Supplement C to OET Bulletin 65, June 19, 2002
- [26] FCC SAR Measurement Procedures for 3G Devices KDB Publication 941225
- [27] SAR Measurement procedures for IEEE 802.11a/b/g KDB Publication 248227
- [28] FCC SAR Considerations for Handsets with Multiple Transmitters and Antennas, KDB Publication 648474
- [29] FCC Application Note for SAR Probe Calibration and System Verification Consideration for Measurements at 150 MHz – 3 GHz, KDB Publication 450824
- [30] FCC SAR Evaluation Considerations for Laptop Computers with Antennas Built-in on Display Screens, KDB Publication 616217
- [31] FCC SAR Measurement Requirements for 3 – 6 GHz, KDB Publication 865664
- [32] FCC Mobile Portable RF Exposure Procedure, KDB Publication 447498
- [33] FCC SAR Procedures for Dongle Transmitters, KDB Publication 447498
- [34] Anexo à Resolução No. 533, de 10 de Setembro de 2009.
- [35] FCC SAR Test Considerations for LTE Handsets and Data Modems, KDB Publication 941225.
- [36] IEC 62209-2, Human exposure to radio frequency fields from hand-held and body-mounted wireless communication devices - Human models, instrumentation, and procedures - Part 2: Procedure to determine the specific absorption rate (SAR) for wireless communication devices used in close proximity to the human body (frequency range of 30 MHz to 6 GHz), Mar. 2010.
- [37] FCC D06 Hot Spot SAR v01, KDB Publication 941225.

FCC ID: ZNFP690B IC Cert No.: 2703C-P690B		SAR COMPLIANCE REPORT INDUSTRY CANADA TECHNICAL REPORT (RSS-102)		Reviewed by: Quality Manager
Filename: OY1107191260.ZNF	Test Dates: 07/18/11 - 08/01/11	EUT Type: 850/1900 GSM/GPRS/EDGE/WCDMA Phone with Bluetooth and WLAN	Page 44 of 44	

APPENDIX A: SAR TEST DATA

PCTEST ENGINEERING LABORATORY, INC.

**DUT: ZNFP690B; Type: 850/1900 GSM/GPRS/EDGE/WCDMA Phone
with Bluetooth and WLAN; Serial: 1**

Communication System: GSM850; Frequency: 836.6 MHz; Duty Cycle: 1:8.3
Medium: 835 Head; Medium parameters used (interpolated):
 $f = 836.6 \text{ MHz}$; $\sigma = 0.868 \text{ mho/m}$; $\epsilon_r = 40.1$; $\rho = 1000 \text{ kg/m}^3$
Phantom section: Right Section

Test Date: 07-18-2011; Ambient Temp: 23.3 °C; Tissue Temp: 21.5 °C

Probe: ES3DV3 - SN3258; ConvF(6.18, 6.18, 6.18); Calibrated: 4/8/2011
Sensor-Surface: 4mm (Mechanical Surface Detection)
Electronics: DAE4 Sn649; Calibrated: 2/21/2011
Phantom: SAM Sub; Type: SAM 4.0; Serial: TP-1357

Measurement SW: DASY4, V4.7 Build 80; Postprocessing SW: SEMCAD, V1.8 Build 186

Mode: GSM 850, Right Head, Touch, Mid.ch

Area Scan (7x14x1): Measurement grid: dx=15mm, dy=15mm

Zoom Scan (5x5x7)/Cube 0: Measurement grid: dx=8mm, dy=8mm, dz=5mm

Reference Value = 20.2 V/m

Peak SAR (extrapolated) = 0.422 W/kg

SAR(1 g) = 0.334 mW/g; SAR(10 g) = 0.247 mW/g

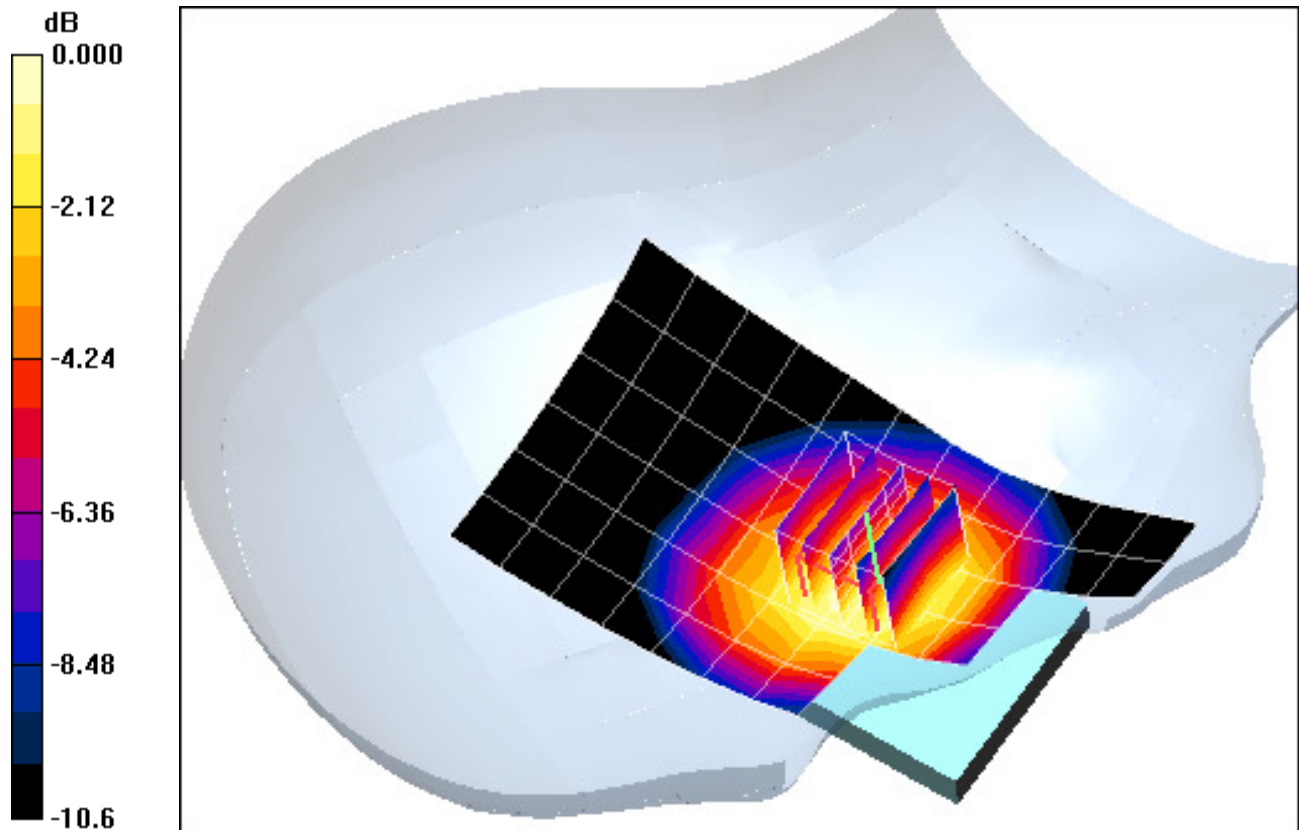

0 dB = 0.354mW/g

PCTEST ENGINEERING LABORATORY, INC.

**DUT: ZNFP690B; Type: 850/1900 GSM/GPRS/EDGE/WCDMA Phone
with Bluetooth and WLAN; Serial: 1**

Communication System: GSM850; Frequency: 836.6 MHz; Duty Cycle: 1:8.3
Medium: 835 Head; Medium parameters used (interpolated):
 $f = 836.6 \text{ MHz}$; $\sigma = 0.868 \text{ mho/m}$; $\epsilon_r = 40.1$; $\rho = 1000 \text{ kg/m}^3$
Phantom section: Right Section

Test Date: 07-18-2011; Ambient Temp: 23.3 °C; Tissue Temp: 21.5 °C

Probe: ES3DV3 - SN3258; ConvF(6.18, 6.18, 6.18); Calibrated: 4/8/2011
Sensor-Surface: 4mm (Mechanical Surface Detection)
Electronics: DAE4 Sn649; Calibrated: 2/21/2011
Phantom: SAM Sub; Type: SAM 4.0; Serial: TP-1357

Measurement SW: DASY4, V4.7 Build 80; Postprocessing SW: SEMCAD, V1.8 Build 186

Mode: GSM 850, Right Head, Tilt, Mid.ch

Area Scan (7x14x1): Measurement grid: dx=15mm, dy=15mm

Zoom Scan (5x5x7)/Cube 0: Measurement grid: dx=8mm, dy=8mm, dz=5mm

Reference Value = 15.4 V/m

Peak SAR (extrapolated) = 0.244 W/kg

SAR(1 g) = 0.194 mW/g; SAR(10 g) = 0.146 mW/g

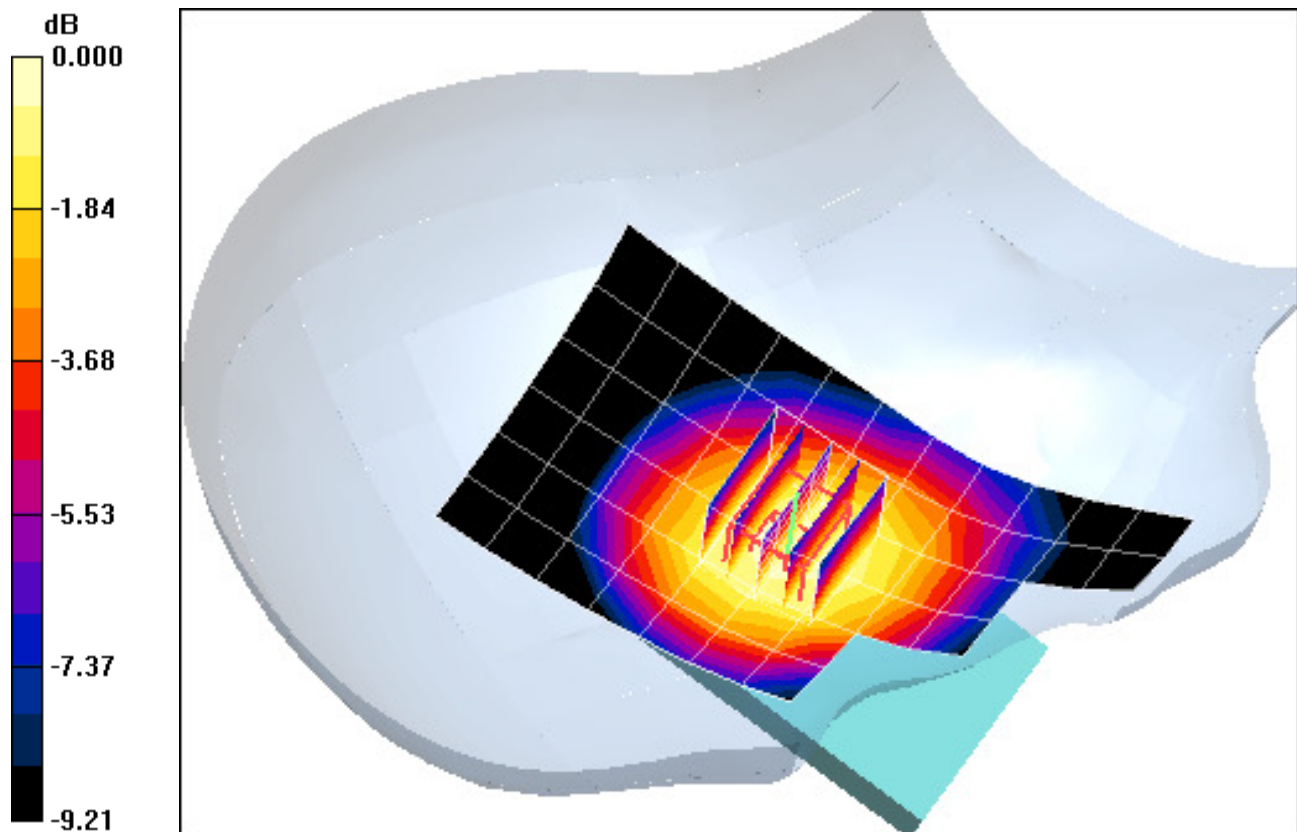

0 dB = 0.204mW/g

PCTEST ENGINEERING LABORATORY, INC.

**DUT: ZNFP690B; Type: 850/1900 GSM/GPRS/EDGE/WCDMA Phone
with Bluetooth and WLAN; Serial: 1**

Communication System: GSM850; Frequency: 836.6 MHz; Duty Cycle: 1:8.3
Medium: 835 Head; Medium parameters used (interpolated):
 $f = 836.6 \text{ MHz}$; $\sigma = 0.868 \text{ mho/m}$; $\epsilon_r = 40.1$; $\rho = 1000 \text{ kg/m}^3$
Phantom section: Left Section

Test Date: 07-18-2011; Ambient Temp: 23.3 °C; Tissue Temp: 21.5 °C

Probe: ES3DV3 - SN3258; ConvF(6.18, 6.18, 6.18); Calibrated: 4/8/2011
Sensor-Surface: 4mm (Mechanical Surface Detection)
Electronics: DAE4 Sn649; Calibrated: 2/21/2011
Phantom: SAM Sub; Type: SAM 4.0; Serial: TP-1357

Measurement SW: DASY4, V4.7 Build 80; Postprocessing SW: SEMCAD, V1.8 Build 186

Mode: GSM 850, Left Head, Touch, Mid.ch

Area Scan (7x14x1): Measurement grid: dx=15mm, dy=15mm

Zoom Scan (5x5x7)/Cube 0: Measurement grid: dx=8mm, dy=8mm, dz=5mm

Reference Value = 4.76 V/m

Peak SAR (extrapolated) = 0.412 W/kg

SAR(1 g) = 0.304 mW/g; SAR(10 g) = 0.221 mW/g

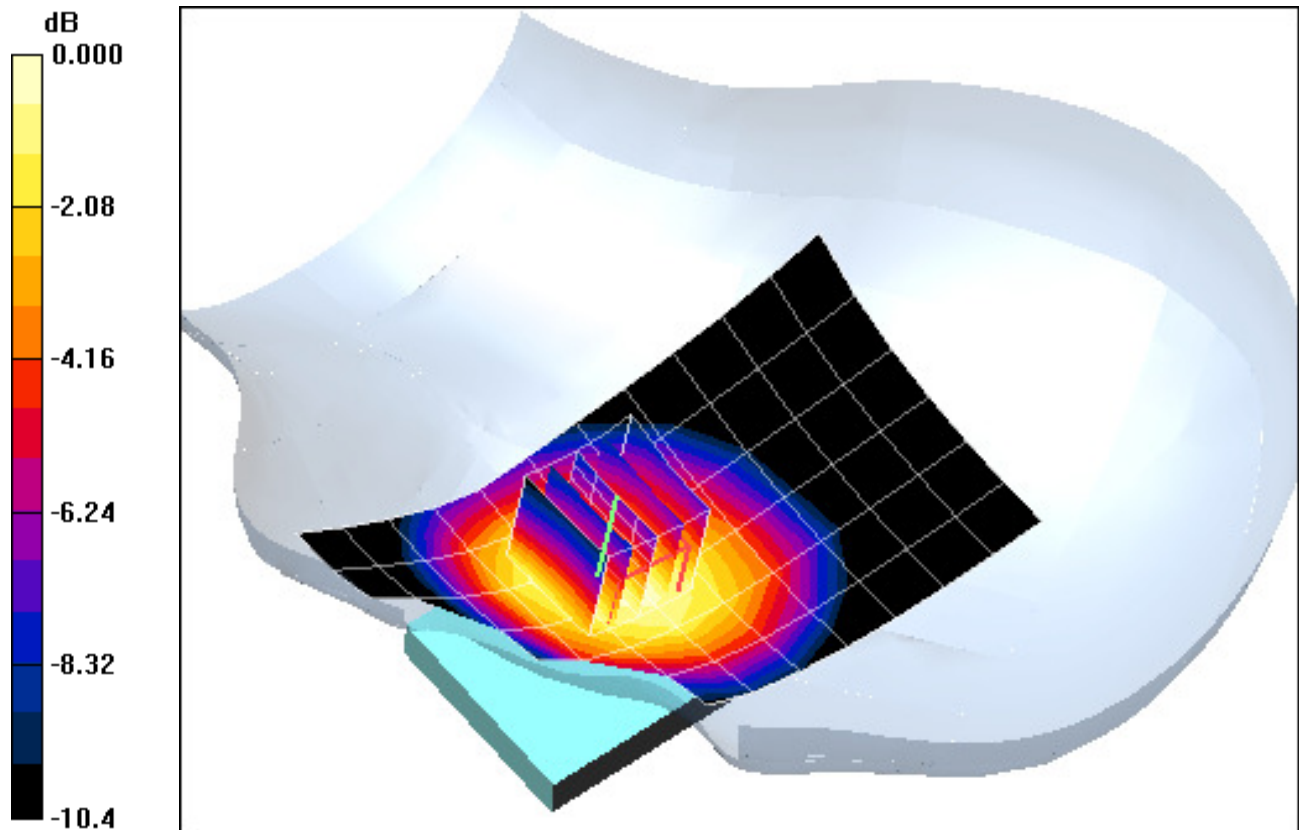

0 dB = 0.321mW/g

PCTEST ENGINEERING LABORATORY, INC.

**DUT: ZNFP690B; Type: 850/1900 GSM/GPRS/EDGE/WCDMA Phone
with Bluetooth and WLAN; Serial: 1**

Communication System: GSM850; Frequency: 836.6 MHz; Duty Cycle: 1:8.3
Medium: 835 Head; Medium parameters used (interpolated):
 $f = 836.6 \text{ MHz}$; $\sigma = 0.868 \text{ mho/m}$; $\epsilon_r = 40.1$; $\rho = 1000 \text{ kg/m}^3$
Phantom section: Left Section

Test Date: 07-18-2011; Ambient Temp: 23.3 °C; Tissue Temp: 21.5 °C

Probe: ES3DV3 - SN3258; ConvF(6.18, 6.18, 6.18); Calibrated: 4/8/2011
Sensor-Surface: 4mm (Mechanical Surface Detection)
Electronics: DAE4 Sn649; Calibrated: 2/21/2011
Phantom: SAM Sub; Type: SAM 4.0; Serial: TP-1357

Measurement SW: DASY4, V4.7 Build 80; Postprocessing SW: SEMCAD, V1.8 Build 186

Mode: GSM 850, Left Head, Tilt, Mid.ch

Area Scan (7x14x1): Measurement grid: dx=15mm, dy=15mm

Zoom Scan (5x5x7)/Cube 0: Measurement grid: dx=8mm, dy=8mm, dz=5mm

Reference Value = 8.36 V/m

Peak SAR (extrapolated) = 0.233 W/kg

SAR(1 g) = 0.183 mW/g; SAR(10 g) = 0.139 mW/g

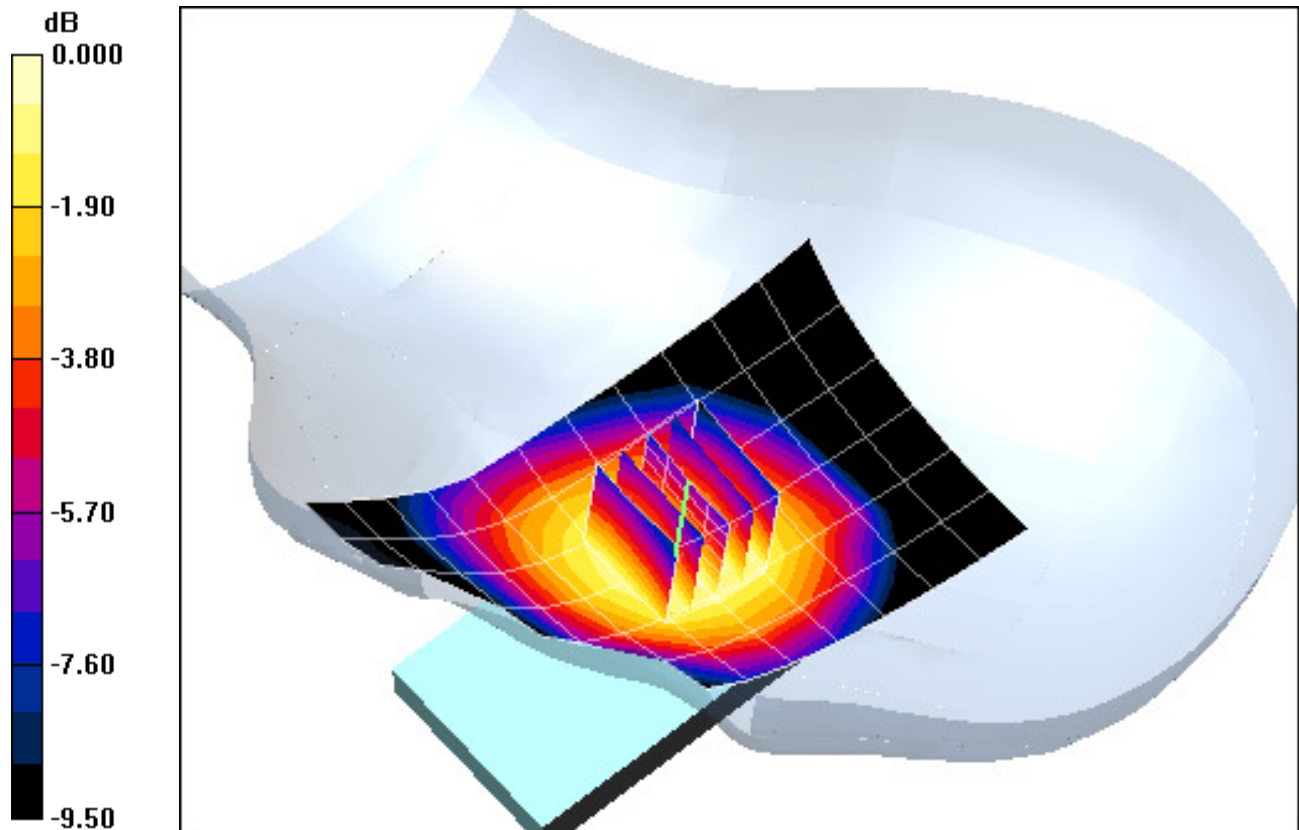

0 dB = 0.192mW/g

PCTEST ENGINEERING LABORATORY, INC.

**DUT: ZNFP690B; Type: 850/1900 GSM/GPRS/EDGE/WCDMA Phone
with Bluetooth and WLAN; Serial: 1**

Communication System: GSM1900; Frequency: 1880 MHz; Duty Cycle: 1:8.3
Medium: 1900 Head; Medium parameters used:

$f = 1880 \text{ MHz}$; $\sigma = 1.42 \text{ mho/m}$; $\epsilon_r = 38.2$; $\rho = 1000 \text{ kg/m}^3$

Phantom section: Right Section

Test Date: 07-43-2011; Ambient Temp: 26.: °C; Tissue Temp: 25.3 °C

Probe: EX3DV4 - SN3550; ConvF(7.01, 7.01, 7.01); Calibrated: 2/14/2011

Sensor-Surface: 4mm (Mechanical Surface Detection)

Electronics: DAE4 Sn665; Calibrated: 4/20/2011

Phantom: SAM Main; Type: SAM 4.0; Serial: TP-1114

Measurement SW: DASY4, V4.7 Build 80; Postprocessing SW: SEMCAD, V1.8 Build 186

Mode: GSM 1900, Right Head, Touch, Mid.ch

Area Scan (7x11x1): Measurement grid: dx=15mm, dy=15mm

Zoom Scan (5x5x7)/Cube 0: Measurement grid: dx=8mm, dy=8mm, dz=5mm

Reference Value = 13.1 V/m

Peak SAR (extrapolated) = 0.361 W/kg

SAR(1 g) = 0.229 mW/g; SAR(10 g) = 0.139 mW/g

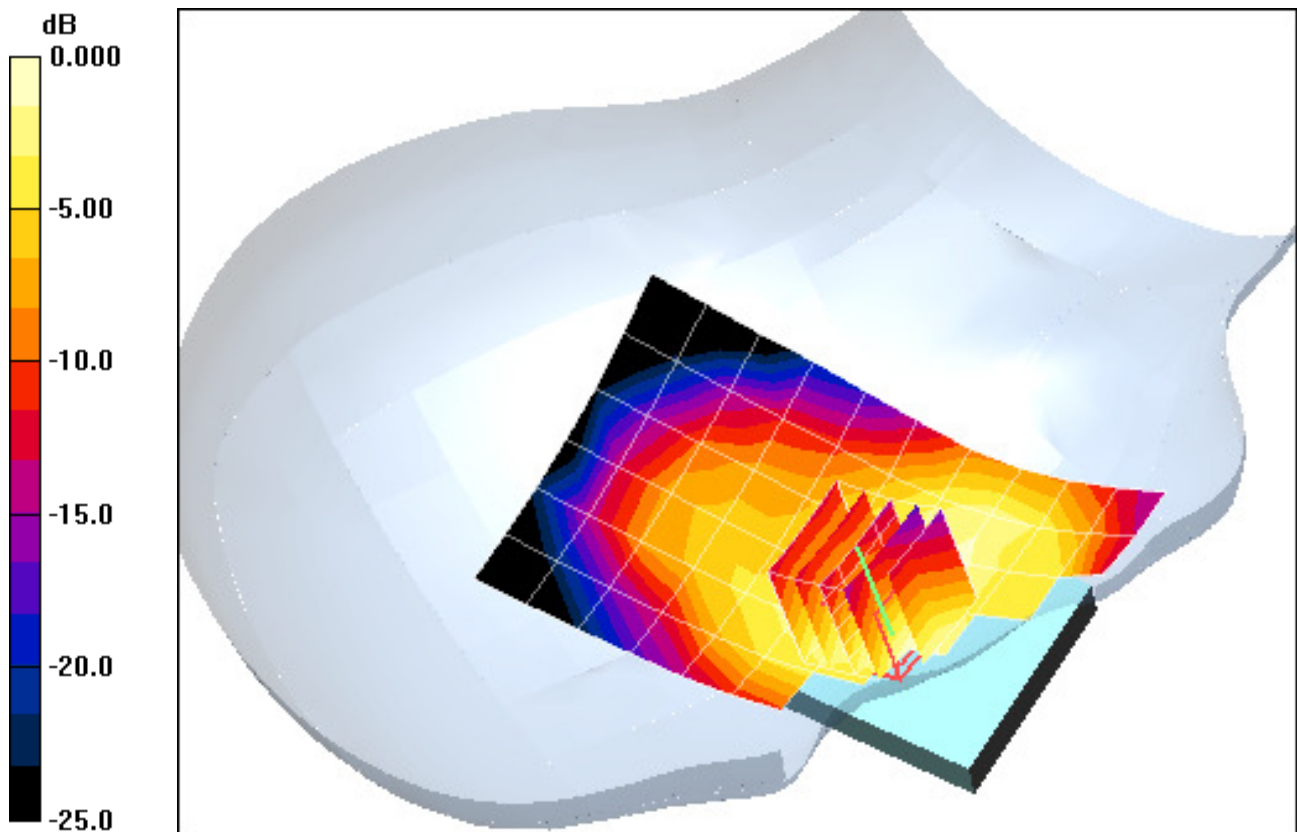

0 dB = 0.247mW/g

PCTEST ENGINEERING LABORATORY, INC.

**DUT: ZNFP690B; Type: 850/1900 GSM/GPRS/EDGE/WCDMA Phone
with Bluetooth and WLAN; Serial: 1**

Communication System: GSM1900; Frequency: 1880 MHz; Duty Cycle: 1:8.3
Medium: 1900 Head; Medium parameters used:
 $f = 1880 \text{ MHz}$; $\sigma = 1.42 \text{ mho/m}$; $\epsilon_r = 38.2$; $\rho = 1000 \text{ kg/m}^3$
Phantom section: Right Section

Test Date: 29/43/4233=C o dlgpv"Vgo r <460 "ÅE="Vkuuwg"Vgo r <450"ÅE

Probe: EX3DV4 - SN3550; ConvF(7.01, 7.01, 7.01); Calibrated: 2/14/2011
Sensor-Surface: 4mm (Mechanical Surface Detection)
Electronics: DAE4 Sn665; Calibrated: 4/20/2011
Phantom: SAM Main; Type: SAM 4.0; Serial: TP-1114
Measurement SW: DASY4, V4.7 Build 80; Postprocessing SW: SEMCAD, V1.8 Build 186

Mode: GSM 1900, Right Head, Tilt, Mid.ch

Area Scan (7x11x1): Measurement grid: dx=15mm, dy=15mm
Zoom Scan (5x5x7)/Cube 0: Measurement grid: dx=8mm, dy=8mm, dz=5mm
Reference Value = 10.1 V/m
Peak SAR (extrapolated) = 0.211 W/kg
SAR(1 g) = 0.133 mW/g; SAR(10 g) = 0.078 mW/g

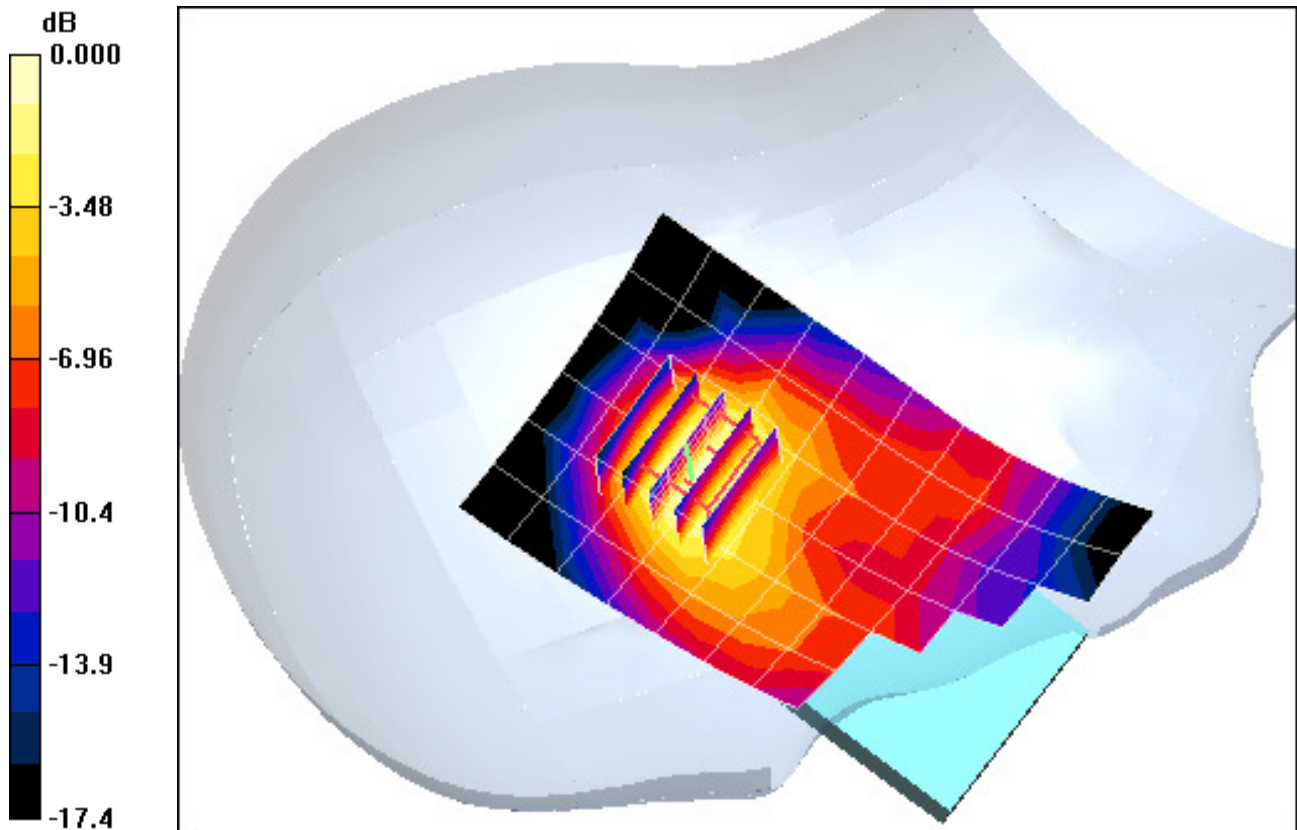

0 dB = 0.143mW/g

PCTEST ENGINEERING LABORATORY, INC.

**DUT: ZNFP690B; Type: 850/1900 GSM/GPRS/EDGE/WCDMA Phone
with Bluetooth and WLAN; Serial: 1**

Communication System: GSM1900; Frequency: 1880 MHz; Duty Cycle: 1:8.3
Medium: 1900 Head; Medium parameters used:
 $f = 1880 \text{ MHz}$; $\sigma = 1.42 \text{ mho/m}$; $\epsilon_r = 38.2$; $\rho = 1000 \text{ kg/m}^3$
Phantom section: Left Section

Test Date: 29/43/4233=C o dlgpvVgo r <460 "ÅE="Vkuuwg"Vgo r <450"ÅE

Probe: EX3DV4 - SN3550; ConvF(7.01, 7.01, 7.01); Calibrated: 2/14/2011
Sensor-Surface: 4mm (Mechanical Surface Detection)
Electronics: DAE4 Sn665; Calibrated: 4/20/2011
Phantom: SAM Main; Type: SAM 4.0; Serial: TP-1114
Measurement SW: DASY4, V4.7 Build 80; Postprocessing SW: SEMCAD, V1.8 Build 186

Mode: GSM 1900, Left Head, Touch, Mid.ch

Area Scan (7x11x1): Measurement grid: dx=15mm, dy=15mm
Zoom Scan (5x5x7)/Cube 0: Measurement grid: dx=8mm, dy=8mm, dz=5mm
Reference Value = 14.7 V/m
Peak SAR (extrapolated) = 0.577 W/kg
SAR(1 g) = 0.344 mW/g; SAR(10 g) = 0.191 mW/g

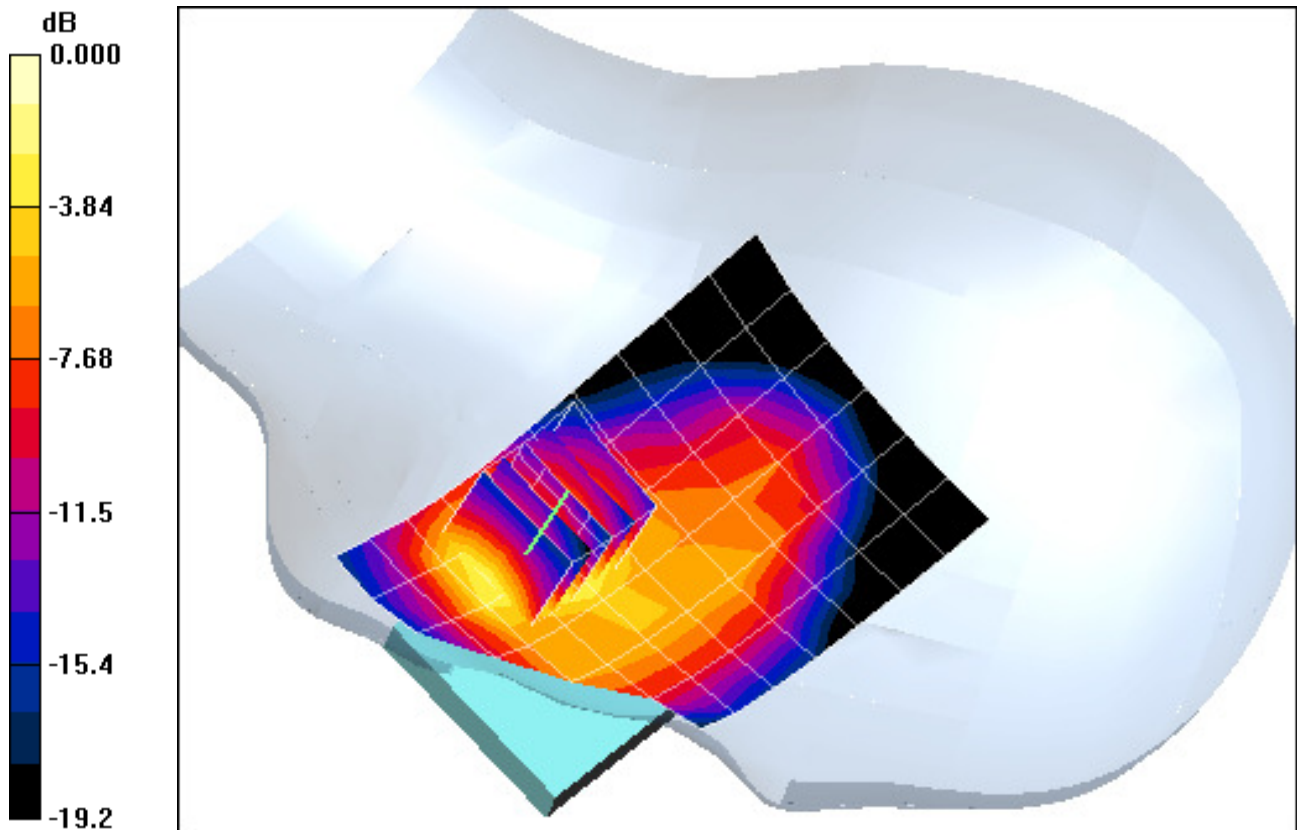

0 dB = 0.380mW/g

PCTEST ENGINEERING LABORATORY, INC.

**DUT: ZNFP690B; Type: 850/1900 GSM/GPRS/EDGE/WCDMA Phone
with Bluetooth and WLAN; Serial: 1**

Communication System: GSM1900; Frequency: 1880 MHz; Duty Cycle: 1:8.3
Medium: 1900 Head; Medium parameters used:
 $f = 1880 \text{ MHz}$; $\sigma = 1.42 \text{ mho/m}$; $\epsilon_r = 38.2$; $\rho = 1000 \text{ kg/m}^3$
Phantom section: Left Section

Test Date: 29/43/4233=C o dlgpv"Vgo r <460 "ÅE="Vkuuwg"Vgo r <450"ÅE

Probe: EX3DV4 - SN3550; ConvF(7.01, 7.01, 7.01); Calibrated: 2/14/2011
Sensor-Surface: 4mm (Mechanical Surface Detection)
Electronics: DAE4 Sn665; Calibrated: 4/20/2011
Phantom: SAM Main; Type: SAM 4.0; Serial: TP-1114
Measurement SW: DASY4, V4.7 Build 80; Postprocessing SW: SEMCAD, V1.8 Build 186

Mode: GSM 1900, Left Head, Tilt, Mid.ch

Area Scan (7x11x1): Measurement grid: dx=15mm, dy=15mm
Zoom Scan (5x5x7)/Cube 0: Measurement grid: dx=8mm, dy=8mm, dz=5mm
Reference Value = 10.1 V/m
Peak SAR (extrapolated) = 0.213 W/kg
SAR(1 g) = 0.131 mW/g; SAR(10 g) = 0.077 mW/g

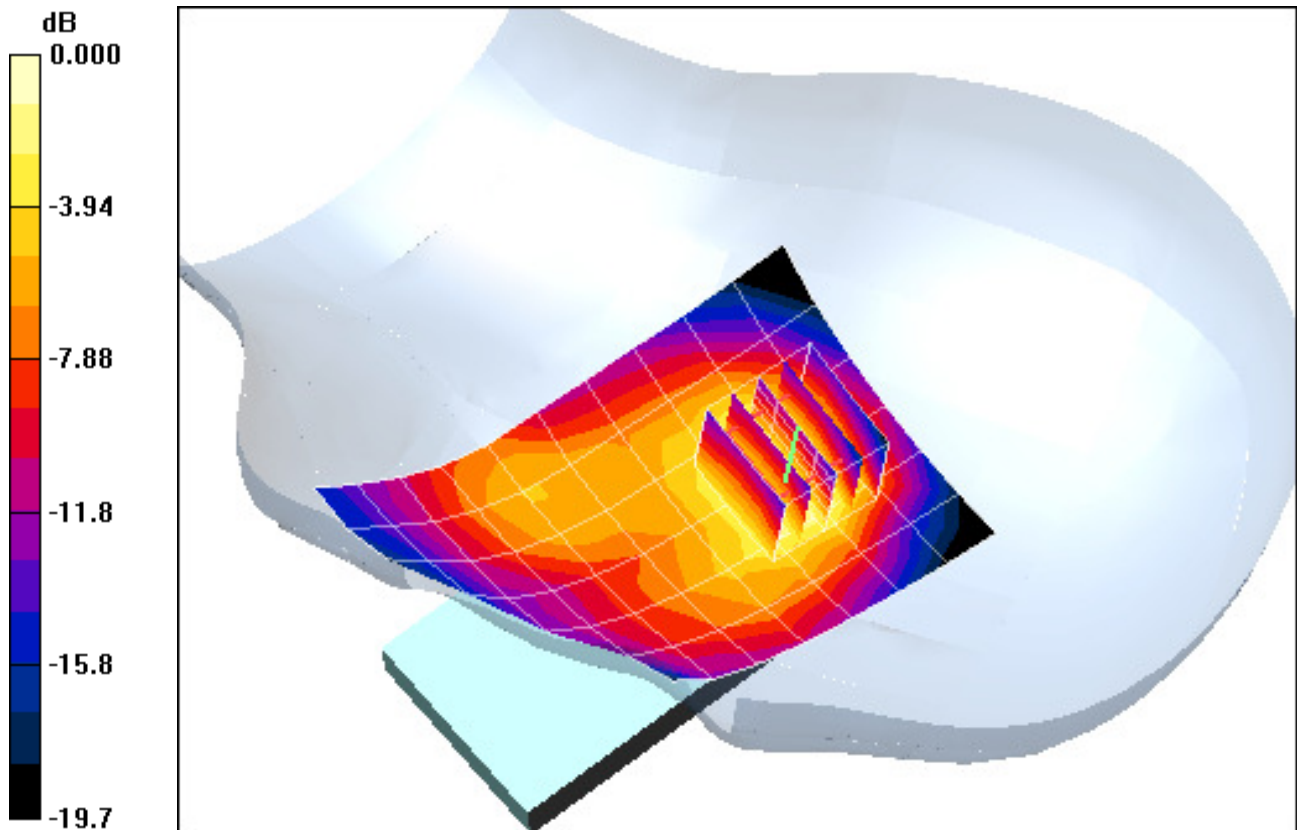

0 dB = 0.142mW/g

PCTEST ENGINEERING LABORATORY, INC.

**DUT: ZNFP690B; Type: 850/1900 GSM/GPRS/EDGE/WCDMA Phone
with Bluetooth and WLAN; Serial: 3**

Communication System: WCDMA850; Frequency: 836.6 MHz; Duty Cycle: 1:1
Medium: 835 Head; Medium parameters used (interpolated):
 $f = 836.6 \text{ MHz}$; $\sigma = 0.868 \text{ mho/m}$; $\epsilon_r = 40.1$; $\rho = 1000 \text{ kg/m}^3$
Phantom section: Right Section

Test Date: 07-18-2011; Ambient Temp: 23.3 °C; Tissue Temp: 21.5 °C

Probe: ES3DV3 - SN3258; ConvF(6.18, 6.18, 6.18); Calibrated: 4/8/2011
Sensor-Surface: 4mm (Mechanical Surface Detection)
Electronics: DAE4 Sn649; Calibrated: 2/21/2011
Phantom: SAM Sub; Type: SAM 4.0; Serial: TP-1357
Measurement SW: DASY4, V4.7 Build 80; Postprocessing SW: SEMCAD, V1.8 Build 186

Mode: WCDMA 850, Right Head, Touch, Mid.ch

Area Scan (7x10x1): Measurement grid: dx=15mm, dy=15mm

Zoom Scan (5x5x7)/Cube 0: Measurement grid: dx=8mm, dy=8mm, dz=5mm

Reference Value = 20.2 V/m

Peak SAR (extrapolated) = 0.419 W/kg

SAR(1 g) = 0.330 mW/g; SAR(10 g) = 0.246 mW/g

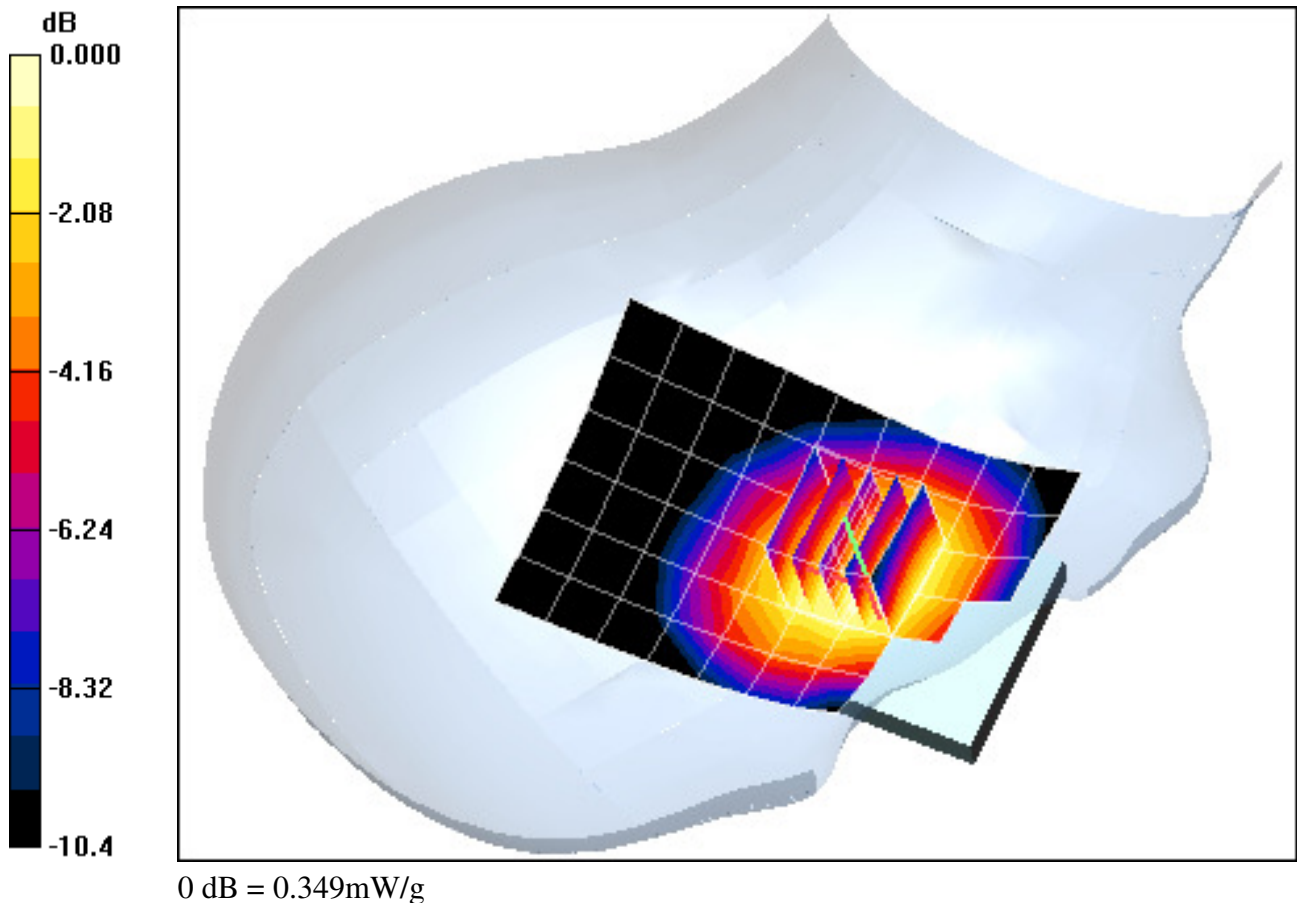

PCTEST ENGINEERING LABORATORY, INC.

**DUT: ZNFP690B; Type: 850/1900 GSM/GPRS/EDGE/WCDMA Phone
with Bluetooth and WLAN; Serial: 3**

Communication System: WCDMA850; Frequency: 836.6 MHz; Duty Cycle: 1:1
Medium: 835 Head; Medium parameters used (interpolated):
 $f = 836.6 \text{ MHz}$; $\sigma = 0.868 \text{ mho/m}$; $\epsilon_r = 40.1$; $\rho = 1000 \text{ kg/m}^3$
Phantom section: Right Section

Test Date: 07-18-2011; Ambient Temp: 23.3 °C; Tissue Temp: 21.5 °C

Probe: ES3DV3 - SN3258; ConvF(6.18, 6.18, 6.18); Calibrated: 4/8/2011
Sensor-Surface: 4mm (Mechanical Surface Detection)
Electronics: DAE4 Sn649; Calibrated: 2/21/2011
Phantom: SAM Sub; Type: SAM 4.0; Serial: TP-1357
Measurement SW: DASY4, V4.7 Build 80; Postprocessing SW: SEMCAD, V1.8 Build 186

Mode: WCDMA 850, Right Head, Tilt, Mid.ch

Area Scan (7x10x1): Measurement grid: dx=15mm, dy=15mm
Zoom Scan (5x5x7)/Cube 0: Measurement grid: dx=8mm, dy=8mm, dz=5mm
Reference Value = 15.3 V/m
Peak SAR (extrapolated) = 0.243 W/kg
SAR(1 g) = 0.195 mW/g; SAR(10 g) = 0.147 mW/g

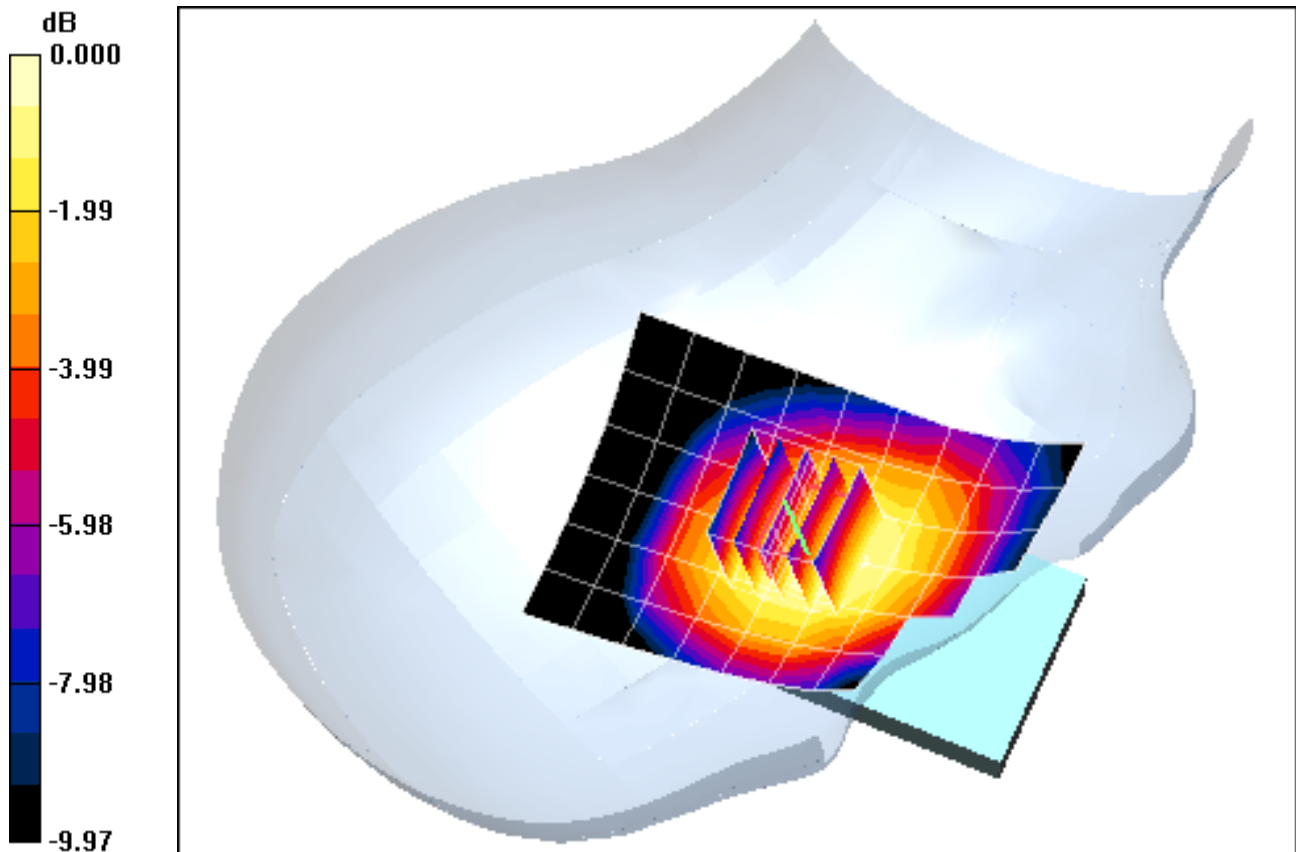

0 dB = 0.204mW/g

PCTEST ENGINEERING LABORATORY, INC.

**DUT: ZNFP690B; Type: 850/1900 GSM/GPRS/EDGE/WCDMA Phone
with Bluetooth and WLAN; Serial: 1**

Communication System: WCDMA850; Frequency: 836.6 MHz; Duty Cycle: 1:1
Medium: 835 Head; Medium parameters used (interpolated):
 $f = 836.6 \text{ MHz}$; $\sigma = 0.868 \text{ mho/m}$; $\epsilon_r = 40.1$; $\rho = 1000 \text{ kg/m}^3$

Phantom section: Left Section

Test Date: 07-18-2011; Ambient Temp: 23.3 °C; Tissue Temp: 21.5 °C

Probe: ES3DV3 - SN3258; ConvF(6.18, 6.18, 6.18); Calibrated: 4/8/2011
Sensor-Surface: 4mm (Mechanical Surface Detection)
Electronics: DAE4 Sn649; Calibrated: 2/21/2011
Phantom: SAM Sub; Type: SAM 4.0; Serial: TP-1357

Measurement SW: DASY4, V4.7 Build 80; Postprocessing SW: SEMCAD, V1.8 Build 186

Mode: WCDMA 850, Left Head, Touch, Mid.ch

Area Scan (7x10x1): Measurement grid: dx=15mm, dy=15mm

Zoom Scan (5x5x7)/Cube 0: Measurement grid: dx=8mm, dy=8mm, dz=5mm

Reference Value = 5.89 V/m

Peak SAR (extrapolated) = 0.607 W/kg

SAR(1 σ) = 0.455 mW/g; SAR(10 σ) = 0.332 mW/g

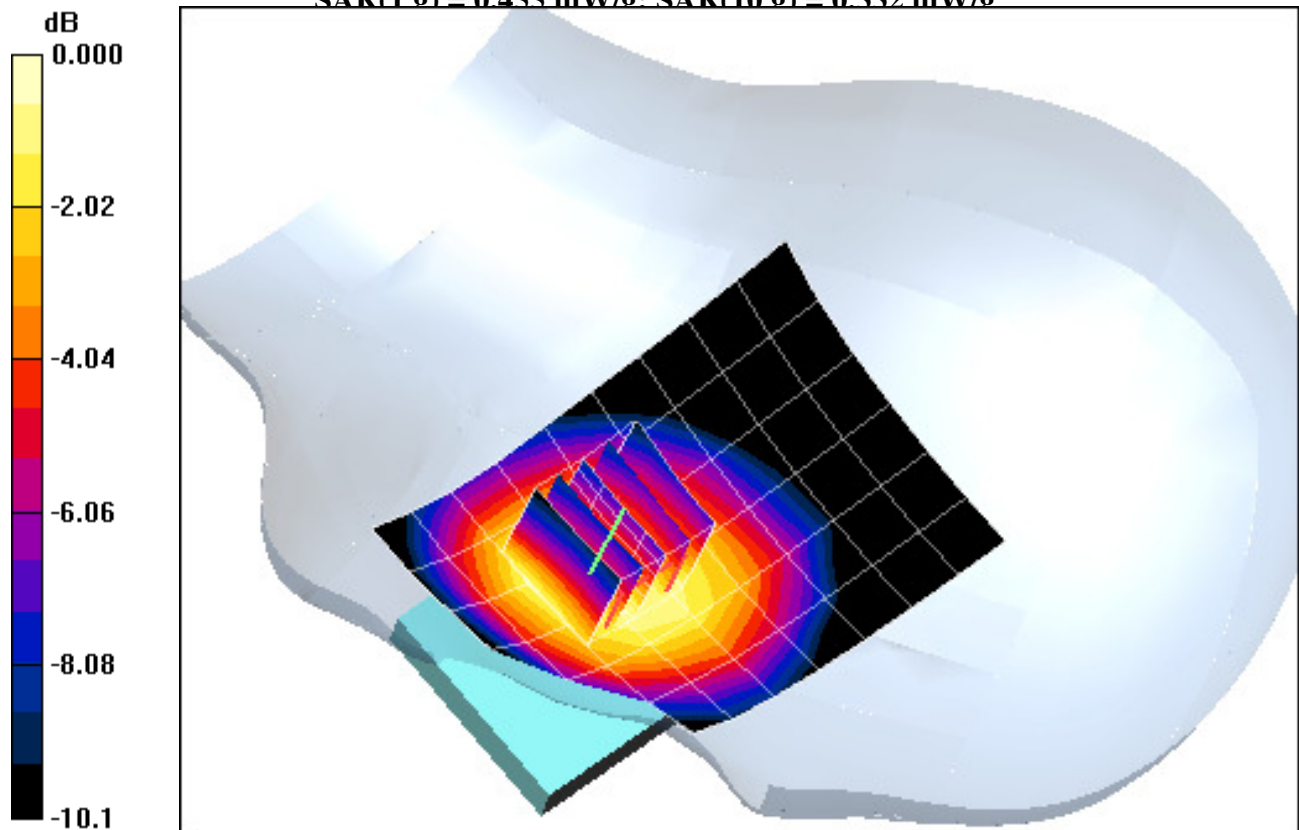

0 dB = 0.481mW/g

PCTEST ENGINEERING LABORATORY, INC.

**DUT: ZNFP690B; Type: 850/1900 GSM/GPRS/EDGE/WCDMA Phone
with Bluetooth and WLAN; Serial: 1**

Communication System: WCDMA850; Frequency: 836.6 MHz; Duty Cycle: 1:1
Medium: 835 Head; Medium parameters used (interpolated):
 $f = 836.6 \text{ MHz}$; $\sigma = 0.868 \text{ mho/m}$; $\epsilon_r = 40.1$; $\rho = 1000 \text{ kg/m}^3$
Phantom section: Left Section

Test Date: 07-18-2011; Ambient Temp: 23.3 °C; Tissue Temp: 21.5 °C

Probe: ES3DV3 - SN3258; ConvF(6.18, 6.18, 6.18); Calibrated: 4/8/2011
Sensor-Surface: 4mm (Mechanical Surface Detection)
Electronics: DAE4 Sn649; Calibrated: 2/21/2011
Phantom: SAM Sub; Type: SAM 4.0; Serial: TP-1357
Measurement SW: DASY4, V4.7 Build 80; Postprocessing SW: SEMCAD, V1.8 Build 186

Mode: WCDMA 850, Left Head, Touch, Mid.ch

Area Scan (7x10x1): Measurement grid: dx=15mm, dy=15mm

Zoom Scan (5x5x7)/Cube 0: Measurement grid: dx=8mm, dy=8mm, dz=5mm

Reference Value = 5.89 V/m

Peak SAR (extrapolated) = 0.607 W/kg

SAR(1 g) = 0.455 mW/g; SAR(10 g) = 0.332 mW/g

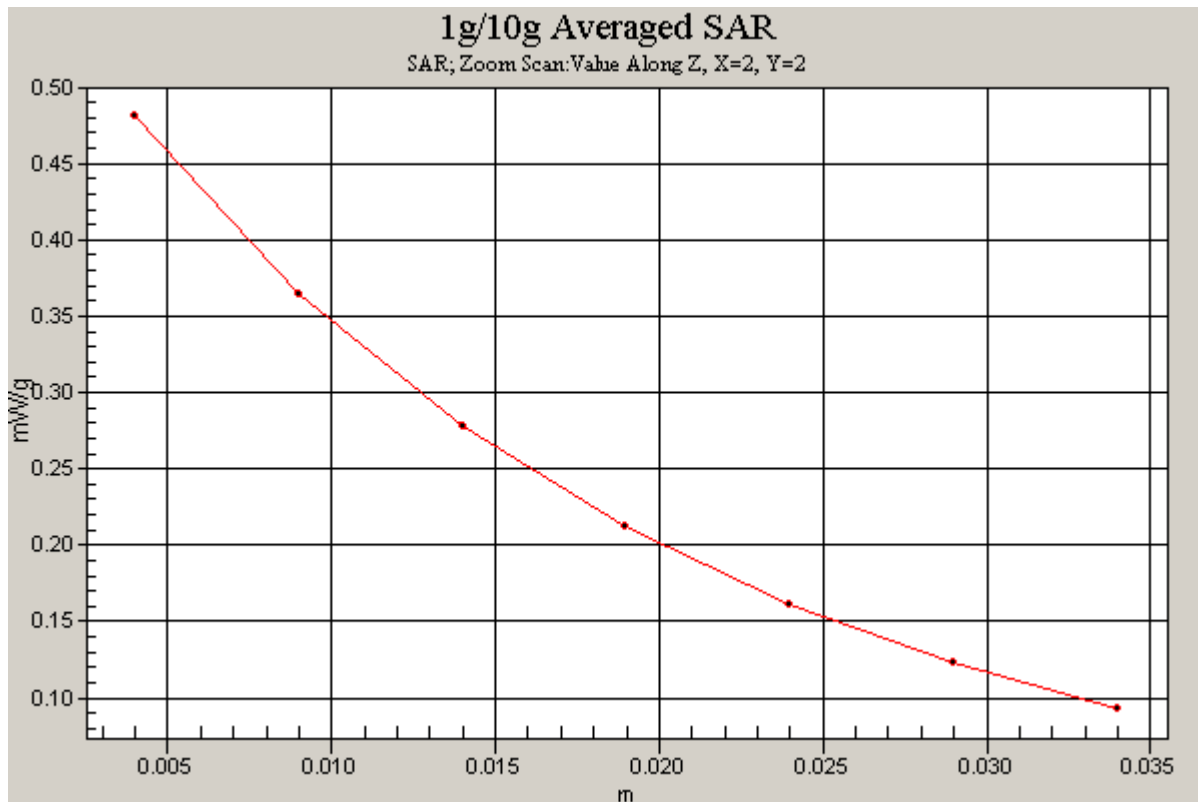

PCTEST ENGINEERING LABORATORY, INC.

**DUT: ZNFP690B; Type: 850/1900 GSM/GPRS/EDGE/WCDMA Phone
with Bluetooth and WLAN; Serial: 1**

Communication System: WCDMA850; Frequency: 836.6 MHz; Duty Cycle: 1:1
Medium: 835 Head; Medium parameters used (interpolated):
 $f = 836.6 \text{ MHz}$; $\sigma = 0.868 \text{ mho/m}$; $\epsilon_r = 40.1$; $\rho = 1000 \text{ kg/m}^3$
Phantom section: Left Section

Test Date: 07-18-2011; Ambient Temp: 23.3 °C; Tissue Temp: 21.5 °C

Probe: ES3DV3 - SN3258; ConvF(6.18, 6.18, 6.18); Calibrated: 4/8/2011
Sensor-Surface: 4mm (Mechanical Surface Detection)
Electronics: DAE4 Sn649; Calibrated: 2/21/2011
Phantom: SAM Sub; Type: SAM 4.0; Serial: TP-1357

Measurement SW: DASY4, V4.7 Build 80; Postprocessing SW: SEMCAD, V1.8 Build 186

Mode: WCDMA 850, Left Head, Tilt, Mid.ch

Area Scan (7x10x1): Measurement grid: dx=15mm, dy=15mm

Zoom Scan (5x5x7)/Cube 0: Measurement grid: dx=8mm, dy=8mm, dz=5mm

Reference Value = 9.91 V/m

Peak SAR (extrapolated) = 0.319 W/kg

SAR(1 g) = 0.256 mW/g; SAR(10 g) = 0.195 mW/g

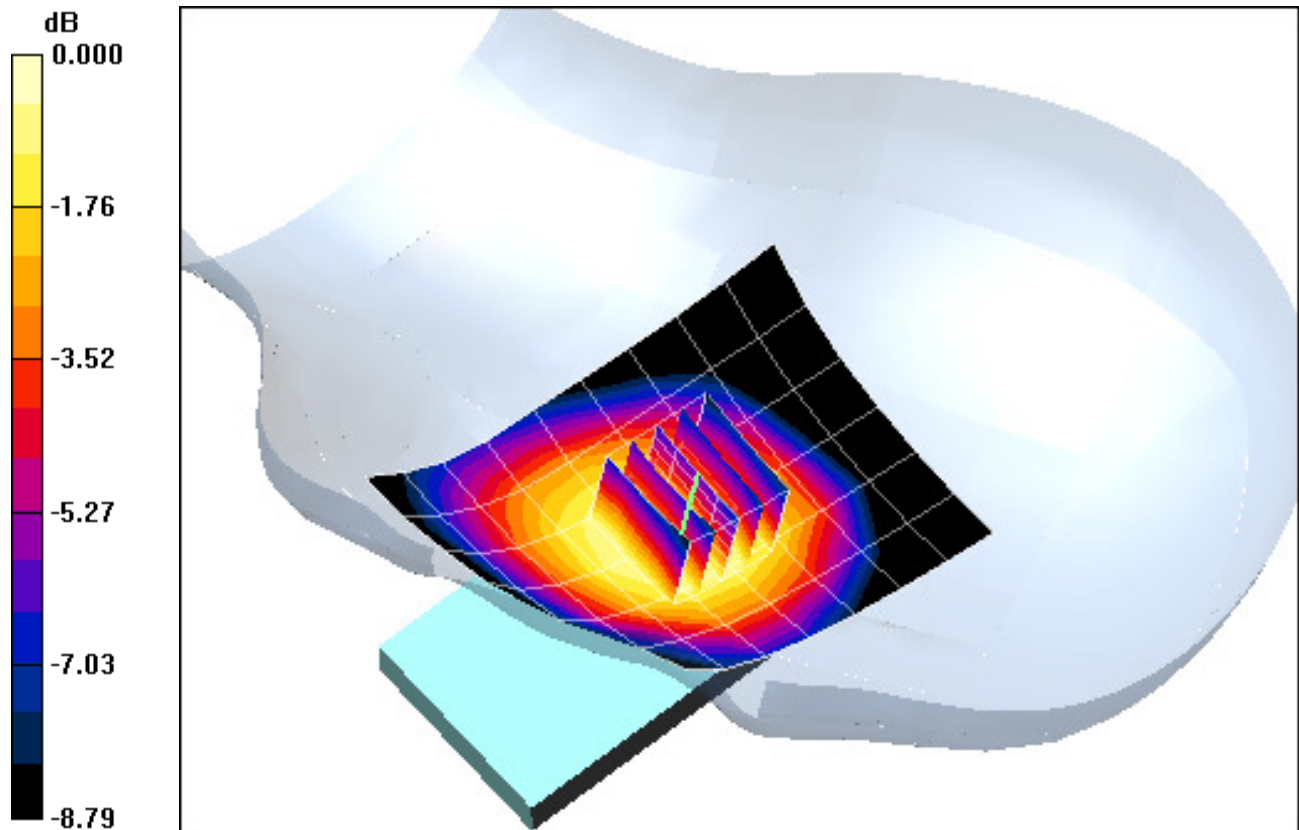

0 dB = 0.269mW/g

PCTEST ENGINEERING LABORATORY, INC.

**DUT: ZNFP690B; Type: 850/1900 GSM/GPRS/EDGE/WCDMA Phone
with Bluetooth and WLAN; Serial: 3**

Communication System: WCDMA1900; Frequency: 1880 MHz; Duty Cycle: 1:1

Medium: 1900 Head; Medium parameters used:

$f = 1880 \text{ MHz}$; $\sigma = 1.42 \text{ mho/m}$; $\epsilon_r = 38.2$; $\rho = 1000 \text{ kg/m}^3$

Phantom section: Right Section

Test Date: 07-21-2011; Ambient Temp: 24.8 °C; Tissue Temp: 23.1 °C

Probe: EX3DV4 - SN3550; ConvF(7.01, 7.01, 7.01); Calibrated: 2/14/2011

Sensor-Surface: 4mm (Mechanical Surface Detection)

Electronics: DAE4 Sn665; Calibrated: 4/20/2011

Phantom: SAM Main; Type: SAM 4.0; Serial: TP-1114

Measurement SW: DASY4, V4.7 Build 80; Postprocessing SW: SEMCAD, V1.8 Build 186

Mode: WCDMA 1900, Right Head, Touch, Mid.ch

Area Scan (7x11x1): Measurement grid: dx=15mm, dy=15mm

Zoom Scan (5x5x7)/Cube 0: Measurement grid: dx=8mm, dy=8mm, dz=5mm

Reference Value = 20.1 V/m

Peak SAR (extrapolated) = 0.863 W/kg

SAR(1 g) = 0.548 mW/g; SAR(10 g) = 0.333 mW/g

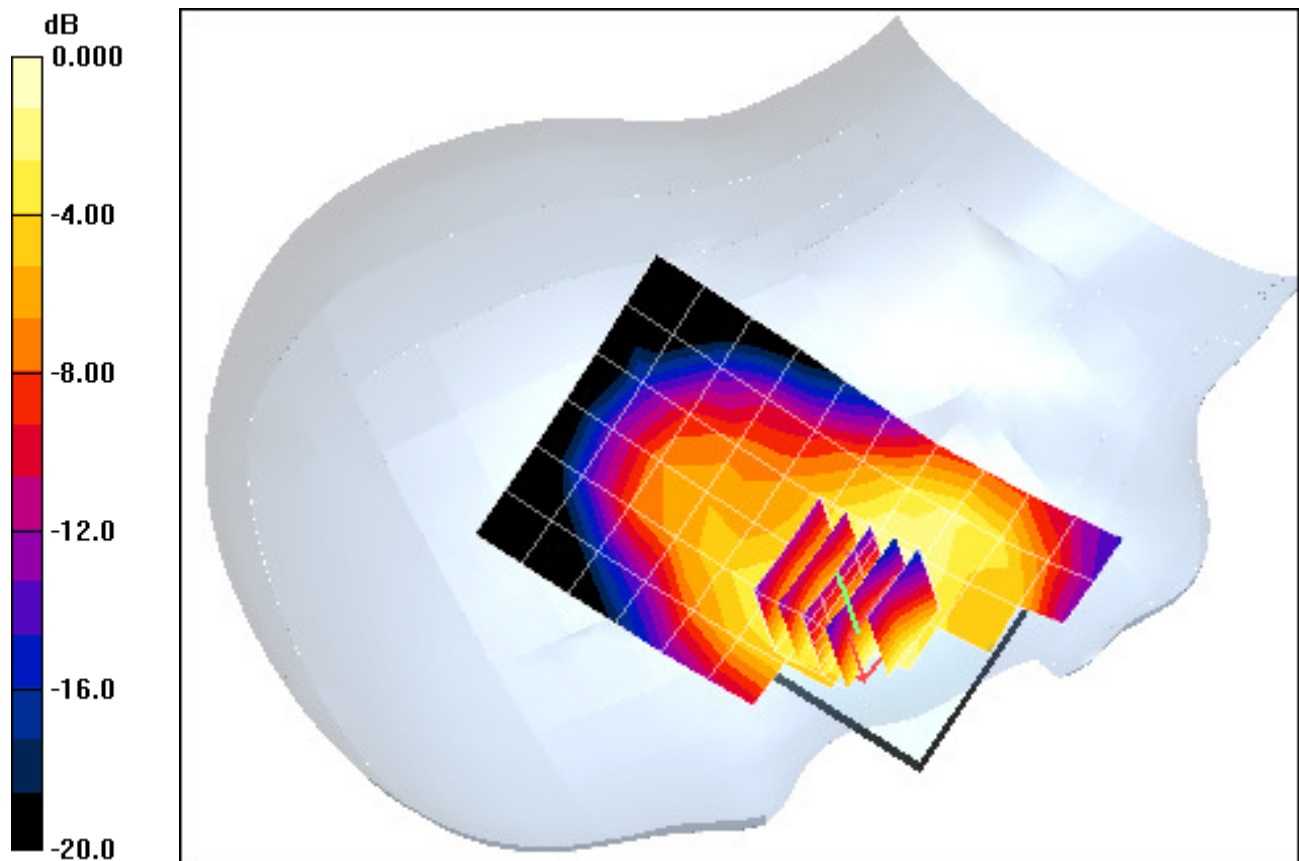

0 dB = 0.589mW/g

PCTEST ENGINEERING LABORATORY, INC.

**DUT: ZNFP690B; Type: 850/1900 GSM/GPRS/EDGE/WCDMA Phone
with Bluetooth and WLAN; Serial: 3**

Communication System: WCDMA1900; Frequency: 1880 MHz; Duty Cycle: 1:1

Medium: 1900 Head; Medium parameters used:

$f = 1880 \text{ MHz}$; $\sigma = 1.42 \text{ mho/m}$; $\epsilon_r = 38.2$; $\rho = 1000 \text{ kg/m}^3$

Phantom section: Right Section

Test Date: 07-21-2011; Ambient Temp: 24.8 °C; Tissue Temp: 23.1 °C

Probe: EX3DV4 - SN3550; ConvF(7.01, 7.01, 7.01); Calibrated: 2/14/2011

Sensor-Surface: 4mm (Mechanical Surface Detection)

Electronics: DAE4 Sn665; Calibrated: 4/20/2011

Phantom: SAM Main; Type: SAM 4.0; Serial: TP-1114

Measurement SW: DASY4, V4.7 Build 80; Postprocessing SW: SEMCAD, V1.8 Build 186

Mode: WCDMA 1900, Right Head, Tilt, Mid.ch

Area Scan (7x11x1): Measurement grid: dx=15mm, dy=15mm

Zoom Scan (5x5x7)/Cube 0: Measurement grid: dx=8mm, dy=8mm, dz=5mm

Reference Value = 14.8 V/m

Peak SAR (extrapolated) = 0.511 W/kg

SAR(1 g) = 0.319 mW/g; SAR(10 g) = 0.187 mW/g

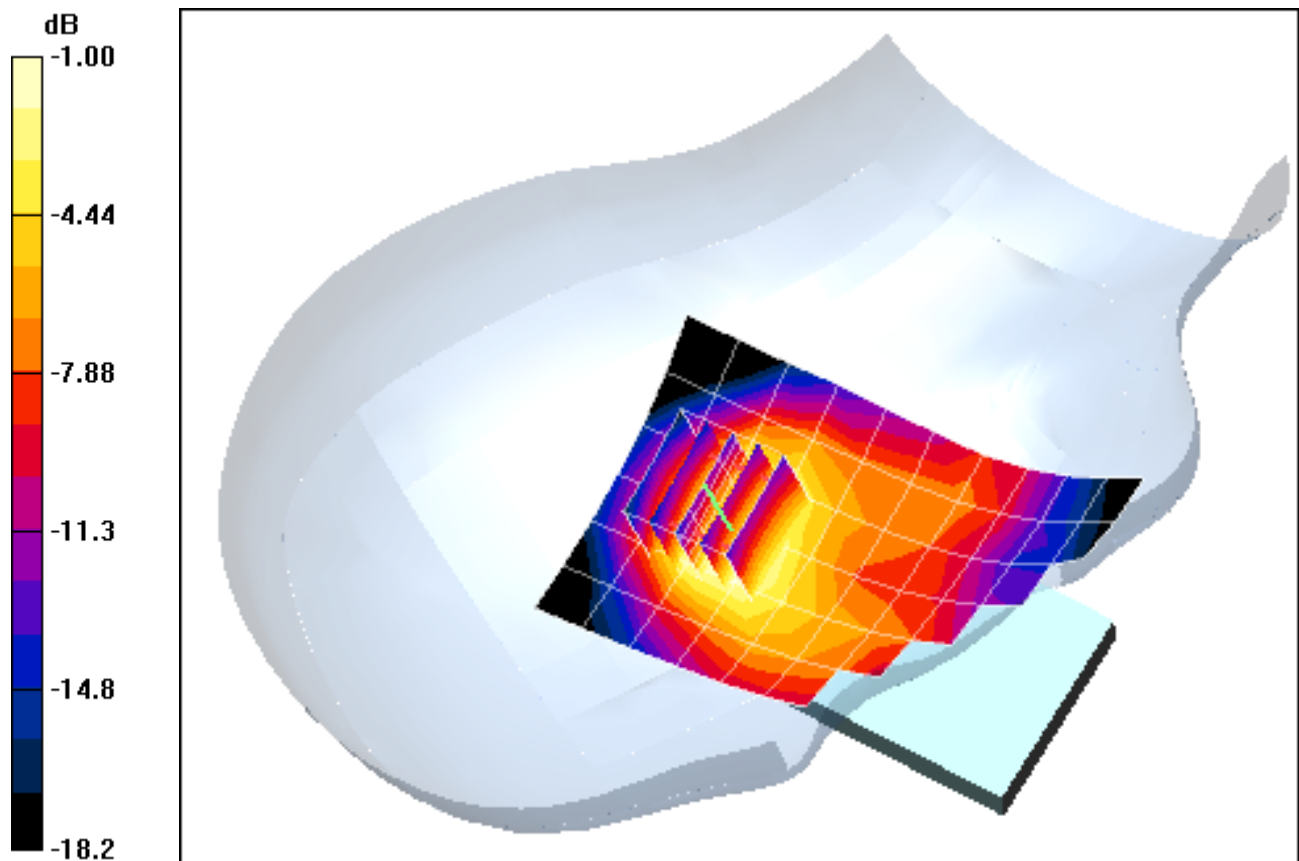

0 dB = 0.350mW/g

PCTEST ENGINEERING LABORATORY, INC.

**DUT: ZNFP690B; Type: 850/1900 GSM/GPRS/EDGE/WCDMA Phone
with Bluetooth and WLAN; Serial: 1**

Communication System: WCDMA1900; Frequency: 1852.4 MHz; Duty Cycle: 1:1
Medium: 1900 Head Medium parameters used (interpolated):
 $f = 1852.4 \text{ MHz}$; $\sigma = 1.41 \text{ mho/m}$; $\epsilon_r = 38.3$; $\rho = 1000 \text{ kg/m}^3$
Phantom section: Left Section

Test Date: 07-21-2011; Ambient Temp: 24.8 °C; Tissue Temp: 23.1 °C

Probe: EX3DV4 - SN3550; ConvF(7.01, 7.01, 7.01); Calibrated: 2/14/2011
Sensor-Surface: 4mm (Mechanical Surface Detection)
Electronics: DAE4 Sn665; Calibrated: 4/20/2011
Phantom: SAM Main; Type: SAM 4.0; Serial: TP-1114
Measurement SW: DASY4, V4.7 Build 80; Postprocessing SW: SEMCAD, V1.8 Build 186

Mode: WCDMA 1900, Left Head, Touch, Low ch

Area Scan (7x11x1): Measurement grid: dx=15mm, dy=15mm
Zoom Scan (5x5x7)/Cube 0: Measurement grid: dx=8mm, dy=8mm, dz=5mm
Reference Value = 29.9 V/m
Peak SAR (extrapolated) = 1.86 W/kg
SAR(1 g) = 1.12 mW/g; SAR(10 g) = 0.616 mW/g

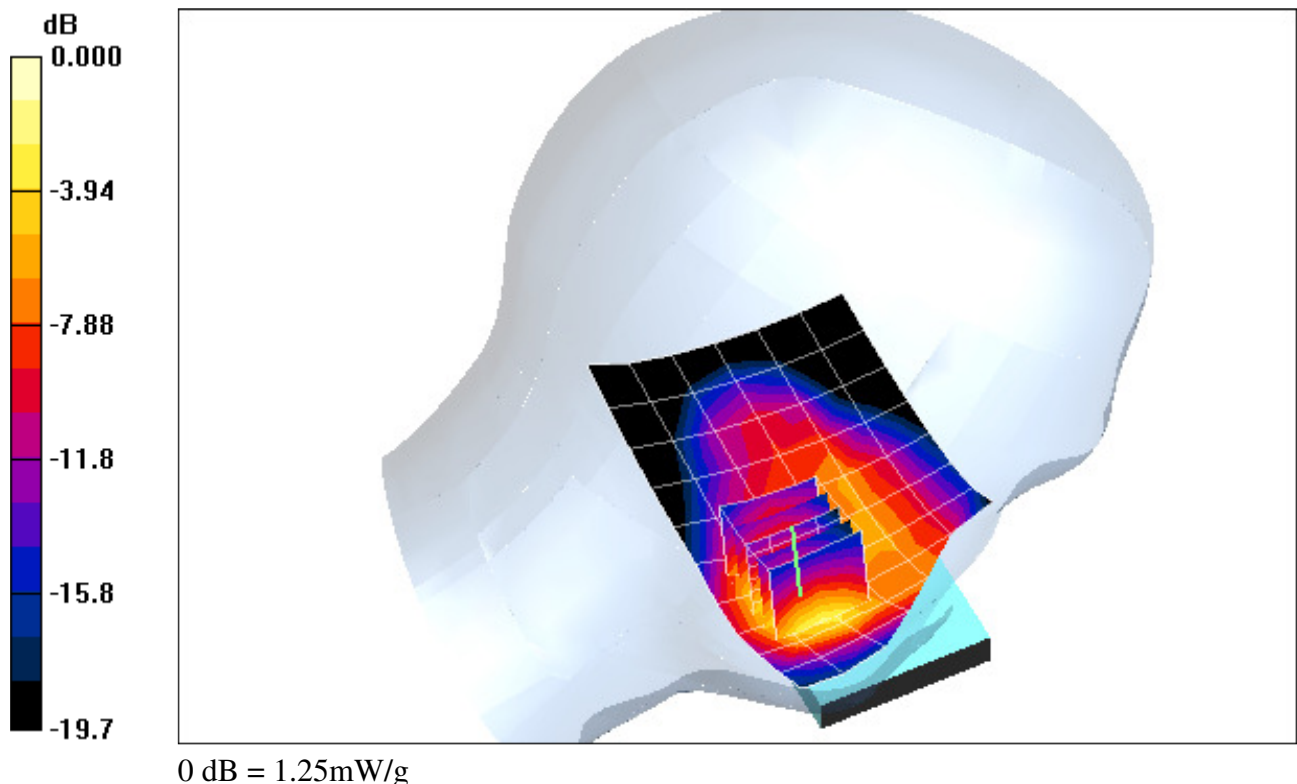

PCTEST ENGINEERING LABORATORY, INC.

**DUT: ZNFP690B; Type: 850/1900 GSM/GPRS/EDGE/WCDMA Phone
with Bluetooth and WLAN; Serial: 1**

Communication System: WCDMA1900; Frequency: 1852.4 MHz; Duty Cycle: 1:1
Medium: 1900 Head Medium parameters used (interpolated):
 $f = 1852.4 \text{ MHz}$; $\sigma = 1.41 \text{ mho/m}$; $\epsilon_r = 38.3$; $\rho = 1000 \text{ kg/m}^3$
Phantom section: Left Section

Test Date: 07-21-2011; Ambient Temp: 24.8 °C; Tissue Temp: 23.1 °C

Probe: EX3DV4 - SN3550; ConvF(7.01, 7.01, 7.01); Calibrated: 2/14/2011
Sensor-Surface: 4mm (Mechanical Surface Detection)
Electronics: DAE4 Sn665; Calibrated: 4/20/2011
Phantom: SAM Main; Type: SAM 4.0; Serial: TP-1114
Measurement SW: DASY4, V4.7 Build 80; Postprocessing SW: SEMCAD, V1.8 Build 186

Mode: WCDMA 1900, Left Head, Touch, Low ch

Area Scan (7x11x1): Measurement grid: dx=15mm, dy=15mm
Zoom Scan (5x5x7)/Cube 0: Measurement grid: dx=8mm, dy=8mm, dz=5mm
Reference Value = 29.9 V/m
Peak SAR (extrapolated) = 1.86 W/kg
SAR(1 g) = 1.12 mW/g; SAR(10 g) = 0.616 mW/g

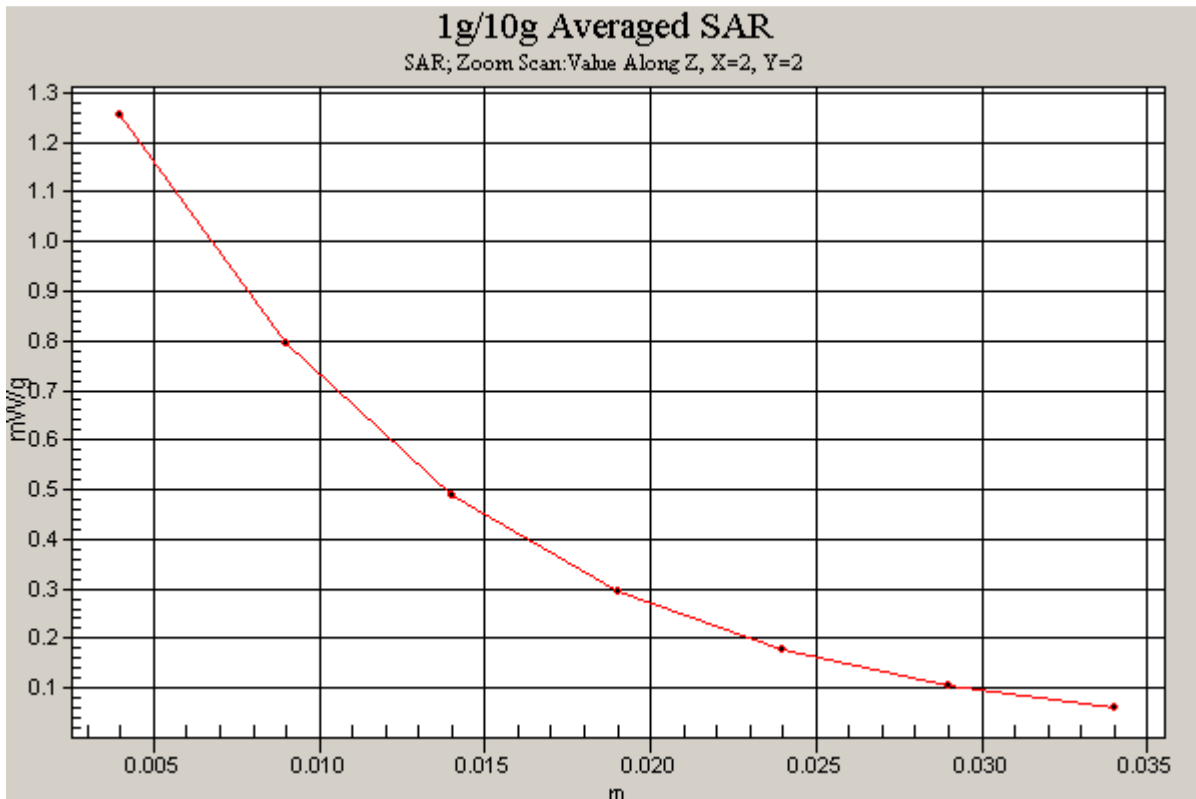

PCTEST ENGINEERING LABORATORY, INC.

**DUT: ZNFP690B; Type: 850/1900 GSM/GPRS/EDGE/WCDMA Phone
with Bluetooth and WLAN; Serial: 1**

Communication System: WCDMA1900; Frequency: 1880 MHz; Duty Cycle: 1:1
Medium: 1900 Head; Medium parameters used:
 $f = 1880 \text{ MHz}$; $\sigma = 1.42 \text{ mho/m}$; $\epsilon_r = 38.2$; $\rho = 1000 \text{ kg/m}^3$
Phantom section: Left Section; Space: 1.0 cm

Test Date: 07-21-2011; Ambient Temp: 24.8 °C; Tissue Temp: 23.1 °C

Probe: EX3DV4 - SN3550; ConvF(7.01, 7.01, 7.01); Calibrated: 2/14/2011
Sensor-Surface: 4mm (Mechanical Surface Detection)
Electronics: DAE4 Sn665; Calibrated: 4/20/2011
Phantom: SAM Main; Type: SAM 4.0; Serial: TP-1114
Measurement SW: DASY4, V4.7 Build 80; Postprocessing SW: SEMCAD, V1.8 Build 186

Mode: WCDMA 1900, Left Head, Tilt, Mid.ch

Area Scan (7x11x1): Measurement grid: dx=15mm, dy=15mm
Zoom Scan (5x5x7)/Cube 0: Measurement grid: dx=8mm, dy=8mm, dz=5mm
Reference Value = 15.0 V/m
Peak SAR (extrapolated) = 0.471 W/kg
SAR(1 g) = 0.294 mW/g; SAR(10 g) = 0.174 mW/g

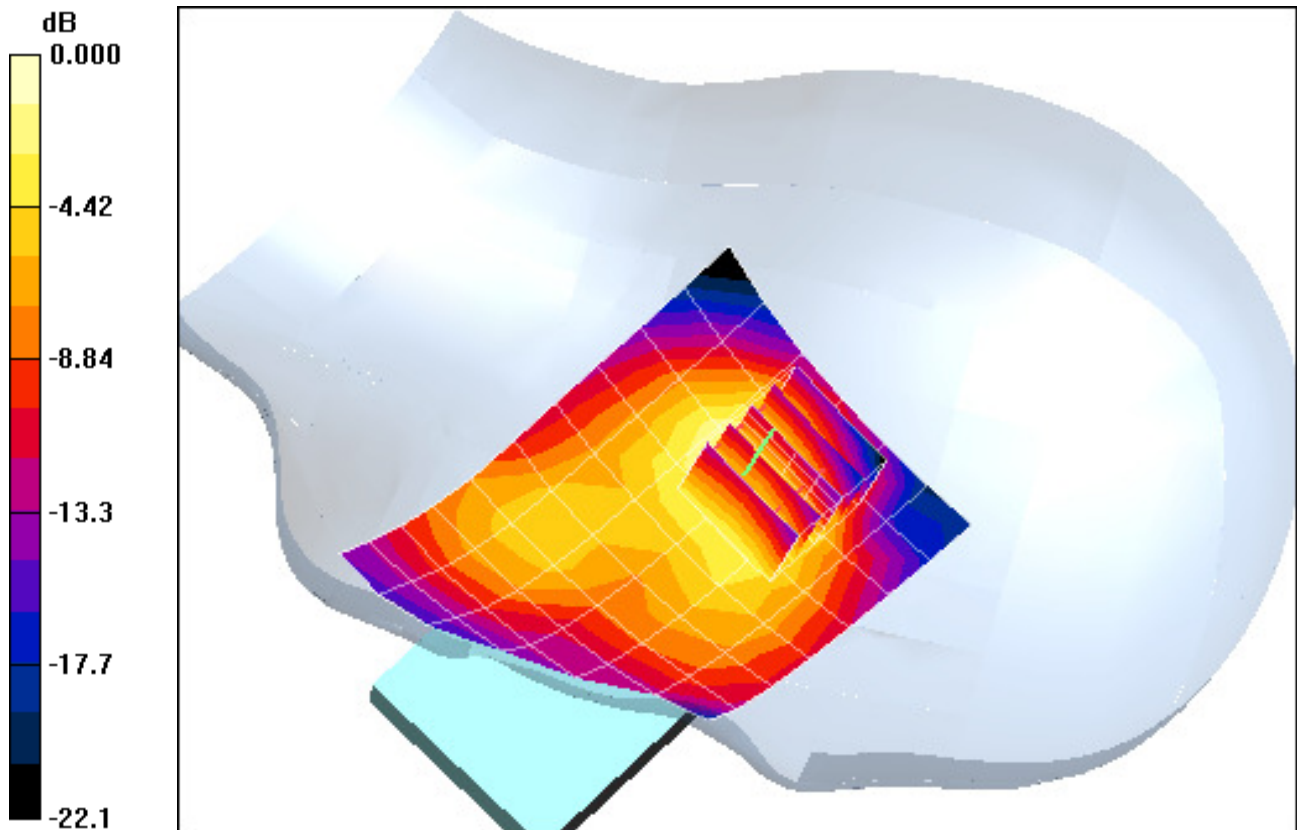

0 dB = 0.317mW/g

PCTEST ENGINEERING LABORATORY, INC.

**DUT: ZNFP690B; Type: 850/1900 GSM/GPRS/EDGE/WCDMA Phone
with Bluetooth and WLAN; Serial: 3**

Communication System: IEEE 802.11b; Frequency: 2462 MHz; Duty Cycle: 1:1

Medium: 2450 Head Medium parameters used (interpolated):

$f = 2462 \text{ MHz}$; $\sigma = 1.8 \text{ mho/m}$; $\epsilon_r = 38.7$; $\rho = 1000 \text{ kg/m}^3$

Phantom section: Right Section

Test Date: 08-01-2011; Ambient Temp: 23.7°C; Tissue Temp: 22.3°C

Probe: EX3DV4 - SN3550; ConvF(6.29, 6.29, 6.29); Calibrated: 2/14/2011

Sensor-Surface: 3mm (Mechanical Surface Detection)

Electronics: DAE4 Sn665; Calibrated: 4/20/2011

Phantom: SAM Main; Type: SAM 4.0; Serial: TP-1114

Measurement SW: DASY4, V4.7 Build 80; Postprocessing SW: SEMCAD, V1.8 Build 186

Mode: IEEE 802.11b, Right Head, Touch, Ch 11, 1 Mbps

Area Scan (7x11x1): Measurement grid: dx=15mm, dy=15mm

Zoom Scan (5x5x7)/Cube 0: Measurement grid: dx=8mm, dy=8mm, dz=5mm

Reference Value = 12.7 V/m

Peak SAR (extrapolated) = 0.568 W/kg

SAR(1 g) = 0.274 mW/g; SAR(10 g) = 0.138 mW/g

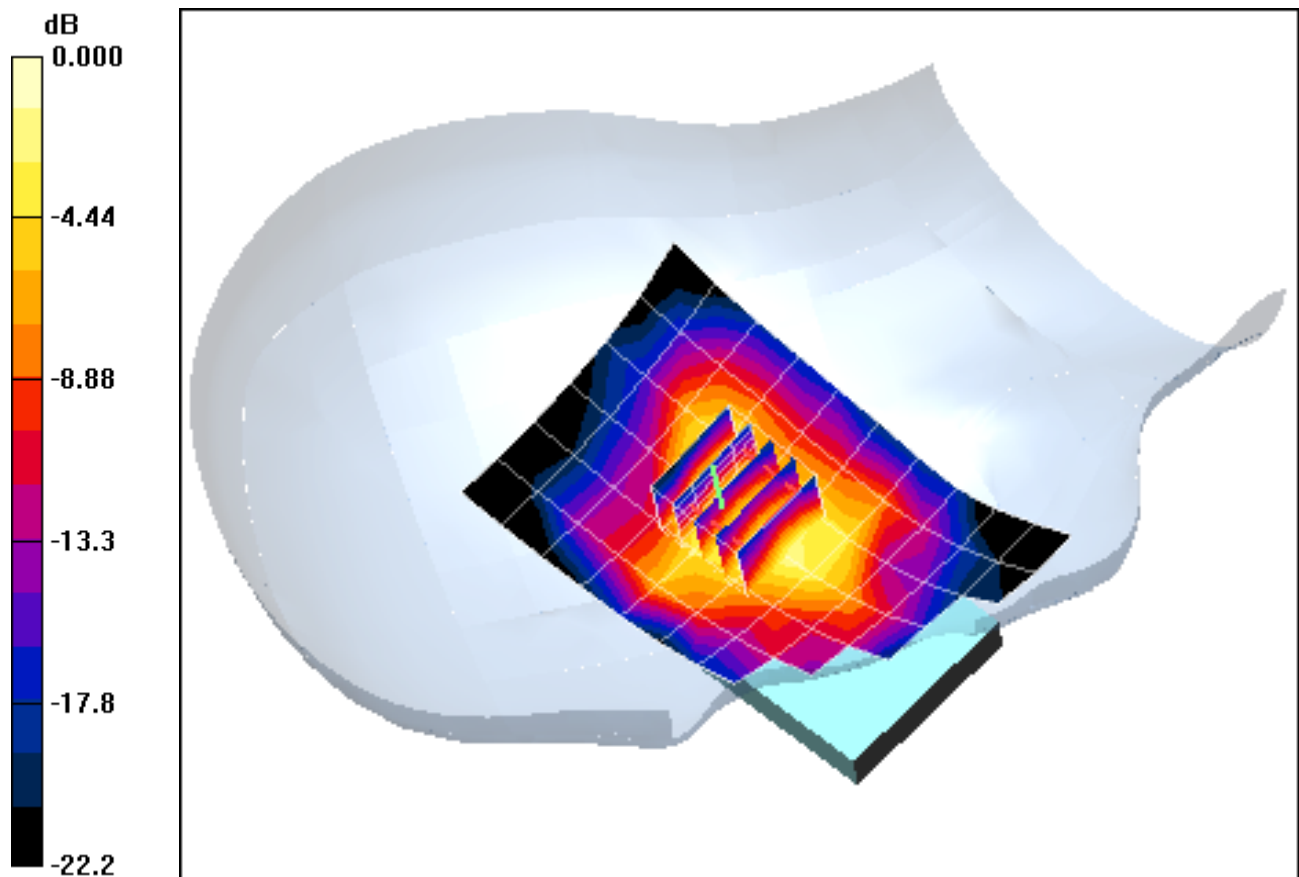

0 dB = 0.326mW/g

PCTEST ENGINEERING LABORATORY, INC.

**DUT: ZNFP690B; Type: 850/1900 GSM/GPRS/EDGE/WCDMA Phone
with Bluetooth and WLAN; Serial: 3**

Communication System: IEEE 802.11b; Frequency: 2462 MHz; Duty Cycle: 1:1
Medium: 2450 Head Medium parameters used (interpolated):

$$f = 2462 \text{ MHz}; \sigma = 1.8 \text{ mho/m}; \epsilon_r = 38.7; \rho = 1000 \text{ kg/m}^3$$

Phantom section: Right Section

Test Date: 08-01-2011; Ambient Temp: 23.7°C; Tissue Temp: 22.3°C

Probe: EX3DV4 - SN3550; ConvF(6.29, 6.29, 6.29); Calibrated: 2/14/2011

Sensor-Surface: 3mm (Mechanical Surface Detection)

Electronics: DAE4 Sn665; Calibrated: 4/20/2011

Phantom: SAM Main; Type: SAM 4.0; Serial: TP-1114

Measurement SW: DASY4, V4.7 Build 80; Postprocessing SW: SEMCAD, V1.8 Build 186

Mode: IEEE 802.11b, Right Head, Tilt, Ch 11, 1 Mbps

Area Scan (7x11x1): Measurement grid: dx=15mm, dy=15mm

Zoom Scan (5x5x7)/Cube 0: Measurement grid: dx=8mm, dy=8mm, dz=5mm

Reference Value = 7.27 V/m

Peak SAR (extrapolated) = 0.165 W/kg

SAR(1 g) = 0.083 mW/g; SAR(10 g) = 0.041 mW/g

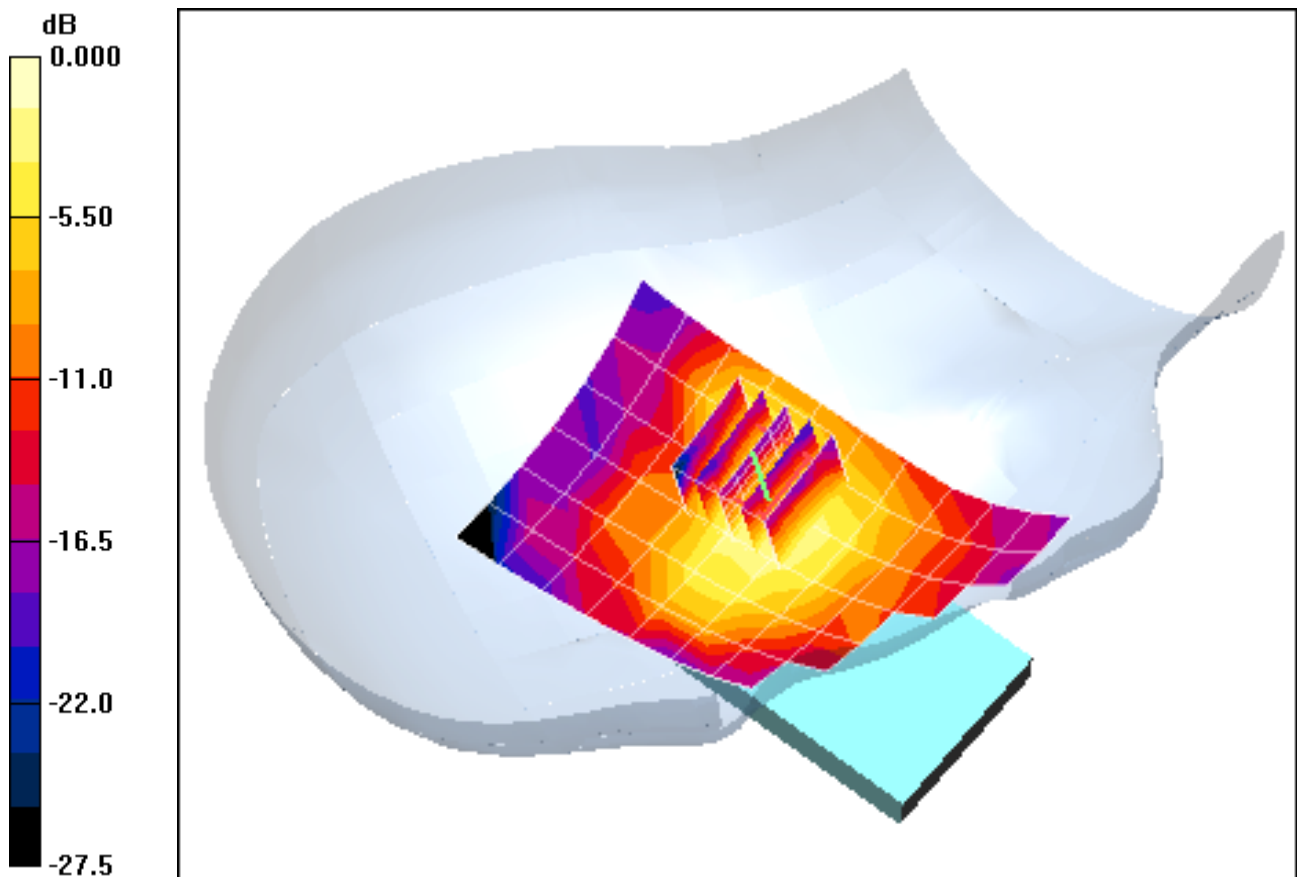

0 dB = 0.105mW/g

PCTEST ENGINEERING LABORATORY, INC.

**DUT: ZNFP690B; Type: 850/1900 GSM/GPRS/EDGE/WCDMA Phone
with Bluetooth and WLAN; Serial: 3**

Communication System: IEEE 802.11b; Frequency: 2462 MHz; Duty Cycle: 1:1
Medium: 2450 Head Medium parameters used (interpolated):
 $f = 2462 \text{ MHz}; \sigma = 1.8 \text{ mho/m}; \epsilon_r = 38.7; \rho = 1000 \text{ kg/m}^3$
Phantom section: Left Section

Test Date: 08-01-2011; Ambient Temp: 23.7°C; Tissue Temp: 22.3°C

Probe: EX3DV4 - SN3550; ConvF(6.29, 6.29, 6.29); Calibrated: 2/14/2011
Sensor-Surface: 3mm (Mechanical Surface Detection)
Electronics: DAE4 Sn665; Calibrated: 4/20/2011
Phantom: SAM Main; Type: SAM 4.0; Serial: TP-1114
Measurement SW: DASY4, V4.7 Build 80; Postprocessing SW: SEMCAD, V1.8 Build 186

Mode: IEEE 802.11b, Left Head, Touch, Ch 11, 1 Mbps

Area Scan (7x11x1): Measurement grid: dx=15mm, dy=15mm
Zoom Scan (5x5x7)/Cube 0: Measurement grid: dx=8mm, dy=8mm, dz=5mm
Reference Value = 18.6 V/m
Peak SAR (extrapolated) = 1.18 W/kg
SAR(1 g) = 0.521 mW/g; SAR(10 g) = 0.223 mW/g

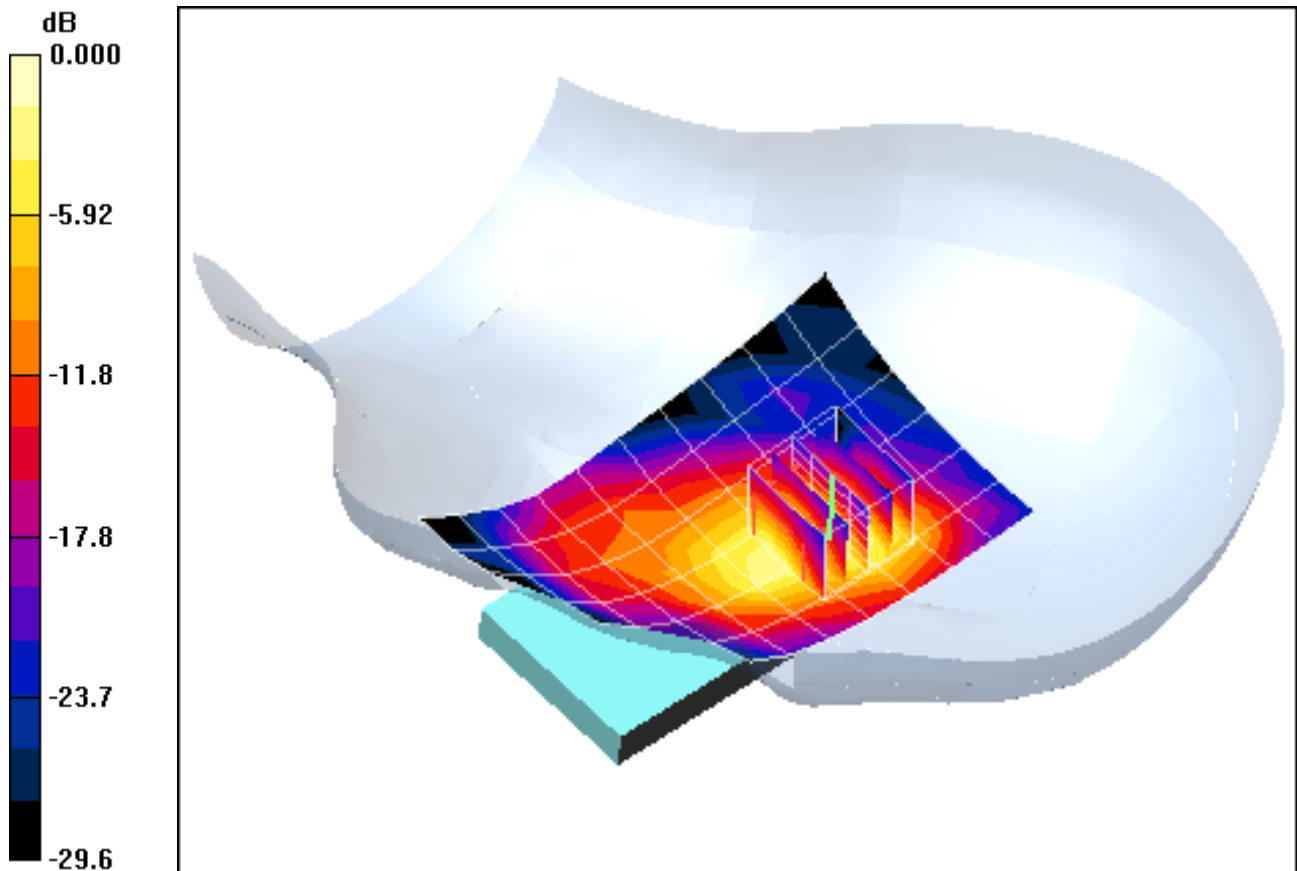

0 dB = 0.705mW/g

PCTEST ENGINEERING LABORATORY, INC.

**DUT: ZNFP690B; Type: 850/1900 GSM/GPRS/EDGE/WCDMA Phone
with Bluetooth and WLAN; Serial: 3**

Communication System: IEEE 802.11b; Frequency: 2462 MHz; Duty Cycle: 1:1
Medium: 2450 Head Medium parameters used (interpolated):
 $f = 2462 \text{ MHz}; \sigma = 1.8 \text{ mho/m}; \epsilon_r = 38.7; \rho = 1000 \text{ kg/m}^3$
Phantom section: Left Section

Test Date: 08-01-2011; Ambient Temp: 23.7°C; Tissue Temp: 22.3°C

Probe: EX3DV4 - SN3550; ConvF(6.29, 6.29, 6.29); Calibrated: 2/14/2011
Sensor-Surface: 3mm (Mechanical Surface Detection)
Electronics: DAE4 Sn665; Calibrated: 4/20/2011
Phantom: SAM Main; Type: SAM 4.0; Serial: TP-1114
Measurement SW: DASY4, V4.7 Build 80; Postprocessing SW: SEMCAD, V1.8 Build 186

Mode: IEEE 802.11b, Left Head, Touch, Ch 11, 1 Mbps

Area Scan (7x11x1): Measurement grid: dx=15mm, dy=15mm
Zoom Scan (5x5x7)/Cube 0: Measurement grid: dx=8mm, dy=8mm, dz=5mm
Reference Value = 18.6 V/m
Peak SAR (extrapolated) = 1.18 W/kg
SAR(1 g) = 0.521 mW/g; SAR(10 g) = 0.223 mW/g

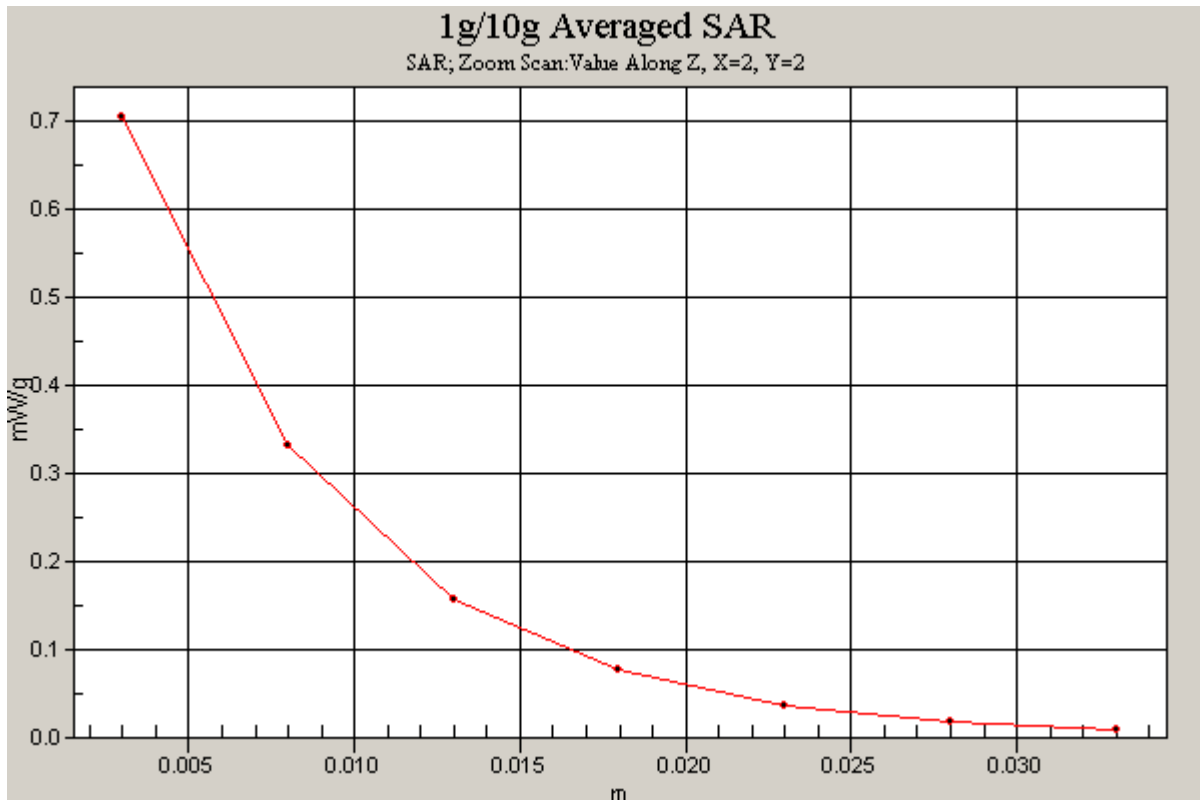

PCTEST ENGINEERING LABORATORY, INC.

**DUT: ZNFP690B; Type: 850/1900 GSM/GPRS/EDGE/WCDMA Phone
with Bluetooth and WLAN; Serial: 3**

Communication System: IEEE 802.11b; Frequency: 2462 MHz; Duty Cycle: 1:1

Medium: 2450 Head Medium parameters used (interpolated):

$f = 2462 \text{ MHz}$; $\sigma = 1.8 \text{ mho/m}$; $\epsilon_r = 38.7$; $\rho = 1000 \text{ kg/m}^3$

Phantom section: Left Section

Test Date: 08-01-2011; Ambient Temp: 23.7°C; Tissue Temp: 22.3°C

Probe: EX3DV4 - SN3550; ConvF(6.29, 6.29, 6.29); Calibrated: 2/14/2011

Sensor-Surface: 3mm (Mechanical Surface Detection)

Electronics: DAE4 Sn665; Calibrated: 4/20/2011

Phantom: SAM Main; Type: SAM 4.0; Serial: TP-1114

Measurement SW: DASY4, V4.7 Build 80; Postprocessing SW: SEMCAD, V1.8 Build 186

Mode: IEEE 802.11b, Left Head, Tilt, Ch 11, 1 Mbps

Area Scan (7x11x1): Measurement grid: dx=15mm, dy=15mm

Zoom Scan (5x5x7)/Cube 0: Measurement grid: dx=8mm, dy=8mm, dz=5mm

Reference Value = 10.2 V/m

Peak SAR (extrapolated) = 0.325 W/kg

SAR(1 g) = 0.153 mW/g; SAR(10 g) = 0.071 mW/g

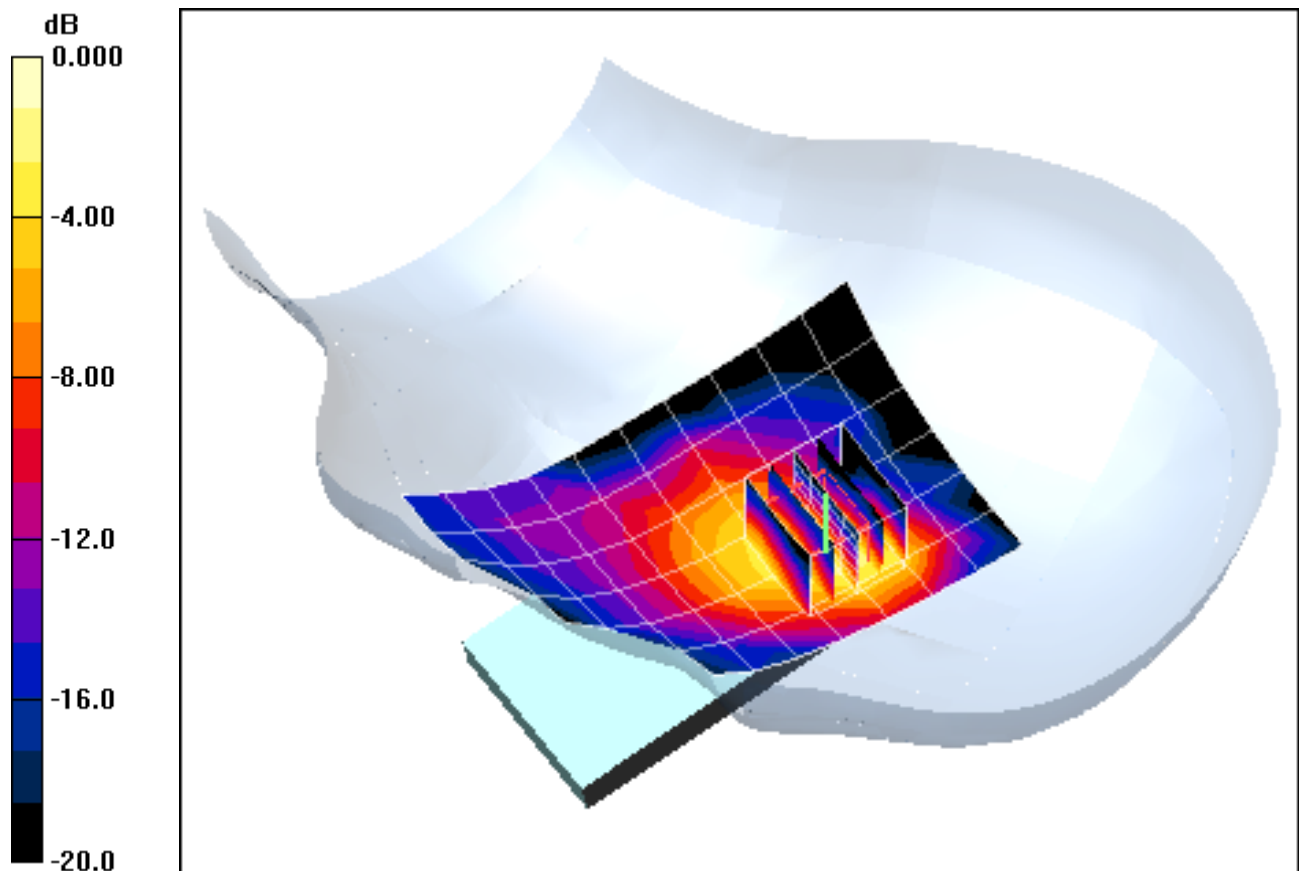

0 dB = 0.206mW/g

PCTEST ENGINEERING LABORATORY, INC.

**DUT: ZNFP690B; Type: 850/1900 GSM/GPRS/EDGE/WCDMA Phone
with Bluetooth and WLAN; Serial: 1**

Communication System: GSM850 GPRS; 4 Tx slots; Frequency: 836.6 MHz; Duty Cycle: 1:2.076
Medium: 835 Body; Medium parameters used (interpolated):
 $f = 836.6 \text{ MHz}$; $\sigma = 0.996 \text{ mho/m}$; $\epsilon_r = 55.3$; $\rho = 1000 \text{ kg/m}^3$
Phantom section: Flat Section; Space: 1.0 cm

Test Date: 07-21-2011; Ambient Temp: 23.6 °C; Tissue Temp: 21.9 °C

Probe: ES3DV3 - SN3258; ConvF(6.12, 6.12, 6.12); Calibrated: 4/8/2011
Sensor-Surface: 4mm (Mechanical Surface Detection)
Electronics: DAE4 Sn649; Calibrated: 2/21/2011
Phantom: SAM Main; Type: SAM 4.0; Serial: TP-1114

Measurement SW: DASY4, V4.7 Build 80; Postprocessing SW: SEMCAD, V1.8 Build 186

Mode: GPRS 850, Body SAR, Back side, Mid.ch, 4 Tx Slots

Area Scan (7x12x1): Measurement grid: dx=15mm, dy=15mm

Zoom Scan (5x5x7)/Cube 0: Measurement grid: dx=8mm, dy=8mm, dz=5mm

Reference Value = 27.3 V/m

Peak SAR (extrapolated) = 0.948 W/kg

SAR(1 g) = 0.691 mW/g; SAR(10 g) = 0.494 mW/g

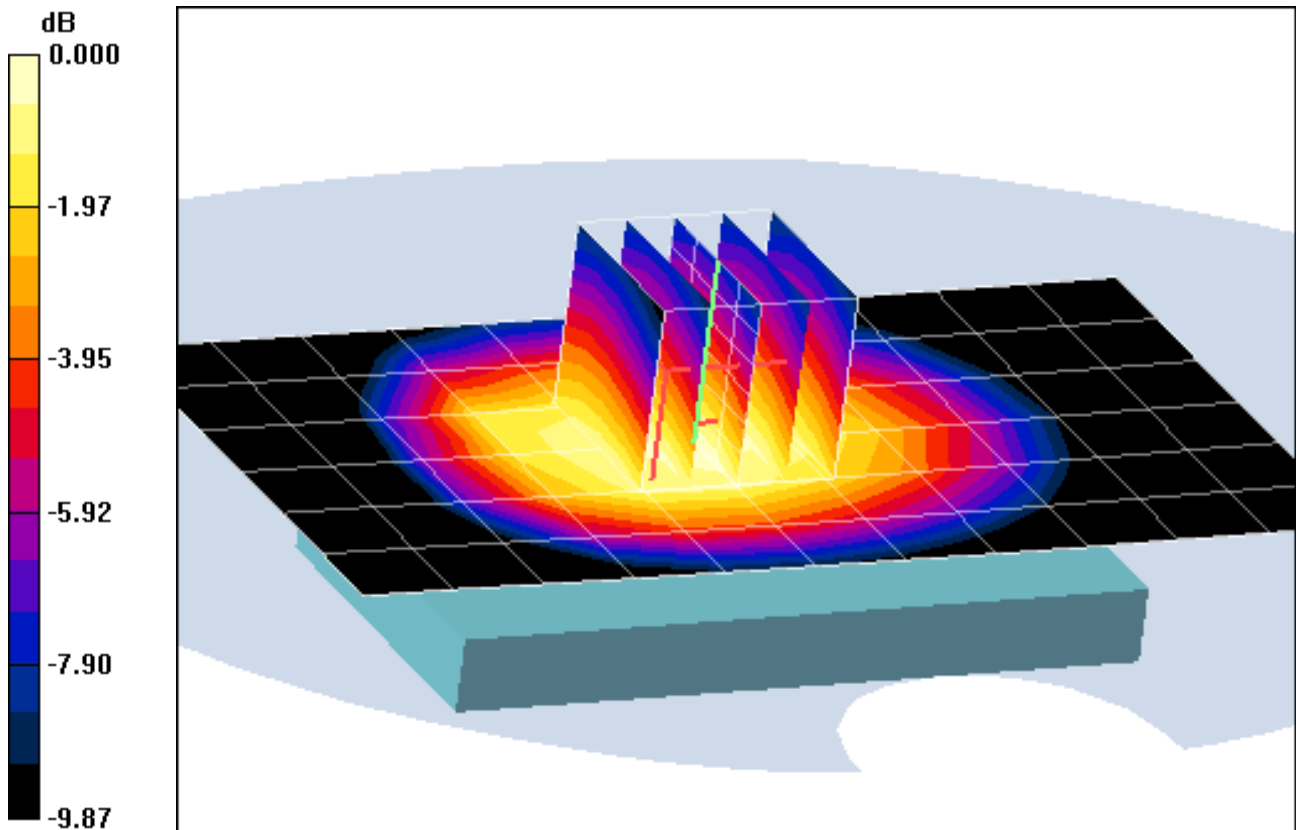

0 dB = 0.729mW/g

PCTEST ENGINEERING LABORATORY, INC.

**DUT: ZNFP690B; Type: 850/1900 GSM/GPRS/EDGE/WCDMA Phone
with Bluetooth and WLAN; Serial: 1**

Communication System: GSM850 GPRS; 4 Tx slots; Frequency: 836.6 MHz; Duty Cycle: 1:2.076
Medium: 835 Body; Medium parameters used (interpolated):
 $f = 836.6 \text{ MHz}$; $\sigma = 0.996 \text{ mho/m}$; $\epsilon_r = 55.3$; $\rho = 1000 \text{ kg/m}^3$
Phantom section: Flat Section; Space: 1.0 cm

Test Date: 07-21-2011; Ambient Temp: 23.6 °C; Tissue Temp: 21.9 °C

Probe: ES3DV3 - SN3258; ConvF(6.12, 6.12, 6.12); Calibrated: 4/8/2011
Sensor-Surface: 4mm (Mechanical Surface Detection)
Electronics: DAE4 Sn649; Calibrated: 2/21/2011
Phantom: SAM Main; Type: SAM 4.0; Serial: TP-1114

Measurement SW: DASY4, V4.7 Build 80; Postprocessing SW: SEMCAD, V1.8 Build 186

Mode: GPRS 850, Body SAR, Back side, Mid.ch, 4 Tx Slots

Area Scan (7x12x1): Measurement grid: dx=15mm, dy=15mm

Zoom Scan (5x5x7)/Cube 0: Measurement grid: dx=8mm, dy=8mm, dz=5mm

Reference Value = 27.3 V/m

Peak SAR (extrapolated) = 0.948 W/kg

SAR(1 g) = 0.691 mW/g; SAR(10 g) = 0.494 mW/g

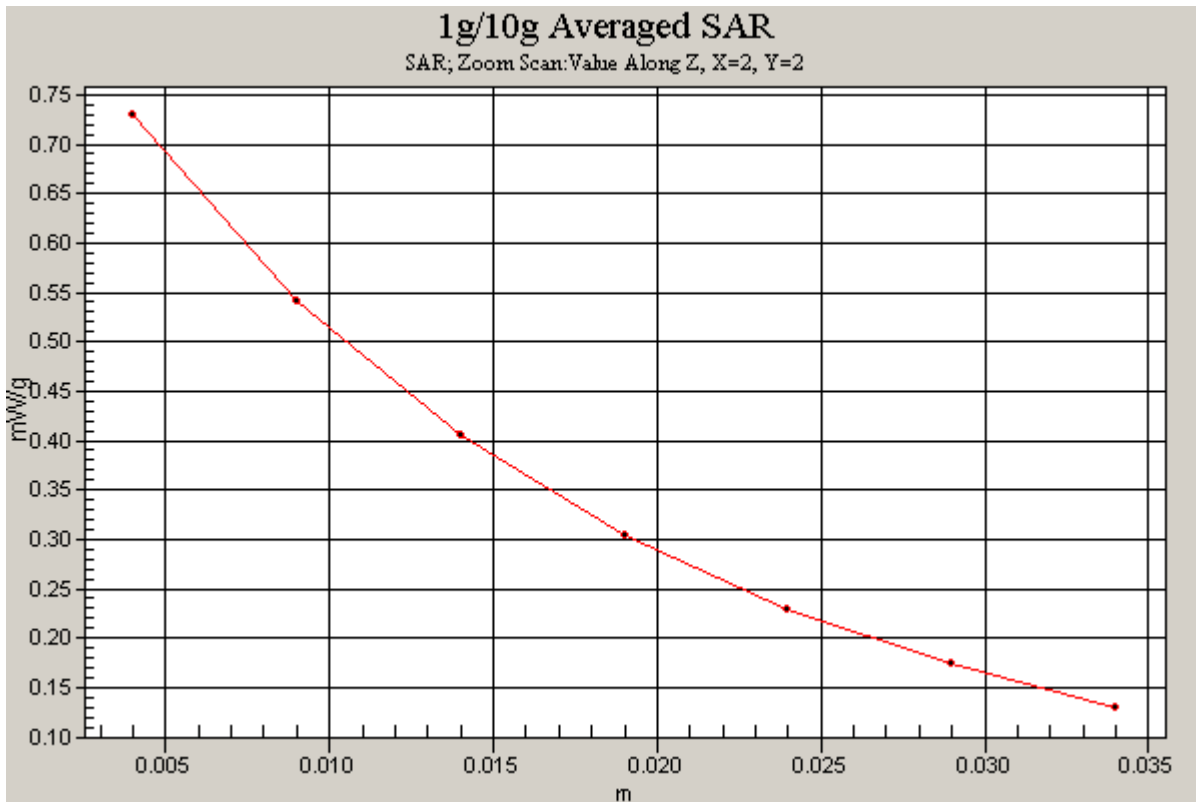

PCTEST ENGINEERING LABORATORY, INC.

**DUT: ZNFP690B; Type: 850/1900 GSM/GPRS/EDGE/WCDMA Phone
with Bluetooth and WLAN; Serial: 1**

Communication System: GSM850 GPRS; 4 Tx slots; Frequency: 836.6 MHz; Duty Cycle: 1:2.076
Medium: 835 Body; Medium parameters used (interpolated):
 $f = 836.6 \text{ MHz}$; $\sigma = 0.996 \text{ mho/m}$; $\epsilon_r = 55.3$; $\rho = 1000 \text{ kg/m}^3$
Phantom section: Flat Section; Space: 1.0 cm

Test Date: 07-21-2011; Ambient Temp: 23.6 °C; Tissue Temp: 21.9 °C

Probe: ES3DV3 - SN3258; ConvF(6.12, 6.12, 6.12); Calibrated: 4/8/2011
Sensor-Surface: 4mm (Mechanical Surface Detection)
Electronics: DAE4 Sn649; Calibrated: 2/21/2011
Phantom: SAM Main; Type: SAM 4.0; Serial: TP-1114

Measurement SW: DASY4, V4.7 Build 80; Postprocessing SW: SEMCAD, V1.8 Build 186

Mode: GPRS 850, Body SAR, Front side, Mid.ch, 4 Tx Slots

Area Scan (7x12x1): Measurement grid: dx=15mm, dy=15mm

Zoom Scan (5x5x7)/Cube 0: Measurement grid: dx=8mm, dy=8mm, dz=5mm

Reference Value = 19.2 V/m

Peak SAR (extrapolated) = 0.516 W/kg

SAR(1 g) = 0.384 mW/g; SAR(10 g) = 0.283 mW/g

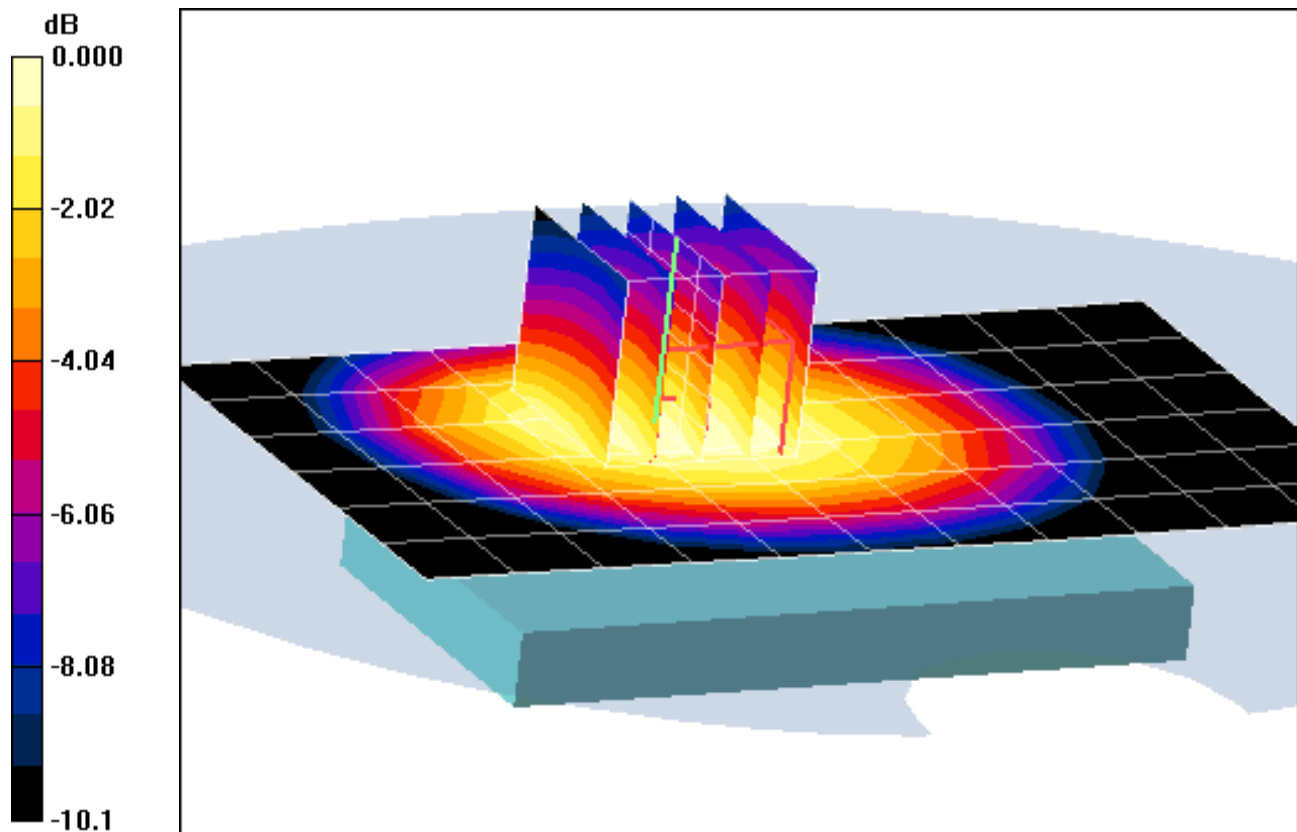

0 dB = 0.406mW/g

PCTEST ENGINEERING LABORATORY, INC.

**DUT: ZNFP690B; Type: 850/1900 GSM/GPRS/EDGE/WCDMA Phone
with Bluetooth and WLAN; Serial: 1**

Communication System: GSM850 GPRS; 4 Tx slots; Frequency: 836.6 MHz; Duty Cycle: 1:2.076
Medium: 835 Body; Medium parameters used (interpolated):
 $f = 836.6 \text{ MHz}$; $\sigma = 0.996 \text{ mho/m}$; $\epsilon_r = 55.3$; $\rho = 1000 \text{ kg/m}^3$
Phantom section: Flat Section; Space: 1.0 cm

Test Date: 07-21-2011; Ambient Temp: 23.6 °C; Tissue Temp: 21.9 °C

Probe: ES3DV3 - SN3258; ConvF(6.12, 6.12, 6.12); Calibrated: 4/8/2011
Sensor-Surface: 4mm (Mechanical Surface Detection)
Electronics: DAE4 Sn649; Calibrated: 2/21/2011
Phantom: SAM Main; Type: SAM 4.0; Serial: TP-1114

Measurement SW: DASY4, V4.7 Build 80; Postprocessing SW: SEMCAD, V1.8 Build 186

Mode: GPRS 850, Body SAR, Bottom Edge, Mid.ch, 4 Tx Slots

Area Scan (5x7x1): Measurement grid: dx=15mm, dy=15mm

Zoom Scan (5x5x7)/Cube 0: Measurement grid: dx=8mm, dy=8mm, dz=5mm

Reference Value = 6.55 V/m

Peak SAR (extrapolated) = 0.077 W/kg

SAR(1 g) = 0.048 mW/g; SAR(10 g) = 0.031 mW/g

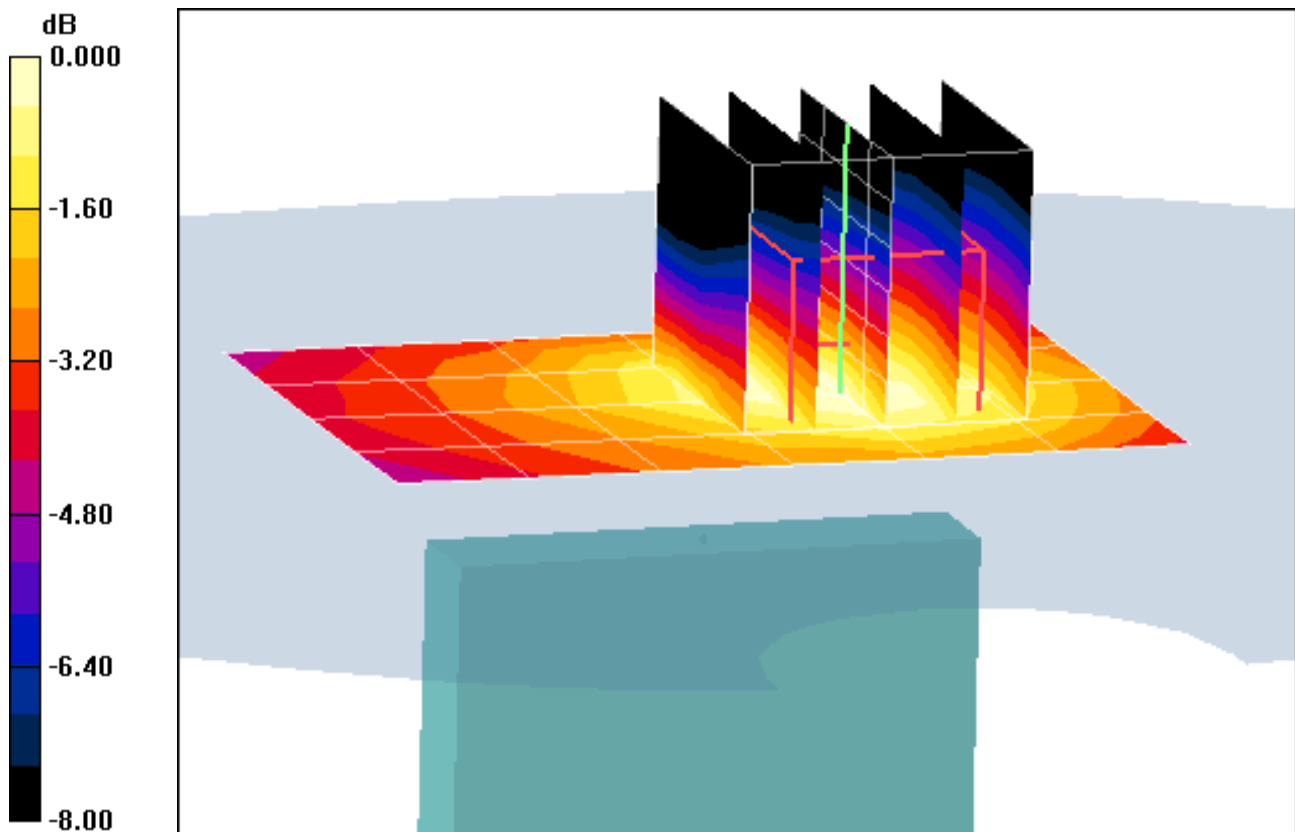

0 dB = 0.051mW/g

PCTEST ENGINEERING LABORATORY, INC.

**DUT: ZNFP690B; Type: 850/1900 GSM/GPRS/EDGE/WCDMA Phone
with Bluetooth and WLAN; Serial: 1**

Communication System: GSM850 GPRS; 4 Tx slots; Frequency: 836.6 MHz; Duty Cycle: 1:2.076
Medium: 835 Body; Medium parameters used (interpolated):
 $f = 836.6 \text{ MHz}$; $\sigma = 0.996 \text{ mho/m}$; $\epsilon_r = 55.3$; $\rho = 1000 \text{ kg/m}^3$
Phantom section: Flat Section; Space: 1.0 cm

Test Date: 07-21-2011; Ambient Temp: 23.6 °C; Tissue Temp: 21.9 °C

Probe: ES3DV3 - SN3258; ConvF(6.12, 6.12, 6.12); Calibrated: 4/8/2011
Sensor-Surface: 4mm (Mechanical Surface Detection)
Electronics: DAE4 Sn649; Calibrated: 2/21/2011
Phantom: SAM Main; Type: SAM 4.0; Serial: TP-1114

Measurement SW: DASY4, V4.7 Build 80; Postprocessing SW: SEMCAD, V1.8 Build 186

Mode: GPRS 850, Body SAR, Right Edge, Mid.ch, 4 Tx Slots

Area Scan (5x13x1): Measurement grid: dx=15mm, dy=15mm

Zoom Scan (5x5x7)/Cube 0: Measurement grid: dx=8mm, dy=8mm, dz=5mm

Reference Value = 19.6 V/m

Peak SAR (extrapolated) = 0.514 W/kg

SAR(1 g) = 0.365 mW/g; SAR(10 g) = 0.253 mW/g

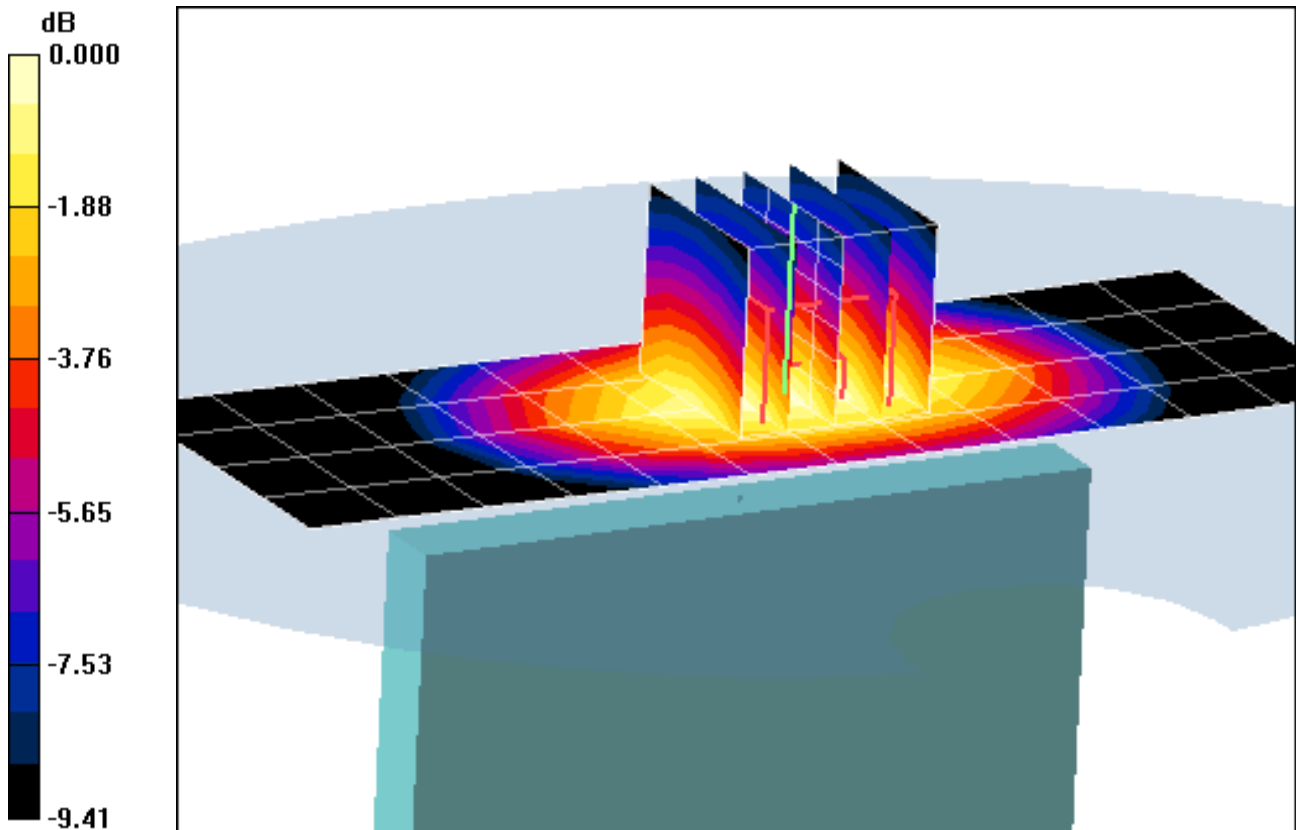

0 dB = 0.390mW/g

PCTEST ENGINEERING LABORATORY, INC.

**DUT: ZNFP690B; Type: 850/1900 GSM/GPRS/EDGE/WCDMA Phone
with Bluetooth and WLAN; Serial: 1**

Communication System: GSM850 GPRS; 4 Tx slots; Frequency: 836.6 MHz; Duty Cycle: 1:2.076
Medium: 835 Body; Medium parameters used (interpolated):
 $f = 836.6 \text{ MHz}$; $\sigma = 0.996 \text{ mho/m}$; $\epsilon_r = 55.3$; $\rho = 1000 \text{ kg/m}^3$
Phantom section: Flat Section; Space: 1.0 cm

Test Date: 07-21-2011; Ambient Temp: 23.6 °C; Tissue Temp: 21.9 °C

Probe: ES3DV3 - SN3258; ConvF(6.12, 6.12, 6.12); Calibrated: 4/8/2011
Sensor-Surface: 4mm (Mechanical Surface Detection)
Electronics: DAE4 Sn649; Calibrated: 2/21/2011
Phantom: SAM Main; Type: SAM 4.0; Serial: TP-1114

Measurement SW: DASY4, V4.7 Build 80; Postprocessing SW: SEMCAD, V1.8 Build 186

Mode: GPRS 850, Body SAR, Left Edge, Mid.ch, 4 Tx Slots

Area Scan (5x13x1): Measurement grid: dx=15mm, dy=15mm

Zoom Scan (5x5x7)/Cube 0: Measurement grid: dx=8mm, dy=8mm, dz=5mm

Reference Value = 18.4 V/m

Peak SAR (extrapolated) = 0.447 W/kg

SAR(1 g) = 0.315 mW/g; SAR(10 g) = 0.217 mW/g

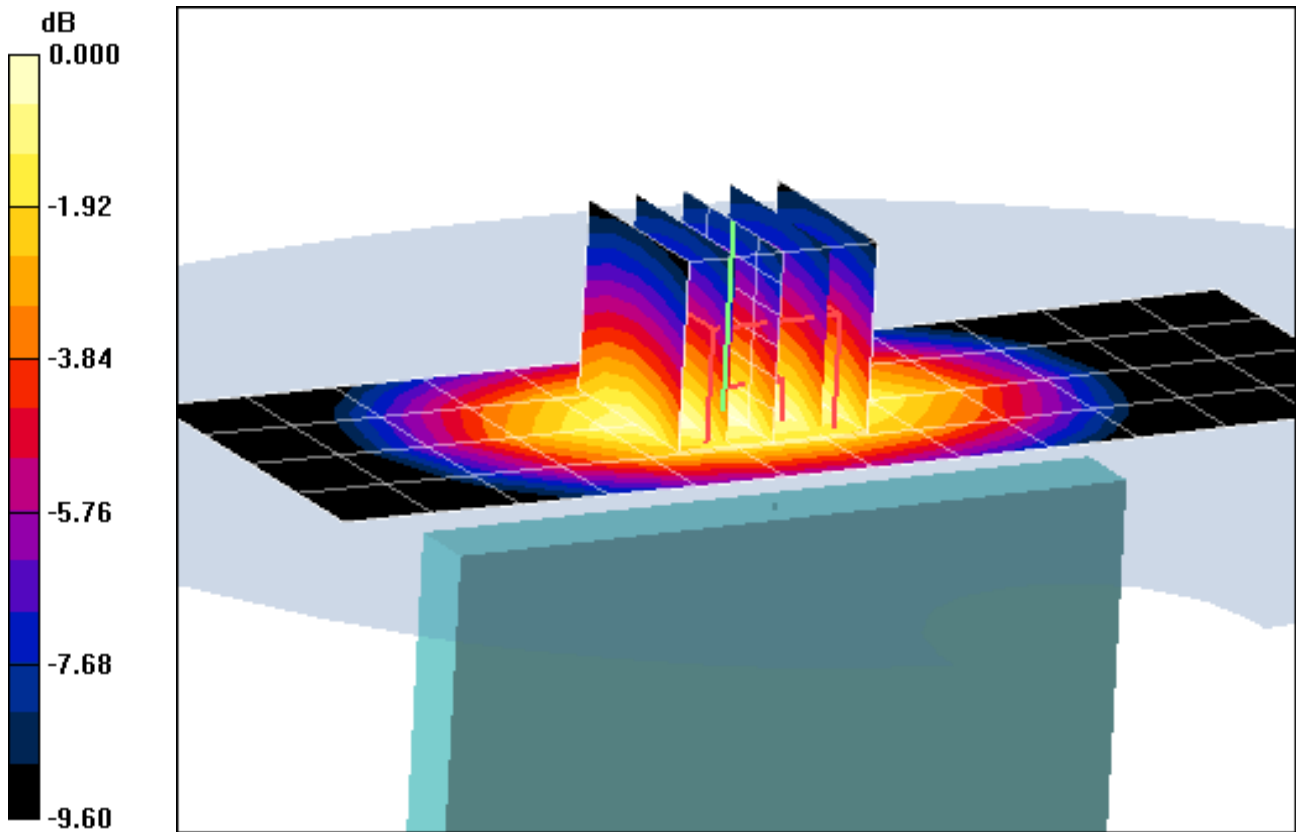

0 dB = 0.336mW/g

PCTEST ENGINEERING LABORATORY, INC.

**DUT: ZNFP690B; Type: 850/1900 GSM/GPRS/EDGE/WCDMA Phone
with Bluetooth and WLAN; Serial: 1**

Communication System: GSM1900 GPRS; 4 Tx slots; Frequency: 1880 MHz; Duty Cycle: 1:2.076
Medium: 1900 Body; Medium parameters used:
 $f = 1880 \text{ MHz}$; $\sigma = 1.52 \text{ mho/m}$; $\epsilon_r = 52$; $\rho = 1000 \text{ kg/m}^3$
Phantom section: Flat Section; Space: 1.0 cm

Test Date: 07-20-2011; Ambient Temp: 23.9 °C; Tissue Temp: 22.6 °C

Probe: EX3DV4 - SN3550; ConvF(6.77, 6.77, 6.77); Calibrated: 2/14/2011
Sensor-Surface: 4mm (Mechanical Surface Detection)
Electronics: DAE4 Sn665; Calibrated: 4/20/2011
Phantom: SAM Sub; Type: SAM 4.0; Serial: TP-1357

Measurement SW: DASY4, V4.7 Build 80; Postprocessing SW: SEMCAD, V1.8 Build 186

Mode: GPRS 1900, Body SAR, Back side, Mid.ch, 4 Tx Slots

Area Scan (7x11x1): Measurement grid: dx=15mm, dy=15mm

Zoom Scan (5x5x7)/Cube 0: Measurement grid: dx=8mm, dy=8mm, dz=5mm

Reference Value = 16.4 V/m

Peak SAR (extrapolated) = 0.665 W/kg

SAR(1 σ) = 0.393 mW/g; SAR(10 σ) = 0.225 mW/g

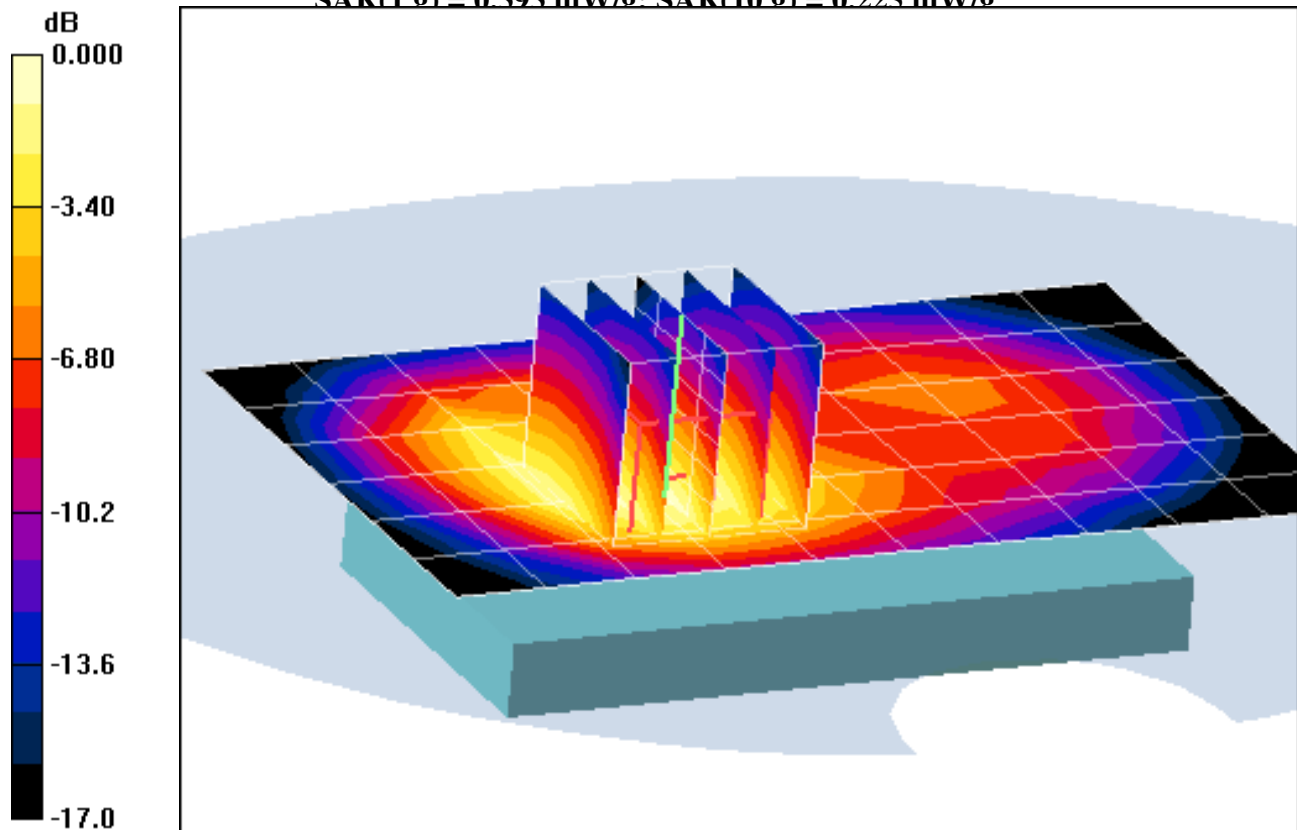

0 dB = 0.431mW/g

PCTEST ENGINEERING LABORATORY, INC.

**DUT: ZNFP690B; Type: 850/1900 GSM/GPRS/EDGE/WCDMA Phone
with Bluetooth and WLAN; Serial: 1**

Communication System: GSM1900 GPRS; 4 Tx slots; Frequency: 1880 MHz; Duty Cycle: 1:2.076
Medium: 1900 Body; Medium parameters used:
 $f = 1880 \text{ MHz}$; $\sigma = 1.52 \text{ mho/m}$; $\epsilon_r = 52$; $\rho = 1000 \text{ kg/m}^3$
Phantom section: Flat Section; Space: 1.0 cm

Test Date: 07-20-2011; Ambient Temp: 23.9 °C; Tissue Temp: 22.6 °C

Probe: EX3DV4 - SN3550; ConvF(6.77, 6.77, 6.77); Calibrated: 2/14/2011
Sensor-Surface: 4mm (Mechanical Surface Detection)
Electronics: DAE4 Sn665; Calibrated: 4/20/2011
Phantom: SAM Sub; Type: SAM 4.0; Serial: TP-1357

Measurement SW: DASY4, V4.7 Build 80; Postprocessing SW: SEMCAD, V1.8 Build 186

Mode: GPRS 1900, Body SAR, Front side, Mid.ch, 4 Tx Slots

Area Scan (7x12x1): Measurement grid: dx=15mm, dy=15mm

Zoom Scan (5x5x7)/Cube 0: Measurement grid: dx=8mm, dy=8mm, dz=5mm

Reference Value = 15.5 V/m

Peak SAR (extrapolated) = 0.571 W/kg

SAR(1 g) = 0.340 mW/g; SAR(10 g) = 0.192 mW/g

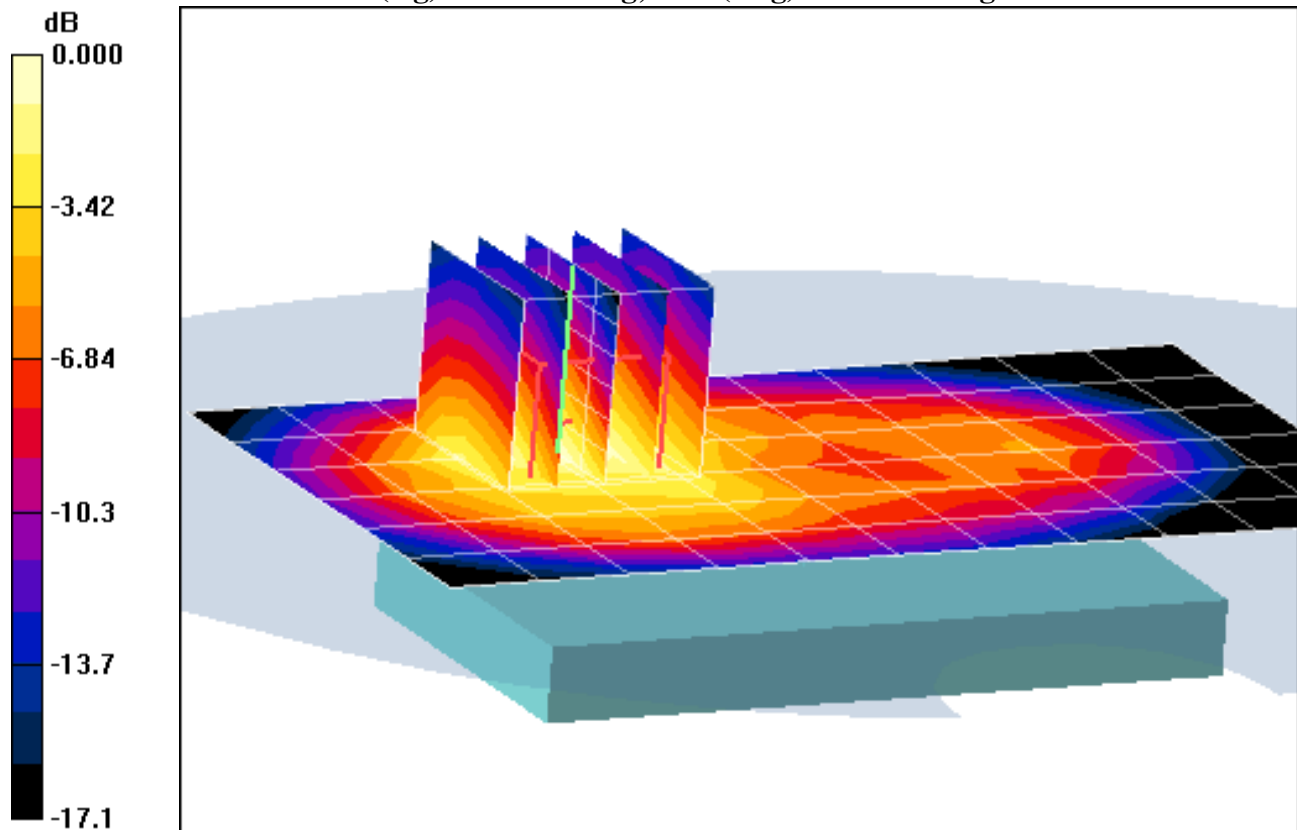

0 dB = 0.369mW/g

PCTEST ENGINEERING LABORATORY, INC.

**DUT: ZNFP690B; Type: 850/1900 GSM/GPRS/EDGE/WCDMA Phone
with Bluetooth and WLAN; Serial: 1**

Communication System: GSM1900 GPRS; 4 Tx slots; Frequency: 1880 MHz; Duty Cycle: 1:2.076

Medium: 1900 Body; Medium parameters used:

$f = 1880 \text{ MHz}$; $\sigma = 1.52 \text{ mho/m}$; $\epsilon_r = 52$; $\rho = 1000 \text{ kg/m}^3$

Phantom section: Flat Section; Space: 1.0 cm

Test Date: 07-20-2011; Ambient Temp: 23.9 °C; Tissue Temp: 22.6 °C

Probe: EX3DV4 - SN3550; ConvF(6.77, 6.77, 6.77); Calibrated: 2/14/2011

Sensor-Surface: 4mm (Mechanical Surface Detection)

Electronics: DAE4 Sn665; Calibrated: 4/20/2011

Phantom: SAM Sub; Type: SAM 4.0; Serial: TP-1357

Measurement SW: DASY4, V4.7 Build 80; Postprocessing SW: SEMCAD, V1.8 Build 186

Mode: GPRS 1900, Body SAR, Bottom Edge, Mid.ch, 4 Tx Slots

Area Scan (5x7x1): Measurement grid: dx=15mm, dy=15mm

Zoom Scan (5x5x7)/Cube 0: Measurement grid: dx=8mm, dy=8mm, dz=5mm

Reference Value = 12.9 V/m

Peak SAR (extrapolated) = 0.461 W/kg

SAR(1 g) = 0.289 mW/g; SAR(10 g) = 0.167 mW/g

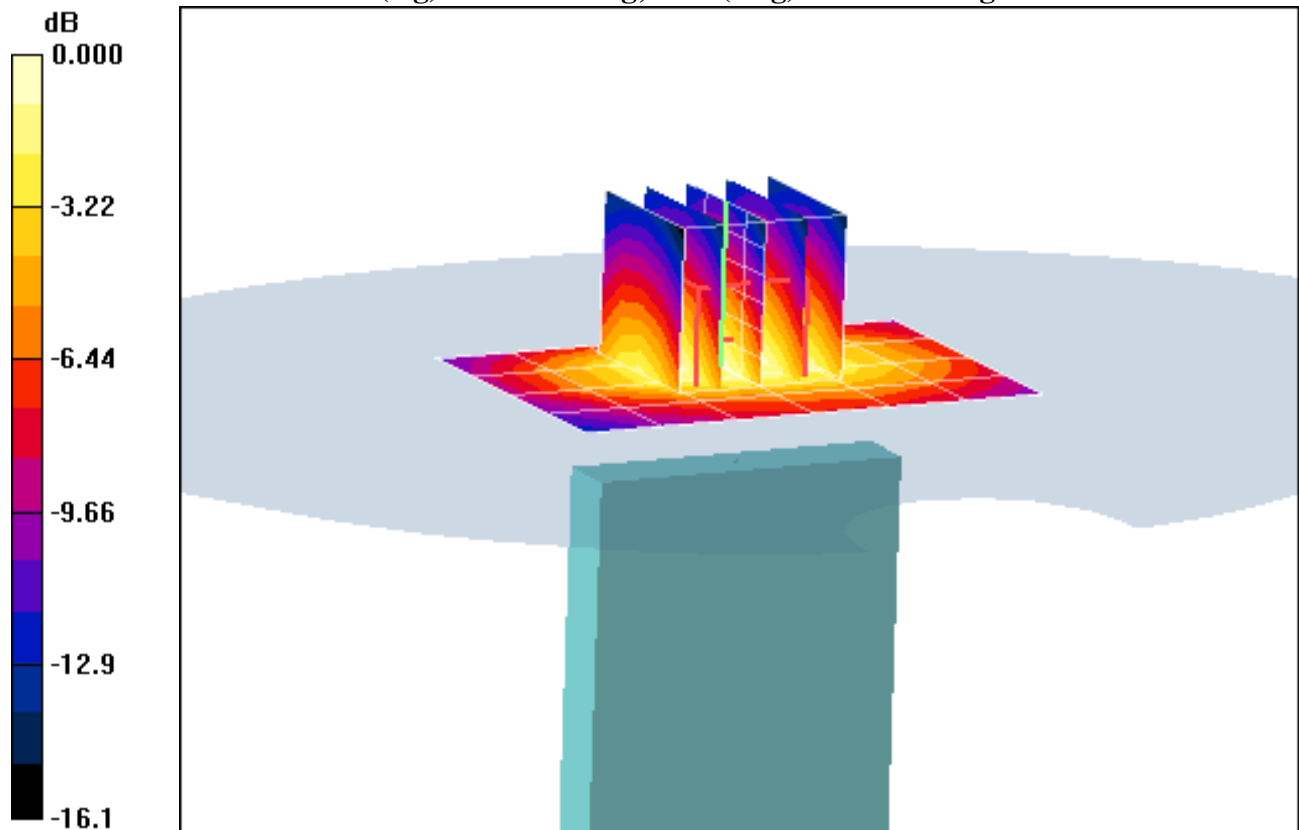

0 dB = 0.321mW/g

PCTEST ENGINEERING LABORATORY, INC.

**DUT: ZNFP690B; Type: 850/1900 GSM/GPRS/EDGE/WCDMA Phone
with Bluetooth and WLAN; Serial: 1**

Communication System: GSM1900 GPRS; 4 Tx slots; Frequency: 1880 MHz; Duty Cycle: 1:2.076
Medium: 1900 Body; Medium parameters used:
 $f = 1880 \text{ MHz}$; $\sigma = 1.52 \text{ mho/m}$; $\epsilon_r = 52$; $\rho = 1000 \text{ kg/m}^3$
Phantom section: Flat Section; Space: 1.0 cm

Test Date: 07-20-2011; Ambient Temp: 23.9 °C; Tissue Temp: 22.6 °C

Probe: EX3DV4 - SN3550; ConvF(6.77, 6.77, 6.77); Calibrated: 2/14/2011
Sensor-Surface: 4mm (Mechanical Surface Detection)
Electronics: DAE4 Sn665; Calibrated: 4/20/2011
Phantom: SAM Sub; Type: SAM 4.0; Serial: TP-1357

Measurement SW: DASY4, V4.7 Build 80; Postprocessing SW: SEMCAD, V1.8 Build 186

Mode: GPRS 1900, Body SAR, Right Edge, Mid.ch, 4 Tx Slots

Area Scan (5x13x1): Measurement grid: dx=15mm, dy=15mm

Zoom Scan (5x5x7)/Cube 0: Measurement grid: dx=8mm, dy=8mm, dz=5mm

Reference Value = 7.04 V/m

Peak SAR (extrapolated) = 0.116 W/kg

SAR(1 g) = 0.074 mW/g; SAR(10 g) = 0.044 mW/g

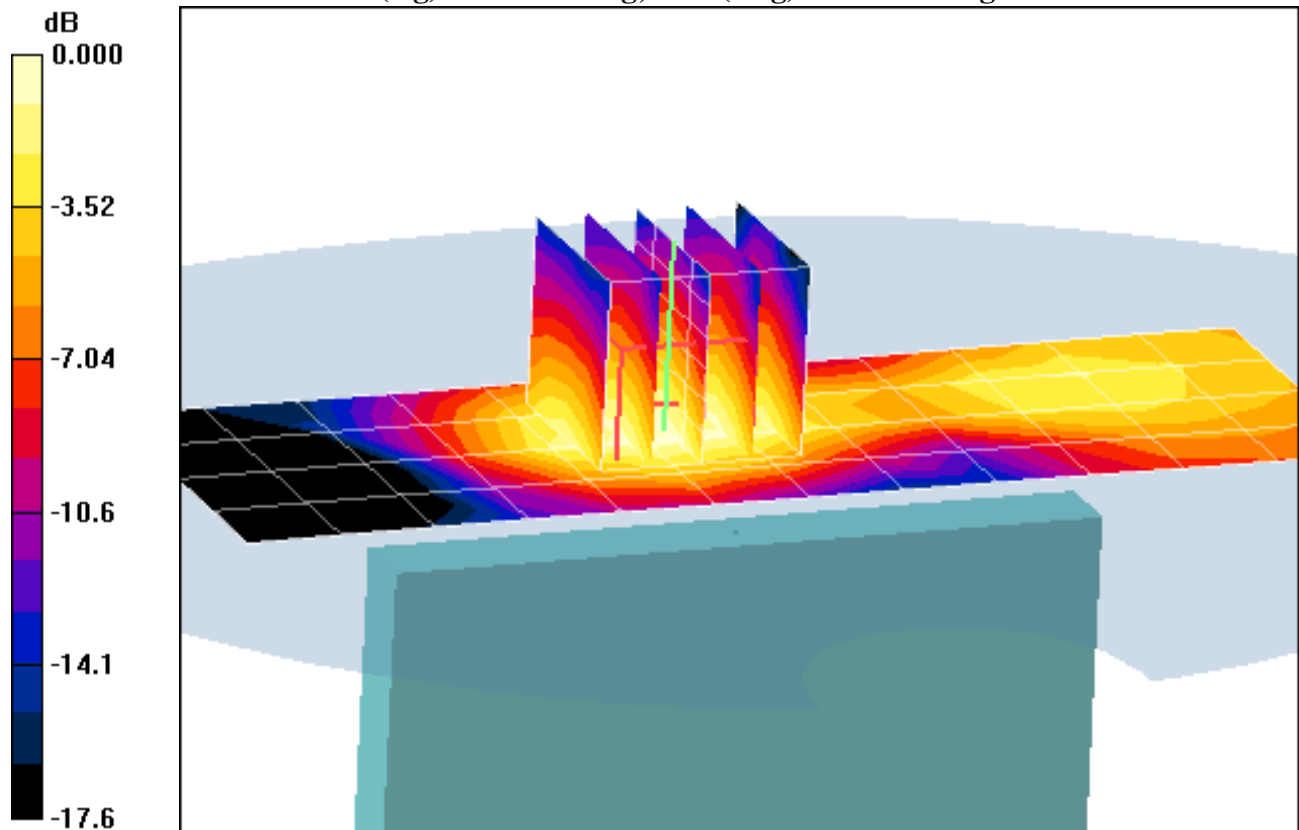

0 dB = 0.081mW/g

PCTEST ENGINEERING LABORATORY, INC.

**DUT: ZNFP690B; Type: 850/1900 GSM/GPRS/EDGE/WCDMA Phone
with Bluetooth and WLAN; Serial: 1**

Communication System: GSM1900 GPRS; 4 Tx slots; Frequency: 1880 MHz; Duty Cycle: 1:2.076

Medium: 1900 Body; Medium parameters used:

$f = 1880 \text{ MHz}$; $\sigma = 1.52 \text{ mho/m}$; $\epsilon_r = 52$; $\rho = 1000 \text{ kg/m}^3$

Phantom section: Flat Section; Space: 1.0 cm

Test Date: 07-20-2011; Ambient Temp: 23.9 °C; Tissue Temp: 22.6 °C

Probe: EX3DV4 - SN3550; ConvF(6.77, 6.77, 6.77); Calibrated: 2/14/2011

Sensor-Surface: 4mm (Mechanical Surface Detection)

Electronics: DAE4 Sn665; Calibrated: 4/20/2011

Phantom: SAM Sub; Type: SAM 4.0; Serial: TP-1357

Measurement SW: DASY4, V4.7 Build 80; Postprocessing SW: SEMCAD, V1.8 Build 186

Mode: GPRS 1900, Body SAR, Left Edge, Mid.ch, 4 Tx Slots

Area Scan (5x13x1): Measurement grid: dx=15mm, dy=15mm

Zoom Scan (5x5x7)/Cube 0: Measurement grid: dx=8mm, dy=8mm, dz=5mm

Reference Value = 8.74 V/m

Peak SAR (extrapolated) = 0.192 W/kg

SAR(1 g) = 0.120 mW/g; SAR(10 g) = 0.073 mW/g

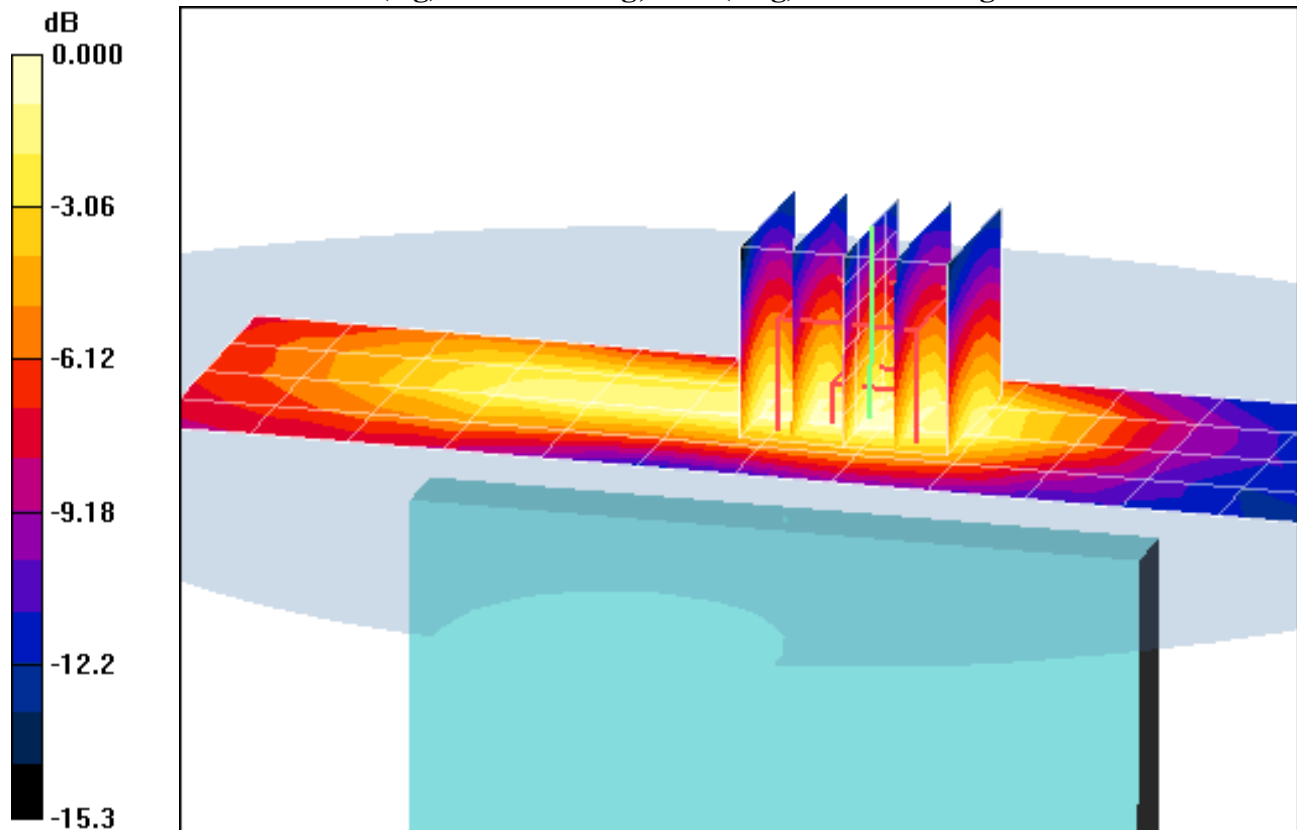

0 dB = 0.130mW/g

PCTEST ENGINEERING LABORATORY, INC.

**DUT: ZNFP690B; Type: 850/1900 GSM/GPRS/EDGE/WCDMA Phone
with Bluetooth and WLAN; Serial: 1**

Communication System: WCDMA850; Frequency: 836.6 MHz; Duty Cycle: 1:1
Medium: 835 Body; Medium parameters used (interpolated):
 $f = 836.6 \text{ MHz}$; $\sigma = 0.996 \text{ mho/m}$; $\epsilon_r = 55.3$; $\rho = 1000 \text{ kg/m}^3$
Phantom section: Flat Section; Space: 1.0 cm

Test Date: 07-21-2011; Ambient Temp: 23.6 °C; Tissue Temp: 21.9 °C

Probe: ES3DV3 - SN3258; ConvF(6.12, 6.12, 6.12); Calibrated: 4/8/2011
Sensor-Surface: 4mm (Mechanical Surface Detection)
Electronics: DAE4 Sn649; Calibrated: 2/21/2011
Phantom: SAM Main; Type: SAM 4.0; Serial: TP-1114
Measurement SW: DASY4, V4.7 Build 80; Postprocessing SW: SEMCAD, V1.8 Build 186

Mode: WCDMA 850, Body SAR, Back side, Mid.ch

Area Scan (7x12x1): Measurement grid: dx=15mm, dy=15mm
Zoom Scan (5x5x7)/Cube 0: Measurement grid: dx=8mm, dy=8mm, dz=5mm
Reference Value = 25.5 V/m
Peak SAR (extrapolated) = 0.814 W/kg
SAR(1 g) = 0.605 mW/g; SAR(10 g) = 0.433 mW/g

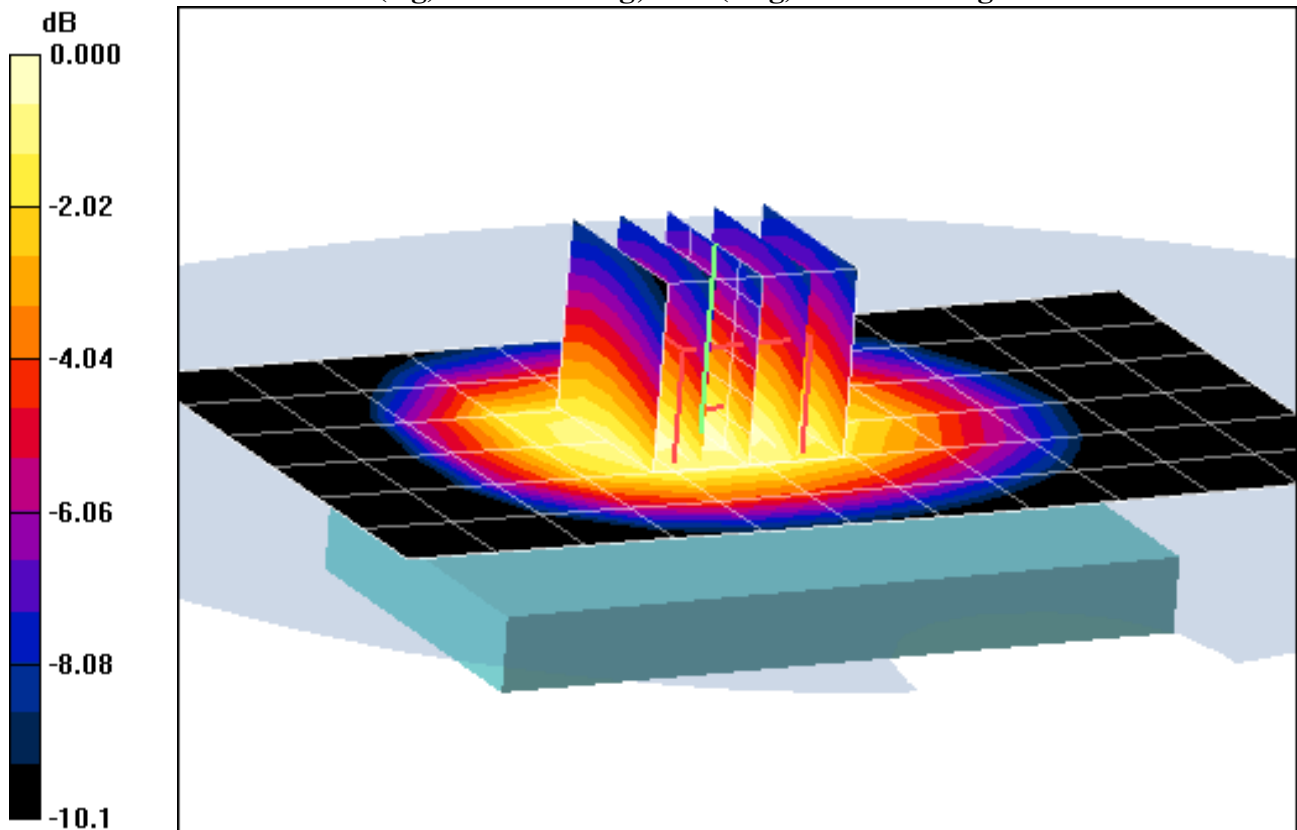

0 dB = 0.641mW/g

PCTEST ENGINEERING LABORATORY, INC.

**DUT: ZNFP690B; Type: 850/1900 GSM/GPRS/EDGE/WCDMA Phone
with Bluetooth and WLAN; Serial: 1**

Communication System: WCDMA850; Frequency: 836.6 MHz; Duty Cycle: 1:1
Medium: 835 Body; Medium parameters used (interpolated):
 $f = 836.6 \text{ MHz}$; $\sigma = 0.996 \text{ mho/m}$; $\epsilon_r = 55.3$; $\rho = 1000 \text{ kg/m}^3$
Phantom section: Flat Section; Space: 1.0 cm

Test Date: 07-21-2011; Ambient Temp: 23.6 °C; Tissue Temp: 21.9 °C

Probe: ES3DV3 - SN3258; ConvF(6.12, 6.12, 6.12); Calibrated: 4/8/2011

Sensor-Surface: 4mm (Mechanical Surface Detection)

Electronics: DAE4 Sn649; Calibrated: 2/21/2011

Phantom: SAM Main; Type: SAM 4.0; Serial: TP-1114

Measurement SW: DASY4, V4.7 Build 80; Postprocessing SW: SEMCAD, V1.8 Build 186

Mode: WCDMA 850, Body SAR, Front side, Mid.ch

Area Scan (7x12x1): Measurement grid: dx=15mm, dy=15mm

Zoom Scan (5x5x7)/Cube 0: Measurement grid: dx=8mm, dy=8mm, dz=5mm

Reference Value = 19.1 V/m

Peak SAR (extrapolated) = 0.462 W/kg

SAR(1 g) = 0.346 mW/g; SAR(10 g) = 0.254 mW/g

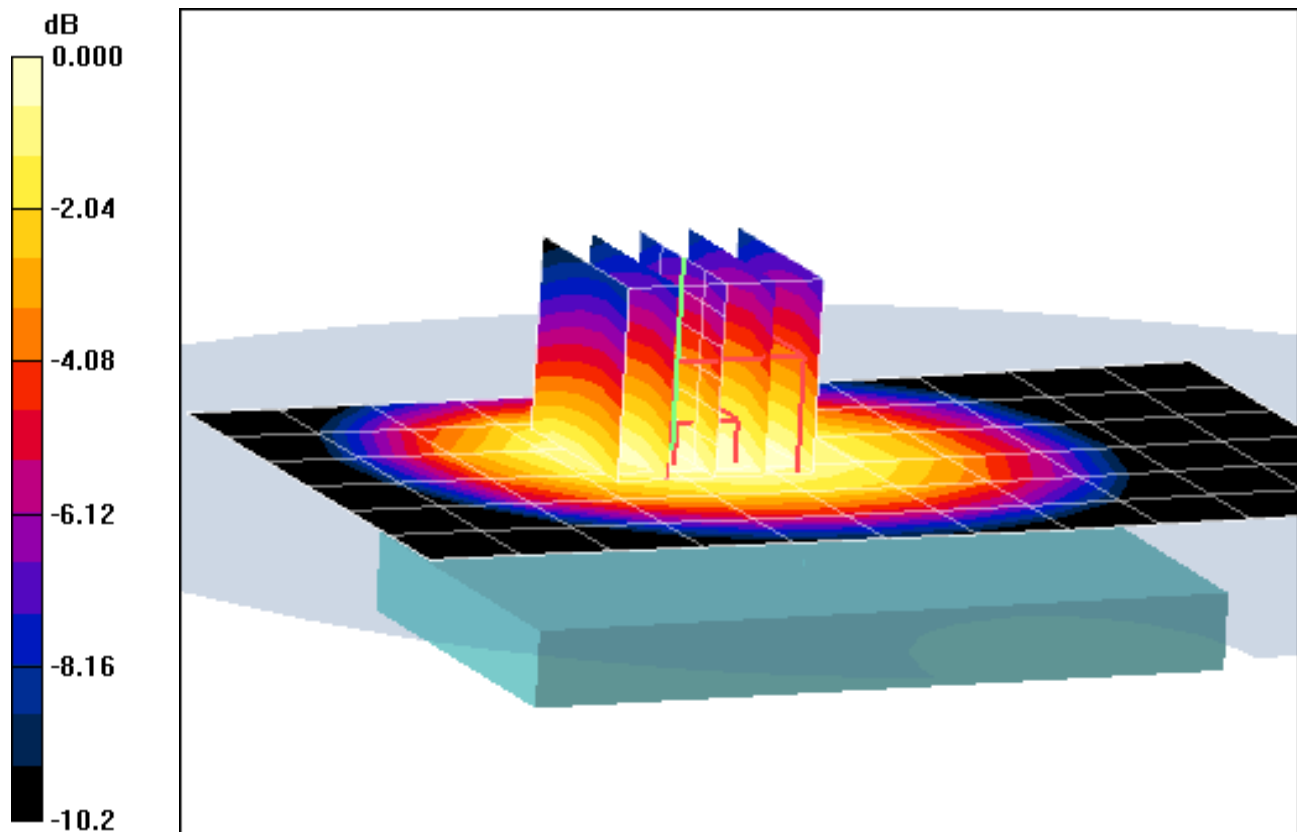

0 dB = 0.364mW/g

PCTEST ENGINEERING LABORATORY, INC.

**DUT: ZNFP690B; Type: 850/1900 GSM/GPRS/EDGE/WCDMA Phone
with Bluetooth and WLAN; Serial: 1**

Communication System: WCDMA850; Frequency: 836.6 MHz; Duty Cycle: 1:1
Medium: 835 Body; Medium parameters used (interpolated):
 $f = 836.6 \text{ MHz}$; $\sigma = 0.996 \text{ mho/m}$; $\epsilon_r = 55.3$; $\rho = 1000 \text{ kg/m}^3$
Phantom section: Flat Section; Space: 1.0 cm

Test Date: 07-21-2011; Ambient Temp: 23.6 °C; Tissue Temp: 21.9 °C

Probe: ES3DV3 - SN3258; ConvF(6.12, 6.12, 6.12); Calibrated: 4/8/2011
Sensor-Surface: 4mm (Mechanical Surface Detection)
Electronics: DAE4 Sn649; Calibrated: 2/21/2011
Phantom: SAM Main; Type: SAM 4.0; Serial: TP-1114
Measurement SW: DASY4, V4.7 Build 80; Postprocessing SW: SEMCAD, V1.8 Build 186

Mode: WCDMA 850, Body SAR, Bottom Edge, Mid.ch

Area Scan (5x7x1): Measurement grid: dx=15mm, dy=15mm
Zoom Scan (5x5x7)/Cube 0: Measurement grid: dx=8mm, dy=8mm, dz=5mm
Reference Value = 6.56 V/m
Peak SAR (extrapolated) = 0.064 W/kg
SAR(1 g) = 0.0395 mW/g; SAR(10 g) = 0.025 mW/g

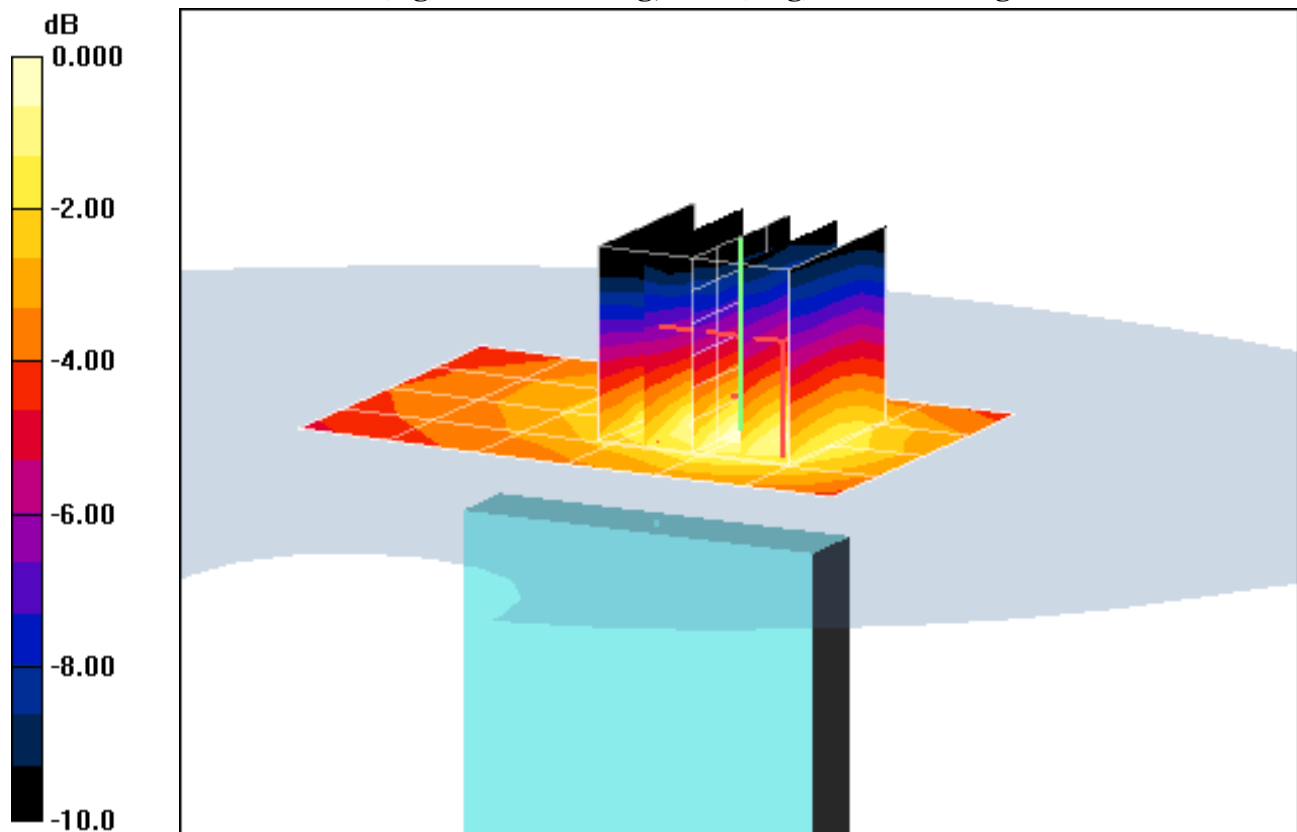

0 dB = 0.043mW/g

PCTEST ENGINEERING LABORATORY, INC.

**DUT: ZNFP690B; Type: 850/1900 GSM/GPRS/EDGE/WCDMA Phone
with Bluetooth and WLAN; Serial: 1**

Communication System: WCDMA850; Frequency: 836.6 MHz; Duty Cycle: 1:1
Medium: 835 Body; Medium parameters used (interpolated):
 $f = 836.6 \text{ MHz}$; $\sigma = 0.996 \text{ mho/m}$; $\epsilon_r = 55.3$; $\rho = 1000 \text{ kg/m}^3$
Phantom section: Flat Section; Space: 1.0 cm

Test Date: 07-21-2011; Ambient Temp: 23.6 °C; Tissue Temp: 21.9 °C

Probe: ES3DV3 - SN3258; ConvF(6.12, 6.12, 6.12); Calibrated: 4/8/2011
Sensor-Surface: 4mm (Mechanical Surface Detection)
Electronics: DAE4 Sn649; Calibrated: 2/21/2011
Phantom: SAM Main; Type: SAM 4.0; Serial: TP-1114
Measurement SW: DASY4, V4.7 Build 80; Postprocessing SW: SEMCAD, V1.8 Build 186

Mode: WCDMA 850, Body SAR, Right Edge, Mid.ch

Area Scan (5x13x1): Measurement grid: dx=15mm, dy=15mm
Zoom Scan (5x5x7)/Cube 0: Measurement grid: dx=8mm, dy=8mm, dz=5mm
Reference Value = 17.9 V/m
Peak SAR (extrapolated) = 0.438 W/kg
SAR(1 g) = 0.314 mW/g; SAR(10 g) = 0.219 mW/g

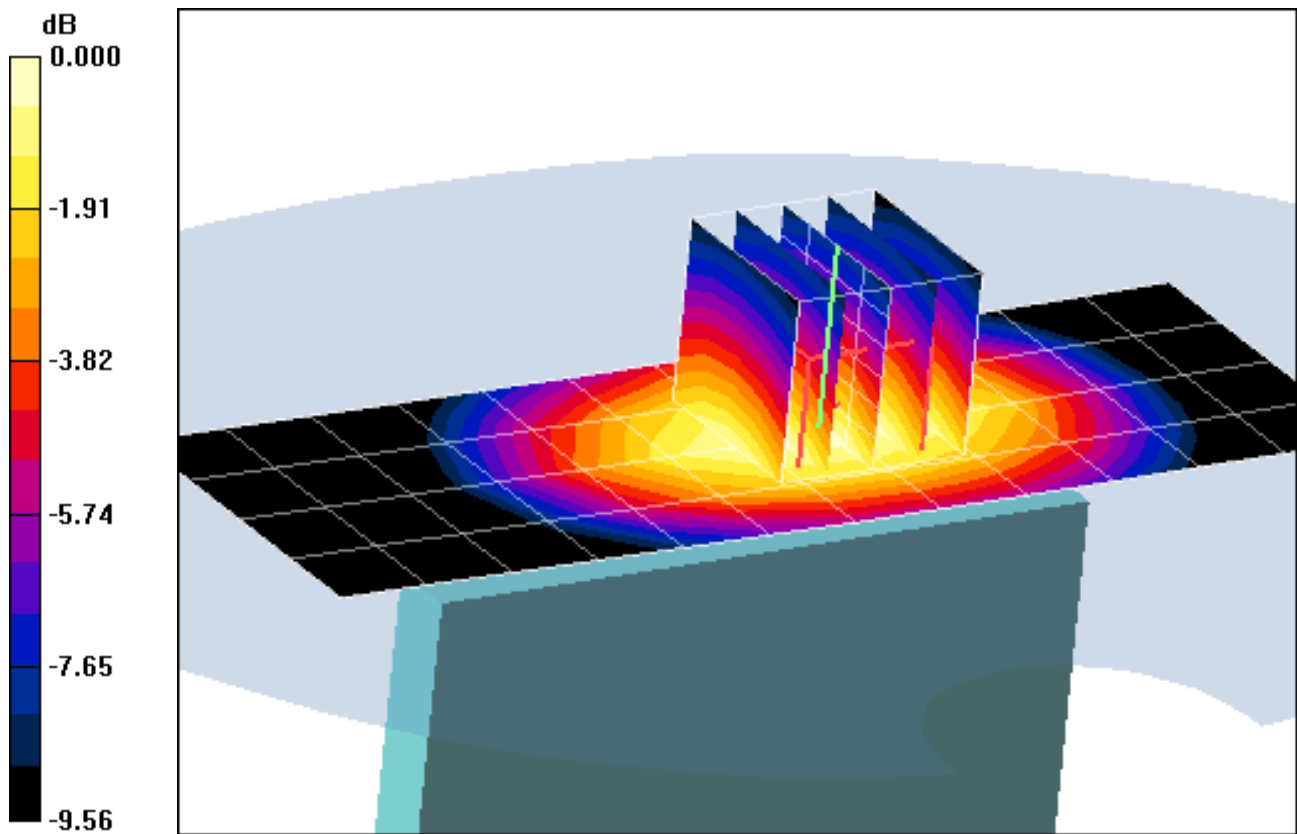

0 dB = 0.334mW/g

PCTEST ENGINEERING LABORATORY, INC.

**DUT: ZNFP690B; Type: 850/1900 GSM/GPRS/EDGE/WCDMA Phone
with Bluetooth and WLAN; Serial: 1**

Communication System: WCDMA850; Frequency: 836.6 MHz; Duty Cycle: 1:1
Medium: 835 Body; Medium parameters used (interpolated):
 $f = 836.6 \text{ MHz}$; $\sigma = 0.996 \text{ mho/m}$; $\epsilon_r = 55.3$; $\rho = 1000 \text{ kg/m}^3$
Phantom section: Flat Section; Space: 1.0 cm

Test Date: 07-21-2011; Ambient Temp: 23.6 °C; Tissue Temp: 21.9 °C

Probe: ES3DV3 - SN3258; ConvF(6.12, 6.12, 6.12); Calibrated: 4/8/2011
Sensor-Surface: 4mm (Mechanical Surface Detection)
Electronics: DAE4 Sn649; Calibrated: 2/21/2011
Phantom: SAM Main; Type: SAM 4.0; Serial: TP-1114
Measurement SW: DASY4, V4.7 Build 80; Postprocessing SW: SEMCAD, V1.8 Build 186

Mode: WCDMA 850, Body SAR, Left Edge, Mid.ch

Area Scan (5x13x1): Measurement grid: dx=15mm, dy=15mm
Zoom Scan (5x5x7)/Cube 0: Measurement grid: dx=8mm, dy=8mm, dz=5mm
Reference Value = 17.0 V/m
Peak SAR (extrapolated) = 0.380 W/kg
SAR(1 g) = 0.269 mW/g; SAR(10 g) = 0.187 mW/g

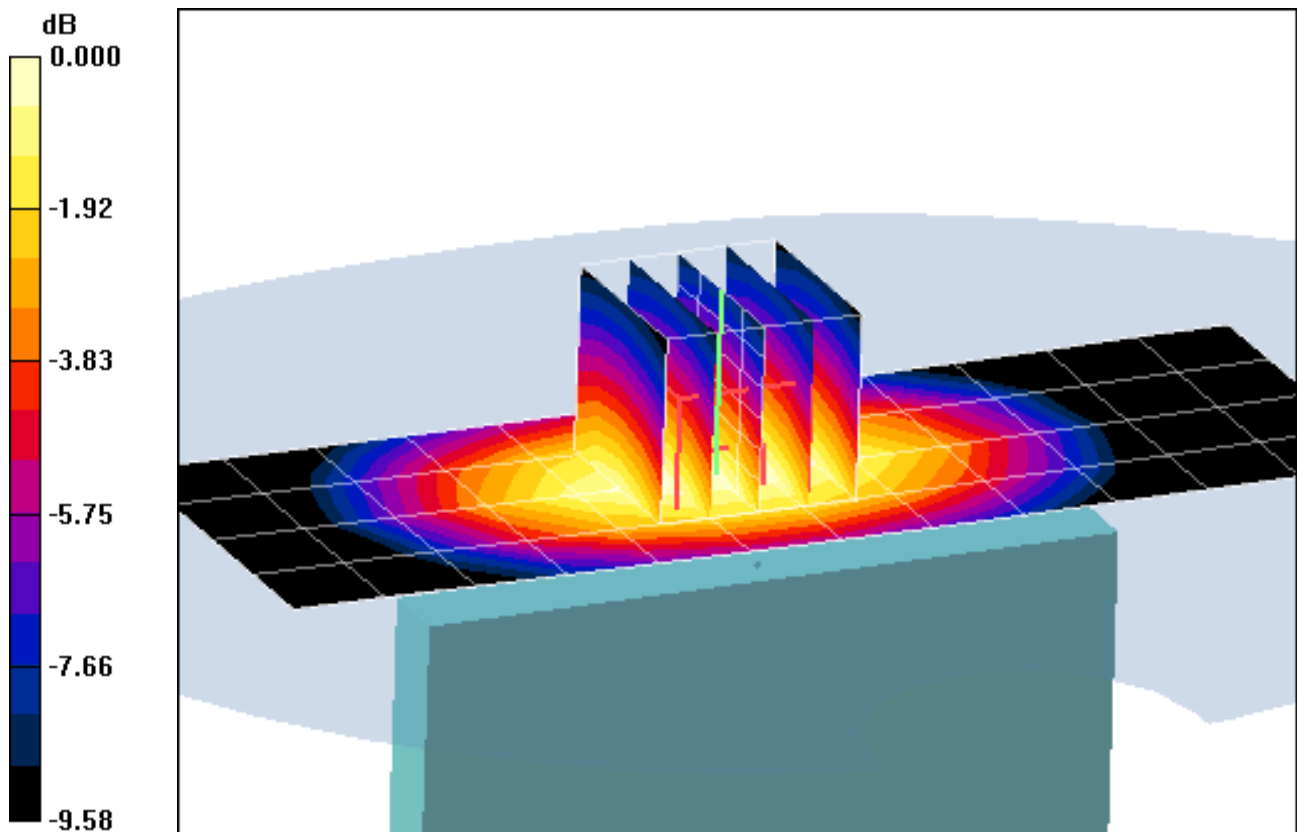

0 dB = 0.286mW/g

PCTEST ENGINEERING LABORATORY, INC.

*****DUT: ZNFP690B; Type: 850/1900 GSM/GPRS/EDGE/WCDMA Phone
with Bluetooth and WLAN; Serial: 1

Communication System: WCDMA1900; Frequency: 1880 MHz; Duty Cycle: 1:1

Medium: 1900 Body Medium parameters used:

$f = 1880 \text{ MHz}$; $\sigma = 1.52 \text{ mho/m}$; $\epsilon_r = 52$; $\rho = 1000 \text{ kg/m}^3$

Phantom section: Flat Section; Space: 1.0 cm

Test Date: 07-20-2011; Ambient Temp: 23.9 °C; Tissue Temp: 22.6 °C

Probe: EX3DV4 - SN3550; ConvF(6.77, 6.77, 6.77); Calibrated: 2/14/2011

Sensor-Surface: 4mm (Mechanical Surface Detection)

Electronics: DAE4 Sn665; Calibrated: 4/20/2011

Phantom: SAM Sub; Type: SAM 4.0; Serial: TP-1357

Measurement SW: DASY4, V4.7 Build 80; Postprocessing SW: SEMCAD, V1.8 Build 186

Mode: WCDMA 1900, Body SAR, Back side, Mid.ch

Area Scan (7x12x1): Measurement grid: dx=15mm, dy=15mm

Zoom Scan (5x5x7)/Cube 0: Measurement grid: dx=8mm, dy=8mm, dz=5mm

Reference Value = 21.5 V/m

Peak SAR (extrapolated) = 1.12 W/kg

SAR(1 g) = 0.667 mW/g; SAR(10 g) = 0.385 mW/g

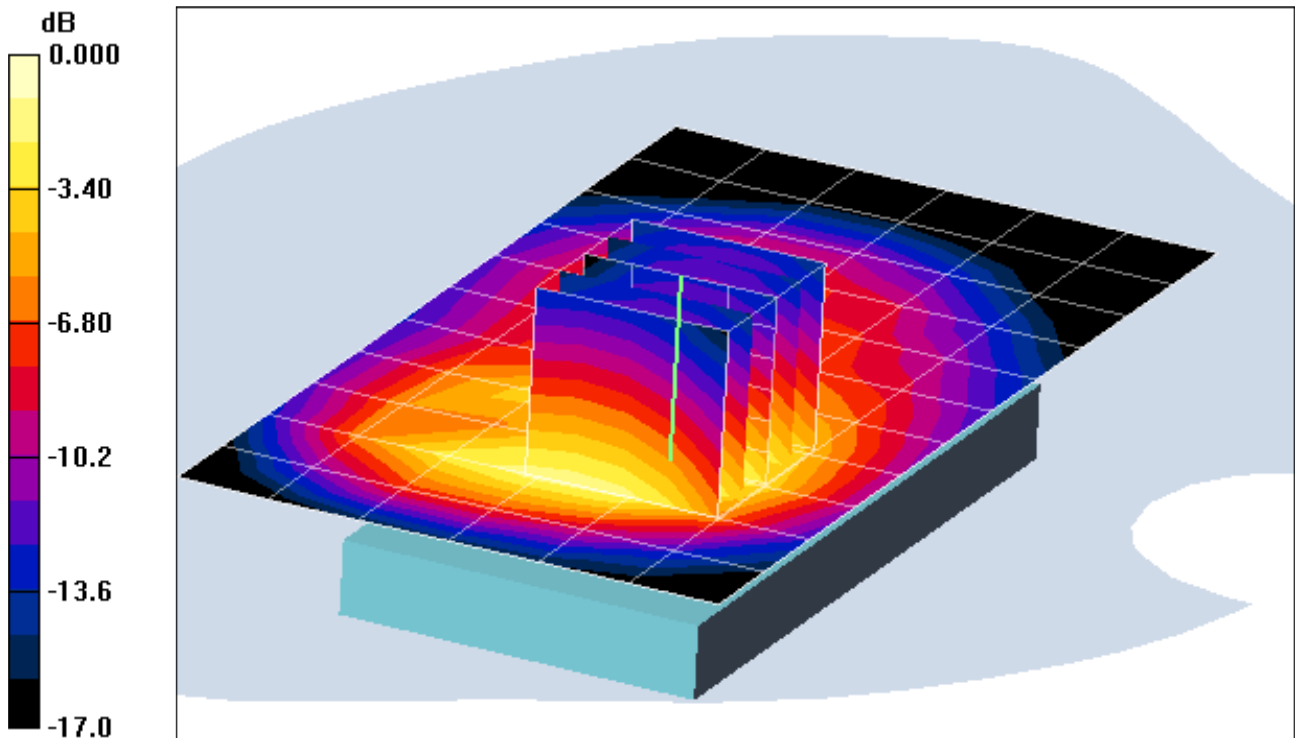

0 dB = 0.731mW/g

PCTEST ENGINEERING LABORATORY, INC.

**DUT: ZNFP690B; Type: 850/1900 GSM/GPRS/EDGE/WCDMA Phone
with Bluetooth and WLAN; Serial: 1**

Communication System: WCDMA1900; Frequency: 1880 MHz; Duty Cycle: 1:1

Medium: 1900 Body Medium parameters used:

$f = 1880 \text{ MHz}$; $\sigma = 1.52 \text{ mho/m}$; $\epsilon_r = 52$; $\rho = 1000 \text{ kg/m}^3$

Phantom section: Flat Section; Space: 1.0 cm

Test Date: 07-20-2011; Ambient Temp: 23.9 °C; Tissue Temp: 22.6 °C

Probe: EX3DV4 - SN3550; ConvF(6.77, 6.77, 6.77); Calibrated: 2/14/2011

Sensor-Surface: 4mm (Mechanical Surface Detection)

Electronics: DAE4 Sn665; Calibrated: 4/20/2011

Phantom: SAM Sub; Type: SAM 4.0; Serial: TP-1357

Measurement SW: DASY4, V4.7 Build 80; Postprocessing SW: SEMCAD, V1.8 Build 186

Mode: WCDMA 1900, Body SAR, Back side, Mid.ch

Area Scan (7x12x1): Measurement grid: dx=15mm, dy=15mm

Zoom Scan (5x5x7)/Cube 0: Measurement grid: dx=8mm, dy=8mm, dz=5mm

Reference Value = 21.5 V/m

Peak SAR (extrapolated) = 1.12 W/kg

SAR(1 g) = 0.667 mW/g; SAR(10 g) = 0.385 mW/g

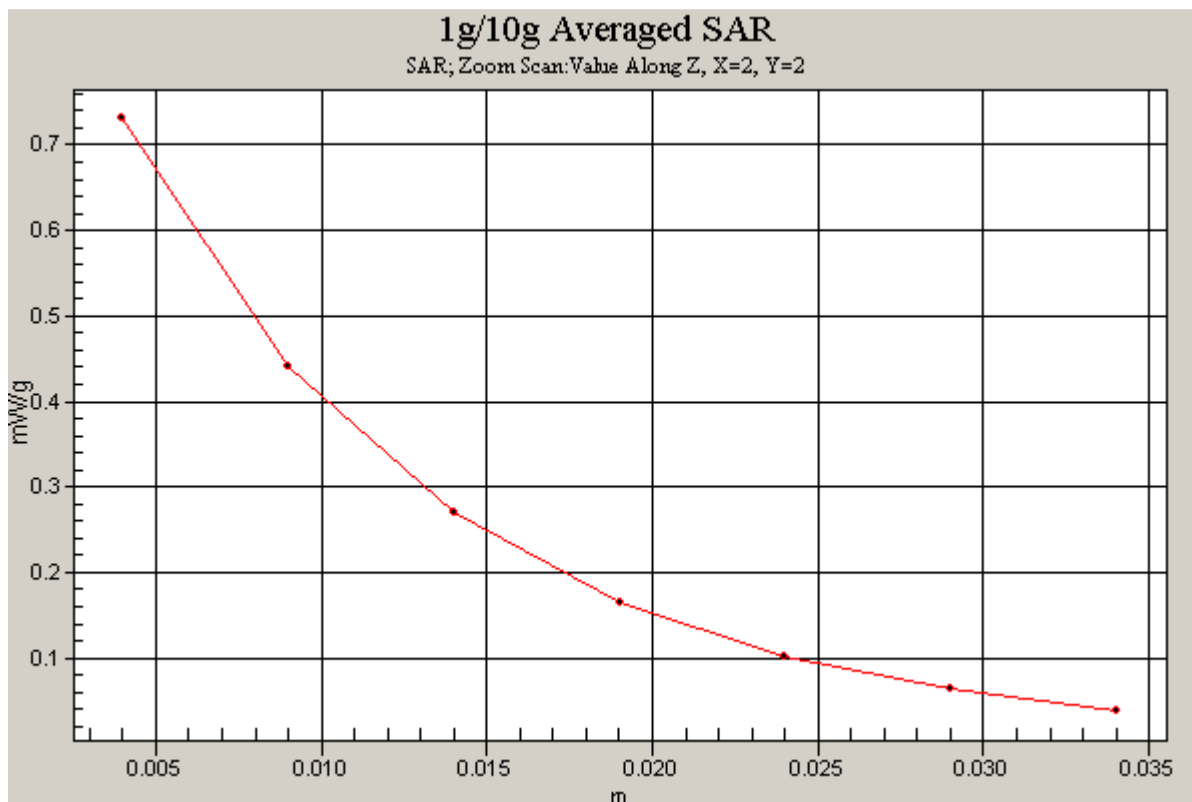

PCTEST ENGINEERING LABORATORY, INC.

**DUT: ZNFP690B; Type: 850/1900 GSM/GPRS/EDGE/WCDMA Phone
with Bluetooth and WLAN; Serial: 3**

Communication System: WCDMA1900; Frequency: 1880 MHz; Duty Cycle: 1:1

Medium: 1900 Body; Medium parameters used:

$f = 1880 \text{ MHz}$; $\sigma = 1.52 \text{ mho/m}$; $\epsilon_r = 52$; $\rho = 1000 \text{ kg/m}^3$

Phantom section: Flat Section; Space: 1.0 cm

Test Date: 07-20-2011; Ambient Temp: 23.9 °C; Tissue Temp: 22.6 °C

Probe: EX3DV4 - SN3550; ConvF(6.77, 6.77, 6.77); Calibrated: 2/14/2011

Sensor-Surface: 4mm (Mechanical Surface Detection)

Electronics: DAE4 Sn665; Calibrated: 4/20/2011

Phantom: SAM Sub; Type: SAM 4.0; Serial: TP-1357

Measurement SW: DASY4, V4.7 Build 80; Postprocessing SW: SEMCAD, V1.8 Build 186

Mode: WCDMA 1900, Body SAR, Front side, Mid.ch

Area Scan (7x12x1): Measurement grid: dx=15mm, dy=15mm

Zoom Scan (5x5x7)/Cube 0: Measurement grid: dx=8mm, dy=8mm, dz=5mm

Reference Value = 18.8 V/m

Peak SAR (extrapolated) = 0.903 W/kg

SAR(1 g) = 0.539 mW/g; SAR(10 g) = 0.308 mW/g

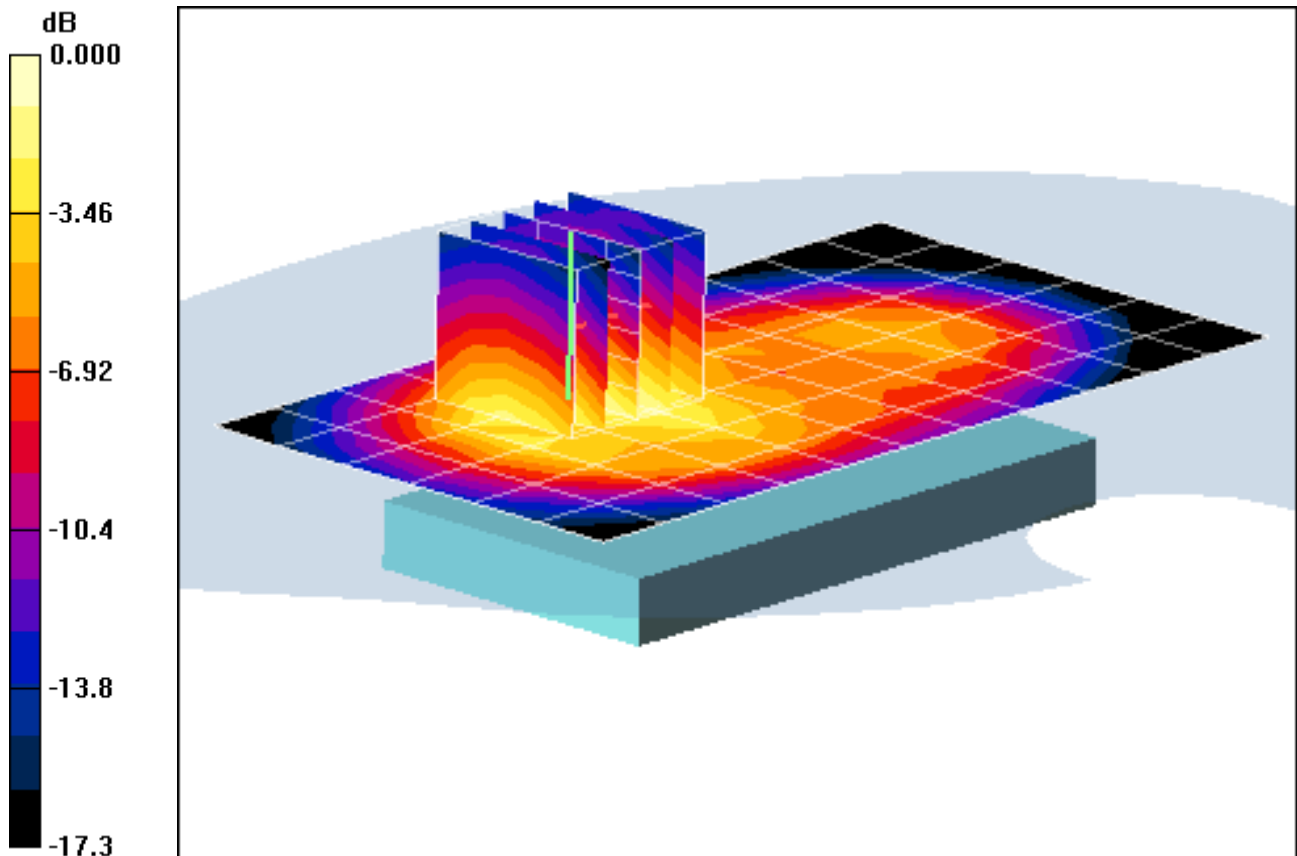

0 dB = 0.596mW/g

PCTEST ENGINEERING LABORATORY, INC.

**DUT: ZNFP690B; Type: 850/1900 GSM/GPRS/EDGE/WCDMA Phone
with Bluetooth and WLAN; Serial: 3**

Communication System: WCDMA1900; Frequency: 1880 MHz; Duty Cycle: 1:1

Medium: 1900 Body; Medium parameters used:

$f = 1880 \text{ MHz}$; $\sigma = 1.52 \text{ mho/m}$; $\epsilon_r = 52$; $\rho = 1000 \text{ kg/m}^3$

Phantom section: Flat Section; Space: 1.0 cm

Test Date: 07-20-2011; Ambient Temp: 23.9 °C; Tissue Temp: 22.6 °C

Probe: EX3DV4 - SN3550; ConvF(6.77, 6.77, 6.77); Calibrated: 2/14/2011

Sensor-Surface: 4mm (Mechanical Surface Detection)

Electronics: DAE4 Sn665; Calibrated: 4/20/2011

Phantom: SAM Sub; Type: SAM 4.0; Serial: TP-1357

Measurement SW: DASY4, V4.7 Build 80; Postprocessing SW: SEMCAD, V1.8 Build 186

Mode: WCDMA 1900, Body SAR, Bottom Edge, Mid.ch

Area Scan (5x7x1): Measurement grid: dx=15mm, dy=15mm

Zoom Scan (5x5x7)/Cube 0: Measurement grid: dx=8mm, dy=8mm, dz=5mm

Reference Value = 19.3 V/m

Peak SAR (extrapolated) = 0.840 W/kg

SAR(1 g) = 0.527 mW/g; SAR(10 g) = 0.305 mW/g

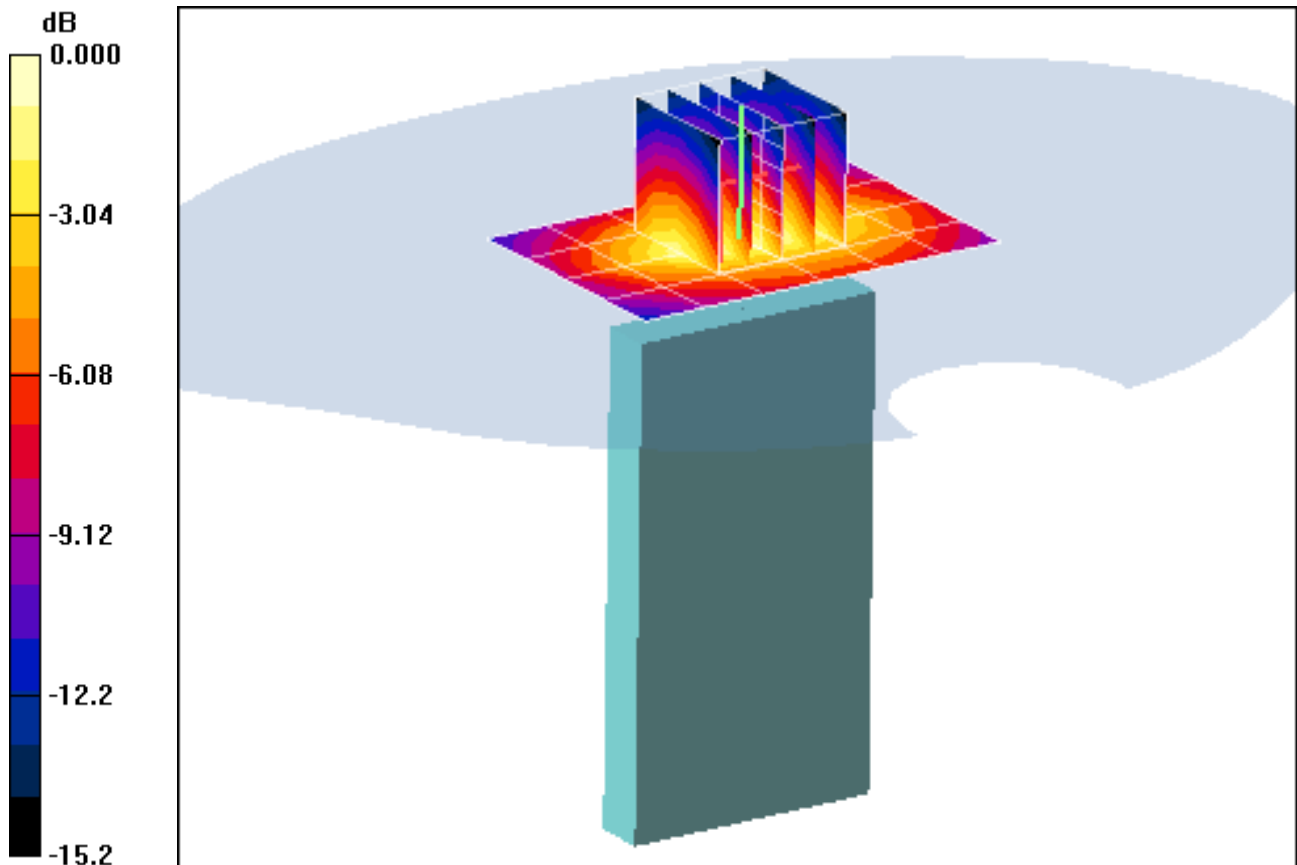

0 dB = 0.585mW/g

PCTEST ENGINEERING LABORATORY, INC.

**DUT: ZNFP690B; Type: 850/1900 GSM/GPRS/EDGE/WCDMA Phone
with Bluetooth and WLAN; Serial: 3**

Communication System: WCDMA1900; Frequency: 1880 MHz; Duty Cycle: 1:1

Medium: 1900 Body; Medium parameters used:

$f = 1880 \text{ MHz}$; $\sigma = 1.52 \text{ mho/m}$; $\epsilon_r = 52$; $\rho = 1000 \text{ kg/m}^3$

Phantom section: Flat Section; Space: 1.0 cm

Test Date: 07-20-2011; Ambient Temp: 23.9 °C; Tissue Temp: 22.6 °C

Probe: EX3DV4 - SN3550; ConvF(6.77, 6.77, 6.77); Calibrated: 2/14/2011

Sensor-Surface: 4mm (Mechanical Surface Detection)

Electronics: DAE4 Sn665; Calibrated: 4/20/2011

Phantom: SAM Sub; Type: SAM 4.0; Serial: TP-1357

Measurement SW: DASY4, V4.7 Build 80; Postprocessing SW: SEMCAD, V1.8 Build 186

Mode: WCDMA 1900, Body SAR, Right Edge, Mid.ch

Area Scan (5x13x1): Measurement grid: dx=15mm, dy=15mm

Zoom Scan (5x5x7)/Cube 0: Measurement grid: dx=8mm, dy=8mm, dz=5mm

Reference Value = 9.40 V/m

Peak SAR (extrapolated) = 0.218 W/kg

SAR(1 g) = 0.135 mW/g; SAR(10 g) = 0.081 mW/g

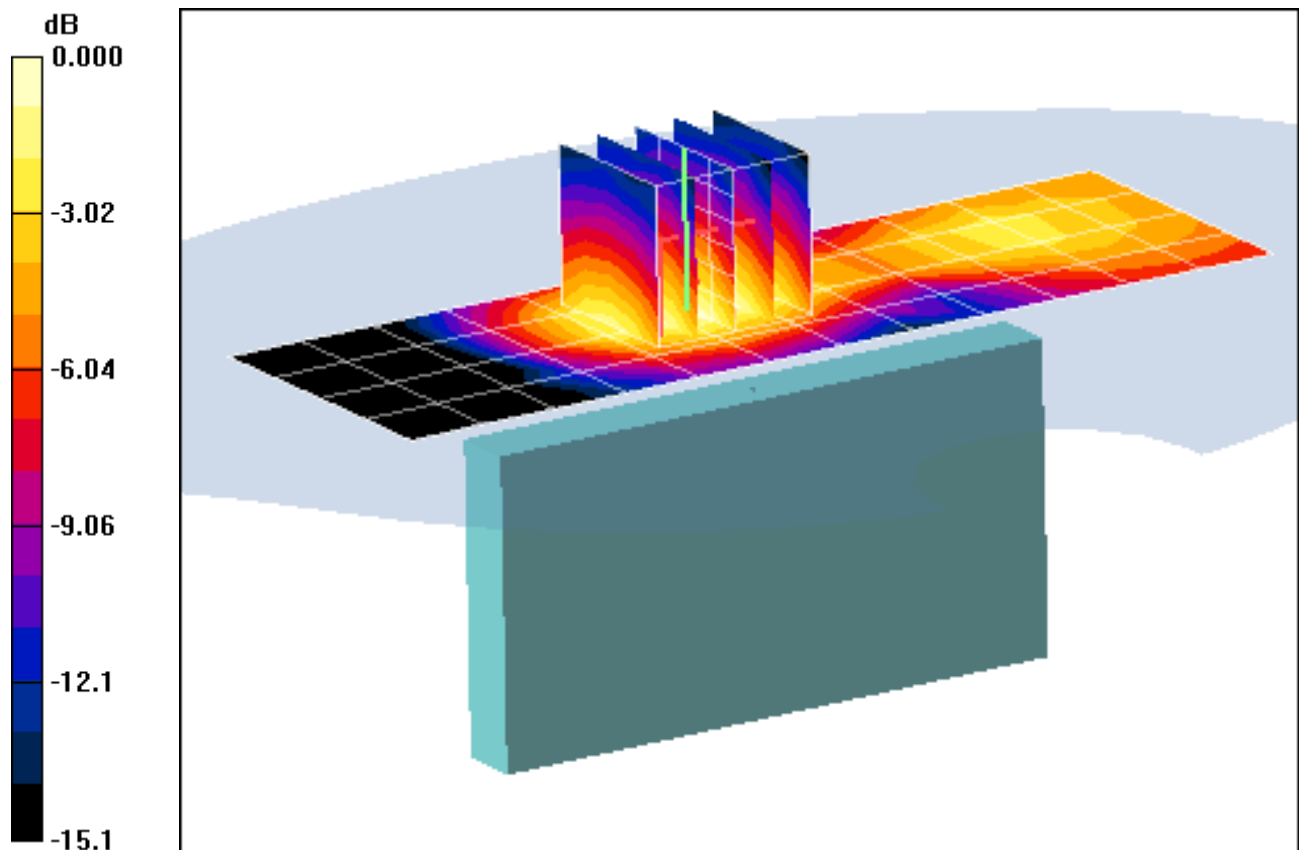

0 dB = 0.147mW/g

PCTEST ENGINEERING LABORATORY, INC.

**DUT: ZNFP690B; Type: 850/1900 GSM/GPRS/EDGE/WCDMA Phone
with Bluetooth and WLAN; Serial: 3**

Communication System: WCDMA1900; Frequency: 1880 MHz; Duty Cycle: 1:1

Medium: 1900 Body; Medium parameters used:

$f = 1880 \text{ MHz}$; $\sigma = 1.52 \text{ mho/m}$; $\epsilon_r = 52$; $\rho = 1000 \text{ kg/m}^3$

Phantom section: Flat Section; Space: 1.0 cm

Test Date: 07-20-2011; Ambient Temp: 23.9 °C; Tissue Temp: 22.6 °C

Probe: EX3DV4 - SN3550; ConvF(6.77, 6.77, 6.77); Calibrated: 2/14/2011

Sensor-Surface: 4mm (Mechanical Surface Detection)

Electronics: DAE4 Sn665; Calibrated: 4/20/2011

Phantom: SAM Sub; Type: SAM 4.0; Serial: TP-1357

Measurement SW: DASY4, V4.7 Build 80; Postprocessing SW: SEMCAD, V1.8 Build 186

Mode: WCDMA 1900, Body SAR, Left Edge, Mid.ch

Area Scan (5x13x1): Measurement grid: dx=15mm, dy=15mm

Zoom Scan (5x5x7)/Cube 0: Measurement grid: dx=8mm, dy=8mm, dz=5mm

Reference Value = 11.5 V/m

Peak SAR (extrapolated) = 0.327 W/kg

SAR(1 g) = 0.207 mW/g; SAR(10 g) = 0.126 mW/g

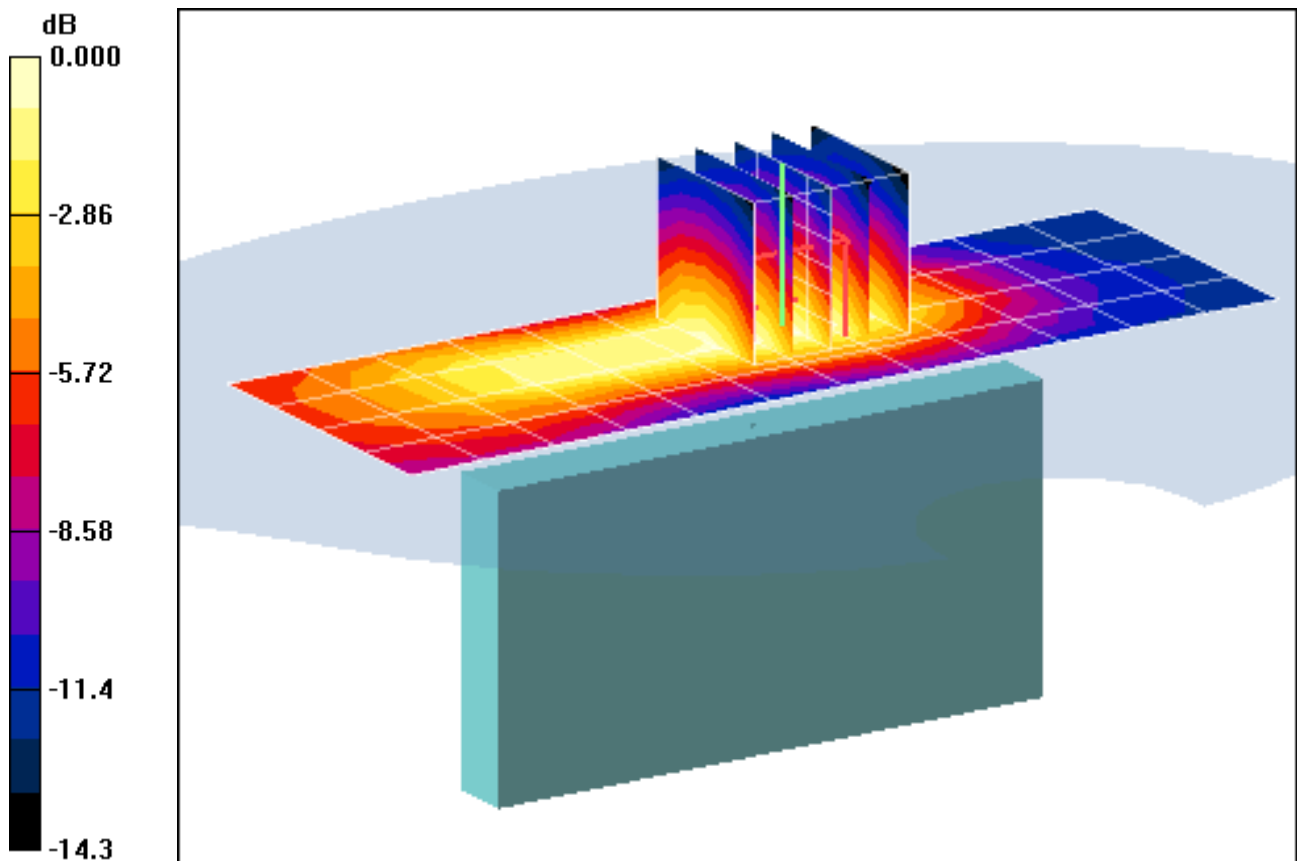

0 dB = 0.224mW/g

PCTEST ENGINEERING LABORATORY, INC.

**DUT: ZNFP690B; Type: 850/1900 GSM/GPRS/EDGE/WCDMA Phone
with Bluetooth and WLAN; Serial: 3**

Communication System: IEEE 802.11b; Frequency: 2462 MHz; Duty Cycle: 1:1

Medium: 2450 Body Medium parameters used (interpolated):

$f = 2462 \text{ MHz}$; $\sigma = 1.89 \text{ mho/m}$; $\epsilon_r = 52$; $\rho = 1000 \text{ kg/m}^3$

Phantom section: Flat Section; Space: 1.0 cm

Test Date: 08-01-2011; Ambient Temp: 23.9°C; Tissue Temp: 22.5°C

Probe: EX3DV4 - SN3550; ConvF(6.25, 6.25, 6.25); Calibrated: 2/14/2011

Sensor-Surface: 3mm (Mechanical Surface Detection)

Electronics: DAE4 Sn665; Calibrated: 4/20/2011

Phantom: SAM Sub; Type: SAM 4.0; Serial: TP-1357

Measurement SW: DASY4, V4.7 Build 80; Postprocessing SW: SEMCAD, V1.8 Build 186

Mode: IEEE 802.11b, Body SAR, Ch 11, 1 Mbps, Back Side

Area Scan (7x11x1): Measurement grid: dx=15mm, dy=15mm

Zoom Scan (5x5x7)/Cube 0: Measurement grid: dx=8mm, dy=8mm, dz=5mm

Reference Value = 6.43 V/m

Peak SAR (extrapolated) = 0.179 W/kg

SAR(1 g) = 0.093 mW/g; SAR(10 g) = 0.048 mW/g

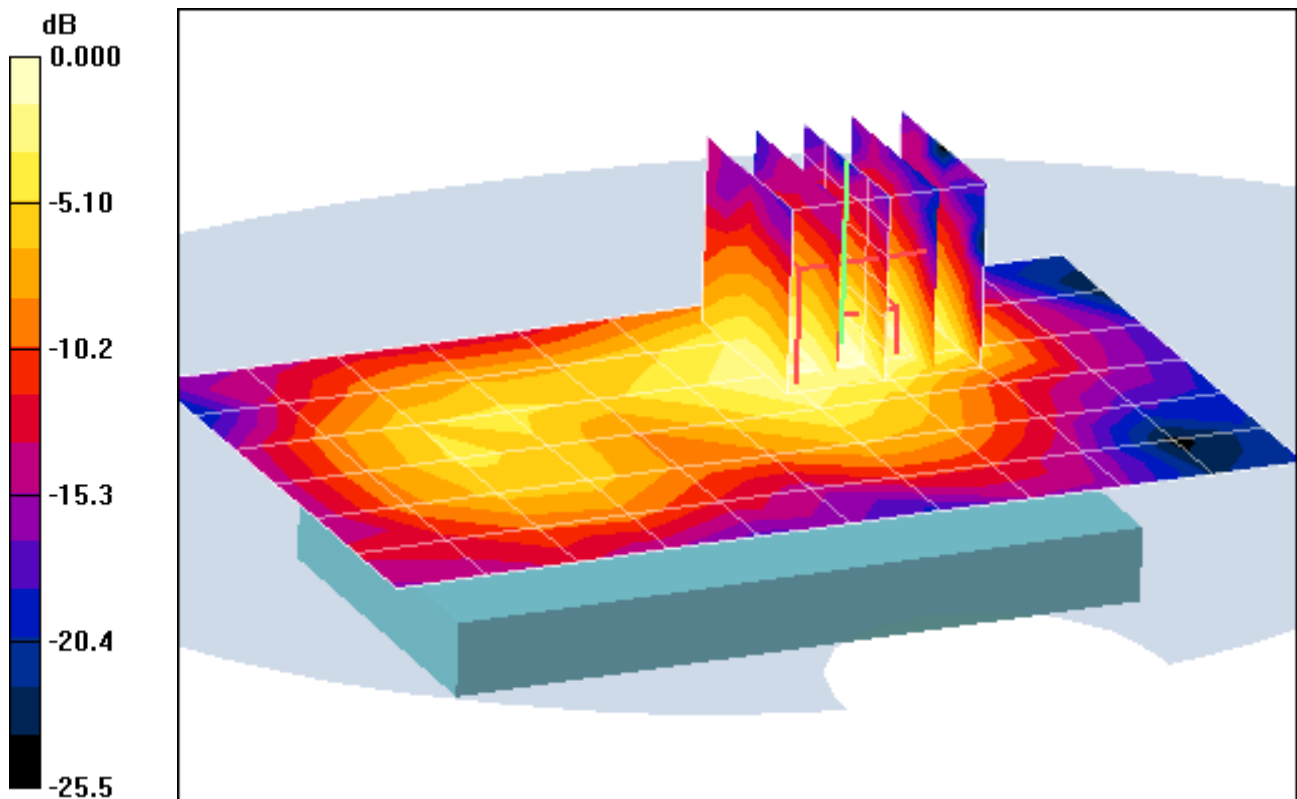

0 dB = 0.118mW/g

PCTEST ENGINEERING LABORATORY, INC.

**DUT: ZNFP690B; Type: 850/1900 GSM/GPRS/EDGE/WCDMA Phone
with Bluetooth and WLAN; Serial: 3**

Communication System: IEEE 802.11b; Frequency: 2462 MHz; Duty Cycle: 1:1
Medium: 2450 Body Medium parameters used (interpolated):

$$f = 2462 \text{ MHz}; \sigma = 1.89 \text{ mho/m}; \epsilon_r = 52; \rho = 1000 \text{ kg/m}^3$$

Phantom section: Flat Section; Space: 1.0 cm

Test Date: 08-01-2011; Ambient Temp: 23.9°C; Tissue Temp: 22.5°C

Probe: EX3DV4 - SN3550; ConvF(6.25, 6.25, 6.25); Calibrated: 2/14/2011

Sensor-Surface: 3mm (Mechanical Surface Detection)

Electronics: DAE4 Sn665; Calibrated: 4/20/2011

Phantom: SAM Sub; Type: SAM 4.0; Serial: TP-1357

Measurement SW: DASY4, V4.7 Build 80; Postprocessing SW: SEMCAD, V1.8 Build 186

Mode: IEEE 802.11b, Body SAR, Ch 11, 1 Mbps, Back Side

Area Scan (7x11x1): Measurement grid: dx=15mm, dy=15mm

Zoom Scan (5x5x7)/Cube 0: Measurement grid: dx=8mm, dy=8mm, dz=5mm

Reference Value = 6.43 V/m

Peak SAR (extrapolated) = 0.179 W/kg

SAR(1 g) = 0.093 mW/g; SAR(10 g) = 0.048 mW/g

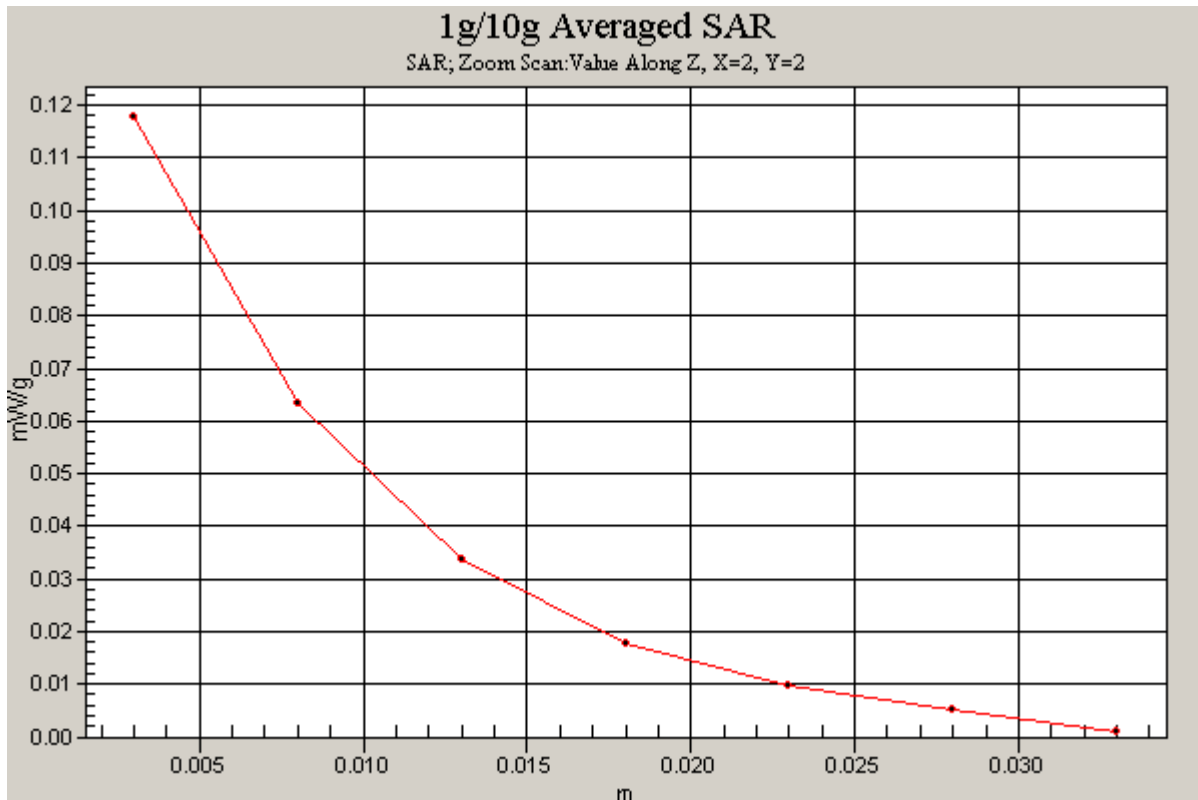

PCTEST ENGINEERING LABORATORY, INC.

**DUT: ZNFP690B; Type: 850/1900 GSM/GPRS/EDGE/WCDMA Phone
with Bluetooth and WLAN; Serial: 3**

Communication System: IEEE 802.11b; Frequency: 2462 MHz; Duty Cycle: 1:1
Medium: 2450 Body Medium parameters used (interpolated):

$$f = 2462 \text{ MHz}; \sigma = 1.89 \text{ mho/m}; \epsilon_r = 52; \rho = 1000 \text{ kg/m}^3$$

Phantom section: Flat Section; Space: 1.0 cm

Test Date: 08-01-2011; Ambient Temp: 23.9°C; Tissue Temp: 22.5°C

Probe: EX3DV4 - SN3550; ConvF(6.25, 6.25, 6.25); Calibrated: 2/14/2011

Sensor-Surface: 3mm (Mechanical Surface Detection)

Electronics: DAE4 Sn665; Calibrated: 4/20/2011

Phantom: SAM Sub; Type: SAM 4.0; Serial: TP-1357

Measurement SW: DASY4, V4.7 Build 80; Postprocessing SW: SEMCAD, V1.8 Build 186

Mode: IEEE 802.11b, Body SAR, Ch 11, 1 Mbps, Front Side

Area Scan (7x11x1): Measurement grid: dx=15mm, dy=15mm

Zoom Scan (5x5x7)/Cube 0: Measurement grid: dx=8mm, dy=8mm, dz=5mm

Reference Value = 5.41 V/m

Peak SAR (extrapolated) = 0.096 W/kg

SAR(1 g) = 0.053 mW/g; SAR(10 g) = 0.028 mW/g

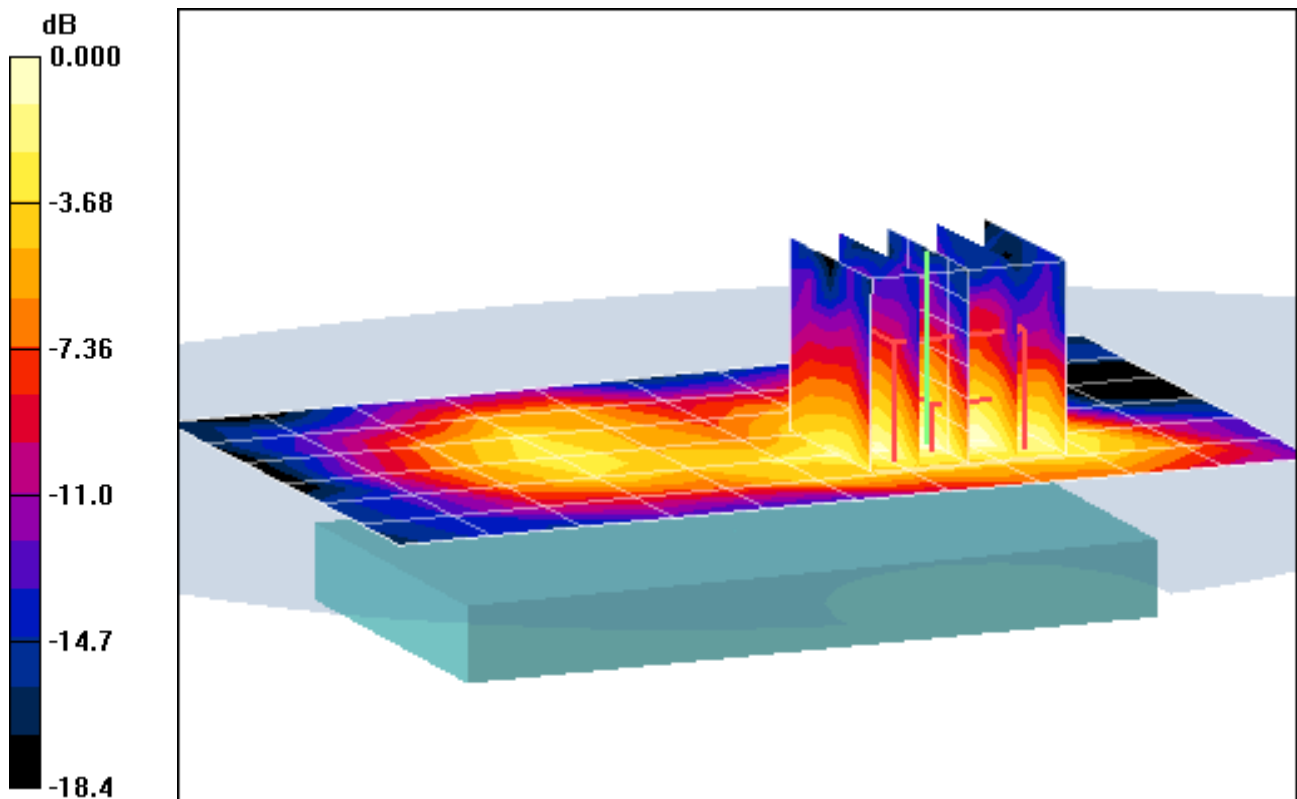

0 dB = 0.065mW/g

PCTEST ENGINEERING LABORATORY, INC.

**DUT: ZNFP690B; Type: 850/1900 GSM/GPRS/EDGE/WCDMA Phone
with Bluetooth and WLAN; Serial: 3**

Communication System: IEEE 802.11b; Frequency: 2462 MHz; Duty Cycle: 1:1

Medium: 2450 Body Medium parameters used (interpolated):

$f = 2462 \text{ MHz}$; $\sigma = 1.89 \text{ mho/m}$; $\epsilon_r = 52$; $\rho = 1000 \text{ kg/m}^3$

Phantom section: Flat Section; Space: 1.0 cm

Test Date: 08-01-2011; Ambient Temp: 23.9°C; Tissue Temp: 22.5°C

Probe: EX3DV4 - SN3550; ConvF(6.25, 6.25, 6.25); Calibrated: 2/14/2011

Sensor-Surface: 3mm (Mechanical Surface Detection)

Electronics: DAE4 Sn665; Calibrated: 4/20/2011

Phantom: SAM Sub; Type: SAM 4.0; Serial: TP-1357

Measurement SW: DASY4, V4.7 Build 80; Postprocessing SW: SEMCAD, V1.8 Build 186

Mode: IEEE 802.11b, Body SAR, Ch.11, 1 Mbps, Top Edge

Area Scan (5x7x1): Measurement grid: dx=15mm, dy=15mm

Zoom Scan (5x5x7)/Cube 0: Measurement grid: dx=8mm, dy=8mm, dz=5mm

Reference Value = 2.56 V/m

Peak SAR (extrapolated) = 0.027 W/kg

SAR(1 g) = 0.012 mW/g; SAR(10 g) = 0.00528 mW/g

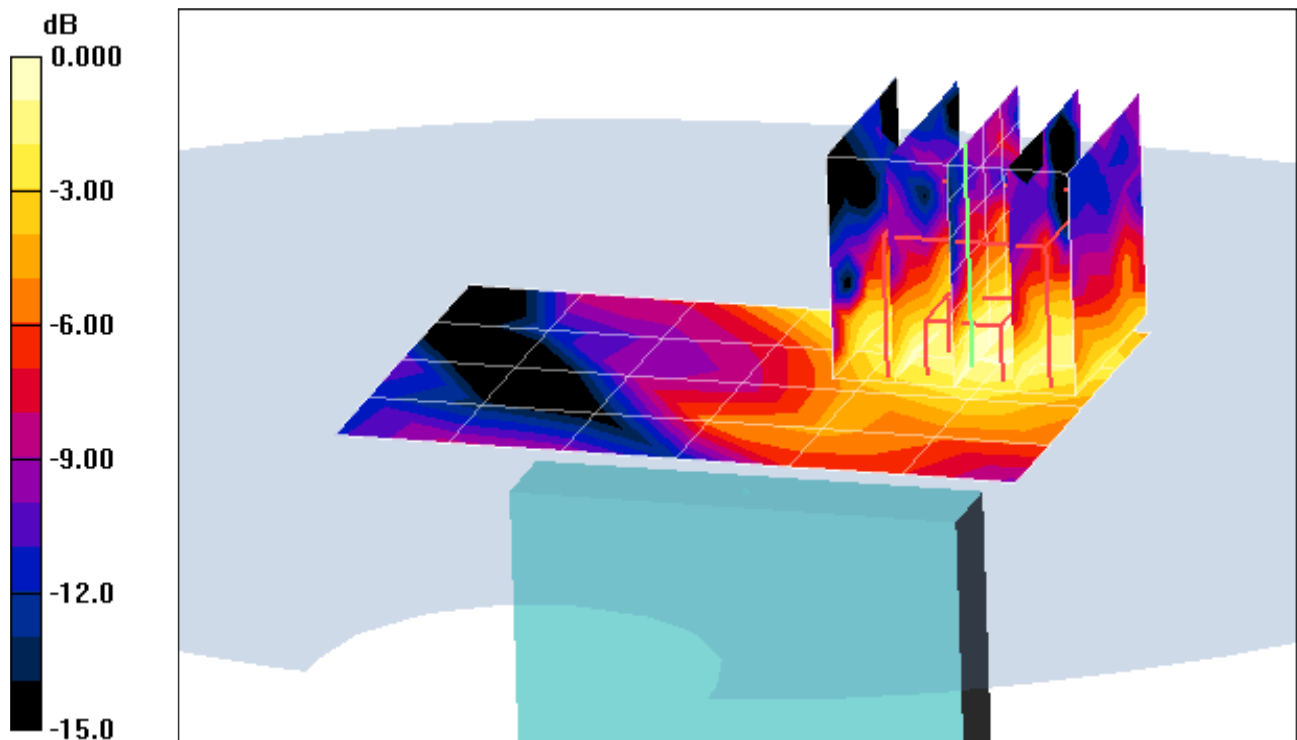

0 dB = 0.014mW/g

PCTEST ENGINEERING LABORATORY, INC.

**DUT: ZNFP690B; Type: 850/1900 GSM/GPRS/EDGE/WCDMA Phone
with Bluetooth and WLAN; Serial: 3**

Communication System: IEEE 802.11b; Frequency: 2462 MHz; Duty Cycle: 1:1

Medium: 2450 Body Medium parameters used (interpolated):

$f = 2462 \text{ MHz}$; $\sigma = 1.89 \text{ mho/m}$; $\epsilon_r = 52$; $\rho = 1000 \text{ kg/m}^3$

Phantom section: Flat Section; Space: 1.0 cm

Test Date: 08-01-2011; Ambient Temp: 23.9°C; Tissue Temp: 22.5°C

Probe: EX3DV4 - SN3550; ConvF(6.25, 6.25, 6.25); Calibrated: 2/14/2011

Sensor-Surface: 3mm (Mechanical Surface Detection)

Electronics: DAE4 Sn665; Calibrated: 4/20/2011

Phantom: SAM Sub; Type: SAM 4.0; Serial: TP-1357

Measurement SW: DASY4, V4.7 Build 80; Postprocessing SW: SEMCAD, V1.8 Build 186

Mode: IEEE 802.11b, Body SAR, Ch.11, 1 Mbps, Right Edge

Area Scan (5x13x1): Measurement grid: dx=15mm, dy=15mm

Zoom Scan (5x5x7)/Cube 0: Measurement grid: dx=8mm, dy=8mm, dz=5mm

Reference Value = 5.64 V/m

Peak SAR (extrapolated) = 0.133 W/kg

SAR(1 g) = 0.072 mW/g; SAR(10 g) = 0.038 mW/g

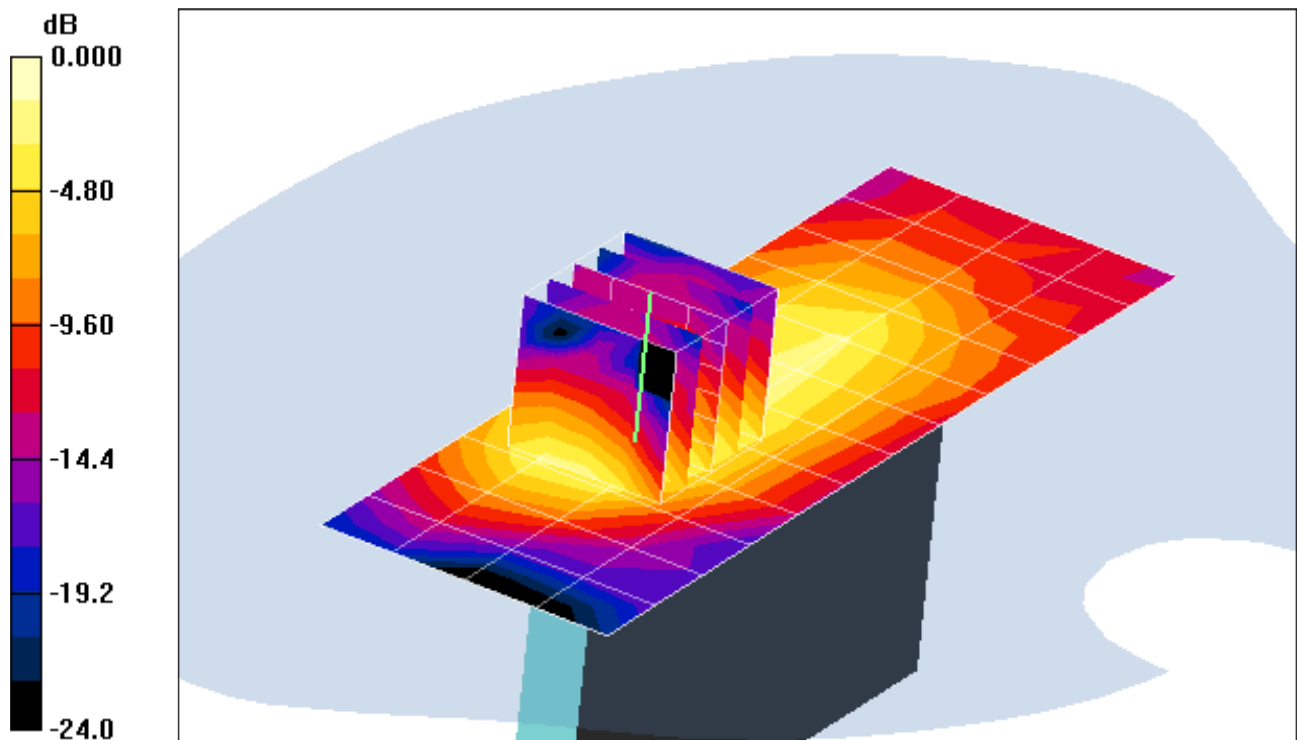

0 dB = 0.091mW/g

APPENDIX B: DIPOLE VALIDATION

PCTEST ENGINEERING LABORATORY, INC.

DUT: Dipole 835 MHz; Type: D835V2; Serial: 4d047

Communication System: CW; Frequency: 835 MHz; Duty Cycle: 1:1

Medium: 835 Head Medium parameters used:

$f = 835 \text{ MHz}$; $\sigma = 0.867 \text{ mho/m}$; $\epsilon_r = 40.1$; $\rho = 1000 \text{ kg/m}^3$

Phantom section: Flat Section; Space: 1.5 cm

Test Date: 07-18-2011; Ambient Temp: 23.3 °C; Tissue Temp: 21.5 °C

Probe: ES3DV3 - SN3258; ConvF(6.18, 6.18, 6.18); Calibrated: 4/8/2011

Sensor-Surface: 4mm (Mechanical Surface Detection)

Electronics: DAE4 Sn649; Calibrated: 2/21/2011

Phantom: SAM Sub; Type: SAM 4.0; Serial: TP-1357

Measurement SW: DASY4, V4.7 Build 80; Postprocessing SW: SEMCAD, V1.8 Build 186

835MHz System Verification

Area Scan (7x13x1): Measurement grid: dx=15mm, dy=15mm

Zoom Scan (5x5x7)/Cube 0: Measurement grid: dx=8mm, dy=8mm, dz=5mm

Input Power = 18.0 dBm (63 mW)

SAR(1 g) = 0.625 mW/g; SAR(10 g) = 0.404 mW/g

Deviation = 4.10 %

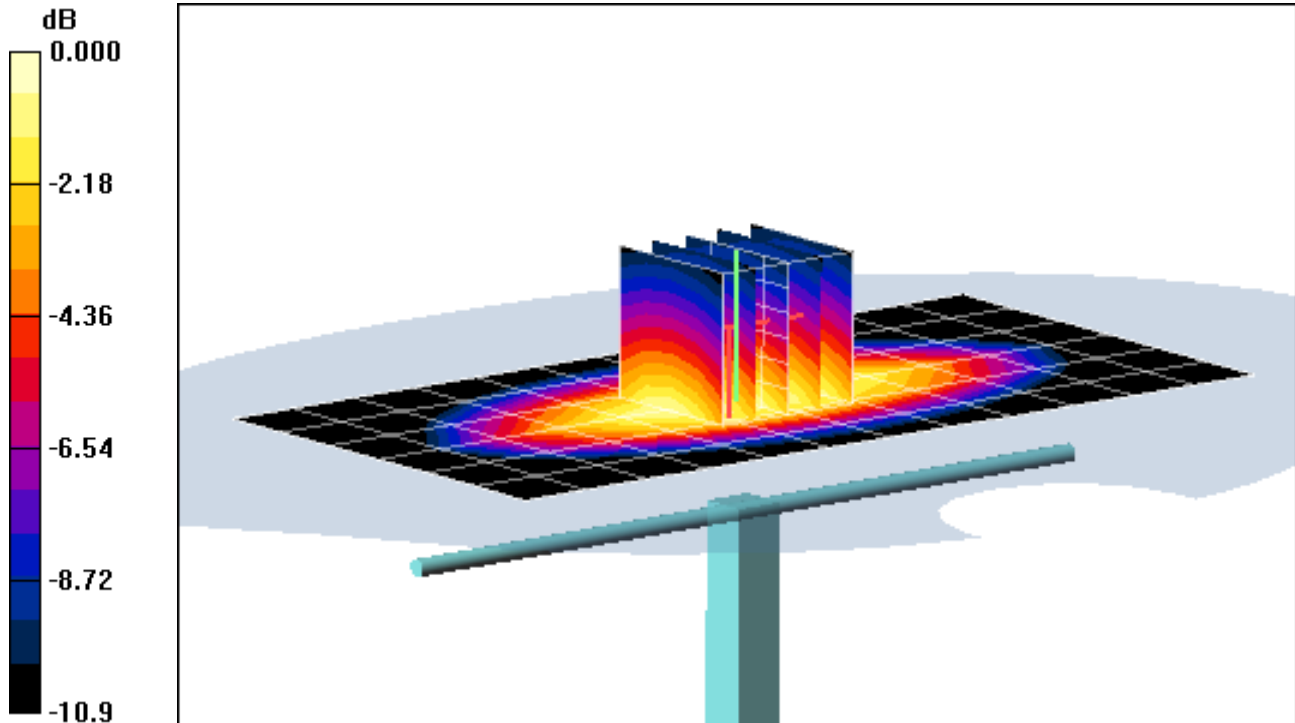

0 dB = 0.676mW/g

PCTEST ENGINEERING LABORATORY, INC.

DUT: Dipole 835 MHz; Type: D835V2; Serial: 4d047

Communication System: CW; Frequency: 835 MHz; Duty Cycle: 1:1

Medium: 835 Body Medium parameters used:

$f = 835 \text{ MHz}$; $\sigma = 0.993 \text{ mho/m}$; $\epsilon_r = 55.3$; $\rho = 1000 \text{ kg/m}^3$

Phantom section: Flat Section; Space: 1.5 cm

Test Date: 07-21-2011; Ambient Temp: 23.6 °C; Tissue Temp: 21.9 °C

Probe: ES3DV3 - SN3258; ConvF(6.12, 6.12, 6.12); Calibrated: 4/8/2011

Sensor-Surface: 4mm (Mechanical Surface Detection)

Electronics: DAE4 Sn649; Calibrated: 2/21/2011

Phantom: SAM Main; Type: SAM 4.0; Serial: TP-1114

Measurement SW: DASY4, V4.7 Build 80; Postprocessing SW: SEMCAD, V1.8 Build 186

835MHz System Verification

Area Scan (7x13x1): Measurement grid: dx=15mm, dy=15mm

Zoom Scan (5x5x7)/Cube 0: Measurement grid: dx=8mm, dy=8mm, dz=5mm

Input Power = 18.0 dBm (63 mW)

SAR(1 g) = 0.636 mW/g; SAR(10 g) = 0.414 mW/g

Deviation = 2.49 %

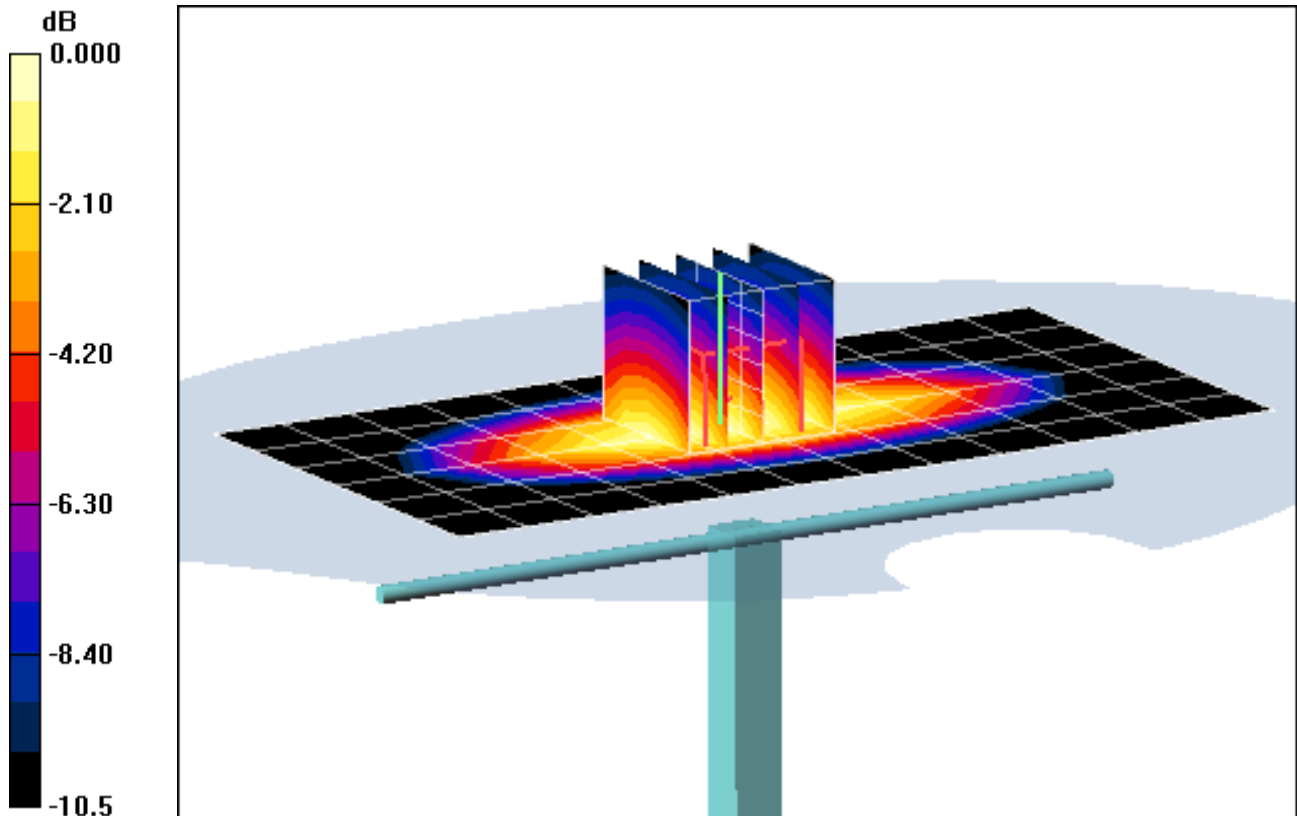

0 dB = 0.690mW/g

PCTEST ENGINEERING LABORATORY, INC.

DUT: SAR Dipole 1900 MHz; Type: D1900V2; Serial: 502

Communication System: CW; Frequency: 1900 MHz; Duty Cycle: 1:1

Medium: 1900 Head; Medium parameters used (interpolated):

$f = 1900 \text{ MHz}$; $\sigma = 1.44 \text{ mho/m}$; $\epsilon_r = 38.1$; $\rho = 1000 \text{ kg/m}^3$

Phantom section: Flat Section; Space: 1.0 cm

Test Date: 07-21-2011; Ambient Temp: 24.8 °C; Tissue Temp: 23.1 °C

Probe: EX3DV4 - SN3550; ConvF(7.01, 7.01, 7.01); Calibrated: 2/14/2011

Sensor-Surface: 4mm (Mechanical Surface Detection)

Electronics: DAE4 Sn665; Calibrated: 4/20/2011

Phantom: SAM Main; Type: SAM 4.0; Serial: TP-1114

Measurement SW: DASY4, V4.7 Build 80; Postprocessing SW: SEMCAD, V1.8 Build 186

1900MHz System Verification

Area Scan (5x7x1): Measurement grid: dx=15mm, dy=15mm

Zoom Scan (5x5x7)/Cube 0: Measurement grid: dx=8mm, dy=8mm, dz=5mm

Input Power = 16 dBm (40 mW)

SAR(1 g) = 1.6 mW/g; SAR(10 g) = 0.820 mW/g

Deviation = -0.50 %

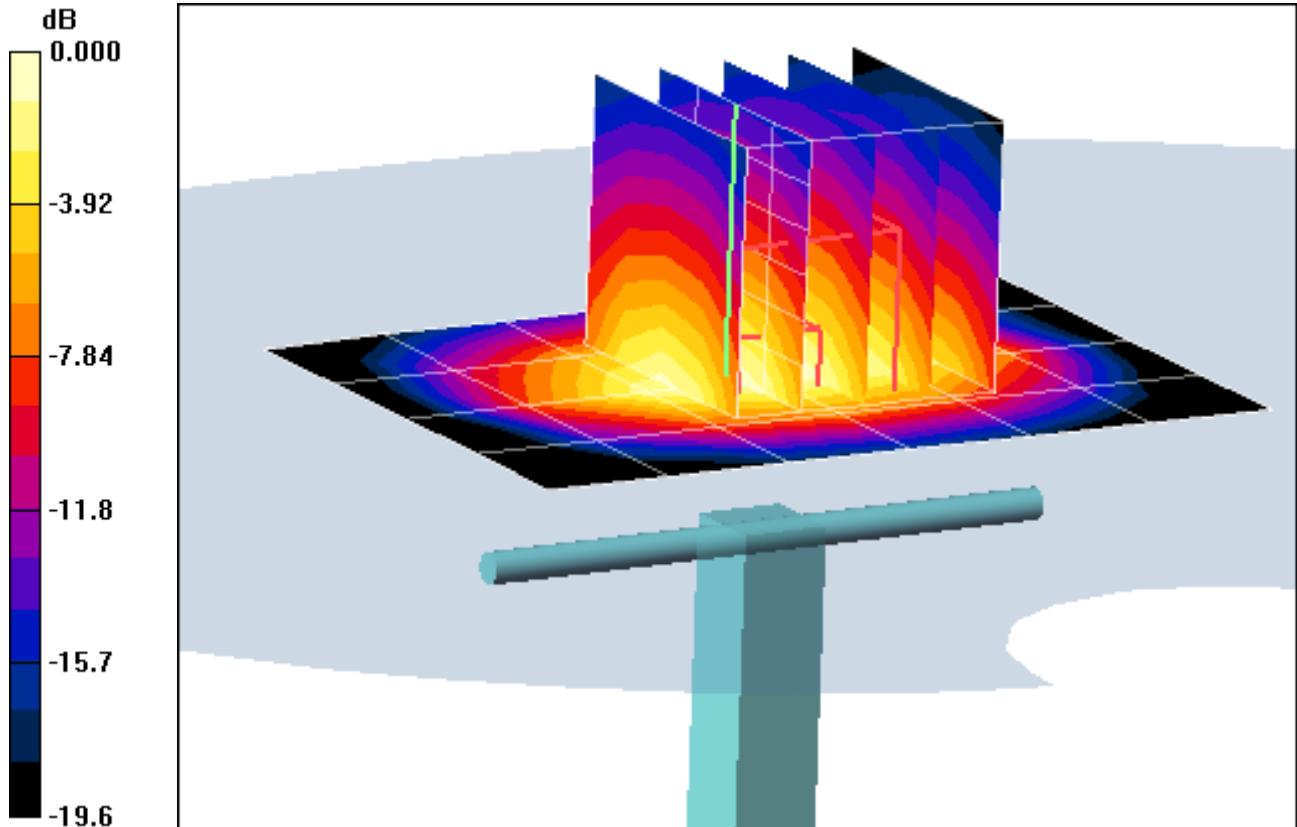

0 dB = 1.76mW/g

PCTEST ENGINEERING LABORATORY, INC.

DUT: Dipole 1900 MHz; Type: D1900V2; Serial: 502

Communication System: CW; Frequency: 1900 MHz; Duty Cycle: 1:1

Medium: 1900 Body; Medium parameters used (interpolated):

$f = 1900 \text{ MHz}$; $\sigma = 1.55 \text{ mho/m}$; $\epsilon_r = 51.8$; $\rho = 1000 \text{ kg/m}^3$

Phantom section: Flat Section; Space: 1.0 cm

Test Date: 07-20-2011; Ambient Temp: 23.9 °C; Tissue Temp: 22.6 °C

Probe: EX3DV4 - SN3550; ConvF(6.77, 6.77, 6.77); Calibrated: 2/14/2011

Sensor-Surface: 4mm (Mechanical Surface Detection)

Electronics: DAE4 Sn665; Calibrated: 4/20/2011

Phantom: SAM Sub; Type: SAM 4.0; Serial: TP-1357

Measurement SW: DASY4, V4.7 Build 80; Postprocessing SW: SEMCAD, V1.8 Build 186

1900MHz System Verification

Area Scan (5x7x1): Measurement grid: dx=15mm, dy=15mm

Zoom Scan (5x5x7)/Cube 0: Measurement grid: dx=8mm, dy=8mm, dz=5mm

Input Power = 16 dBm (40 mW)

SAR(1 g) = 1.7 mW/g; SAR(10 g) = 0.877 mW/g

Deviation = 3.41 %

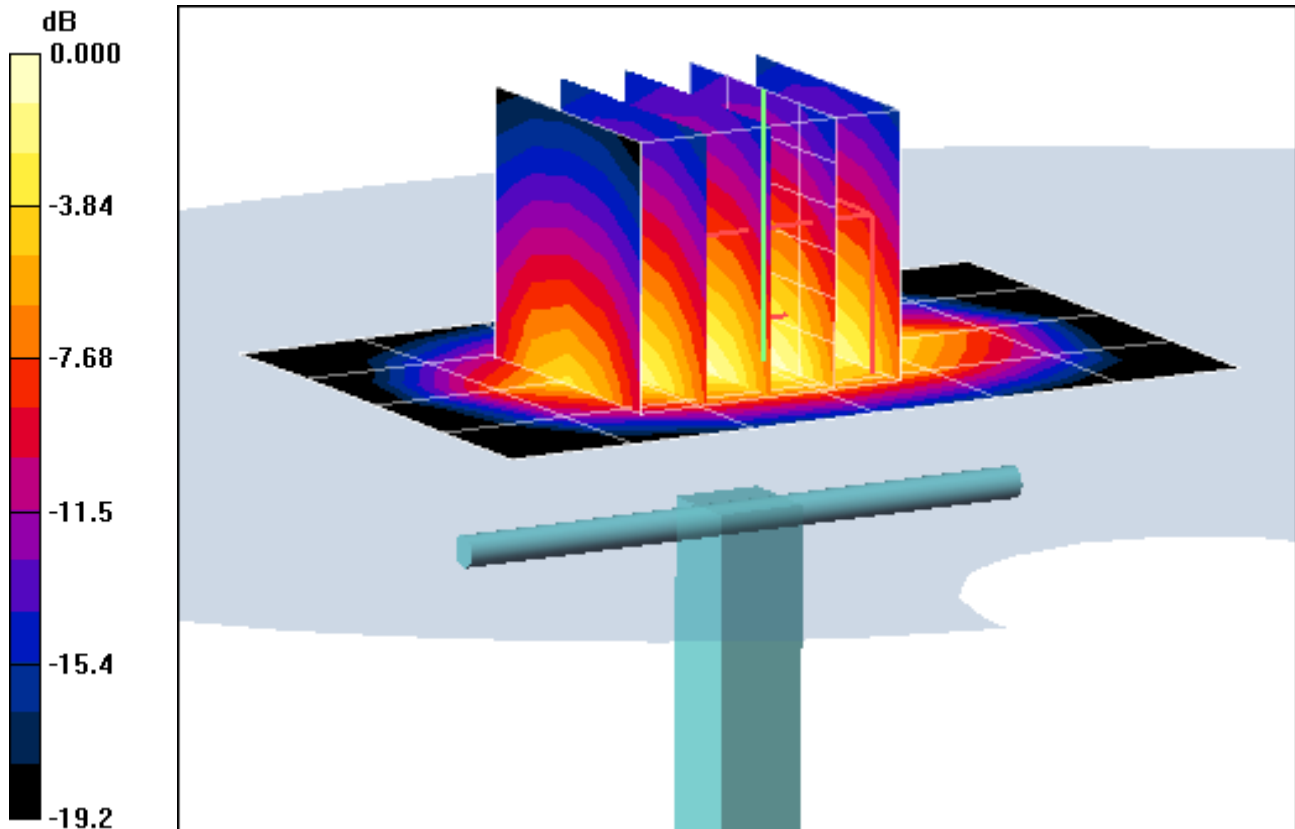

0 dB = 1.90mW/g

PCTEST ENGINEERING LABORATORY, INC.

DUT: SAR Dipole 2450 MHz; Type: D2450V2; Serial: 797

Communication System: CW; Frequency: 2450 MHz; Duty Cycle: 1:1

Medium: 2450 Head Medium parameters used:

$f = 2450 \text{ MHz}$; $\sigma = 1.78 \text{ mho/m}$; $\epsilon_r = 38.63$; $\rho = 1000 \text{ kg/m}^3$

Phantom section: Flat Section; Space: 1.0 cm

Test Date: 08-01-2011; Ambient Temp: 23.7°C; Tissue Temp: 22.3°C

Probe: EX3DV4 - SN3550; ConvF(6.29, 6.29, 6.29); Calibrated: 2/14/2011

Sensor-Surface: 3mm (Mechanical Surface Detection)

Electronics: DAE4 Sn665; Calibrated: 4/20/2011

Phantom: SAM Main; Type: SAM 4.0; Serial: TP-1114

Measurement SW: DASY4, V4.7 Build 80; Postprocessing SW: SEMCAD, V1.8 Build 186

2450MHz System Verification

Area Scan (5x7x1): Measurement grid: dx=15mm, dy=15mm

Zoom Scan (5x5x7)/Cube 0: Measurement grid: dx=8mm, dy=8mm, dz=5mm

Input Power = 16 dBm (40 mW)

SAR(1 g) = 2.3 mW/g; SAR(10 g) = 1.04 mW/g

Deviation = 7.88 %

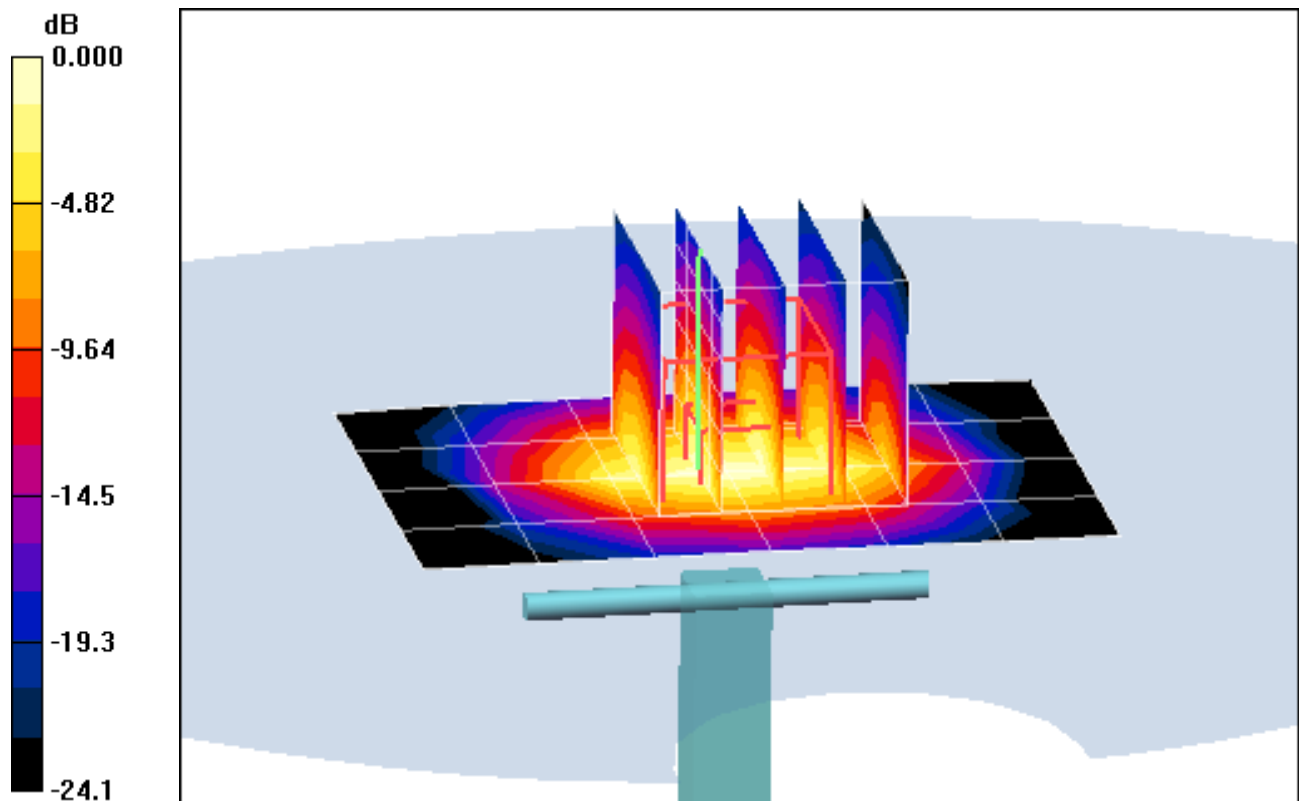

0 dB = 2.96mW/g

PCTEST ENGINEERING LABORATORY, INC.

DUT: SAR Dipole 2450 MHz; Type: D2450V2; Serial: 797

Communication System: CW; Frequency: 2450 MHz; Duty Cycle: 1:1

Medium: 2450 Body Medium parameters used:

$f = 2450 \text{ MHz}$; $\sigma = 1.88 \text{ mho/m}$; $\epsilon_r = 52.1$; $\rho = 1000 \text{ kg/m}^3$

Phantom section: Flat Section; Space: 1.0 cm

Test Date: 08-01-2011; Ambient Temp: 23.9°C; Tissue Temp: 22.5°C

Probe: EX3DV4 - SN3550; ConvF(6.25, 6.25, 6.25); Calibrated: 2/14/2011

Sensor-Surface: 3mm (Mechanical Surface Detection)

Electronics: DAE4 Sn665; Calibrated: 4/20/2011

Phantom: SAM Sub; Type: SAM 4.0; Serial: TP-1357

Measurement SW: DASY4, V4.7 Build 80; Postprocessing SW: SEMCAD, V1.8 Build 186

2450MHz System Verification

Area Scan (5x7x1): Measurement grid: dx=15mm, dy=15mm

Zoom Scan (5x5x7)/Cube 0: Measurement grid: dx=8mm, dy=8mm, dz=5mm

Input Power = 16 dBm (40 mW)

SAR(1 g) = 2.18 mW/g; SAR(10 g) = 1 mW/g

Deviation = 4.21 %

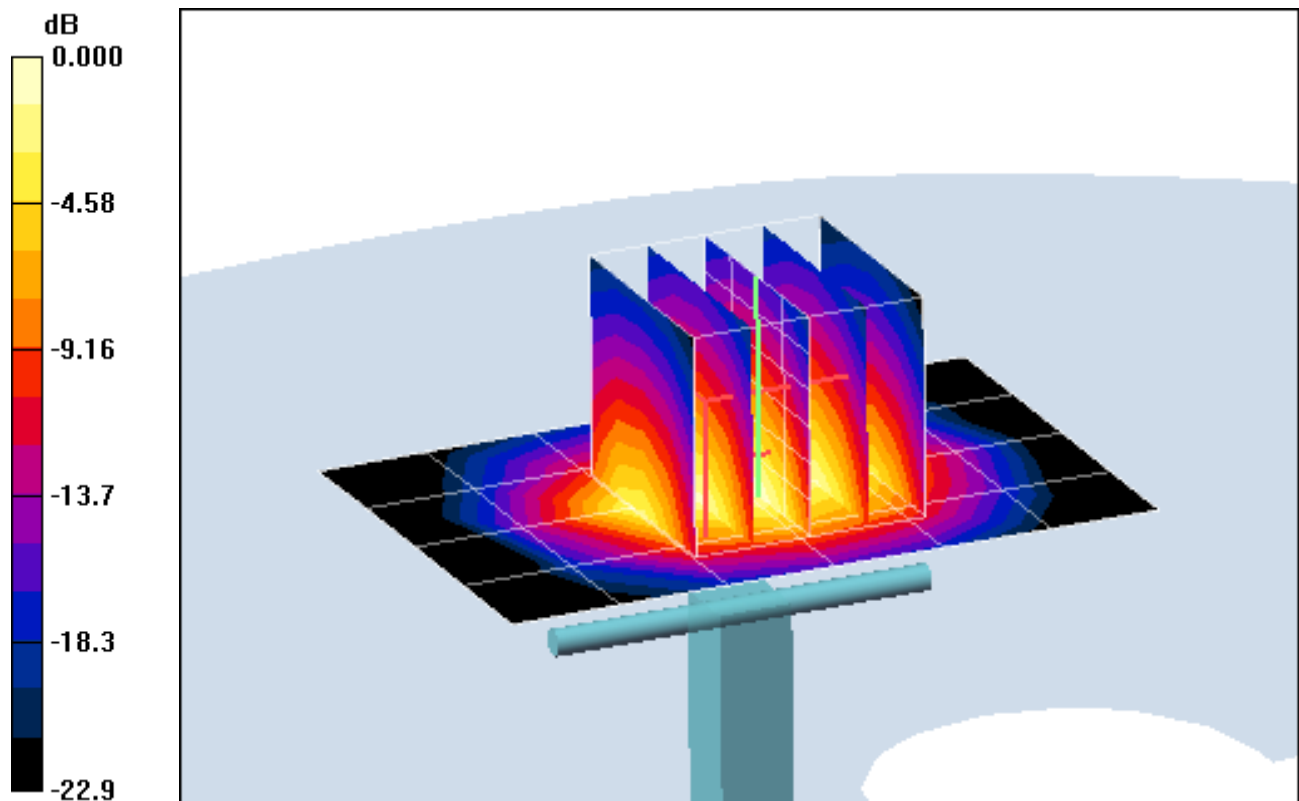

0 dB = 2.85mW/g

APPENDIX C: PROBE CALIBRATION



Accredited by the Swiss Accreditation Service (SAS)
The Swiss Accreditation Service is one of the signatories to the EA
Multilateral Agreement for the recognition of calibration certificates

Accreditation No.: **SCS 108**

Client **PC Test**

Certificate No: **ES3-3258_Apr11**

CALIBRATION CERTIFICATE

Object **ES3DV3 - SN:3258**

Calibration procedure(s) **QA CAL-01.v7, QA CAL-23.v4, QA CAL-25.v3
Calibration procedure for dosimetric E-field probes**

Calibration date: **April 8, 2011**

This calibration certificate documents the traceability to national standards, which realize the physical units of measurements (SI).
The measurements and the uncertainties with confidence probability are given on the following pages and are part of the certificate.

All calibrations have been conducted in the closed laboratory facility: environment temperature (22 ± 3)°C and humidity < 70%.

Calibration Equipment used (M&TE critical for calibration)

*✓ KOK
6/2/11*

Primary Standards	ID	Cal Date (Certificate No.)	Scheduled Calibration
Power meter E4419B	GB41293874	31-Mar-11 (No. 217-01372)	Apr-12
Power sensor E4412A	MY41495277	31-Mar-11 (No. 217-01372)	Apr-12
Power sensor E4412A	MY41498087	31-Mar-11 (No. 217-01372)	Apr-12
Reference 3 dB Attenuator	SN: S5054 (3c)	29-Mar-11 (No. 217-01369)	Apr-12
Reference 20 dB Attenuator	SN: S5086 (20b)	29-Mar-11 (No. 217-01367)	Apr-12
Reference 30 dB Attenuator	SN: S5129 (30b)	29-Mar-11 (No. 217-01370)	Apr-12
Reference Probe ES3DV2	SN: 3013	29-Dec-10 (No. ES3-3013_Dec10)	Dec-11
DAE4	SN: 654	23-Apr-10 (No. DAE4-654_Apr10)	Apr-11
Secondary Standards	ID	Check Date (in house)	Scheduled Check
RF generator HP 8648C	US3642U01700	4-Aug-99 (in house check Oct-09)	In house check: Oct-11
Network Analyzer HP 8753E	US37390585	18-Oct-01 (in house check Oct-10)	In house check: Oct-11

	Name	Function	Signature
Calibrated by:	Dimce Iliev	Laboratory Technician	<i>Dimce Iliev</i>
Approved by:	Kalja Pokovic	Technical Manager	<i>Kalja Pokovic</i>

Issued: April 13, 2011

This calibration certificate shall not be reproduced except in full without written approval of the laboratory.



Accredited by the Swiss Accreditation Service (SAS)

Accreditation No.: **SCS 108**

The Swiss Accreditation Service is one of the signatories to the EA Multilateral Agreement for the recognition of calibration certificates

Glossary:

TSL	tissue simulating liquid
NORM _{x,y,z}	sensitivity in free space
ConvF	sensitivity in TSL / NORM _{x,y,z}
DCP	diode compression point
CF	crest factor (1/duty_cycle) of the RF signal
A, B, C	modulation dependent linearization parameters
Polarization φ	φ rotation around probe axis
Polarization ϑ	ϑ rotation around an axis that is in the plane normal to probe axis (at measurement center), i.e., $\vartheta = 0$ is normal to probe axis

Calibration is Performed According to the Following Standards:

- IEEE Std 1528-2003, "IEEE Recommended Practice for Determining the Peak Spatial-Averaged Specific Absorption Rate (SAR) in the Human Head from Wireless Communications Devices: Measurement Techniques", December 2003
- IEC 62209-1, "Procedure to measure the Specific Absorption Rate (SAR) for hand-held devices used in close proximity to the ear (frequency range of 300 MHz to 3 GHz)", February 2005

Methods Applied and Interpretation of Parameters:

- NORM_{x,y,z}**: Assessed for E-field polarization $\vartheta = 0$ ($f \leq 900$ MHz in TEM-cell; $f > 1800$ MHz: R22 waveguide). NORM_{x,y,z} are only intermediate values, i.e., the uncertainties of NORM_{x,y,z} does not affect the E²-field uncertainty inside TSL (see below ConvF).
- NORM(f)_{x,y,z}** = NORM_{x,y,z} * frequency_response (see Frequency Response Chart). This linearization is implemented in DASY4 software versions later than 4.2. The uncertainty of the frequency response is included in the stated uncertainty of ConvF.
- DCP_{x,y,z}**: DCP are numerical linearization parameters assessed based on the data of power sweep with CW signal (no uncertainty required). DCP does not depend on frequency nor media.
- PAR**: PAR is the Peak to Average Ratio that is not calibrated but determined based on the signal characteristics
- A_{x,y,z}; B_{x,y,z}; C_{x,y,z}** are numerical linearization parameters in dB assessed based on the data of power sweep for specific modulation signal. The parameters do not depend on frequency nor media.
- VR**: VR is the validity range of the calibration related to the average diode voltage or DAE voltage in mV.
- ConvF and Boundary Effect Parameters**: Assessed in flat phantom using E-field (or Temperature Transfer Standard for $f \leq 800$ MHz) and inside waveguide using analytical field distributions based on power measurements for $f > 800$ MHz. The same setups are used for assessment of the parameters applied for boundary compensation (alpha, depth) of which typical uncertainty values are given. These parameters are used in DASY4 software to improve probe accuracy close to the boundary. The sensitivity in TSL corresponds to NORM_{x,y,z} * ConvF whereby the uncertainty corresponds to that given for ConvF. A frequency dependent ConvF is used in DASY version 4.4 and higher which allows extending the validity from ± 50 MHz to ± 100 MHz.
- Spherical isotropy (3D deviation from isotropy)**: in a field of low gradients realized using a flat phantom exposed by a patch antenna.
- Sensor Offset**: The sensor offset corresponds to the offset of virtual measurement center from the probe tip (on probe axis). No tolerance required.

Probe ES3DV3

SN:3258

Manufactured: January 25, 2010
Calibrated: April 8, 2011

Calibrated for DASY/EASY Systems
(Note: non-compatible with DASY2 system!)

DASY/EASY - Parameters of Probe: ES3DV3 - SN:3258

Basic Calibration Parameters

	Sensor X	Sensor Y	Sensor Z	Unc (k=2)
Norm ($\mu V/(V/m)^2$) ^A	1.31	1.19	1.25	± 10.1 %
DCP (mV) ^B	98.3	103.8	99.8	

Modulation Calibration Parameters

UID	Communication System Name	PAR		A dB	B dB	C dB	VR mV	Unc ^E (k=2)
10000	CW	0.00	X	0.00	0.00	1.00	115.1	±2.7 %
			Y	0.00	0.00	1.00	105.5	
			Z	0.00	0.00	1.00	113.5	

The reported uncertainty of measurement is stated as the standard uncertainty of measurement multiplied by the coverage factor k=2, which for a normal distribution corresponds to a coverage probability of approximately 95%.

^A The uncertainties of NormX,Y,Z do not affect the E²-field uncertainty inside TSL (see Pages 5 and 6).

^B Numerical linearization parameter: uncertainty not required.

^E Uncertainty is determined using the max. deviation from linear response applying rectangular distribution and is expressed for the square of the field value.

DASY/EASY - Parameters of Probe: ES3DV3 - SN:3258

Calibration Parameter Determined in Head Tissue Simulating Media

f (MHz) ^C	Relative Permittivity ^F	Conductivity (S/m) ^F	ConvF X	ConvF Y	ConvF Z	Alpha	Depth (mm)	Unct. (k=2)
750	41.9	0.89	6.41	6.41	6.41	1.00	1.00	± 12.0 %
835	41.5	0.90	6.18	6.18	6.18	1.00	1.00	± 12.0 %
1750	40.1	1.37	5.32	5.32	5.32	0.99	1.16	± 12.0 %
1900	40.0	1.40	5.15	5.15	5.15	1.00	1.15	± 12.0 %
2450	39.2	1.80	4.50	4.50	4.50	0.87	1.26	± 12.0 %
2600	39.0	1.96	4.33	4.33	4.33	0.87	1.24	± 12.0 %

^C Frequency validity of ± 100 MHz only applies for DASY v4.4 and higher (see Page 2), else it is restricted to ± 50 MHz. The uncertainty is the RSS of the ConvF uncertainty at calibration frequency and the uncertainty for the indicated frequency band.

^F At frequencies below 3 GHz, the validity of tissue parameters (ϵ and σ) can be relaxed to ± 10% if liquid compensation formula is applied to measured SAR values. At frequencies above 3 GHz, the validity of tissue parameters (ϵ and σ) is restricted to ± 5%. The uncertainty is the RSS of the ConvF uncertainty for indicated target tissue parameters.

DASY/EASY - Parameters of Probe: ES3DV3- SN:3258

Calibration Parameter Determined in Body Tissue Simulating Media

f (MHz) ^C	Relative Permittivity ^F	Conductivity (S/m) ^F	ConvF X	ConvF Y	ConvF Z	Alpha	Depth (mm)	Unct. (k=2)
750	55.5	0.96	6.16	6.16	6.16	1.00	1.00	± 12.0 %
835	55.2	0.97	6.12	6.12	6.12	1.00	1.00	± 12.0 %
1750	53.4	1.49	5.00	5.00	5.00	0.91	1.28	± 12.0 %
1900	53.3	1.52	4.75	4.75	4.75	0.90	1.23	± 12.0 %
2450	52.7	1.95	4.34	4.34	4.34	1.00	1.00	± 12.0 %
2600	52.5	2.16	4.16	4.16	4.16	0.94	1.15	± 12.0 %

^C Frequency validity of ± 100 MHz only applies for DASY v4.4 and higher (see Page 2), else it is restricted to ± 50 MHz. The uncertainty is the RSS of the ConvF uncertainty at calibration frequency and the uncertainty for the indicated frequency band.

^F At frequencies below 3 GHz, the validity of tissue parameters (ϵ and σ) can be relaxed to ± 10% if liquid compensation formula is applied to measured SAR values. At frequencies above 3 GHz, the validity of tissue parameters (ϵ and σ) is restricted to ± 5%. The uncertainty is the RSS of the ConvF uncertainty for indicated target tissue parameters.

Frequency Response of E-Field

(TEM-Cell:ifi110 EXX, Waveguide: R22)

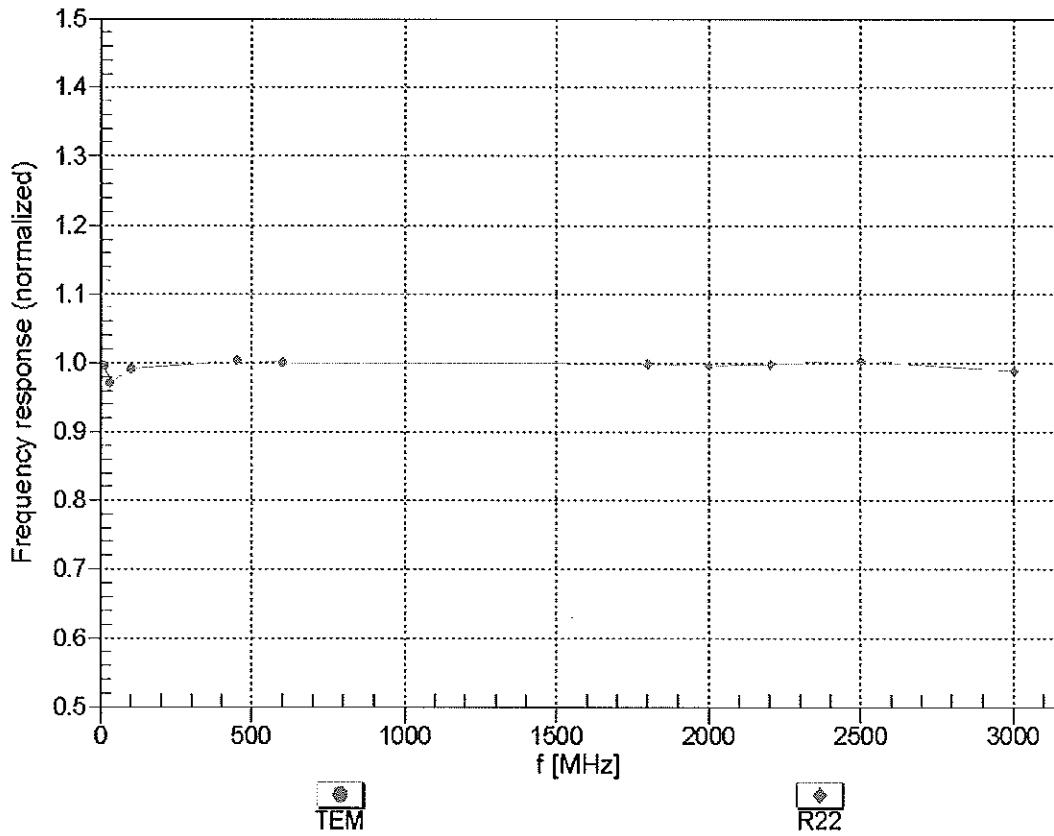

Uncertainty of Frequency Response of E-field: $\pm 6.3\%$ (k=2)

Receiving Pattern (ϕ), $\theta = 0^\circ$

f=600 MHz,TEM

f=1800 MHz,R22

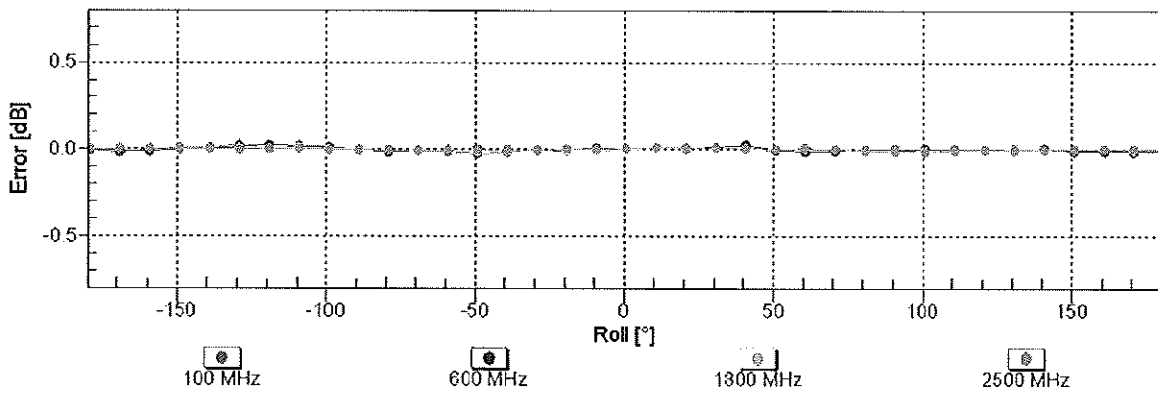
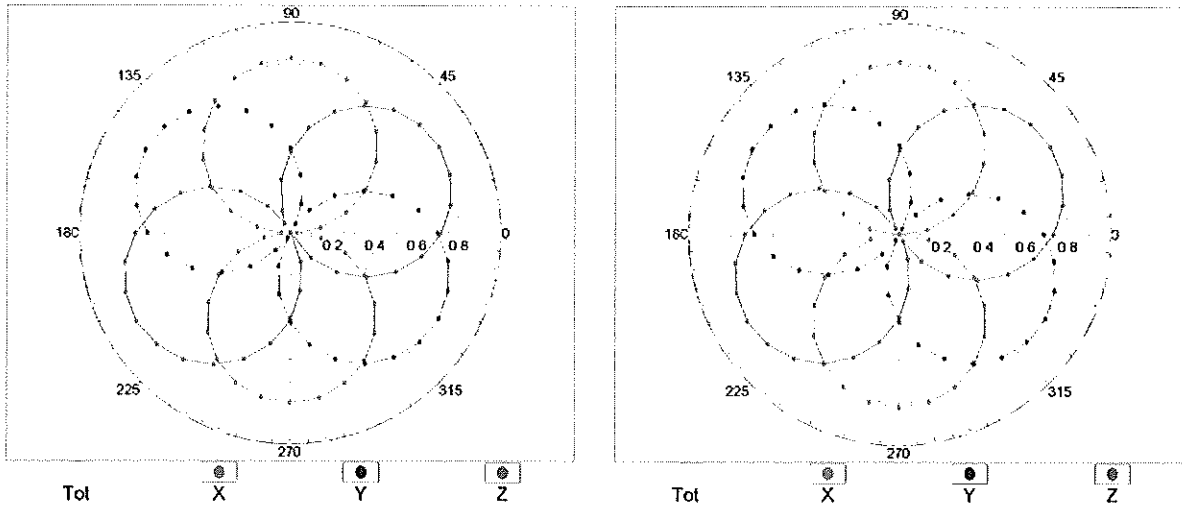

Uncertainty of Axial Isotropy Assessment: $\pm 0.5\%$ (k=2)

Dynamic Range $f(\text{SAR}_{\text{head}})$ (TEM cell , $f = 900 \text{ MHz}$)

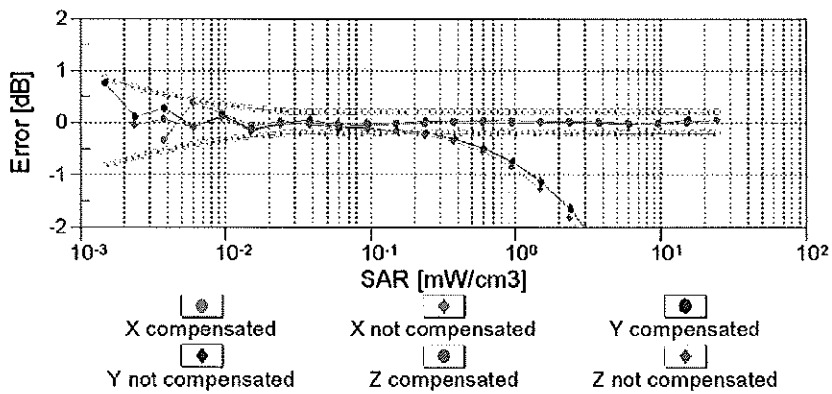
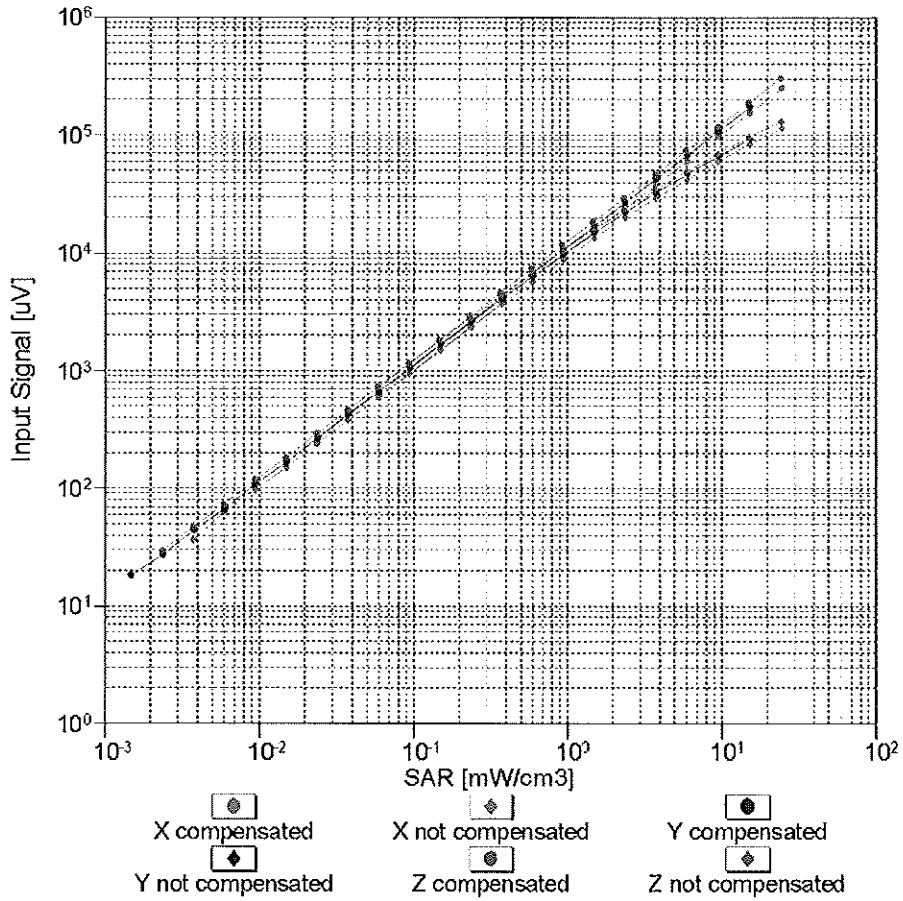

Uncertainty of Linearity Assessment: $\pm 0.6\%$ ($k=2$)

Conversion Factor Assessment

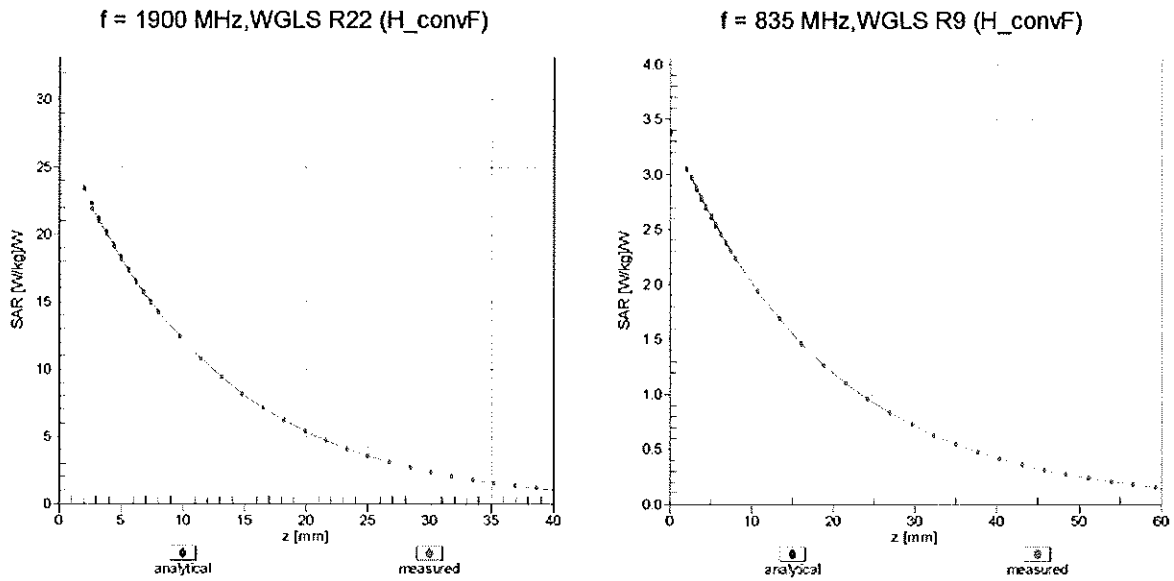

Deviation from Isotropy in Liquid Error (ϕ, θ), f = 900 MHz

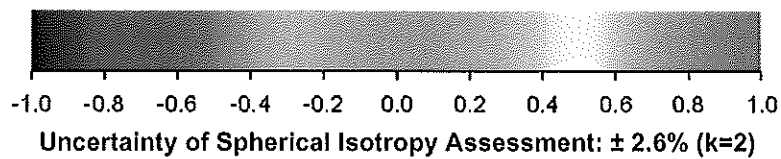
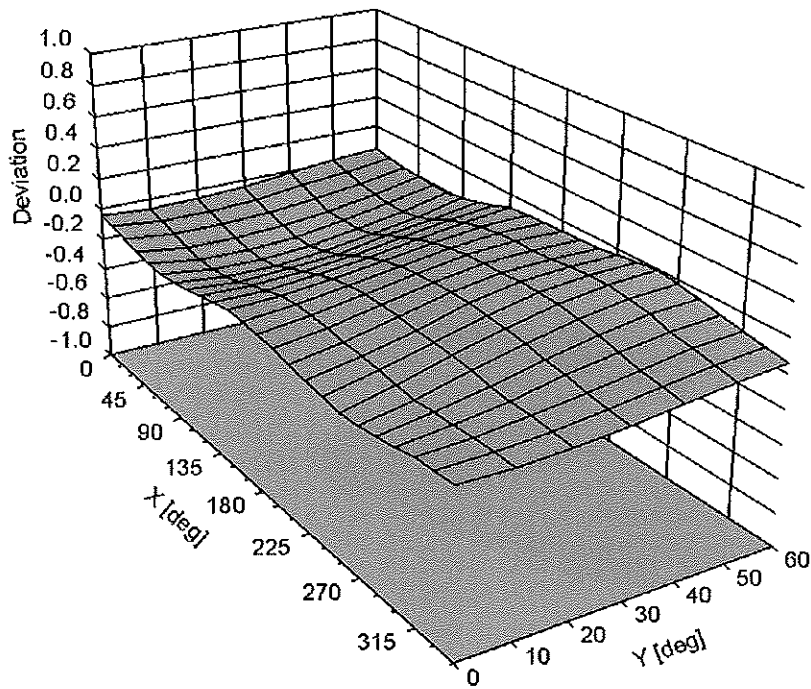

DASY/EASY - Parameters of Probe: ES3DV3 - SN:3258

Other Probe Parameters

Sensor Arrangement	Triangular
Connector Angle (°)	Not applicable
Mechanical Surface Detection Mode	enabled
Optical Surface Detection Mode	disabled
Probe Overall Length	337 mm
Probe Body Diameter	10 mm
Tip Length	10 mm
Tip Diameter	4 mm
Probe Tip to Sensor X Calibration Point	2 mm
Probe Tip to Sensor Y Calibration Point	2 mm
Probe Tip to Sensor Z Calibration Point	2 mm
Recommended Measurement Distance from Surface	3 mm



Accredited by the Swiss Accreditation Service (SAS)
The Swiss Accreditation Service is one of the signatories to the EA
Multilateral Agreement for the recognition of calibration certificates

Accreditation No.: SCS 108

Client **PC Test**

Certificate No: **EX-3550_Feb11**

CALIBRATION CERTIFICATE

Object: **EX3DV4 - SN:3550**

Calibration procedure(s): **QA CAL-01.v7, QA CAL-14.v3, QA CAL-23.v4, QA CAL-25.v3
Calibration procedure for dosimetric E-field probes**

Calibration date: **February 14, 2011**

This calibration certificate documents the traceability to national standards, which realize the physical units of measurements (SI).
The measurements and the uncertainties with confidence probability are given on the following pages and are part of the certificate.

All calibrations have been conducted in the closed laboratory facility: environment temperature (22 ± 3)°C and humidity < 70%.

Calibration Equipment used (M&TE critical for calibration)

✓
Kok
2/22/11

Primary Standards	ID	Cal Date (Certificate No.)	Scheduled Calibration
Power meter E4419B	GB41293874	01-Apr-10 (No. 217-01136)	Apr-11
Power sensor E4412A	MY41495277	01-Apr-10 (No. 217-01136)	Apr-11
Power sensor E4412A	MY41498087	01-Apr-10 (No. 217-01136)	Apr-11
Reference 3 dB Attenuator	SN: S5054 (3c)	30-Mar-10 (No. 217-01159)	Mar-11
Reference 20 dB Attenuator	SN: S5086 (20b)	30-Mar-10 (No. 217-01161)	Mar-11
Reference 30 dB Attenuator	SN: S5129 (30b)	30-Mar-10 (No. 217-01160)	Mar-11
Reference Probe ES3DV2	SN: 3013	29-Dec-10 (No. ES3-3013_Dec10)	Dec-11
DAE4	SN: 654	23-Apr-10 (No. DAE4-654_Apr10)	Apr-11
Secondary Standards	ID	Check Date (in house)	Scheduled Check
RF generator HP 8648C	US3642U01700	4-Aug-99 (in house check Oct-09)	In house check: Oct-11
Network Analyzer HP 8753E	US37390585	18-Oct-01 (in house check Oct-10)	In house check: Oct-11

	Name	Function	Signature
Calibrated by:	Katja Pokovic	Technical Manager	
Approved by:	Niels Kuster	Quality Manager	

Issued: February 14, 2011

This calibration certificate shall not be reproduced except in full without written approval of the laboratory.



Accredited by the Swiss Accreditation Service (SAS)

Accreditation No.: **SCS 108**

The Swiss Accreditation Service is one of the signatories to the EA Multilateral Agreement for the recognition of calibration certificates

Glossary:

TSL	tissue simulating liquid
NORM _{x,y,z}	sensitivity in free space
ConvF	sensitivity in TSL / NORM _{x,y,z}
DCP	diode compression point
CF	crest factor (1/duty_cycle) of the RF signal
A, B, C	modulation dependent linearization parameters
Polarization ω	ω rotation around probe axis
Polarization ϑ	ϑ rotation around an axis that is in the plane normal to probe axis (at measurement center), i.e., $\vartheta = 0$ is normal to probe axis

Calibration is Performed According to the Following Standards:

- IEEE Std 1528-2003, "IEEE Recommended Practice for Determining the Peak Spatial-Averaged Specific Absorption Rate (SAR) in the Human Head from Wireless Communications Devices: Measurement Techniques", December 2003
- IEC 62209-1, "Procedure to measure the Specific Absorption Rate (SAR) for hand-held devices used in close proximity to the ear (frequency range of 300 MHz to 3 GHz)", February 2005

Methods Applied and Interpretation of Parameters:

- NORM_{x,y,z}**: Assessed for E-field polarization $\vartheta = 0$ ($f \leq 900$ MHz in TEM-cell; $f > 1800$ MHz: R22 waveguide). NORM_{x,y,z} are only intermediate values, i.e., the uncertainties of NORM_{x,y,z} does not affect the E^2 -field uncertainty inside TSL (see below ConvF).
- NORM(f)_{x,y,z}** = NORM_{x,y,z} * frequency_response (see Frequency Response Chart). This linearization is implemented in DASY4 software versions later than 4.2. The uncertainty of the frequency response is included in the stated uncertainty of ConvF.
- DCP_{x,y,z}**: DCP are numerical linearization parameters assessed based on the data of power sweep with CW signal (no uncertainty required). DCP does not depend on frequency nor media.
- PAR**: PAR is the Peak to Average Ratio that is not calibrated but determined based on the signal characteristics
- A_{x,y,z}; B_{x,y,z}; C_{x,y,z}** are numerical linearization parameters in dB assessed based on the data of power sweep for specific modulation signal. The parameters do not depend on frequency nor media.
- VR**: VR is the validity range of the calibration related to the average diode voltage or DAE voltage in mV.
- ConvF and Boundary Effect Parameters**: Assessed in flat phantom using E-field (or Temperature Transfer Standard for $f \leq 800$ MHz) and inside waveguide using analytical field distributions based on power measurements for $f > 800$ MHz. The same setups are used for assessment of the parameters applied for boundary compensation (alpha, depth) of which typical uncertainty values are given. These parameters are used in DASY4 software to improve probe accuracy close to the boundary. The sensitivity in TSL corresponds to NORM_{x,y,z} * ConvF whereby the uncertainty corresponds to that given for ConvF. A frequency dependent ConvF is used in DASY version 4.4 and higher which allows extending the validity from ± 50 MHz to ± 100 MHz.
- Spherical isotropy (3D deviation from isotropy)**: in a field of low gradients realized using a flat phantom exposed by a patch antenna.
- Sensor Offset**: The sensor offset corresponds to the offset of virtual measurement center from the probe tip (on probe axis). No tolerance required.

Probe EX3DV4

SN:3550

Manufactured: May 19, 2004
Calibrated: February 14, 2011

Calibrated for DASY/EASY Systems
(Note: non-compatible with DASY2 system!)

DASY/EASY - Parameters of Probe: EX3DV4 - SN:3550

Basic Calibration Parameters

	Sensor X	Sensor Y	Sensor Z	Unc (k=2)
Norm ($\mu\text{V}/(\text{V}/\text{m})^2$) ^A	0.52	0.45	0.50	$\pm 10.1 \%$
DCP (mV) ^B	100.3	98.8	99.0	

Modulation Calibration Parameters

UID	Communication System Name	PAR		A dB	B dB	C dB	VR mV	Unc ^E (k=2)
10000	CW	0.00	X	0.00	0.00	1.00	110.7	$\pm 2.2 \%$
			Y	0.00	0.00	1.00	145.7	
			Z	0.00	0.00	1.00	148.8	

The reported uncertainty of measurement is stated as the standard uncertainty of measurement multiplied by the coverage factor $k=2$, which for a normal distribution corresponds to a coverage probability of approximately 95%.

^A The uncertainties of NormX,Y,Z do not affect the E^2 -field uncertainty inside TSL (see Pages 5 and 6).

^B Numerical linearization parameter: uncertainty not required.

^E Uncertainty is determined using the max. deviation from linear response applying rectangular distribution and is expressed for the square of the field value.

DASY/EASY - Parameters of Probe: EX3DV4 - SN:3550

Calibration Parameter Determined in Head Tissue Simulating Media

f (MHz) ^C	Relative Permittivity ^F	Conductivity (S/m) ^F	ConvF X	ConvF Y	ConvF Z	Alpha	Depth (mm)	Unct. (k=2)
750	41.9	0.89	8.42	8.42	8.42	0.48	0.69	± 12.0 %
835	41.5	0.90	8.04	8.04	8.04	0.33	0.84	± 12.0 %
1750	40.1	1.37	7.33	7.33	7.33	0.46	0.65	± 12.0 %
1900	40.0	1.40	7.01	7.01	7.01	0.42	0.72	± 12.0 %
2450	39.2	1.80	6.29	6.29	6.29	0.13	1.57	± 12.0 %
2600	39.0	1.96	6.13	6.13	6.13	0.20	1.32	± 12.0 %
4950	36.3	4.40	4.37	4.37	4.37	0.35	1.80	± 13.1 %
5200	36.0	4.66	4.06	4.06	4.06	0.35	1.80	± 13.1 %
5300	35.9	4.76	3.92	3.92	3.92	0.35	1.80	± 13.1 %
5500	35.6	4.96	3.77	3.77	3.77	0.35	1.80	± 13.1 %
5600	35.5	5.07	3.50	3.50	3.50	0.40	1.80	± 13.1 %
5800	35.3	5.27	3.64	3.64	3.64	0.40	1.80	± 13.1 %

^C Frequency validity of ± 100 MHz only applies for DASY v4.4 and higher (see Page 2), else it is restricted to ± 50 MHz. The uncertainty is the RSS of the ConvF uncertainty at calibration frequency and the uncertainty for the indicated frequency band.

^F At frequencies below 3 GHz, the validity of tissue parameters (ϵ and σ) can be relaxed to ± 10% if liquid compensation formula is applied to measured SAR values. At frequencies above 3 GHz, the validity of tissue parameters (ϵ and σ) is restricted to ± 5%. The uncertainty is the RSS of the ConvF uncertainty for indicated target tissue parameters.

DASY/EASY - Parameters of Probe: EX3DV4- SN:3550

Calibration Parameter Determined in Body Tissue Simulating Media

f (MHz) ^c	Relative Permittivity ^f	Conductivity (S/m) ^f	ConvF X	ConvF Y	ConvF Z	Alpha	Depth (mm)	Unct. (k=2)
750	55.5	0.96	8.18	8.18	8.18	0.23	1.09	± 12.0 %
835	55.2	0.97	8.11	8.11	8.11	0.25	1.05	± 12.0 %
1750	53.4	1.49	7.21	7.21	7.21	0.42	0.89	± 12.0 %
1900	53.3	1.52	6.77	6.77	6.77	0.35	0.84	± 12.0 %
2450	52.7	1.95	6.25	6.25	6.25	0.30	0.86	± 12.0 %
2600	52.5	2.16	5.98	5.98	5.98	0.21	1.03	± 12.0 %
3700	51.0	3.55	5.42	5.42	5.42	0.20	1.95	± 13.1 %
4950	49.4	5.01	3.72	3.72	3.72	0.45	1.90	± 13.1 %
5200	49.0	5.30	3.58	3.58	3.58	0.45	1.90	± 13.1 %
5300	48.9	5.42	3.31	3.31	3.31	0.48	1.90	± 13.1 %
5500	48.6	5.65	3.21	3.21	3.21	0.47	1.90	± 13.1 %
5600	48.5	5.77	3.19	3.19	3.19	0.45	1.90	± 13.1 %
5800	48.2	6.00	3.29	3.29	3.29	0.50	1.90	± 13.1 %

^c Frequency validity of ± 100 MHz only applies for DASY v4.4 and higher (see Page 2), else it is restricted to ± 50 MHz. The uncertainty is the RSS of the ConvF uncertainty at calibration frequency and the uncertainty for the indicated frequency band.

^f At frequencies below 3 GHz, the validity of tissue parameters (ϵ and σ) can be relaxed to ± 10% if liquid compensation formula is applied to measured SAR values. At frequencies above 3 GHz, the validity of tissue parameters (ϵ and σ) is restricted to ± 5%. The uncertainty is the RSS of the ConvF uncertainty for indicated target tissue parameters.

Frequency Response of E-Field

(TEM-Cell:ifi110 EXX, Waveguide: R22)

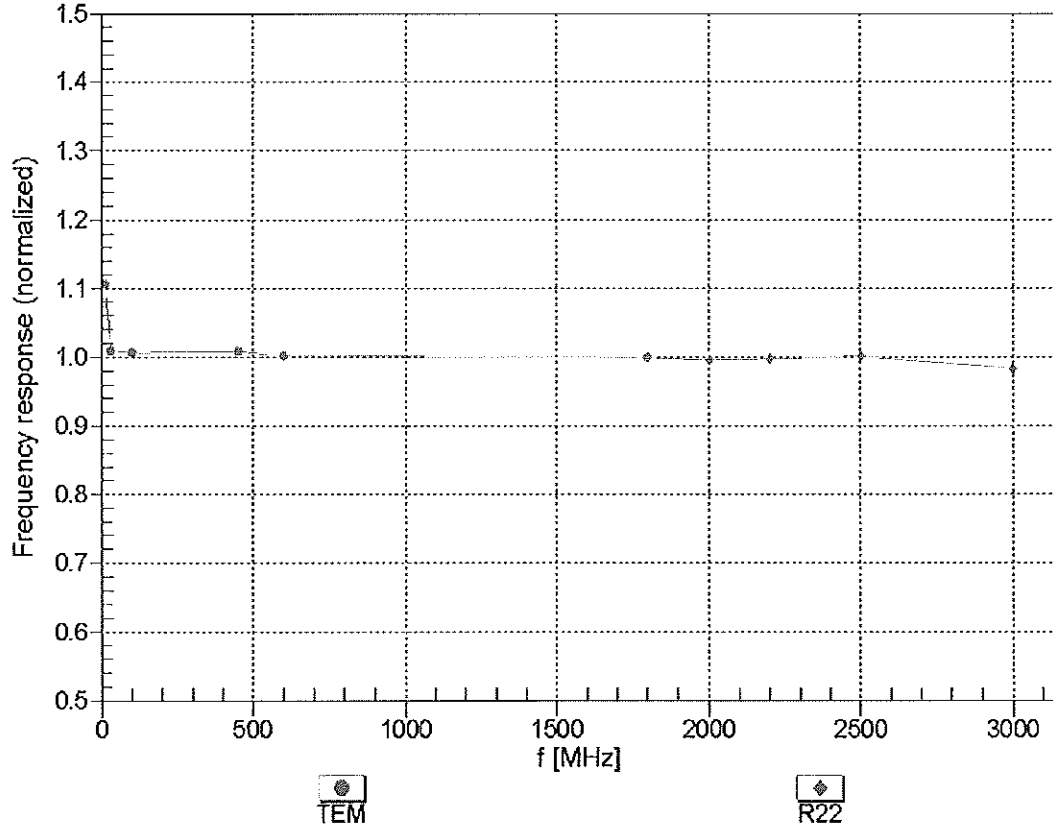

Uncertainty of Frequency Response of E-field: $\pm 6.3\%$ (k=2)

Receiving Pattern (ϕ), $\theta = 0^\circ$

f=600 MHz,TEM

f=1800 MHz,R22

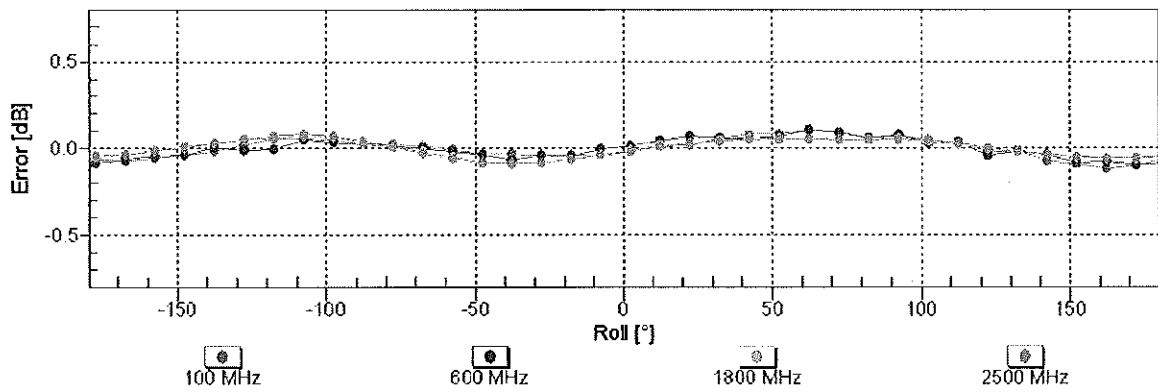
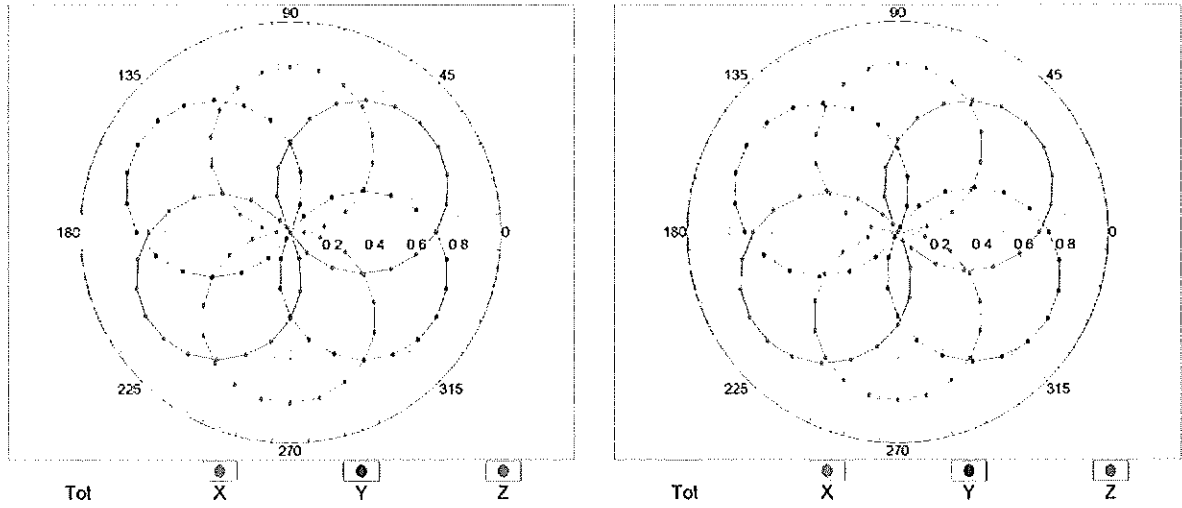

Uncertainty of Axial Isotropy Assessment: $\pm 0.5\%$ ($k=2$)

Dynamic Range $f(\text{SAR}_{\text{head}})$ (TEM cell, $f = 900 \text{ MHz}$)

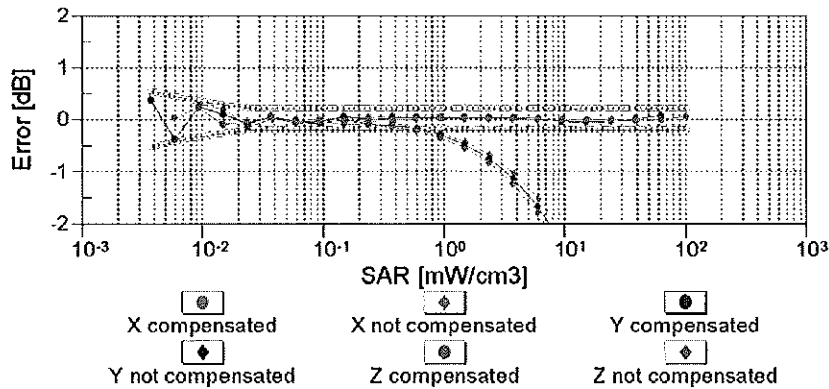
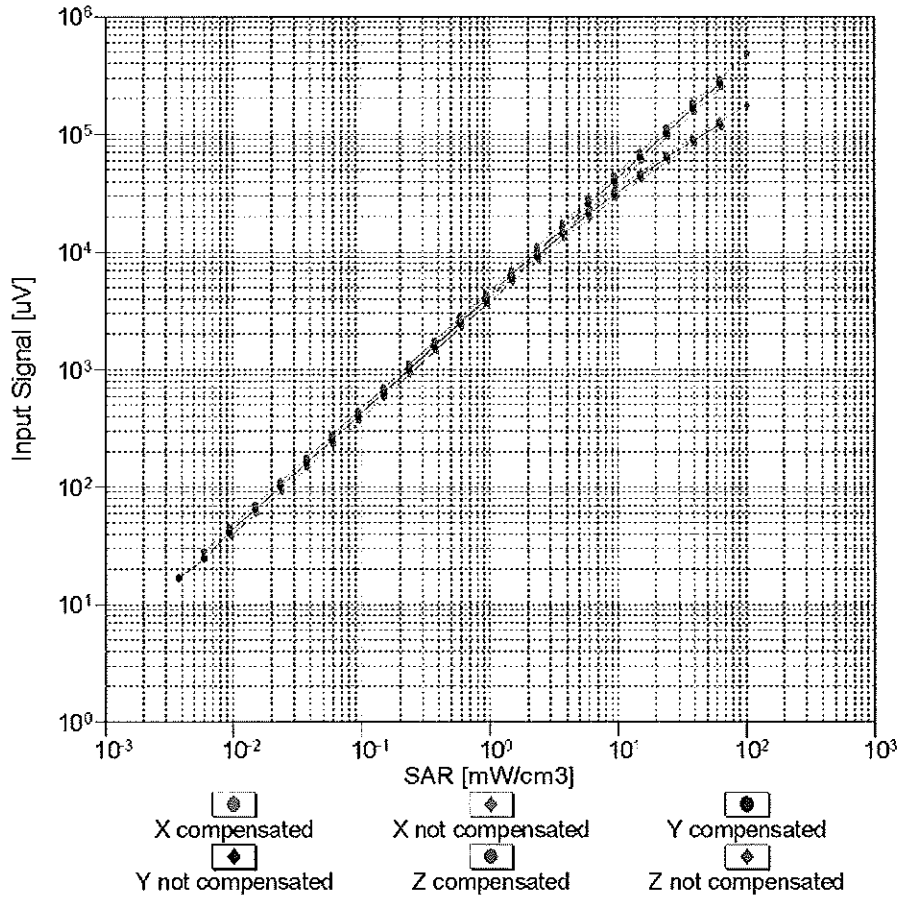

Uncertainty of Linearity Assessment: $\pm 0.6\%$ ($k=2$)

Conversion Factor Assessment

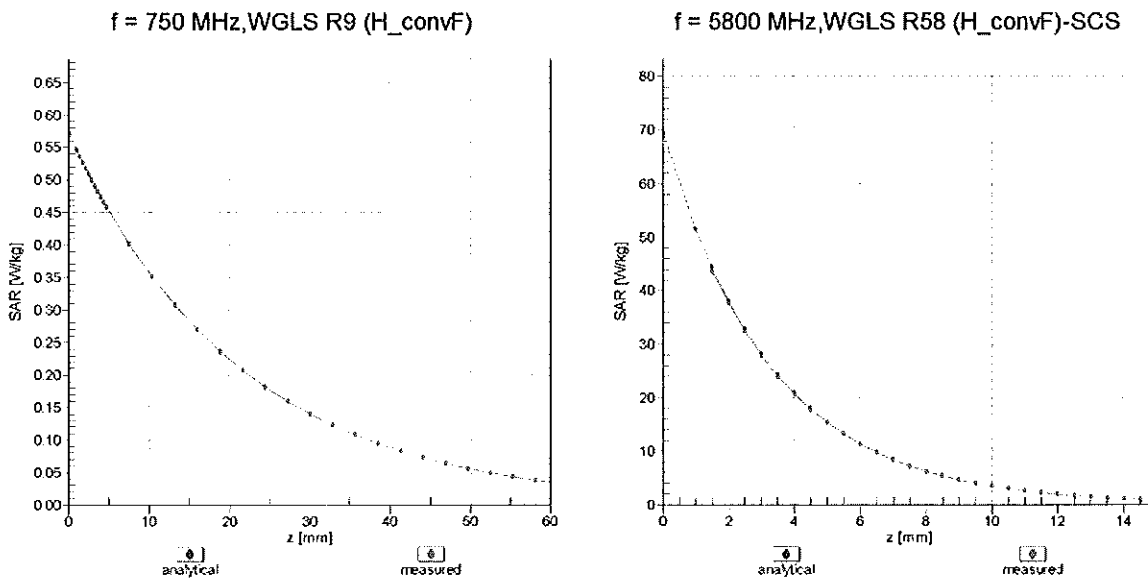

Deviation from Isotropy in Air Error (ϕ, ϑ), f = 900 MHz

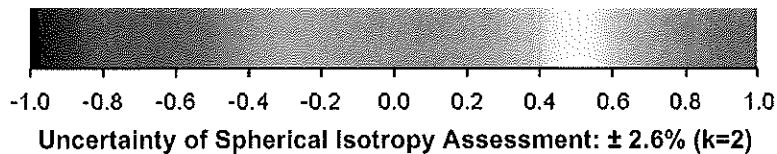
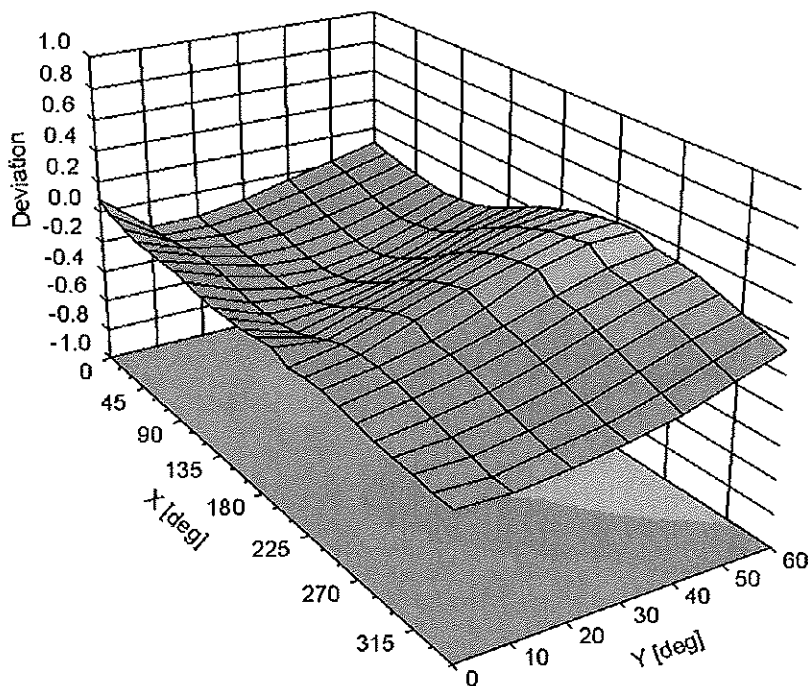

DASY/EASY - Parameters of Probe: EX3DV4 - SN:3550

Other Probe Parameters

Sensor Arrangement	Triangular
Connector Angle (°)	Not applicable
Mechanical Surface Detection Mode	enabled
Optical Surface Detection Mode	disabled
Probe Overall Length	337 mm
Probe Body Diameter	10 mm
Tip Length	9 mm
Tip Diameter	3 mm
Probe Tip to Sensor X Calibration Point	1 mm
Probe Tip to Sensor Y Calibration Point	1 mm
Probe Tip to Sensor Z Calibration Point	1 mm
Recommended Measurement Distance from Surface	2 mm



Accredited by the Swiss Accreditation Service (SAS)
The Swiss Accreditation Service is one of the signatories to the EA
Multilateral Agreement for the recognition of calibration certificates

Accreditation No.: **SCS 108**

Client **PC Test**

Certificate No: **D835V2-4d047_Feb11**

CALIBRATION CERTIFICATE

Object **D835V2 - SN: 4d047**

Calibration procedure(s) **QA CAL-05.v8
Calibration procedure for dipole validation kits**

Calibration date: **February 09, 2011**

✓
2/24/11
KOK

This calibration certificate documents the traceability to national standards, which realize the physical units of measurements (SI).
The measurements and the uncertainties with confidence probability are given on the following pages and are part of the certificate.

All calibrations have been conducted in the closed laboratory facility: environment temperature (22 ± 3)°C and humidity < 70%.

Calibration Equipment used (M&TE critical for calibration)

Primary Standards	ID #	Cal Date (Certificate No.)	Scheduled Calibration
Power meter EPM-442A	GB37480704	06-Oct-10 (No. 217-01266)	Oct-11
Power sensor HP 8481A	US37292783	06-Oct-10 (No. 217-01266)	Oct-11
Reference 20 dB Attenuator	SN: 5086 (20g)	30-Mar-10 (No. 217-01158)	Mar-11
Type-N mismatch combination	SN: 5047.2 / 06327	30-Mar-10 (No. 217-01162)	Mar-11
Reference Probe ES3DV3	SN: 3205	30-Apr-10 (No. ES3-3205_Apr10)	Apr-11
DAE4	SN: 601	10-Jun-10 (No. DAE4-601_Jun10)	Jun-11
Secondary Standards	ID #	Check Date (in house)	Scheduled Check
Power sensor HP 8481A	MY41092317	18-Oct-02 (in house check Oct-09)	In house check: Oct-11
RF generator R&S SMT-06	100005	4-Aug-99 (in house check Oct-09)	In house check: Oct-11
Network Analyzer HP 8753E	US37390585 S4206	18-Oct-01 (in house check Oct-10)	In house check: Oct-11

Calibrated by: **Dimce Iliev** Function: **Laboratory Technician** Signature: *D. Iliev*

Approved by: **Katja Pokovic** Technical Manager *Katja Pokovic*

Issued: February 9, 2011

This calibration certificate shall not be reproduced except in full without written approval of the laboratory.



Accredited by the Swiss Accreditation Service (SAS)
The Swiss Accreditation Service is one of the signatories to the EA
Multilateral Agreement for the recognition of calibration certificates

Accreditation No.: **SCS 108**

Glossary:

TSL	tissue simulating liquid
ConvF	sensitivity in TSL / NORM x,y,z
N/A	not applicable or not measured

Calibration is Performed According to the Following Standards:

- IEEE Std 1528-2003, "IEEE Recommended Practice for Determining the Peak Spatial-Averaged Specific Absorption Rate (SAR) in the Human Head from Wireless Communications Devices: Measurement Techniques", December 2003
- IEC 62209-1, "Procedure to measure the Specific Absorption Rate (SAR) for hand-held devices used in close proximity to the ear (frequency range of 300 MHz to 3 GHz)", February 2005
- Federal Communications Commission Office of Engineering & Technology (FCC OET), "Evaluating Compliance with FCC Guidelines for Human Exposure to Radiofrequency Electromagnetic Fields; Additional Information for Evaluating Compliance of Mobile and Portable Devices with FCC Limits for Human Exposure to Radiofrequency Emissions", Supplement C (Edition 01-01) to Bulletin 65

Additional Documentation:

- DASY4/5 System Handbook

Methods Applied and Interpretation of Parameters:

- Measurement Conditions:** Further details are available from the Validation Report at the end of the certificate. All figures stated in the certificate are valid at the frequency indicated.
- Antenna Parameters with TSL:** The dipole is mounted with the spacer to position its feed point exactly below the center marking of the flat phantom section, with the arms oriented parallel to the body axis.
- Feed Point Impedance and Return Loss:** These parameters are measured with the dipole positioned under the liquid filled phantom. The impedance stated is transformed from the measurement at the SMA connector to the feed point. The Return Loss ensures low reflected power. No uncertainty required.
- Electrical Delay:** One-way delay between the SMA connector and the antenna feed point. No uncertainty required.
- SAR measured:** SAR measured at the stated antenna input power.
- SAR normalized:** SAR as measured, normalized to an input power of 1 W at the antenna connector.
- SAR for nominal TSL parameters:** The measured TSL parameters are used to calculate the nominal SAR result.

Measurement Conditions

DASY system configuration, as far as not given on page 1.

DASY Version	DASY5	V52.6
Extrapolation	Advanced Extrapolation	
Phantom	Modular Flat Phantom V4.9	
Distance Dipole Center - TSL	15 mm	with Spacer
Zoom Scan Resolution	dx, dy, dz = 5 mm	
Frequency	835 MHz \pm 1 MHz	

Head TSL parameters

The following parameters and calculations were applied.

	Temperature	Permittivity	Conductivity
Nominal Head TSL parameters	22.0 °C	41.5	0.90 mho/m
Measured Head TSL parameters	(22.0 \pm 0.2) °C	41.1 \pm 6 %	0.89 mho/m \pm 6 %
Head TSL temperature during test	(21.8 \pm 0.2) °C	----	----

SAR result with Head TSL

SAR averaged over 1 cm³ (1 g) of Head TSL	Condition	
SAR measured	250 mW input power	2.37 mW / g
SAR normalized	normalized to 1W	9.48 mW / g
SAR for nominal Head TSL parameters	normalized to 1W	9.53 mW / g \pm 17.0 % (k=2)

SAR averaged over 10 cm³ (10 g) of Head TSL	condition	
SAR measured	250 mW input power	1.54 mW / g
SAR normalized	normalized to 1W	6.16 mW / g
SAR for nominal Head TSL parameters	normalized to 1W	6.19 mW / g \pm 16.5 % (k=2)

Body TSL parameters

The following parameters and calculations were applied.

	Temperature	Permittivity	Conductivity
Nominal Body TSL parameters	22.0 °C	55.2	0.97 mho/m
Measured Body TSL parameters	(22.0 ± 0.2) °C	54.2 ± 6 %	0.99 mho/m ± 6 %
Body TSL temperature during test	(22.0 ± 0.2) °C	----	----

SAR result with Body TSL

SAR averaged over 1 cm ³ (1 g) of Body TSL	Condition	
SAR measured	250 mW input power	2.51 mW / g
SAR normalized	normalized to 1W	10.0 mW / g
SAR for nominal Body TSL parameters	normalized to 1W	9.85 mW / g ± 17.0 % (k=2)

SAR averaged over 10 cm ³ (10 g) of Body TSL	condition	
SAR measured	250 mW input power	1.64 mW / g
SAR normalized	normalized to 1W	6.56 mW / g
SAR for nominal Body TSL parameters	normalized to 1W	6.47 mW / g ± 16.5 % (k=2)

Appendix

Antenna Parameters with Head TSL

Impedance, transformed to feed point	50.1 Ω - 6.2 j Ω
Return Loss	- 24.2 dB

Antenna Parameters with Body TSL

Impedance, transformed to feed point	45.9 Ω - 8.2 j Ω
Return Loss	- 20.4 dB

General Antenna Parameters and Design

Electrical Delay (one direction)	1.387 ns
----------------------------------	----------

After long term use with 100W radiated power, only a slight warming of the dipole near the feedpoint can be measured.

The dipole is made of standard semirigid coaxial cable. The center conductor of the feeding line is directly connected to the second arm of the dipole. The antenna is therefore short-circuited for DC-signals.

No excessive force must be applied to the dipole arms, because they might bend or the soldered connections near the feedpoint may be damaged.

Additional EUT Data

Manufactured by	SPEAG
Manufactured on	August 16, 2006

DASY5 Validation Report for Head TSL

Date/Time: 09.02.2011 10:54:37

Test Laboratory: SPEAG, Zurich, Switzerland

DUT: Dipole 835 MHz; Type: D835V2; Serial: D835V2 - SN:4d047

Communication System: CW; Frequency: 835 MHz; Duty Cycle: 1:1

Medium: HSL900

Medium parameters used: $f = 835 \text{ MHz}$; $\sigma = 0.89 \text{ mho/m}$; $\epsilon_r = 41$; $\rho = 1000 \text{ kg/m}^3$

Phantom section: Flat Section

Measurement Standard: DASY5 (IEEE/IEC/ANSI C63.19-2007)

DASY5 Configuration:

- Probe: ES3DV3 - SN3205; ConvF(6.03, 6.03, 6.03); Calibrated: 30.04.2010
- Sensor-Surface: 3mm (Mechanical Surface Detection)
- Electronics: DAE4 Sn601; Calibrated: 10.06.2010
- Phantom: Flat Phantom 4.9L; Type: QD000P49AA; Serial: 1001
- Measurement SW: DASY52, V52.6.1 Build (408)
- Postprocessing SW: SEMCAD X, V14.4.2 Build (2595)

Pin=250 mW /d=15mm, dist=3.0mm (ES-Probe)/Zoom Scan (7x7x7) /Cube 0: Measurement grid: dx=5mm, dy=5mm, dz=5mm

Reference Value = 57.212 V/m; Power Drift = 0.02 dB

Peak SAR (extrapolated) = 3.567 W/kg

SAR(1 g) = 2.37 mW/g; SAR(10 g) = 1.54 mW/g

Maximum value of SAR (measured) = 2.763 mW/g

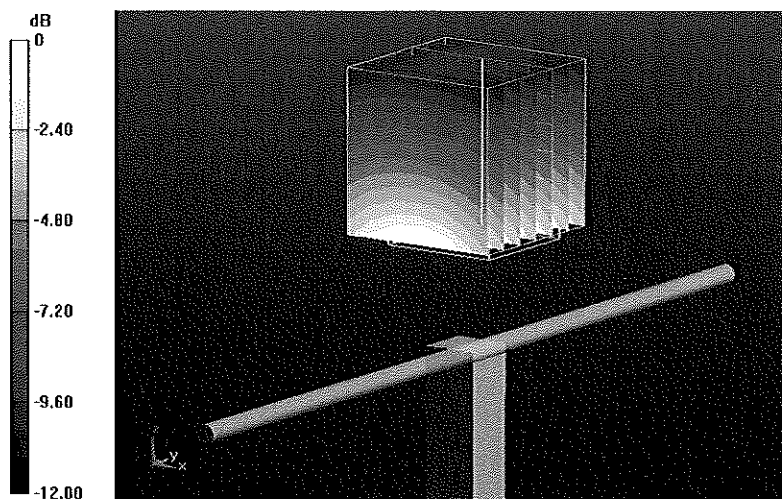

0 dB = 2.760mW/g

Impedance Measurement Plot for Head TSL

9 Feb 2011 10:16:52

[CH1] S11 1 U FS 1: 50.000 Ω -6.1836 Ω 30.824 pF 835.000 000 MHz

*
De1
Cor

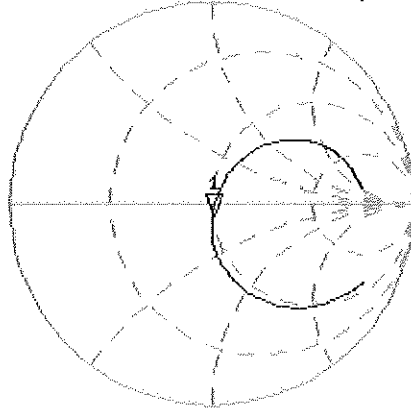

Avg
16

CH2 S11 LOG 5 dB/REF -20 dB 1: -24.208 dB 835.000 000 MHz

Cor

Avg
16

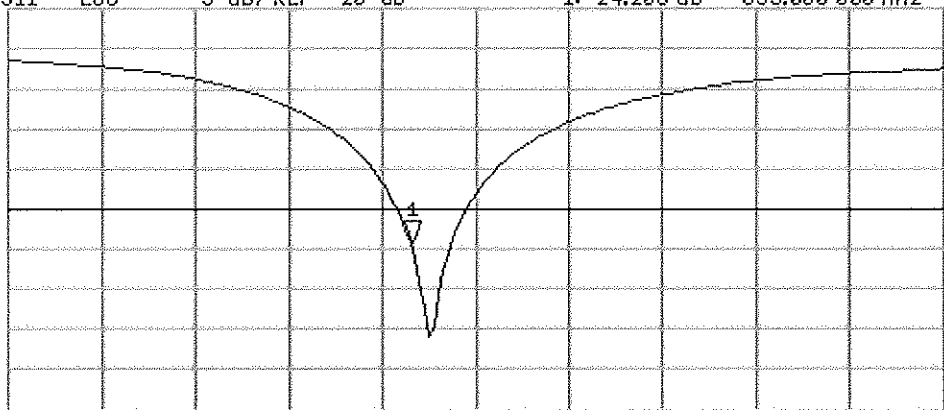

START 635.000 000 MHz

STOP 1 100.000 000 MHz

DASY5 Validation Report for Body TSL

Date/Time: 09.02.2011 13:56:30

Test Laboratory: SPEAG, Zurich, Switzerland

DUT: Dipole 835 MHz; Type: D835V2; Serial: D835V2 - SN:4d047

Communication System: CW; Frequency: 835 MHz; Duty Cycle: 1:1

Medium: MSL900

Medium parameters used: $f = 835$ MHz; $\sigma = 0.99$ mho/m; $\epsilon_r = 54.2$; $\rho = 1000$ kg/m³

Phantom section: Flat Section

Measurement Standard: DASY5 (IEEE/IEC/ANSI C63.19-2007)

DASY5 Configuration:

- Probe: ES3DV3 - SN3205; ConvF(5.86, 5.86, 5.86); Calibrated: 30.04.2010
- Sensor-Surface: 3mm (Mechanical Surface Detection)
- Electronics: DAE4 Sn601; Calibrated: 10.06.2010
- Phantom: Flat Phantom 4.9L; Type: QD000P49AA; Serial: 1001
- Measurement SW: DASY52, V52.6.1 Build (408)
- Postprocessing SW: SEMCAD X, V14.4.2 Build (2595)

Pin=250 mW /d=15mm, dist=3.0mm (ES-Probe)/Zoom Scan (7x7x7) /Cube 0: Measurement grid: dx=5mm, dy=5mm, dz=5mm

Reference Value = 56.092 V/m; Power Drift = 0.02 dB

Peak SAR (extrapolated) = 3.714 W/kg

SAR(1 g) = 2.51 mW/g; SAR(10 g) = 1.64 mW/g

Maximum value of SAR (measured) = 2.921 mW/g

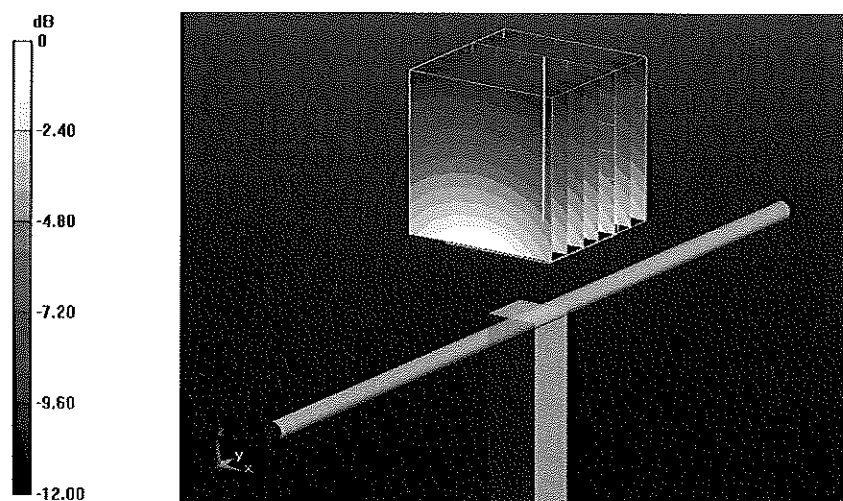

0 dB = 2.920mW/g

Impedance Measurement Plot for Body TSL

9 Feb 2011 14:20:21

CH1 S11 1 U FS 1: 45.922 Ω -8.2461 Ω 23.115 μF 835.000 000 MHz

*
Del
Cor

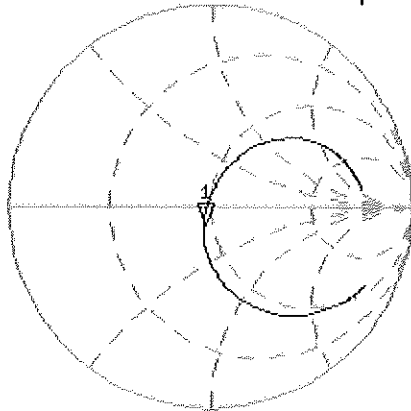

Avg
16

↑

CH2 S11 LOG 5 dB/REF -20 dB 1: -20.397 dB 835.000 000 MHz

Cor

Avg
16

↑

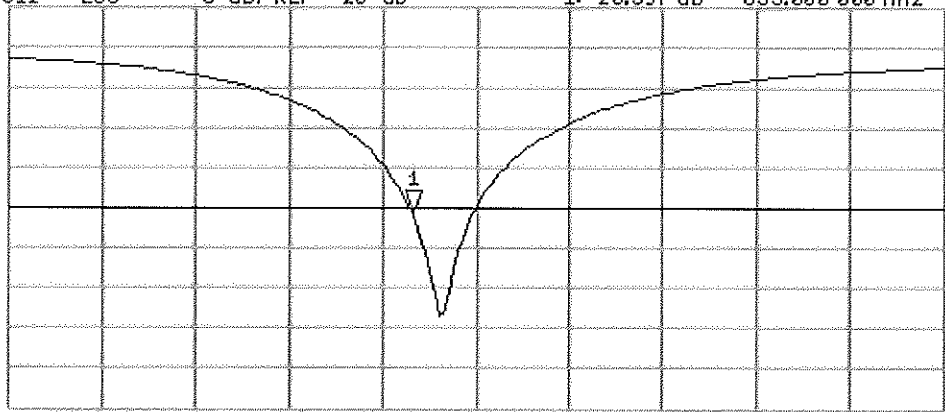

START 635.000 000 MHz

STOP 1 100.000 000 MHz



Accredited by the Swiss Accreditation Service (SAS)
The Swiss Accreditation Service is one of the signatories to the EA
Multilateral Agreement for the recognition of calibration certificates

Accreditation No.: **SCS 108**

Client **PC Test**

Certificate No: **D1900V2-502_Feb11**

CALIBRATION CERTIFICATE

Object **D1900V2 - SN: 502**

Calibration procedure(s) **QA CAL-05.v8
Calibration procedure for dipole validation kits**

Calibration date: **February 17, 2011**

✓
KOK
2/24/11

This calibration certificate documents the traceability to national standards, which realize the physical units of measurements (SI).
The measurements and the uncertainties with confidence probability are given on the following pages and are part of the certificate.

All calibrations have been conducted in the closed laboratory facility: environment temperature (22 ± 3)°C and humidity < 70%.

Calibration Equipment used (M&TE critical for calibration)

Primary Standards	ID #	Cal Date (Certificate No.)	Scheduled Calibration
Power meter EPM-442A	GB37480704	06-Oct-10 (No. 217-01266)	Oct-11
Power sensor HP 8481A	US37292783	06-Oct-10 (No. 217-01266)	Oct-11
Reference 20 dB Attenuator	SN: 5086 (20g)	30-Mar-10 (No. 217-01158)	Mar-11
Type-N mismatch combination	SN: 5047.2 / 06327	30-Mar-10 (No. 217-01162)	Mar-11
Reference Probe ES3DV3	SN: 3205	30-Apr-10 (No. ES3-3205_Apr10)	Apr-11
DAE4	SN: 601	10-Jun-10 (No. DAE4-601_Jun10)	Jun-11
Secondary Standards	ID #	Check Date (in house)	Scheduled Check
Power sensor HP 8481A	MY41092317	18-Oct-02 (in house check Oct-09)	In house check: Oct-11
RF generator R&S SMT-06	100005	4-Aug-99 (in house check Oct-09)	In house check: Oct-11
Network Analyzer HP 8753E	US37390585 S4206	18-Oct-01 (in house check Oct-10)	In house check: Oct-11

Calibrated by: **Dimce Iliev** Name: **Dimce Iliev** Function: **Laboratory Technician** Signature: *Dimce Iliev*

Approved by: **Katja Pokovic** Name: **Katja Pokovic** Function: **Technical Manager** Signature: *Katja Pokovic*

Issued: February 17, 2011

This calibration certificate shall not be reproduced except in full without written approval of the laboratory.



Accredited by the Swiss Accreditation Service (SAS)

The Swiss Accreditation Service is one of the signatories to the EA
Multilateral Agreement for the recognition of calibration certificates

Accreditation No.: **SCS 108**

Glossary:

TSL	tissue simulating liquid
ConvF	sensitivity in TSL / NORM x,y,z
N/A	not applicable or not measured

Calibration is Performed According to the Following Standards:

- IEEE Std 1528-2003, "IEEE Recommended Practice for Determining the Peak Spatial-Averaged Specific Absorption Rate (SAR) in the Human Head from Wireless Communications Devices: Measurement Techniques", December 2003
- IEC 62209-1, "Procedure to measure the Specific Absorption Rate (SAR) for hand-held devices used in close proximity to the ear (frequency range of 300 MHz to 3 GHz)", February 2005
- Federal Communications Commission Office of Engineering & Technology (FCC OET), "Evaluating Compliance with FCC Guidelines for Human Exposure to Radiofrequency Electromagnetic Fields; Additional Information for Evaluating Compliance of Mobile and Portable Devices with FCC Limits for Human Exposure to Radiofrequency Emissions", Supplement C (Edition 01-01) to Bulletin 65

Additional Documentation:

- DASY4/5 System Handbook

Methods Applied and Interpretation of Parameters:

- Measurement Conditions:** Further details are available from the Validation Report at the end of the certificate. All figures stated in the certificate are valid at the frequency indicated.
- Antenna Parameters with TSL:** The dipole is mounted with the spacer to position its feed point exactly below the center marking of the flat phantom section, with the arms oriented parallel to the body axis.
- Feed Point Impedance and Return Loss:** These parameters are measured with the dipole positioned under the liquid filled phantom. The impedance stated is transformed from the measurement at the SMA connector to the feed point. The Return Loss ensures low reflected power. No uncertainty required.
- Electrical Delay:** One-way delay between the SMA connector and the antenna feed point. No uncertainty required.
- SAR measured:** SAR measured at the stated antenna input power.
- SAR normalized:** SAR as measured, normalized to an input power of 1 W at the antenna connector.
- SAR for nominal TSL parameters:** The measured TSL parameters are used to calculate the nominal SAR result.

Measurement Conditions

DASY system configuration, as far as not given on page 1.

DASY Version	DASY5	V52.6
Extrapolation	Advanced Extrapolation	
Phantom	Modular Flat Phantom V5.0	
Distance Dipole Center - TSL	10 mm	with Spacer
Zoom Scan Resolution	dx, dy, dz = 5 mm	
Frequency	1900 MHz \pm 1 MHz	

Head TSL parameters

The following parameters and calculations were applied.

	Temperature	Permittivity	Conductivity
Nominal Head TSL parameters	22.0 °C	40.0	1.40 mho/m
Measured Head TSL parameters	(22.0 \pm 0.2) °C	39.8 \pm 6 %	1.41 mho/m \pm 6 %
Head TSL temperature during test	(21.5 \pm 0.2) °C	----	----

SAR result with Head TSL

SAR averaged over 1 cm ³ (1 g) of Head TSL	Condition	
SAR measured	250 mW input power	10.1 mW / g
SAR normalized	normalized to 1W	40.4 mW / g
SAR for nominal Head TSL parameters	normalized to 1W	40.2 mW / g \pm 17.0 % (k=2)

SAR averaged over 10 cm ³ (10 g) of Head TSL	condition	
SAR measured	250 mW input power	5.26 mW / g
SAR normalized	normalized to 1W	21.0 mW / g
SAR for nominal Head TSL parameters	normalized to 1W	21.0 mW / g \pm 16.5 % (k=2)

Body TSL parameters

The following parameters and calculations were applied.

	Temperature	Permittivity	Conductivity
Nominal Body TSL parameters	22.0 °C	53.3	1.52 mho/m
Measured Body TSL parameters	(22.0 ± 0.2) °C	52.8 ± 6 %	1.55 mho/m ± 6 %
Body TSL temperature during test	(21.5 ± 0.2) °C	----	----

SAR result with Body TSL

SAR averaged over 1 cm ³ (1 g) of Body TSL	Condition	
SAR measured	250 mW input power	10.4 mW / g
SAR normalized	normalized to 1W	41.6 mW / g
SAR for nominal Body TSL parameters	normalized to 1W	41.1 mW / g ± 17.0 % (k=2)

SAR averaged over 10 cm ³ (10 g) of Body TSL	condition	
SAR measured	250 mW input power	5.48 mW / g
SAR normalized	normalized to 1W	21.9 mW / g
SAR for nominal Body TSL parameters	normalized to 1W	21.8 mW / g ± 16.5 % (k=2)

Appendix

Antenna Parameters with Head TSL

Impedance, transformed to feed point	51.3 Ω + 6.4 j Ω
Return Loss	- 23.8 dB

Antenna Parameters with Body TSL

Impedance, transformed to feed point	47.3 Ω + 6.7 j Ω
Return Loss	- 22.5 dB

General Antenna Parameters and Design

Electrical Delay (one direction)	1.206 ns
----------------------------------	----------

After long term use with 100W radiated power, only a slight warming of the dipole near the feedpoint can be measured.

The dipole is made of standard semirigid coaxial cable. The center conductor of the feeding line is directly connected to the second arm of the dipole. The antenna is therefore short-circuited for DC-signals.

No excessive force must be applied to the dipole arms, because they might bend or the soldered connections near the feedpoint may be damaged.

Additional EUT Data

Manufactured by	SPEAG
Manufactured on	November 14, 1998

DASY5 Validation Report for Head TSL

Date/Time: 17.02.2011 10:13:23

Test Laboratory: SPEAG, Zurich, Switzerland

DUT: Dipole 1900 MHz; Type: D1900V2; Serial: D1900V2 - SN:502

Communication System: CW; Frequency: 1900 MHz; Duty Cycle: 1:1

Medium: HSL U12 BB

Medium parameters used: $f = 1900$ MHz; $\sigma = 1.41$ mho/m; $\epsilon_r = 39.9$; $\rho = 1000$ kg/m³

Phantom section: Flat Section

Measurement Standard: DASY5 (IEEE/IEC/ANSI C63.19-2007)

DASY5 Configuration:

- Probe: ES3DV3 - SN3205; ConvF(5.09, 5.09, 5.09); Calibrated: 30.04.2010
- Sensor-Surface: 3mm (Mechanical Surface Detection)
- Electronics: DAE4 Sn601; Calibrated: 10.06.2010
- Phantom: Flat Phantom 5.0 (front); Type: QD000P50AA; Serial: 1001
- Measurement SW: DASY52, V52.6.1 Build (408)
- Postprocessing SW: SEMCAD X, V14.4.2 Build (2595)

Pin=250 mW /d=10mm, dist=3.0mm (ES-Probe)/Zoom Scan (7x7x7) /Cube 0: Measurement grid: dx=5mm, dy=5mm, dz=5mm

Reference Value = 97.159 V/m; Power Drift = 0.05 dB

Peak SAR (extrapolated) = 18.519 W/kg

SAR(1 g) = 10.1 mW/g; SAR(10 g) = 5.26 mW/g

Maximum value of SAR (measured) = 12.407 mW/g

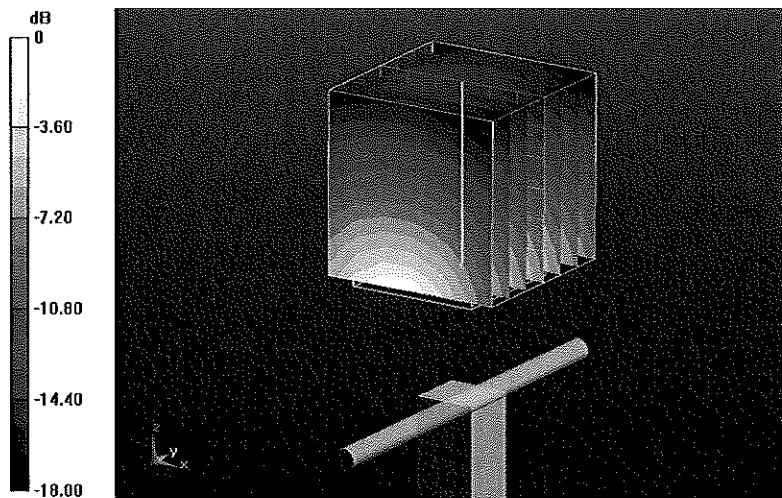

0 dB = 12.410mW/g

Impedance Measurement Plot for Head TSL

17 Feb 2011 10:39:46

CH1 S11 1 U FS 3: 51.264 Ω 6.4219 Ω 537.93 μH 1 900.000 000 MHz

*
Del
CA

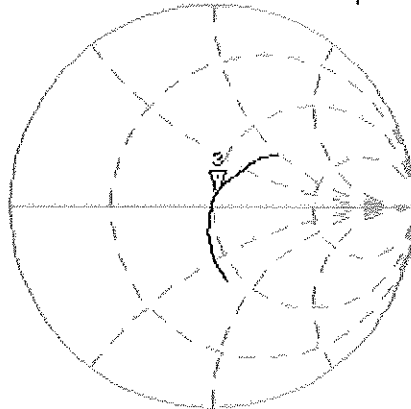

Avg
16

CH2 S11 LOG 5 dB/REF -20 dB 3:-23.804 dB 1 900.000 000 MHz

CA

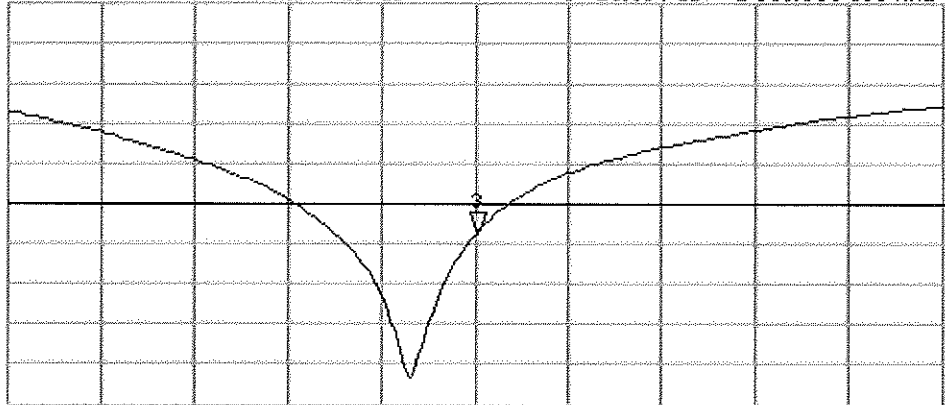

Avg
16

START 1 700.000 000 MHz

STOP 2 100.000 000 MHz

DASY5 Validation Report for Body TSL

Date/Time: 17.02.2011 10:55:26

Test Laboratory: SPEAG, Zurich, Switzerland

DUT: Dipole 1900 MHz; Type: D1900V2; Serial: D1900V2 - SN:502

Communication System: CW; Frequency: 1900 MHz; Duty Cycle: 1:1

Medium: MSL U12 BB

Medium parameters used: $f = 1900$ MHz; $\sigma = 1.55$ mho/m; $\epsilon_r = 52.9$; $\rho = 1000$ kg/m³

Phantom section: Flat Section

Measurement Standard: DASY5 (IEEE/IEC/ANSI C63.19-2007)

DASY5 Configuration:

- Probe: ES3DV3 - SN3205; ConvF(4.59, 4.59, 4.59); Calibrated: 30.04.2010
- Sensor-Surface: 3mm (Mechanical Surface Detection)
- Electronics: DAE4 Sn601; Calibrated: 10.06.2010
- Phantom: Flat Phantom 5.0 (back); Type: QD000P50AA; Serial: 1002
- Measurement SW: DASY52, V52.6.1 Build (408)
- Postprocessing SW: SEMCAD X, V14.4.2 Build (2595)

Pin=250 mW /d=10mm, dist=3.0mm (ES-Probe)/Zoom Scan (7x7x7) /Cube 0: Measurement grid: dx=5mm, dy=5mm, dz=5mm

Reference Value = 96.636 V/m; Power Drift = -0.02 dB

Peak SAR (extrapolated) = 17.829 W/kg

SAR(1 g) = 10.4 mW/g; SAR(10 g) = 5.48 mW/g

Maximum value of SAR (measured) = 13.070 mW/g

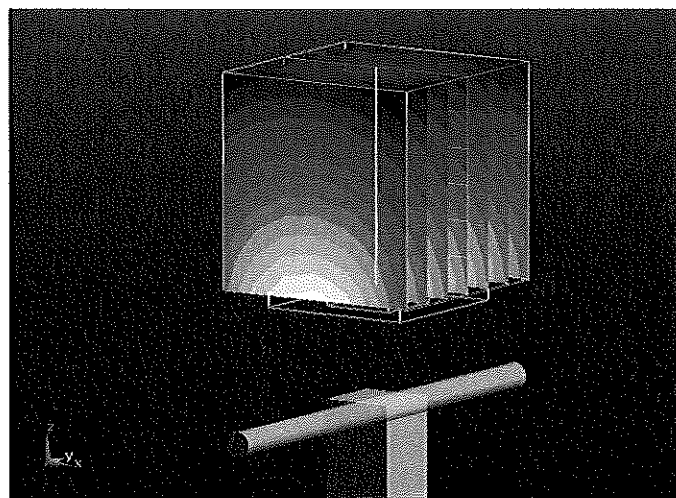

0 dB = 13.070mW/g

Impedance Measurement Plot for Body TSL

17 Feb 2011 10:40:17

CH1 S11 1 U FS 3: 47.260 Ω 6.7480 Ω 565.26 μ H 1 900.000 000 MHz

*
De1
CA

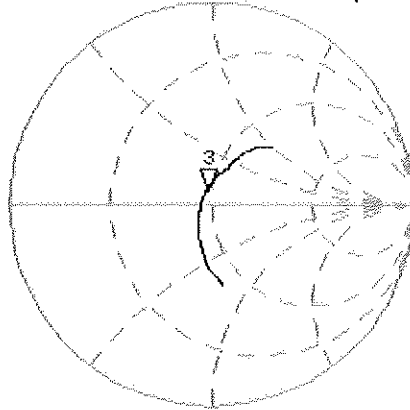

Avg
16
↑

CH2 S11 LOG 5 dB/REF -20 dB 3:-22.531 dB 1 900.000 000 MHz

CA

Avg
16
↑

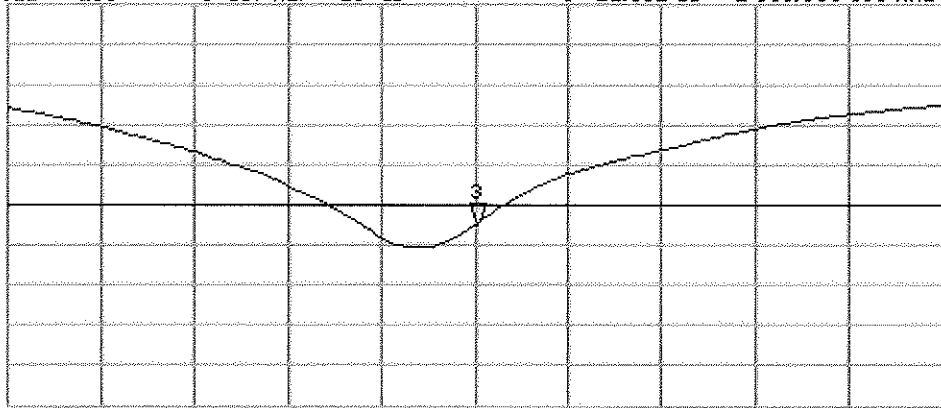

START 1 700.000 000 MHz

STOP 2 100.000 000 MHz



Accredited by the Swiss Accreditation Service (SAS)
The Swiss Accreditation Service is one of the signatories to the EA
Multilateral Agreement for the recognition of calibration certificates

Accreditation No.: **SCS 108**

Client **PC Test**

Certificate No: **D2450V2-797_Feb11**

CALIBRATION CERTIFICATE

Object **D2450V2 - SN: 797**

Calibration procedure(s) **QA CAL-05.v8
Calibration procedure for dipole validation kits**

Calibration date: **February 08, 2011**

*✓ KOK
2/24/11*

This calibration certificate documents the traceability to national standards, which realize the physical units of measurements (SI).
The measurements and the uncertainties with confidence probability are given on the following pages and are part of the certificate.

All calibrations have been conducted in the closed laboratory facility: environment temperature (22 ± 3)°C and humidity < 70%.

Calibration Equipment used (M&TE critical for calibration)

Primary Standards	ID #	Cal Date (Certificate No.)	Scheduled Calibration
Power meter EPM-442A	GB37480704	06-Oct-10 (No. 217-01266)	Oct-11
Power sensor HP 8481A	US37292783	06-Oct-10 (No. 217-01266)	Oct-11
Reference 20 dB Attenuator	SN: 5086 (20g)	30-Mar-10 (No. 217-01158)	Mar-11
Type-N mismatch combination	SN: 5047.2 / 06327	30-Mar-10 (No. 217-01162)	Mar-11
Reference Probe ES3DV3	SN: 3205	30-Apr-10 (No. ES3-3205_Apr10)	Apr-11
DAE4	SN: 601	10-Jun-10 (No. DAE4-601_Jun10)	Jun-11
Secondary Standards	ID #	Check Date (in house)	Scheduled Check
Power sensor HP 8481A	MY41092317	18-Oct-02 (in house check Oct-09)	In house check: Oct-11
RF generator R&S SMT-06	100005	4-Aug-99 (in house check Oct-09)	In house check: Oct-11
Network Analyzer HP 8753E	US37390585 S4206	18-Oct-01 (in house check Oct-10)	In house check: Oct-11

Calibrated by:	Name Dimce Iliev	Function Laboratory Technician	Signature <i>D. Iliev</i>
Approved by:	Katja Pokovic	Technical Manager	<i>Katja Pokovic</i>

Issued: February 8, 2011

This calibration certificate shall not be reproduced except in full without written approval of the laboratory.



Accredited by the Swiss Accreditation Service (SAS)
The Swiss Accreditation Service is one of the signatories to the EA
Multilateral Agreement for the recognition of calibration certificates

Accreditation No.: **SCS 108**

Glossary:

TSL	tissue simulating liquid
ConvF	sensitivity in TSL / NORM x,y,z
N/A	not applicable or not measured

Calibration is Performed According to the Following Standards:

- IEEE Std 1528-2003, "IEEE Recommended Practice for Determining the Peak Spatial-Averaged Specific Absorption Rate (SAR) in the Human Head from Wireless Communications Devices: Measurement Techniques", December 2003
- IEC 62209-1, "Procedure to measure the Specific Absorption Rate (SAR) for hand-held devices used in close proximity to the ear (frequency range of 300 MHz to 3 GHz)", February 2005
- Federal Communications Commission Office of Engineering & Technology (FCC OET), "Evaluating Compliance with FCC Guidelines for Human Exposure to Radiofrequency Electromagnetic Fields; Additional Information for Evaluating Compliance of Mobile and Portable Devices with FCC Limits for Human Exposure to Radiofrequency Emissions", Supplement C (Edition 01-01) to Bulletin 65

Additional Documentation:

- DASY4/5 System Handbook

Methods Applied and Interpretation of Parameters:

- Measurement Conditions:** Further details are available from the Validation Report at the end of the certificate. All figures stated in the certificate are valid at the frequency indicated.
- Antenna Parameters with TSL:** The dipole is mounted with the spacer to position its feed point exactly below the center marking of the flat phantom section, with the arms oriented parallel to the body axis.
- Feed Point Impedance and Return Loss:** These parameters are measured with the dipole positioned under the liquid filled phantom. The impedance stated is transformed from the measurement at the SMA connector to the feed point. The Return Loss ensures low reflected power. No uncertainty required.
- Electrical Delay:** One-way delay between the SMA connector and the antenna feed point. No uncertainty required.
- SAR measured:** SAR measured at the stated antenna input power.
- SAR normalized:** SAR as measured, normalized to an input power of 1 W at the antenna connector.
- SAR for nominal TSL parameters:** The measured TSL parameters are used to calculate the nominal SAR result.

Measurement Conditions

DASY system configuration, as far as not given on page 1.

DASY Version	DASY5	V52.6
Extrapolation	Advanced Extrapolation	
Phantom	Modular Flat Phantom V5.0	
Distance Dipole Center - TSL	10 mm	with Spacer
Zoom Scan Resolution	dx, dy, dz = 5 mm	
Frequency	2450 MHz \pm 1 MHz	

Head TSL parameters

The following parameters and calculations were applied.

	Temperature	Permittivity	Conductivity
Nominal Head TSL parameters	22.0 °C	39.2	1.80 mho/m
Measured Head TSL parameters	(22.0 \pm 0.2) °C	39.1 \pm 6 %	1.73 mho/m \pm 6 %
Head TSL temperature during test	(21.0 \pm 0.2) °C	----	----

SAR result with Head TSL

SAR averaged over 1 cm ³ (1 g) of Head TSL	Condition	
SAR measured	250 mW input power	13.1 mW / g
SAR normalized	normalized to 1W	52.4 mW / g
SAR for nominal Head TSL parameters	normalized to 1W	53.3 mW / g \pm 17.0 % (k=2)

SAR averaged over 10 cm ³ (10 g) of Head TSL	condition	
SAR measured	250 mW input power	6.14 mW / g
SAR normalized	normalized to 1W	24.6 mW / g
SAR for nominal Head TSL parameters	normalized to 1W	24.7 mW / g \pm 16.5 % (k=2)

Body TSL parameters

The following parameters and calculations were applied.

	Temperature	Permittivity	Conductivity
Nominal Body TSL parameters	22.0 °C	52.7	1.95 mho/m
Measured Body TSL parameters	(22.0 ± 0.2) °C	52.2 ± 6 %	1.94 mho/m ± 6 %
Body TSL temperature during test	(21.0 ± 0.2) °C	----	----

SAR result with Body TSL

SAR averaged over 1 cm ³ (1 g) of Body TSL	Condition	
SAR measured	250 mW input power	13.1 mW / g
SAR normalized	normalized to 1W	52.4 mW / g
SAR for nominal Body TSL parameters	normalized to 1W	52.3 mW / g ± 17.0 % (k=2)

SAR averaged over 10 cm ³ (10 g) of Body TSL	condition	
SAR measured	250 mW input power	6.05 mW / g
SAR normalized	normalized to 1W	24.2 mW / g
SAR for nominal Body TSL parameters	normalized to 1W	24.2 mW / g ± 16.5 % (k=2)

Appendix

Antenna Parameters with Head TSL

Impedance, transformed to feed point	$53.9 \Omega + 3.9 j\Omega$
Return Loss	- 25.5 dB

Antenna Parameters with Body TSL

Impedance, transformed to feed point	$49.0 \Omega + 5.2 j\Omega$
Return Loss	- 25.5 dB

General Antenna Parameters and Design

Electrical Delay (one direction)	1.151 ns
----------------------------------	----------

After long term use with 100W radiated power, only a slight warming of the dipole near the feedpoint can be measured.

The dipole is made of standard semirigid coaxial cable. The center conductor of the feeding line is directly connected to the second arm of the dipole. The antenna is therefore short-circuited for DC-signals.

No excessive force must be applied to the dipole arms, because they might bend or the soldered connections near the feedpoint may be damaged.

Additional EUT Data

Manufactured by	SPEAG
Manufactured on	January 24, 2006

DASY5 Validation Report for Head TSL

Date/Time: 07.02.2011 13:51:58

Test Laboratory: SPEAG, Zurich, Switzerland

DUT: Dipole 2450 MHz; Type: D2450V2; Serial: D2450V2 - SN:797

Communication System: CW; Frequency: 2450 MHz; Duty Cycle: 1:1

Medium: HSL U12 BB

Medium parameters used: $f = 2450$ MHz; $\sigma = 1.74$ mho/m; $\epsilon_r = 39.3$; $\rho = 1000$ kg/m³

Phantom section: Flat Section

Measurement Standard: DASY5 (IEEE/IEC/ANSI C63.19-2007)

DASY5 Configuration:

- Probe: ES3DV3 - SN3205; ConvF(4.53, 4.53, 4.53); Calibrated: 30.04.2010
- Sensor-Surface: 3mm (Mechanical Surface Detection)
- Electronics: DAE4 Sn601; Calibrated: 10.06.2010
- Phantom: Flat Phantom 5.0 (front); Type: QD000P50AA; Serial: 1001
- Measurement SW: DASY52, V52.6.1 Build (408)
- Postprocessing SW: SEMCAD X, V14.4.2 Build (2595)

Pin=250 mW /d=10mm, dist=3.0mm (ES-Probe)/Zoom Scan (7x7x7) /Cube 0: Measurement grid: dx=5mm, dy=5mm, dz=5mm

Reference Value = 101.6 V/m; Power Drift = 0.02 dB

Peak SAR (extrapolated) = 26.650 W/kg

SAR(1 g) = 13.1 mW/g; SAR(10 g) = 6.14 mW/g

Maximum value of SAR (measured) = 16.664 mW/g

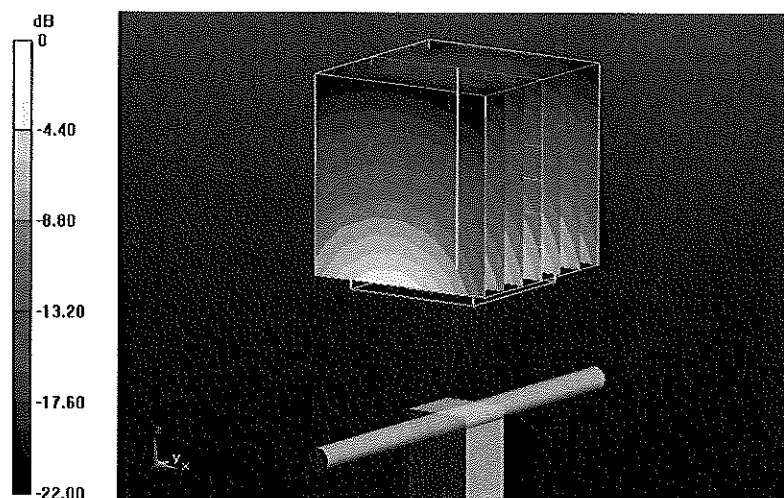

0 dB = 16.660mW/g

Impedance Measurement Plot for Head TSL

7 Feb 2011 10:40:17

[CH1] S11 1 U FS 4: 53.889 Ω 3.8828 Ω 252.23 μH 2 450.000 000 MHz

*
De1
Ca

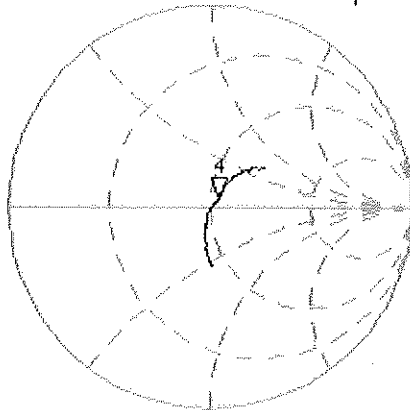

Avg
16

CH2 S11 LOG 5 dB/REF -20 dB 4:-25.540 dB 2 450.000 000 MHz

Ca

Avg
16

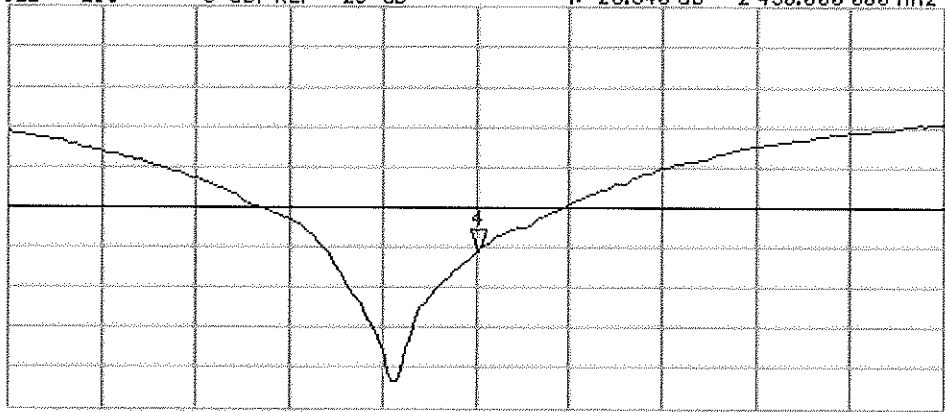

START 2 250.000 000 MHz

STOP 2 650.000 000 MHz

DASY5 Validation Report for Body TSL

Date/Time: 08.02.2011 13:24:09

Test Laboratory: SPEAG, Zurich, Switzerland

DUT: Dipole 2450 MHz; Type: D2450V2; Serial: D2450V2 - SN:797

Communication System: CW; Frequency: 2450 MHz; Duty Cycle: 1:1

Medium: MSL U12 BB

Medium parameters used: $f = 2450$ MHz; $\sigma = 1.95$ mho/m; $\epsilon_r = 52.4$; $\rho = 1000$ kg/m³

Phantom section: Flat Section

Measurement Standard: DASY5 (IEEE/IEC/ANSI C63.19-2007)

DASY5 Configuration:

- Probe: ES3DV3 - SN3205; ConvF(4.31, 4.31, 4.31); Calibrated: 30.04.2010
- Sensor-Surface: 3mm (Mechanical Surface Detection)
- Electronics: DAE4 Sn601; Calibrated: 10.06.2010
- Phantom: Flat Phantom 5.0 (back); Type: QD000P50AA; Serial: 1002
- Measurement SW: DASY52, V52.6.1 Build (408)
- Postprocessing SW: SEMCAD X, V14.4.2 Build (2595)

Pin=250 mW /d=10mm, dist=3.0mm (ES-Probe)/Zoom Scan (7x7x7) /Cube 0: Measurement grid: dx=5mm, dy=5mm, dz=5mm

Reference Value = 96.699 V/m; Power Drift = -0.08 dB

Peak SAR (extrapolated) = 27.483 W/kg

SAR(1 g) = 13.1 mW/g; SAR(10 g) = 6.05 mW/g

Maximum value of SAR (measured) = 17.122 mW/g

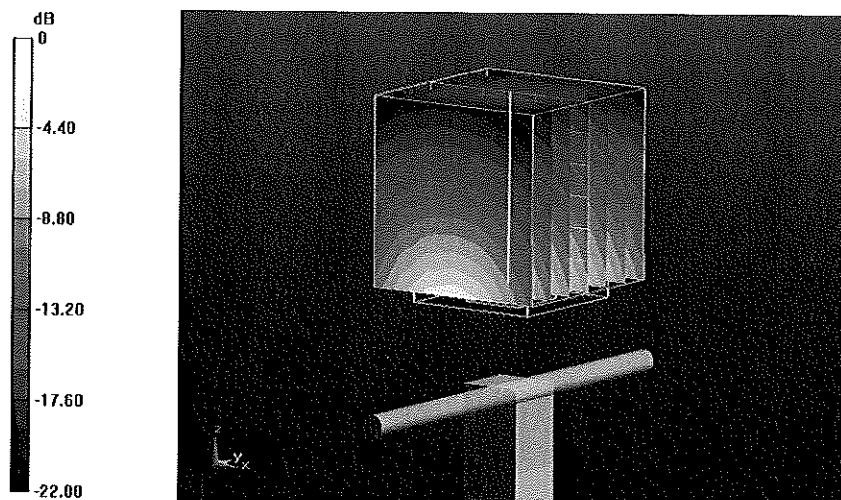

0 dB = 17.120mW/g

Impedance Measurement Plot for Body TSL

8 Feb 2011 10:58:23

CH1 S11 1 U FS 5: 49.029 Ω 5.1934 Ω 337.37 μH 2 450.000 000 MHz

*
De1

CA

Avg
16

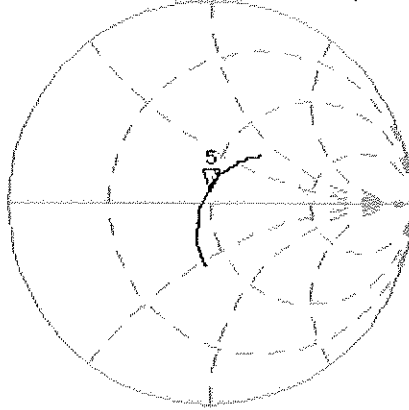

CH2 S11 LOG 5 dB/REF -20 dB 5: -25.470 dB 2 450.000 000 MHz

CA

Avg
16

