

FCC DFS REPORT

FCC Certification

Applicant Name:
LG Electronics MobileComm U.S.A., Inc.

Date of Issue:
April 25, 2016

Address:
1000 Sylvan Avenue, Englewood Cliffs NJ 07632

Test Site/Location:
HCT CO., LTD., 74,Seoicheon-ro 578beon-gil,Majang-myeo,Icheon-si, Gyeonggi-do, 17383, Rep. of KOREA
Report No.: HCT-R-1604-F064
HCT FRN: 0005866421

IC Recognition No.: 5944A-5

FCC ID : ZFNFSO
APPLICANT : LG Electronics MobileComm U.S.A., Inc.

Model(s): KT1601
EUT Type: Tablet with WLAN and Bluetooth

Max. RF Output Power:

Band	Mode	Frequency Range (MHz)	Power (dBm)	Power (W)
UNII2A	802.11a	5260 – 5320	13.44	0.0221
	802.11n_HT20	5260 – 5320	10.02	0.0100
	802.11n_HT40	5270 – 5310	9.42	0.0087
	802.11ac_VHT20	5260 – 5320	9.79	0.0095
	802.11ac_VHT40	5270 – 5310	9.74	0.0094
	802.11ac_VHT80	5290	8.87	0.0077
UNII2C	802.11a	5500 – 5700	13.56	0.0227
	802.11n_HT20	5500 – 5700	9.89	0.0097
	802.11n_HT40	5510 – 5670	9.44	0.0088
	802.11ac_VHT20	5500 – 5700	9.78	0.0095
	802.11ac_VHT40	5510 – 5670	9.64	0.0092
	802.11ac_VHT80	5530	8.91	0.0078

Modulation type OFDM
FCC Classification: Unlicensed National Information Infrastructure (UNII)
FCC Rule Part(s): Part 15.407(DFS)

Engineering Statement:

The measurements shown in this report were made in accordance with the procedures indicated, and the emissions from this equipment were found to be within the limits applicable. I assume full responsibility for the accuracy and completeness of these measurements, and for the qualifications of all persons taking them.

HCT CO., LTD. Certifies that no party to this application has subject to a denial of Federal benefits that includes FCC benefits pursuant to section 5301 of the Anti-Drug Abuse Act of 1998,21 U.S. C.853(a)



Report prepared by
: Seoul Ki Lee
Test Engineer of RF Team

Approved by
: Jong Seok Lee
Manager of RF Team

This report only responds to the tested sample and may not be reproduced, except in full, without written approval of the HCT Co., Ltd.

Version

TEST REPORT NO.	DATE	DESCRIPTION
HCT-R-1604-F064	April 25, 2016	- First Approval Report

Table of Contents

1. GENERAL INFORMATION	4
2. EUT DESCRIPTION	4
3. SCOPE	5
4. INSTRUMENT CALIBRATION.....	5
5. FACILITIES AND ACCREDITATIONS	5
5.1 FACILITIES	5
5.2 EQUIPMENT	5
6. SUMMARY OF TEST RESULTS	6
7. DESCRIPTION OF DYNAMIC FREQUENCY SELECTION TEST.....	7
7.1 APPLICABILITY	7
7.2 REQUIREMENTS.....	8
7.3 DFS DETECTION THRESHOLD VALUES	10
7.4 PARAMETERS OF DFS TEST SIGNALS.....	11
7.5 TEST AND MEASUREMENT SYSTEM	13
7.6 DESCRIPTION OF EUT.....	15
7.7 UNII2A TEST RESULT	16
7.8 UNII2C TEST RESULT	19
8. LIST OF TEST EQUIPMENT	22

1. GENERAL INFORMATION

Applicant: LG Electronics MobileComm U.S.A., Inc
Address: 1000 Sylvan Avenue, Englewood Cliffs NJ 07632
FCC ID: ZNFNSO
EUT Type: Tablet with WLAN and Bluetooth
Model (s): KT1601
Date(s) of Tests: April 18, 2016 ~ April 21, 2016
Place of Tests: HCT Co., Ltd.
 74, Seoicheon-ro 578beon-gil, Majang-myeon, Icheon-si, Gyeonggi-do, Korea

2. EUT DESCRIPTION

Model	KT1601	
EUT Type	Tablet with WLAN and Bluetooth	
Power Supply	DC 3.85 V	
Battery Information	Model: BL-T20J_KD Type: Li-ion Polymer	
Frequency Range	TX_20 MHz BW:	5260 MHz - 5320 MHz (UNII 2A) / 5500 MHz - 5700 MHz (UNII 2C)
	40 MHz BW:	5270 MHz - 5310 MHz (UNII 2A) / 5510 MHz - 5670 MHz (UNII 2C)
	80 MHz BW:	5290 MHz (UNII 2A) / 5530 MHz (UNII 2C)
	RX_20 MHz BW:	5260 MHz - 5320 MHz (UNII 2A) / 5500 MHz - 5700 MHz (UNII 2C)
	40 MHz BW:	5270 MHz - 5310 MHz (UNII 2A) / 5510 MHz - 5670 MHz (UNII 2C)
	80 MHz BW:	5290 MHz (UNII 2A) / 5530 MHz (UNII 2C)
Modulation Type	OFDM(802.11a, 802.11n, 802.11ac)	
Antenna Specification	Manufacturer: Ace technology. Antenna type: INTERNAL ANTENNA Peak Gain : -0.68 dBi (5260~5320 UNII2A BAND) / 0.69 dBi (5500~5700 UNII2C BAND)	

3. SCOPE

This report has been prepared to demonstrate compliance with the requirements for Dynamic Frequency Selection(DFS) as stated in KDB 905462 D02 v02. Testing was performed in accordance with the measurement procedure described in FCC KDB 905462 D02 v02.

4. INSTRUMENT CALIBRATION

The measuring equipment, which was utilized in performing the tests documented herein, has been calibrated in accordance with the manufacturer's recommendations for utilizing calibration equipments, which is traceable to recognized national standards.

Especially, all antenna for measurement is calibrated in accordance with the requirements of C63.5 (Version : 2006).

5. FACILITIES AND ACCREDITATIONS

5.1 FACILITIES

The SAC(Semi-Anechoic Chamber) and conducted measurement facility used to collect the radiated data are located at the 74, Seoicheon-ro 578beon-gil, Majang-myeon, Icheon-si, Gyeonggi-do, Korea The site is constructed in conformance with the requirements of ANSI C63.4. (Version :2014) and CISPR Publication 22. Detailed description of test facility was submitted to the Commission and accepted dated July 07, 2015 (Registration Number: 90661)

5.2 EQUIPMENT

Radiated emissions are measured with one or more of the following types of Linearly polarized antennas: tuned dipole, bi-conical, log periodic, bi-log, and/or ridged waveguide, horn. Spectrum analyzers with pre-selectors and quasi-peak detectors are used to perform radiated measurements. Conducted emissions are measured with Line Impedance Stabilization Networks and EMI Test Receivers. Calibrated wideband preamplifiers, coaxial cables, and coaxial attenuators are also used for making measurements.

All receiving equipment conforms to CISPR Publication 16-1, "Radio Interference Measuring Apparatus and Measurement Methods."

6. SUMMARY OF TEST RESULTS

Band	Parameter	Limit	Result
UNII2A	Channel Move Time	10 seconds	PASS
	Channel Closing Transmission Time	200 ms + aggregate of 60 ms over remaining 10 second period	PASS
	Non-occupancy Period	30 minutes	PASS
UNII2C	Channel Move Time	10 seconds	PASS
	Channel Closing Transmission Time	200 ms + aggregate of 60 ms over remaining 10 second period	PASS
	Non-occupancy Period	30 minutes	PASS

7. DESCRIPTION OF DYNAMIC FREQUENCY SELECTION TEST

7.1 APPLICABILITY

The following table from KDB905462 D02 v02(04/08/2016) lists the applicable requirements for the DFS testing. The device evaluated in this report is considered a client device without radar detection capability.

Requirement	Operation Mode		
	Master	Client Without Radar Detection	Client With Radar Detection
Non-Occupancy Period	Yes	Not required	Yes
DFS Detection Threshold	Yes	Not required	Yes
Channel Availability Check Time	Yes	Not required	Not required
Uniform Spreading	Yes	Not required	Not required
U-NII Detection Bandwidth	Yes	Not required	Yes

Table 1-1. DFS Applicability

Requirement	Operation Mode		
	Master	Client Without Radar Detection	Client With Radar Detection
DFS Detection Threshold	Yes	Not required	Yes
Channel Closing Transmission Time	Yes	Yes	Yes
Channel Move Time	Yes	Yes	Yes
U-NII Detection Bandwidth	Yes	Not required	Yes

Table 1-2. DFS Applicability During Normal Operation

7.2 REQUIREMENTS

Per KDB905462 D02 v02(04/08/2016) the following are the requirements for Client Devices:

- a) A Client Device will not transmit before having received appropriate control signals from a Master Device.
- b) A Client Device will stop all its transmissions whenever instructed by a Master Device to which it is associated and will meet the Channel Move Time and Channel Closing Transmission Time requirements.
The Client Device will not resume any transmissions until it has again received control signals from a Master Device.
- c) If a Client Device is performing In-Service Monitoring and detects a Radar Waveform above the DFS Detection Threshold, it will inform the Master Device. This is equivalent to the Master Device detecting the Radar Waveform and d) through f) of section 5.1.1 apply.
- d) Irrespective of Client Device or Master Device detection the Channel Move Time and Channel Closing Transmission Time requirements remain the same.

Channel Move Time and Channel Closing Transmission Time requirements are listed following table.

Parameter	Value
Non-occupancy period	Minimum 30 minutes
Channel Availability Check Time	60 seconds
Channel Move Time	10 seconds See Note 1.
Channel Closing Transmission Time	200 milliseconds + an Aggregate of 60 milliseconds over Remaining 10 second period. See Notes 1 and 2.
U-NII Detection Bandwidth	Minimum 100 % of the U-NII 99 % transmission Power bandwidth. See Note 3.
<p>Note 1: Channel Move Time and the Channel Closing Transmission Time should be performed with Radar Type 0. The measurement timing begins at the end of the Radar Type 0 burst.</p> <p>Note 2: The Channel Closing Transmission Time is comprised of 200 milliseconds starting at the beginning of The Channel Move Time plus any additional intermittent control signals required to facilitate a Channell move (an aggregate of 60 milliseconds) during the remainder of the 10 second period. The aggregate duration of control signals will not count quiet periods in between transmissions.</p> <p>Note3: During the U-NII Detection Bandwidth detection test, radar type 0 should be used.</p> <p>For each frequency step the minimum percentage of detection is 90 percent. Measurements are performed With no data traffic.</p>	

Table 1-3: DFS Response requirements

7.3 DFS DETECTION THRESHOLD VALUES

The DFS detection thresholds are defined for Master devices and Client Devices with In-service monitoring. These detection thresholds are listed in the following table.

Maximum Transmit Power	Value (See Notes 1 and 2)
≥ 200 milliwatt	-64 dBm
< 200 milliwatt	-62 dBm
<p>Note 1: This is the level at the input of the receiver assuming a 0 dBi receive antenna.</p> <p>Note 2: Throughout these test procedures an additional 1 dB has been added to the amplitude of the test transmission waveforms to account for variations in measurement equipment. This will ensure that the test signal is at or above the detection threshold level to trigger a DFS response.</p>	

Table 1-4: Detection Thresholds for Master Devices and Client Devices with Radar Detection

7.4 PARAMETERS OF DFS TEST SIGNALS

As the EUT is a Client Device with no Radar Detection only one type radar pulse is required for the testing. Radar Pulse type 0 was used in the evaluation of the Client device for the purpose of measuring the Channel Move Time and the Channel Closing Transmission Time. Table 1-5 lists the parameters for the Short Pulse Radar Waveforms. A plot of the Radar pulse Type 0 used for testing is included in Section 7.7 of this report.

Radar Type	Pulse Width (μsec)	PRI (μsec)	Number Of Pulses	Minimum Percentage of Successful Detection	Minimum Number of Trials
0	1	1428	18	See Note 1	See Note 1
1	1	Test A: 15 unique PRI values Randomly selected From the list of 23 PRI values in Table 5a	Roundup $\left\{ \begin{array}{l} \frac{1}{360} \\ \frac{19 \cdot 10^6}{\text{PRI}_{\mu\text{sec}}} \end{array} \right\}$	60%	30
		Test B: 15 unique PRI values Randomly selected within the range of 518-3066 μ sec, with a minimum increment of 1 μ sec, excluding PRI values selected in Test A			
2	1-5	150-230	23-29	60%	30
3	6-10	200-500	16-18	60%	30
4	11-20	200-500	12-16	60%	30
				80%	120
Note1: Short pulse Radar Type 0 should be used for the detection bandwidth test, channel move time, and channel closing time tests.					

Table 1-5: Parameters for Short Pulse Radar Waveforms

7.5 TEST AND MEASUREMENT SYSTEM

General Test Setup Procedure:

1. The EUT was operating 802.11ac_VHT80 mode (MCS0) during the test.
2. Connect FCC approved Master AP to a network, via wired Ethernet, that allows connection to an FTP server.
3. Associate the EUT with the Master AP.
4. Launch the FTP application on the EUT.
5. Connect to the FTP server application to the FTP server hosting the file
6. Initiate an FTP download of the file from the host.
7. Monitor the channel loading during transfer.
8. Reduce the maximum allowed data rate for the Master AP, using the AP's GUI interface.
9. Repeat steps 5-7 until the channel loading is as close to 20 % as possible.
10. Record the data rate setting on the Master AP and the channel loading.
11. While the system is performing an FTP transfer using the settings from item 9 above, perform the Channel Closing Transmission Time and Channel Move Time Measurements as required by KDB905462 D02 v02 using a conducted test.

PROCEDURE

The KDB905462 D02 v02 describes a radiated test setup and a conducted test setup. A radiated test setup was used for this testing. Figure 3-1 shows the typical test setup. Each one channel selected between 5260 and 5320 MHz, 5500 and 5700 is chosen for the testing.

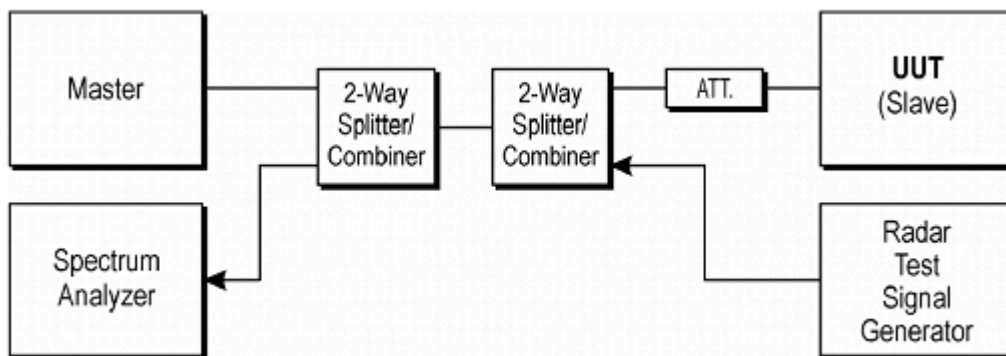

Figure 3-1. Conducted Test Setup for DFS

1. The radar pulse generator is setup to provide a pulse at the frequency that the Master and Client are operating. A Type 0 radar pulse with a 1 μ s pulse width and a 1428 μ s PRI is used for the testing.
2. The vector signal generator is adjusted to provide the radar burst (18 pulses) at a level of approximately -62 dBm at the antenna of the Master device.
3. The Client Device (EUT) is set up per the diagram in Figure 3-1 and communications between the Master device and the Client is established.
4. The MPEG file specified by the FCC ("*6½ Magic Hours*") is streamed from the "file computer" through the Master to the Slave Device and played in full motion video using Media Player Classic Ver.6.4.8.6 in order to properly load the network.
5. The spectrum analyzer is set to record about 15 sec window to any transmissions occurring up to and after 10 sec.
6. The system is again setup and the monitoring time is shortened in order to capture the Channel Closing Transmission Time. This time is measured to insure that the Client ceases transmission within 200 ms and the aggregate of emissions occurring after 200 ms up to 10 sec do not exceed 60 ms.

(Note: the channel may be different since the Master and Client have changed channels due to the detection of the initial radar pulse.)

7. After the initial radar burst the channel is monitored for 30 minutes to insure no transmissions or beacons occur. A second monitoring setup is used to verify that the Master and Client have both moved to different channels.

SYSTEM CALIBRATION

A-50-ohm load is connected in place of the spectrum analyzer, and the spectrum analyzer is connected to a coaxial cable. The signal generator is set to CW mode. The amplitude of the signal generator is adjusted to yield a level of - 62 dBm as measured on the spectrum analyzer.

Without changing any of the instrument settings, the spectrum analyzer is reconnected to the common port of the spectrum analyzer combiner or divider.

The spectrum analyzer displays the level of the signal generator higher than the client TX level. Because we can not search the signal generator in the spectrum analyzer when the signal generator level is - 62 dBm. The spectrum analyzer will still indicate the level higher than the client TX level.

7.6 DESCRIPTION OF EUT

The EUT operates over the 5260 MHz - 5320 MHz and 5500 MHz - 5700 MHz ranges.

The EUT is a slave device without radar detection.

The EUT antenna has a gain of -0.68 dBi in 5260 MHz - 5320 MHz band and 0.69 dBi in 5500 MHz- 5700 MHz band.

The highest power level within these bands is 12.76 dBm EIRP in the 5260 MHz - 5320 MHz band and 14.25 dBm EIRP in the 5500 MHz – 5700 MHz band.

The EUT one transmitter/receiver chain connected to a coaxial cable to perform conducted tests.

TPC is not required since the maximum EIRP is less than 500 mW.

The EUT utilizes the 802.11a/n/ac architecture.

The nominal channel bandwidth is implemented: 20 MHz, 40 MHz, 80 MHz

7.7 UNII2A TEST RESULT

▣ RESULT PLOTS(UNII2A Band)

Type0 Radar Pulse Number

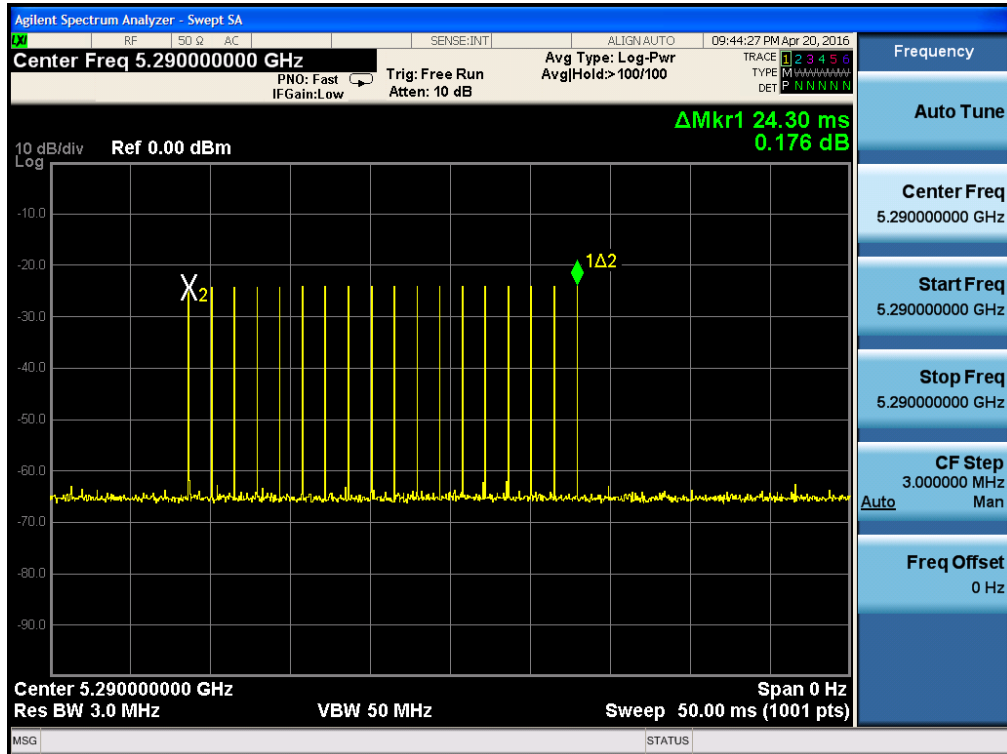

Marker Descriptions:

Number of Pulse Form M1R to M1 : 18

Type0 PRI

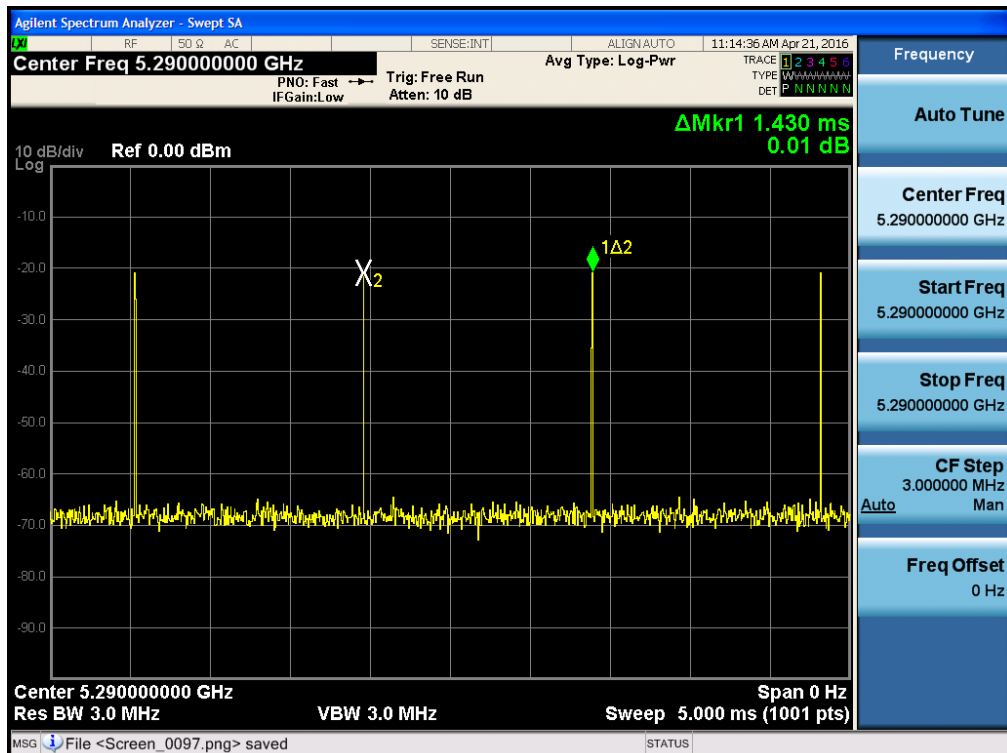

Time Display, Non WLAN Channel Traffic

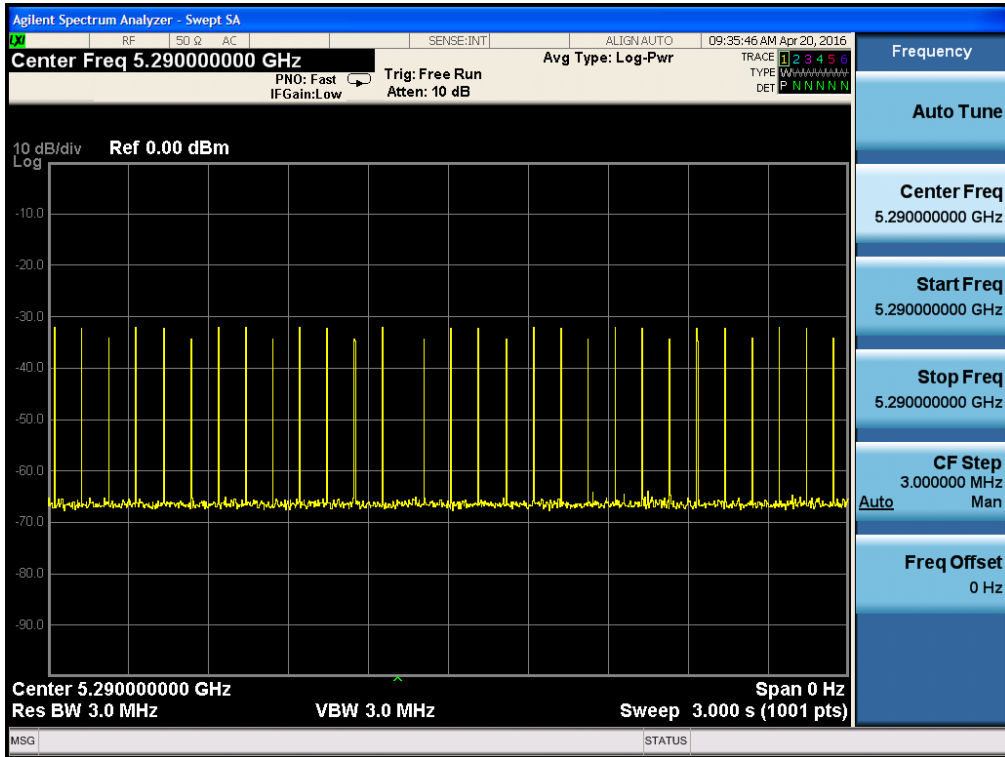

Time Display, WLAN Channel Traffic (Streaming Video)

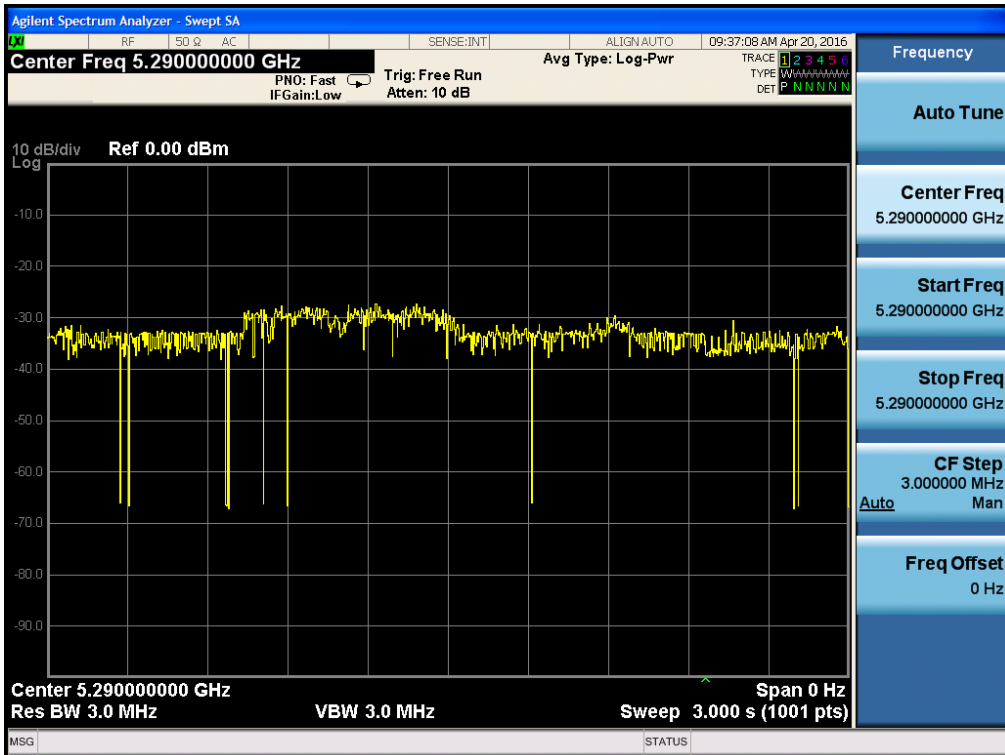



- Channel Move Time : 0.144431 s (Limit : 10 s)
- Channel Closing Transmission Time, Aggregate Time After 200 ms : 0.000503s (Limit : 60 ms)

Non-occupancy Period – Monitoring live time spectrum analyzer – Elapse time 30 minutes

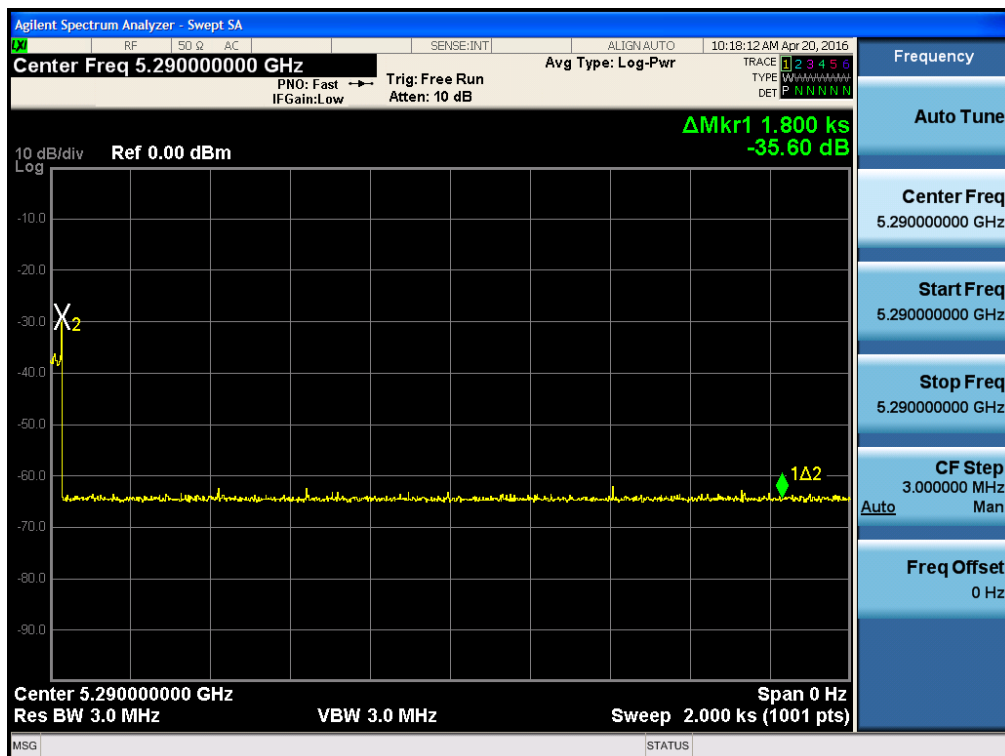

7.8 UNII2C TEST RESULT

▣ RESULT PLOTS_(UNII2C Band)

Type0 Radar Pulse Number

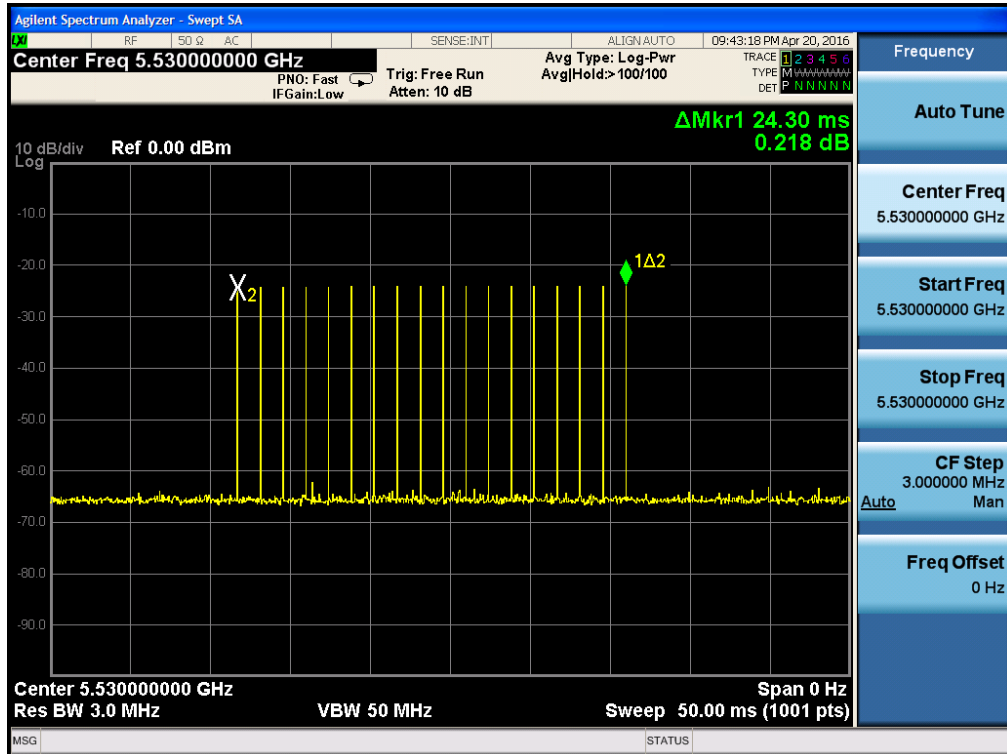

Marker Descriptions:

Number of Pulse Form M1R to M1 : 18

Type0 PRI

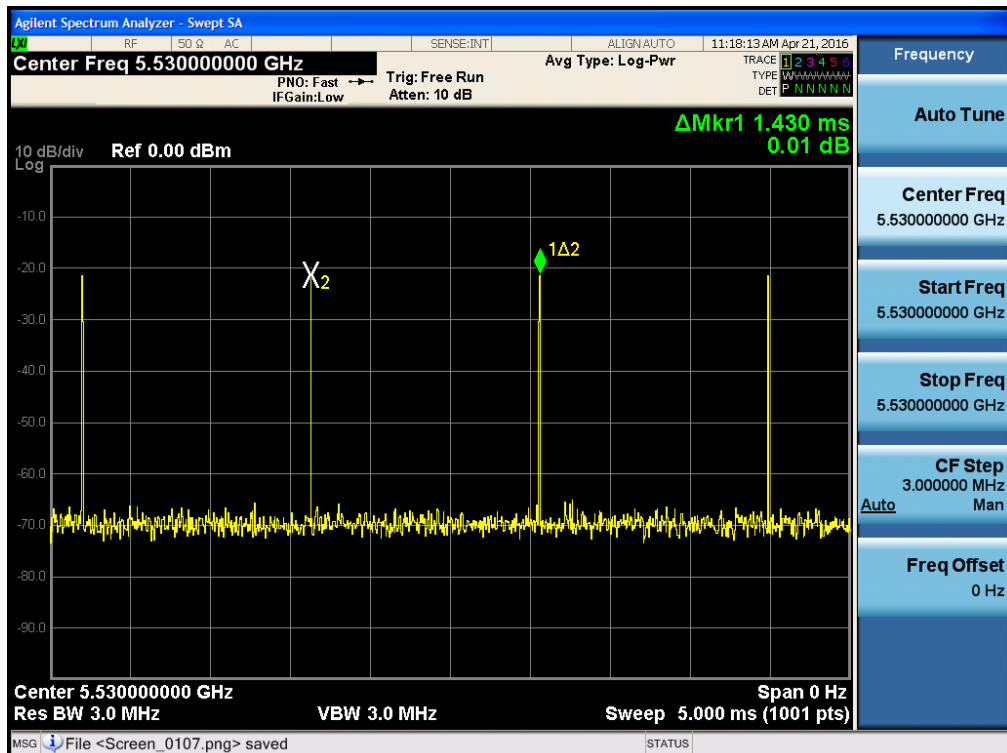

Time Display, Non WLAN Channel Traffic

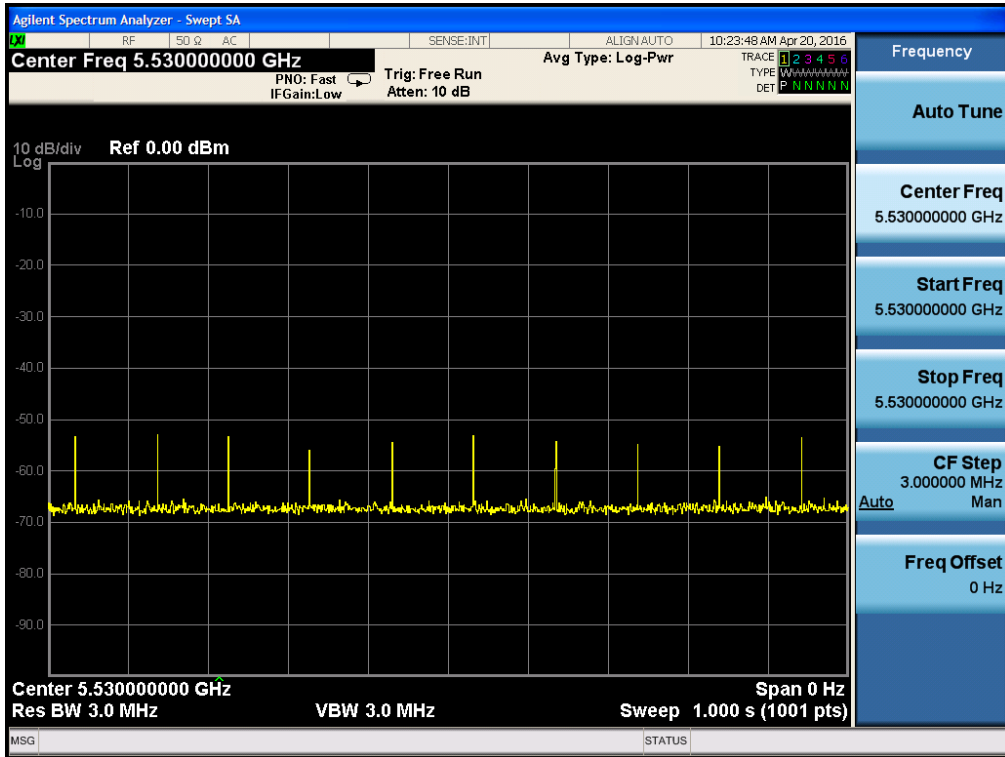

Time Display, WLAN Channel Traffic (Streaming Video)

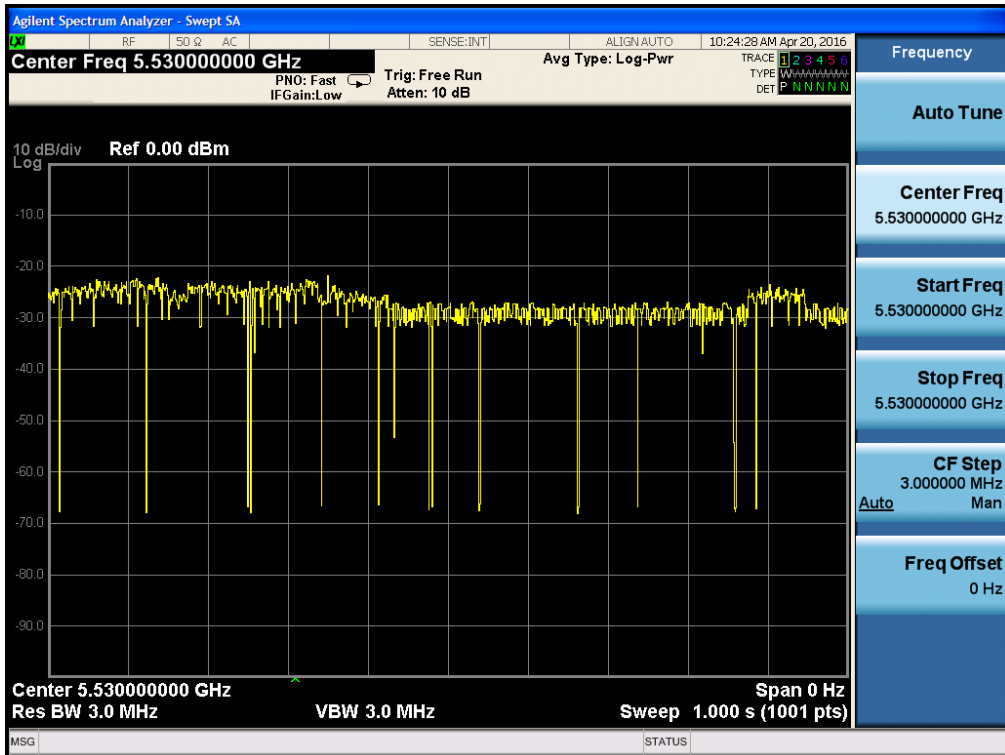



- Channel Move Time : 0.025706 s (Limit : 10 s)
- Channel Closing Transmission Time, Aggregate Time After 200 ms : 0.000002 s (Limit : 60 ms)

Non-occupancy Period – Monitoring live spectrum analyzer – Elapse time 30 minutes

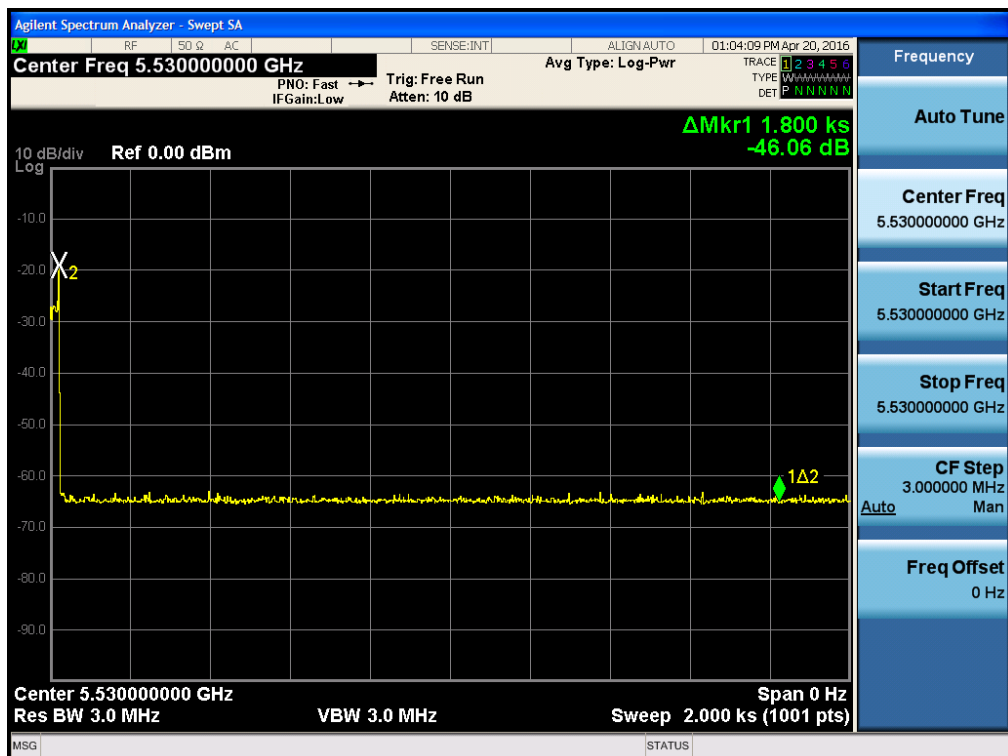

8. LIST OF TEST EQUIPMENT

Manufacturer	Model / Equipment	Calibration Date	Calibration Interval	Serial No.
SAMSUNG ELECTRONICS	WEA453e / Wireless AP (Master Device)	N/A	N/A	S2LF812265 FCC ID: A3LWEA453E
ADLINK	PXI/DFS Measurement System(S/G)	03/28/2016	Annual	302581/735
ADLINK	PXI/DFS Measurement System(S/A)	03/28/2016	Annual	303582/113
Agilent	N9020A / SIGNAL ANALYZER	06/30/2015	Annual	MY51110085
Agilent	N9030A / SIGNAL ANALYZER	11/24/2015	Annual	MY49431210
Agilent	N1911A/Power Meter	07/09/2015	Annual	MY45100523
Agilent	N1921A /Power Sensor	03/11/2016	Annual	MY52260025
Hewlett Packard	11636B/Power Divider	01/26/2016	Annual	0531
Agilent	87300B/Directional Coupler	11/30/2015	Annual	3116A03621
Hewlett Packard	11667B / Power Splitter	06/15/2015	Annual	5001
Hewlett Packard	E3632A / DC POWER SUPPLY	03/09/2016	Annual	KR75303962
Agilent	8493C / Attenuator(10 dB)	07/23/2015	Annual	07560
WEINSCHHEL	2-3 / Attenuator(3 dB)	10/26/2015	Annual	BR0617
Weinschel	AF9003-69-31 / Step Attenuator	10/14/2015	Annual	5701
Narda	922695 / 4 Way Divider	09/22/2015	Annual	15298