



17. TEST PHOTOGRAPHS

See following Attached Pages for setup photographs.

FCC ID: ZNFMS695	 PCTEST ENGINEERING LABORATORY, INC.	HAC (RF EMISSIONS) TEST REPORT	 LG	Reviewed by: Quality Manager
HAC Filename: 0Y1112192176.ZNF	Test Dates: 12/27/2011	EUT Type: Portable Handset	Page 78 of 80	

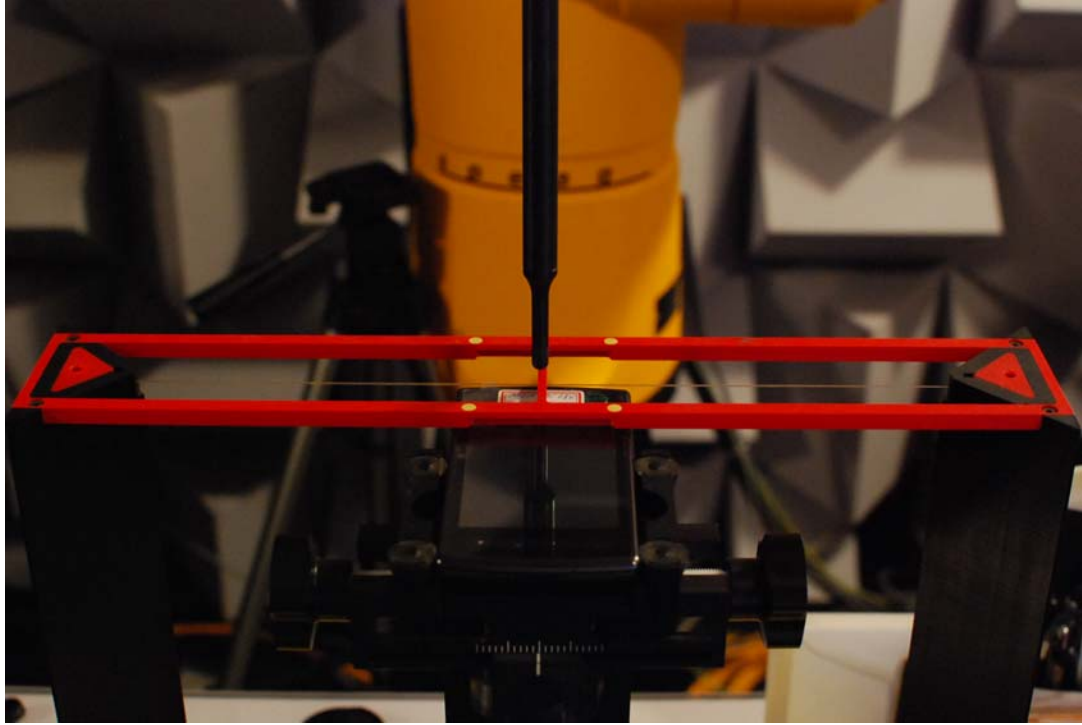

Figure 17-1
Ear Reference Point HAC Phantom Alignment

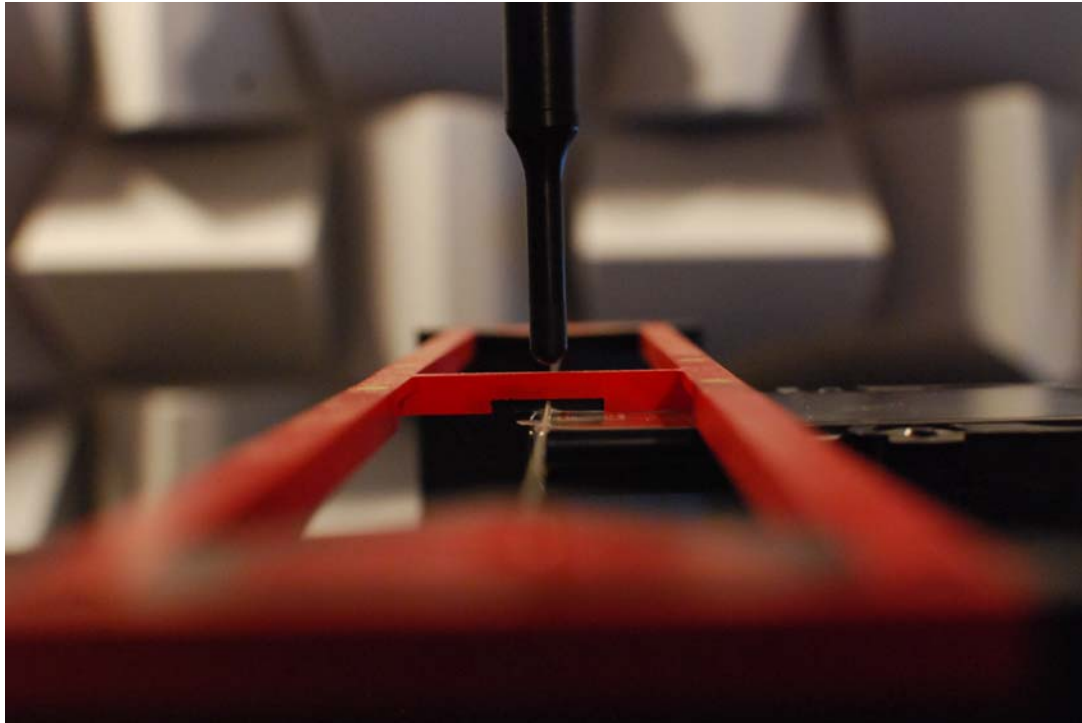



Figure 17-2
HAC Phantom Plane Alignment

FCC ID: ZNFMS695		HAC (RF EMISSIONS) TEST REPORT	 Reviewed by: Quality Manager
HAC Filename: 0Y1112192176.ZNF	Test Dates: 12/27/2011	EUT Type: Portable Handset	Page 79 of 80

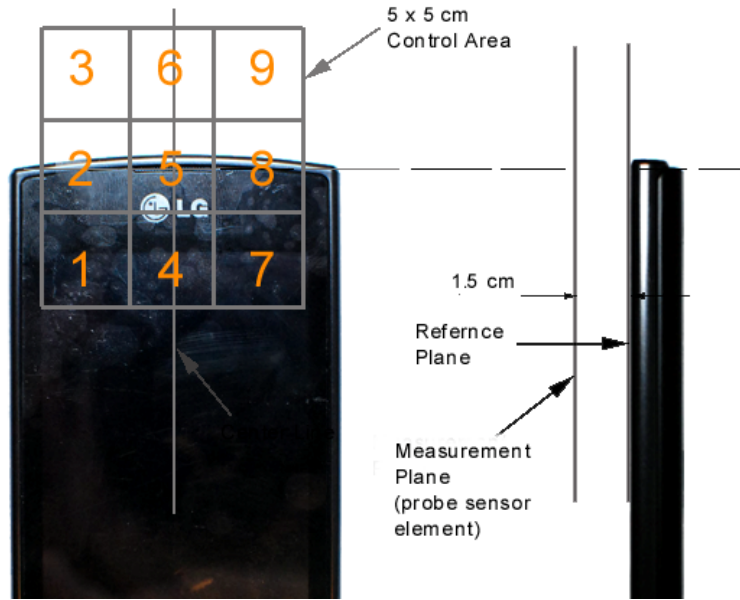

Figure 17-3
5x5 Scan grid above WD



Figure 17-4
E-Field WD Scan overlay



Figure 17-5
H-Field WD Scan overlay

FCC ID: ZNFMS695	PCTEST ENGINEERING LABORATORY, INC.	HAC (RF EMISSIONS) TEST REPORT	LG	Reviewed by: Quality Manager
HAC Filename: 0Y1112192176.ZNF	Test Dates: 12/27/2011	EUT Type: Portable Handset		Page 80 of 80