



17. TEST PHOTOGRAPHS

See following Attached Pages for setup photographs.

FCC ID: ZNFM703	 PCTEST ENGINEERING LABORATORY, INC.	HAC (RF EMISSIONS) TEST REPORT	 LG	Approved by: Quality Manager
Filename: 1M1706190198-09.ZNF	Test Dates: 6/19/2017 - 6/21/2017	DUT Type: Portable Handset	Page 68 of 70	

© 2017 PCTEST Engineering Laboratory, Inc.

REV 3.1.M

05/15/2017

© 2017 PCTEST Engineering Laboratory, Inc. All rights reserved. Unless otherwise specified, no part of this report may be reproduced or utilized in any part, form or by any means, electronic or mechanical, including photocopying and microfilm, without permission in writing from PCTEST Engineering Laboratory, Inc. If you have any questions about this international copyright or have an enquiry about obtaining additional rights to this report or assembly of contents thereof, please contact INFO@PCTESTLAB.COM.

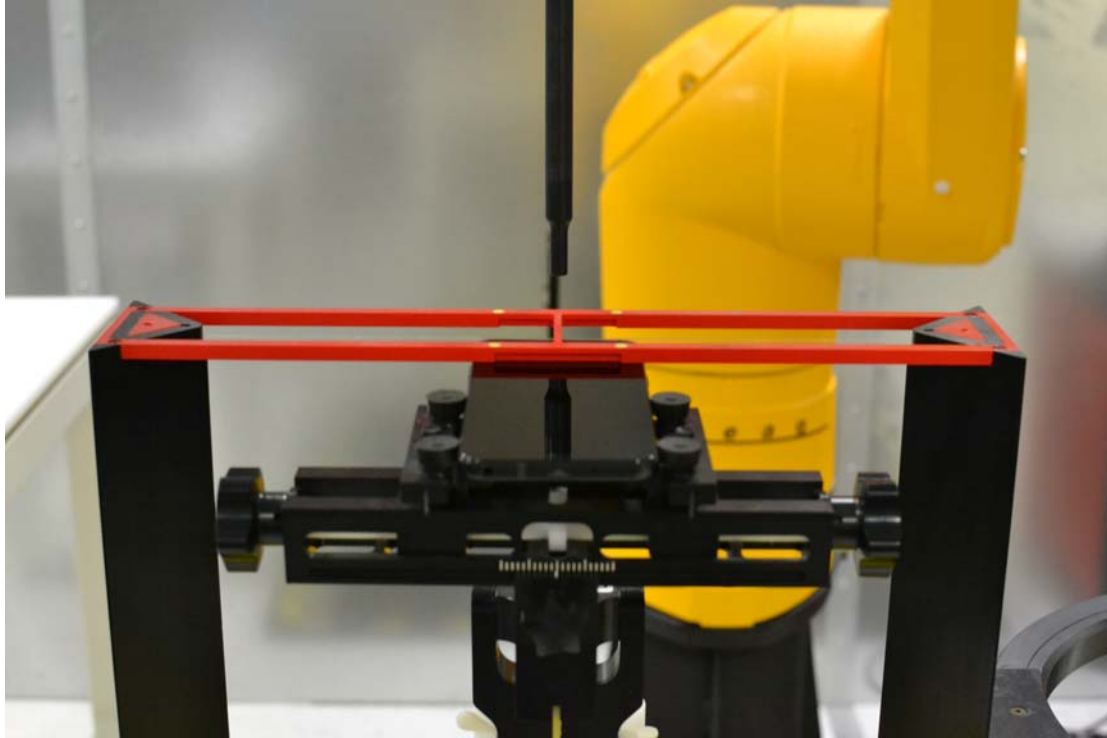

Figure 17-1
Ear Reference Point HAC Phantom Alignment

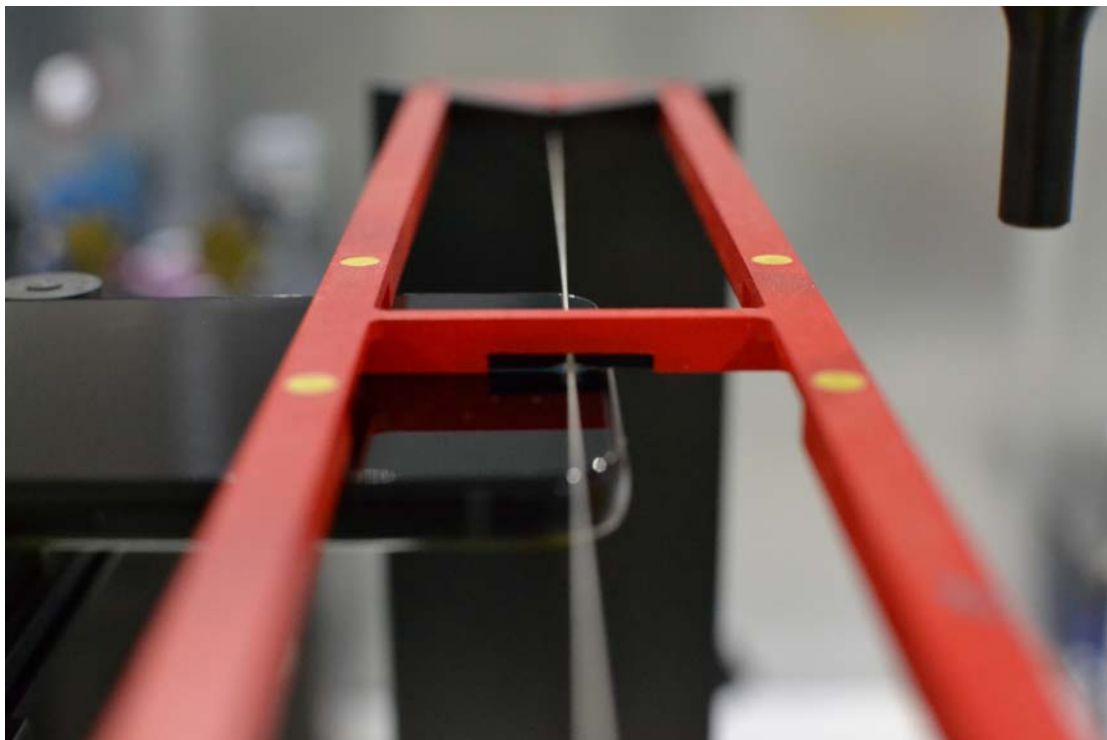



Figure 17-2
HAC Phantom Plane Alignment

FCC ID: ZNFM703	 PCTEST ENGINEERING LABORATORY, INC.	HAC (RF EMISSIONS) TEST REPORT	 LG	Approved by: Quality Manager
Filename: 1M1706190198-09.ZNF	Test Dates: 6/19/2017 - 6/21/2017	DUT Type: Portable Handset	Page 69 of 70	

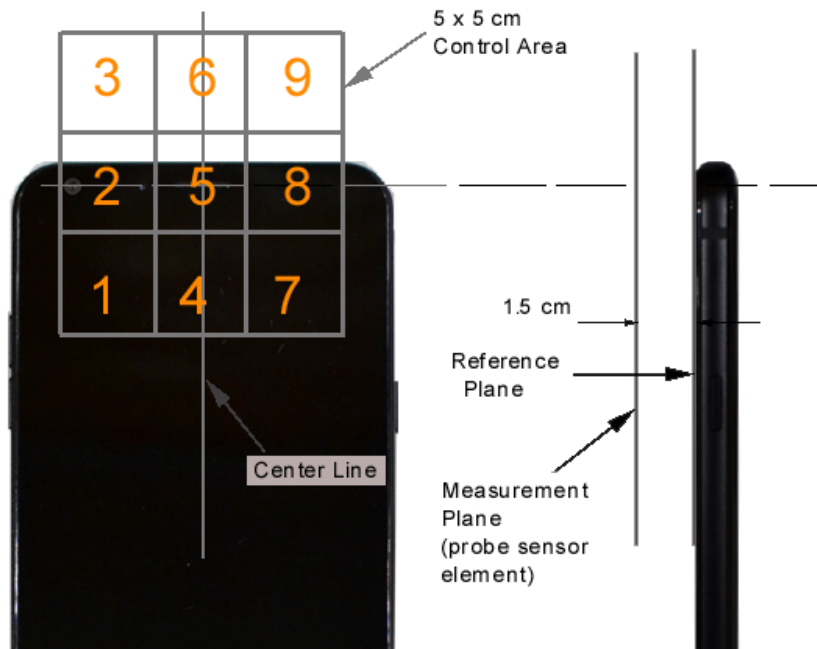

Figure 17-3 5x5 Scan grid above WD



Figure 17-4 E-Field WD Scan overlay

FCC ID: ZNFM703	PCTEST ENGINEERING LABORATORY, INC.	HAC (RF EMISSIONS) TEST REPORT	LG	Approved by: Quality Manager
Filename: 1M1706190198-09.ZNF	Test Dates: 6/19/2017 - 6/21/2017	DUT Type: Portable Handset		Page 70 of 70