



74, Seoicheon-ro 578beon-gil, Majang-myeon, Icheon-si, Gyeonggi-do, Korea
TEL: +82-31-645-6300 FAX: +82-31-645-6401

SAR TEST REPORT

Applicant Name: LG Electronics MobileComm USA, Inc. 1000 Sylvan Avenue, Englewood Cliffs NJ 07632	Date of Issue: 06. 27, 2017 Test Report No.: HCT-A-1706-F008-1 Test Site: HCT CO., LTD.
--	--

FCC ID:

ZNFM700TV

Equipment Type: GSM/WCDMA/LTE Phone with Bluetooth4.2LE, WIFI802.11 b/g/n

Model Name: LG-M700TV
Additional FCC Model(s): LGM700TV, M700TV

Testing has been carried out in accordance with:
47CFR §2.1093
ANSI/ IEEE C95.1 – 1992
IEEE 1528-2013

Date of Test: 05/18/2017 ~ 06/07/2017

This device has been shown to be capable of compliance for localized specific absorption rate (SAR) for uncontrolled environment/general population exposure limits specified in FCC KDB procedures and had been tested in accordance with the measurement procedures specified in FCC KDB procedures.

I attest to the accuracy of data. All measurements reported herein were performed by me or were made under my supervision and are correct to the best of my knowledge and belief. I assume full responsibility for the completeness of these measurements and vouch for the qualifications of all persons taking them.

Tested By

Young-Seok, Yoo
Test Engineer
SAR Team
Certification Division

Reviewed By

Yun-Jeang, Heo
Technical Manager
SAR Team
Certification Division

This report only responds to the tested sample and may not be reproduced, except in full, without written approval of the HCT Co., Ltd.

DOCUMENT HISTORY

Version	DATE	DESCRIPTION
HCT-A-1706-F008	06. 16, 2017	First Approval Report
HCT-A-1706-F008-1	06. 27, 2017	Sec.2.5.2, Sec.2.8, plot 12 were revised.

Table of Contents

1. Attestation of Test Result of Device Under Test.....	4
2. Device Under Test Description	5
3. INTRODUCTION	1 5
4. DESCRIPTION OF TEST EQUIPMENT	1 6
5. SAR MEASUREMENT PROCEDURE	1 7
6. DESCRIPTION OF TEST POSITION.....	1 9
7. ANSI/ IEEE C95.1 - 1992 RF EXPOSURE LIMITS.....	2 2
8. FCC SAR GENERAL MEASUREMENT PROCEDURES	2 3
9. Output Power Specifications	2 8
10. SYSTEM VERIFICATION	3 9
11. SAR TEST DATA SUMMARY	4 2
12. Simultaneous SAR Analysis	5 3
13. SAR Measurement Variability and Uncertainty.....	5 7
14. MEASUREMENT UNCERTAINTY	5 8
15. SAR TEST EQUIPMENT	5 9
16. CONCLUSION.....	5 9
17. REFERENCES	6 1
Attachment 1. – SAR Test Plots.....	6 3
Attachment 2. – Dipole Verification Plots.....	6 4
Attachment 3. – Probe Calibration Data	1 0 1
Attachment 4. – Dipole Calibration Data	1 4 8
Attachment 5. – SAR Tissue Characterization	1 0 2
Attachment 6. – SAR SYSTEM VALIDATION	1 9 1

1. Attestation of Test Result of Device Under Test

Test Laboratory	
Company Name:	HCT Co., LTD
Address	74, Seoicheon-ro 578beon-gil, Majang-myeon, Icheon-si, Gyeonggi-do, 17383, Rep. of Korea
Telephone	+82 31 645 6300
Fax.	+82 31 645 6401

Attestation of SAR test result	
Trade Name:	LG Electronics, MobileComm U.S.A., Inc.
FCC ID:	ZNFM700TV
Model:	LG-M700TV
Additional FCC Model(s):	LGM700TV, M700TV
EUT Type:	GSM/WCDMA/LTE Phone with Bluetooth4.2LE, WIFI802.11 b/g/n
Application Type:	Certification

The Highest Reported SAR (W/Kg)					
Band	Tx. Frequency	Equipment Class	Reported 1g SAR (W/kg)		
	(MHz)		Head	Body-Worn	Hotspot
GSM/GPRS/EDGE 850	824.2 ~ 848.8	PCE	0.14	0.46	0.46
GSM/GPRS/EDGE 1900	1 850.2 ~ 1 909.8	PCE	0.16	0.45	0.76
UMTS 850	826.4 ~ 846.6	PCE	0.24	0.68	0.68
UMTS 1900	1 852.4 ~ 1 907.6	PCE	0.21	0.58	1.11
LTE Band 2 (PCS)	1 850.7 ~ 1 909.3	PCE	0.18	0.79	0.79
LTE Band 7	2 502.5 ~ 2 567.5	PCE	0.26	0.22	0.28
LTE Band 17	706.5 ~ 713.5	PCE	0.11	0.56	0.58
802.11b	2 412 ~ 2 462	DTS	0.77	0.17	0.19
Bluetooth	2 402 ~ 2 480	DSS/DTS	0.22	N/A	N/A
Simultaneous SAR per KDB 690783 D01v01r03			1.02	1.07	1.38
Date(s) of Tests:	05/18/2017 ~ 06/07/2017				

2. Device Under Test Description

2.1 DUT specification

Device Wireless specification overview		
Band & Mode	Operating Mode	Tx Frequency
GSM/GPRS/EDGE 850	Voice / Data	824.2 – 848.8 MHz
GSM/GPRS/EDGE 1900	Voice / Data	1 850.2 – 1 909.8 MHz
UMTS 850	Voice / Data	826.4 – 846.6 MHz
UMTS 1900	Voice / Data	1 852.4 – 1 907.6 MHz
LTE Band 2 (PCS)	Voice / Data	1 850.7 – 1 909.3 MHz
LTE Band 7	Voice / Data	2 502.5 – 2 567.5 MHz
LTE Band 17	Voice / Data	706.5 – 713.5 MHz
2.4 GHz WLAN	Voice / Data	2 412 – 2 462 MHz
Bluetooth	Data	2 402 – 2 480 MHz

Device Description									
Device Dimension	Overall (Length x Width): 69.3 mm x 142.5 mm Overall diagonal dimension: 151 mm Display diagonal dimension: 135 mm								
Back Cover:	Normal Battery cover								
Battery Options	Standard (Li-ion Polymer Battery)								
	Battery Model Name: BL-T33, Manufacturer: LishenVX								
Device Serial Numbers	<table border="1"> <thead> <tr> <th>Mode</th> <th>Serial Number</th> </tr> </thead> <tbody> <tr> <td>GSM850/ UMTS850/ LTE17</td> <td>3290M</td> </tr> <tr> <td>GSM1900/ UMTS1900/ LTE2/ 7</td> <td>3290K</td> </tr> <tr> <td>2.4 GHz WLAN/ Bluetooth</td> <td>3290L</td> </tr> </tbody> </table>	Mode	Serial Number	GSM850/ UMTS850/ LTE17	3290M	GSM1900/ UMTS1900/ LTE2/ 7	3290K	2.4 GHz WLAN/ Bluetooth	3290L
	Mode	Serial Number							
	GSM850/ UMTS850/ LTE17	3290M							
	GSM1900/ UMTS1900/ LTE2/ 7	3290K							
2.4 GHz WLAN/ Bluetooth	3290L								
Several samples with identical hardware were used to SAR testing. The manufacturer has confirmed that the devices tested have the same physical, mechanical and thermal characteristics are within operational tolerances expected for production units.									
Power Reduction for SAR	There is no power reduction used for any band/mode implemented in this device for SAR purposes.								

2.2 DUT Wireless mode

Wireless Modulation	Band	Operating Mode		Duty Cycle
GSM	850 1900	Voice(GMSK) GPRS (GMSK) EGPRS (8PSK)	GPRS/ EDGE Multi-Slot Class: Class 33 – 4 Up, 5 Down Mode class B	GSM Voice: 12.5% GPRS/EDGE: 1 Slot: 12.5% 2 Slots : 25% 3 Slots : 37.5% 4 Slots : 50%
WCDMA (UMTS)	Band 5 Band 2	UMTS Rel.99 (Voice / DATA) HSDPA (Rel. 5,Cat.10) HSUPA (Rel. 6 Cat.6) DC-HSDPA (Rel.8, Cat.24) HSPA+ (Rel. 7, Cat.14) (Uplink QPSK Only)		100 %
LTE Band	2 (PCS)	Voice / Data (QPSK, 16QAM)		100 % (FDD)
	7	Voice / Data (QPSK, 16QAM)		100 % (FDD)
	17	Voice / Data (QPSK, 16QAM)		100 % (FDD)
2.4 GHz WLAN		Voice / Data	802.11 b, 802.11 g, 802.11 n (HT20)	99.84 %
Bluetooth		Data		76.4 % (DH5)
Bluetooth 4.2 LE		Data		N/A

2.3 LTE information

Item.		Description		
Frequency Range	LTE Band 2 (PCS)	1 850.7 MHz ~ 1 909.3 MHz		
	LTE Band 7	2 502.5 MHz ~ 2 567.5 MHz		
	LTE Band 17	706.5 MHz~ 713.5 MHz		
Channel Bandwidths	LTE Band 2 (PCS)	1.4 MHz, 3 MHz, 5 MHz, 10 MHz, 15 MHz, 20 MHz		
	LTE Band 7	5 MHz, 10 MHz, 15 MHz, 20 MHz		
	LTE Band 17	5 MHz, 10 MHz		
Channel Numbers & Freq.(MHz)		Low	Mid	High
LTE Band 2 (PCS)	1.4 MHz	1 850.7 (18607)	1 880.0 (18900)	1 909.3 (19193)
	3 MHz	1 851.5 (18615)	1 880.0 (18900)	1 908.5 (19185)
	5 MHz	1 852.5 (18625)	1 880.0 (18900)	1 907.5 (19175)
	10 MHz	1 855.0 (18650)	1 880.0 (18900)	1 905.0 (19150)
	15 MHz	1 857.5 (18675)	1 880.0 (18900)	1 902.5 (19125)
	20 MHz	1 860.0 (18700)	1 880.0 (18900)	1 900.0 (19100)
LTE Band 7	5 MHz	2 502.5 (20775)	2 535 (21100)	2 567.5 (21425)
	10 MHz	2 505.0 (20800)	2 535 (21100)	2 565.0 (21400)
	15 MHz	2 507.5 (20825)	2 535 (21100)	2 562.5 (21375)
	20 MHz	2 510.0 (20850)	2 535 (21100)	2 560.0 (21350)
LTE Band 17	5 MHz	706.5 (23755)	710 (23790)	713.5 (23825)
	10 MHz	709.0 (23780)	710 (23790)	711.0 (23800)
UE Category	LTE Rel. 10, Category 6			
LTE Carrier Aggregation Possible Combinations	LTE B7+ LTE B7 (CA_7C)			
	LTE B7:15,20MHz	LTE B7:10,15,20MHz		LTE B7:10,15,20MHz
	LTE B7:15,20MHz	LTE B7:10,15,20MHz		LTE B7:10,15,20MHz
	LTE B7+ LTE B7(CA_7A-7A)			
	LTEB7:5,10,15,20MHz	LTEB7:5,10,15,20MHz	LTEB7:5,10,15,20MHz	LTEB7:5,10,15,20MHz
	LTEB7:5,10,15,20MHz	LTEB7:5,10,15,20MHz	LTEB7:5,10,15,20MHz	LTEB7:5,10,15,20MHz
Modulations Supported in UL	QPSK, 16QAM			
LTE voice/data requirements	Voice/ DATA VOLTE is supported. LTE Head SAR is also evaluated.			
LTE MPR options	The EUT incorporates MPR as per 3GPP TS 36.101 sec. 6.2.3 ~ 6.2.5			
	The MPR is permanently built-in by design as a mandatory.			
	A-MPR is not implemented in the DUT.			
Power reduction explanation	This device doesn't implements power reduction.			
LTE Carrier Aggregation	This device only supports downlink Intra-Band Carrier Aggregation. Inter-Band Down-Link and Up-link carrier aggregations do not support.			
LTE Release 10 Additional Information	This device does not support full feature on 3GPP Release 10. It supports a maximum of 2 carriers in the downlink. All uplink communications are identical to the Release 8 specifications. The following LTE release 10 features are not supported: Up link Carrier aggregations Replay, HetNet, Enhanced MIMO, eICI, WIFI offloading, MDH, eMBHA, Cross-Carrier Scheduling, Enhanced SC-FDMA.			
Description of the test equipment, software, etc.	LTE SAR Testing was performed using a CMW500./MT8820C UE transmits with maximum output power during SAR testing.			

2.4 TEST METHODOLOGY and Procedures

The tests documented in this report were performed in accordance with IEEE Standard 1528-2013 the following published KDB procedures.

- FCC KDB Publication 941225 D01 3G SAR Procedures v03r01
- FCC KDB Publication 941225 D06 Hot Spot SAR v02r01
- FCC KDB Publication 941225 D05 SAR for LTE Devices v02r05
- FCC KDB Publication 941225 D05A LTE Rel.10 KDB Inquiry sheet v01r02
- FCC KDB Publication 248227 D01 802.11 Wi-Fi SAR v02r02
- FCC KDB Publication 447498 D01 General SAR Guidance v06
- FCC KDB Publication 648474 D04 Handset SAR v01r03
- FCC KDB Publication 865664 D01 SAR measurement 100 MHz to 6 GHz v01r04
- FCC KDB Publication 865664 D02 SAR Reporting v01r02
- October 2013 TCB Workshop Notes (GPRS testing criteria)
- April 2015 TCB Workshop Notes (Simultaneous transmission summation clarified)

2.5 Nominal and Maximum Output Power Specifications

This device operates using the following maximum output power specifications. SAR values were scaled to the maximum allowed power to determine compliance per KDB publication 447498 D01v06.

2.5.1 Maximum PCE Power

Mode / Band		Voice (dBm)	Burst Average GMSK GPRS (dBm)				Burst Average 8-PSK EGPRS (dBm)			
		1 Tx Slot	1 Tx Slot	2 Tx Slot	3 Tx Slot	4 Tx Slot	1 Tx Slot	2 Tx Slot	3 Tx Slot	4 Tx Slot
GSM/GPRS/EDGE 850	Maximum	33.7	33.7	30.7	28.7	28.2	26.2	25.7	25.7	24.7
	Nominal	33.2	33.2	30.2	28.2	27.7	25.7	25.2	25.2	24.2
GSM/GPRS/EDGE 1900	Maximum	30.7	30.7	28.7	26.7	26.7	25.7	25.2	25.2	24.7
	Nominal	30.2	30.2	28.2	26.2	26.2	25.2	24.7	24.7	24.2

Mode / Band		3GPP WCDMA	3GPP HSDPA(dBm)				3GPP HSUPA(dBm)					DC-HSDPA(dBm)			
			Sub test1	Sub test2	Sub test3	Sub test4	Sub test1	Sub test2	Sub test3	Sub test4	Sub Test5	Sub test1	Sub test2	Sub test3	Sub test4
UMTS Band 5 (850 MHz)	Maximum	25.2	25.2	25.2	24.7	24.7	25.2	23.2	24.2	23.2	25.2	25.2	25.2	24.7	24.7
	Nominal	24.7	24.7	24.7	24.2	24.2	24.7	22.7	23.7	22.7	24.7	24.7	24.7	24.2	24.2
UMTS Band 2 (1900 MHz)	Maximum	23.7	23.7	23.7	23.2	23.2	23.7	21.7	22.7	21.7	23.7	23.7	23.7	23.2	23.2
	Nominal	23.2	23.2	23.2	22.7	22.7	23.2	21.2	22.2	21.2	23.2	23.2	23.2	22.7	22.7

Mode / Band		Modulated Average (dBm)
LTE Band 2 (PCS)	Maximum	23.7
	Nominal	23.2
LTE Band 7	Maximum	24.2
	Nominal	23.7
LTE Band 17	Maximum	25.2
	Nominal	24.7

2.5.2 Maximum WLAN/BT Power

Mode / Band		Modulated Average (dBm)		
		1 CH	2 CH ~10 CH	11 CH
IEEE 802.11b (2.4 GHz)	Maximum	16.0	17.0	16.0
	Nominal	15.0	16.0	15.0
IEEE 802.11g (2.4 GHz)	Maximum	15.0	16.0	15.0
	Nominal	14.0	15.0	14.0
IEEE 802.11n (2.4 GHz) HT20	Maximum	14.0	15.0	14.0
	Nominal	13.0	14.0	13.0

Mode / Band		Modulated Average (dBm)	
Bluetooth	DH5	Maximum	11
		Nominal	10
	2-DH5	Maximum	11
		Nominal	10
	3-DH5	Maximum	11
		Nominal	10
	LE	Maximum	2
		Nominal	1

2.6 DUT Antenna Locations

Device Edges / Sides for SAR Testing						
Mode	Rear	Front	Left	Right	Bottom	Top
GSM/GPRS 850	Yes	Yes	No	Yes	Yes	No
GSM/GPRS 1900	Yes	Yes	Yes	No	Yes	No
UMTS 850	Yes	Yes	No	Yes	Yes	No
UMTS 1900	Yes	Yes	Yes	No	Yes	No
LTE Band 2	Yes	Yes	Yes	No	Yes	No
LTE Band 7	Yes	Yes	Yes	No	Yes	No
LTE Band 17	Yes	Yes	No	Yes	Yes	No
2.4 GHz WLAN	Yes	Yes	Yes	No	No	Yes
Bluetooth	Yes	Yes	Yes	No	No	Yes

Particular EUT edges were not required to be evaluated for Wireless Router SAR if the edges were > 25 mm from the transmitting antenna according to FCC KDB 941225 D06v02r01 on page 2. The distance between the transmit antennas and the edges of the device are included in found in SAR _ Setup_ photos.

Note; All test configurations are based on front view.

2.7 SAR Summation Scenario

According to FCC KDB 447498 D01v06, transmitters are considered to be transmitting simultaneously when there is overlapping transmission, with the exception of transmissions during network hand-offs with maximum hand-off duration less than 30 seconds. Possible transmission paths for the EUT are shown below paths and are mode in same rectangle to indicate communication modes which share the same path. Modes which share the same transmission path cannot transmit simultaneously with one another.

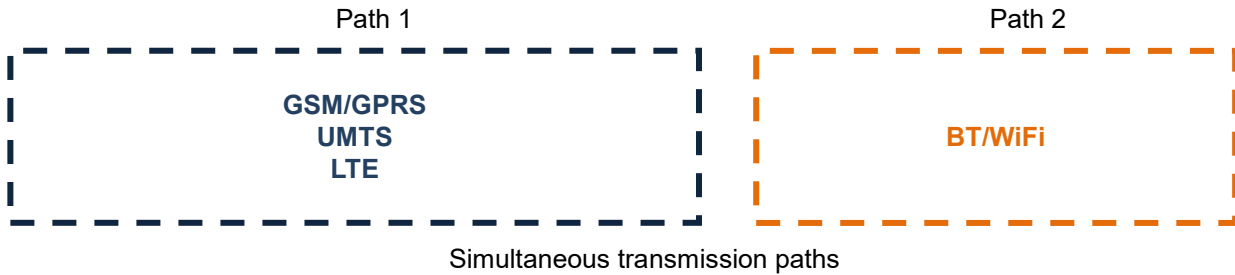

This device contains multiple transmitters that may operate simultaneously, and therefore requires a simultaneous transmission analysis according to FCC KDB 447498 D01v06.

Simultaneous Transmission Scenarios			
Applicable Combination	Head	Body-Worn	Hotspot
GSM Voice + 2.4 GHz WiFi	Yes	Yes	N/A
GSM Voice + 2.4 GHz Bluetooth	Yes*	Yes	N/A
GPRS/EDGE + 2.4 GHz WiFi	Yes	Yes	Yes
GPRS/EDGE + 2.4 GHz Bluetooth	Yes*	Yes	Yes *
UMTS + 2.4 GHz WiFi	Yes	Yes	Yes
UMTS + 2.4 GHz Bluetooth	Yes*	Yes	Yes *
LTE+ 2.4 GHz WiFi	Yes	Yes	Yes
LTE+ 2.4 GHz Bluetooth	Yes*	Yes	Yes *

1. 2.4 GHz WLAN and 2.4 GHz Bluetooth share antenna path and cannot transmit simultaneously.
2. All licensed modes share the same antenna path and cannot transmit simultaneously.
3. UMTS +WLAN scenario also represents the UMTS Voice/DATA + WLAN hotspot scenario.
4. Per the manufacturer, GPRS support VOIP service.
5. This device support VoLTE and VoWIFI .
6. The highest reported SAR for each exposure condition is used for SAR summation purpose.
7. * BT Tethering applications are considered.

2.8 SAR Test Exclusions Applied

(A) BT & LE

Per FCC KDB 447498 D01v06, The SAR exclusion threshold for distance < 50mm is defined by the following equation:

$$\frac{\text{Max Power of Channel(mW)}}{\text{Test Separation Distance (mm)}} * \sqrt{\text{Frequency(GHz)}} \leq 3.0$$

Mode	Frequency	Maximum Allowed Power	Separation Distance	≤ 3.0
	[MHz]	[mW]	[mm]	
Bluetooth	2 480	13	10	2.0
Bluetooth LE	2 480	2	10	0.3

Based on the maximum conducted power of Bluetooth and antenna to use separation distance, Bluetooth SAR was not required $[(13/10)*\sqrt{2.480}] = 2.0 < 3.0$.

Based on the maximum conducted power of Bluetooth LE and antenna to use separation distance, Bluetooth LE SAR was not required $[(2/10)*\sqrt{2.480}] = 0.3 < 3.0$.

This device contains transmitters that may operate simultaneously. Therefore simultaneous transmission analysis is required. Per FCC KDB 447498 D01v06 IV.C.1iii, simultaneous transmission SAR test exclusion may be applied when the sum of the 1-g SAR for all the simultaneous transmitting antennas in a specific a physical test configuration is ≤ 1.6W/kg. When standalone SAR is not required to be measured per FCC KDB 447498 D01v06 4.3.22, the following equation must be used to estimate the standalone 1-g SAR for simultaneous transmission assessment involving that transmitter.

$$\text{Estimated SAR} = \frac{\sqrt{f(\text{GHZ})}}{7.5} * \frac{(\text{Max Power of channel mW})}{\text{Min Separation Distance}}$$

Mode	Frequency	Maximum Allowed Power	Separation Distance (Body)	Estimated SAR (Body)
	[MHz]	[mW]	[mm]	[W/kg]
Bluetooth	2 480	13	10	0.273
Bluetooth LE	2 480	2	10	0.042

Note:

- 1). The Estimated SAR results were determined according to FCC KDB447498 D01v06.
- 2) The frequency of Bluetooth and Bluetooth LE using for estimated SAR was selected highest channel of Bluetooth LE for highest estimated SAR.

(B) Licensed Transmitter(s)

GSM/GPRS/EDGE DTM is not supported for US bands. Therefore, the GSM Voice modes in this report do not transmit simultaneously with GPRS/EDGE Data.

This device is only capable of QPSK HSUPA in the uplink. Therefore, no additional SAR tests are required beyond that described for devices with HSUPA in KDB 941225 D01v03r01.

LTE SAR for the higher modulations and lower bandwidths were not tested since the maximum average output power of all required channels and configurations was not more than 0.5 dB higher than the highest bandwidth; and the reported LTE SAR for the highest bandwidth was less than 1.45 W/kg for all configurations according to FCC KDB 941225 D05v02r05.

Per FCC KDB 941225 D01v03r01, 12.2 kbps RMC is the primary mode and HSPA (HSUPA/HSDPA with RMC) is the secondary mode.

Per FCC KDB 941225 D01v03r01, The SAR test exclusion is applied to the secondary mode by the following equation.

$$\text{Adjusted SAR} = \text{Highest Reported SAR} * \frac{\text{Secondary Max tune - up (mW)}}{\text{Primary Max tune - up(mW)}} \leq 1.2 \text{ W/kg.}$$

Based on the highest Reported SAR, the secondary mode is not required.

$$1.110 * (234/234)] = 1.110 \text{ W/kg} \leq 1.2 \text{ W/kg}$$

And the maximum output power and tune-up tolerance in secondary mode is ≤ 0.25 dB higher than the primary mode.

3. INTRODUCTION

The FCC has adopted the guidelines for evaluating the environmental effects of radio frequency radiation in ET Docket 93-62 on Aug. 6, 1996 to protect the public and workers from the potential hazards of RF emissions due to FCC-regulated portable devices.

The safety limits used for the environmental evaluation measurements are based on the criteria published by the American National Standards Institute (ANSI) for localized specific absorption rate (SAR) in IEEE/ANSI C95.1-1992 Standard for Safety Levels with Respect to Human Exposure to Radio Frequency Electromagnetic Fields, 3 kHz to 300 GHz. 1992 by the Institute of Electrical and Electronics Engineers, Inc., , New York 10017. The measurement procedure described in IEEE/ANSI C95.3-1992 Recommended Practice for the Measurement of Potentially Hazardous Electromagnetic Fields - RF and Microwave is used for guidance in measuring SAR due to the RF radiation exposure from the Equipment Under Test (EUT). These criteria for SAR evaluation are similar to those recommended by the National Council on Radiation Protection and Measurements (NCRP) in Biological Effects and Exposure Criteria for Radio Frequency Electromagnetic Fields," NCRP Report No. 86 NCRP, 1986, Bethesda, MD 20814. SAR is a measure of the rate of energy absorption due to exposure to an RF transmitting source. SAR values have been related to threshold levels for potential biological hazards.

SAR Definition

Specific Absorption Rate (SAR) is defined as the time derivative of the incremental electromagnetic energy (dW) absorbed by (dissipated in) an incremental mass (dm) contained in a volume element (dV) of a given density (r). It is also defined as the rate of RF energy absorption per unit mass at a point in an absorbing body.

$$SAR = \frac{d}{dt} \left(\frac{dU}{dm} \right)$$

Figure 1. SAR Mathematical Equation

SAR is expressed in units of Watts per Kilogram (W/kg)

$$SAR = \sigma E^2 / \rho$$

Where:

σ = conductivity of the tissue-simulant material (S/m)

ρ = mass density of the tissue-simulant material (kg/m³)

E = Total RMS electric field strength (V/m)

NOTE: The primary factors that control rate of energy absorption were found to be the wavelength of the incident field in relations to the dimensions and geometry of the irradiated organism, the orientation of the organism in relation to the polarity of field vectors, the presence of reflecting surfaces, and whether conductive contact is made by the organism with a ground plane.

4. DESCRIPTION OF TEST EQUIPMENT

4.1 SAR MEASUREMENT SETUP

These measurements are performed using the DASY4 & DASY5 automated dosimetric assessment system. It is made by Schmid & Partner Engineering AG (SPEAG) in Zurich, Switzerland. It consists of high precision robotics system (Staubli), robot controller, Pentium III computer, near-field probe, probe alignment sensor, and the generic twin phantom containing the brain equivalent material. The robot is a six-axis industrial robot performing precise movements to position the probe to the location (points) of maximum electromagnetic field (EMF) (see Figure.2).

A cell controller system contains the power supply, robot controller, teach pendant (Joystick), and remote control, is used to drive the robot motors. The PC with Windows XP or Windows 7 is working with SAR Measurement system DASY4 & DASY5, A/D interface card, monitor, mouse, and keyboard. The Staubli Robot is connected to the cell controller to allow software manipulation of the robot. A data acquisition electronic (DAE) circuit performs the signal amplification, signal multiplexing, AD-conversion, offset measurements, mechanical surface detection, collision detection, etc. is connected to the Electro-optical coupler (EOC). The EOC performs the conversion from the optical into digital electric signal of the DAE and transfers data to the PC plug-in card.

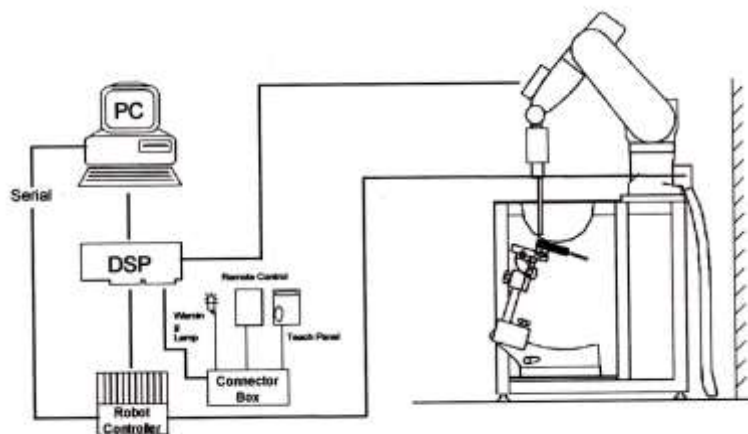

Figure 2. HCT SAR Lab. Test Measurement Set-up

The DAE consists of a highly sensitive electrometer-grade preamplifier with auto-zeroing, a channel and gain-switching multiplexer, a fast 16 bit AD-converter and a command decoder and control logic unit. Transmission to the PC-card is accomplished through an optical downlink for data and status information and an optical uplink for commands and clock lines. The mechanical probe mounting device includes two different sensor systems for frontal and sidewise probe contacts. They are also used for mechanical surface detection and probe collision detection. The robot uses its own controller with a built in VME-bus computer. The system is described in detail in.

5. SAR MEASUREMENT PROCEDURE

The evaluation was performed with the following procedure:

1. The SAR distribution at the exposed side of the head or body was measured at a distance no more than 5.0 mm from the inner surface of the shell. The area covered the entire dimension of the DUT's head and body area and the horizontal grid resolution was depending on the FCC KDB 865664 D01v01r04 table 4-1 & IEEE 1528-2013.
2. Based on step, the area of the maximum absorption was determined by sophisticated interpolations routines implemented in DASY software. When an Area Scan has measured all reachable point. DASY system computes the field maximal found in the scanned are, within a range of the maximum. SAR at this fixed point was measured and used as a reference value.
3. Around this point, a volume was assessed according to the measurement resolution and volume size requirements of FCC KDB 865664 D01v01r04 table 4-1 and IEEE 1528-2013. On the basis of this data set, the spatial peak SAR value was evaluated with the following procedure (reference from the DASY manual.)
 - a. The data at the surface were extrapolated, since the center of the dipoles is no more than 2.7 mm away from the tip of the probe (it is different from the probe type) and the distance between the surface and the lowest measuring point is 1.2 mm. The extrapolation was based on a least square algorithm. A polynomial of the fourth order was calculated through the points in z-axes. This polynomial was then used to evaluate the points between the surface and the probe tip.
 - b. The maximum interpolated value was searched with a straight-forward algorithm. Around this maximum the SAR values averaged over the spatial volumes (1 g or 10 g) were computed using the 3D-Spline interpolation algorithm. The 3D-spline is composed of three one-dimensional splines with the "Not a knot" condition (in x, y, and z directions. The volume was integrated with the trapezoidal algorithm. One thousand points (10 x 10 x 10) were interpolated to calculate the average.
 - c. All neighboring volumes were evaluated until no neighboring volume with a higher average value was found.
4. The SAR reference value, at the same location as step 2, was re-measured after the zoom scan. If the value changed by more than 5 %, the SAR evaluation and drift measurements were repeated.

Area scan and zoom scan resolution setting follow KDB 865664 D01v01r04 quoted below.

		≤ 3 GHz	> 3 GHz
Maximum distance from closest measurement point (geometric center of probe sensors) to phantom surface		5 ± 1 mm	$\frac{1}{2} \cdot \delta \cdot \ln(2) \pm 0.5$ mm
Maximum probe angle from probe axis to phantom surface normal at the measurement location		$30^\circ \pm 1^\circ$	$20^\circ \pm 1^\circ$
Maximum area scan Spatial resolution: $\Delta x_{Area}, \Delta y_{Area}$		≤ 2 GHz: ≤ 15 mm 2-3 GHz: ≤ 12 mm	3-4 GHz: ≤ 12 mm 4-6 GHz: ≤ 10 mm
	When the x or y dimension of the test device, in the measurement plane orientation, is smaller than the above, the measurement resolution must be \leq the corresponding x or y dimension of the test device with at least one measurement point on the test device.		
Maximum zoom scan Spatial resolution: $\Delta x_{zoom}, \Delta y_{zoom}$		≤ 2 GHz: ≤ 8 mm 2-3 GHz: ≤ 5 mm*	3-4 GHz: ≤ 5 mm* 4-6 GHz: ≤ 4 mm*
Maximum zoom scan Spatial resolution normal to phantom surface	uniform grid: $\Delta z_{zoom}(n)$	≤ 5 mm	3-4 GHz: ≤ 4 mm 4-5 GHz: ≤ 3 mm 5-6 GHz: ≤ 2 mm
	graded grid $\Delta z_{zoom}(1)$: between 1 st two Points closest to phantom surface	≤ 4 mm	3-4 GHz: ≤ 3 mm 4-5 GHz: ≤ 2.5 mm 5-6 GHz: ≤ 2 mm
	$\Delta z_{zoom}(n>1)$: between subsequent Points	$\leq 1.5 \cdot \Delta z_{zoom}(n-1)$	
Minimum zoom scan volume	x, y, z	≥ 30 mm	3-4 GHz: ≥ 28 mm 4-5 GHz: ≥ 25 mm 5-6 GHz: ≥ 22 mm
<p>Note: δ is the penetration depth of a plane-wave at normal incidence to the tissue medium; see draft standard IEEE P1528-2011 for details.</p> <p>* When zoom scan is required and the reported SAR from the area scan based 1-g SAR estimation procedures of KDB 447498 is ≤ 1.4 W/kg, ≤ 8 mm, ≤ 7 mm and ≤ 5 mm zoom scan resolution may be applied, respectively, for 2 GHz to 3 GHz, 3 GHz to 4 GHz and 4 GHz to 6 GHz.</p>			

6. DESCRIPTION OF TEST POSITION

6.1 EAR REFERENCE POINT

Figure 6-2 shows the front, back and side views of the SAM phantom. The center-of-mouth reference point is labeled “M”, the left ear reference point (ERP) is marked “LE”, and the right ERP is marked “RE.” Each ERP is on the B-M (back-mouth) line located 15 mm behind the entrance-to-ear-canal (EEC) point, as shown in Figure 6-1. The Reference Plane is defined as passing through the two ear reference point and point M. The line N-F (Neck-Front), also called the Reference Pivoting Line, is not perpendicular to the reference plane (See Figure 5-1), Line B-M is perpendicular to the N-F line. Both N-F and B-M lines are marked on the external phantom shell to facilitate handset positioning.

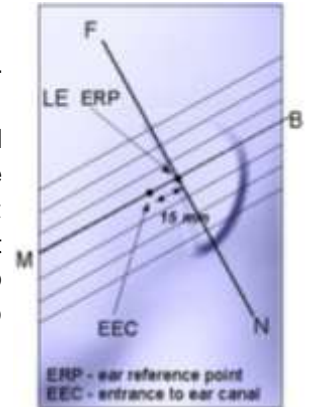

Figure 6-1
Close-up side view of ERP

6.2 HEAD POSITION

Two imaginary lines on the handset were established: the vertical centerline and the horizontal line. The device under test was placed in a normal operating position with the acoustic output located along the “vertical centerline” on the front of the device aligned to the “ear reference point”(see Figure 6-3). The acoustic output was then located at the same level as the center of the ear reference point. The device under test was positioned so that the “vertical centerline” was bisecting the front surface of the handset at its top and bottom edges, positioning the “ear reference point” on the outer surface of the both the left and right head phantoms on the ear reference point.



Figure 6-2
Front, back and side views of SAM Twin Phantom

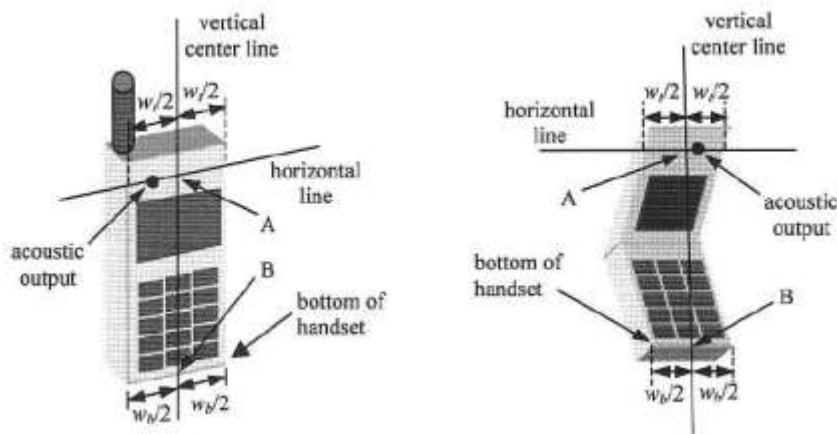

Figure 6-3. Handset vertical and horizontal reference lines

6.3 Body Holster/Belt Clip Configurations

Body-worn operating configurations are tested with the belt-clips and holsters attached to the device and positioned against a flat phantom in a normal use configuration. A device with a headset output is tested with a headset connected to the device. Body dielectric parameters are used.

Accessories for Body-worn operation configurations are divided into two categories: those that do not contain metallic components and those that contain metallic components. When multiple accessories that do not contain metallic components are supplied with the device, the device is tested with only the accessory that dictates the closest spacing to the body. Then multiple accessories that contain metallic components are tested with each accessory. If multiple accessories share an identical metallic component (i.e. the same metallic belt-clip used with different holsters with no other metallic components) only the accessory that dictates the closest spacing to the body is tested.

Body-worn accessories may not always be supplied or available as options for some Devices intended to be authorized for body-worn use. In this case, a test configuration with a separation distance between the back of the device and the flat phantom is used.

Since this EUT does not supply any body worn accessory to the end user a distance of 1.0 cm from the EUT back surface to the liquid interface is configured for the generic test.

"See the Test SET-UP Photo"

Transmitters that are designed to operate in front of a person's face, as in push-to-talk configurations, are tested for SAR compliance with the front of the device positioned to face the flat phantom. For devices that are carried next to the body such as a shoulder, waist or chest-worn transmitters, SAR compliance is tested with the accessory(ies), including headsets and microphones, attached to the device and positioned against a flat phantom in a normal use configuration.

In all cases SAR measurements are performed to investigate the worst-case positioning. Worstcase positioning is then documented and used to perform Body SAR testing.

6.4 Body-Worn Accessory Configurations

Body-Worn operating configurations are tested with the belt-dips and holsters attached to the device and positioned against a flat phantom in a normal use configuration (see Figure 6-4). Per FCC KDB Publication 648474 D04v01r03 Body-Worn accessory exposure is typically related to voice mode operations when handsets are carried in body-Worn accessories. The body-Worn accessory procedures in FCC KDB Publication 447498 D01v06 should be used to test for body-Worn accessory SAR compliance, without a headset connected to it. This enables the test results for such configuration to be compatible with that required for hotspot mode when the body-Worn accessory test separation distance is greater than or equal to that required for hotspot mode, when applicable. When the reported SAR for a body-Worn accessory, measured without a headset connected to the handset, is > 1.2 W/kg, the highest reported SAR configuration for that wireless mode and frequency band should be repeated for that body-Worn accessory with a headset attached to the handset.



Figure 6-4
Sample Body-Worn Diagram

Accessories for Body-Worn operation configurations are divided into two categories: those that do not contain metallic components and those that do contain metallic components. When multiple accessories that do not contain metallic components are supplied with the device, the device is tested with only the accessory that dictates the closest spacing to the body. Then multiple accessories that contain metallic components are tested with the device with each accessory. If multiple accessories share an identical metallic component (i.e. the same metallic belt-dip used with different holsters with no other metallic components) only the accessory that dictates the closest spacing to the body is tested.

Body-Worn accessories may not always be supplied or available as options for some devices intended to be authorized for body-Worn use. In this case, a test configuration with a separation distance between the back of the device and the flat phantom is used. Test position spacing was documented.

Transmitters that are designed to operate in front of a person's face, as in push-to-talk configurations, are tested for SAR compliance with the front of the device positioned to face the flat phantom in head fluid. For devices that are carried next to the body such as a shoulder, waist or chest-Worn transmitters. SAR compliance is tested with the accessories, including headsets and microphones, attached to the device and positioned against a flat phantom in a normal use configuration.

6.5 Wireless Router Configurations

Some battery-operated handsets have the capability to transmit and receive user data through simultaneous transmission of WIFI simultaneously with a separate licensed transmitter. The FCC has provided guidance in FCC KDB Publication 941225 D06v02r01 where SAR test considerations for handsets ($L \times W \geq 9\text{cm} \times 5\text{cm}$) are based on a composite test separation distance of 10 mm from the front back and edges of the device containing transmitting antennas within 2.5 cm of their edges, determined from general mixed use conditions for this type of devices. Since the hotspot SAR results may overlap with the body-Worn accessory SAR requirements, the more conservative configurations can be considered, thus excluding some body-Worn accessory SAR tests.

When the user enables the personal wireless router functions for the handset actual operations include simultaneous transmission of both the WIFI transmitter and another licensed transmitter. Both transmitters often do not transmit at the same transmitting frequency and thus cannot be evaluated for SAR under actual use conditions due to the limitations of the SAR assessment probes. Therefore, SAR must be evaluated for each frequency transmission and mode separately and spatially summed with the WIFI transmitter according to FCC KDB Publication 447498 D01v06 publication procedures. The "Portable Hotspot*" feature on the handset was NOT activated during SAR assessments, to ensure the SAR measurements were evaluated for a single transmission frequency RF signal at a time.

7. ANSI/ IEEE C95.1 - 1992 RF EXPOSURE LIMITS

HUMAN EXPOSURE	UNCONTROLLED ENVIRONMENT General Population	CONTROLLED ENVIRONMENT Occupational
	(W/kg) or (mW/g)	(W/kg) or (mW/g)
SPATIAL PEAK SAR * (Brain)	1.60	8.00
SPATIAL AVERAGE SAR ** (Whole Body)	0.08	0.40
SPATIAL PEAK SAR *** (Hands / Feet / Ankle / Wrist)	4.00	20.00

Table 8.1 Safety Limits for Partial Body Exposure

NOTES:

* The Spatial Peak value of the SAR averaged over any 1 g of tissue (defined as a tissue volume in the shape of a cube) and over the appropriate averaging time.

** The Spatial Average value of the SAR averaged over the whole-body.

*** The Spatial Peak value of the SAR averaged over any 10 g of tissue (defined as a tissue volume in the shape of a cube) and over the appropriate averaging time.

Uncontrolled Environments are defined as locations where there is the exposure of individuals who have no knowledge or control of their exposure. The general population/uncontrolled exposure limits are applicable to situations in which the general public may be exposed or in which persons who are exposed as a consequence of their employment may not be made fully aware of the potential for exposure or cannot exercise control over their exposure. Members of the general public would come under this category when exposure is not employment-related; for example, in the case of a wireless transmitter that exposes persons in its vicinity.

Controlled Environments are defined as locations where there is exposure that may be incurred by persons who are aware of the potential for exposure, (i.e. as a result of employment or occupation). In general, occupational/controlled exposure limits are applicable to situations in which persons are exposed as a consequence of their employment, who have been made fully aware of the potential for exposure and can exercise control over their exposure. This exposure category is also applicable when the exposure is of a transient nature due to incidental passage through a location where the exposure levels may be higher than the general population/uncontrolled limits, but the exposed person is fully aware of the potential for exposure and can exercise control over his or her exposure by leaving the area or by some other appropriate means.

8. FCC SAR GENERAL MEASUREMENT PROCEDURES

8.1 Measured and Reported SAR

Per FCC KDB Publication 447498 D01v06, when SAR is not measured at the maximum power level allowed for production units, the results must be scaled to the maximum tune-up tolerance limit according to the power applied to the individual channels tested to determine compliance. For simultaneous transmission, the measured aggregate SAR must be scaled according to the sum of the differences between the maximum tune-up tolerance and actual power used to test each transmitter. When SAR is measured at or scaled to the maximum tune-up tolerance limit, the results are referred to as Reported SAR. The highest reported SAR results are identified on the grant of equipment authorization according to procedures in KDB 690783 D01v01r03.

8.2 3G SAR Test Reduction Procedure

8.2.1 GSM, GPRS AND EDGE

The following procedures may be considered for each frequency band to determine SAR test reduction for devices operating in GSM/GPRS/EDGE modes to demonstrate RF exposure compliance. GSM voice mode transmits with 1 time slot. GPRS and EDGE may transmit up to 4 time slots in the 8 time-slot frame according to the multi-slot class implemented in a device.

8.2.2 SAR Test Reduction

In FCC KDB 941225 D01v03r01, certain transmission modes within a frequency band and wireless mode evaluated for SAR are defined as primary modes. The equivalent modes considered for SAR test reduction are denoted as secondary modes. When the maximum output power including tune-up tolerance specified for production units in a secondary mode is ≤ 0.25 dB higher than the primary mode or when the highest reported SAR of the primary mode, scaled by the ratio of specified maximum output power and tune-up tolerance of secondary to primary mode, is ≤ 1.2 W/kg, SAR measurements are not required for the secondary mode. These criteria are referred to as the 3G SAR test reduction procedure. When the 3G SAR test reduction procedure is not satisfied, SAR measurements are additionally required for the secondary mode.

SAR test reduction for GPRS and EDGE modes is determined by the source-based time-averaged output power specified for production units, including tune-up tolerance. The data mode with highest specified time-averaged output power should be tested for SAR compliance in the applicable exposure conditions. For modes with the same specified maximum output power and tolerance, the higher number time-slot configuration should be tested

8.3 Procedures Used to Establish RF Signal for SAR

The following procedures are according to FCC KDB 941225 D01v03r01 - 3G SAR Measurement Procedures. The handset was placed into a simulated call using a base station simulator in a shielded chamber. Such test signals offer a consistent means for testing SAR and are recommended for evaluation SAR measurements were taken with a fully charged battery. In order to verify that the device was tested and maintained at full power, this was configured with the base station simulator. The SAR measurement Software calculates a reference point at the start and end of the test to check for power drifts. If conducted Power deviations of more than 5 % occurred, the tests were repeated.

8.4 SAR Measurement Conditions for UMTS

8.4.1 Output Power Verification

Maximum output power is verified on the High, Middle and Low channels according to the general descriptions in sec. 5.2 of 3GPP TS 34.121, using the appropriate RMC with TPC (transmit power control) set to all "1s" or applying the required inner loop power control procedures to maintain maximum output power while HSUPA is active. Results for all applicable physical channel configurations (DPCCH, DPDCHn and spreading codes, HS-DPCCH etc) are tabulated in this test report. All configurations that are not supported by the DUT or cannot be measured due to technical or equipment limitations are identified.

8.4.2 Head SAR Measurements

SAR for next to the ear head exposure is measured using a 12.2 kbps RMC with TPC bits configured to all "1's". The 3G SAR test reduction procedure is applied to AMR configurations with 12.2 kbps RMC as the primary mode. Otherwise, SAR is measured for 12.2 kbps AMR in 3.4 kbps SRB (signaling radio bearer) using the highest reported SAR configuration in 12.2 kbps RMC for head exposure.

8.4.3 Body SAR measurements

SAR for body exposure configurations is measured using the 12.2kbps RMC with the TPC bits all "1s". the 3G SAR test reduction procedure is applied to other spreading codes and multiple DPDCHn configurations supported by the handset with 12.2 kbps RMC as the primary mode. Otherwise, SAR is measured using and applicable RMC configuration with the corresponding spreading code or DPDCHn, for the highest reported SAR configuration in 12.2kbps RMC.

8.4.4 SAR Measurements with Rel. 5 HSDPA

The 3G SAR test reduction procedure is applied to HSDPA body configurations with 12.2 kbps RMC as the primary mode. Otherwise, Body SAR for HSDPA is measured using and FRC with H-SET 1 in Sub-test and a 12.2 kbps RMC without HSDPA. Handsets with both HSDPA and HSUPA are tested according to release 6 HSPA test procedures. 8.4.5 SAR Measurement with Rel.6 HSUPA The 3G SAR test Reduction Procedure is applied to HSPA (HSUPA/HSDPA with RMC) body configurations with 12.2 kbps RMC as the primary mode. Otherwise, Body SAR for HSPA is measured with E-DCH Sub-test 5, Using H-Set 1 and QPSK for FRC and a 12.2kbps RMC configured in Test Loop Mode 1 and Power Control algorithm 2, according to the highest reported body SAR configuration in 12.2 kbps RMC without HSPA. When VOIP applies to head exposure, the 3G SAR test reduction procedure is applied with 12.2 kbps RMC as the primary mode; otherwise, the same HSPA configuration used for body SAR measurements are applied to head exposure testing.

8.4.5 SAR Measurements with Rel. 6 HSUPA

The 3G SAR test reduction procedure is applied to HSPA (HSUPA/HSDPA with RMC) body configurations with 12.2 kbps RMC as the primary mode. Otherwise, Body SAR for HSPA is measured with E-DCH Sub-test 5, using H-Set1 and QPSK for FRC and a 12.2 kbps RMC configured in Test Loop Mode 1 and power control algorithm 2, according to the highest reported body SAR configuration in 12.2 kbps RMC without HSPA.

8.4.6 DC-HSDPA

UMTS SAR was tested under RMC 12.2 kbps with HSPA inactive per KDB publication 941225 D01v03r01. HSPA SAR was not required since the average output power of the HSPA subtests was not more than 0.25 dB higher than the RMC level and SAR was less than 1.2 W/kg.

DC-HSDPA Considerations:

- 3GPP Specification 34.121-1 Release 8 Ver 8.10.0 was used for DC-HSDPA guidance
- H-Set 12(QPSK) was confirmed to be used during DC-HSDPA measurements
- Measured maximum output powers for DC-HSDPA were not greater than 1/4 dB higher than the WCDMA 12.2 kbps RMC maximum output and as a result, SAR is not required for DC-HSDPA
- The DUT supports UE category 24 for HSDPA.

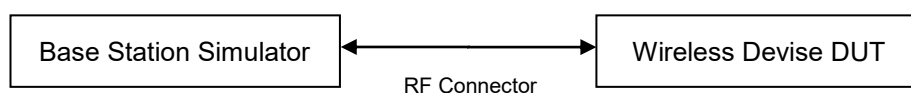

8.5 SAR Measurement Conditions for LTE

LTE modes are tested according to FCC KDB 941225 D05v02r05 publication. Establishing connections with base station simulators ensure a consistent means for testing SAR and are recommended for evaluation SAR [4]. The R&S CMW500 or Anritsu MT8820C simulators are used for LTE output power measurements and SAR testing. Closed loop power control was used so the UE transmits with maximum output power during SAR testing. SAR tests were performed with the same number of RB and RB offsets transmitting on all TTI frames (maximum TTI).

8.5.1 Spectrum Plots for RB Configurations

A properly configured base station simulator was used for SAR tests and power measurements. Therefore, spectrum plots for RB configurations were not required to be included in this report.

8.5.2 MPR

MPR is permanently implemented for this device by the manufacturer. The specific manufacturer target MPR is indicated alongside the SAR results. MPR is enabled for this device, according to 3GPP TS36. 101 Section 6.2.3 – 6.2.5 under Table 6.2.3-1.

8.5.3 A-MPR

A-MPR (Additional MPR) has been disabled for all SAR tests by setting NS=01 on the base station simulator.

8.5.4 Required RB Size and RB offsets for SAR testing

According to FCC KDB 941225 D05v02r05

- a. Per sec 4.2.1, SAR is required for QPSK 1 RB Allocation for the largest bandwidth
 - i. The required channel and offset combination with the highest maximum output power is required for SAR.
 - ii. When the reported SAR is ≤ 0.8 W/Kg, testing of the remaining RB offset configurations and required test channels is not required. Otherwise, SAR is required for the remaining required test channels using the RB offset configuration with highest output power for that channel.
 - iii. When the reported SAR for a required test channel is > 1.45 W/kg, SAR is required for all RB offset configurations for that channel.
- b. Per Sec 4.2.2, SAR is required for 50% RB allocation using the largest bandwidth following the same procedures outlined in Sec 4.2.1.
- c. Per Sec. 4.2.3, QPSK SAR is not required for the 100% allocation when the highest maximum output power for the 100% allocation is less than the highest maximum output power of the 1 RB and 50% RB allocations and the reported SAR for the 1 RB and 50% RB allocations is < 0.8 W/kg.
- d. Per Sec. 4.2.4 and 4.3, SAR test for higher order modulations and lower bandwidths configurations are not required when the conducted power of the required test configurations determined by Sec. 4.2.1 through 4.2.3 is less than or equal to 1/2 dB higher than the equivalent configuration using QPSK modulation and when the QPSK SAR for those configurations is < 1.45 W/Kg.

8.5.5 Downlink Carrier Aggregation

Conducted power measurements with LTE Carrier aggregation (CA) downlink only active are made in accordance to KDB publication 941225 D05Av01r02. The RRC connection is only handled by one cell, the primary component carrier (PCC) for downlink and uplink communications. After making a data connection to the PCC, the UE device adds secondary component carrier (SCC) on the downlink only. All uplink communications and acknowledgements remain identical to specifications when downlink carrier aggregation is inactive on the PCC. For every supported combination of downlink only carrier aggregation, additional conducted output Powers are measured with downlink carrier aggregation active for the configuration with highest measured maximum conducted power with the downlink carrier aggregation inactive measured among the channel bandwidth, modulation and RB combinations in each frequency band. Per FCC KDB Publication 941225 D05Av01r02, no SAR measurements are required for carrier aggregation configurations when the average output power with downlink only carrier aggregation active is not more than 0.25dB higher than the average output power with downlink only carrier aggregation inactive.

8.6 SAR Testing with 802.11 Transmitters

The normal network operating configurations of 802.11 transmitters are not suitable for SAR measurements. Unpredictable fluctuations in network traffic and antenna diversity conditions can introduce undesirable variations in SAR results. The SAR for these devices should be measured using chipset based test mode software to ensure the results are consistent and reliable. See KDB Publication 248227 D01v02r02 for more details.

8.6.1 General Device Setup

Chipset based test mode software is hardware dependent and generally varies among manufacturers. The device operating parameters established in test mode for SAR measurements must be identical to those programmed in production units, including output power levels, amplifier gain settings and other RF performance tuning parameters.

A periodic duty factor is required for current generation SAR system to measure SAR. When 802.11 frame gaps are accounted for in the transmission, a maximum transmission duty factor of 92-96% is typically achievable in most test mode configurations. A minimum transmission duty factor of 85% is required to avoid certain hardware and device implementation issues related to wide range SAR scaling. The reported SAR is scaled to 100% transmission duty factor to determine compliance at the maximum tune-up tolerance limit.

8.6.2 Initial Test Position Procedure

For exposure conditions with multiple test positions, such as handset operating next to the ear, devices with hotspot mode or UMPC mini-tablet, procedures for initial test position can be applied. Using the transmission mode determined by the DSSS procedure or initial test configuration, area scans are measured for all positions in an exposure condition. The test position with the highest extrapolated (peak) SAR is used as the initial test position. When reported SAR for the initial test position is ≤ 0.4 W/kg for 1g SAR and ≤ 1.0 W/kg for 10g SAR, no additional testing for the remaining test position is required. Otherwise, SAR is evaluated at the subsequent highest peak SAR positions until the reported SAR result is ≤ 0.8 W/kg for 1g SAR and ≤ 2.0 W/kg for 10g SAR or all test positions are measured.

8.6.3 2.4 GHz SAR test Requirements

SAR is measured for 2.4 GHz 802.11b DSSS using either the fixed test position or, when applicable, the initial test position procedure. SAR test reduction is determined according to the following:

- 1) When the reported SAR of the highest measured maximum output power channel for the exposure configuration is ≤ 0.8 W/kg, no further SAR testing is required for 802.11b DSSS in that exposure configuration.
- 2) When the reported SAR is > 0.8 W/kg, SAR is required for that position using the next highest measured output power channel. When any reported SAR is > 1.2 W/kg, SAR is required for the third channel; i.e., all channels require testing.

2.4 GHz 802.11 g/n OFDM are additionally evaluated for SAR if the highest reported SAR for 802.11b, adjusted by the ratio of the OFDM to DSSS specified maximum output power, is > 1.2 W/kg. When SAR is required for OFDM modes in 2.4 GHz band, the Initial Test Configuration Procedures should be followed.

8.6.4 OFDM Transmission Mode and SAR Test Channel Selection

For the 2.4 GHz, when the same maximum output power was specified for multiple OFDM transmission mode configurations in a frequency band or aggregated band, SAR is measured using the configuration with the largest channel bandwidth, lowest order modulation and lowest data rate and lowest order 802.11 g/n mode. When the maximum output power of a channel is the same for equivalent OFDM configurations; for example, 802.11g and 802.11n with the same channel bandwidth, modulation and data rate etc., the lower order 802.11 mode i.e., 802.11g then 802.11n, is used for SAR measurement. When the maximum output power are the same for multiple test channels, either according to the default or additional power measurement requirements, SAR is measured using the channel closest to the middle of the frequency band or aggregated band. When there are multiple channels with the same maximum output power, SAR is measured using the higher number channel.

8.6.5 Initial Test Configuration Procedure

For OFDM, in both 2.4 GHz, an initial test configuration is determined for each frequency band and aggregated band, according to the transmission mode with the highest maximum output power specified for SAR measurements. When the same maximum output power is specified for multiple OFDM transmission mode configurations in a frequency band or aggregated band, SAR is measured using the configuration(s) with the largest channel bandwidth, lowest order modulation, and lowest data rate. If the average RF output powers of the highest identical transmission modes are within 0.25 dB of each other, the channel of the transmission mode with highest average RF output power is the initial test channel. Otherwise, the channel of the transmission mode with the highest average RF output conducted power will be the initial test configuration.

When the reported SAR is ≤ 0.8 W/kg, no additional measurements on other test channels are required. Otherwise, SAR is evaluated using the subsequent highest average RF output channel until the reported SAR result is 1.2 W/kg or all channels are measured. When there are multiple untested channels having the same subsequent highest average RF output power, the channel with higher frequency from the lowest 802.11 mode is considered for SAR measurements.

8.6.6 Subsequent Test Configuration Procedures

For OFDM configurations in each frequency band and aggregated band, SAR is evaluated for initial test configuration using the fixed test position or the initial test position on procedure. When the highest reported SAR (for the initial test configuration), adjusted by the ratio of the specified maximum output power of the subsequent test configuration to initial test configuration, is ≤ 1.2 W/kg for 1g SAR and ≤ 3.0 W/kg for 10g SAR, no additional SAR tests for the subsequent test configurations are required.

9. Output Power Specifications

This device operates using the following maximum output power specifications. SAR values were scaled to the maximum allowed power to determine compliance per KDB publication 447498 D01v06.

9.1 GSM

GSM Conducted output powers (Burst-Average)

Band	Channel	Voice	GPRS(GMSK) Data – CS1				EDGE Data			
		GSM (dBm)	GPRS 1 TX Slot (dBm)	GPRS 2 TX Slot (dBm)	GPRS 3 TX Slot (dBm)	GPRS 4 TX Slot (dBm)	EDGE 1 TX Slot (dBm)	EDGE 2 TX Slot (dBm)	EDGE 3 TX Slot (dBm)	EDGE 4 TX Slot (dBm)
Maximum Tune-up		33.70	33.70	30.70	28.70	28.20	26.20	25.70	25.70	24.70
Nominal Tune-up		33.20	33.20	30.20	28.20	27.70	25.70	25.20	25.20	24.20
GSM 850	128	33.34	33.38	30.25	28.22	27.99	25.98	25.20	25.41	24.41
	190	33.47	33.47	30.42	28.31	28.12	26.09	25.35	25.42	24.45
	251	33.60	33.58	30.63	28.52	28.16	26.19	25.54	25.62	24.65
Maximum Tune-up		30.70	30.70	28.70	26.70	26.70	25.70	25.20	25.20	24.70
Nominal Tune-up		30.20	30.20	28.20	26.20	26.20	25.20	24.70	24.70	24.20
GSM 1900	512	30.47	30.48	28.69	26.44	26.29	25.63	25.09	24.95	24.67
	661	30.30	30.28	28.56	26.57	26.43	25.57	25.07	24.84	24.65
	810	30.20	30.20	28.69	26.54	26.32	25.67	25.19	24.93	24.69

GSM Conducted output powers (Frame-Average)

Band	Channel	Voice	GPRS(GMSK) Data – CS1				EDGE Data			
		GSM (dBm)	GPRS 1 TX Slot (dBm)	GPRS 2 TX Slot (dBm)	GPRS 3 TX Slot (dBm)	GPRS 4 TX Slot (dBm)	EDGE 1 TX Slot (dBm)	EDGE 2 TX Slot (dBm)	EDGE 3 TX Slot (dBm)	EDGE 4 TX Slot (dBm)
Maximum Tune-up		24.67	24.67	24.68	24.44	25.19	17.17	19.68	21.44	21.69
Nominal Tune-up		24.17	24.17	24.18	23.94	24.69	16.67	19.18	20.94	21.19
GSM 850	128	24.31	24.35	24.23	23.96	24.98	16.95	19.18	21.15	21.40
	190	24.44	24.44	24.40	24.05	25.11	17.06	19.33	21.16	21.44
	251	24.57	24.55	24.61	24.26	25.15	17.16	19.52	21.36	21.64
Maximum Tune-up		21.67	21.67	22.68	22.44	23.69	16.67	19.18	20.94	21.69
Nominal Tune-up		21.17	21.17	22.18	21.94	23.19	16.17	18.68	20.44	21.19
GSM 1900	512	21.44	21.45	22.67	22.18	23.28	16.60	19.07	20.69	21.66
	661	21.27	21.25	22.54	22.31	23.42	16.54	19.05	20.58	21.64
	810	21.17	21.17	22.67	22.28	23.31	16.64	19.17	20.67	21.68

Note:

Time slot average factor is as follows:

1 Tx slot = 9.03 dB, Frame-Average output power = Burst-Average output power – 9.03 dB

2 Tx slot = 6.02 dB, Frame-Average output power = Burst-Average output power – 6.02 dB

3 Tx slot = 4.26 dB, Frame-Average output power = Burst-Average output power – 4.26 dB

4 Tx slot = 3.01 dB, Frame-Average output power = Burst-Average output power – 3.01 dB

GSM Class: B

GSM voice/GPRS VOIP: Head SAR, Body worn SAR

GPRS/EDGE Multi-slots 33: Hotspot SAR with GPRS/EDGE

Multi-slot Class 33 with CS 1 (GMSK)



9.2 UMTS

9.2.1 WCDMA Band 5

3GPP Release Version	Mode	3GPP 34.121 Subtest	WCDMA Band 5 [dBm]		
			UL 4132 DL 4357	UL 4183 DL 4408	UL 4233 DL 4458
99	WCDMA	12.2 kbps RMC	25.00	24.92	25.04
99	WCDMA	12.2 kbps AMR	25.00	24.91	25.04
5	HSDPA	Subtest 1	24.79	24.81	24.86
5		Subtest 2	24.73	24.72	24.80
5		Subtest 3	24.30	24.23	24.33
5		Subtest 4	24.29	24.21	24.33
6	HSUPA	Subtest 1	23.97	24.07	23.78
6		Subtest 2	22.94	22.86	22.85
6		Subtest 3	24.01	23.92	23.84
6		Subtest 4	22.92	22.88	22.89
6		Subtest 5	23.86	24.00	23.70
8	DC-HSDPA	Subtest 1	24.62	24.61	24.64
8		Subtest 2	24.60	24.58	24.48
8		Subtest 3	24.16	24.11	24.10
8		Subtest 4	24.16	24.10	24.09

WCDMA Average Conducted output powers

9.2.2 WCDMA Band 2

3GPP Release Version	Mode	3GPP 34.121 Subtest	WCDMA Band 2 [dBm]		
			UL 9262 DL 9662	UL 9400 DL 9800	UL 9538 DL 9938
99	WCDMA	12.2 kbps RMC	23.51	23.35	23.46
99	WCDMA	12.2 kbps AMR	23.53	23.36	23.45
5	HSDPA	Subtest 1	23.51	23.32	23.47
5		Subtest 2	23.53	23.34	23.48
5		Subtest 3	22.97	22.90	22.99
5		Subtest 4	22.95	22.91	22.98
6	HSUPA	Subtest 1	22.41	22.70	22.67
6		Subtest 2	21.35	21.28	21.40
6		Subtest 3	22.34	22.30	22.37
6		Subtest 4	21.32	21.29	21.46
6		Subtest 5	23.22	22.40	22.68
8	DC-HSDPA	Subtest 1	23.50	23.53	23.33
8		Subtest 2	23.49	23.50	23.34
8		Subtest 3	22.95	23.12	22.97
8		Subtest 4	22.95	23.13	22.98

WCDMA Average Conducted output powers

9.3 LTE

9.3.1 LTE Band 2 Maximum Conducted Power

Bandwidth	Modulation	RB Size	RB Offset	Max. Average Power (dBm)			MPR Allowed Per 3GPP	MPR
				18607	18900	19193		
				1850.7 MHz	1880 MHz	1909.3 MHz	[dB]	[dB]
1.4 MHz	QPSK	1	0	22.85	23.21	23.15	0	0
		1	3	22.91	23.59	23.04	0	0
		1	5	22.83	23.30	23.12	0	0
		3	0	23.02	22.06	22.11	0	0
		3	1	23.03	22.02	22.10	0	0
		3	3	23.05	22.14	22.22	0	0
	16QAM	6	0	22.08	22.10	22.11	0-1	1
		1	0	21.99	22.73	21.81	0-1	1
		1	3	22.06	22.99	22.10	0-1	1
		1	5	21.98	22.80	21.76	0-1	1
		3	0	22.19	21.13	21.12	0-1	1
		3	1	22.10	21.09	21.15	0-1	1
		3	3	22.21	21.10	20.98	0-1	1
		6	0	21.02	20.94	20.95	0-2	2

Bandwidth	Modulation	RB Size	RB Offset	Max. Average Power (dBm)			MPR Allowed Per 3GPP	MPR
				18615	18900	19185		
				1851.5 MHz	1880 MHz	1908.5 MHz	[dB]	[dB]
3 MHz	QPSK	1	0	23.21	23.15	22.92	0	0
		1	7	23.59	23.04	23.29	0	0
		1	14	23.30	23.12	23.15	0	0
		8	0	22.06	22.11	22.01	0-1	1
		8	3	22.02	22.10	22.01	0-1	1
		8	7	22.14	22.22	22.00	0-1	1
		15	0	22.10	22.11	21.97	0-1	1
	16QAM	1	0	22.73	21.81	22.12	0-1	1
		1	7	22.99	22.10	22.49	0-1	1
		1	14	22.80	21.76	22.19	0-1	1
		8	0	21.13	21.12	20.90	0-2	2
		8	3	21.09	21.15	20.94	0-2	2
		8	7	21.10	20.98	20.99	0-2	2
		15	0	20.94	20.95	21.14	0-2	2

Bandwidth	Modulation	RB Size	RB Offset	Max. Average Power (dBm)			MPR Allowed Per 3GPP	MPR
				18625	18900	19175		
				1852.5 MHz	1880 MHz	1907.5 MHz	[dB]	[dB]
5 MHz	QPSK	1	0	22.91	22.92	23.00	0	0
		1	12	23.32	23.52	23.21	0	0
		1	24	22.96	22.85	23.03	0	0
		12	0	22.14	22.17	21.94	0-1	1
		12	6	22.12	22.09	21.98	0-1	1
		12	11	22.14	22.09	21.97	0-1	1
		25	0	22.09	22.10	21.96	0-1	1
	16QAM	1	0	21.80	21.76	22.10	0-1	1
		1	12	21.97	21.70	22.19	0-1	1
		1	24	21.74	21.36	21.35	0-1	1
		12	0	20.92	20.95	20.97	0-2	2
		12	6	20.81	20.80	20.95	0-2	2
		12	11	20.91	20.76	21.07	0-2	2
		25	0	21.12	21.07	20.95	0-2	2

Bandwidth	Modulation	RB Size	RB Offset	Max. Average Power (dBm)			MPR Allowed Per 3GPP	MPR
				18650	18900	19150		
				1855 MHz	1880 MHz	1905 MHz	[dB]	[dB]
10 MHz	QPSK	1	0	23.39	23.22	23.02	0	0
		1	24	23.43	23.24	23.18	0	0
		1	49	23.42	23.08	23.18	0	0
		25	0	22.20	22.13	22.07	0-1	1
		25	12	22.15	22.15	21.94	0-1	1
		25	24	22.15	22.04	21.96	0-1	1
		50	0	22.16	22.05	22.01	0-1	1
	16QAM	1	0	22.43	21.98	22.45	0-1	1
		1	24	23.03	21.91	22.41	0-1	1
		1	49	22.48	21.74	21.84	0-1	1
		25	0	21.18	21.10	20.90	0-2	2
		25	12	21.07	21.13	21.11	0-2	2
		25	24	21.08	21.10	20.96	0-2	2
		50	0	20.98	20.95	20.93	0-2	2

Bandwidth	Modulation	RB Size	RB Offset	Max. Average Power (dBm)			MPR Allowed Per 3GPP	MPR
				18675	18900	19125		
				1857.5 MHz	1880 MHz	1902.5 MHz	[dB]	[dB]
15 MHz	QPSK	1	0	23.33	22.98	23.03	0	0
		1	36	23.53	23.08	23.05	0	0
		1	74	23.31	23.04	23.09	0	0
		36	0	22.2	22.11	22.12	0-1	1
		36	18	22.16	22.03	22.02	0-1	1
		36	38	22.05	22.04	21.86	0-1	1
		75	0	22.17	21.98	21.98	0-1	1
	16QAM	1	0	22.54	21.91	22.15	0-1	1
		1	36	23.03	21.90	22.07	0-1	1
		1	74	22.45	21.45	22.72	0-1	1
		36	0	21.06	21.06	21.18	0-2	2
		36	18	21.17	21.01	21.10	0-2	2
		36	38	21.00	21.03	20.77	0-2	2
		75	0	21.07	21.00	20.93	0-2	2

Bandwidth	Modulation	RB Size	RB Offset	Max. Average Power (dBm)			MPR Allowed Per 3GPP	MPR
				18700	18900	19100		
				1860 MHz	1880 MHz	1900 MHz	[dB]	[dB]
20 MHz	QPSK	1	0	23.25	23.12	23.21	0	0
		1	49	23.28	23.40	23.53	0	0
		1	99	23.04	23.04	23.24	0	0
		50	0	22.26	22.17	22.05	0-1	1
		50	25	22.17	22.04	21.97	0-1	1
		50	49	22.15	22.04	22.04	0-1	1
		100	0	22.18	22.02	21.93	0-1	1
	16QAM	1	0	22.10	21.90	21.81	0-1	1
		1	49	22.08	22.07	21.73	0-1	1
		1	99	21.85	21.31	21.20	0-1	1
		50	0	21.16	21.09	21.00	0-2	2
		50	25	21.04	20.99	20.84	0-2	2
		50	49	21.04	21.11	21.05	0-2	2
		100	0	21.09	20.96	20.91	0-2	2

9.3.2 LTE Band 7 Maximum Conducted Power

Bandwidth	Modulation	RB Size	RB Offset	Max. Average Power (dBm)			MPR Allowed Per 3GPP	MPR
				20775	21100	21425		
				2502.5MHz	2535MHz	2567.5MHz	[dB]	[dB]
5 MHz	QPSK	1	0	23.49	23.52	23.65	0	0
		1	12	23.83	23.88	23.54	0	0
		1	24	23.34	23.57	23.36	0	0
		12	0	22.61	22.53	22.47	0-1	1
		12	6	22.57	22.53	22.50	0-1	1
		12	11	22.60	22.62	22.48	0-1	1
		25	0	22.55	22.55	22.40	0-1	1
	16QAM	1	0	22.24	22.52	22.10	0-1	1
		1	12	22.62	22.50	22.32	0-1	1
		1	24	22.32	22.02	22.03	0-1	1
		12	0	21.47	21.67	21.30	0-2	2
		12	6	21.44	21.68	21.35	0-2	2
		12	11	21.40	21.54	21.51	0-2	2
		25	0	21.69	21.57	21.55	0-2	2

Bandwidth	Modulation	RB Size	RB Offset	Max. Average Power (dBm)			MPR Allowed Per 3GPP	MPR
				20800	21100	21400		
				2505MHz	2535MHz	2565MHz	[dB]	[dB]
10 MHz	QPSK	1	0	23.65	23.67	23.58	0	0
		1	24	23.94	23.62	23.51	0	0
		1	49	23.66	23.54	23.40	0	0
		25	0	22.65	22.57	22.60	0-1	1
		25	12	22.62	22.54	22.57	0-1	1
		25	24	22.57	22.50	22.53	0-1	1
		50	0	22.56	22.51	22.57	0-1	1
	16QAM	1	0	22.83	22.47	22.95	0-1	1
		1	24	23.43	22.32	22.91	0-1	1
		1	49	22.79	22.29	22.82	0-1	1
		25	0	21.59	21.83	21.81	0-2	2
		25	12	21.64	21.74	21.53	0-2	2
		25	24	21.52	21.85	21.63	0-2	2
		50	0	21.60	21.62	21.55	0-2	2

Bandwidth	Modulation	RB Size	RB Offset	Max. Average Power (dBm)			MPR Allowed Per 3GPP	MPR
				20825	21100	21375	[dB]	[dB]
				2507.5MHz	2535MHz	2562.5MHz		
15 MHz	QPSK	1	0	24.19	23.57	23.49	0	0
		1	36	24.03	23.47	23.55	0	0
		1	74	23.65	23.19	23.33	0	0
		36	0	22.65	22.58	22.54	0-1	1
		36	18	22.64	22.52	22.54	0-1	1
		36	38	22.63	22.48	22.53	0-1	1
		75	0	22.51	22.47	22.55	0-1	1
	16QAM	1	0	23.11	22.45	22.93	0-1	1
		1	36	23.40	22.32	22.88	0-1	1
		1	74	23.04	22.09	22.59	0-1	1
		36	0	21.62	21.52	21.65	0-2	2
		36	18	21.55	21.46	21.57	0-2	2
		36	38	21.46	21.47	21.40	0-2	2
		75	0	21.62	21.49	21.57	0-2	2

Bandwidth	Modulation	RB Size	RB Offset	Max. Average Power (dBm)			MPR Allowed Per 3GPP	MPR
				20850	21100	21350	[dB]	[dB]
				2510MHz	2535MHz	2560MHz		
20 MHz	QPSK	1	0	23.73	23.62	23.69	0	0
		1	49	23.87	23.92	23.80	0	0
		1	99	23.84	23.47	23.51	0	0
		50	0	22.63	22.62	22.45	0-1	1
		50	25	22.63	22.58	22.48	0-1	1
		50	49	22.67	22.53	22.40	0-1	1
		100	0	22.61	22.57	22.47	0-1	1
	16QAM	1	0	22.04	22.46	22.30	0-1	1
		1	49	22.52	22.39	22.36	0-1	1
		1	99	21.84	21.84	22.19	0-1	1
		50	0	21.67	21.53	21.51	0-2	2
		50	25	21.54	21.50	21.58	0-2	2
		50	49	21.63	21.47	21.57	0-2	2
		100	0	21.58	21.52	21.48	0-2	2

9.3.3 LTE Band 17 Maximum Conducted Power

Bandwidth	Modulation	RB Size	RB Offset	Max. Average Power (dBm)		MPR Allowed Per 3GPP	MPR
				23790		[dB]	[dB]
				710 MHz			
5 MHz	QPSK	1	0	24.91		0	0
		1	12	25.16		0	0
		1	24	24.96		0	0
		12	0	23.90		0-1	1
		12	6	23.85		0-1	1
		12	11	23.89		0-1	1
	16QAM	25	0	23.92		0-1	1
		1	0	23.45		0-1	1
		1	12	23.50		0-1	1
		1	24	23.43		0-1	1
		12	0	22.85		0-2	2
		12	6	22.71		0-2	2
		12	11	22.77		0-2	2
		25	0	22.99		0-2	2

Bandwidth	Modulation	RB Size	RB Offset	Max. Average Power (dBm)		MPR Allowed Per 3GPP	MPR
				23790		[dB]	[dB]
				710 MHz			
10 MHz	QPSK	1	0	24.96		0	0
		1	24	25.12		0	0
		1	49	25.08		0	0
		25	0	23.89		0-1	1
		25	12	23.98		0-1	1
		25	24	23.92		0-1	1
	16QAM	50	0	23.95		0-1	1
		1	0	23.65		0-1	1
		1	24	23.50		0-1	1
		1	49	23.37		0-1	1
		25	0	23.00		0-2	2
		25	12	23.04		0-2	2
		25	24	22.99		0-2	2
		50	0	23.10		0-2	2

Note: LTE Band 17 at 5 MHz & 10 MHz Bandwidth does not support three non-overlapping channels. Per KDB 941225 D05v02r05, when a device supports overlapping channel assignment in a channel bandwidth configuration, the mid channel of the group of overlapping channels should be selected for testing.

9.3.4 LTE Down-link Carrier Aggregation Conducted Powers

Intra-band Continuous Downlik CA (CA_7C)															
PCC									SCC				Tx Power		
Band	BW	Modulation	RB	offset	PCC(UL) channel	PCC(UL) Frequency	PCC(DL) channel	PCC(DL) Frequency	Band	BW	SCC(DL) channel	SCC(DL) Frequency	Rel 8	Rel 10	
7	15	QPSK	1	0	20825	2507.5	2825	2627.5	7	15	2975	2642.5	24.19	24.11	
Intra-band Non-continuous Downlik CA (CA_7A-7A)															
PCC									SCC				Tx Power		
Band	BW	Modulation	RB	offset	PCC(UL) channel	PCC(UL) Frequency	PCC(DL) channel	PCC(DL) Frequency	Band	BW	SCC(DL) channel	SCC(DL) Frequency	Rel 8	Rel 10	
7	15	QPSK	1	0	20825	2507.5	2825	2627.5	7	15	3375	2682.5	24.19	24.13	

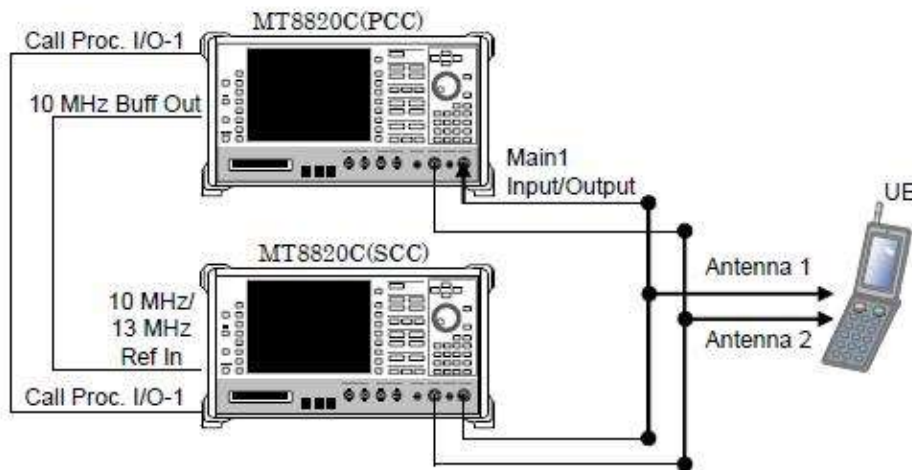

Power Measurement setup

Notes:

1. **This device only supports downlink intra-band Carrier Aggregation.** Downlink Inter-band Carrier Aggregation and Uplink Carrier Aggregation are not supported. For every supported combination of downlink carrier aggregation, power measurements were performed with the downlink carrier aggregation active for the configuration with highest measured maximum conducted power with downlink carrier aggregation inactive measured among the channel bandwidth, modulation and RB combinations in each frequency band.
- 2.. All control and acknowledge data is sent on uplink channels that operate identical to specifications when downlink carrier aggregation is inactive

9.4 WiFi

IEEE 802.11 Average RF Power

Mode	Freq.	Channel	IEEE 802.11 (2.4 GHz) Conducted Power
	[MHz]		[dBm]
802.11b	2412	1	15.55
	2417	2	16.32
	2437	6	16.40
	2457	10	16.39
	2462	11	15.53
802.11g	2412	1	14.35
	2417	2	15.32
	2437	6	15.41
	2457	10	15.40
	2462	11	14.48
802.11n (HT20)	2412	1	13.53
	2417	2	14.43
	2437	6	14.39
	2457	10	14.47
	2462	11	13.49

Justification for test configurations for WLAN per KDB Publication 248227 D01v02r02:

- Power measurements were performed for the transmission mode configuration with the highest maximum output power specified for production units.
- For transmission mode with the same maximum output power specification, powers were measured for the largest channel bandwidth, lowest order modulation and lowest data rate.
- For transmission modes with identical maximum specified output power, channel bandwidth, modulation and data rates, power measurements were required for all identical configurations.
- For each transmission mode configuration, powers were measured for the highest and lowest channels; and at the mid-band channel(s) when there were at least 3 channels supported. For configurations with multiple mid-band channels, due to an even number of channels, both channels were measured.

Test Configuration

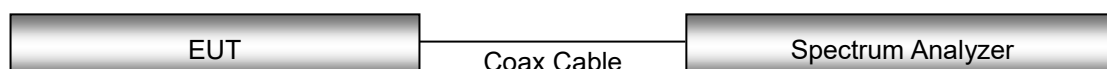

9.5 BT

Averaged-conducted Power

Mode	Channel	BT Power
		[dBm]
DH5	0	9.88
	39	10.80
	78	9.65
2-DH5	0	9.22
	39	10.18
	78	9.00
3-DH5	0	9.21
	39	10.19
	78	9.00

Per October 2016 TCB Workshop Notes:

When call box and Bluetooth protocol are used for BT SAR measurement, time-domain plot is required to identify duty factor for supporting the test setup and result.

Bluetooth duty cycle was measured using Bluetooth tester equipment (CBT / R&S) with Bluetooth protocol. DH5 mode is the highest duty cycle and conducted power. SAR test were performed at DH5 mode.



Duty Cycle

$$= (\text{BT-On time} / \text{BT-Full time}) = (2.864 / 3.748) * 100 = 0.764 (\text{DH5})$$

Duty factor = 1 / Duty cycle : 1.308

10. SYSTEM VERIFICATION

10.1 Tissue Verification

The Head /Body simulating material is calibrated by HCT using the DAKS 3.5 to determine the conductivity and permittivity.

Table for Head Tissue Verification

Date of Tests	Tissue Temp. (°C)	Tissue Type	Freq. (MHz)	Measured Conductivity σ (S/m)	Measured Dielectric Constant, ϵ	Target Conductivity σ (S/m)	Target Dielectric Constant, ϵ	% dev σ	% dev ϵ
05/23/2017	22.1	750H	705	0.851	41.900	0.889	42.175	-4.27%	-0.65%
			710	0.854	41.808	0.89	42.149	-4.04%	-0.81%
			750	0.890	41.300	0.893	41.94	-0.34%	-1.53%
05/30/2017	20.9	835H	820	0.897	42.192	0.899	41.578	-0.22%	1.48%
			835	0.913	42.000	0.900	41.500	1.44%	1.20%
			850	0.928	41.718	0.916	41.500	1.31%	0.53%
05/26/2017	20.5	1900H	1850	1.365	39.993	1.400	40.000	-2.50%	-0.02%
			1900	1.410	39.841	1.400	40.000	0.71%	-0.40%
			1910	1.417	39.842	1.400	40.000	1.21%	-0.40%
05/26/2017	21.2	2450H	2400	1.791	38.762	1.756	39.290	1.99%	-1.34%
			2450	1.847	38.559	1.800	39.200	2.61%	-1.64%
			2500	1.907	38.390	1.855	39.140	2.80%	-1.92%
06/07/2017	20.1	2450H	2400	1.772	38.999	1.756	39.290	0.91%	-0.74%
			2450	1.826	38.641	1.800	39.200	1.44%	-1.43%
			2500	1.891	38.312	1.855	39.140	1.94%	-2.12%
06/01/2017	20.5	2600H	2500	1.899	38.773	1.855	39.140	2.37%	-0.94%
			2600	1.997	38.432	1.964	39.010	1.68%	-1.48%
			2700	2.121	37.964	2.073	38.880	2.32%	-2.36%

Table for Body Tissue Verification

Date of Tests	Tissue Temp. (°C)	Tissue Type	Freq. (MHz)	Measured Conductivity σ (S/m)	Measured Dielectric Constant, ϵ	Target Conductivity σ (S/m)	Target Dielectric Constant, ϵ	% dev σ	% dev ϵ
05/18/2017	21.7	750B	705	0.914	56.000	0.961	55.710	-4.89%	0.52%
			710	0.916	55.903	0.961	55.690	-4.68%	0.38%
			750	0.954	55.500	0.963	55.530	-0.93%	-0.05%
05/31/2017	22.5	835B	820	0.940	56.578	0.969	55.258	-2.99%	2.39%
			835	0.954	56.400	0.970	55.200	-1.65%	2.17%
			850	0.974	56.234	0.988	55.154	-1.42%	1.96%
05/30/2017	21.5	1900B	1850	1.524	52.843	1.520	53.300	0.26%	-0.86%
			1900	1.570	52.708	1.520	53.300	3.29%	-1.11%
			1910	1.577	52.700	1.520	53.300	3.75%	-1.13%
05/26/2017	21.2	2450B	2400	1.882	52.630	1.902	52.770	-1.05%	-0.27%
			2450	1.934	52.398	1.950	52.700	-0.82%	-0.57%
			2500	1.995	52.357	2.021	52.640	-1.29%	-0.54%
05/31/2017	22.5	2600B	2500	2.050	51.318	2.021	52.640	1.43%	-2.51%
			2600	2.160	51.000	2.163	52.510	-0.14%	-2.88%
			2700	2.298	50.619	2.305	52.380	-0.30%	-3.36%

10.2 System Verification

Prior to assessment, the system is verified to the $\pm 10\%$ of the specifications at 750MHz / 835 MHz / 1 900 MHz / 2 450 MHz / 2 600 MHz by using the system Verification kit. (Graphic Plots Attached)

System Verification Results

Freq.	Date	Probe (S/N)	Dipole (S/N)	Liquid	Amb. Temp.	Liquid Temp.	1 W Target SAR _{1g} (SPEAG)	Measured SAR _{1g}	1 W Normalized SAR _{1g}	Deviation	Limit [%]
[MHz]					[°C]	[°C]	[W/kg]	[W/kg]	[W/kg]	[%]	[%]
750	05/23/2017	1630	1014	Head	22.4	22.1	8.29	0.869	8.69	+ 4.83	± 10
750	05/18/2017	1630		Body	21.9	21.7	8.74	0.913	9.13	+ 4.46	± 10
835	05/30/2017	1630	441	Head	21.1	20.9	9.38	0.972	9.72	+ 3.62	± 10
835	05/31/2017	1630		Body	22.7	22.5	9.62	0.980	9.80	+ 1.87	± 10
1 900	05/26/2017	1605	5d032	Head	20.7	20.5	40.0	4.11	41.1	+ 2.75	± 10
1 900	05/30/2017	3797		Body	21.7	21.5	40.5	3.97	39.7	- 1.98	± 10
2 450	05/26/2017	3797	743	Head	21.4	21.2	53.0	5.31	53.1	+ 0.19	± 10
2 450	06/07/2017	3797		Head	20.3	20.1	53.0	5.18	51.8	- 2.26	± 10
2 450	05/26/2017	3797		Body	21.4	21.2	50.6	4.74	47.4	- 6.32	± 10
2 600	06/01/2017	3797	1015	Head	20.7	20.5	57.5	6.03	60.3	+ 4.87	± 10
2 600	05/31/2017	7370		Body	22.7	22.5	55.1	5.06	50.6	- 8.17	± 10

10.3 System Verification Procedure

SAR measurement was prior to assessment, the system is verified to the $\pm 10\%$ of the specifications at each frequency band by using the system Verification kit. (Graphic Plots Attached)

- Cabling the system, using the Verification kit equipments.
- Generate about 100 mW Input Level from the Signal generator to the Dipole Antenna.
- Dipole Antenna was placed below the Flat phantom.
- The measured one-gram SAR at the surface of the phantom above the dipole feed-point should be within 10 % of the target reference value.
- The results are normalized to 1 W input power.

NOTE;

SAR Verification was performed according to the FCC KDB 865664 D01v01r04.

11. SAR TEST DATA SUMMARY

11.1 HEAD SAR Measurement Results

GSM 850 Head SAR											
Frequency		Mode	Tune-Up Limit	Meas. Power	Power Drift	Test Position	Duty Cycle	Meas. SAR	Scaling Factor	Scaled SAR	Plot No.
MHz	Ch.		(dB)	(dB)	(dB)			(W/kg)		(W/kg)	
836.6	190	GSM	33.7	33.47	-0.05	Left Cheek	1:8.3	0.071	1.054	0.075	1
836.6	190	GSM	33.7	33.47	-0.07	Left Tilt	1:8.3	0.029	1.054	0.031	-
836.6	190	GSM	33.7	33.47	-0.15	Right Cheek	1:8.3	0.043	1.054	0.045	-
836.6	190	GSM	33.7	33.47	-0.02	Right Tilt	1:8.3	0.027	1.054	0.028	-
836.6	190	GPRS 4Tx	28.2	28.12	0.04	Left Cheek	1:2.075	0.136	1.019	0.139	2
836.6	190	GPRS 4Tx	28.2	28.12	0.11	Left Tilt	1:2.075	0.057	1.019	0.058	-
836.6	190	GPRS 4Tx	28.2	28.12	0.04	Right Cheek	1:2.075	0.090	1.019	0.092	-
836.6	190	GPRS 4Tx	28.2	28.12	0.08	Right Tilt	1:2.075	0.056	1.019	0.057	-
ANSI/ IEEE C95.1 - 1992– Safety Limit Spatial Peak Uncontrolled Exposure/ General Population						Head 1.6 W/kg Averaged over 1 gram					

GSM 1900 Head SAR											
Frequency		Mode	Tune-Up Limit	Meas. Power	Power Drift	Test Position	Duty Cycle	Meas. SAR	Scaling Factor	Scaled SAR	Plot No.
MHz	Ch.		(dB)	(dB)	(dB)			(W/kg)		(W/kg)	
1 880	661	GSM	30.7	30.30	0.02	Left Cheek	1:8.3	0.079	1.096	0.087	3
1 880	661	GSM	30.7	30.30	0.09	Left Tilt	1:8.3	0.041	1.096	0.045	-
1 880	661	GSM	30.7	30.30	0.02	Right Cheek	1:8.3	0.078	1.096	0.085	-
1 880	661	GSM	30.7	30.30	-0.14	Right Tilt	1:8.3	0.044	1.096	0.048	-
1 880	661	GPRS 4Tx	26.7	26.43	0.09	Left Cheek	1:2.075	0.147	1.064	0.156	-
1 880	661	GPRS 4Tx	26.7	26.43	0.16	Left Tilt	1:2.075	0.079	1.064	0.084	-
1 880	661	GPRS 4Tx	26.7	26.43	0.09	Right Cheek	1:2.075	0.149	1.064	0.159	4
1 880	661	GPRS 4Tx	26.7	26.43	-0.01	Right Tilt	1:2.075	0.090	1.064	0.096	-
ANSI/ IEEE C95.1 - 1992– Safety Limit Spatial Peak Uncontrolled Exposure/ General Population						Head 1.6 W/kg Averaged over 1 gram					

UMTS 850 Head SAR											
Frequency		Mode	Tune-Up Limit	Meas. Power	Power Drift	Test Position	Duty Cycle	Meas. SAR	Scaling Factor	Scaled SAR	Plot No.
MHz	Ch.		(dB)	(dB)	(dB)			(W/kg)		(W/kg)	
836.6	4183	RMC	25.2	24.92	0.042	Left Cheek	1:1	0.223	1.067	0.238	5
836.6	4183	RMC	25.2	24.92	0.041	Left Tilt	1:1	0.097	1.067	0.103	-
836.6	4183	RMC	25.2	24.92	0.030	Right Cheek	1:1	0.160	1.067	0.171	-
836.6	4183	RMC	25.2	24.92	0.040	Right Tilt	1:1	0.099	1.067	0.106	-
ANSI/ IEEE C95.1 - 1992– Safety Limit Spatial Peak Uncontrolled Exposure/ General Population						Head 1.6 W/kg Averaged over 1 gram					

UMTS 1900 Head SAR											
Frequency		Mode	Tune-Up Limit	Meas. Power	Power Drift	Test Position	Duty Cycle	Meas. SAR	Scaling Factor	Scaled SAR	Plot No.
MHz	Ch.		(dB)	(dB)	(dB)			(W/kg)		(W/kg)	
1 880	9400	RMC	23.7	23.35	0.00	Left Cheek	1:1	0.190	1.084	0.206	6
1 880	9400	RMC	23.7	23.35	0.17	Left Tilt	1:1	0.082	1.084	0.089	-
1 880	9400	RMC	23.7	23.35	0.08	Right Cheek	1:1	0.145	1.084	0.157	-
1 880	9400	RMC	23.7	23.35	0.06	Right Tilt	1:1	0.078	1.084	0.085	-
ANSI/ IEEE C95.1 - 1992 – Safety Limit Spatial Peak Uncontrolled Exposure/ General Population						Head 1.6 W/kg (mW/g) Averaged over 1 gram					

LTE Band 2 (PCS) Head SAR															
Frequency		Mode	Band width	Tune-up Limit	Meas. Power	Power Drift	Test Position	MPR	RB Size	RB offset	Duty Cycle	Meas. SAR	Scaling Factor	Scaled SAR	Plot No.
MHz	Ch.														
1 900	19100	QPSK	20	23.7	23.53	0.09	Left Cheek	0	1	49	1:1	0.169	1.040	0.176	7
1 860	18700	QPSK	20	22.7	22.26	0.05	Left Cheek	1	50	0	1:1	0.141	1.107	0.156	-
1 900	19100	QPSK	20	23.7	23.53	0.10	Left Tilt	0	1	49	1:1	0.075	1.040	0.078	-
1 860	18700	QPSK	20	22.7	22.26	0.01	Left Tilt	1	50	0	1:1	0.059	1.107	0.065	-
1 900	19100	QPSK	20	23.7	23.53	-0.15	Right Cheek	0	1	49	1:1	0.169	1.040	0.176	-
1 860	18700	QPSK	20	22.7	22.26	0.02	Right Cheek	1	50	0	1:1	0.131	1.107	0.145	-
1 900	19100	QPSK	20	23.7	23.53	-0.10	Right Tilt	0	1	49	1:1	0.073	1.040	0.076	-
1 860	18700	QPSK	20	22.7	22.26	0.04	Right Tilt	1	50	0	1:1	0.060	1.107	0.066	-
ANSI/ IEEE C95.1 - 1992– Safety Limit Spatial Peak Uncontrolled Exposure/ General Population							Head 1.6 W/kg Averaged over 1 gram								

LTE Band 7 Head SAR															
Frequency		Mode	Band width	Tune-up Limit	Meas. Power	Power Drift	Test Position	MPR	RB Size	RB offset	Duty Cycle	Meas. SAR	Scaling Factor	Scaled SAR	Plot No.
MHz	Ch.														
2 535	21100	QPSK	20	24.2	23.92	0.12	Left Cheek	0	1	49	1:1	0.241	1.067	0.257	8
2 510	20850	QPSK	20	23.2	22.67	0.01	Left Cheek	1	50	49	1:1	0.204	1.130	0.231	-
2 535	21100	QPSK	20	24.2	23.92	0.05	Left Tilt	0	1	49	1:1	0.061	1.067	0.065	-
2 510	20850	QPSK	20	23.2	22.67	0.04	Left Tilt	1	50	49	1:1	0.048	1.130	0.054	-
2 535	21100	QPSK	20	24.2	23.92	0.11	Right Cheek	0	1	49	1:1	0.105	1.067	0.112	-
2 510	20850	QPSK	20	23.2	22.67	0.02	Right Cheek	1	50	49	1:1	0.093	1.130	0.105	-
2 535	21100	QPSK	20	24.2	23.92	0.16	Right Tilt	0	1	49	1:1	0.063	1.067	0.067	-
2 510	20850	QPSK	20	23.2	22.67	0.16	Right Tilt	1	50	49	1:1	0.051	1.130	0.058	-
ANSI/ IEEE C95.1 - 1992– Safety Limit Spatial Peak Uncontrolled Exposure/ General Population							Head 1.6 W/kg Averaged over 1 gram								

LTE Band 17 Head SAR															
Frequency		Mode	Band width	Tune-Up Limit	Meas. Power	Power Drift	Test Position	MPR	RB Size	RB offset	Duty Cycle	Meas. SAR	Scaling Factor	Scaled SAR	Plot No.
MHz	Ch.														
710	23790	QPSK	10	25.2	25.12	-0.073	Left Cheek	0	1	24	1:1	0.111	1.019	0.113	9
710	23790	QPSK	10	24.2	23.98	-0.014	Left Cheek	1	25	12	1:1	0.086	1.052	0.090	-
710	23790	QPSK	10	25.2	25.12	0.072	Left Tilt	0	1	24	1:1	0.055	1.019	0.056	-
710	23790	QPSK	10	24.2	23.98	-0.016	Left Tilt	1	25	12	1:1	0.041	1.052	0.043	-
710	23790	QPSK	10	25.2	25.12	0.116	Right Cheek	0	1	24	1:1	0.107	1.019	0.109	-
710	23790	QPSK	10	24.2	23.98	-0.132	Right Cheek	1	25	12	1:1	0.083	1.052	0.087	-
710	23790	QPSK	10	25.2	25.12	-0.095	Right Tilt	0	1	24	1:1	0.065	1.019	0.066	-
710	23790	QPSK	10	24.2	23.98	0.186	Right Tilt	1	25	12	1:1	0.049	1.052	0.052	-
ANSI/ IEEE C95.1 - 1992– Safety Limit Spatial Peak Uncontrolled Exposure/ General Population							Head 1.6 W/kg Averaged over 1 gram								

DTS Head SAR															
Frequency		Mode	Band width	Data Rate	Tune-Up Limit	Meas. Power	Power Drift	Test Position	Duty Cycle	Area Scan Peak SAR	Meas. SAR	Scaling Factor	Scaling Factor	Scaled SAR	Plot No.
MHz	Ch.														
2 437	6	802.11b	22	1	17.0	16.40		Left Cheek	99.84	0.253		1.148	1.002		-
2 437	6	802.11b	22	1	17.0	16.40		Left Tilt	99.84	0.135		1.148	1.002		-
2 437	6	802.11b	22	1	17.0	16.40	0.00	Right Cheek	99.84	0.920	0.667	1.148	1.002	0.767	10
2 437	6	802.11b	22	1	17.0	16.40	-0.08	Right Tilt	99.84	0.355	0.220	1.148	1.002	0.253	-
ANSI/ IEEE C95.1 - 1992– Safety Limit Spatial Peak Uncontrolled Exposure/ General Population							Head 1.6 W/kg Averaged over 1 gram								

DSS Head SAR													
Frequency		Mode	Tune-Up Limit	Meas. Power	Power Drift	Test Position	Duty Cycle	Meas. SAR	Scaling Factor	Scaling Factor	Scaled SAR	Plot No.	
MHz	Ch.												(dBm)
2 441	39	Bluetooth DH5	11.0	10.80	-0.01	Left Cheek	76.4	0.046	1.047	1.308	0.063	-	
2 441	39	Bluetooth DH5	11.0	10.80	-0.06	Left Tilt	76.4	0.022	1.047	1.308	0.030	-	
2 441	39	Bluetooth DH5	11.0	10.80	0.16	Right Cheek	76.4	0.162	1.047	1.308	0.222	11	
2 441	39	Bluetooth DH5	11.0	10.80	0.01	Right Tilt	76.4	0.052	1.047	1.308	0.071	-	
ANSI/ IEEE C95.1 - 1992– Safety Limit Spatial Peak Uncontrolled Exposure/ General Population							Head 1.6 W/kg (mW/g) Averaged over 1 gram						

11.2 Body-worn SAR Measurement Results

GSM/UMTS Body-Worn SAR														
Frequency		Mode		Tune-Up Limit (dB)	Meas. Power (dB)	Power Drift (dB)	Test Position	Duty Cycle	Distance (mm)	Meas. SAR (W/kg)	Scaling Factor	Scaled SAR (W/kg)	Plot No.	
MHz	Ch.													
836.6	190	GSM 850	GSM	33.7	33.47	-0.09	Rear	1:8.3	10	0.270	1.054	0.285	12	
836.6	190	GSM 850	GPRS 4Tx	28.2	28.12	0.05	Rear	1:2.075	10	0.450	1.019	0.459	13	
1 880.0	661	GSM 1900	GSM	30.7	30.30	-0.02	Rear	1:8.3	10	0.366	1.096	0.401	14	
1 880.0	661	GSM 1900	GPRS 4Tx	26.7	26.43	-0.01	Rear	1:2.075	10	0.426	1.064	0.453	15	
836.6	4183	UMTS 850	RMC	25.2	24.92	0.014	Rear	1:1	10	0.633	1.067	0.675	16	
1 880.0	9400	UMTS 1900	RMC	23.7	23.35	-0.16	Rear	1:1	10	0.533	1.084	0.578	17	
ANSI/ IEEE C95.1 - 1992– Safety Limit Spatial Peak Uncontrolled Exposure/ General Population							Body 1.6 W/kg Averaged over 1 gram							

LTE Body-Worn SAR																
Frequency		Mode	Band width (MHz)	Tune-Up Limit (dBm)	Meas. Power (dBm)	Power Drift (dB)	Test Position	MPR (dB)	RB Size	RB offset	Duty Cycle	Distance (mm)	Meas. SAR (W/kg)	Scaling Factor	Scaled SAR (W/kg)	Plot No.
MHz	Ch.															
1 900	19100	LTE 2 QPSK	20	23.7	23.53	0.01	Rear	0	1	49	1:1	10	0.763	1.040	0.794	18
1 860	18700		20	22.7	22.26	-0.14	Rear	1	50	0	1:1	10	0.633	1.107	0.701	-
2 535	21100	LTE 7 QPSK	20	24.2	23.92	0.00	Rear	0	1	49	1:1	10	0.203	1.067	0.217	19
2 510	20850		20	23.2	22.67	0.15	Rear	1	50	49	1:1	10	0.169	1.130	0.191	-
710	23790	LTE 17 QPSK	10	25.2	25.12	-0.019	Rear	0	1	24	1:1	10	0.551	1.019	0.561	20
710	23790		10	24.2	23.98	0.016	Rear	1	25	12	1:1	10	0.463	1.052	0.487	-
ANSI/ IEEE C95.1 - 1992– Safety Limit Spatial Peak Uncontrolled Exposure/ General Population							Body 1.6 W/kg Averaged over 1 gram									

DTS Body-Worn SAR																
Frequency		Mode	Band width (MHz)	Data Rate (Mbps)	Tune-Up Limit (dBm)	Meas. Power (dBm)	Power Drift (dB)	Test Position	Duty Cycle	Distance (mm)	Area Scan Peak SAR (W/kg)	Meas. SAR (W/kg)	Scaling Factor	Scaling Factor (Duty)	Scaled SAR (W/kg)	Plot No.
MHz	Ch.															
2 437	6	802.11b	22	1	17.0	16.40	-0.12	Rear	99.84	10	0.216	0.146	1.148	1.002	0.168	21
ANSI/ IEEE C95.1 - 1992– Safety Limit Spatial Peak Uncontrolled Exposure/ General Population							Body 1.6 W/kg Averaged over 1 gram									

11.3 Hotspot SAR Measurement Results

GSM 850 Hotspot SAR

Frequency		Mode	Tune-Up Limit (dB)	Meas. Power (dB)	Power Drift (dB)	Test Position	Duty Cycle	Distance (mm)	Meas. SAR (W/kg)	Scaling Factor	Scaled SAR (W/kg)	Plot No.
MHz	Ch.											
836.6	190	GPRS 4Tx	28.2	28.12	0.05	Rear	1:2.075	10	0.450	1.019	0.459	13
836.6	190	GPRS 4Tx	28.2	28.12	-0.02	Front	1:2.075	10	0.448	1.019	0.457	-
836.6	190	GPRS 4Tx	28.2	28.12	0.05	Right	1:2.075	10	0.197	1.019	0.201	-
836.6	190	GPRS 4Tx	28.2	28.12	0.04	Bottom	1:2.075	10	0.222	1.019	0.226	-
ANSI/ IEEE C95.1 - 1992- Safety Limit Spatial Peak Uncontrolled Exposure/ General Population						Body 1.6 W/kg Averaged over 1 gram						

GSM 1900 Hotspot SAR

Frequency		Mode	Tune-Up Limit (dB)	Meas. Power (dB)	Power Drift (dB)	Test Position	Duty Cycle	Distance (mm)	Meas. SAR (W/kg)	Scaling Factor	Scaled SAR (W/kg)	Plot No.
MHz	Ch.											
1 880	661	GPRS 4Tx	26.7	26.43	-0.01	Rear	1:2.075	10	0.426	1.064	0.453	15
1 880	661	GPRS 4Tx	26.7	26.43	-0.08	Front	1:2.075	10	0.389	1.064	0.414	-
1 880	661	GPRS 4Tx	26.7	26.43	-0.13	Left	1:2.075	10	0.197	1.064	0.210	-
1 880	661	GPRS 4Tx	26.7	26.43	0.18	Bottom	1:2.075	10	0.712	1.064	0.758	22
ANSI/ IEEE C95.1 - 1992- Safety Limit Spatial Peak Uncontrolled Exposure/ General Population						Body 1.6 W/kg Averaged over 1 gram						

UMTS 850 Hotspot SAR

Frequency		Mode	Tune-Up Limit (dB)	Meas. Power (dB)	Power Drift (dB)	Test Position	Duty Cycle	Distance (mm)	Meas. SAR (W/kg)	Scaling Factor	Scaled SAR (W/kg)	Plot No.
MHz	Ch.											
836.6	4183	RMC	25.2	24.92	0.014	Rear	1:1	10	0.633	1.067	0.675	16
836.6	4183	RMC	25.2	24.92	0.001	Front	1:1	10	0.581	1.067	0.620	-
836.6	4183	RMC	25.2	24.92	-0.001	Right	1:1	10	0.273	1.067	0.291	-
836.6	4183	RMC	25.2	24.92	-0.013	Bottom	1:1	10	0.335	1.067	0.357	-
ANSI/ IEEE C95.1 - 1992- Safety Limit Spatial Peak Uncontrolled Exposure/ General Population						Body 1.6 W/kg Averaged over 1 gram						

UMTS 1900 Hotspot SAR

Frequency		Mode	Tune-Up Limit (dB)	Meas. Power (dB)	Power Drift (dB)	Test Position	Duty Cycle	Distance (mm)	Meas. SAR (W/kg)	Scaling Factor	Scaled SAR (W/kg)	Plot No.
MHz	Ch.											
1 880.0	9400	RMC	23.7	23.35	-0.16	Rear	1:1	10	0.533	1.084	0.578	17
1 880.0	9400	RMC	23.7	23.35	0.06	Front	1:1	10	0.482	1.084	0.522	-
1 880.0	9400	RMC	23.7	23.35	0.17	Left	1:1	10	0.219	1.084	0.237	-
1 852.4	9262	RMC	23.7	23.51	0.09	Bottom	1:1	10	0.739	1.045	0.772	-
1 880.0	9400	RMC	23.7	23.35	0.02	Bottom	1:1	10	0.866	1.084	0.939	-
1 907.6	9538	RMC	23.7	23.46	0.06	Bottom	1:1	10	1.05	1.057	1.110	23
ANSI/ IEEE C95.1 - 1992– Safety Limit Spatial Peak Uncontrolled Exposure/ General Population							Body 1.6 W/kg Averaged over 1 gram					

LTE Band 2 (PCS) Hotspot SAR

Frequency		Mode	Band width (MHz)	Tune-Up Limit (dBm)	Meas. Power (dBm)	Power Drift (dB)	Test Position	MPR (dB)	RB Size	RB offset	Duty Cycle	Distance (mm)	Meas. SAR (W/kg)	Scaling Factor	Scaled SAR (W/kg)	Plot No.
MHz	Ch.															
1 900	19100	QPSK	20	23.7	23.53	0.01	Rear	0	1	49	1:1	10	0.763	1.040	0.794	18
1 860	18700	QPSK	20	22.7	22.26	-0.14	Rear	1	50	0	1:1	10	0.633	1.107	0.701	-
1 900	19100	QPSK	20	23.7	23.53	-0.10	Front	0	1	49	1:1	10	0.473	1.040	0.492	-
1 860	18700	QPSK	20	22.7	22.26	-0.15	Front	1	50	0	1:1	10	0.374	1.107	0.414	-
1 900	19100	QPSK	20	23.7	23.53	0.04	Left	0	1	49	1:1	10	0.193	1.040	0.201	-
1 860	18700	QPSK	20	22.7	22.26	-0.12	Left	1	50	0	1:1	10	0.147	1.107	0.163	-
1 900	19100	QPSK	20	23.7	23.53	0.01	Bottom	0	1	49	1:1	10	0.599	1.040	0.623	-
1 860	18700	QPSK	20	22.7	22.26	0.14	Bottom	1	50	0	1:1	10	0.598	1.107	0.662	-
ANSI/ IEEE C95.1 - 1992– Safety Limit Spatial Peak Uncontrolled Exposure/ General Population							Body 1.6 W/kg Averaged over 1 gram									

LTE Band 7 Hotspot SAR																
Frequency		Mode	Band width	Tune-Up Limit	Meas. Power	Power Drift	Test Position	MPR	RB Size	RB offset	Duty Cycle	Distance	Meas. SAR	Scaling Factor	Scaled SAR	Plot No.
MHz	Ch.															
2 535	21100	QPSK	20	24.2	23.92	0.00	Rear	0	1	49	1:1	10	0.203	1.067	0.217	19
2 510	20850	QPSK	20	23.2	22.67	0.15	Rear	1	50	49	1:1	10	0.169	1.130	0.191	-
2 535	21100	QPSK	20	24.2	23.92	0.02	Front	0	1	49	1:1	10	0.260	1.067	0.277	24
2 510	20850	QPSK	20	23.2	22.67	-0.03	Front	1	50	49	1:1	10	0.210	1.130	0.237	-
2 535	21100	QPSK	20	24.2	23.92	0.03	Left	0	1	49	1:1	10	0.105	1.067	0.112	-
2 510	20850	QPSK	20	23.2	22.67	0.04	Left	1	50	49	1:1	10	0.089	1.130	0.101	-
2 535	21100	QPSK	20	24.2	23.92	0.04	Bottom	0	1	49	1:1	10	0.176	1.067	0.188	-
2 510	20850	QPSK	20	23.2	22.67	0.12	Bottom	1	50	49	1:1	10	0.141	1.130	0.159	-
ANSI/ IEEE C95.1 - 1992– Safety Limit Spatial Peak Uncontrolled Exposure/ General Population								Body 1.6 W/kg Averaged over 1 gram								

LTE Band 17 Hotspot SAR																
Frequency		Mode	Band width	Tune-Up Limit	Meas. Power	Power Drift	Test Position	MPR	RB Size	RB offset	Duty Cycle	Distance	Meas. SAR	Scaling Factor	Scaled SAR	Plot No.
MHz	Ch.															
710	23790	QPSK	10	25.2	25.12	-0.019	Rear	0	1	24	1:1	10	0.551	1.019	0.561	20
710	23790	QPSK	10	24.2	23.98	0.016	Rear	1	25	12	1:1	10	0.463	1.052	0.487	-
710	23790	QPSK	10	25.2	25.12	0.177	Front	0	1	24	1:1	10	0.573	1.019	0.584	25
710	23790	QPSK	10	24.2	23.98	-0.198	Front	1	25	12	1:1	10	0.429	1.052	0.451	-
710	23790	QPSK	10	25.2	25.12	0.075	Right	0	1	24	1:1	10	0.309	1.019	0.315	-
710	23790	QPSK	10	24.2	23.98	0.076	Right	1	25	12	1:1	10	0.249	1.052	0.262	-
710	23790	QPSK	10	25.2	25.12	0.045	Bottom	0	1	24	1:1	10	0.257	1.019	0.262	-
710	23790	QPSK	10	24.2	23.98	0.015	Bottom	1	25	12	1:1	10	0.207	1.052	0.218	-
ANSI/ IEEE C95.1 - 1992– Safety Limit Spatial Peak Uncontrolled Exposure/ General Population								Body 1.6 W/kg Averaged over 1 gram								

DTS Hotspot SAR																
Frequency		Mode	Band width	Data Rate	Tune-Up Limit	Meas. Power	Power Drift	Test Position	Duty Cycle	Distance	Area Scan Peak SAR	Meas. SAR	Scaling Factor	Scaling Factor (Duty)	Scaled SAR	Plot No.
MHz	Ch.															
2 437	6	802.11b	22	1	17.0	16.40	-0.12	Rear	99.84	10	0.216	0.146	1.148	1.002	0.168	21
2 437	6	802.11b	22	1	17.0	16.40		Front	99.84	10	0.161		1.148	1.002		-
2 437	6	802.11b	22	1	17.0	16.40	0.11	Left	99.84	10	0.241	0.165	1.148	1.002	0.190	26
2 437	6	802.11b	22	1	17.0	16.40		Top	99.84	10	0.063		1.148	1.002		-
ANSI/ IEEE C95.1 - 1992– Safety Limit Spatial Peak Uncontrolled Exposure/ General Population								Body 1.6 W/kg Averaged over 1 gram								

11.4 SAR Test Notes

General Notes:

1. The test data reported are the worst-case SAR values according to test procedures specified in IEEE 1528-2013, FCC KDB Procedure.
2. Batteries are fully charged at the beginning of the SAR measurements. A standard battery was used for all SAR measurements.
3. Liquid tissue depth was at least 15.0 cm for all frequencies.
4. The manufacturer has confirmed that the device(s) tested have the same physical, mechanical and thermal characteristics and are within operational tolerances expected for production units.
5. SAR results were scaled to the maximum allowed power to demonstrate compliance per FCC KDB 447498 D01v06.
6. Device was tested using a fixed spacing for body-worn accessory testing. A separation distance of 10 mm was considered because the manufacturer has determined that there will be body-worn accessories available in the marketplace for users to support this separation distance.
7. Per FCC KDB 648474 D04v01r03, SAR was evaluated without a headset connected to the device. Since the standalone reported SAR was ≤ 1.2 W/kg, no additional SAR evaluation using a headset cable were required.

GSM/GPRS Test Notes:

1. This EUT'S GSM and GPRS device class is B.
2. This device supports GPRS VOIP in the head and the body-worn configurations therefore GPRS was additionally evaluated for head and body-worn compliance.
3. Body-Worn accessory testing is typically associated with voice operations. Therefore, GSM voice was evaluated for body-worn SAR.
4. Justification for reduced test configurations per KDB 941225 D01v03r01: The source-based time-averaged output power was evaluated for all multi-slot operations. The multi-slot configuration with the highest frame averaged output power including tolerance was evaluated for SAR.
5. Per FCC KDB 447498 D01v06, if the reported (scaled) SAR measured at the middle channel or highest output power channel for each test configuration is ≤ 0.8 W/kg then testing at the other channels is not required for such test configuration(s). When the maximum output power variation across the required test channels is 1/2 dB, instead of the middle channel, the highest output power channel must be used.
6. Justification for reduced test configurations per KDB Publication 941225 D01v03r01 and October 2013 TCB Workshop Notes: The source-based frame-averaged output power was evaluated for all GPRS/EDGE slot configurations. The configuration with the highest target frame averaged output power was evaluated for hotspot SAR. When the maximum frame-averaged powers are equivalent across two or more slots (within 0.25 dB), the configuration with the most number of time slots was tested.
7. When the maximum output power variation across the required test channels are over than 1/2 dB, instead of the middle channel, the highest output power channel was selected for SAR test according to Per FCC KDB 447498 D01v06.

UMTS Notes:

1. The 12.2 kbps RMC mode is the primary mode per KDB 941225 D01v03r01.
2. UMTS mode in Body SAR was tested under RMC 12.2 kbps with HSPA inactive per KDB 941225 D01v03r01. HSPA SAR was not required since the average output power of the HSPA subtests was not more than 0.25 dB higher than the RMC level and Adjusted SAR value was less than 1.2 W/kg.
3. Per FCC KDB 447498 D01v06, if the reported (scaled) SAR measured at the middle channel or highest output power channel for each test configuration is ≤ 0.8 W/kg then testing at the other channels is not required for such test configuration(s). When the maximum output power variation across the channel highest output power channel was used.
4. UMTS SAR was tested under RMC 12.2 kbps with HSPA inactive per KDB publication 941225 D01v03r01. HSPA SAR was not required since the average output power of the HSPA subtests was not more than 0.25 dB higher than the RMC level and SAR was less than 1.2 W/kg.

LTE Notes:

1. LTE Considerations: LTE test configurations are determined according to SAR Evaluation Consideration for LTE Devices in FCC KDB 941225 D05v02r05.
2. According to FCC KDB 941225 D05v02r05.
When the reported SAR is ≤ 0.8 W/kg, testing of the 100%RB allocation and required test channels is not required. Otherwise, SAR is required for the remaining required test channels using the 1RB, 50%RB and 100%RB allocation with highest output power for that channel.
Only one channel, and as reported SAR values for 1RB allocation and 50%RB allocation were less than 1.45W/Kg only the highest power RB offset for each allocation was required.
3. MPR is permanently implemented for this device by the manufacturer. The specific manufacturer target MPR is indicated alongside the SAR results. MPR is enabled for this device, according to target MPR is indicated alongside the SAR results.
4. A-MPR was disabled for all SAR tests by setting NS=01 on the base station simulator.
5. Pre-installed VOIP applications are considered.
6. Per KDB 941225 D05Av01r02, SAR for LTE Carrier Aggregation operations was not needed because the maximum average output power in LTE CA mode was not > 0.25 dB higher than the maximum output power when downlink CA was not activated.
7. SAR test reduction is applied using the following criteria:
Start with the largest channel bandwidth and measure SAR for QPSK with 1 RB, and 50% RB allocation, using the RB offset and required test channel combination with the highest maximum output power among RB offsets at the upper edge, middle and lower edge of each required test channel. When the reported SAR is >0.8 W/kg, testing for other Channels is performed at the highest output power level for 1RB, and 50% RB configuration for that channel. Testing for 100% RB configuration is performed at the highest output power level for 100% RB configuration across the Low, Mid and High Channel when the highest reported SAR for 1 RB and 50% RB are >0.8 W/kg, Testing for the remaining required channels is not needed because the reported SAR for 100% RB Allocation <1.45 W/kg. Testing for 16-QAM modulation is not required because the reported SAR for QPSK is <1.45 W/kg and its output power is not more than 0.5 dB higher than that a QPSK. Testing for the other channel bandwidths is not required because the reported SAR for the highest channel bandwidth is <1.45 W/kg and its output power is not more than 0.5 dB higher than that of the highest channel bandwidth.

WLAN Notes:

1. For held-to-ear and hotspot operations, the initial test position procedures were applied. For initial test position, the highest extrapolated peak SAR will be used. When reported SAR for the initial test position is ≤ 0.4 W/kg for 1g SAR and ≤ 1.0 W/kg for 10g SAR, no additional testing for the remaining test positions was required. Otherwise, SAR is evaluated at the subsequent highest peak SAR positions until the reported SAR results is ≤ 0.8 W/kg for 1g SAR and ≤ 2.0 W/kg for 10g SAR or all test position are measured.
2. Per KDB 248227 D01v02r02 justification for test configurations of 2.4 GHz WiFi Single transmission chain operations, the highest measured maximum output power channel for DSSS was selected for SAR measurement. SAR for OFDM modes (2.4 GHz 802.11 g/n) was not required due to the maximum allowed powers and the highest reported DSSS SAR.
3. When the maximum reported 1g averaged SAR is ≤ 0.8 W/kg, SAR testing on additional channels was not required. Otherwise, SAR for the next highest output power channel was required until the reported SAR result was ≤ 1.20 W/kg or all test channels were measured.
4. The device was configured to transmit continuously at the required data rate, channel bandwidth and signal modulation, using the highest transmission duty factor supported by the test mode tools. The reported SAR was scaled to the 100% transmission duty factor to determine compliance. Procedures used to measure the duty factor are identical to that in the associated WLAN test reports.

Bluetooth Notes:

1. Bluetooth SAR was measured with the device connected to a call box with hopping disabled with DH5 operation and Tx Tests mode type. Per October 2016 TCBC Workshop Notes, the reported SAR was scaled to 100% transmission duty factor to determine compliance. Please see sec.9.5 for the time-domain plot and calculation for duty factor of the device.

12. Simultaneous SAR Analysis

12.1 Simultaneous Transmission Summation for Head

Simultaneous Transmission Summation Scenario with 2.4 GHz WLAN				
Exposure condition	Band	WWAN SAR	2.4 GHz WLAN SAR	Σ 1-g SAR
		(W/kg)	(W/kg)	(W/kg)
Head SAR	GSM 850	0.075	0.767	0.842
	GPRS 850	0.139	0.767	0.906
	GSM 1900	0.087	0.767	0.854
	GPRS 1900	0.159	0.767	0.926
	UMTS 850	0.238	0.767	1.005
	UMTS 1900	0.206	0.767	0.973
	LTE Band 2	0.176	0.767	0.943
	LTE Band 7	0.257	0.767	1.024
	LTE Band 17	0.113	0.767	0.880

Simultaneous Transmission Summation Scenario with Bluetooth				
Exposure condition	Band	WWAN SAR	Bluetooth SAR	Σ 1-g SAR
		(W/kg)	(W/kg)	(W/kg)
Head SAR	GSM 850	0.075	0.222	0.297
	GPRS 850	0.139	0.222	0.361
	GSM 1900	0.087	0.222	0.309
	GPRS 1900	0.159	0.222	0.381
	UMTS 850	0.238	0.222	0.460
	UMTS 1900	0.206	0.222	0.428
	LTE Band 2	0.176	0.222	0.398
	LTE Band 7	0.257	0.222	0.479
	LTE Band 17	0.113	0.222	0.335

12.2 Simultaneous Transmission Summation for Body-Worn

Simultaneous Transmission Summation Scenario with 2.4 GHz WLAN					
Exposure condition	Distance	Band	WWAN SAR	2.4 GHz WLAN SAR	\sum 1-g SAR
	(mm)		(W/kg)	(W/kg)	(W/kg)
Body-worn	10	GSM 850	0.285	0.168	0.453
		GPRS 850	0.459	0.168	0.627
		GSM 1900	0.401	0.168	0.569
		GPRS 1900	0.453	0.168	0.621
		UMTS 850	0.675	0.168	0.843
		UMTS 1900	0.578	0.168	0.746
		LTE Band 2	0.794	0.168	0.962
		LTE Band 7	0.217	0.168	0.385
		LTE Band 17	0.561	0.168	0.729

Simultaneous Transmission Summation Scenario with Bluetooth					
Exposure condition	Distance	Band	WWAN SAR	Bluetooth SAR	\sum 1-g SAR
	(mm)		(W/kg)	(W/kg)	(W/kg)
Body-worn	10	GSM 850	0.285	0.273	0.558
		GPRS 850	0.459	0.273	0.732
		GSM 1900	0.401	0.273	0.674
		GPRS 1900	0.453	0.273	0.726
		UMTS 850	0.675	0.273	0.948
		UMTS 1900	0.578	0.273	0.851
		LTE Band 2	0.794	0.273	1.067
		LTE Band 7	0.217	0.273	0.490
		LTE Band 17	0.561	0.273	0.834

Note: Bluetooth SAR was not required to be measured per FCC KDB 447498 D01v06. Estimated SAR results were used for SAR summation for body-worn back side at 10 mm to determine simultaneous transmission SAR test exclusion.

12.3 Simultaneous Transmission Summation for Hotspot

Simultaneous Transmission Summation Scenario with 2.4 GHz WLAN					
Exposure condition	Distance	Band	WWAN SAR	2.4 GHz WLAN SAR	Σ 1-g SAR
	(mm)		(W/kg)	(W/kg)	(W/kg)
Hotspot	10	GSM 850	0.459	0.190	0.649
		GSM 1900	0.758	0.190	0.948
		UMTS 850	0.675	0.190	0.865
		UMTS 1900	1.110	0.190	1.300
		LTE Band 2	0.794	0.190	0.984
		LTE Band 7	0.277	0.190	0.467
		LTE Band 17	0.584	0.190	0.774

Simultaneous Transmission Summation Scenario with Bluetooth					
Exposure condition	Distance	Band	WWAN SAR	Bluetooth SAR	Σ 1-g SAR
	(mm)		(W/kg)	(W/kg)	(W/kg)
Hotspot	10	GSM 850	0.459	0.273	0.732
		GSM 1900	0.758	0.273	1.031
		UMTS 850	0.675	0.273	0.948
		UMTS 1900	1.110	0.273	1.383
		LTE Band 2	0.794	0.273	1.067
		LTE Band 7	0.277	0.273	0.550
		LTE Band 17	0.584	0.273	0.857

Note: Bluetooth SAR was not required to be measured per FCC KDB 447498 D01v06. Estimated SAR results were used for SAR summation for body back side at 10 mm to determine simultaneous transmission SAR test exclusion.

12.4 Simultaneous Transmission Conclusion

The above numerical summed SAR results for all the worst-case simultaneous transmission conditions were below the SAR limit. Therefore, the above analysis is sufficient to determine that simultaneous transmission cases will not exceed the SAR limit. And therefore no measured volumetric simultaneous SAR summation is required per FCC KDB Publication 447498 D01v06 and IEEE 1528-2013.

13. SAR Measurement Variability and Uncertainty

In accordance with KDB procedure 865664 D01v01r04 SAR measurement 100 MHz to 6 GHz, SAR additional measurements are repeated after the completion of all measurements requiring the same head or body tissue-equivalent medium in a frequency band. The test device should be returned to ambient conditions (normal room temperature) with the battery fully charged before it is re-mounted on the device holder for the repeated measurement(s) to minimize any unexpected variations in the repeated results.

SAR Measurement variability was assessed using the following procedures for each frequency band:

1) Repeated measurement is not required when the original highest measured SAR is < 0.80 W/kg for 1g SAR or < 2.0 W/kg for 10g SAR; steps 2) through 4) do not apply.

2) When the original highest measured 1g SAR is ≥ 0.80 W/kg or 10g SAR ≥ 2.0 W/kg, repeat that measurement once.

3) Perform a second repeated measurement only if the ratio of largest to smallest SAR for the original and first repeated measurements is > 1.20 or when the original or repeated measurement is ≥ 1.45 W/kg for 1g SAR or ≥ 3.625 W/kg for 10g SAR (~ 10% from the 1-g SAR limit).

4) Perform a third repeated measurement only if the original, first or second repeated measurement is ≥ 1.5 W/kg for 1g SAR or ≥ 3.75 W/kg for 10g SAR and the ratio of largest to smallest SAR for the original, first and second repeated measurements is > 1.20.

Frequency		Modulation	Battery	Configuration	Original SAR	Repeated SAR	Largest to Smallest SAR Ratio	Plot No.
MHz	Channel				(W/kg)	(W/kg)		
1 907.6	9538	UMTS 1900	Standard	Bottom	1.05	1.04	1.01	27

14. MEASUREMENT UNCERTAINTY

Error Description	Tol (± %)	Prob. dist.	Div.	c _i	Standard Uncertainty (± %)	V _{eff}
1. Measurement System						
Probe Calibration	6.55	N	1	1	6.55	∞
Axial Isotropy	4.70	R	1.73	0.70	1.90	∞
Hemispherical Isotropy	9.60	R	1.73	0.70	3.88	∞
Boundary Effects	2.00	R	1.73	1	1.15	∞
Linearity	4.70	R	1.73	1	2.71	∞
System Detection Limits	0.25	R	1.73	1	0.14	∞
Readout Electronics	0.30	N	1.00	1	0.30	∞
Response Time	0.80	R	1.73	1	0.46	∞
Integration Time	2.60	R	1.73	1	1.50	∞
RF Ambient Noise	3.00	R	1.73	1	1.73	∞
RF Ambient Reflections	3.00	R	1.73	1	1.73	∞
Probe Positioner	0.80	R	1.73	1	0.46	∞
Probe Positioning	6.70	R	1.73	1	3.87	∞
Max SAR Eval	4.00	R	1.73	1	2.31	∞
2. Test Sample Related						
Device Positioning	2.11	N	1.00	1	2.11	9
Device Holder	3.60	N	1.00	1	3.60	5
Power Drift	5.00	R	1.73	1	2.89	∞
Power Scaling	0.00	R	1.73	1	0.00	∞
3. Phantom and Setup						
Phantom Uncertainty	6.60	R	1.73	1	3.82	∞
Liquid Conductivity(target)	5.00	R	1.73	0.64	1.85	∞
Liquid Permittivity(target)	5.00	R	1.73	0.60	1.73	∞
Liquid Conductivity(meas.)	3.80	N	1	0.78	2.96	5
Liquid Permittivity(meas.)	2.60	N	1	0.23	0.60	5
Liquid Conductivity(temp.)	1.70	R	1.73	0.78	0.77	∞
Liquid Permittivity(temp.)	2.70	R	1.73	0.23	0.36	∞
Combind Standard Uncertainty					12.49	
Coverage Factor for 95 %					k=2	
Expanded STD Uncertainty					24.98	

15. SAR TEST EQUIPMENT

Manufacturer	Type / Model	S/N	Calib. Date	Calib.Interval	Calib.Due
SPEAG	SAM Phantom	-	N/A	N/A	N/A
SPEAG	Triple Modular Phantom	-	N/A	N/A	N/A
HP	SAR System Control PC	-	N/A	N/A	N/A
Staubli	Robot ControllerCS7MB	F01/5L76A1/C/01	N/A	N/A	N/A
Staubli	CS8Cspeag-TX90	F17/ 59RAA1/C/01	N/A	N/A	N/A
Staubli	CS8Cspeag-TX90	F13/ 5R4XF1/C/01	N/A	N/A	N/A
Staubli	Robot RX90B L	F01/5L76A1/A/01	N/A	N/A	N/A
Staubli	TX90 Xlspeag	F17/ 59RAA1/A/01	N/A	N/A	N/A
Staubli	TX90 Xlspeag	F13/ 5R4XF1/A/01	N/A	N/A	N/A
Staubli	Teach Pendant (Joystick)	D22134006 A	N/A	N/A	N/A
Staubli	Teach Pendant (Joystick)	D21142606B	N/A	N/A	N/A
Staubli	Teach Pendant (Joystick)	D21142605	N/A	N/A	N/A
SPEAG	DAE4	652	01/20/2017	Annual	01/20/2018
SPEAG	DAE4	1225	11/24/2016	Annual	11/24/2017
SPEAG	DAE4	1417	01/19/2017	Annual	01/19/2018
SPEAG	DAE3	446	01/19/2017	Annual	01/19/2018
SPEAG	E-Field Probe EX3DV4	7370	08/30/2016	Annual	08/30/2017
SPEAG	E-Field Probe EX3DV4	3797	11/25/2016	Annual	11/25/2017
SPEAG	E-Field Probe ET3DV6	1630	02/27/2017	Annual	02/27/2018
SPEAG	E-Field Probe ET3DV6	1605	07/29/2016	Annual	07/29/2017
SPEAG	Dipole D750V3	1014	07/22/2016	Annual	07/22/2017
SPEAG	Dipole D835V2	441	11/16/2016	Annual	11/16/2017
SPEAG	Dipole D1900V2	5d032	03/21/2017	Annual	03/21/2018
SPEAG	Dipole D2450V2	743	03/15/2017	Annual	03/15/2018
SPEAG	Dipole D2600V2	1015	01/18/2017	Annual	01/18/2018
Agilent	Power Meter N1911A	MY45101406	09/28/2016	Annual	09/28/2017
HP	Power Sensor N1921A	MY55220026	08/24/2016	Annual	08/24/2017
SPEAG	DAKS 3.5	1031	04/27/2017	Annual	04/27/2018
Agilent	Directional Bridge	86205A	10/16/2016	Annual	10/16/2017
Agilent	Base Station E5515C	GB44400269	02/02/2017	Annual	02/08/2018
HP	Signal Generator E4433B	US40052109	03/10/2017	Annual	03/10/2018
HP	11636B/Power Divider	58698	03/05/2017	Annual	03/05/2018
TESTO	175-H1/Thermometer	40332651310	02/10/2017	Annual	02/10/2018
TESTO	175-H1/Thermometer	40331939309	02/10/2017	Annual	02/10/2018
EMPOWER	RF Power amplifier	1011	10/17/2016	Annual	10/17/2017
Agilent	Attenuator(3dB)	52744	10/16/2016	Annual	10/16/2017
Agilent	Attenuator(20dB)	52664	10/16/2016	Annual	10/16/2017
HP	Dielectric Probe Kit 85070C	00721521	N/A	N/A	N/A
HP	Dual Directional Coupler	16072	10/16/2016	Annual	10/16/2017
R&S	Wideband Radio Communication Tester CMW500	101519	04/27/2017	Annual	04/27/2018
Anritsu	Radio Communication Analyzer/ MT8820C	6200628628	07/05/2016	Annual	07/05/2017
Anritsu	Radio Communication Analyzer/ MT8820C	6200576565	07/05/2016	Annual	07/05/2017
R&S	Bluetooth CBT	101519	04/27/2017	Annual	04/27/2018

NOTE:

The E-field probe was calibrated by SPEAG, by the waveguide technique procedure. Dipole Verification measurement is performed by HCT Lab. before each test. The brain/body simulating material is calibrated by HCT using the DAKS 3.5 to determine the conductivity and permittivity (dielectric constant) of the brain/body-equivalent material.

16. CONCLUSION

The SAR measurement indicates that the EUT complies with the RF radiation exposure limits of the ANSI/IEEE C95.1 1992.

These measurements are taken to simulate the RF effects exposure under worst-case conditions. Precise laboratory measures were taken to assure repeatability of the tests.

The SAR measurement indicates that the EUT complies with the RF radiation exposure limits of the FCC and Industry Canada. These measurements were taken to simulate the RF effects of RF exposure under worst-case conditions. Precise laboratory measures were taken to assure repeatability of the tests. The results and statements relate only to the item(s) tested.

17. REFERENCES

- [1] IEEE Standards Coordinating Committee 34 – IEEE Std. 1528-2013, IEEE Recommended Practice or Determining the Peak Spatial-Average Specific Absorption Rate (SAR) in the Human Body from Wireless Communications Devices.
- [2] Federal Communications Commission, ET Docket 93-62, Guidelines for Evaluating the Environmental Effects of Radio frequency Radiation, Aug. 1996.
- [3] ANSI/IEEE C95.1 - 1991, American National Standard safety levels with respect to human exposure to radio frequency electromagnetic fields, 300 kHz to 100 GHz, New York: IEEE, Aug. 1992
- [4] ANSI/IEEE C 95.1 - 2005, American National Standard safety levels with respect to human exposure to radio frequency electromagnetic fields, 3 kHz to 300 GHz, New York: IEEE, 2006.
- [5] ANSI/IEEE C95.3 - 1991, IEEE Recommended Practice for the Measurement of Potentially Hazardous Electromagnetic Fields - RF and Microwave, New York: IEEE, 1992.
- [6] NCRP, National Council on Radiation Protection and Measurements, Biological Effects and Exposure Criteria for Radio Frequency Electromagnetic Fields, NCRP Report No. 86, 1986. Reprinted Feb. 1995.
- [7] T. Schmid, O. Egger, N. Kuster, Automated E-field scanning system for dosimetric assessments, IEEE Transaction on Microwave Theory and Techniques, vol. 44, Jan. 1996, pp. 105-113.
- [8] K. Pokovic, T. Schmid, N. Kuster, Robust setup for precise calibration of E-field probes in tissue simulating liquids at mobile communications frequencies, ICECOM97, Oct. 1997, pp. 120-124.
- [9] K. Pokovic, T. Schmid, and N. Kuster, E-field Probe with improved isotropy in brain simulating liquids, Proceedings of the ELMAR, Zadar, Croatia, June 23-25, 1996, pp. 172-175.
- [10] Schmid & Partner Engineering AG, Application Note: Data Storage and Evaluation, June 1998, p2.
- [11] V. Hombach, K. Meier, M. Burkhardt, E. Kuhn, N. Kuster, The Dependence of EM Energy Absorption upon Human Head Modeling at 900 MHz, IEEE Transaction on Microwave Theory and Techniques, vol. 44 no. 10, Oct. 1996, pp. 1865-1873.
- [12] N. Kuster and Q. Balzano, Energy absorption mechanism by biological bodies in the near field of dipole antennas above 300 MHz, IEEE Transaction on Vehicular Technology, vol. 41, no. 1, Feb. 1992, pp. 17-23.
- [13] G. Hartsgrove, A. Kraszewski, A. Surowiec, Simulated Biological Materials for Electromagnetic Radiation Absorption Studies, University of Ottawa, Bioelectro magnetics, Canada: 1987, pp. 29-36.
- [14] Q. Balzano, O. Garay, T. Manning Jr., Electromagnetic Energy Exposure of Simulated Users of Portable Cellular Telephones, IEEE Transactions on Vehicular Technology, vol. 44, no.3, Aug. 1995.
- [15] W. Gander, Computer mathematick, Birkhaeuser, Basel, 1992.
- [16] W.H. Press, S.A. Teukolsky, W.T. Vetterling, and B.P. Flannery, Numerical Receptions in C, The Art of Scientific Computing, Second edition, Cambridge University Press, 1992.
- [17] N. Kuster, R. Kastle, T. Schmid, Dosimetric evaluation of mobile communications equipment with known precision, IEEE Transaction on Communications, vol. E80-B, no. 5, May 1997, pp. 645-652.
- [18] CENELEC CLC/SC111B, European Prestandard (prENV 50166-2), Human Exposure to Electromagnetic Fields High-frequency: 10 kHz-300 GHz, Jan. 1995.
- [19] Prof. Dr. Niels Kuster, ETH, Eidgenössische Technische Hochschule Zürich, Dosimetric Evaluation of the Cellular Phone.

- [20] IEC 62209-1, Human exposure to radio frequency fields from hand-held and body-mounted wireless communication devices – Human models, instrumentation and procedures – Part 1: Procedure to determine the specific absorption rate (SAR) for hand-held devices used in close proximity to the ear (frequency range of 300 MHz to 3 GHz), Feb. 2005.
- [21] IEC 62209-2, Human exposure to radio frequency fields from hand-held and body-mounted wireless communication devices – Human models, instrumentation, and procedures – Part 2: Procedure to determine the specific absorption rate (SAR) for wireless communication devices used in close proximity to the human body (frequency range of 30 MHz to 6 GHz) Mar. 2010.
- [22] Industry Canada RSS-102 Radio Frequency Exposure Compliance of Radio communication Apparatus (All Frequency Band) Issue 5, March 2015.
- [23] Health Canada Safety Code 6 Limits of Human Exposure to Radio Frequency Electromagnetic Fields in the Frequency Range from 3 kHz – 300 GHz, 2009
- [24] FCC SAR Test procedures for 2G-3G Devices, Mobile Hotspot and UMPC Device KDB 941225 D01.
- [25] SAR Measurement Guidance for IEEE 802.11 transmitters, KDB 248227 D01.
- [26] SAR Evaluation of Handsets with Multiple Transmitters and Antennas KDB 648474 D03, D04.
- [27] SAR Evaluation for Laptop, Notebook, Netbook and Tablet computers KDB 616217 D04.
- [28] SAR Measurement and Reporting Requirements for 100 MHz – 6 GHz, KDB 865664 D01, D02.
- [29] FCC General RF Exposure Guidance and SAR procedures for Dongles, KDB 447498 D01, D02.

Attachment 1. – SAR Test Plots

Test Laboratory: HCT CO., LTD
EUT Type: GSM/WCDMA/LTE Phone with Bluetooth4.2LE, WIFI802.11 b/g/n
Liquid Temperature: 20.9 °C
Ambient Temperature: 21.1 °C
Test Date: 05/30/2017
Plot No.: 1

DUT: LG-M700TV; Type: bar

Communication System: UID 0, GSM 850; Frequency: 836.6 MHz;Duty Cycle: 1:8.3
Medium parameters used (interpolated): $f = 836.6$ MHz; $\sigma = 0.915$ S/m; $\epsilon_r = 41.937$; $\rho = 1000$ kg/m³
Phantom section: Left Section

DASY5 Configuration:

- Probe: ET3DV6 - SN1630; ConvF(7.26, 7.26, 7.26); Calibrated: 2017-02-27;
- Sensor-Surface: 4mm (Mechanical Surface Detection)
- Electronics: DAE4 Sn652; Calibrated: 2017-01-20
- Phantom: SAM
- Measurement SW: DASY4, Version 4.7 (80);

GSM850 Head Left touch 190ch/Area Scan (7x12x1): Measurement grid: dx=15mm, dy=15mm
Maximum value of SAR (measured) = 0.0747 W/kg

GSM850 Head Left touch 190ch/Zoom Scan (5x5x7)/Cube 0: Measurement grid: dx=8mm, dy=8mm, dz=5mm

Reference Value = 2.737 V/m; Power Drift = -0.05 dB

Peak SAR (extrapolated) = 0.0890 W/kg

SAR(1 g) = 0.071 W/kg; SAR(10 g) = 0.055 W/kg

Maximum value of SAR (measured) = 0.0740 W/kg

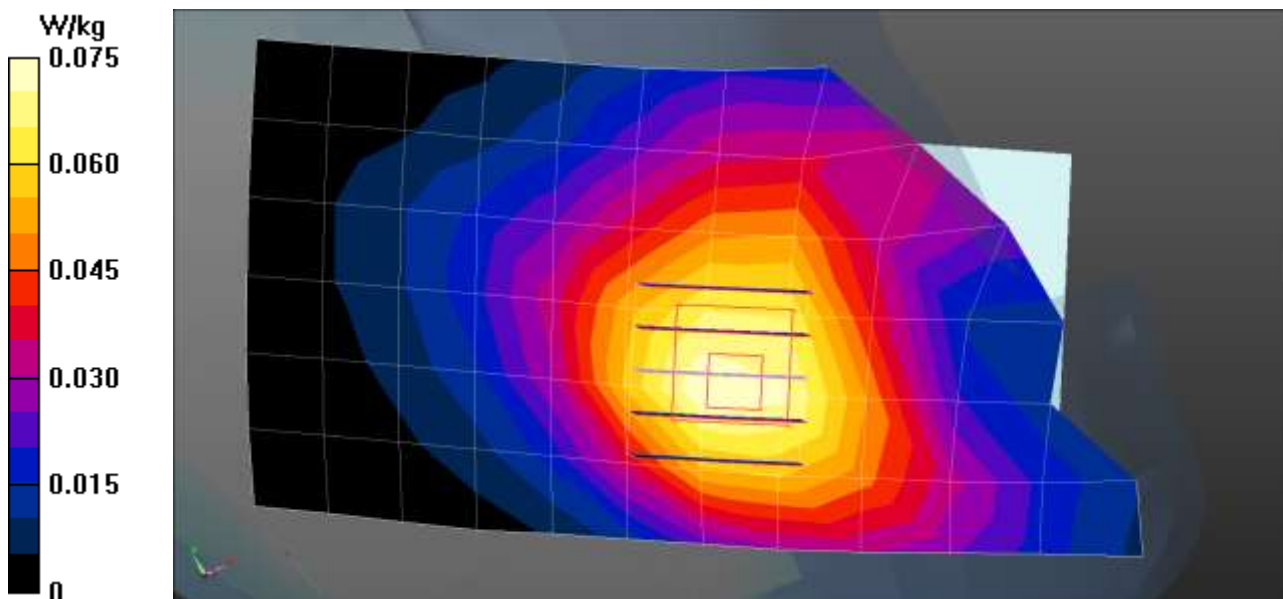

Test Laboratory: HCT CO., LTD
EUT Type: GSM/WCDMA/LTE Phone with Bluetooth4.2LE, WIFI802.11 b/g/n
Liquid Temperature: 20.9 °C
Ambient Temperature: 21.1 °C
Test Date: 05/30/2017
Plot No.: 2

DUT: LG-M700TV; Type: bar

Communication System: UID 0, GSM 850; Frequency: 836.6 MHz;Duty Cycle: 1:2.075
Medium parameters used (interpolated): $f = 836.6$ MHz; $\sigma = 0.915$ S/m; $\epsilon_r = 41.937$; $\rho = 1000$ kg/m³
Phantom section: Left Section

DASY5 Configuration:

- Probe: ET3DV6 - SN1630; ConvF(7.26, 7.26, 7.26); Calibrated: 2017-02-27;
- Sensor-Surface: 4mm (Mechanical Surface Detection)
- Electronics: DAE4 Sn652; Calibrated: 2017-01-20
- Phantom: SAM
- Measurement SW: DASY4, Version 4.7 (80);

GSM850 Head Left Touch GPRS 4Tx 190ch/Area Scan (7x12x1): Measurement grid: dx=15mm, dy=15mm
Maximum value of SAR (measured) = 0.140 W/kg

GSM850 Head Left Touch GPRS 4Tx 190ch/Zoom Scan (5x5x7)/Cube 0: Measurement grid: dx=8mm, dy=8mm, dz=5mm
Reference Value = 3.703 V/m; Power Drift = 0.04 dB
Peak SAR (extrapolated) = 0.169 W/kg
SAR(1 g) = 0.136 W/kg; SAR(10 g) = 0.106 W/kg
Maximum value of SAR (measured) = 0.141 W/kg

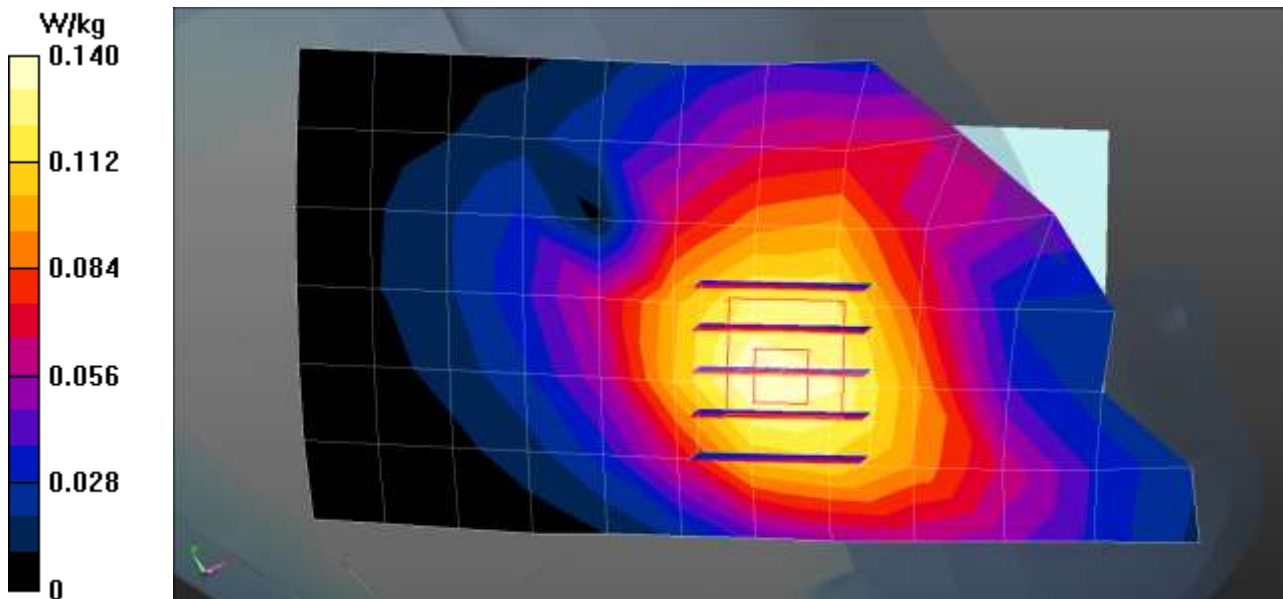

Test Laboratory: HCT CO., LTD
EUT Type: GSM/WCDMA/LTE Phone with Bluetooth4.2LE, WIFI802.11 b/g/n
Liquid Temperature: 20.5 °C
Ambient Temperature: 20.7 °C
Test Date: 05/26/2017
Plot No.: 3

DUT: LG-M700TV; Type: Bar

Communication System: UID 0, GSM 1900; Frequency: 1880 MHz;Duty Cycle: 1:8.30042
Medium parameters used: $f = 1880$ MHz; $\sigma = 1.39$ S/m; $\epsilon_r = 39.844$; $\rho = 1000$ kg/m³
Phantom section: Left Section

DASY5 Configuration:

- Probe: ET3DV6 - SN1605; ConvF(5.18, 5.18, 5.18); Calibrated: 2016-07-29;
- Sensor-Surface: 4mm (Mechanical Surface Detection)
- Electronics: DAE3 Sn446; Calibrated: 2017-01-19
- Phantom: SAM
- Measurement SW: DASY52, Version 52.8 (1);

GSM1900 Head Left Touch 661ch/Area Scan (8x12x1): Measurement grid: dx=15mm, dy=15mm
Maximum value of SAR (measured) = 0.0860 W/kg

GSM1900 Head Left Touch 661ch/Zoom Scan (5x5x7)/Cube 0: Measurement grid: dx=8mm, dy=8mm, dz=5mm

Reference Value = 3.024 V/m; Power Drift = 0.02 dB

Peak SAR (extrapolated) = 0.120 W/kg

SAR(1 g) = 0.079 W/kg; SAR(10 g) = 0.049 W/kg

Maximum value of SAR (measured) = 0.0841 W/kg

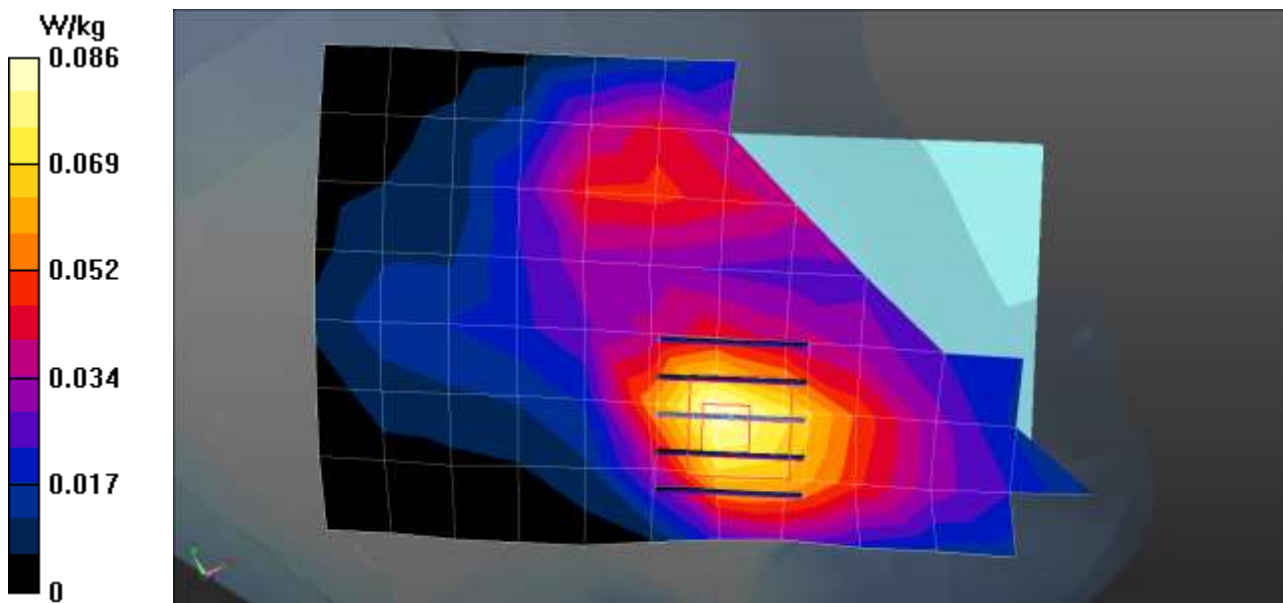

Test Laboratory: HCT CO., LTD
 EUT Type: GSM/WCDMA/LTE Phone with Bluetooth4.2LE, WIFI802.11 b/g/n
 Liquid Temperature: 20.5 °C
 Ambient Temperature: 20.7 °C
 Test Date: 05/26/2017
 Plot No.: 4

DUT: LG-M700TV; Type: Bar

Communication System: UID 0, GSM 1900 4TX; Frequency: 1880 MHz; Duty Cycle: 1:2.07491
 Medium parameters used: $f = 1880 \text{ MHz}$; $\sigma = 1.39 \text{ S/m}$; $\epsilon_r = 39.844$; $\rho = 1000 \text{ kg/m}^3$
 Phantom section: Right Section

DASY5 Configuration:

- Probe: ET3DV6 - SN1605; ConvF(5.18, 5.18, 5.18); Calibrated: 2016-07-29;
- Sensor-Surface: 4mm (Mechanical Surface Detection)
- Electronics: DAE3 Sn446; Calibrated: 2017-01-19
- Phantom: SAM
- Measurement SW: DASY52, Version 52.8 (1);

GSM1900 Head Right Touch 661ch 4Tx/Area Scan (8x12x1): Measurement grid: dx=15mm, dy=15mm
 Maximum value of SAR (measured) = 0.151 W/kg

GSM1900 Head Right Touch 661ch 4Tx/Zoom Scan (5x5x7)/Cube 0: Measurement grid: dx=8mm, dy=8mm, dz=5mm

Reference Value = 4.103 V/m; Power Drift = 0.09 dB

Peak SAR (extrapolated) = 0.214 W/kg

SAR(1 g) = 0.149 W/kg; SAR(10 g) = 0.093 W/kg

Maximum value of SAR (measured) = 0.164 W/kg

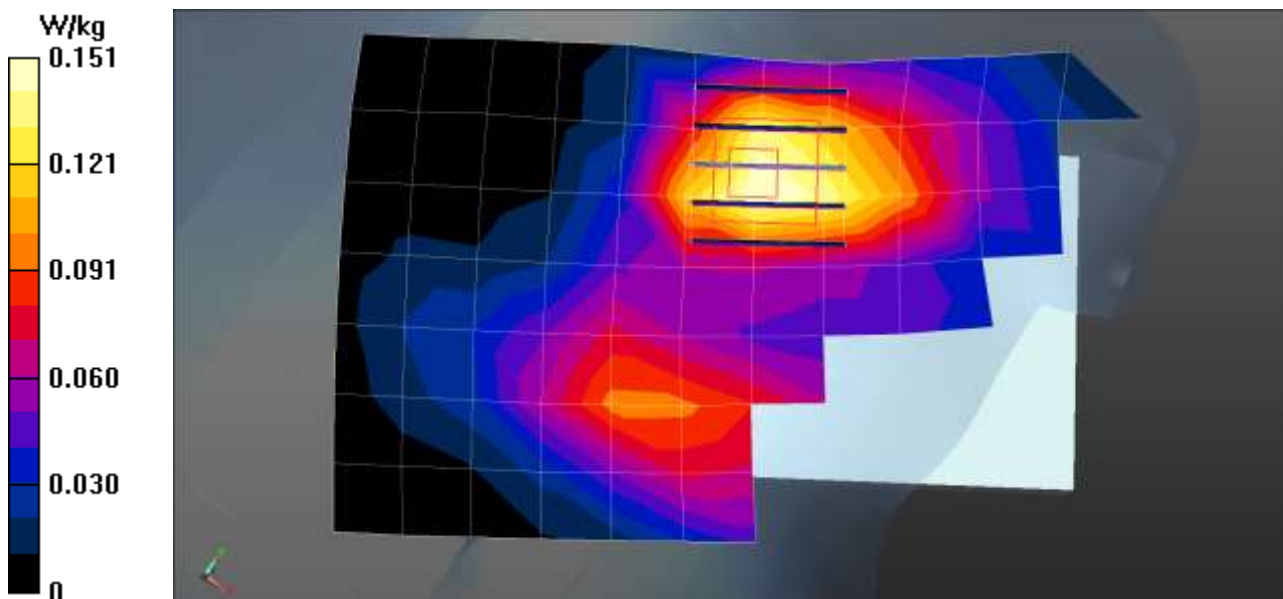

Test Laboratory: HCT CO., LTD
 EUT Type: GSM/WCDMA/LTE Phone with Bluetooth4.2LE, WIFI802.11 b/g/n
 Liquid Temperature: 20.9 °C
 Ambient Temperature: 21.1 °C
 Test Date: 05/30/2017
 Plot No.: 5

DUT: LG-M700TV; Type: bar

Communication System: WCDMA850; Frequency: 836.6 MHz;Duty Cycle: 1:1
 Medium parameters used (interpolated): $f = 836.6$ MHz; $\sigma = 0.915$ mho/m; $\epsilon_r = 41.9$; $\rho = 1000$ kg/m³
 Phantom section: Left Section

DASY4 Configuration:

- Probe: ET3DV6 - SN1630; ConvF(7.26, 7.26, 7.26); Calibrated: 2017-02-27
- Sensor-Surface: 4mm (Mechanical Surface Detection)
- Electronics: DAE4 Sn652; Calibrated: 2017-01-20
- Phantom: SAM
- Measurement SW: DASY4, V4.7 Build 80
- Postprocessing SW: SEMCAD, V1.8 Build 186

WCDMA850 Head Left touch 4183ch/Area Scan (7x12x1): Measurement grid: dx=15mm, dy=15mm
 Maximum value of SAR (measured) = 0.221 mW/g

WCDMA850 Head Left touch 4183ch/Zoom Scan (5x5x7)/Cube 0: Measurement grid: dx=8mm, dy=8mm, dz=5mm

Reference Value = 4.73 V/m; Power Drift = 0.042 dB

Peak SAR (extrapolated) = 0.269 W/kg

SAR(1 g) = 0.223 mW/g; SAR(10 g) = 0.174 mW/g

Maximum value of SAR (measured) = 0.231 mW/g

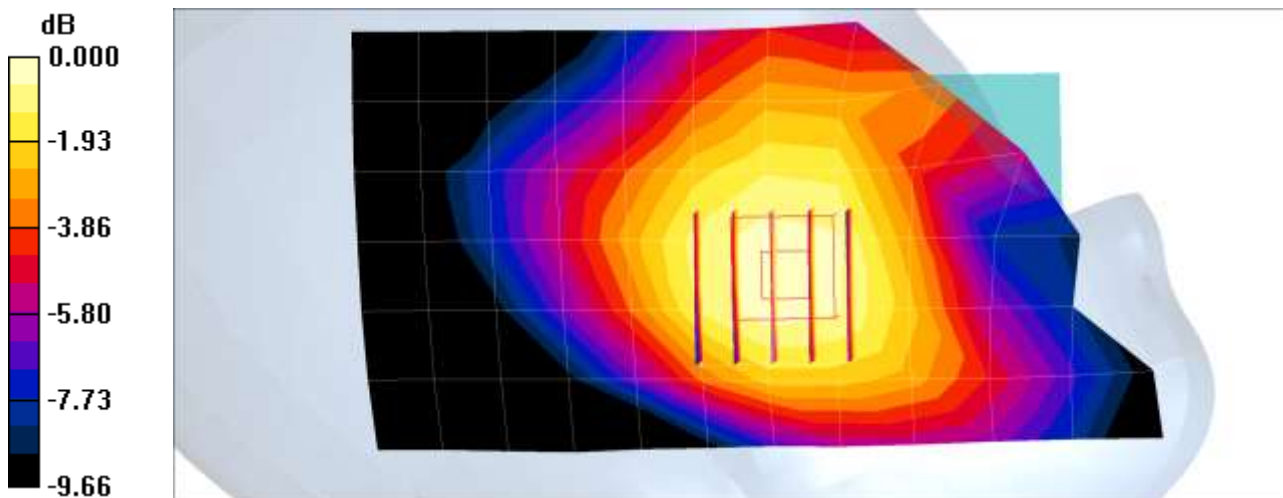

0 dB = 0.231mW/g

Test Laboratory:	HCT CO., LTD
EUT Type:	GSM/WCDMA/LTE Phone with Bluetooth4.2LE, WIFI802.11 b/g/n
Liquid Temperature:	20.7 °C
Ambient Temperature:	20.5 °C
Test Date:	05/26/2017
Plot No.:	6

DUT: LG-M700TV; Type: Bar

Communication System: UID 0, WCDMA1900; Frequency: 1880 MHz;Duty Cycle: 1:1
 Medium parameters used: $f = 1880 \text{ MHz}$; $\sigma = 1.39 \text{ S/m}$; $\epsilon_r = 39.844$; $\rho = 1000 \text{ kg/m}^3$
 Phantom section: Left Section

DASY5 Configuration:

- Probe: ET3DV6 - SN1605; ConvF(5.18, 5.18, 5.18); Calibrated: 2016-07-29;
- Sensor-Surface: 4mm (Mechanical Surface Detection)
- Electronics: DAE3 Sn446; Calibrated: 2017-01-19
- Phantom: SAM
- Measurement SW: DASY52, Version 52.8 (1);

WCDMA1900 Head Left Touch 9400ch/Area Scan (8x13x1): Measurement grid: $dx=15\text{mm}$, $dy=15\text{mm}$
 Maximum value of SAR (measured) = 0.218 W/kg

WCDMA1900 Head Left Touch 9400ch/Zoom Scan (5x5x7)/Cube 0: Measurement grid: $dx=8\text{mm}$, $dy=8\text{mm}$, $dz=5\text{mm}$

Reference Value = 4.502 V/m; Power Drift = 0.00 dB

Peak SAR (extrapolated) = 0.298 W/kg

SAR(1 g) = 0.190 W/kg; SAR(10 g) = 0.112 W/kg

Maximum value of SAR (measured) = 0.208 W/kg

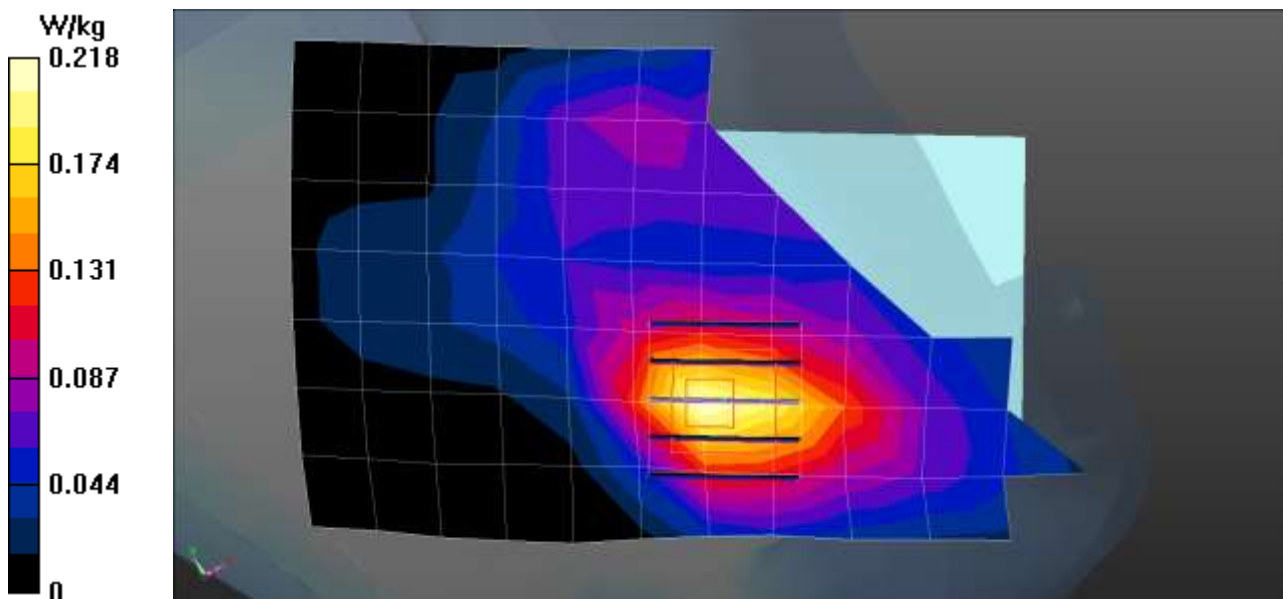

Test Laboratory: HCT CO., LTD
 EUT Type: GSM/WCDMA/LTE Phone with Bluetooth4.2LE, WIFI802.11 b/g/n
 Liquid Temperature: 20.7 °C
 Ambient Temperature: 20.5 °C
 Test Date: 05/26/2017
 Plot No.: 7

DUT: LG-M700TV; Type: Bar

Communication System: UID 0, LTE Band 2; Frequency: 1900 MHz;Duty Cycle: 1:1
 Medium parameters used: $f = 1900$ MHz; $\sigma = 1.41$ S/m; $\epsilon_r = 39.841$; $\rho = 1000$ kg/m³
 Phantom section: Left Section

DASY5 Configuration:

- Probe: ET3DV6 - SN1605; ConvF(5.18, 5.18, 5.18); Calibrated: 2016-07-29;
- Sensor-Surface: 4mm (Mechanical Surface Detection)
- Electronics: DAE3 Sn446; Calibrated: 2017-01-19
- Phantom: SAM
- Measurement SW: DASY52, Version 52.8 (1);

LTE Band2 Head Left Touch QPSK 20MHz 1RB 49offset 19100ch/Area Scan (8x12x1): Measurement grid: dx=15mm, dy=15mm
 Maximum value of SAR (measured) = 0.180 W/kg

LTE Band2 Head Left Touch QPSK 20MHz 1RB 49offset 19100ch/Zoom Scan (5x5x7)/Cube 0: Measurement grid: dx=8mm, dy=8mm, dz=5mm
 Reference Value = 4.314 V/m; Power Drift = 0.09 dB
 Peak SAR (extrapolated) = 0.251 W/kg
SAR(1 g) = 0.169 W/kg; SAR(10 g) = 0.102 W/kg
 Maximum value of SAR (measured) = 0.181 W/kg

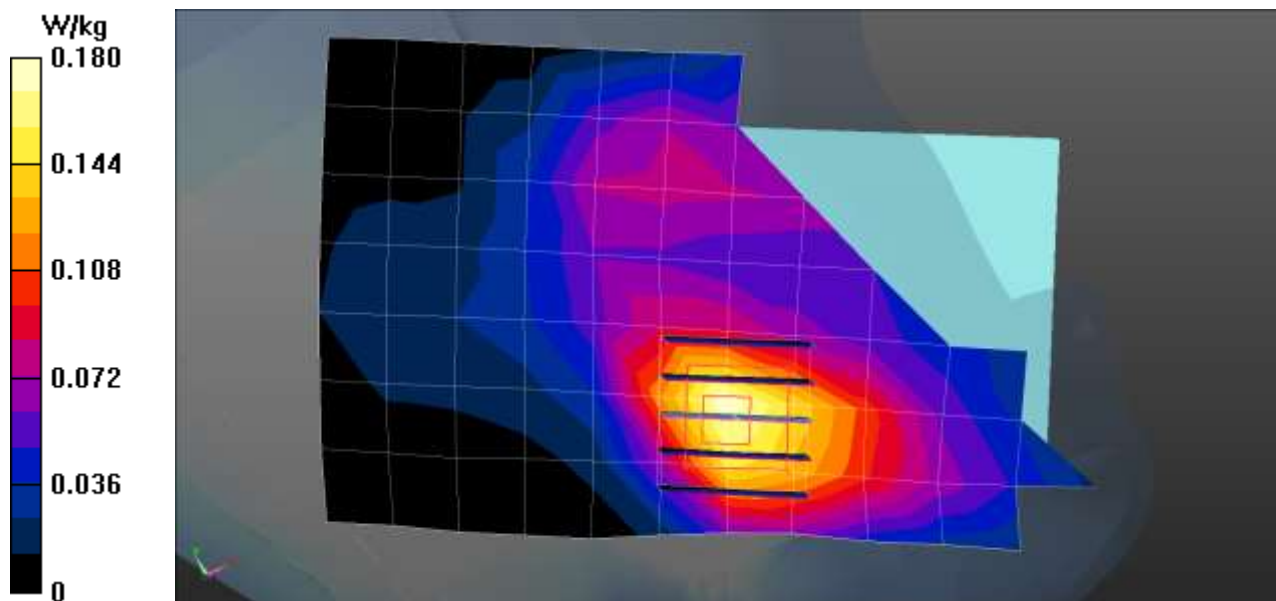

Test Laboratory: HCT CO., LTD
 EUT Type: GSM/WCDMA/LTE Phone with Bluetooth4.2LE, WIFI802.11 b/g/n
 Liquid Temperature: 20.5 °C
 Ambient Temperature: 20.7 °C
 Test Date: 06/01/2017
 Plot No.: 8

DUT: LG-M700TV; Type: Bar

Communication System: UID 0, LTE 7 (0); Frequency: 2535 MHz;Duty Cycle: 1:1
 Medium parameters used (interpolated): $f = 2535 \text{ MHz}$; $\sigma = 1.93 \text{ S/m}$; $\epsilon_r = 38.734$; $\rho = 1000 \text{ kg/m}^3$
 Phantom section: Left Section

DASY5 Configuration:

- Probe: EX3DV4 - SN3797; ConvF(6.97, 6.97, 6.97); Calibrated: 2016-11-25;
- Sensor-Surface: 2mm (Mechanical Surface Detection)
- Electronics: DAE4 Sn1225; Calibrated: 2016-11-24
- Phantom: SAM
- Measurement SW: DASY52, Version 52.8 (8);

LTE Band 7 Head Left Touch QPSK 20MHz 1RB 49offset 21100ch/Area Scan (9x15x1): Measurement grid: $dx=12\text{mm}$, $dy=12\text{mm}$
 Maximum value of SAR (measured) = 0.322 W/kg

LTE Band 7 Head Left Touch QPSK 20MHz 1RB 49offset 21100ch/Zoom Scan (7x7x7)/Cube 0: Measurement grid: $dx=5\text{mm}$, $dy=5\text{mm}$, $dz=5\text{mm}$
 Reference Value = 3.542 V/m; Power Drift = 0.12 dB
 Peak SAR (extrapolated) = 0.435 W/kg
SAR(1 g) = 0.241 W/kg; SAR(10 g) = 0.130 W/kg
 Maximum value of SAR (measured) = 0.330 W/kg

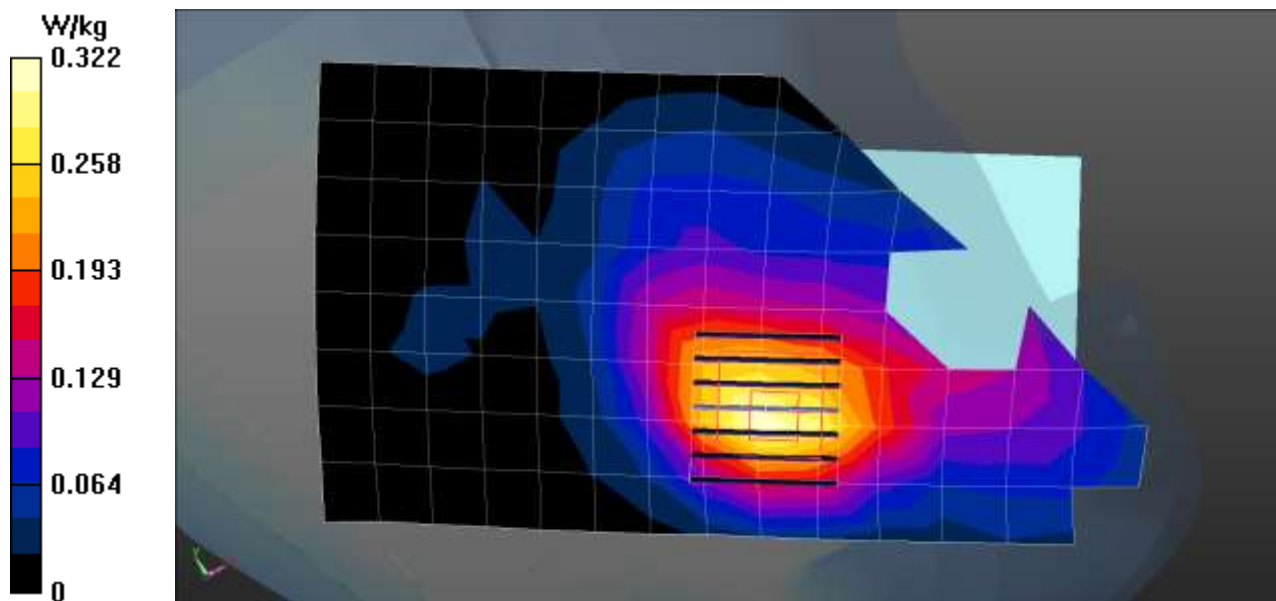

Test Laboratory: HCT CO., LTD
 EUT Type: GSM/WCDMA/LTE Phone with Bluetooth4.2LE, WIFI802.11 b/g/n
 Liquid Temperature: 22.1 °C
 Ambient Temperature: 22.4 °C
 Test Date: 05/23/2017
 Plot No.: 9

DUT: LG-M700TV; Type: bar

Communication System: LTE Band 17; Frequency: 710 MHz;Duty Cycle: 1:1
 Medium parameters used: $f = 710 \text{ MHz}$; $\sigma = 0.854 \text{ mho/m}$; $\epsilon_r = 41.8$; $\rho = 1000 \text{ kg/m}^3$
 Phantom section: Left Section

DASY4 Configuration:

- Probe: ET3DV6 - SN1630; ConvF(7.74, 7.74, 7.74); Calibrated: 2017-02-27
- Sensor-Surface: 4mm (Mechanical Surface Detection)
- Electronics: DAE4 Sn652; Calibrated: 2017-01-20
- Phantom: SAM
- Measurement SW: DASY4, V4.7 Build 80
- Postprocessing SW: SEMCAD, V1.8 Build 186

LTE Band17 Head Left Touch QPSK 10MHz 1RB 24offset 23790ch/Area Scan (7x12x1): Measurement grid: $dx=15\text{mm}$, $dy=15\text{mm}$
 Maximum value of SAR (measured) = 0.114 mW/g

LTE Band17 Head Left Touch QPSK 10MHz 1RB 24offset 23790ch/Zoom Scan (5x5x7)/Cube 0:
 Measurement grid: $dx=8\text{mm}$, $dy=8\text{mm}$, $dz=5\text{mm}$
 Reference Value = 4.81 V/m; Power Drift = -0.073 dB
 Peak SAR (extrapolated) = 0.125 W/kg
SAR(1 g) = 0.111 mW/g; SAR(10 g) = 0.091 mW/g
 Maximum value of SAR (measured) = 0.115 mW/g

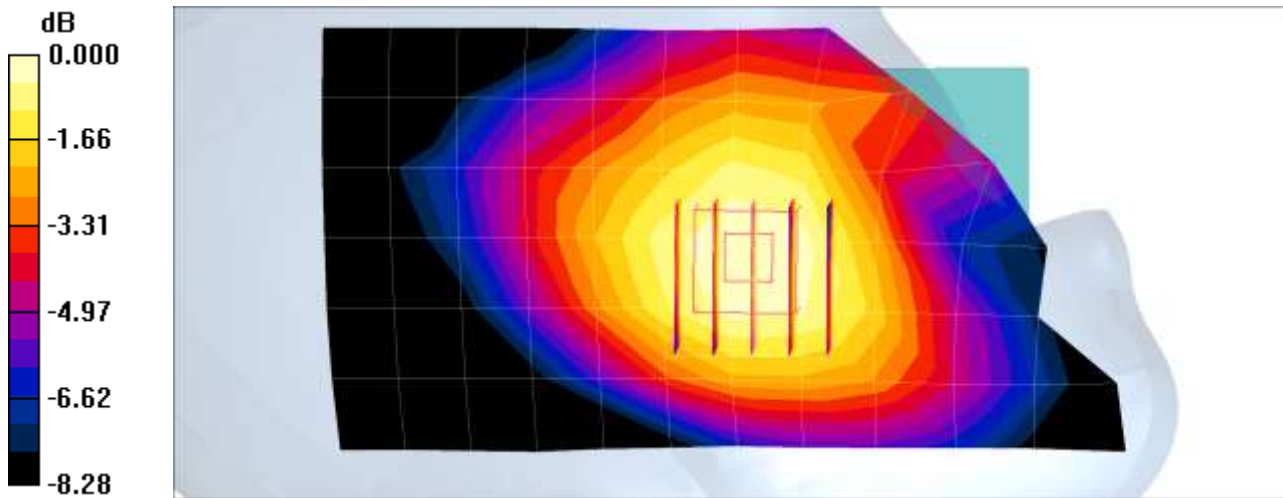

0 dB = 0.115mW/g

Test Laboratory: HCT CO., LTD
EUT Type: GSM/WCDMA/LTE Phone with Bluetooth4.2LE, WIFI802.11 b/g/n
Liquid Temperature: 21.2 °C
Ambient Temperature: 21.4 °C
Test Date: 05/26/2017
Plot No.: 10

DUT: LG-M700TV; Type: Bar

Communication System: UID 0, 2450MHz FCC (0); Frequency: 2437 MHz;Duty Cycle: 1:1
Medium parameters used (interpolated): $f = 2437$ MHz; $\sigma = 1.833$ S/m; $\epsilon_r = 38.606$; $\rho = 1000$ kg/m³
Phantom section: Right Section

DASY5 Configuration:

- Probe: EX3DV4 - SN3797; ConvF(7.21, 7.21, 7.21); Calibrated: 2016-11-25;
- Sensor-Surface: 2mm (Mechanical Surface Detection)
- Electronics: DAE4 Sn1225; Calibrated: 2016-11-24
- Phantom: SAM
- Measurement SW: DASY52, Version 52.8 (8);

802.11b Head Right touch 1Mbps 6ch/Area Scan (9x15x1): Measurement grid: dx=12mm, dy=12mm
Maximum value of SAR (measured) = 0.818 W/kg

802.11b Head Right touch 1Mbps 6ch/Zoom Scan (7x7x7)/Cube 0: Measurement grid: dx=5mm, dy=5mm, dz=5mm

Reference Value = 7.632 V/m; Power Drift = -0.00 dB

Peak SAR (extrapolated) = 1.77 W/kg

SAR(1 g) = 0.667 W/kg; SAR(10 g) = 0.275 W/kg

Maximum value of SAR (measured) = 1.18 W/kg

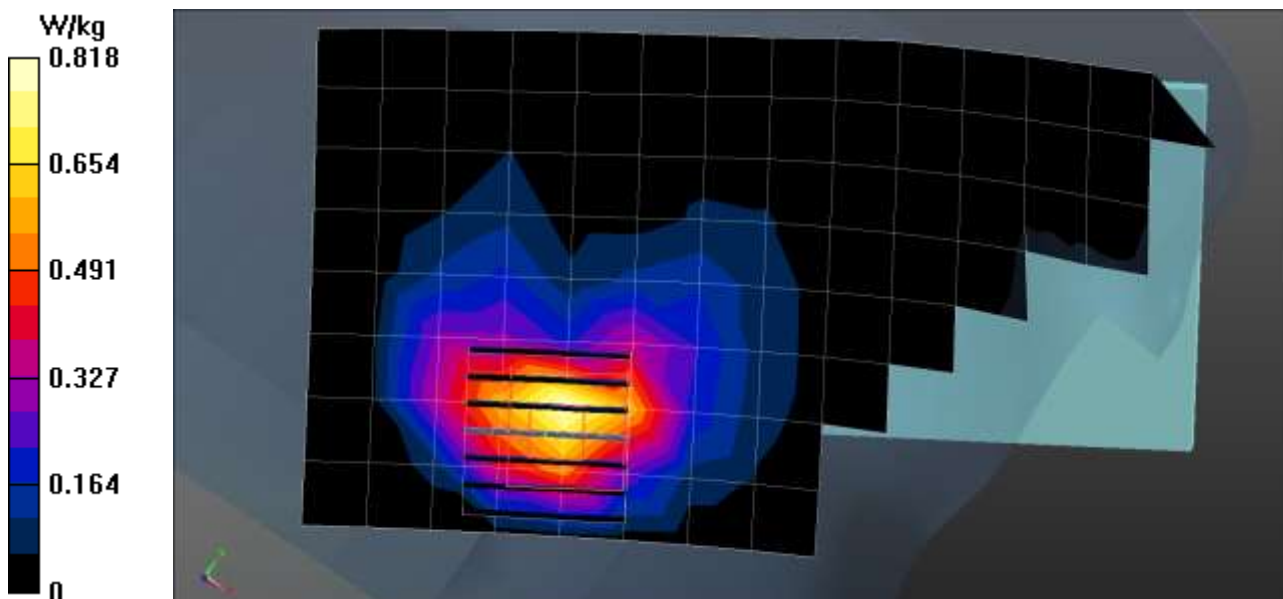

Test Laboratory: HCT CO., LTD
 EUT Type: GSM/WCDMA/LTE Phone with Bluetooth4.2LE, WIFI802.11 b/g/n
 Liquid Temperature: 20.1 °C
 Ambient Temperature: 20.3 °C
 Test Date: 06/07/2017
 Plot No.: 11

DUT: LG-M700TV; Type: Bar

Communication System: UID 0, Bluetooth (0); Frequency: 2441 MHz; Duty Cycle: 1:1.308
 Medium parameters used (interpolated): $f = 2441$ MHz; $\sigma = 1.823$ S/m; $\epsilon_r = 38.716$; $\rho = 1000$ kg/m³
 Phantom section: Right Section

DASY5 Configuration:

- Probe: EX3DV4 - SN3797; ConvF(7.21, 7.21, 7.21); Calibrated: 2016-11-25;
- Sensor-Surface: 2mm (Mechanical Surface Detection)
- Electronics: DAE4 Sn1225; Calibrated: 2016-11-24
- Phantom: SAM
- Measurement SW: DASY52, Version 52.8 (8);

BT Head Right Touch DH5 39ch/Area Scan (9x14x1): Measurement grid: dx=12mm, dy=12mm
 Maximum value of SAR (measured) = 0.163 W/kg

BT Head Right Touch DH5 39ch/Zoom Scan (7x7x7)/Cube 0: Measurement grid: dx=5mm, dy=5mm, dz=5mm

Reference Value = 3.096 V/m; Power Drift = 0.16 dB

Peak SAR (extrapolated) = 0.422 W/kg

SAR(1 g) = 0.162 W/kg; SAR(10 g) = 0.067 W/kg

Maximum value of SAR (measured) = 0.267 W/kg

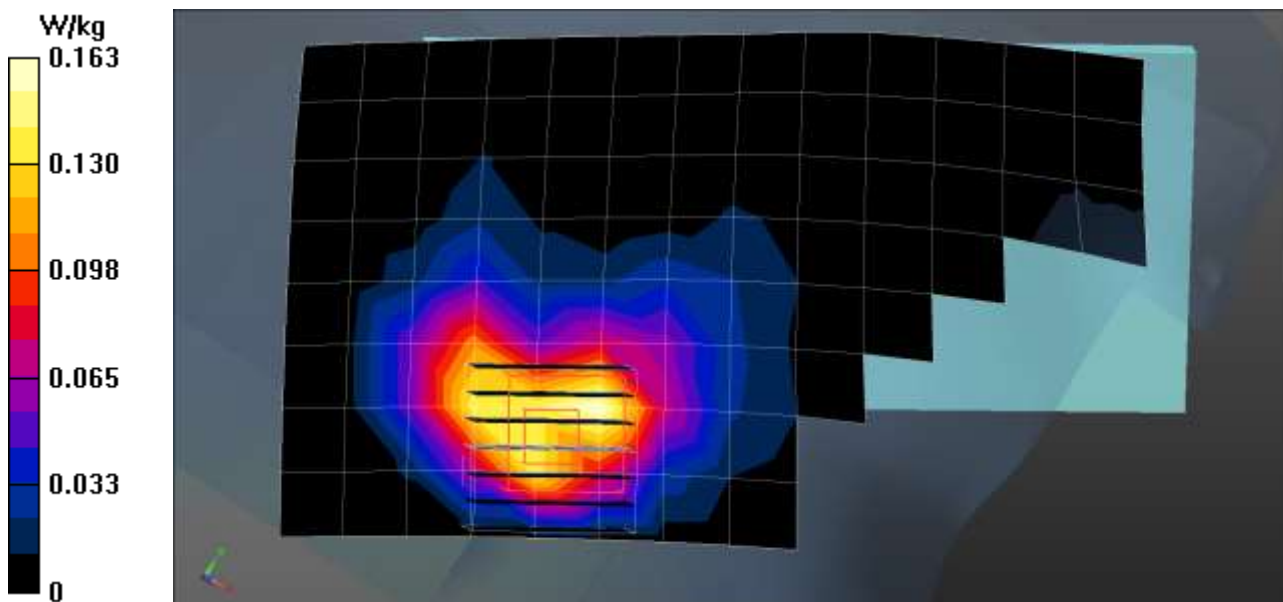

Test Laboratory: HCT CO., LTD
 EUT Type: GSM/WCDMA/LTE Phone with Bluetooth4.2LE, WIFI802.11 b/g/n
 Liquid Temperature: 22.5 °C
 Ambient Temperature: 22.7 °C
 Test Date: 05/31/2017
 Plot No.: 12

DUT: LG-M700TV; Type: bar

Communication System: UID 0, GSM 850; Frequency: 836.6 MHz; Duty Cycle: 1:8.3
 Medium parameters used (interpolated): $f = 836.6 \text{ MHz}$; $\sigma = 0.956 \text{ S/m}$; $\epsilon_r = 56.375$; $\rho = 1000 \text{ kg/m}^3$
 Phantom section: Center Section

DASY Configuration:

- Probe: ET3DV6 - SN1630; ConvF(6.73, 6.73, 6.73); Calibrated: 2017-02-27;
- Sensor-Surface: 4mm (Mechanical Surface Detection)
- Electronics: DAE4 Sn652; Calibrated: 2017-01-20
- Phantom: Triple Flat Phantom 5
- Measurement SW: DASY4, Version 4.7 (80);

GSM850 Body Rear Voice 190ch/Area Scan (7x13x1): Measurement grid: dx=15mm, dy=15mm
 Maximum value of SAR (measured) = 0.283 W/kg

GSM850 Body Rear Voice 190ch/Zoom Scan (5x5x7)/Cube 0: Measurement grid: dx=8mm, dy=8mm, dz=5mm

Reference Value = 11.70 V/m; Power Drift = -0.09 dB

Peak SAR (extrapolated) = 0.359 W/kg

SAR(1 g) = 0.270 W/kg; SAR(10 g) = 0.192 W/kg

Maximum value of SAR (measured) = 0.285 W/kg

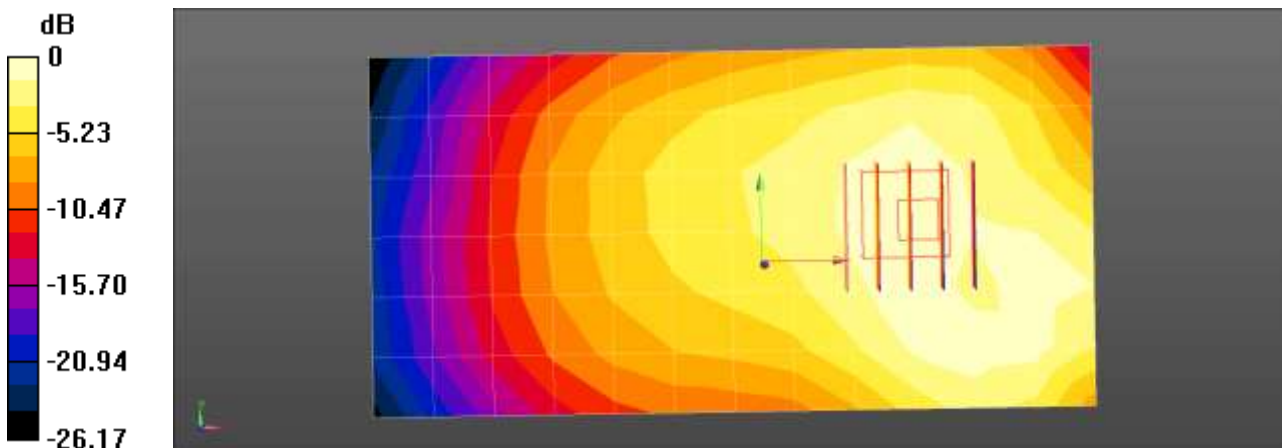

0 dB = 0.283 W/kg = -5.48 dBW/kg

Test Laboratory:	HCT CO., LTD
EUT Type:	GSM/WCDMA/LTE Phone with Bluetooth4.2LE, WIFI802.11 b/g/n
Liquid Temperature:	22.5 °C
Ambient Temperature:	22.7 °C
Test Date:	05/31/2017
Plot No.:	13

DUT: LG-M700TV; Type: bar

Communication System: UID 0, GSM 850; Frequency: 836.6 MHz; Duty Cycle: 1:2.075
 Medium parameters used (interpolated): $f = 836.6$ MHz; $\sigma = 0.956$ S/m; $\epsilon_r = 56.375$; $\rho = 1000$ kg/m³
 Phantom section: Center Section

DASY5 Configuration:

- Probe: ET3DV6 - SN1630; ConvF(6.73, 6.73, 6.73); Calibrated: 2017-02-27;
- Sensor-Surface: 4mm (Mechanical Surface Detection)
- Electronics: DAE4 Sn652; Calibrated: 2017-01-20
- Phantom: Triple Flat Phantom
- Measurement SW: DASY4, Version 4.7 (80);

GSM850 Body Rear 4Tx 190ch/Area Scan (7x13x1): Measurement grid: dx=15mm, dy=15mm
 Maximum value of SAR (measured) = 0.452 W/kg

GSM850 Body Rear 4Tx 190ch/Zoom Scan (5x5x7)/Cube 0: Measurement grid: dx=8mm, dy=8mm, dz=5mm

Reference Value = 14.44 V/m; Power Drift = 0.05 dB

Peak SAR (extrapolated) = 0.623 W/kg

SAR(1 g) = 0.450 W/kg; SAR(10 g) = 0.313 W/kg

Maximum value of SAR (measured) = 0.481 W/kg

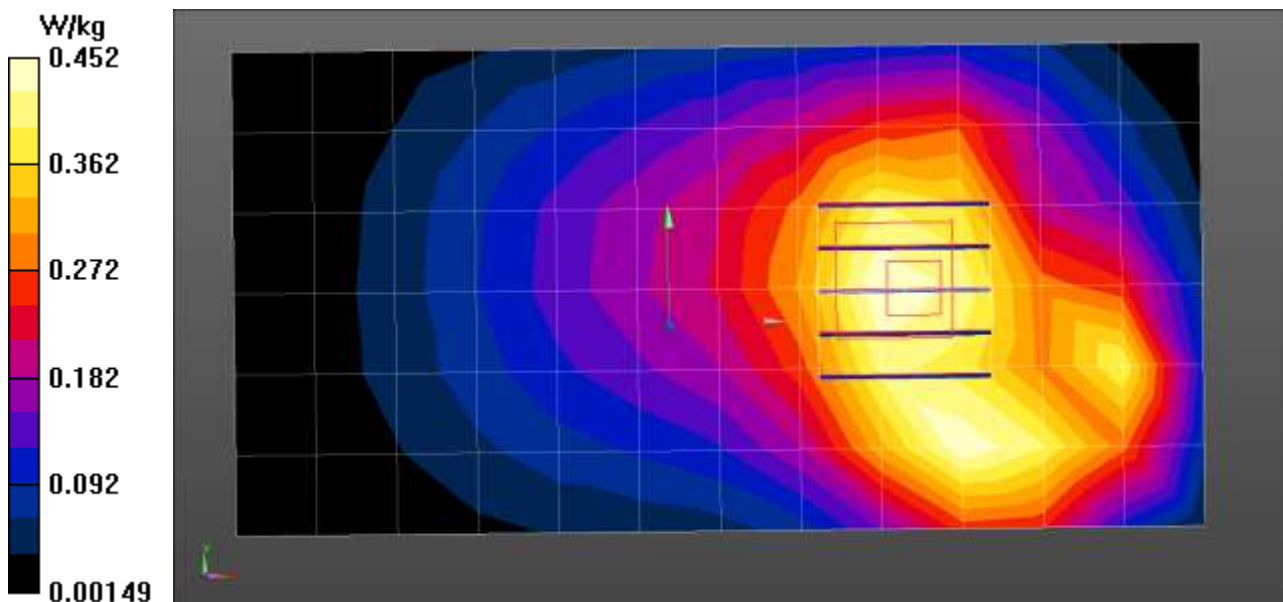

Test Laboratory: HCT CO., LTD
EUT Type: GSM/WCDMA/LTE Phone with Bluetooth4.2LE, WIFI802.11 b/g/n
Liquid Temperature: 21.5 °C
Ambient Temperature: 21.7 °C
Test Date: 05/30/2017
Plot No.: 14

DUT: LG-M700TV; Type: Bar

Communication System: UID 0, GSM 1900 (0); Frequency: 1880 MHz;Duty Cycle: 1:8.30042
Medium parameters used: $f = 1880$ MHz; $\sigma = 1.555$ S/m; $\epsilon_r = 52.747$; $\rho = 1000$ kg/m³
Phantom section: Center Section

DASY5 Configuration:

- Probe: EX3DV4 - SN3797; ConvF(7.45, 7.45, 7.45); Calibrated: 2016-11-25;
- Sensor-Surface: 2mm (Mechanical Surface Detection)
- Electronics: DAE4 Sn1225; Calibrated: 2016-11-24
- Phantom: Triple Flat Phantom
- Measurement SW: DASY52, Version 52.8 (8);

GSM1900 Body Rear 661ch Body worn/Area Scan (8x13x1): Measurement grid: dx=15mm, dy=15mm
Maximum value of SAR (measured) = 0.437 W/kg

GSM1900 Body Rear 661ch Body worn/Zoom Scan (5x5x7)/Cube 0: Measurement grid: dx=8mm, dy=8mm, dz=5mm

Reference Value = 5.187 V/m; Power Drift = -0.02 dB

Peak SAR (extrapolated) = 0.569 W/kg

SAR(1 g) = 0.366 W/kg; SAR(10 g) = 0.224 W/kg

Maximum value of SAR (measured) = 0.471 W/kg

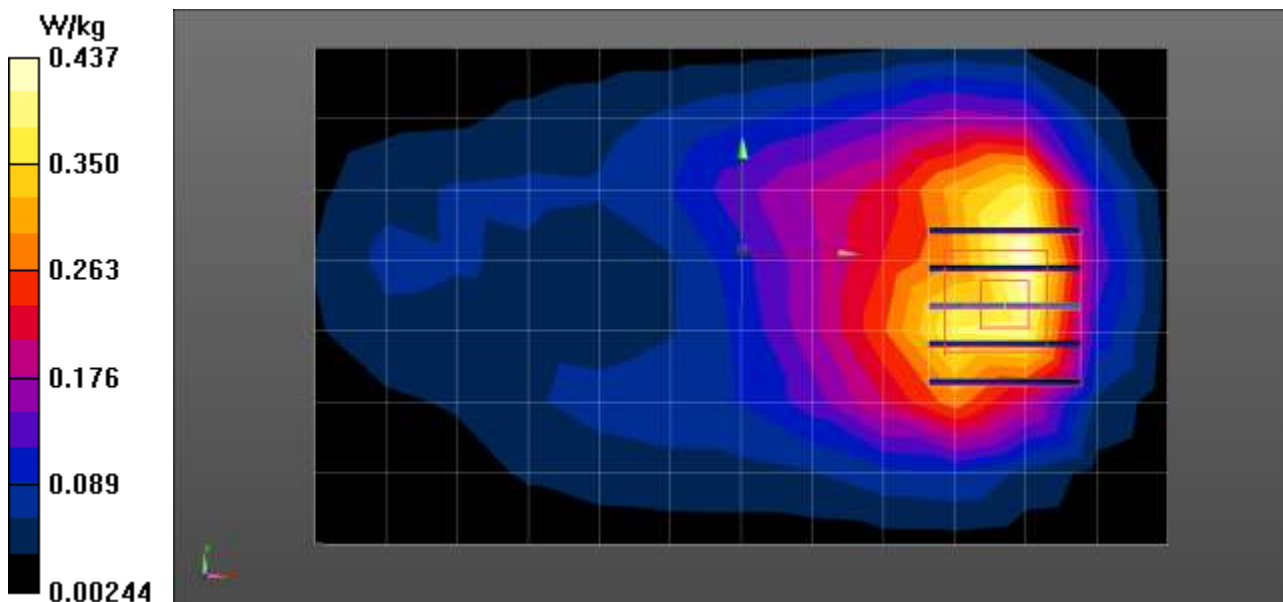

Test Laboratory: HCT CO., LTD
 EUT Type: GSM/WCDMA/LTE Phone with Bluetooth4.2LE, WIFI802.11 b/g/n
 Liquid Temperature: 21.5 °C
 Ambient Temperature: 21.7 °C
 Test Date: 05/30/2017
 Plot No.: 15

DUT: LG-M700TV; Type: Bar

Communication System: UID 0, GSM 1900 4TX (0); Frequency: 1880 MHz; Duty Cycle: 1:2.07491
 Medium parameters used: $f = 1880 \text{ MHz}$; $\sigma = 1.555 \text{ S/m}$; $\epsilon_r = 52.747$; $\rho = 1000 \text{ kg/m}^3$
 Phantom section: Center Section

DASY5 Configuration:

- Probe: EX3DV4 - SN3797; ConvF(7.45, 7.45, 7.45); Calibrated: 2016-11-25;
- Sensor-Surface: 2mm (Mechanical Surface Detection)
- Electronics: DAE4 Sn1225; Calibrated: 2016-11-24
- Phantom: Triple Flat Phantom
- Measurement SW: DASY52, Version 52.8 (8);

GSM1900 Body Rear 4Tx 661ch/Area Scan (8x13x1): Measurement grid: $dx=15\text{mm}$, $dy=15\text{mm}$
 Maximum value of SAR (measured) = 0.518 W/kg

GSM1900 Body Rear 4Tx 661ch/Zoom Scan (5x5x7)/Cube 0: Measurement grid: $dx=8\text{mm}$, $dy=8\text{mm}$, $dz=5\text{mm}$

Reference Value = 8.798 V/m; Power Drift = -0.01 dB

Peak SAR (extrapolated) = 0.655 W/kg

SAR(1 g) = 0.426 W/kg; SAR(10 g) = 0.264 W/kg

Maximum value of SAR (measured) = 0.553 W/kg

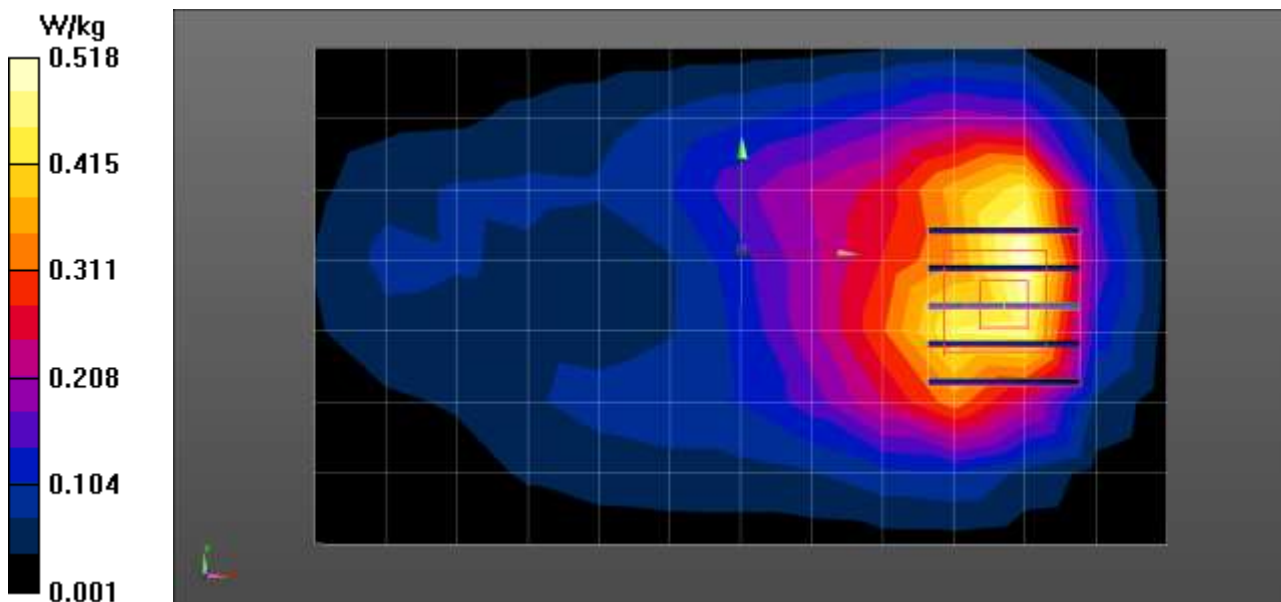

Test Laboratory: HCT CO., LTD
 EUT Type: GSM/WCDMA/LTE Phone with Bluetooth4.2LE, WIFI802.11 b/g/n
 Liquid Temperature: 22.5 °C
 Ambient Temperature: 22.7 °C
 Test Date: 05/31/2017
 Plot No.: 16

DUT: LG-M700TV; Type: bar

Communication System: WCDMA850; Frequency: 836.6 MHz;Duty Cycle: 1:1
 Medium parameters used (interpolated): $f = 836.6$ MHz; $\sigma = 0.956$ mho/m; $\epsilon_r = 56.4$; $\rho = 1000$ kg/m³
 Phantom section: Center Section

DASY4 Configuration:

- Probe: ET3DV6 - SN1630; ConvF(6.73, 6.73, 6.73); Calibrated: 2017-02-27
- Sensor-Surface: 4mm (Mechanical Surface Detection)
- Electronics: DAE4 Sn652; Calibrated: 2017-01-20
- Phantom: Triple Flat Phantom
- Measurement SW: DASY4, V4.7 Build 80
- Postprocessing SW: SEMCAD, V1.8 Build 186

WCDMA850 Body Rear 4183ch/Area Scan (7x13x1): Measurement grid: dx=15mm, dy=15mm
 Maximum value of SAR (measured) = 0.653 mW/g

WCDMA850 Body Rear 4183ch/Zoom Scan (5x5x7)/Cube 0: Measurement grid: dx=8mm, dy=8mm, dz=5mm
 Reference Value = 17.7 V/m; Power Drift = 0.014 dB
 Peak SAR (extrapolated) = 0.848 W/kg
SAR(1 g) = 0.633 mW/g; SAR(10 g) = 0.447 mW/g
 Maximum value of SAR (measured) = 0.669 mW/g

WCDMA850 Body Rear 4183ch/Zoom Scan (5x5x7)/Cube 1: Measurement grid: dx=8mm, dy=8mm, dz=5mm
 Reference Value = 17.7 V/m; Power Drift = 0.014 dB
 Peak SAR (extrapolated) = 0.927 W/kg
SAR(1 g) = 0.544 mW/g; SAR(10 g) = 0.336 mW/g
 Maximum value of SAR (measured) = 0.603 mW/g

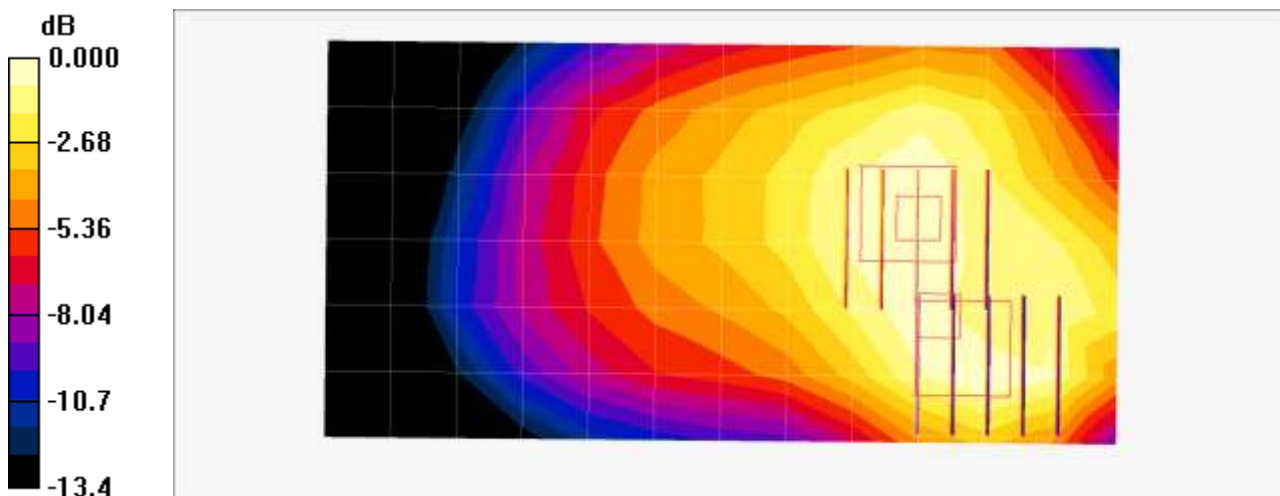

0 dB = 0.603mW/g

Test Laboratory: HCT CO., LTD
 EUT Type: GSM/WCDMA/LTE Phone with Bluetooth4.2LE, WIFI802.11 b/g/n
 Liquid Temperature: 21.5 °C
 Ambient Temperature: 21.7 °C
 Test Date: 05/30/2017
 Plot No.: 17

DUT: LG-M700TV; Type: Bar

Communication System: UID 0, WCDMA1900 (0); Frequency: 1880 MHz; Duty Cycle: 1:1
 Medium parameters used: $f = 1880 \text{ MHz}$; $\sigma = 1.555 \text{ S/m}$; $\epsilon_r = 52.747$; $\rho = 1000 \text{ kg/m}^3$
 Phantom section: Center Section

DASY5 Configuration:

- Probe: EX3DV4 - SN3797; ConvF(7.45, 7.45, 7.45); Calibrated: 2016-11-25;
- Sensor-Surface: 2mm (Mechanical Surface Detection)
- Electronics: DAE4 Sn1225; Calibrated: 2016-11-24
- Phantom: Triple Flat Phantom
- Measurement SW: DASY52, Version 52.8 (8);

WCDMA1900 Body Rear 9400ch/Area Scan (8x13x1): Measurement grid: dx=15mm, dy=15mm
 Maximum value of SAR (measured) = 0.659 W/kg

WCDMA1900 Body Rear 9400ch/Zoom Scan (5x5x7)/Cube 0: Measurement grid: dx=8mm, dy=8mm, dz=5mm

Reference Value = 9.964 V/m; Power Drift = -0.16 dB

Peak SAR (extrapolated) = 0.820 W/kg

SAR(1 g) = 0.533 W/kg; SAR(10 g) = 0.331 W/kg

Maximum value of SAR (measured) = 0.688 W/kg

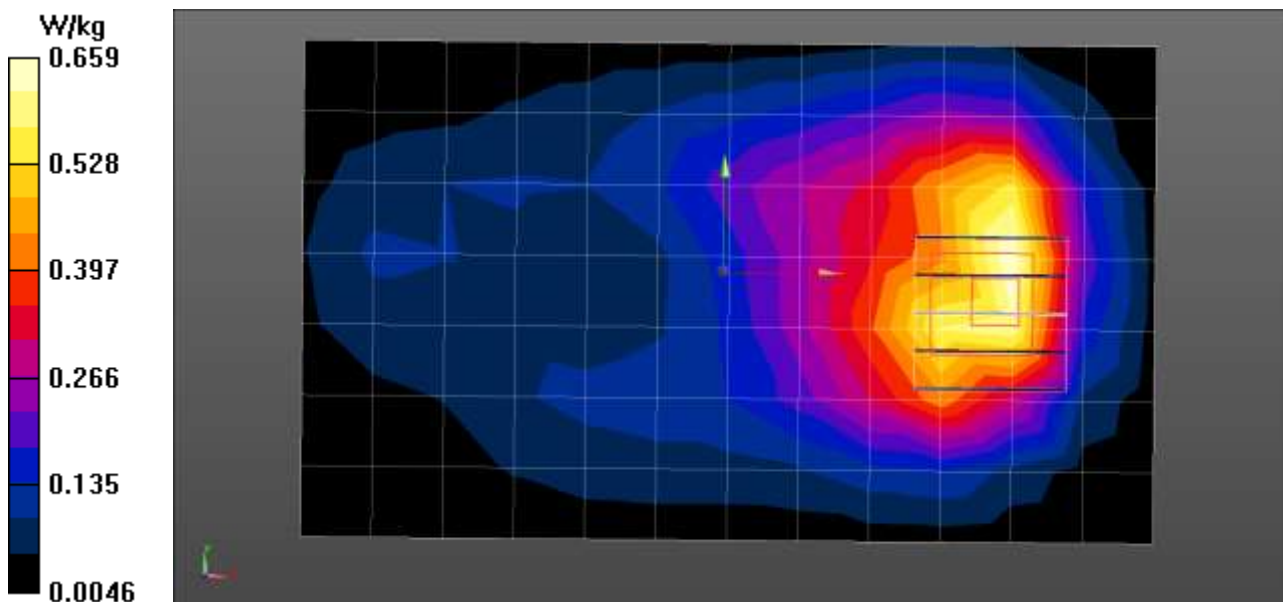

Test Laboratory: HCT CO., LTD
EUT Type: GSM/WCDMA/LTE Phone with Bluetooth4.2LE, WIFI802.11 b/g/n
Liquid Temperature: 21.5 °C
Ambient Temperature: 21.7 °C
Test Date: 05/30/2017
Plot No.: 18

DUT: LG-M700TV; Type: Bar

Communication System: UID 0, LTE Band 2 (0); Frequency: 1900 MHz;Duty Cycle: 1:1
Medium parameters used: $f = 1900$ MHz; $\sigma = 1.57$ S/m; $\epsilon_r = 52.708$; $\rho = 1000$ kg/m³
Phantom section: Center Section

DASY5 Configuration:

- Probe: EX3DV4 - SN3797; ConvF(7.45, 7.45, 7.45); Calibrated: 2016-11-25;
- Sensor-Surface: 2mm (Mechanical Surface Detection)
- Electronics: DAE4 Sn1225; Calibrated: 2016-11-24
- Phantom: Triple Flat Phantom
- Measurement SW: DASY52, Version 52.8 (8);

LTE Band 2 Body Rear QPSK 20MHz 1RB 49offset 19100ch/Area Scan (8x13x1): Measurement grid:
dx=15mm, dy=15mm
Maximum value of SAR (measured) = 0.877 W/kg

LTE Band 2 Body Rear QPSK 20MHz 1RB 49offset 19100ch/Zoom Scan (5x5x7)/Cube 0: Measurement grid: dx=8mm, dy=8mm, dz=5mm
Reference Value = 7.772 V/m; Power Drift = 0.01 dB
Peak SAR (extrapolated) = 1.19 W/kg
SAR(1 g) = 0.763 W/kg; SAR(10 g) = 0.460 W/kg
Maximum value of SAR (measured) = 0.993 W/kg

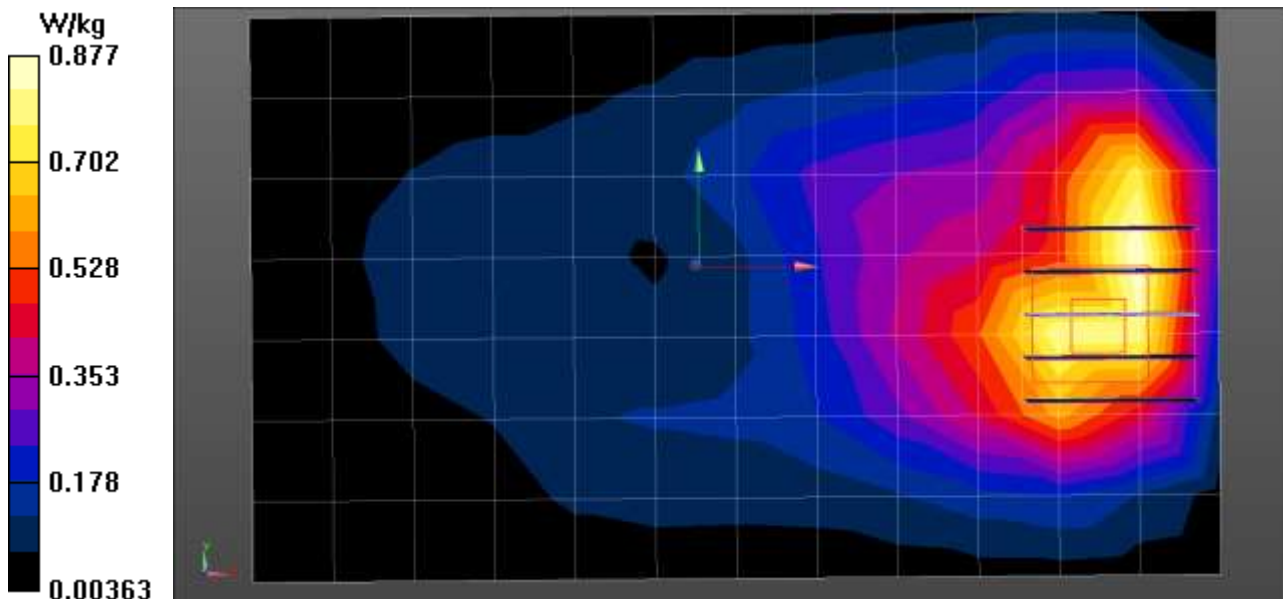

Test Laboratory: HCT CO., LTD
 EUT Type: GSM/WCDMA/LTE Phone with Bluetooth4.2LE, WIFI802.11 b/g/n
 Liquid Temperature: 22.5 °C
 Ambient Temperature: 22.7 °C
 Test Date: 05/31/2017
 Plot No.: 19

DUT: LG-M700TV; Type: bar

Communication System: UID 0, LTE Band 7; Frequency: 2535 MHz;Duty Cycle: 1:1
 Medium parameters used (interpolated): $f = 2535 \text{ MHz}$; $\sigma = 2.084 \text{ S/m}$; $\epsilon_r = 51.29$; $\rho = 1000 \text{ kg/m}^3$
 Phantom section: Center Section

DASY5 Configuration:

- Probe: EX3DV4 - SN7370; ConvF(7.42, 7.42, 7.42); Calibrated: 2016-08-30;
- Sensor-Surface: 2mm (Mechanical Surface Detection)
- Electronics: DAE4 Sn1417; Calibrated: 2017-01-19
- Phantom: Triple Flat Phantom
- Measurement SW: DASY4, Version 4.7 (80);

LTE Band7 Body Rear QPSK 20MHz 1RB 49offset 21100ch/Area Scan (9x15x1): Measurement grid:
 $dx=12\text{mm}$, $dy=12\text{mm}$
 Maximum value of SAR (measured) = 0.286 W/kg

LTE Band7 Body Rear QPSK 20MHz 1RB 49offset 21100ch/Zoom Scan (7x7x7)/Cube 0: Measurement grid: $dx=5\text{mm}$, $dy=5\text{mm}$, $dz=5\text{mm}$
 Reference Value = 7.712 V/m; Power Drift = -0.00 dB
 Peak SAR (extrapolated) = 0.379 W/kg
SAR(1 g) = 0.203 W/kg; SAR(10 g) = 0.112 W/kg
 Maximum value of SAR (measured) = 0.282 W/kg

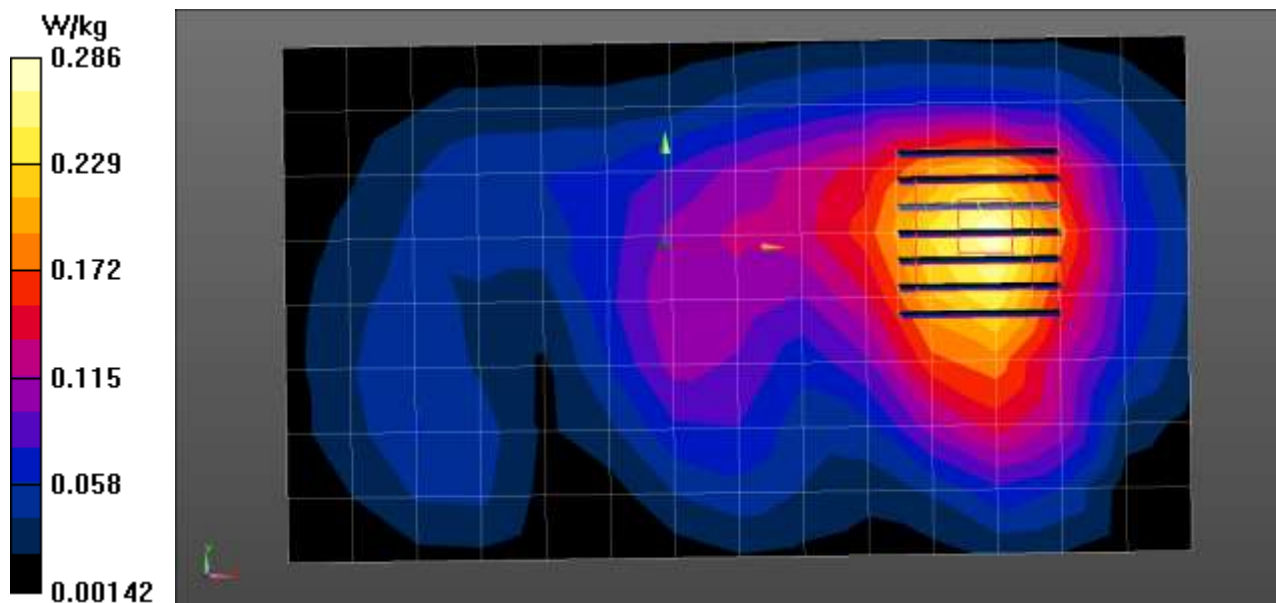

Test Laboratory: HCT CO., LTD
 EUT Type: GSM/WCDMA/LTE Phone with Bluetooth4.2LE, WIFI802.11 b/g/n
 Liquid Temperature: 21.7 °C
 Ambient Temperature: 21.9 °C
 Test Date: 05/18/2017
 Plot No.: 20

DUT: LG-M700TV; Type: bar

Communication System: LTE Band 17; Frequency: 710 MHz; Duty Cycle: 1:1
 Medium parameters used: $f = 710 \text{ MHz}$; $\sigma = 0.916 \text{ mho/m}$; $\epsilon_r = 55.9$; $\rho = 1000 \text{ kg/m}^3$
 Phantom section: Center Section

DASY4 Configuration:

- Probe: ET3DV6 - SN1630; ConvF(6.91, 6.91, 6.91); Calibrated: 2017-02-27
- Sensor-Surface: 4mm (Mechanical Surface Detection)
- Electronics: DAE4 Sn652; Calibrated: 2017-01-20
- Phantom: Triple Flat Phantom
- Measurement SW: DASY4, V4.7 Build 80
- Postprocessing SW: SEMCAD, V1.8 Build 186

LTE Band17 Body Rear QPSK 10MHz 1RB 24offset 23790ch/Area Scan (8x12x1): Measurement grid:
 $dx=15\text{mm}$, $dy=15\text{mm}$
 Maximum value of SAR (measured) = 0.596 mW/g

LTE Band17 Body Rear QPSK 10MHz 1RB 24offset 23790ch/Zoom Scan (5x5x7)/Cube 0: Measurement grid: $dx=8\text{mm}$, $dy=8\text{mm}$, $dz=5\text{mm}$
 Reference Value = 14.8 V/m; Power Drift = -0.019 dB
 Peak SAR (extrapolated) = 0.900 W/kg
SAR(1 g) = 0.551 mW/g; SAR(10 g) = 0.352 mW/g
 Maximum value of SAR (measured) = 0.597 mW/g

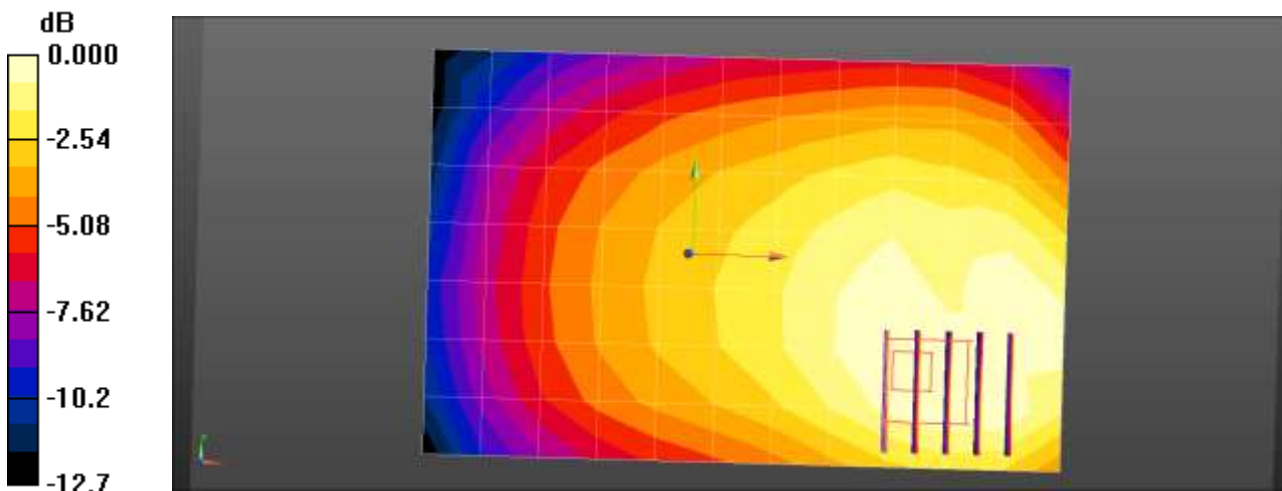

0 dB = 0.597mW/g

Test Laboratory:	HCT CO., LTD
EUT Type:	GSM/WCDMA/LTE Phone with Bluetooth4.2LE, WIFI802.11 b/g/n
Liquid Temperature:	21.2 °C
Ambient Temperature:	21.4 °C
Test Date:	05/26/2017
Plot No.:	21

DUT: LG-M700TV; Type: Bar

Communication System: UID 0, 2450MHz FCC (0); Frequency: 2437 MHz;Duty Cycle: 1:1
 Medium parameters used (interpolated): $f = 2437$ MHz; $\sigma = 1.918$ S/m; $\epsilon_r = 52.427$; $\rho = 1000$ kg/m³
 Phantom section: Center Section

DASY5 Configuration:

- Probe: EX3DV4 - SN3797; ConvF(7.19, 7.19, 7.19); Calibrated: 2016-11-25;
- Sensor-Surface: 2mm (Mechanical Surface Detection)
- Electronics: DAE4 Sn1225; Calibrated: 2016-11-24
- Phantom: Triple Flat Phantom
- Measurement SW: DASY52, Version 52.8 (8);

802.11b Body Rear 1Mbps 6ch/Area Scan (10x15x1): Measurement grid: dx=12mm, dy=12mm
 Maximum value of SAR (measured) = 0.215 W/kg

802.11b Body Rear 1Mbps 6ch/Zoom Scan (7x7x7)/Cube 0: Measurement grid: dx=5mm, dy=5mm, dz=5mm

Reference Value = 5.813 V/m; Power Drift = -0.12 dB

Peak SAR (extrapolated) = 0.281 W/kg

SAR(1 g) = 0.146 W/kg; SAR(10 g) = 0.073 W/kg

Maximum value of SAR (measured) = 0.213 W/kg

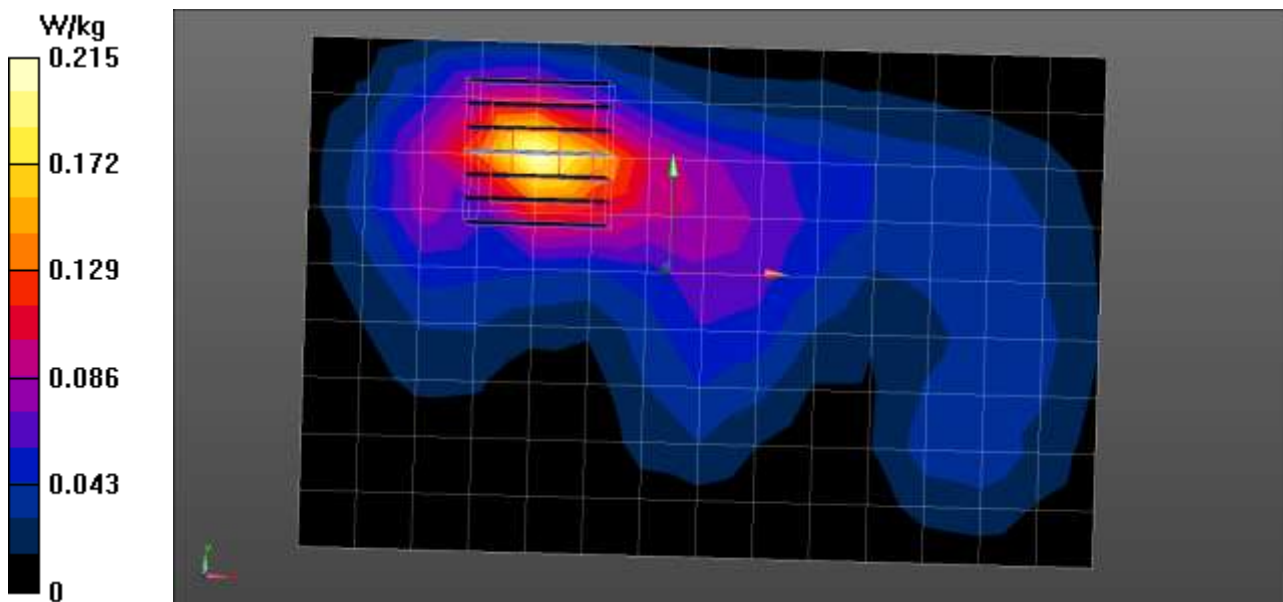

Test Laboratory: HCT CO., LTD
EUT Type: GSM/WCDMA/LTE Phone with Bluetooth4.2LE, WIFI802.11 b/g/n
Liquid Temperature: 21.5 °C
Ambient Temperature: 21.7 °C
Test Date: 05/30/2017
Plot No.: 22

DUT: LG-M700TV; Type: Bar

Communication System: UID 0, GSM 1900 4TX (0); Frequency: 1880 MHz;Duty Cycle: 1:2.07491
Medium parameters used: $f = 1880$ MHz; $\sigma = 1.555$ S/m; $\epsilon_r = 52.747$; $\rho = 1000$ kg/m³
Phantom section: Center Section

DASY5 Configuration:

- Probe: EX3DV4 - SN3797; ConvF(7.45, 7.45, 7.45); Calibrated: 2016-11-25;
- Sensor-Surface: 2mm (Mechanical Surface Detection)
- Electronics: DAE4 Sn1225; Calibrated: 2016-11-24
- Phantom: Triple Flat Phantom
- Measurement SW: DASY52, Version 52.8 (8);

GSM1900 Body Bottom 4Tx 661ch/Area Scan (8x6x1): Measurement grid: dx=15mm, dy=15mm
Maximum value of SAR (measured) = 0.903 W/kg

GSM1900 Body Bottom 4Tx 661ch/Zoom Scan (5x5x7)/Cube 0: Measurement grid: dx=8mm, dy=8mm, dz=5mm

Reference Value = 22.83 V/m; Power Drift = 0.18 dB

Peak SAR (extrapolated) = 1.10 W/kg

SAR(1 g) = 0.712 W/kg; SAR(10 g) = 0.397 W/kg

Maximum value of SAR (measured) = 0.946 W/kg

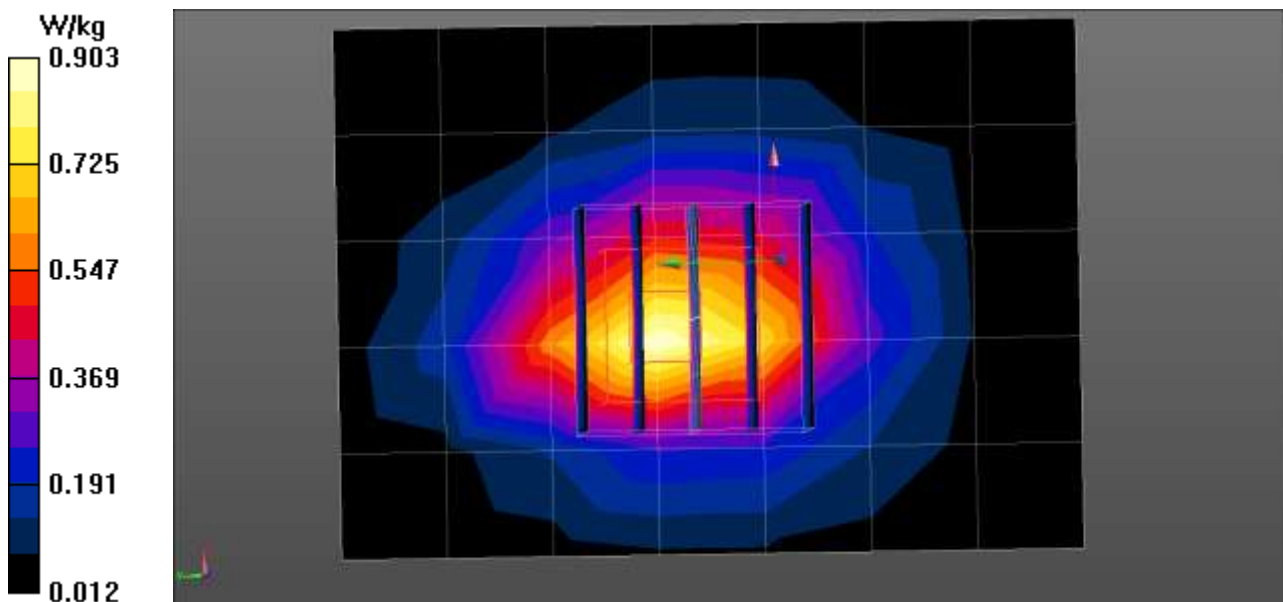

Test Laboratory: HCT CO., LTD
 EUT Type: GSM/WCDMA/LTE Phone with Bluetooth4.2LE, WIFI802.11 b/g/n
 Liquid Temperature: 21.5 °C
 Ambient Temperature: 21.7 °C
 Test Date: 05/30/2017
 Plot No.: 23

DUT: LG-M700TV; Type: Bar

Communication System: UID 0, WCDMA1900 (0); Frequency: 1907.6 MHz;Duty Cycle: 1:1
 Medium parameters used (interpolated): $f = 1907.6$ MHz; $\sigma = 1.576$ S/m; $\epsilon_r = 52.702$; $\rho = 1000$ kg/m³
 Phantom section: Center Section

DASY5 Configuration:

- Probe: EX3DV4 - SN3797; ConvF(7.45, 7.45, 7.45); Calibrated: 2016-11-25;
- Sensor-Surface: 2mm (Mechanical Surface Detection)
- Electronics: DAE4 Sn1225; Calibrated: 2016-11-24
- Phantom: Triple Flat Phantom
- Measurement SW: DASY52, Version 52.8 (8);

WCDMA1900 Body Bottom 9538ch/Area Scan (8x6x1): Measurement grid: dx=15mm, dy=15mm
 Maximum value of SAR (measured) = 1.31 W/kg

WCDMA1900 Body Bottom 9538ch/Zoom Scan (5x5x7)/Cube 0: Measurement grid: dx=8mm, dy=8mm, dz=5mm

Reference Value = 27.80 V/m; Power Drift = 0.06 dB

Peak SAR (extrapolated) = 1.69 W/kg

SAR(1 g) = 1.05 W/kg; SAR(10 g) = 0.602 W/kg

Maximum value of SAR (measured) = 1.38 W/kg

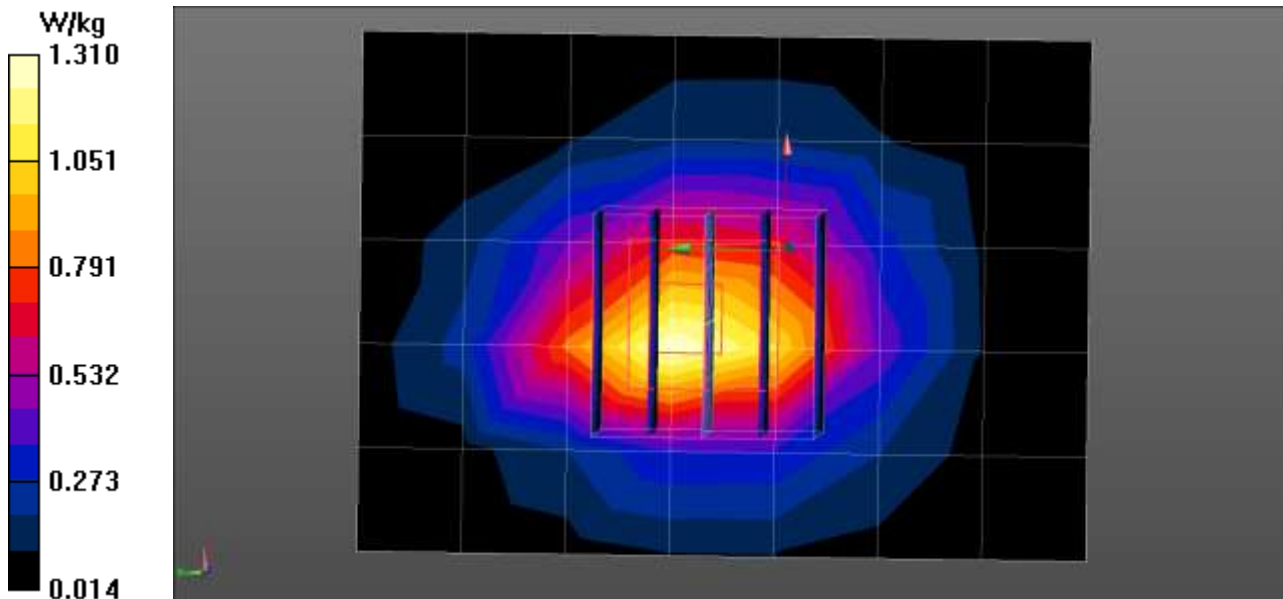

Test Laboratory: HCT CO., LTD
 EUT Type: GSM/WCDMA/LTE Phone with Bluetooth4.2LE, WIFI802.11 b/g/n
 Liquid Temperature: 22.5 °C
 Ambient Temperature: 22.7 °C
 Test Date: 05/31/2017
 Plot No.: 24

DUT: LG-M700TV; Type: bar

Communication System: UID 0, LTE Band 7; Frequency: 2535 MHz; Duty Cycle: 1:1
 Medium parameters used (interpolated): $f = 2535 \text{ MHz}$; $\sigma = 2.084 \text{ S/m}$; $\epsilon_r = 51.29$; $\rho = 1000 \text{ kg/m}^3$
 Phantom section: Center Section

DASY5 Configuration:

- Probe: EX3DV4 - SN7370; ConvF(7.42, 7.42, 7.42); Calibrated: 2016-08-30;
- Sensor-Surface: 2mm (Mechanical Surface Detection)
- Electronics: DAE4 Sn1417; Calibrated: 2017-01-19
- Phantom: Triple Flat Phantom
- Measurement SW: DASY4, Version 4.7 (80);

LTE Band7 Body Front QPSK 20MHz 1RB 49offset 21100ch/Area Scan (9x15x1): Measurement grid:
 $dx=12\text{mm}$, $dy=12\text{mm}$
 Maximum value of SAR (measured) = 0.349 W/kg

LTE Band7 Body Front QPSK 20MHz 1RB 49offset 21100ch/Zoom Scan (7x7x7)/Cube 0: Measurement grid: $dx=5\text{mm}$, $dy=5\text{mm}$, $dz=5\text{mm}$
 Reference Value = 6.724 V/m; Power Drift = 0.02 dB
 Peak SAR (extrapolated) = 0.487 W/kg
SAR(1 g) = 0.260 W/kg; SAR(10 g) = 0.142 W/kg
 Maximum value of SAR (measured) = 0.363 W/kg

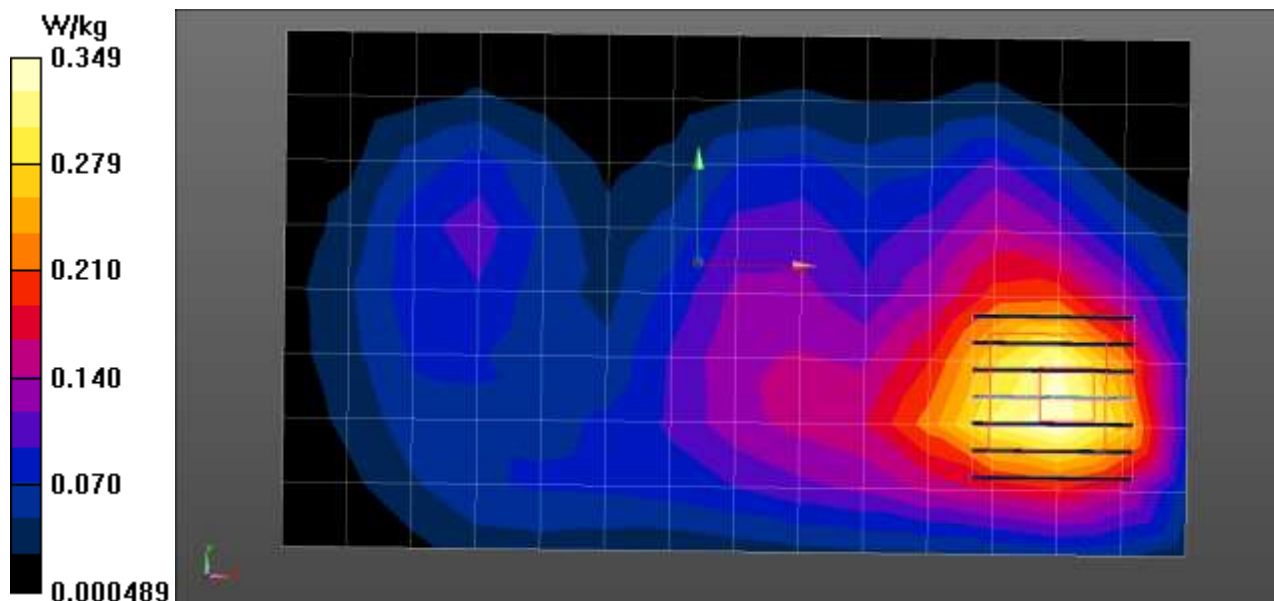

Test Laboratory: HCT CO., LTD
 EUT Type: GSM/WCDMA/LTE Phone with Bluetooth4.2LE, WIFI802.11 b/g/n
 Liquid Temperature: 21.7 °C
 Ambient Temperature: 21.9 °C
 Test Date: 05/18/2017
 Plot No.: 25

DUT: LG-M700TV; Type: bar

Communication System: LTE Band 17; Frequency: 710 MHz; Duty Cycle: 1:1
 Medium parameters used: $f = 710 \text{ MHz}$; $\sigma = 0.916 \text{ mho/m}$; $\epsilon_r = 55.9$; $\rho = 1000 \text{ kg/m}^3$
 Phantom section: Center Section

DASY4 Configuration:

- Probe: ET3DV6 - SN1630; ConvF(6.91, 6.91, 6.91); Calibrated: 2017-02-27
- Sensor-Surface: 4mm (Mechanical Surface Detection)
- Electronics: DAE4 Sn652; Calibrated: 2017-01-20
- Phantom: Triple Flat Phantom
- Measurement SW: DASY4, V4.7 Build 80
- Postprocessing SW: SEMCAD, V1.8 Build 186

LTE Band17 Body Front QPSK 10MHz 1RB 24offset 23790ch/Area Scan (8x12x1): Measurement grid:
 $dx=15\text{mm}$, $dy=15\text{mm}$
 Maximum value of SAR (measured) = 0.594 mW/g

LTE Band17 Body Front QPSK 10MHz 1RB 24offset 23790ch/Zoom Scan (5x5x7)/Cube 0:
 Measurement grid: $dx=8\text{mm}$, $dy=8\text{mm}$, $dz=5\text{mm}$
 Reference Value = 14.2 V/m; Power Drift = 0.177 dB
 Peak SAR (extrapolated) = 0.975 W/kg
SAR(1 g) = 0.573 mW/g; SAR(10 g) = 0.356 mW/g
 Maximum value of SAR (measured) = 0.616 mW/g

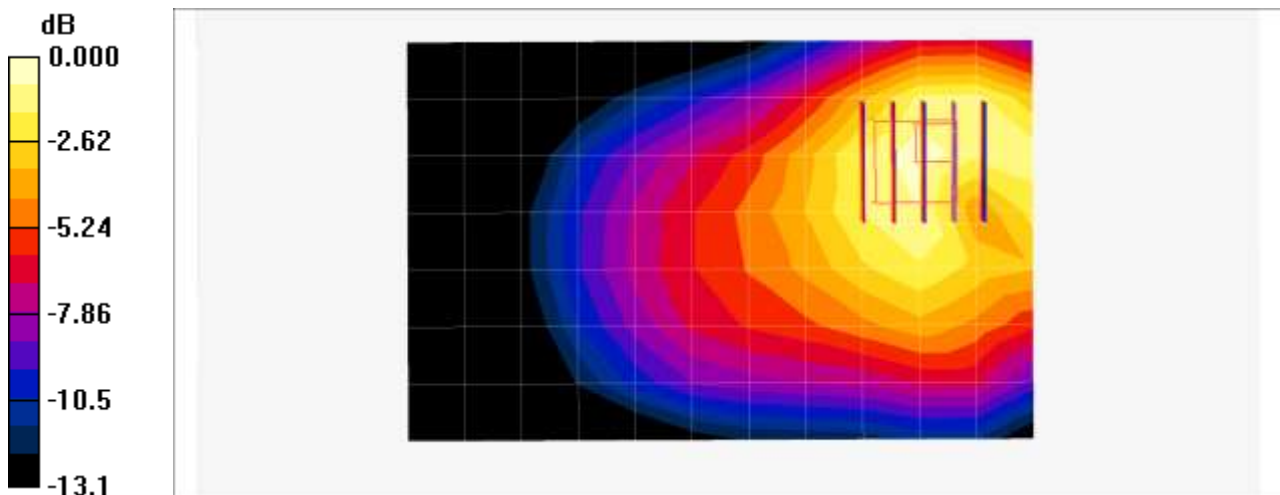

0 dB = 0.616mW/g

Test Laboratory: HCT CO., LTD
EUT Type: GSM/WCDMA/LTE Phone with Bluetooth4.2LE, WIFI802.11 b/g/n
Liquid Temperature: 21.2 °C
Ambient Temperature: 21.4 °C
Test Date: 05/26/2017
Plot No.: 26

DUT: LG-M700TV; Type: Bar

Communication System: UID 0, 2450MHz FCC (0); Frequency: 2437 MHz;Duty Cycle: 1:1
Medium parameters used (interpolated): $f = 2437$ MHz; $\sigma = 1.918$ S/m; $\epsilon_r = 52.427$; $\rho = 1000$ kg/m³
Phantom section: Center Section

DASY5 Configuration:

- Probe: EX3DV4 - SN3797; ConvF(7.19, 7.19, 7.19); Calibrated: 2016-11-25;
- Sensor-Surface: 2mm (Mechanical Surface Detection)
- Electronics: DAE4 Sn1225; Calibrated: 2016-11-24
- Phantom: Triple Flat Phantom
- Measurement SW: DASY52, Version 52.8 (8);

802.11b Body Left 1Mbps 6ch/Area Scan (7x15x1): Measurement grid: dx=12mm, dy=12mm
Maximum value of SAR (measured) = 0.224 W/kg

802.11b Body Left 1Mbps 6ch/Zoom Scan (7x7x7)/Cube 0: Measurement grid: dx=5mm, dy=5mm, dz=5mm

Reference Value = 9.136 V/m; Power Drift = 0.11 dB

Peak SAR (extrapolated) = 0.330 W/kg

SAR(1 g) = 0.165 W/kg; SAR(10 g) = 0.082 W/kg

Maximum value of SAR (measured) = 0.247 W/kg

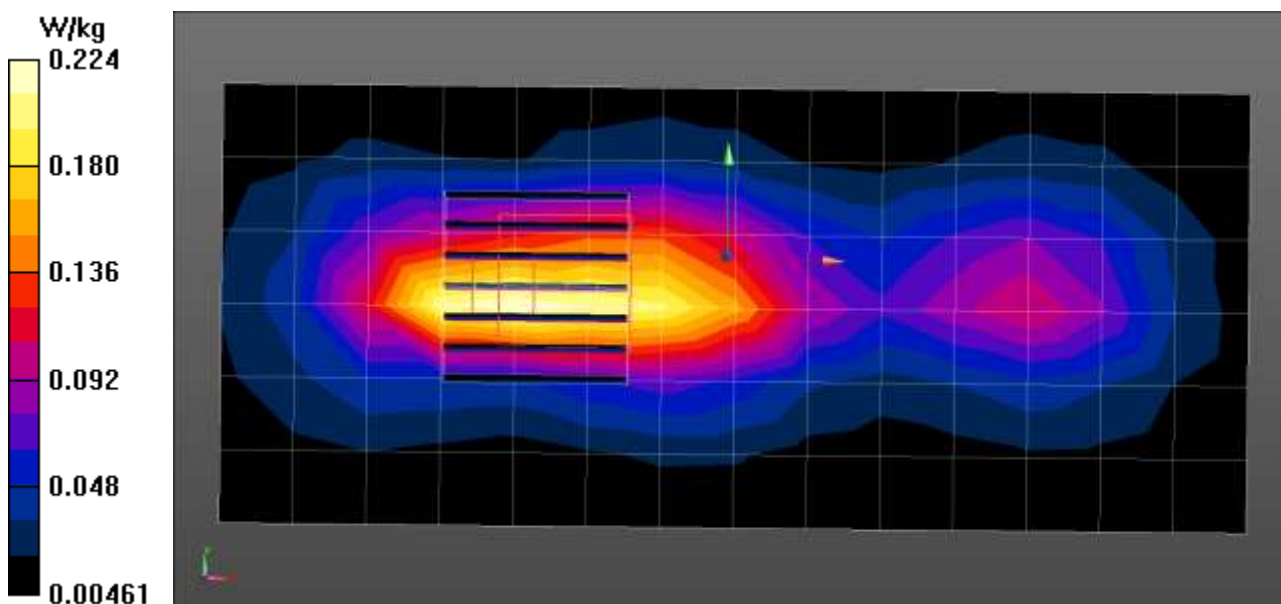

Test Laboratory: HCT CO., LTD
EUT Type: GSM/WCDMA/LTE Phone with Bluetooth4.2LE, WIFI802.11 b/g/n
Liquid Temperature: 21.5 °C
Ambient Temperature: 21.7 °C
Test Date: 05/30/2017
Plot No.: 27

DUT: LG-M700TV; Type: Bar

Communication System: UID 0, WCDMA1900 (0); Frequency: 1907.6 MHz;Duty Cycle: 1:1
Medium parameters used (interpolated): $f = 1907.6$ MHz; $\sigma = 1.576$ S/m; $\epsilon_r = 52.702$; $\rho = 1000$ kg/m³
Phantom section: Center Section

DASY5 Configuration:

- Probe: EX3DV4 - SN3797; ConvF(7.45, 7.45, 7.45); Calibrated: 2016-11-25;
- Sensor-Surface: 2mm (Mechanical Surface Detection)
- Electronics: DAE4 Sn1225; Calibrated: 2016-11-24
- Phantom: Triple Flat Phantom
- Measurement SW: DASY52, Version 52.8 (8);

WCDMA1900 Body Bottom 9538ch/Area Scan (8x6x1): Measurement grid: dx=15mm, dy=15mm
Maximum value of SAR (measured) = 1.27 W/kg

WCDMA1900 Body Bottom 9538ch/Zoom Scan (5x5x7)/Cube 0: Measurement grid: dx=8mm, dy=8mm, dz=5mm

Reference Value = 27.47 V/m; Power Drift = 0.09 dB

Peak SAR (extrapolated) = 1.68 W/kg

SAR(1 g) = 1.04 W/kg; SAR(10 g) = 0.598 W/kg

Maximum value of SAR (measured) = 1.37 W/kg

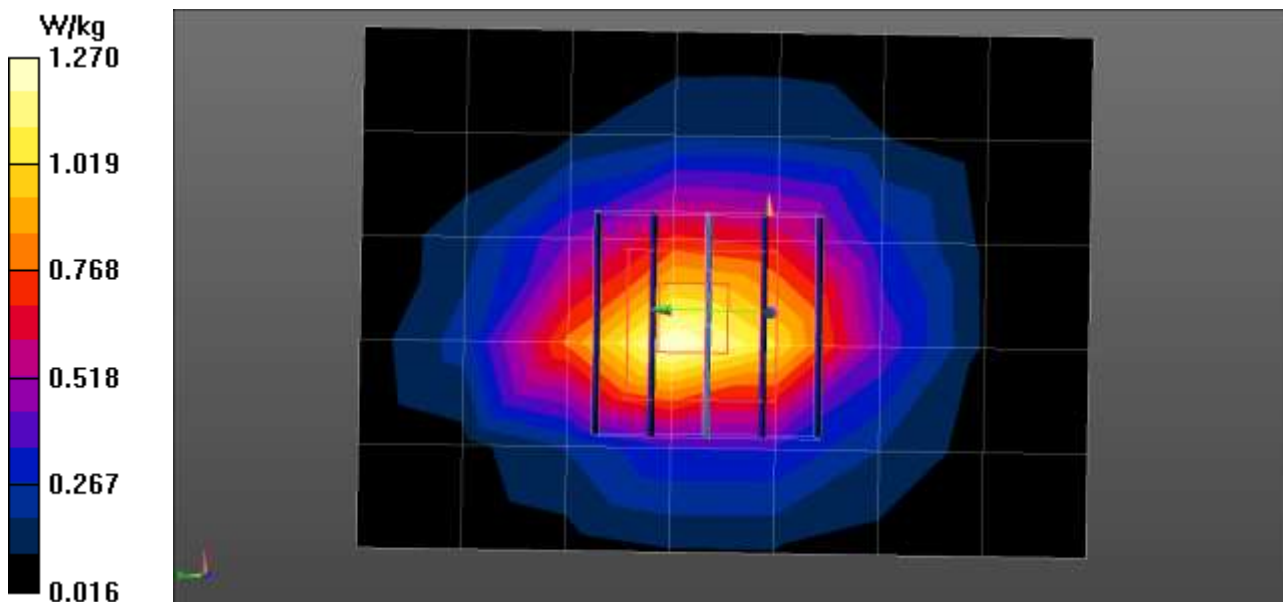

Attachment 2. – Dipole Verification Plots

■ Verification Data (750 MHz Head)

Test Laboratory: HCT CO., LTD
Input Power 100 mW (20 dBm)
Liquid Temp: 22.1 °C
Test Date: 05/23/2017

DUT: Dipole 750 MHz; Type: D750V3

Communication System: CW; Frequency: 750 MHz; Duty Cycle: 1:1
Medium parameters used: $f = 750 \text{ MHz}$; $\sigma = 0.89 \text{ mho/m}$; $\epsilon_r = 41.3$; $\rho = 1000 \text{ kg/m}^3$
Phantom section: Flat Section

DASY4 Configuration:

- Probe: ET3DV6 - SN1630; ConvF(7.74, 7.74, 7.74); Calibrated: 2017-02-27
- Sensor-Surface: 4mm (Mechanical Surface Detection)
- Electronics: DAE4 Sn652; Calibrated: 2017-01-20
- Phantom: SAM
- Measurement SW: DASY4, V4.7 Build 80
- Postprocessing SW: SEMCAD, V1.8 Build 186

750MHz Head Verification/Area Scan (7x9x1): Measurement grid: $dx=15\text{mm}$, $dy=15\text{mm}$
Maximum value of SAR (measured) = 0.894 mW/g

750MHz Head Verification/Zoom Scan (5x5x7)/Cube 0: Measurement grid: $dx=8\text{mm}$, $dy=8\text{mm}$, $dz=5\text{mm}$
Reference Value = 32.5 V/m; Power Drift = 0.196 dB
Peak SAR (extrapolated) = 1.16 W/kg
SAR(1 g) = 0.869 mW/g; SAR(10 g) = 0.588 mW/g
Maximum value of SAR (measured) = 0.945 mW/g

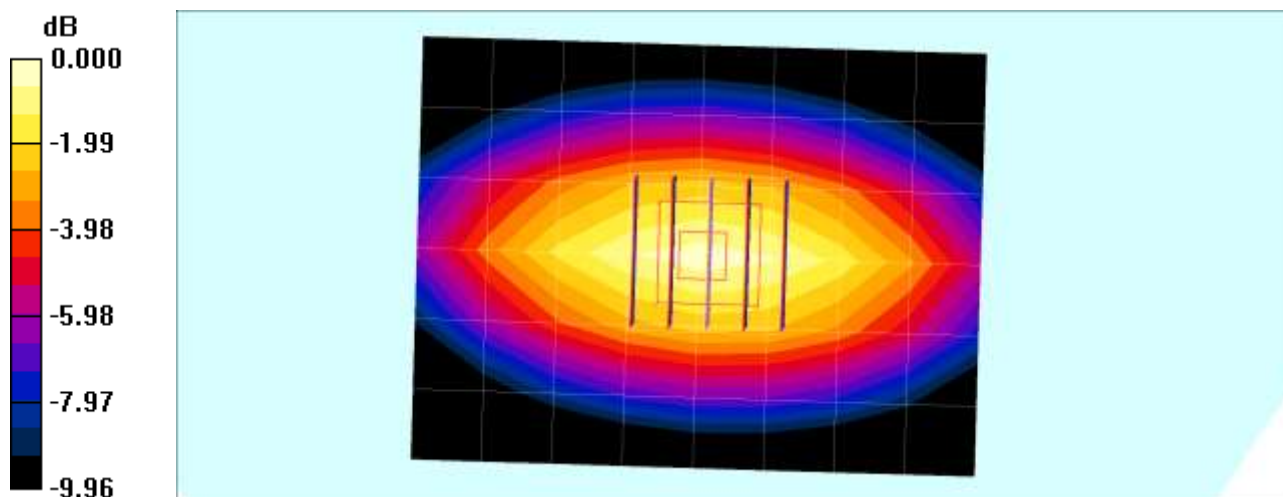

0 dB = 0.945mW/g

■ Verification Data (750 MHz Body)

Test Laboratory: HCT CO., LTD
 Input Power 100 mW (20 dBm)
 Liquid Temp: 21.7 °C
 Test Date: 05/18/2017

DUT: Dipole 750 MHz; Type: D750V3

Communication System: CW; Frequency: 750 MHz; Duty Cycle: 1:1
 Medium parameters used: $f = 750 \text{ MHz}$; $\sigma = 0.954 \text{ mho/m}$; $\epsilon_r = 55.5$; $\rho = 1000 \text{ kg/m}^3$
 Phantom section: Center Section

DASY4 Configuration:

- Probe: ET3DV6 - SN1630; ConvF(6.91, 6.91, 6.91); Calibrated: 2017-02-27
- Sensor-Surface: 4mm (Mechanical Surface Detection)
- Electronics: DAE4 Sn652; Calibrated: 2017-01-20
- Phantom: Triple Flat Phantom
- Measurement SW: DASY4, V4.7 Build 80
- Postprocessing SW: SEMCAD, V1.8 Build 186

750MHz Body Verification/Area Scan (12x7x1): Measurement grid: dx=15mm, dy=15mm
 Maximum value of SAR (measured) = 0.983 mW/g

750MHz Body Verification/Zoom Scan (5x5x7)/Cube 0: Measurement grid: dx=8mm, dy=8mm, dz=5mm
 Reference Value = 33.3 V/m; Power Drift = 0.003 dB
 Peak SAR (extrapolated) = 1.34 W/kg
SAR(1 g) = 0.913 mW/g; SAR(10 g) = 0.595 mW/g
 Maximum value of SAR (measured) = 0.984 mW/g

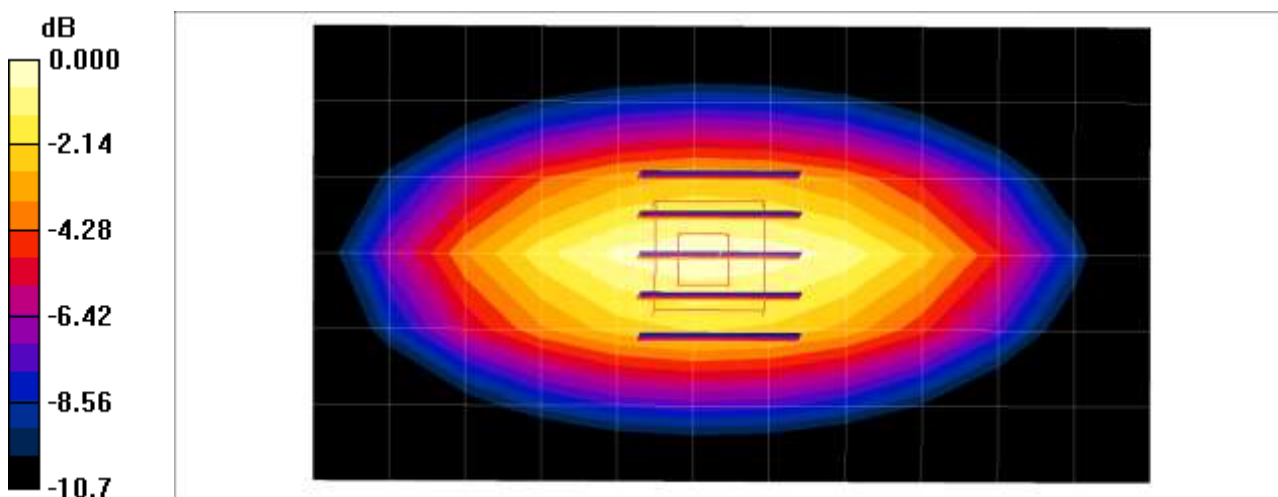

0 dB = 0.984mW/g

■ Verification Data (835 MHz Head)

Test Laboratory: HCT CO., LTD
Input Power 100 mW (20 dBm)
Liquid Temp: 20.9 °C
Test Date: 05/30/2017

DUT: Dipole 835 MHz; Type: D835V2

Communication System: CW; Frequency: 835 MHz; Duty Cycle: 1:1
Medium parameters used (interpolated): $f = 835$ MHz; $\sigma = 0.913$ mho/m; $\epsilon_r = 42$; $\rho = 1000$ kg/m³
Phantom section: Flat Section

DASY4 Configuration:

- Probe: ET3DV6 - SN1630; ConvF(7.26, 7.26, 7.26); Calibrated: 2017-02-27
- Sensor-Surface: 4mm (Mechanical Surface Detection)
- Electronics: DAE4 Sn652; Calibrated: 2017-01-20
- Phantom: SAM
- \Measurement SW: DASY4, V4.7 Build 80
- Postprocessing SW: SEMCAD, V1.8 Build 186

835MHz Head Verification/Area Scan (7x7x1): Measurement grid: dx=15mm, dy=15mm
Maximum value of SAR (measured) = 1.03 mW/g

835MHz Head Verification/Zoom Scan (5x5x7)/Cube 0: Measurement grid: dx=8mm, dy=8mm, dz=5mm
Reference Value = 34.9 V/m; Power Drift = 0.013 dB
Peak SAR (extrapolated) = 1.44 W/kg
SAR(1 g) = 0.972 mW/g; SAR(10 g) = 0.626 mW/g
Maximum value of SAR (measured) = 1.06 mW/g

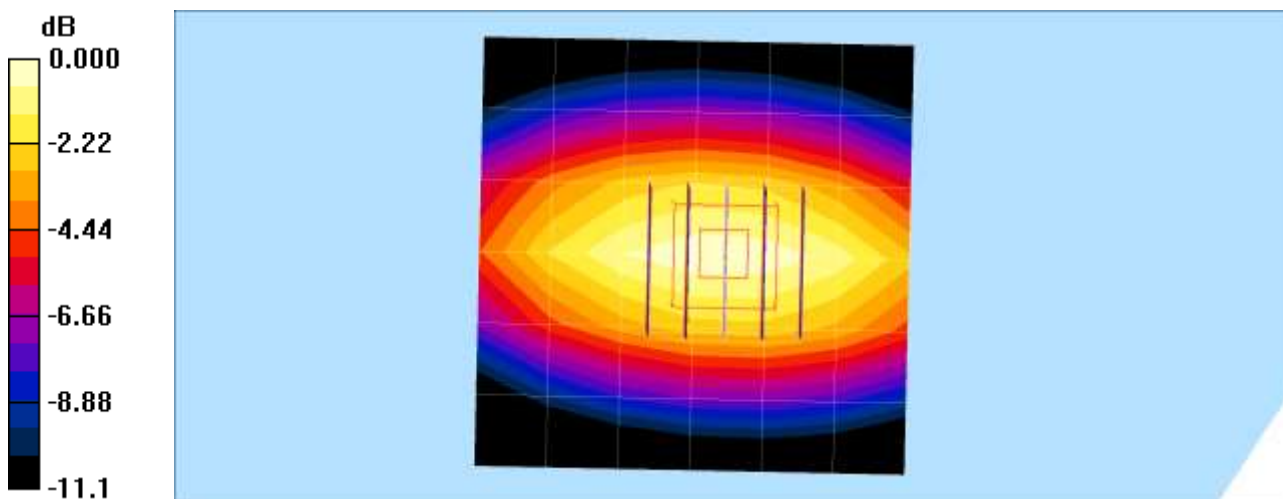

0 dB = 1.06mW/g

■ Verification Data (835 MHz Body)

Test Laboratory: HCT CO., LTD
 Input Power 100 mW (20 dBm)
 Liquid Temp: 22.5 °C
 Test Date: 05/31/2017

DUT: Dipole 835 MHz; Type: D835V2

Communication System: CW; Frequency: 835 MHz; Duty Cycle: 1:1
 Medium parameters used (interpolated): $f = 835$ MHz; $\sigma = 0.954$ mho/m; $\epsilon_r = 56.4$; $\rho = 1000$ kg/m³
 Phantom section: Center Section

DASY4 Configuration:

- Probe: ET3DV6 - SN1630; ConvF(6.73, 6.73, 6.73); Calibrated: 2017-02-27
- Sensor-Surface: 4mm (Mechanical Surface Detection)
- Electronics: DAE4 Sn652; Calibrated: 2017-01-20
- Phantom: Triple Flat Phantom
- Measurement SW: DASY4, V4.7 Build 80
- Postprocessing SW: SEMCAD, V1.8 Build 186

835 MHz Body Verification/Area Scan (12x7x1): Measurement grid: dx=15mm, dy=15mm
 Maximum value of SAR (measured) = 1.04 mW/g

835 MHz Body Verification/Zoom Scan (5x5x7)/Cube 0: Measurement grid: dx=8mm, dy=8mm, dz=5mm
 Reference Value = 34.8 V/m; Power Drift = -0.078 dB
 Peak SAR (extrapolated) = 1.44 W/kg
SAR(1 g) = 0.980 mW/g; SAR(10 g) = 0.637 mW/g
 Maximum value of SAR (measured) = 1.06 mW/g

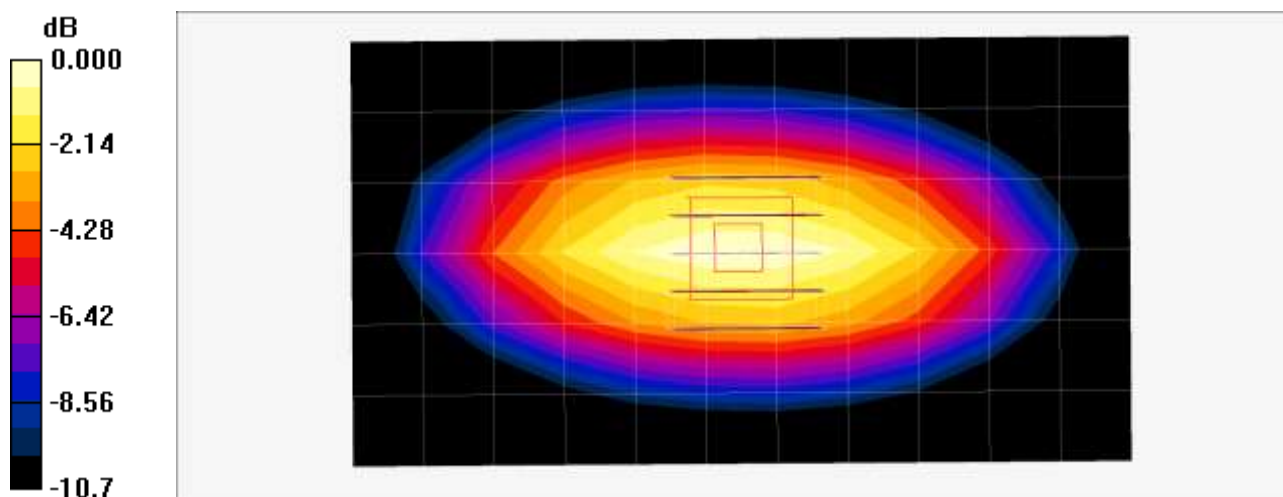

0 dB = 1.06mW/g

■ Verification Data (1 900 MHz Head)

Test Laboratory: HCT CO., LTD
Input Power: 100 mW (20 dBm)
Liquid Temp: 20.5 °C
Test Date: 05/26/2017

DUT: Dipole 1900 MHz D1900V2; Type: D1900V2

Communication System: UID 0, CW; Frequency: 1900 MHz; Duty Cycle: 1:1
Medium parameters used: $f = 1900$ MHz; $\sigma = 1.41$ S/m; $\epsilon_r = 39.841$; $\rho = 1000$ kg/m³
Phantom section: Flat Section

DASY5 Configuration:

- Probe: ET3DV6 - SN1605; ConvF(5.18, 5.18, 5.18); Calibrated: 2016-07-29;
- Sensor-Surface: 4mm (Mechanical Surface Detection)
- Electronics: DAE3 Sn446; Calibrated: 2017-01-19
- Phantom: SAM
- Measurement SW: DASY52, Version 52.8 (1);

1900MHz Head Verification/Area Scan (7x7x1): Measurement grid: dx=15mm, dy=15mm
Maximum value of SAR (measured) = 4.64 W/kg

1900MHz Head Verification/Zoom Scan (5x5x7)/Cube 0: Measurement grid: dx=8mm, dy=8mm, dz=5mm
Reference Value = 61.03 V/m; Power Drift = -0.03 dB
Peak SAR (extrapolated) = 7.44 W/kg
SAR(1 g) = 4.11 W/kg; SAR(10 g) = 2.09 W/kg
Maximum value of SAR (measured) = 4.56 W/kg

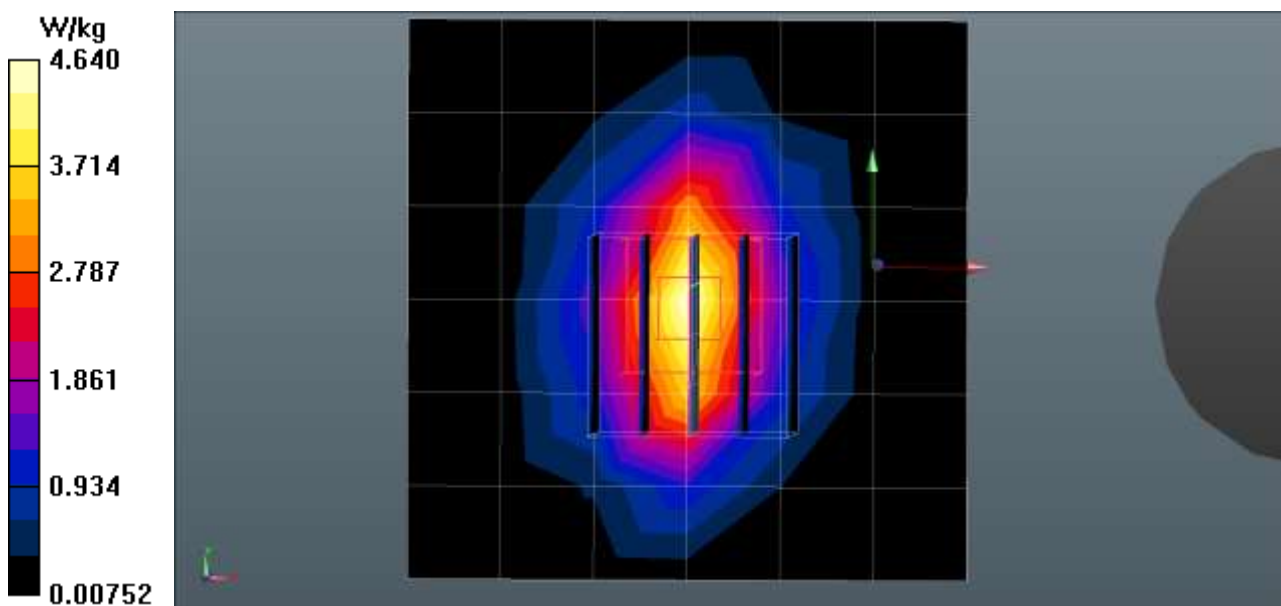

■ Verification Data (1 900 MHz Body)

Test Laboratory: HCT CO., LTD
 Input Power 100 mW (20 dBm)
 Liquid Temp: 21.5 °C
 Test Date: 05/30/2017

DUT: Dipole 1900 MHz D1900V2; Type: D1900V2

Communication System: UID 0, CW (0); Frequency: 1900 MHz; Duty Cycle: 1:1
 Medium parameters used: $f = 1900 \text{ MHz}$; $\sigma = 1.57 \text{ S/m}$; $\epsilon_r = 52.708$; $\rho = 1000 \text{ kg/m}^3$
 Phantom section: Center Section

DASY5 Configuration:

- Probe: EX3DV4 - SN3797; ConvF(7.45, 7.45, 7.45); Calibrated: 2016-11-25;
- Sensor-Surface: 2mm (Mechanical Surface Detection)
- Electronics: DAE4 Sn1225; Calibrated: 2016-11-24
- Phantom: Triple Flat Phantom
- Measurement SW: DASY52, Version 52.8 (8);

1900MHz Body Verification/Area Scan (7x7x1): Measurement grid: dx=15mm, dy=15mm
 Maximum value of SAR (measured) = 5.20 W/kg

1900MHz Body Verification/Zoom Scan (5x5x7)/Cube 0: Measurement grid: dx=8mm, dy=8mm, dz=5mm
 Reference Value = 58.62 V/m; Power Drift = 0.08 dB
 Peak SAR (extrapolated) = 6.98 W/kg
SAR(1 g) = 3.97 W/kg; SAR(10 g) = 2.1 W/kg
 Maximum value of SAR (measured) = 5.58 W/kg

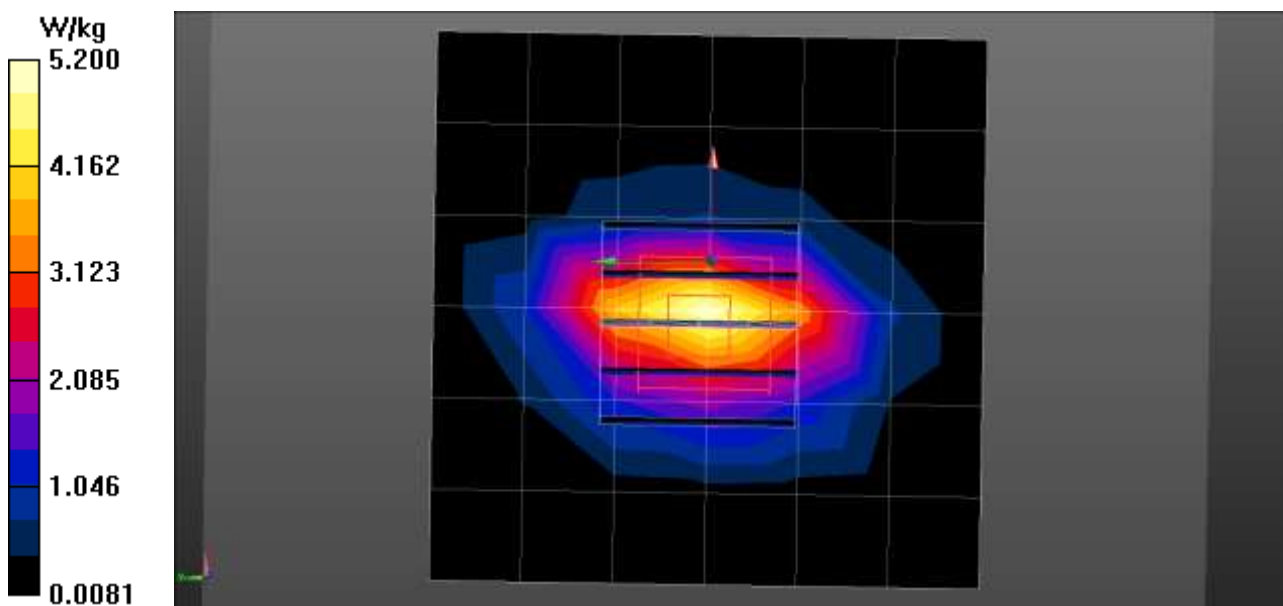

■ Verification Data (2 450 MHz Head)

Test Laboratory: HCT CO., LTD
Input Power: 100 mW (20 dBm)
Liquid Temp: 21.2 °C
Test Date: 05/26/2017

DUT: Dipole 2450 MHz D2450V2; Type: D2450V2

Communication System: UID 0, CW; Frequency: 2450 MHz; Duty Cycle: 1:1
Medium parameters used: $f = 2450$ MHz; $\sigma = 1.847$ S/m; $\epsilon_r = 38.559$; $\rho = 1000$ kg/m³
Phantom section: Flat Section

DASY5 Configuration:

- Probe: EX3DV4 - SN3797; ConvF(7.21, 7.21, 7.21); Calibrated: 2016-11-25;
- Sensor-Surface: 2mm (Mechanical Surface Detection)
- Electronics: DAE4 Sn1225; Calibrated: 2016-11-24
- Phantom: SAM
- Measurement SW: DASY52, Version 52.8 (1);

2450MHz Head Verification/Area Scan (8x8x1): Measurement grid: dx=12mm, dy=12mm
Maximum value of SAR (measured) = 7.62 W/kg

2450MHz Head Verification/Zoom Scan (7x7x7)/Cube 0: Measurement grid: dx=5mm, dy=5mm, dz=5mm
Reference Value = 65.45 V/m; Power Drift = 0.08 dB
Peak SAR (extrapolated) = 11.3 W/kg
SAR(1 g) = 5.31 W/kg; SAR(10 g) = 2.42 W/kg
Maximum value of SAR (measured) = 8.26 W/kg

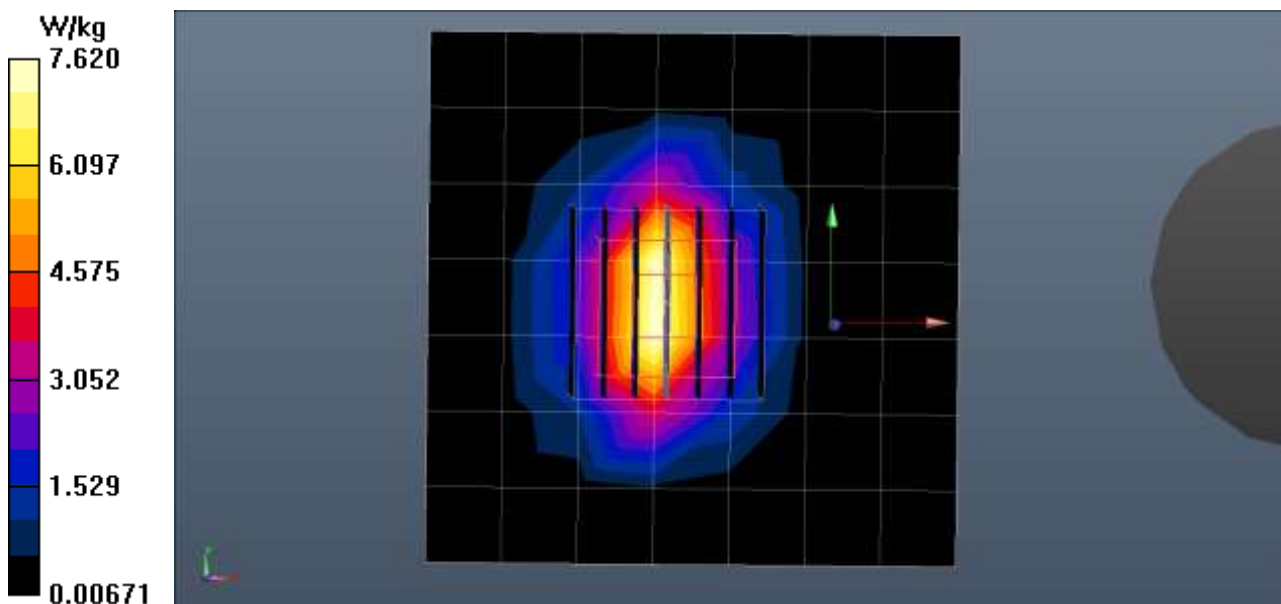

■ **Verification Data (2 450 MHz Head)**

Test Laboratory: HCT CO., LTD
 Input Power 100 mW (20 dBm)
 Liquid Temp: 20.1 °C
 Test Date: 06/07/2017

DUT: Dipole 2450 MHz D2450V2; Type: D2450V2

Communication System: UID 0, CW; Frequency: 2450 MHz; Duty Cycle: 1:1
 Medium parameters used: $f = 2450$ MHz; $\sigma = 1.826$ S/m; $\epsilon_r = 38.641$; $\rho = 1000$ kg/m³
 Phantom section: Flat Section

DASY Configuration:

- Probe: EX3DV4 - SN3797; ConvF(7.21, 7.21, 7.21); Calibrated: 2016-11-25;
- Sensor-Surface: 2mm (Mechanical Surface Detection)
- Electronics: DAE4 Sn1225; Calibrated: 2016-11-24
- Phantom: SAM
- Measurement SW: DASY52, Version 52.8 (1);

2450MHz Verification/Area Scan (8x8x1): Measurement grid: dx=12mm, dy=12mm
 Maximum value of SAR (measured) = 7.39 W/kg

2450MHz Verification/Zoom Scan (7x7x7)/Cube 0: Measurement grid: dx=5mm, dy=5mm, dz=5mm
 Reference Value = 65.07 V/m; Power Drift = 0.07 dB
 Peak SAR (extrapolated) = 11.1 W/kg
SAR(1 g) = 5.18 W/kg; SAR(10 g) = 2.36 W/kg
 Maximum value of SAR (measured) = 8.09 W/kg

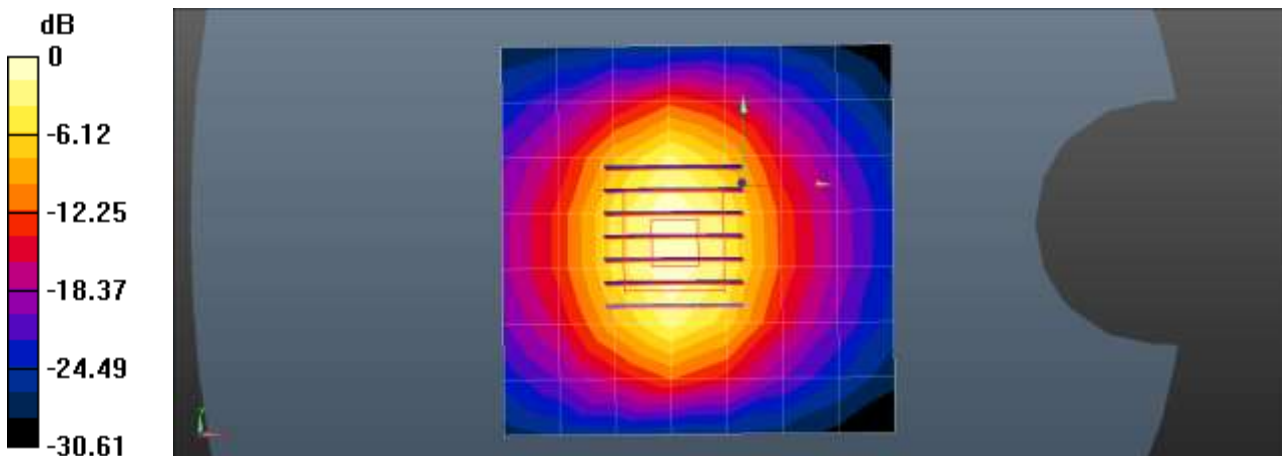

0 dB = 7.39 W/kg = 8.69 dBW/kg

■ Verification Data (2 450 MHz Body)

Test Laboratory: HCT CO., LTD
 Input Power: 100 mW (20 dBm)
 Liquid Temp: 21.2 °C
 Test Date: 05/26/2017

DUT: Dipole 2450 MHz D2450V2; Type: D2450V2

Communication System: UID 0, CW; Frequency: 2450 MHz; Duty Cycle: 1:1
 Medium parameters used: $f = 2450$ MHz; $\sigma = 1.934$ S/m; $\epsilon_r = 52.398$; $\rho = 1000$ kg/m³
 Phantom section: Center Section

DASY5 Configuration:

- Probe: EX3DV4 - SN3797; ConvF(7.19, 7.19, 7.19); Calibrated: 2016-11-25;
- Sensor-Surface: 2mm (Mechanical Surface Detection)
- Electronics: DAE4 Sn1225; Calibrated: 2016-11-24
- Phantom: Triple Flat Phantom
- Measurement SW: DASY52, Version 52.8 (1);

2450MHz Body Verification/Area Scan (9x9x1): Measurement grid: dx=12mm, dy=12mm
 Maximum value of SAR (measured) = 7.09 W/kg

2450MHz Body Verification/Zoom Scan (7x7x7)/Cube 0: Measurement grid: dx=5mm, dy=5mm, dz=5mm
 Reference Value = 62.20 V/m; Power Drift = -0.07 dB

Peak SAR (extrapolated) = 9.62 W/kg

SAR(1 g) = 4.74 W/kg; SAR(10 g) = 2.23 W/kg

Maximum value of SAR (measured) = 7.22 W/kg

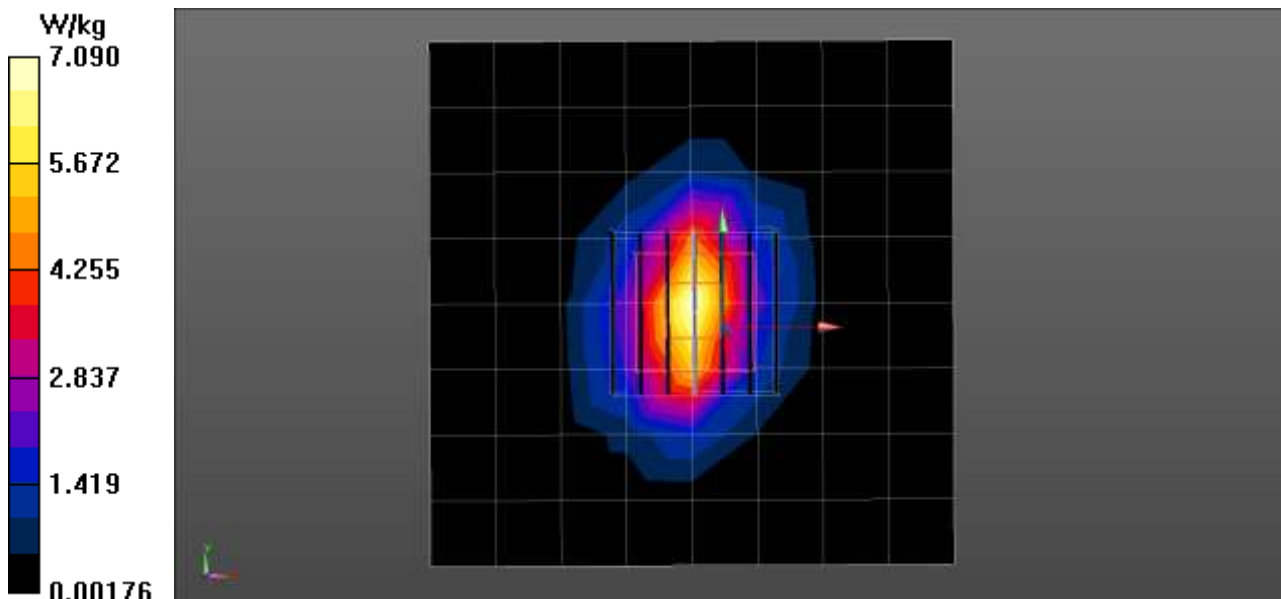

■ Verification Data (2 600 MHz Head)

Test Laboratory: HCT CO., LTD
 Input Power: 100 mW (20 dBm)
 Liquid Temp: 20.5 °C
 Test Date: 06/01/2017

DUT: Dipole 2600 MHz D2600V2; Type: D2600V2

Communication System: UID 0, CW (0); Frequency: 2600 MHz; Duty Cycle: 1:1
 Medium parameters used: $f = 2600$ MHz; $\sigma = 1.997$ S/m; $\epsilon_r = 38.432$; $\rho = 1000$ kg/m³
 Phantom section: Flat Section

DASY5 Configuration:

- Probe: EX3DV4 - SN3797; ConvF(6.97, 6.97, 6.97); Calibrated: 2016-11-25;
- Sensor-Surface: 2mm (Mechanical Surface Detection)
- Electronics: DAE4 Sn1225; Calibrated: 2016-11-24
- Phantom: SAM
- Measurement SW: DASY52, Version 52.8 (8);

2600MHz Head Verification/Area Scan (8x8x1): Measurement grid: dx=12mm, dy=12mm
 Maximum value of SAR (measured) = 6.16 W/kg

2600MHz Head Verification/Zoom Scan (7x7x7)/Cube 0: Measurement grid: dx=5mm, dy=5mm, dz=5mm
 Reference Value = 69.04 V/m; Power Drift = 0.19 dB
 Peak SAR (extrapolated) = 13.2 W/kg
SAR(1 g) = 6.03 W/kg; SAR(10 g) = 2.68 W/kg
 Maximum value of SAR (measured) = 9.54 W/kg

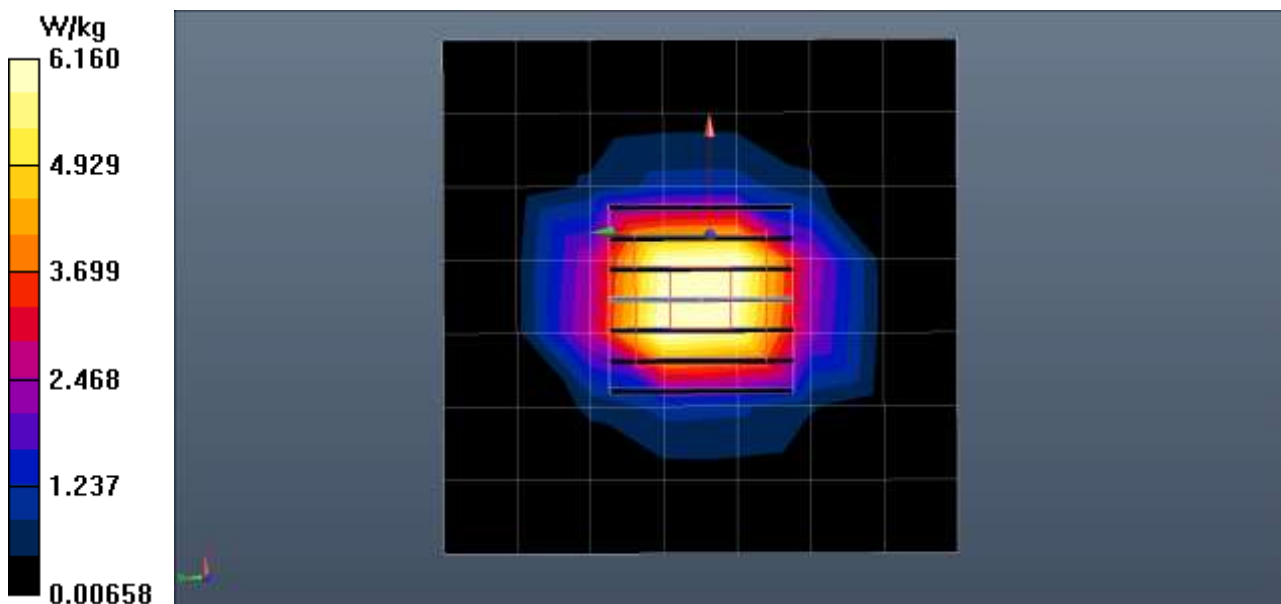

■ Verification Data (2 600 MHz Body)

Test Laboratory: HCT CO., LTD
 Input Power 100 mW (20 dBm)
 Liquid Temp: 22.5 °C
 Test Date: 05/31/2017

DUT: Dipole 2600 MHz; Type: D2600V2

Communication System: CW; Frequency: 2600 MHz; Duty Cycle: 1:1
 Medium parameters used: $f = 2600$ MHz; $\sigma = 2.16$ mho/m; $\epsilon_r = 51$; $\rho = 1000$ kg/m³
 Phantom section: Center Section

DASY4 Configuration:

- Probe: EX3DV4 - SN7370; ConvF(7.42, 7.42, 7.42); Calibrated: 2016-08-30
- Sensor-Surface: 2mm (Mechanical Surface Detection)
- Electronics: DAE4 Sn1417; Calibrated: 2017-01-19
- Phantom: Triple Flat Phantom
- Measurement SW: DASY4, V4.7 Build 80
- Postprocessing SW: SEMCAD, V1.8 Build 186

2600MHz Body Verification/Area Scan (9x9x1): Measurement grid: dx=12mm, dy=12mm
 Maximum value of SAR (measured) = 5.82 mW/g

2600MHz Body Verification/Zoom Scan (7x7x7)/Cube 0: Measurement grid: dx=5mm, dy=5mm, dz=5mm
 Reference Value = 44.8 V/m; Power Drift = -0.049 dB
 Peak SAR (extrapolated) = 11.0 W/kg
SAR(1 g) = 5.06 mW/g; SAR(10 g) = 2.27 mW/g
 Maximum value of SAR (measured) = 7.91 mW/g

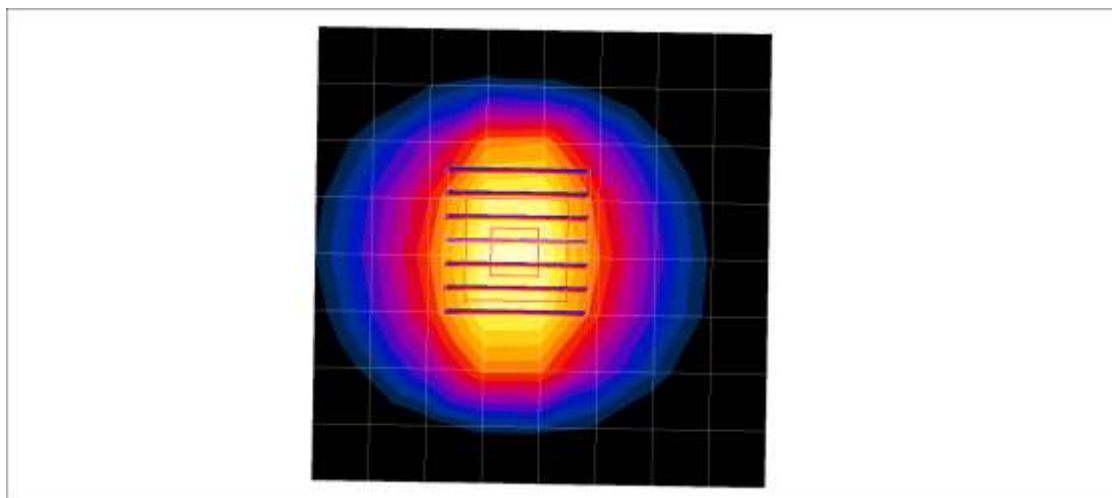
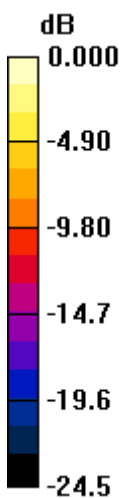

0 dB = 7.91mW/g