

# FCC LTE REPORT

## FCC Certification

<b>Applicant Name:</b> LG Electronics MobileComm U.S.A., Inc.	<b>Date of Issue:</b> June 15, 2017
<b>Address:</b> 1000 Sylvan Avenue, Englewood Cliffs NJ 07632	<b>Location:</b> HCT CO., LTD., 74, Seoicheon-ro 578beon-gil, Majang-myeon, Icheon-si, Gyeonggi-do, 17383, Rep. of KOREA
	<b>Report No.:</b> HCT-R-1706-F061 <b>HCT FRN:</b> 0005866421

<b>FCC ID:</b>	<b>ZNFM700N</b>
<b>APPLICANT:</b>	<b>LG Electronics MobileComm U.S.A., Inc.</b>

According to the Evaluation report, all of the data contained herein is reused from the reference FCC ID: ZNFM700H report.

**FCC Model(s):** LG-M700n  
**Additional FCC Model(s):** LGM700n, M700n  
**EUT Type:** GSM/WCDMA/LTE Phone with Bluetooth4.2LE, WIFI802.11 b/g/n, NFC  
**FCC Classification:** Licensed Portable Transmitter Held to Ear (PCE)  
**FCC Rule Part(s):** §27, §2

Mode (MHz)	Tx Frequency (MHz)	Emission Designator	Modulation	ERP	
				Max. Power (W)	Max. Power (dBm)
LTE – Band17 (5)	706.5 – 713.5	4M50G7D	QPSK	0.036	15.58
		4M49W7D	16QAM	0.027	14.33
LTE – Band17 (10)	709.0 – 711.0	8M96G7D	QPSK	0.033	15.22
		8M97W7D	16QAM	0.026	14.18

The measurements shown in this report were made in accordance with the procedures specified in CFR47 section §2.947. I assume full responsibility for the accuracy and completeness of these measurements, and for the qualifications of all persons taking them.

HCT CO., LTD. Certifies that no party to this application has subject to a denial of Federal benefits that includes FCC benefits pursuant to section 5301 of the Anti-Drug Abuse Act of 1998,21 U.S. C.853(a)



**Report prepared by : Jeong Ho Kim**  
**Engineer of Telecommunication Testing Center**



**Report approved by : Jong Seok Lee**  
**Manager of Telecommunication Testing Center**

This report only responds to the tested sample and may not be reproduced, except in full, without written approval of the HCT Co., Ltd.

## Version

TEST REPORT NO.	DATE	DESCRIPTION
HCT-R-1706-F061	June 15, 2017	- First Approval Report

---

---

# Table of Contents

1. GENERAL INFORMATION .....	4
2. INTRODUCTION .....	5
2.1. EUT DESCRIPTION.....	5
2.2. MEASURING INSTRUMENT CALIBRATION.....	5
2.3. TEST FACILITY .....	5
3. DESCRIPTION OF TESTS .....	6
3.1 ERP RADIATED POWER AND RADIATED SPURIOUS EMISSIONS .....	6
3.2 BLOCK B FREQUENCY RANGE (704 – 710 and 734 – 740 MHz, 777 – 792 MHz) .....	6
3.3 OCCUPIED BANDWIDTH.....	8
3.4 SPURIOUS AND HARMONIC EMISSIONS AT ANTENNA TERMINAL.....	9
3.5 FREQUENCY STABILITY / VARIATION OF AMBIENT TEMPERATURE .....	10
4. LIST OF TEST EQUIPMENT .....	11
5. MEASUREMENT UNCERTAINTY.....	12
6. SUMMARY OF TEST RESULTS .....	13
7. SAMPLE CALCULATION.....	14
8. TEST DATA .....	15
8.1 EFFECTIVE RADIATED POWER (Band 17).....	15
8.2 RADIATED SPURIOUS EMISSIONS .....	17
8.2.1 RADIATED SPURIOUS EMISSIONS (5 MHz Band 17 LTE).....	17
8.2.2 RADIATED SPURIOUS EMISSIONS (10 MHz Band 17 LTE).....	18
8.3 OCCUPIED BANDWIDTH .....	19
8.4 CONDUCTED SPURIOUS EMISSIONS .....	20
8.4.1 BAND EDGE.....	20
8.5 FREQUENCY STABILITY / VARIATION OF AMBIENT TEMPERATURE .....	21
8.5.1 FREQUENCY STABILITY (5 MHz Band 17 LTE) .....	21
8.5.2 FREQUENCY STABILITY (10 MHz Band 17 LTE) .....	22
9. TEST PLOTS.....	23

# MEASUREMENT REPORT

## 1. GENERAL INFORMATION

**Applicant Name:** LG Electronics MobileComm U.S.A., Inc.

**Address:** 1000 Sylvan Avenue, Englewood Cliffs NJ 07632

**FCC ID:** ZNFM700N

**Application Type:** Certification

**FCC Classification:** Licensed Portable Transmitter Held to Ear (PCE)

**FCC Rule Part(s):** §27, §2

**EUT Type:** GSM/WCDMA/LTE Phone with Bluetooth4.2LE, WIFI802.11 b/g/n, NFC

**FCC Model(s):** LG-M700n

**Additional FCC Model(s):** LGM700n, M700n

**Tx Frequency:** 706.5 MHz – 713.5 MHz (LTE – Band 17 (5 MHz))  
709.0 MHz – 711.0 MHz (LTE – Band 17 (10 MHz))

**Max. RF Output Power:**

Band 17 ( 5 MHz) :	0.036 W (QPSK) (15.58 dBm)
	0.027 W (16-QAM) (14.33 dBm)
Band 17 (10 MHz) :	0.033 W (QPSK) (15.22 dBm)
	0.026 W (16-QAM) (14.18 dBm)

**Emission Designator(s):**

Band 17 ( 5 MHz) :	4M50G7D (QPSK) / 4M49W7D (16-QAM)
Band 17 (10 MHz) :	8M96G7D (QPSK) / 8M97W7D (16-QAM)

**Date(s) of Tests:** April 25, 2017 ~ May 29, 2017

**Antenna Specification:**

Manufacturer:	LS Mtron Co. Ltd.
Antenna type:	PIFA Antenna (Planar Inverted F)

## **2. INTRODUCTION**

### **2.1. EUT DESCRIPTION**

The LG Electronics MobileComm U.S.A., Inc. LG-M700n GSM/WCDMA/LTE Phone with Bluetooth4.2LE, WIFI802.11 b/g/n, NFC consists of LTE 17.

### **2.2. MEASURING INSTRUMENT CALIBRATION**

The measuring equipment, which was utilized in performing the tests documented herein, has been calibrated in accordance with the manufacturer's recommendations for utilizing calibration equipment, which is traceable to recognized national standards.

### **2.3. TEST FACILITY**

The Fully-anechoic chamber and conducted measurement facility used to collect the radiated data are located at the **74, Seoicheon-ro 578beon-gil, Majang-myeon, Icheon-si, Gyeonggi-do, 17383, Rep. of KOREA.**

## **3. DESCRIPTION OF TESTS**

### **3.1 ERP RADIATED POWER AND RADIATED SPURIOUS EMISSIONS**

Note: ERP(Effective Radiated Power)

Test Procedure

Radiated emission measurements are performed in the Fully-anechoic chamber. The equipment under test is placed on a non-conductive table 3-meters away from the receive antenna in accordance with ANSI/TIA-603-D-2010 Clause 2.2.17. The turntable is rotated through 360 degrees, and the receiving antenna scans in order to determine the level of the maximized emission. The level and position of the maximized emission is recorded with the spectrum analyzer using a RMS detector.

A half wave dipole is then substituted in place of the EUT. For emissions above 1GHz, a horn antenna is substituted in place of the EUT. The substitute antenna is driven by a signal generator and the previously recorded signal was duplicated.

The power is calculated by the following formula;

$$P_{d(\text{dBm})} = P_{g(\text{dBm})} - \text{cable loss}_{(\text{dB})} + \text{antenna gain}_{(\text{dB})}$$

Where:  $P_d$  is the dipole equivalent power and  $P_g$  is the generator output power into the substitution antenna.

#### **Radiated spurious emissions**

: Frequency Range : 9 kHz ~ 10<sup>th</sup> Harmonics of highest channel fundamental frequency.

### **3.2 BLOCK B FREQUENCY RANGE (704 – 710 and 734 – 740 MHz, 777 – 792 MHz)**

§27.5(c)

698-746 MHz Band. The following frequencies are available for licensing pursuant to this part in the 698–746 MHz band: (1) Three paired channel blocks of 12 MHz each are available for assignment as follows :

Block A : 698 – 704 MHz and 728 – 734 MHz ;

Block B : 704 – 710 MHz and 734 – 740 MHz ; and

Block C : 710 – 716 MHz and 740 – 746 MHz.

The EUT is only being authorized for operation in Blocks B and C.

**5.1.1 Peak power measurements with a spectrum/signal analyzer or EMI receiver**

The following procedure can be used to determine the total peak output power.

- a) Set the RBW  $\geq$  OBW.
- b) Set VBW  $\geq 3 \times$  RBW.
- c) Set span  $\geq 2 \times$  RBW
- d) Sweep time = auto couple.
- e) Detector = peak.
- f) Ensure that the number of measurement points  $\geq$  span/RBW.
- g) Trace mode = max hold.
- h) Allow trace to fully stabilize.
- i) Use the peak marker function to determine the peak amplitude level.

**5.2.2 Procedures for use with a spectrum/signal analyzer when EUT cannot be configured to transmit continuously and sweep triggering/signal gating cannot be properly implemented**

If the EUT cannot be configured to transmit continuously (burst duty cycle  $< 98\%$ ), then one of the following procedures can be used. The selection of the applicable procedure will depend on the characteristics of the measured burst duty cycle.

Measure the burst duty cycle with a spectrum/signal analyzer or EMC receiver can be used in zero-span mode if the response time and spacing between bins on the sweep are sufficient to permit accurate measurement of the burst on/off time of the transmitted signal.

**5.2.2.2 Constant burst duty cycle**

If the measured burst duty cycle is constant (i.e., duty cycle variations are less than  $\pm 2$  percent), then:

- a) Set span to at least 1.5 times the OBW.
- b) Set RBW = 1-5% of the OBW, not to exceed 1 MHz.
- c) Set VBW  $\geq 3 \times$  RBW.
- d) Number of points in sweep  $\geq 2 \times$  span / RBW. (This gives bin-to-bin spacing  $\leq$  RBW/2, so that narrowband signals are not lost between frequency bins.)
- e) Sweep time = auto.
- f) Detector = RMS (power averaging).
- g) Set sweep trigger to "free run".
- h) Trace average at least 100 traces in power averaging (i.e., RMS) mode.
- i) Compute power by integrating the spectrum across the OBW of the signal using the instrument's band power measurement function with band limits set equal to the OBW band edges. If the instrument does not have a band power function, sum the spectrum levels (in power units) at intervals equal to the RBW extending across the entire OBW of the spectrum.
- j) Add  $10 \log (1/x)$ , where  $x$  is the duty cycle, to the measured power in order to compute the average power during the actual transmission times (because the measurement represents an average over both the on and off times of the transmission).

For example, add  $10 \log (1/0.25) = 6$  dB if the duty cycle is a constant 25%.

### 3.3 OCCUPIED BANDWIDTH.

Test set-up

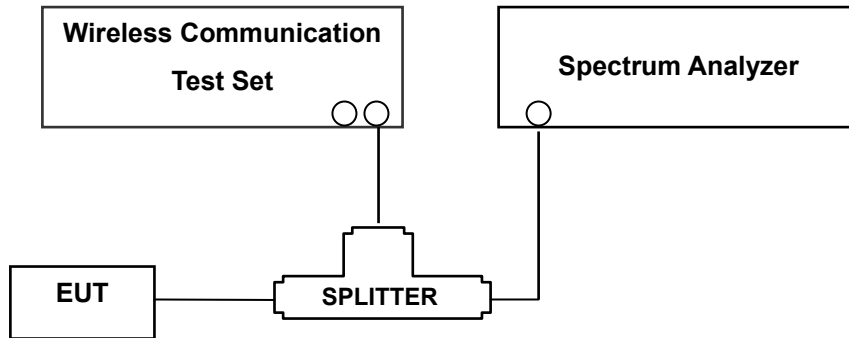

(Configuration of conducted Emission measurement)

The width of a frequency band such that, below the lower and above the upper frequency limits, the mean powers emitted are each equal to a specified percentage 0.5 % of the total mean power of a given emission.

#### Test Procedure

OBW is tested in accordance with KDB971168 D01 Power Meas License Digital Systems v02r02, October 17, 2014, Section 4.2.

The EUT makes a call to the communication simulator. The power was measured with R&S Spectrum Analyzer. All measurements were done at 3 channels(low, middle and high operational range.)

The conducted occupied bandwidth used the power splitter via EUT RF power connector between simulation base station and spectrum analyzer.

The communication simulator station system controlled a EUT to export maximum output power under transmission mode and specific channel frequency. Use OBW measurement function of Spectrum analyzer to measure 99 % occupied bandwidth



### 3.4 SPURIOUS AND HARMONIC EMISSIONS AT ANTENNA TERMINAL.

#### Test Procedure

Spurious and harmonic emissions at antenna terminal is tested in accordance with KDB971168 D01 Power Meas License Digital Systems v02r02, October 17, 2014, Section 6.0.

The level of the carrier and the various conducted spurious and harmonic frequencies is measured by means of a calibrated spectrum analyzer.

The spectrum is scanned from the lowest frequency generated in the equipment up to a frequency including its 10th harmonic. On any frequency outside a licensee's frequency block, the power of any emission shall be attenuated below the transmitter power (P) by at least  $43 + 10 \log(P)$  dB. Compliance with these provisions is based on the use of measurement instrumentation employing a resolution bandwidth of 1 MHz or greater. However, in the 100 kHz bands immediately outside and adjacent to the frequency block a resolution bandwidth of at least 30kHz bandwidth may be employed. The emission bandwidth is defined as the width of the signal between two points, one below the carrier center frequency and one above the carrier center frequency

**NOTES:** The analyzer plot offsets were determined by below conditions.

- For LTE Band 17 total offset 26.6 dB = 20 dB attenuator + 6 dB Divider + 0.6 dB RF cables.

### 3.5 FREQUENCY STABILITY / VARIATION OF AMBIENT TEMPERATURE

#### Test Set-up

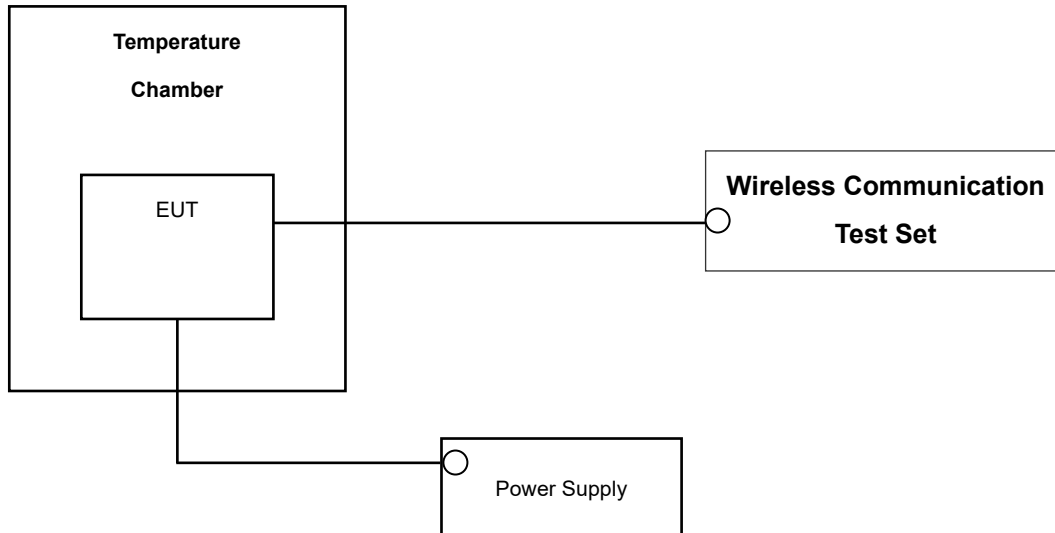

\* Nominal Operating Voltage

#### Test Procedure

Frequency stability is tested in accordance with ANSI/TIA-603-D-2010 section 2.2.2

The frequency stability of the transmitter is measured by:

- a.) **Temperature:** The temperature is varied from - 30 °C to + 50 °C using an environmental chamber.
- b.) **Primary Supply Voltage:** The primary supply voltage is varied from the end point to 100 % of the voltage normally at the input to the device or at the power supply terminals if cables are not normally supplied.

Specification — the frequency stability shall be sufficient to ensure that the fundamental emission stays within the authorized frequency block

#### Time Period and Procedure:

The carrier frequency of the transmitter is measured at room temperature (20°C to provide a reference).

1. The equipment is turned on in a "standby" condition for one minute before applying power to the transmitter. Measurement of the carrier frequency of the transmitter is made within one minute after applying power to the transmitter.
2. Frequency measurements are made at 10°C intervals ranging from -30°C to +50°C. A period of at least one half-hour is provided to allow stabilization of the equipment at each temperature level.

**NOTE: The EUT is tested down to the battery endpoint.**

## 4. LIST OF TEST EQUIPMENT

Manufacture	Model/ Equipment	Serial Number	Calibration Date	Calibration Interval	Calibration Due
REOHDE & SCHWARZ	SCU 18 / AMPLIFIER	10094	04/24/2017	Annual	04/24/2018
Wainwright	WHK1.2/15G-10EF/H.P.F	4	04/10/2017	Annual	04/10/2018
Wainwright	WHK3.3/18G-10EF/H.P.F	2	04/10/2017	Annual	04/10/2018
Hewlett Packard	11667B / Power Splitter	10545	02/15/2017	Annual	02/15/2018
Hewlett Packard	11667B / Power Splitter	11275	05/04/2017	Annual	05/04/2018
Agilent	E3632A/DC Power Supply	KR75303243	07/12/2016	Annual	07/12/2017
Schwarzbeck	UHAP/ Dipole Antenna	557	03/31/2017	Biennial	03/31/2019
Schwarzbeck	UHAP/ Dipole Antenna	558	03/31/2017	Biennial	03/31/2019
EXP	EX-TH400/ Chamber	None	05/31/2016	Annual	05/31/2017
Schwarzbeck	BBHA 9120D/ Horn Antenna	147	09/09/2016	Biennial	09/09/2018
Schwarzbeck	BBHA 9120D/ Horn Antenna	1298	10/14/2016	Biennial	10/14/2018
Schwarzbeck	BBHA 9170/ Horn Antenna(15~40GHz)	BBHA9170342	04/25/2017	Biennial	04/25/2019
Schwarzbeck	BBHA 9170/ Horn Antenna(15~40GHz)	BBHA9170124	04/25/2017	Biennial	04/25/2019
Agilent	N9020A/Signal Analyzer	MY51110074	11/28/2016	Annual	11/28/2017
Hewlett Packard	8493C/ATTENUATOR	17280	06/22/2016	Annual	06/22/2017
REOHDE & SCHWARZ	FSV40/Spectrum Analyzer	1307.9002K40-100931-NK	06/15/2016	Annual	06/15/2017
Agilent	8960 (E5515C)/ Base Station	MY48360800	10/19/2016	Annual	10/19/2017
Schwarzbeck	FMZB1513/ Loop Antenna(9kHz~30MHz)	1513-175	04/06/2017	Biennial	04/06/2019
Schwarzbeck	VULB9160/ Bilog Antenna	3150	09/30/2016	Biennial	09/30/2018
Schwarzbeck	VULB9160/ Bilog Antenna	3368	10/14/2016	Biennial	10/14/2018
REOHDE & SCHWARZ	ESU / EMI TEST RECEIVER	100346	08/11/2017	Annual	08/11/2018
Anritsu Corp.	MT8820C/Wideband Radio Communication Tester	6200863156	02/15/2017	Annual	02/15/2018
Anritsu Corp.	MT8820C/Wideband Radio Communication Tester	6201026545	02/13/2017	Annual	02/13/2018
Anritsu Corp.	MT8821C/Radio Communication Analyzer	6201502997	08/04/2016	Annual	08/04/2017
REOHDE & SCHWARZ	SMB100A/ SIGNAL GENERATOR (100kHz~40GHz)	177633	07/18/2016	Annual	07/18/2017

## 5. MEASUREMENT UNCERTAINTY

The measurement uncertainties shown below were calculated in accordance with the requirements of ANSI C63.4:2014.

All measurement uncertainty values are shown with a coverage factor of  $k = 2$  to indicate a 95 % level of confidence. The measurement data shown herein meets or exceeds the  $U_{\text{CISPR}}$  measurement uncertainty values specified in CISPR 16-4-2 and, thus, can be compared directly to specified limits to determine compliance.

Parameter	Expanded Uncertainty ( $\pm$ dB)
Conducted Disturbance (150 kHz ~ 30 MHz)	1.82
Radiated Disturbance (9 kHz ~ 30 MHz)	3.40
Radiated Disturbance (30 MHz ~ 1 GHz)	4.80
Radiated Disturbance (1 GHz ~ 18 GHz)	6.07

## 6. SUMMARY OF TEST RESULTS

FCC Part Section(s)	Test Description	Test Limit	Test Condition	Test Result
2.1049	Occupied Bandwidth	N/A	CONDUCTED	PASS
2.1051, 27.53(g)	Band Edge / Spurious and Harmonic Emissions at Antenna Terminal.	$< 43 + 10 \log_{10}(P[\text{Watts}])$ at Band Edge and for all-of-band emissions		PASS
2.1046	*Conducted Output Power	N/A		PASS
2.1055, 27.54	Frequency stability / variation of ambient temperature	Emission must remain in band		PASS
27.50(c)(10)	Effective Radiated Power	$< 3$ Watts max. ERP	RADIATED	PASS
2.1053, 27.53(g)	Undesirable Out-of-Band Emissions	$< 43 + 10 \log_{10}(P[\text{Watts}])$ for all out-of-band emissions		PASS

\*: See SAR Report

## 7. SAMPLE CALCULATION

### A. ERP Sample Calculation

Mode	Ch./ Freq.		Measured Level(dBm)	Substitute LEVEL(dBm)	Ant. Gain (dBd)	C.L	Pol.	Limit W	ERP	
	channel	Freq.(MHz)							W	dBm
LTE Band 17	23790	710.0	-32.09	28.83	-10.21	0.81	V	< 3.00	0.060	17.81

#### ERP = Substitute LEVEL(dBm) + Ant. Gain – CL(Cable Loss)

- 1) The EUT mounted on a wooden tripod is 2.5 meter above test site ground level.
- 2) During the test , the turn table is rotated and the antenna height is found.
- 3) Record the field strength meter's level.
- 4) Replace the EUT with dipole/Horn antenna that is connected to a calibrated signal generator.
- 5) Increase the signal generator output till the field strength meter's level is equal to the item (3).
- 6) The signal generator output level with Ant. Gain and cable loss are the rating of effective radiated power (**ERP**).

## B. Emission Designator

### QPSK Modulation

**Emission Designator = 4M48G7D**

LTE BW = 4.48 MHz

G = Phase Modulation

7 = Quantized/Digital Info

D = Data transmission; telemetry; telecommand

### 16QAM Modulation

**Emission Designator = 4M48W7D**

LTE BW = 4.48 MHz

W = main carrier modulated in a combination of two

or more of the following modes;

amplitude, angle, pulse

7 = Quantized/Digital Info

D = Data transmission; telemetry; telecommand

## 8. TEST DATA

### 8.1 EFFECTIVE RADIATED POWER (Band 17)

Freq (MHz)	Bandwidth	Modulation	Measured Level (dBm)	Substitute Level (dBm)	Ant. Gain(dBd)	C.L	Pol	Limit	ERP	
								W	W	dBm
706.5	5 MHz	QPSK	-34.92	26.54	-10.20	1.21	V	< 3.00	0.033	15.13
		16-QAM	-36.15	25.31	-10.20	1.21	V		0.025	13.90
710.0		QPSK	-34.39	27.02	-10.22	1.22	V		0.036	15.58
		16-QAM	-35.64	25.77	-10.22	1.22	V		0.027	14.33
713.5		QPSK	-34.32	26.91	-10.24	1.22	V		0.035	15.45
		16-QAM	-35.54	25.69	-10.24	1.22	V		0.026	14.23

#### Effective Radiated Power Data (5 MHz Band 17 LTE)

Note: All of RB size has been tested for emissions and ERP, with the 1RB configuration observed as the worst case

Freq (MHz)	Bandwidth	Modulation	Measured Level (dBm)	Substitute Level (dBm)	Ant. Gain(dBd)	C.L	Pol	Limit	ERP	
								W	W	dBm
709.0	10 MHz	QPSK	-34.80	26.63	-10.22	1.21	V	< 3.00	0.033	15.20
		16-QAM	-35.94	25.49	-10.22	1.21	V		0.025	14.06
710.0		QPSK	-34.84	26.57	-10.22	1.22	V		0.033	15.13
		16-QAM	-36.01	25.40	-10.22	1.22	V		0.025	13.96
711.0		QPSK	-34.72	26.67	-10.23	1.22	V		0.033	15.22
		16-QAM	-35.76	25.63	-10.23	1.22	V		0.026	14.18

#### Effective Radiated Power Data (10 MHz Band 17 LTE)

Note: All of RB size has been tested for emissions and ERP, with the 1RB configuration observed as the worst case

**NOTES:**

Effective Radiated Power Output Measurements by Substitution Method  
according to ANSI/TIA/EIA-603-D-2010 June 24, 2010:

The EUT was placed on a non-conductive styrofoam resin table 3-meters from the receive antenna. The receive antenna height and turntable rotation was adjusted for the highest reading on the receive spectrum analyzer. For LTE signals, RBW = 1-5% of the OBW, not to exceed 1MHz, VBW  $\geq 3 \times$  RBW, Detector = RMS. A half-wave dipole was substituted in place of the EUT. This dipole antenna was driven by a signal generator and the level of the signal generator was adjusted to obtain the same receive spectrum analyzer reading. The conducted power at the terminals of the dipole is measured. The ERP is recorded.

Also, we have done x, y, z planes in EUT and horizontal and vertical polarization in detecting antenna. The worst case of the EUT is y plane in LTE mode. Also worst case of detecting Antenna is vertical polarization in LTE mode.



## 8.2 RADIATED SPURIOUS EMISSIONS

### 8.2.1 RADIATED SPURIOUS EMISSIONS (5 MHz Band 17 LTE)

- ▣ OPERATING FREQUENCY: 710.00 MHz
- ▣ MEASURED OUTPUT POWER: 15.58 dBm = 0.036 W
- ▣ MODULATION SIGNAL: 5 MHz QPSK
- ▣ DISTANCE: 3 meters
- ▣ LIMIT:  $43 + 10 \log_{10}(W) =$  28.58 dBc

Ch	Freq (MHz)	Measured Level (dBm)	Ant. Gain (dBd)	Substitute Level (dBm)	C.L	Pol	ERP (dBm)	dBc
23755 (706.50)	1,413.00	-55.92	8.03	-66.05	1.74	H	-59.76	75.34
	2,119.50	-40.16	10.44	-49.38	2.15	H	-41.09	56.67
	2,826.00	-55.09	11.18	-63.15	2.52	H	-54.49	70.07
23790 (710.00)	1,420.00	-55.39	8.09	-65.55	1.74	V	-59.21	74.79
	2,130.00	-39.91	10.47	-48.83	2.16	H	-40.51	56.09
	2,840.00	-57.67	11.19	-65.57	2.53	H	-56.90	72.48
23825 (713.50)	1,427.00	-55.21	8.09	-65.37	1.74	H	-59.03	74.61
	2,140.50	-40.39	10.49	-48.80	2.17	H	-40.48	56.06
	2,854.00	-54.29	11.20	-62.22	2.52	V	-53.54	69.12

- NOTES:**
1. Radiated Spurious Emission Measurements at 3 meters by Substitution Method according to ANSI/TIA/EIA-603-D-2010 June 24, 2010:
  2. We are performed all frequency to 10<sup>th</sup> harmonics from 9 kHz. Measurements above show only up to 3 maximum emissions noted, or would be lesser if no specific emissions from the EUT are recorded (ie: margin > 20 dB from the applicable limit) and considered that's already beyond the background noise floor.
  3. We have done x, y, z planes in EUT and horizontal and vertical polarization in detecting antenna.
  4. All of RB size has been tested for emissions and ERP, with the 1RB configuration observed as the worst case
  5. We are performed 16QAM and QPSK modulations. The worst case data are reported in the table above.

## 8.2.2 RADIATED SPURIOUS EMISSIONS (10 MHz Band 17 LTE)

- ▣ OPERATING FREQUENCY: 711.00 MHz
- ▣ MEASURED OUTPUT POWER: 15.22 dBm = 0.033 W
- ▣ MODULATION SIGNAL: 10 MHz QPSK
- ▣ DISTANCE: 3 meters
- ▣ LIMIT:  $43 + 10 \log_{10}(W) =$  28.22 dBc

Ch	Freq (MHz)	Measured Level (dBm)	Ant. Gain (dBd)	Substitute Level (dBm)	C.L	Pol	ERP (dBm)	dBc
23780 (709.00)	1,418.00	-54.88	8.03	-64.99	1.74	V	-58.70	73.92
	2,127.00	-40.95	10.46	-49.90	2.15	V	-41.59	56.81
	2,836.00	-56.80	11.19	-64.74	2.53	H	-56.08	71.30
23790 (710.00)	1,420.00	-57.01	8.09	-67.17	1.74	H	-60.83	76.05
	2,130.00	-39.72	10.47	-48.64	2.16	V	-40.32	55.54
	2,840.00	-55.33	11.19	-63.23	2.53	H	-54.56	69.78
23800 (711.00)	1,422.00	-55.88	8.10	-66.11	1.74	H	-59.75	74.97
	2,133.00	-41.86	10.47	-50.61	2.16	H	-42.30	57.52
	2,844.00	-56.61	11.19	-64.51	2.53	H	-55.85	71.07

- NOTES:**
1. Radiated Spurious Emission Measurements at 3 meters by Substitution Method according to ANSI/TIA/EIA-603-D-2010 June 24, 2010:
  2. We are performed all frequency to 10<sup>th</sup> harmonics from 9 kHz. Measurements above show only up to 3 maximum emissions noted, or would be lesser if no specific emissions from the EUT are recorded (ie: margin > 20 dB from the applicable limit) and considered that's already beyond the background noise floor.
  3. We have done x, y, z planes in EUT and horizontal and vertical polarization in detecting antenna.
  4. All of RB size has been tested for emissions and ERP, with the 1RB configuration observed as the worst case
  5. We are performed 16QAM and QPSK modulations. The worst case data are reported in the table above.

### 8.3 OCCUPIED BANDWIDTH

Band	Band Width	Frequency (MHz)	Modulation	Resource Block Size	Resource Block Offset	Data ( MHz )
17	5 MHz	710.0	QPSK	25	0	4.5045
			16-QAM	25	0	4.4913
	10 MHz		QPSK	50	0	8.9619
			16-QAM	50	0	8.9676

- Plots of the EUT's Occupied Bandwidth are shown Page 24 ~ 25.

## 8.4 CONDUCTED SPURIOUS EMISSIONS

### ■FACTORS FOR FREQUENCY

Frequency Range (GHz)	Factor [dB]
0.03 – 1	25.27
1 – 5	27.98
5 – 10	28.59
10 – 15	29.12
15 – 20	29.49
Above 20	30.13

### NOTES:

Factor(dB) = Cable Loss + Attenuator +Power Splitter

Band	Band Width (MHz)	Frequency (MHz)	Frequency of Maximum Harmonic (GHz)	Factor (dB)	Measurement Maximum Data (dBm)	Result (dBm)	Limit (dBm)
17	5	706.5	3.7039	27.98	-67.408	-39.428	-13.00
		710.0	3.6985	27.98	-67.497	-39.517	
		713.5	3.7015	27.98	-67.394	-39.414	
	10	709.0	3.7054	27.98	-67.430	-39.450	
		710.0	3.7054	27.98	-67.120	-39.140	
		711.0	3.6835	27.98	-67.617	-39.637	

### NOTES:

1. Conducted Spurious Emissions was Tested QPSK Modulation, Resource Block Size 1 and Resource Block Offset 0
2. Result (dBm) = Measurement Maximum Data (dBm) + Factor (dB)

- Plots of the EUT's Conducted Spurious Emissions are shown Page 32 ~ 34.

### 8.4.1 BAND EDGE

- Plots of the EUT's Band Edge are shown Page 26 ~ 31.

## 8.5 FREQUENCY STABILITY / VARIATION OF AMBIENT TEMPERATURE

### 8.5.1 FREQUENCY STABILITY (5 MHz Band 17 LTE)

- ▣ OPERATING FREQUENCY: 710,000,000 Hz
- ▣ CHANNEL: 23790 (5 MHz)
- ▣ REFERENCE VOLTAGE: 3.85 VDC
- ▣ DEVIATION LIMIT: Emission must remain in band

Voltage (%)	Power (VDC)	Temp. (°C)	Frequency (Hz)	Frequency Error (Hz)	Deviation (%)	ppm
100%	3.85	+20(Ref)	710 000 004	0.0	0.000 000	0.0000
100%		-30	710 000 009	5.0	0.000 001	0.0070
100%		-20	710 000 000	-3.3	0.000 000	-0.0046
100%		-10	710 000 002	-2.0	0.000 000	-0.0028
100%		0	709 999 999	-4.5	-0.000 001	-0.0063
100%		+10	710 000 008	4.6	0.000 001	0.0065
100%		+30	710 000 008	4.4	0.000 001	0.0062
100%		+40	710 000 009	5.0	0.000 001	0.0070
100%		+50	710 000 008	4.3	0.000 001	0.0061
Batt. Endpoint	3.40	+20	710 000 009	5.3	0.000 001	0.0075

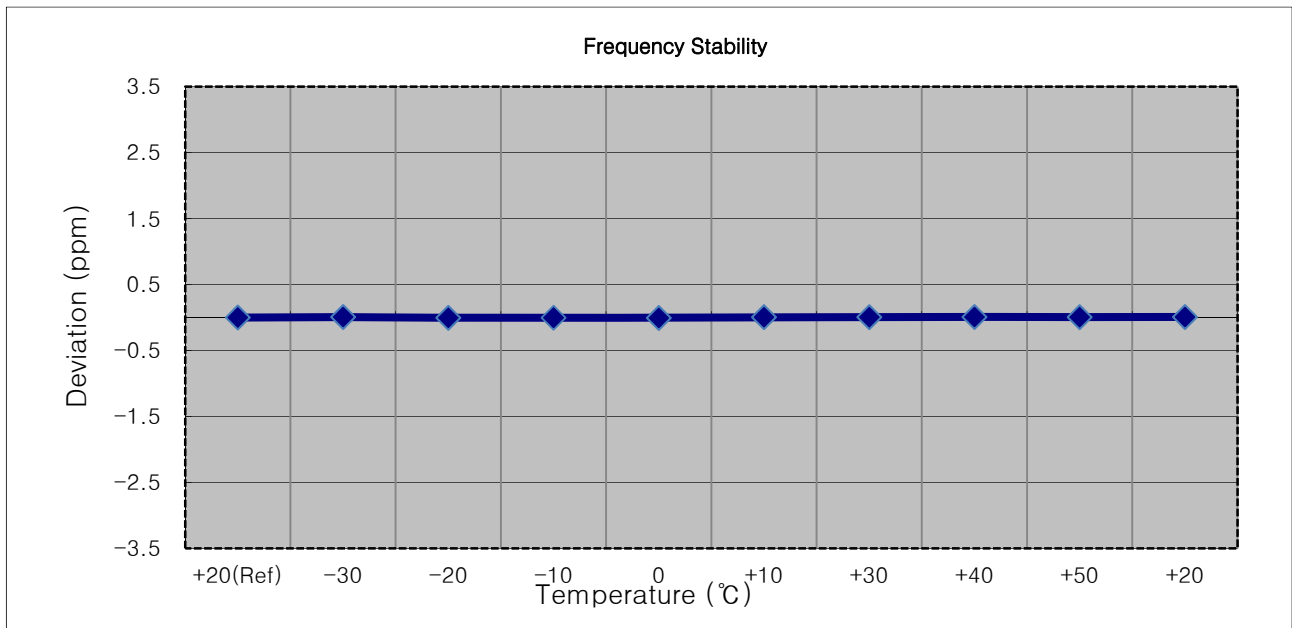

**8.5.2 FREQUENCY STABILITY (10 MHz Band 17 LTE)**

- ▣ OPERATING FREQUENCY: 710,000,000 Hz
- ▣ CHANNEL: 23790 (10 MHz)
- ▣ REFERENCE VOLTAGE: 3.85 VDC
- ▣ DEVIATION LIMIT: Emission must remain in band

Voltage (%)	Power (VDC)	Temp. (°C)	Frequency (Hz)	Frequency Error (Hz)	Deviation (%)	ppm
100%	3.85	+20(Ref)	709 999 994	0.0	0.000 000	0.0000
100%		-30	709 999 998	4.1	0.000 001	0.0058
100%		-20	709 999 997	3.0	0.000 000	0.0042
100%		-10	709 999 998	4.5	0.000 001	0.0063
100%		0	710 000 000	6.0	0.000 001	0.0085
100%		+10	709 999 989	-5.1	-0.000 001	-0.0072
100%		+30	709 999 998	3.8	0.000 001	0.0054
100%		+40	710 000 000	5.7	0.000 001	0.0080
100%		+50	709 999 989	-4.9	-0.000 001	-0.0069
Batt. Endpoint		3.40	+20	709 999 990	-4.3	-0.000 001

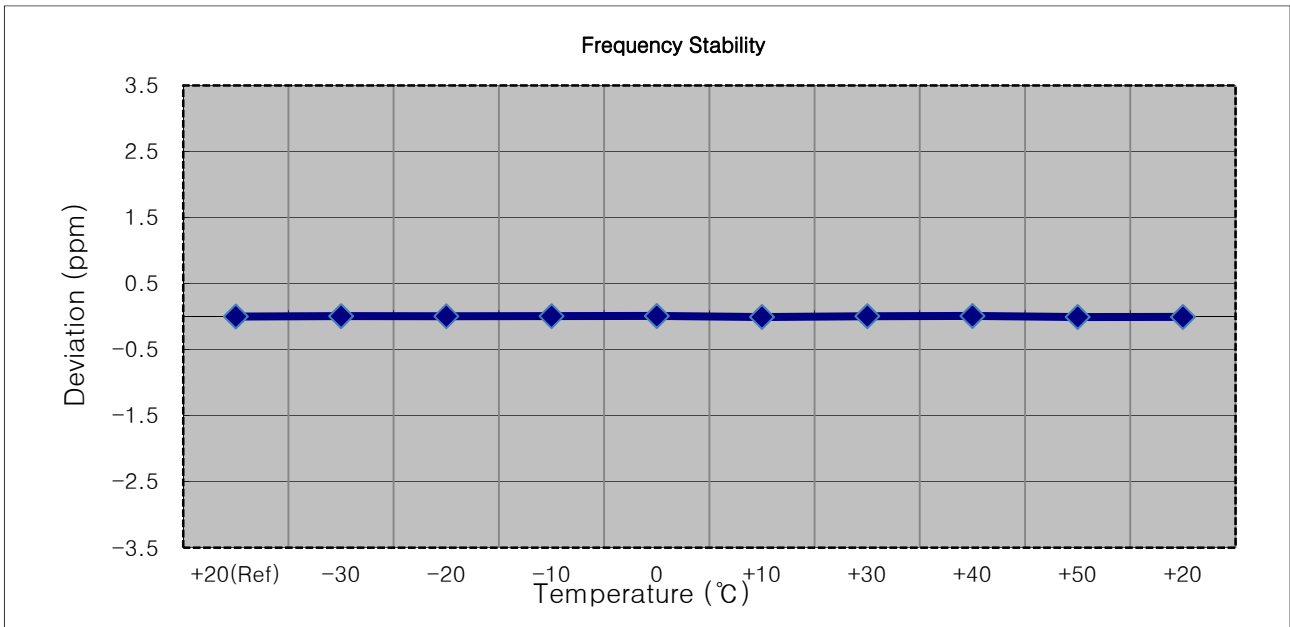

## 9. TEST PLOTS

BAND 17. Occupied Bandwidth Plot (5M BW Ch.23790 QPSK RB 25)

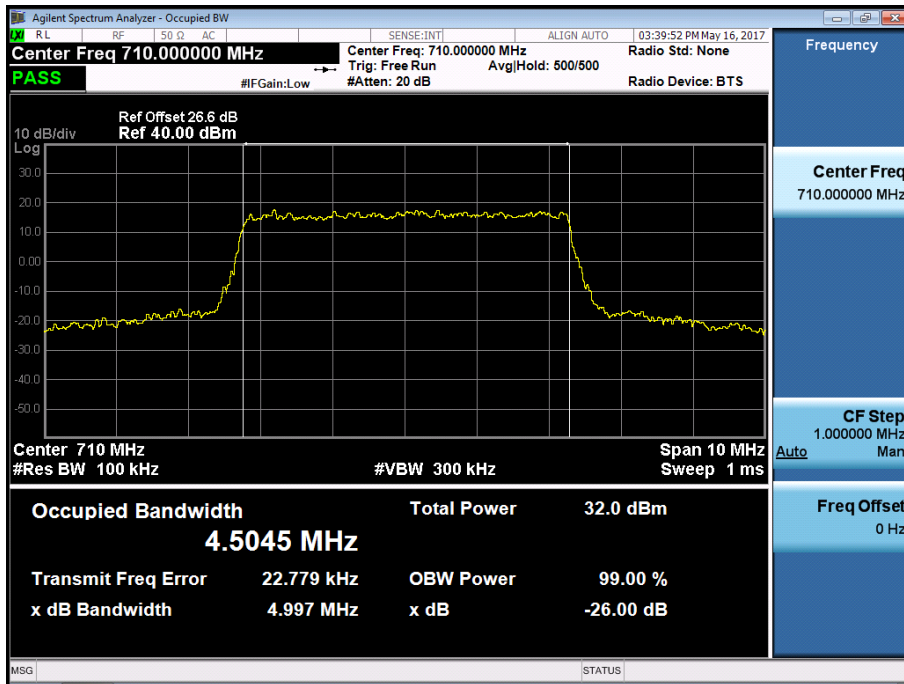

BAND 17. Occupied Bandwidth Plot (5M BW Ch.23790 16QAM RB 25)

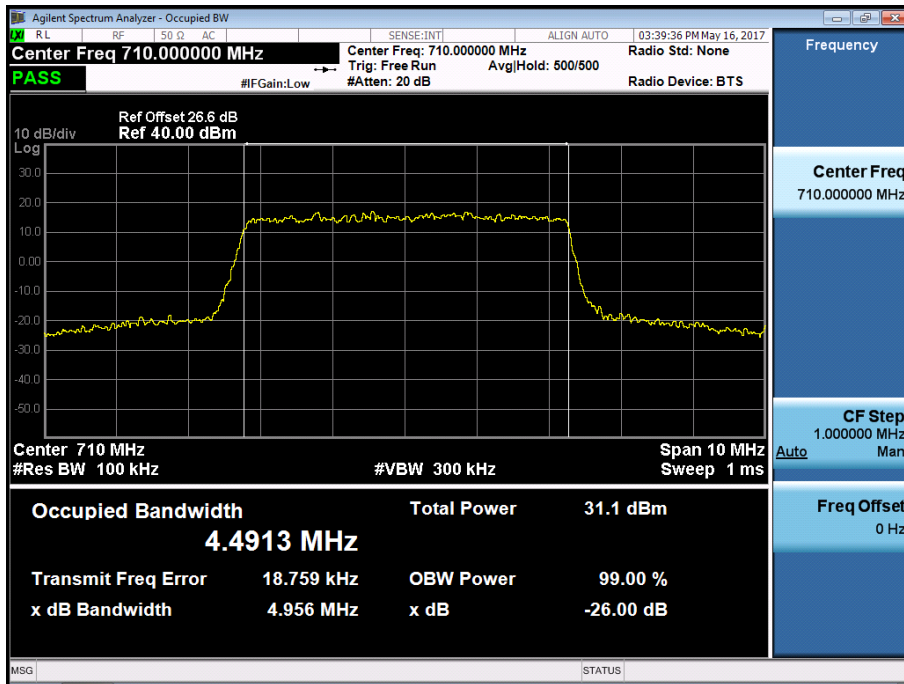



BAND 17. Occupied Bandwidth Plot (10M BW Ch.23790 QPSK RB 50)

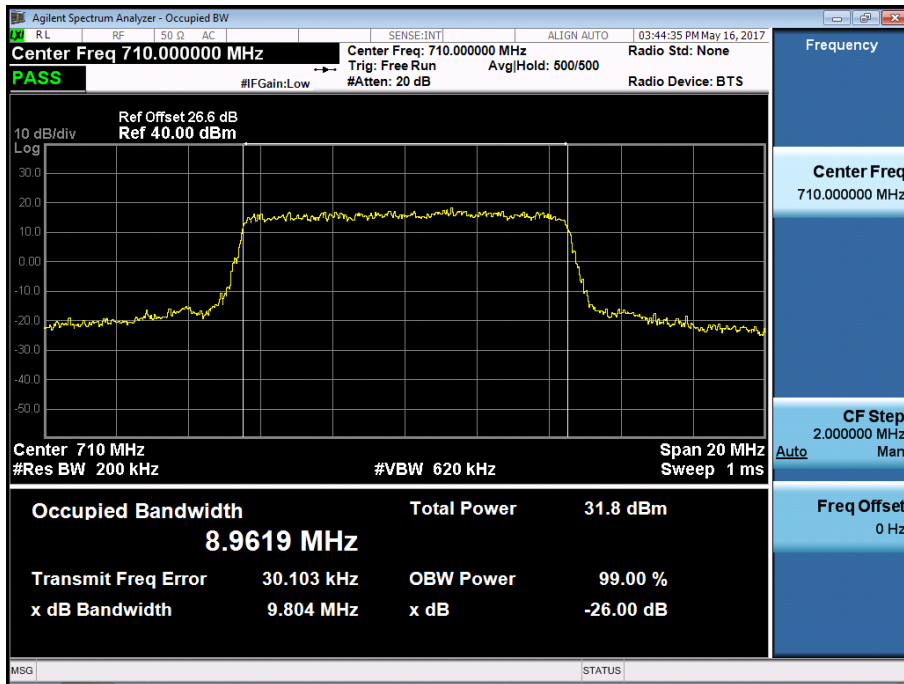

BAND 17. Occupied Bandwidth Plot (10M BW Ch.23790 16QAMRB 50)

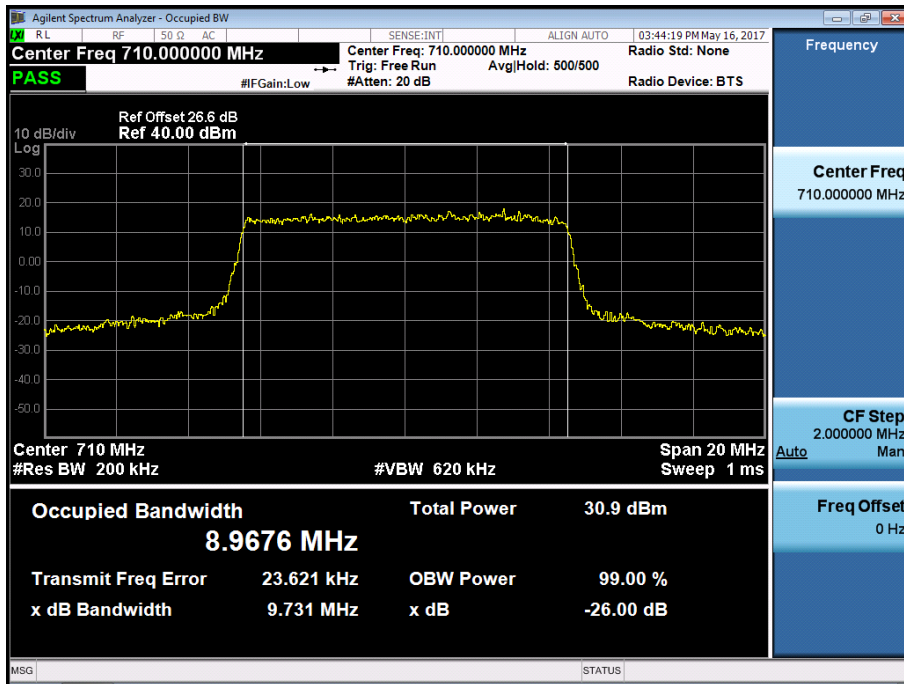

BAND 17. Lower Band Edge Plot (5M BW Ch.23755 QPSK RB 1, Offset 0) -1

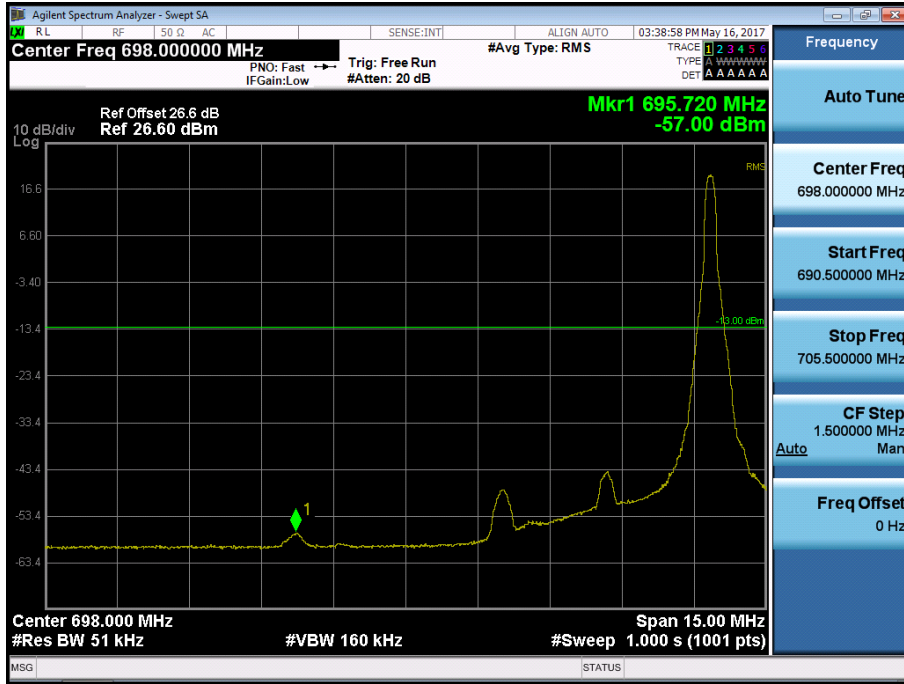

BAND 17. Lower Band Edge Plot (5M BW Ch.23755 QPSK RB 25) -2



BAND 17. Lower Extended Band Edge Plot (5M BW Ch.23755 QPSK\_RB25\_0) -3



BAND 17. Lower Band Edge Plot (10M BW Ch.23780 QPSK RB 1, Offset 0) -1

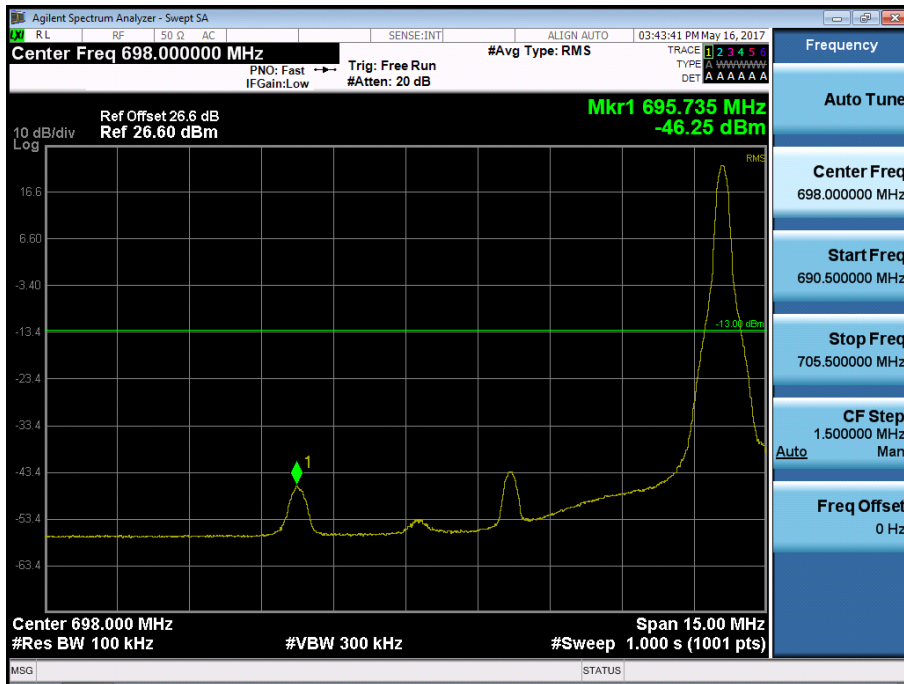

BAND 17. Lower Band Edge Plot (10M BW Ch.23780 QPSK RB 50) -2

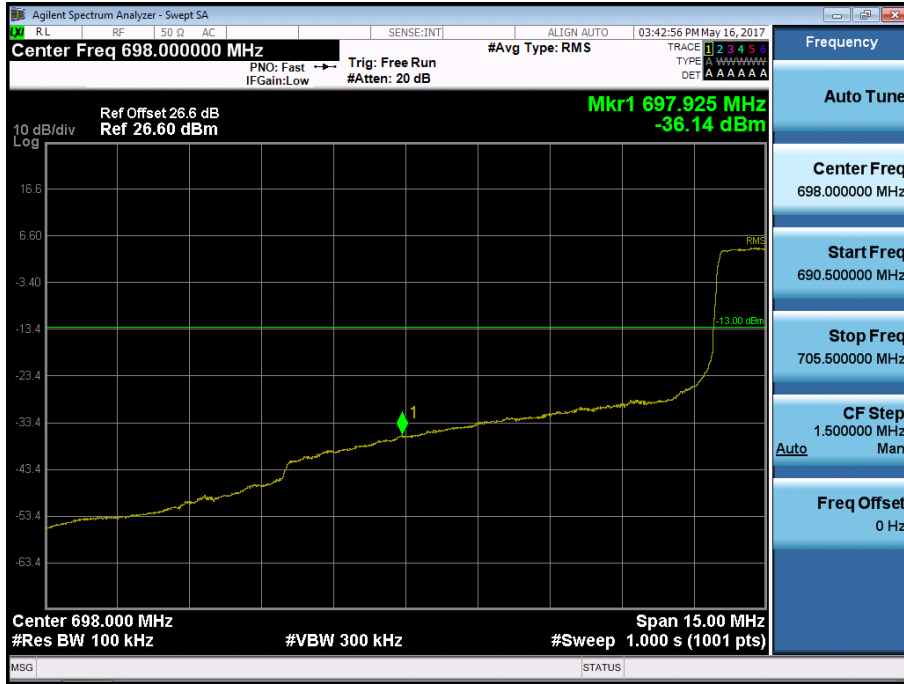

BAND 17. Lower Extended Band Edge Plot (10M BW Ch.23780 QPSK\_RB50\_0) -3



BAND 17. Upper Band Edge Plot (5M BW Ch.23825 QPSK\_RB1\_Offset 24) -1

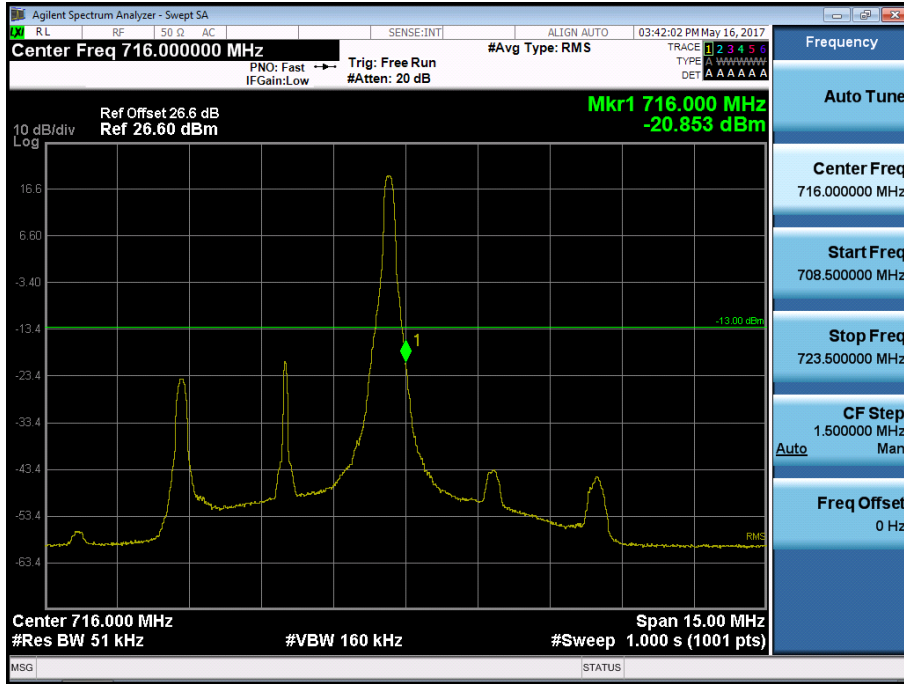

BAND 17. Upper Band Edge Plot (5M BW Ch.23825 QPSK\_RB25) -2



BAND 17. Upper Extended Band Edge Plot (5M BW Ch.23825 QPSK\_RB25) -3



BAND 17. Upper Band Edge Plot (10M BW Ch.23800 QPSK\_RB1\_Offset 49) -1

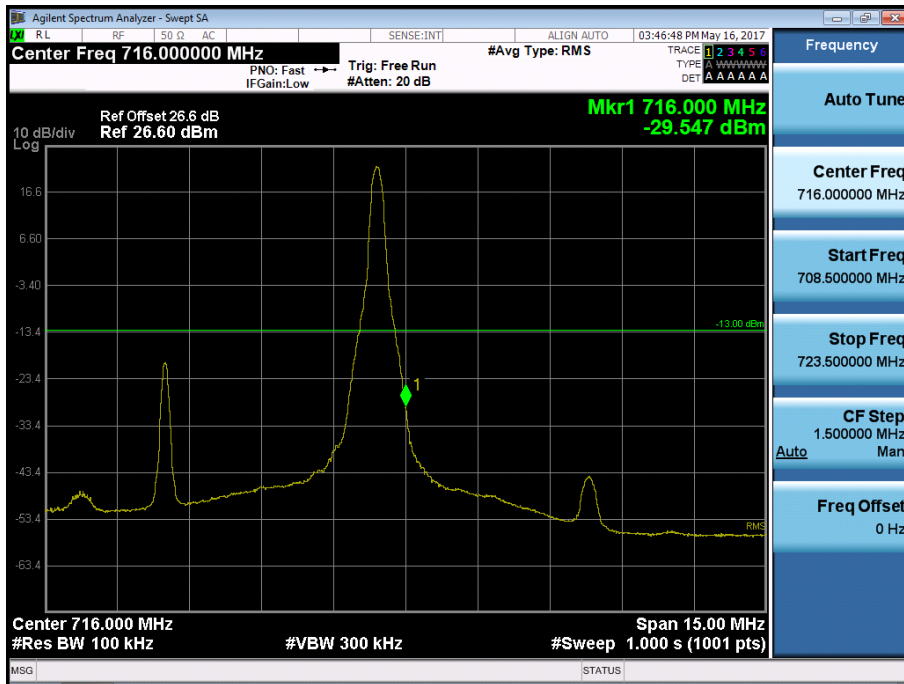

BAND 17. Upper Band Edge Plot (10M BW Ch.23800 QPSK\_RB50) -2



BAND 17. Upper Extended Band Edge Plot (10M BW Ch.23800 QPSK\_RB50) -3

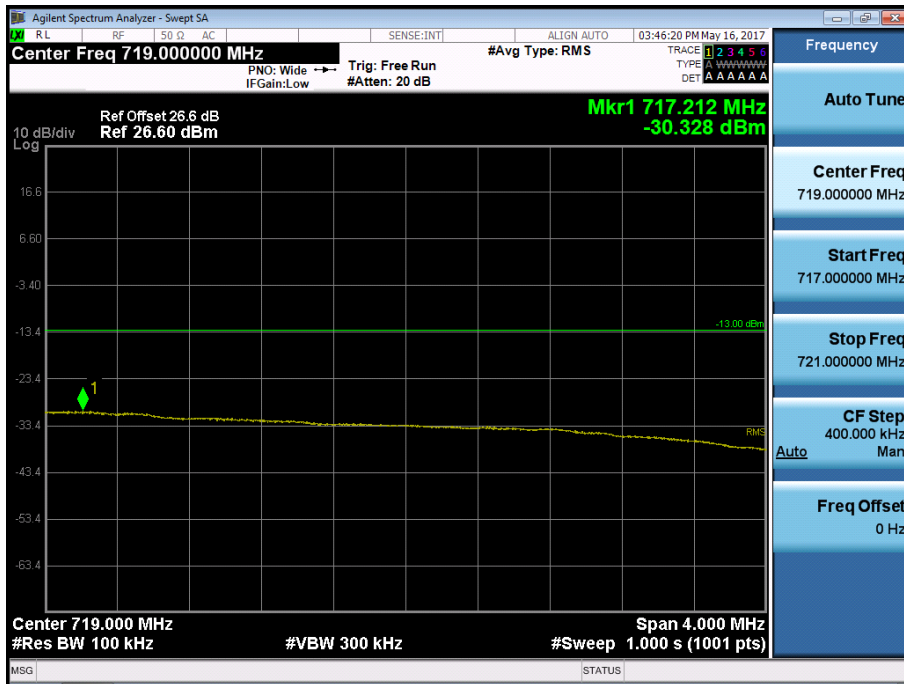

BAND 17. Conducted Spurious Plot\_ (23755ch\_5MHz\_QPSK\_RB 1\_0)

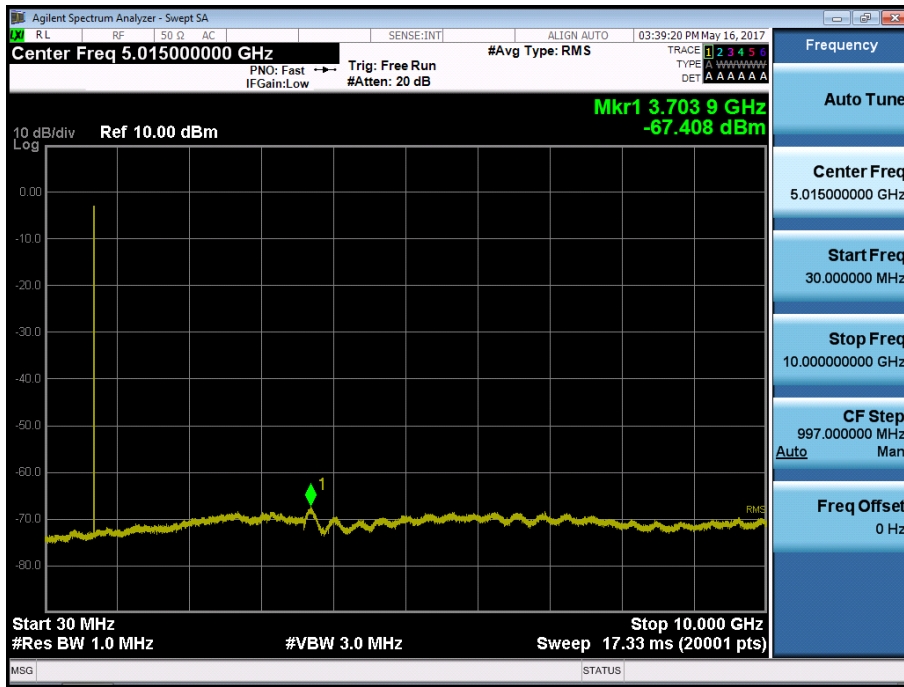

BAND 17. Conducted Spurious Plot\_ (23790ch\_5MHz\_QPSK\_RB 1\_0)

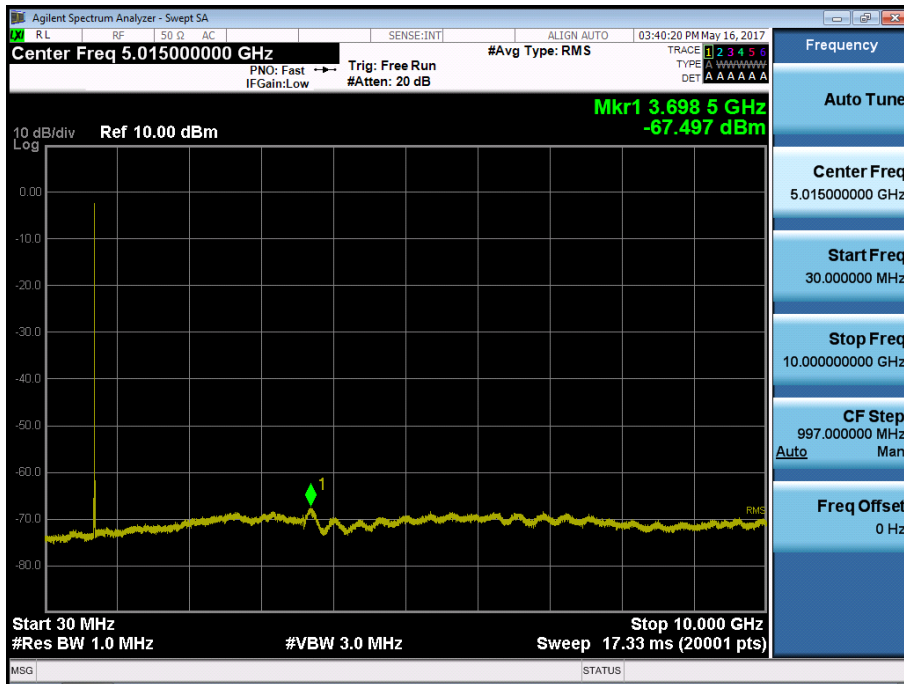



BAND 17. Conducted Spurious Plot\_ (23825ch\_5MHz\_QPSK\_RB 1\_0)

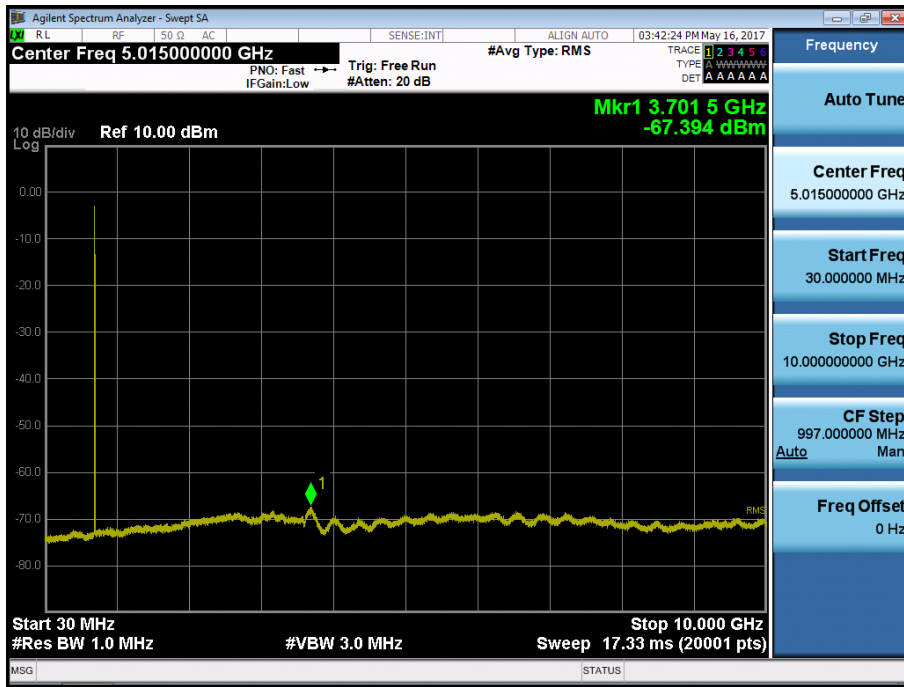

BAND 17. Conducted Spurious Plot\_ (23780ch\_10MHz\_QPSK\_RB 1\_0)

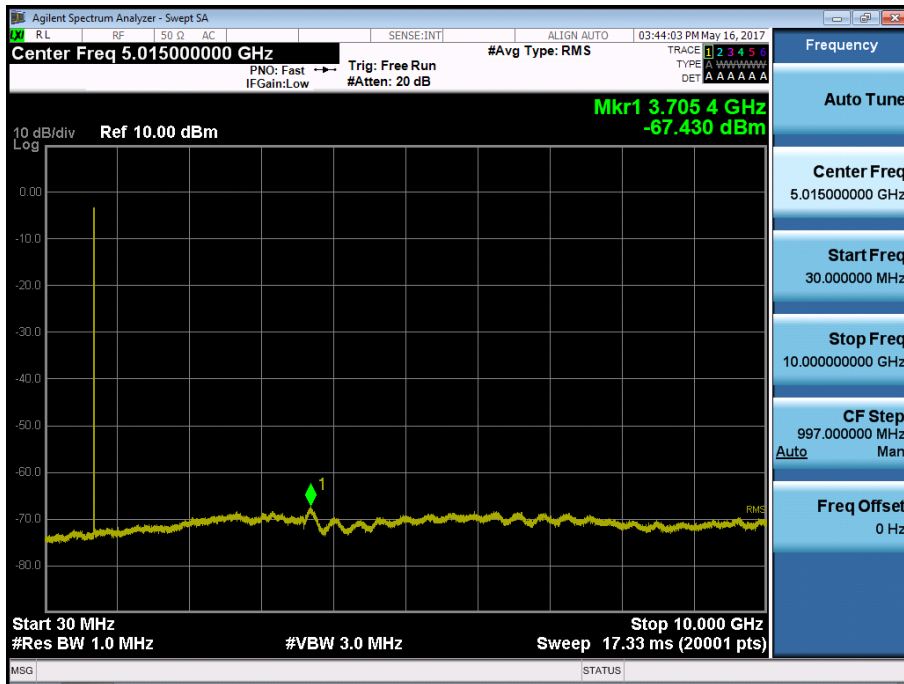

BAND 17. Conducted Spurious Plot\_ (23790ch\_10MHz\_QPSK\_RB 1\_0)

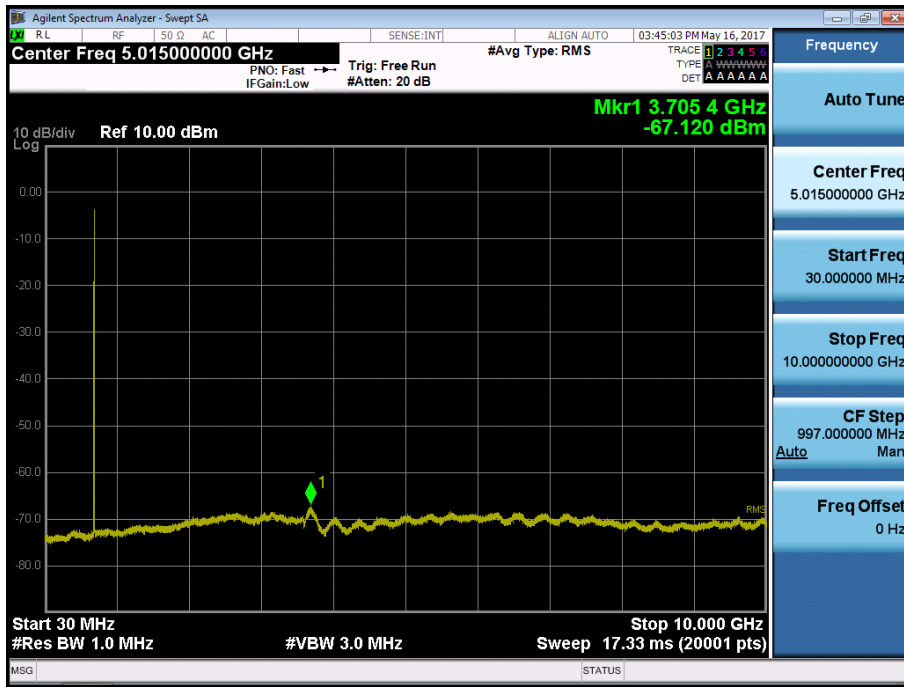

BAND 17. Conducted Spurious Plot\_ (23800ch\_10MHz\_QPSK\_RB 1\_0)

