

FCC LTE REPORT

FCC Certification

Applicant Name:

LG Electronics MobileComm U.S.A., Inc.

Date of Issue:

June 07, 2017

Location:

HCT CO., LTD.,

Address:

1000 Sylvan Avenue, Englewood Cliffs NJ 07632

74, Seoicheon-ro 578beon-gil, Majang-myeon,
 Icheon-si, Gyeonggi-do, 17383, Rep. of KOREA

Report No.: HCT-R-1706-F029

HCT FRN: 0005866421

FCC ID:

ZNFM700H

APPLICANT:

LG Electronics MobileComm U.S.A., Inc.

FCC Model(s): LG-M700H
Additional: LGM700H, M700H
EUT Type: GSM/WCDMA/LTE Phone with Bluetooth4.2LE, WIFI802.11 b/g/n
FCC Classification: Licensed Portable Transmitter Held to Ear (PCE)
FCC Rule Part(s): §27, §2

Mode (MHz)	Tx Frequency (MHz)	Emission Designator	Modulation	EIRP	
				Max. Power (W)	Max. Power (dBm)
LTE – Band4 (1.4)	1710.7 – 1754.3	1M10G7D	QPSK	0.091	19.61
		1M10W7D	16QAM	0.067	18.29
LTE – Band4 (3)	1711.5 – 1753.5	2M70G7D	QPSK	0.093	19.70
		2M70W7D	16QAM	0.067	18.28
LTE – Band4 (5)	1712.5 – 1752.5	4M49G7D	QPSK	0.088	19.46
		4M50W7D	16QAM	0.066	18.17
LTE – Band4 (10)	1715.0 – 1750.0	8M98G7D	QPSK	0.093	19.67
		8M95W7D	16QAM	0.072	18.58
LTE – Band4 (15)	1717.5 – 1747.5	13M4G7D	QPSK	0.091	19.58
		13M4W7D	16QAM	0.072	18.58
LTE – Band4 (20)	1720.0 – 1745.0	17M9G7D	QPSK	0.086	19.34
		18M0W7D	16QAM	0.070	18.43

The measurements shown in this report were made in accordance with the procedures specified in CFR47 section §2.947. I assume full responsibility for the accuracy and completeness of these measurements, and for the qualifications of all persons taking them.

HCT CO., LTD. Certifies that no party to this application has subject to a denial of Federal benefits that includes FCC benefits pursuant to section 5301 of the Anti-Drug Abuse Act of 1998, 21 U.S. C.853(a)



Report prepared by : Jeong Ho Kim
Engineer of Telecommunication Testing Center



Report approved by : Jong Seok Lee
Manager of Telecommunication Testing Center

This report only responds to the tested sample and may not be reproduced, except in full, without written approval of the HCT Co., Ltd.

Version

TEST REPORT NO.	DATE	DESCRIPTION
HCT-R-1706-F029	June 07, 2017	- First Approval Report

Table of Contents

1. GENERAL INFORMATION	4
2. INTRODUCTION	5
2.1. EUT DESCRIPTION.....	5
2.2. MEASURING INSTRUMENT CALIBRATION.....	5
2.3. TEST FACILITY	5
3. DESCRIPTION OF TESTS.....	6
3.1 EIRP RADIATED POWER AND RADIATED SPURIOUS EMISSIONS	6
3.2 AWS – MOBILE FREQUENCY BLOCKS (1710 – 1755 MHz).....	7
3.3 PEAK-AVERAGE RATIO.	8
3.4 OCCUPIED BANDWIDTH.	10
3.5 SPURIOUS AND HARMONIC EMISSIONS AT ANTENNA TERMINAL.....	11
3.6 FREQUENCY STABILITY / VARIATION OF AMBIENT TEMPERATURE	12
4. LIST OF TEST EQUIPMENT	13
5. MEASUREMENT UNCERTAINTY	14
6. SUMMARY OF TEST RESULTS	15
7. SAMPLE CALCULATION.....	16
8. TEST DATA	17
8.1 EQUIVALENT ISOTROPIC RADIATED POWER (Band 4)	17
8.2 RADIATED SPURIOUS EMISSIONS.....	21
8.2.1 RADIATED SPURIOUS EMISSIONS (1.4 MHz Band 4 LTE)	21
8.2.2 RADIATED SPURIOUS EMISSIONS (3 MHz Band 4 LTE)	22
8.2.3 RADIATED SPURIOUS EMISSIONS (5 MHz Band 4 LTE)	23
8.2.4 RADIATED SPURIOUS EMISSIONS (10 MHz Band 4 LTE)	24
8.2.5 RADIATED SPURIOUS EMISSIONS (15 MHz Band 4 LTE)	25
8.2.6 RADIATED SPURIOUS EMISSIONS (20 MHz Band 4 LTE)	26
8.3 PEAK-TO-AVERAGE RATIO	27
8.4 OCCUPIED BANDWIDTH	28
8.5 CONDUCTED SPURIOUS EMISSIONS	29
8.5.1 BAND EDGE.....	29
8.6 FREQUENCY STABILITY / VARIATION OF AMBIENT TEMPERATURE	30
8.6.1 FREQUENCY STABILITY (1.4 MHz Band 4 LTE)	30
8.6.2 FREQUENCY STABILITY (3 MHz Band 4 LTE)	31
8.6.3 FREQUENCY STABILITY (5 MHz Band 4 LTE)	32
8.6.4 FREQUENCY STABILITY (10 MHz Band 4 LTE)	33
8.6.5 FREQUENCY STABILITY (15 MHz Band 4 LTE)	34
8.6.6 FREQUENCY STABILITY (20 MHz Band 4 LTE)	35
9. TEST PLOTS.....	36

MEASUREMENT REPORT

1. GENERAL INFORMATION

Applicant Name: LG Electronics MobileComm U.S.A., Inc.

Address: 1000 Sylvan Avenue, Englewood Cliffs NJ 07632

FCC ID: ZNFM700H

Application Type: Certification

FCC Classification: Licensed Portable Transmitter Held to Ear (PCE)

FCC Rule Part(s): §27, §2

EUT Type: GSM/WCDMA/LTE Phone with Bluetooth4.2LE, WIFI802.11 b/g/n

FCC Model(s): LG-M700H

Additional FCC Model(s): LGM700H, M700H

Tx Frequency: 1710.7 MHz – 1754.3 MHz (LTE – Band 4 (1.4 MHz))
1711.5 MHz – 1753.5 MHz (LTE – Band 4 (3 MHz))
1712.5 MHz – 1752.5 MHz (LTE – Band 4 (5 MHz))
1715.0 MHz – 1750.0 MHz (LTE – Band 4 (10 MHz))
1717.5 MHz – 1747.5 MHz (LTE – Band 4 (15 MHz))
1720.0 MHz – 1745.0 MHz (LTE – Band 4 (20 MHz))

Max. RF Output Power:

Band 4 (1.4 MHz):	0.091 W (QPSK) (19.61 dBm)
	0.067 W (16-QAM) (18.29 dBm)
Band 4 (3 MHz):	0.093 W (QPSK) (19.70 dBm)
	0.067 W (16-QAM) (18.28 dBm)
Band 4 (5 MHz):	0.088 W (QPSK) (19.46 dBm)
	0.066 W (16-QAM) (18.17 dBm)
Band 4 (10 MHz):	0.093 W (QPSK) (19.67 dBm)
	0.072 W (16-QAM) (18.58 dBm)
Band 4 (15 MHz):	0.091 W (QPSK) (19.58 dBm)
	0.072 W (16-QAM) (18.58 dBm)
Band 4 (20 MHz):	0.086 W (QPSK) (19.34 dBm)
	0.070 W (16-QAM) (18.43 dBm)

Emission Designator(s):

Band 4 (1.4 MHz):	1M10G7D (QPSK) / 1M10W7D (16-QAM)
Band 4 (3 MHz):	2M70G7D (QPSK) / 2M70W7D (16-QAM)
Band 4 (5 MHz):	4M49G7D (QPSK) / 4M50W7D (16-QAM)
Band 4 (10 MHz):	8M98G7D (QPSK) / 8M95W7D (16-QAM)
Band 4 (15 MHz):	13M4G7D (QPSK) / 13M4W7D (16-QAM)
Band 4 (20 MHz):	17M9G7D (QPSK) / 18M0W7D (16-QAM)

Date(s) of Tests: April 25 , 2017 ~ May 30, 2017

Antenna Specification:

Manufacturer:	LS Mtron Co. Ltd.
Antenna type:	PIFA Antenna (Planar Inverted F)

2. INTRODUCTION

2.1. EUT DESCRIPTION

The LG Electronics MobileComm U.S.A., Inc. LG-M700H GSM/WCDMA/LTE Phone with Bluetooth4.2LE, WIFI802.11 b/g/n consists of LTE 4.

2.2. MEASURING INSTRUMENT CALIBRATION

The measuring equipment, which was utilized in performing the tests documented herein, has been calibrated in accordance with the manufacturer's recommendations for utilizing calibration equipment, which is traceable to recognized national standards.

2.3. TEST FACILITY

The Fully-anechoic chamber and conducted measurement facility used to collect the radiated data are located at the **74, Seoicheon-ro 578beon-gil, Majang-myeon, Icheon-si, Gyeonggi-do, 17383, Rep. of KOREA.**

3. DESCRIPTION OF TESTS

3.1 EIRP RADIATED POWER AND RADIATED SPURIOUS EMISSIONS

Note: EIRP(Effective Isotropic Radiated Power)

Test Procedure

Radiated emission measurements are performed in the Fully-anechoic chamber. The equipment under test is placed on a non-conductive table 3-meters away from the receive antenna in accordance with ANSI/TIA-603-D-2010 Clause 2.2.17. The turntable is rotated through 360 degrees, and the receiving antenna scans in order to determine the level of the maximized emission. The level and position of the maximized emission is recorded with the spectrum analyzer using a RMS detector.

A half wave dipole is then substituted in place of the EUT. For emissions above 1GHz, a horn antenna is substituted in place of the EUT. The substitute antenna is driven by a signal generator and the previously recorded signal was duplicated.

The power is calculated by the following formula;

$$P_{d(\text{dBm})} = P_{g(\text{dBm})} - \text{cable loss (dB)} + \text{antenna gain (dB)}$$

Where: P_d is the dipole equivalent power and P_g is the generator output power into the substitution antenna.

The maximum EIRP is calculated by adding the forward power to the calibrated source plus its appropriate gain value. These steps are repeated with the receiving antenna in both vertical and horizontal polarization. the difference between the gain of the horn and an isotropic antenna are taken into consideration

Radiated spurious emissions

: Frequency Range : 9 kHz ~ 10th Harmonics of highest channel fundamental frequency.

3.2 AWS – MOBILE FREQUENCY BLOCKS (1710 – 1755 MHz)

§27.5(h)

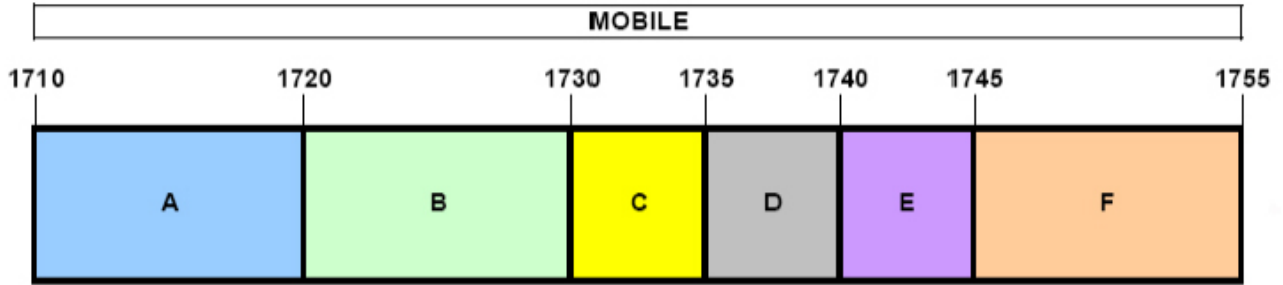

BLOCK 1: 1710 – 1720 MHz (A)

BLOCK 2: 1720 – 1730 MHz (B)

BLOCK 3: 1730 – 1735 MHz (C)

BLOCK 4: 1735 – 1740 MHz (D)

BLOCK 5: 1740 – 1745 MHz (E)

BLOCK 6: 1745 – 1755 MHz (F)

3.3 PEAK-AVERAGE RATIO.

Test Procedure

Peak to Average Power Ratio is tested in accordance with KDB971168 D01 Power Meas License Digital Systems v02r02, October 17, 2014, Section 5.7.

- Section 5.7.1 CCDF Procedure

- a) Set resolution/measurement bandwidth \geq signal's occupied bandwidth;
- b) Set the number of counts to a value that stabilizes the measured CCDF curve;
- c) Set the measurement interval as follows:
 - 1) for continuous transmissions, set to 1 ms,
 - 2) for burst transmissions, employ an external trigger that is synchronized with the EUT burst timing sequence, or use the internal burst trigger with a trigger level that allows the burst to stabilize and set the measurement interval to a time that is less than or equal to the burst duration.
- d) Record the maximum PAPR level associated with a probability of 0.1%.

- Section 5.7.2 Alternate Procedure

Use one of the procedures presented in 5.1 to measure the total peak power and record as P_{Pk} . Use one of the applicable procedures presented 5.2 to measure the total average power and record as P_{Avg} . Determine the P.A.R. from: $P.A.R_{(dB)} = P_{Pk (dBm)} - P_{Avg (dBm)}$ (P_{Avg} = Average Power + Duty cycle Factor)

5.1.1 Peak power measurements with a spectrum/signal analyzer or EMI receiver

The following procedure can be used to determine the total peak output power.

- a) Set the RBW \geq OBW.
- b) Set VBW $\geq 3 \times$ RBW.
- c) Set span $\geq 2 \times$ RBW
- d) Sweep time = auto couple.
- e) Detector = peak.
- f) Ensure that the number of measurement points \geq span/RBW.
- g) Trace mode = max hold.
- h) Allow trace to fully stabilize.
- i) Use the peak marker function to determine the peak amplitude level.

5.2.2 Procedures for use with a spectrum/signal analyzer when EUT cannot be configured to transmit continuously and sweep triggering/signal gating cannot be properly implemented

If the EUT cannot be configured to transmit continuously (burst duty cycle < 98%), then one of the following procedures can be used. The selection of the applicable procedure will depend on the characteristics of the measured burst duty cycle.

Measure the burst duty cycle with a spectrum/signal analyzer or EMC receiver can be used in zero-span mode if the response time and spacing between bins on the sweep are sufficient to permit accurate measurement of the burst on/off time of the transmitted signal.

5.2.2.2 Constant burst duty cycle

If the measured burst duty cycle is constant (i.e., duty cycle variations are less than ± 2 percent), then:

- a) Set span to at least 1.5 times the OBW.
- b) Set RBW = 1-5% of the OBW, not to exceed 1 MHz.
- c) Set VBW $\geq 3 \times$ RBW.
- d) Number of points in sweep $\geq 2 \times$ span / RBW. (This gives bin-to-bin spacing \leq RBW/2, so that narrowband signals are not lost between frequency bins.)
- e) Sweep time = auto.
- f) Detector = RMS (power averaging).
- g) Set sweep trigger to "free run".
- h) Trace average at least 100 traces in power averaging (i.e., RMS) mode.
- i) Compute power by integrating the spectrum across the OBW of the signal using the instrument's band power measurement function with band limits set equal to the OBW band edges. If the instrument does not have a band power function, sum the spectrum levels (in power units) at intervals equal to the RBW extending across the entire OBW of the spectrum.
- j) Add $10 \log (1/x)$, where x is the duty cycle, to the measured power in order to compute the average power during the actual transmission times (because the measurement represents an average over both the on and off times of the transmission).

For example, add $10 \log (1/0.25) = 6$ dB if the duty cycle is a constant 25%.

3.4 OCCUPIED BANDWIDTH.

Test set-up

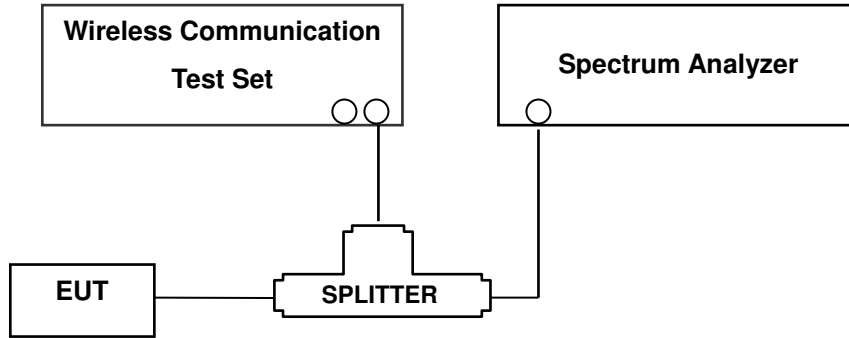

(Configuration of conducted Emission measurement)

The width of a frequency band such that, below the lower and above the upper frequency limits, the mean powers emitted are each equal to a specified percentage 0.5 % of the total mean power of a given emission.

Test Procedure

OBW is tested in accordance with KDB971168 D01 Power Meas License Digital Systems v02r02, October 17, 2014, Section 4.2.

The EUT makes a call to the communication simulator. The power was measured with R&S Spectrum Analyzer. All measurements were done at 3 channels(low, middle and high operational range.)

The conducted occupied bandwidth used the power splitter via EUT RF power connector between simulation base station and spectrum analyzer.

The communication simulator station system controlled a EUT to export maximum output power under transmission mode and specific channel frequency. Use OBW measurement function of Spectrum analyzer to measure 99 % occupied bandwidth

3.5 SPURIOUS AND HARMONIC EMISSIONS AT ANTENNA TERMINAL.

Test Procedure

Spurious and harmonic emissions at antenna terminal is tested in accordance with KDB971168 D01 Power Meas License Digital Systems v02r02, October 17, 2014, Section 6.0.

The level of the carrier and the various conducted spurious and harmonic frequencies is measured by means of a calibrated spectrum analyzer.

The spectrum is scanned from the lowest frequency generated in the equipment up to a frequency including its 10th harmonic. On any frequency outside a licensee's frequency block, the power of any emission shall be attenuated below the transmitter power (P) by at least $43 + 10 \log(P)$ dB. Compliance with these provisions is based on the use of measurement instrumentation employing a resolution bandwidth of 1 MHz or greater. However, in the 100 kHz bands immediately outside and adjacent to the frequency block a resolution bandwidth of at least 30 kHz bandwidth may be employed. The emission bandwidth is defined as the width of the signal between two points, one below the carrier center frequency and one above the carrier center frequency

NOTES: The analyzer plot offsets were determined by below conditions.

- For LTE Band 4, total offset 27.0 dB = 20 dB attenuator + 6 dB Divider + 1.0 dB RF cables.

3.6 FREQUENCY STABILITY / VARIATION OF AMBIENT TEMPERATURE

Test Set-up

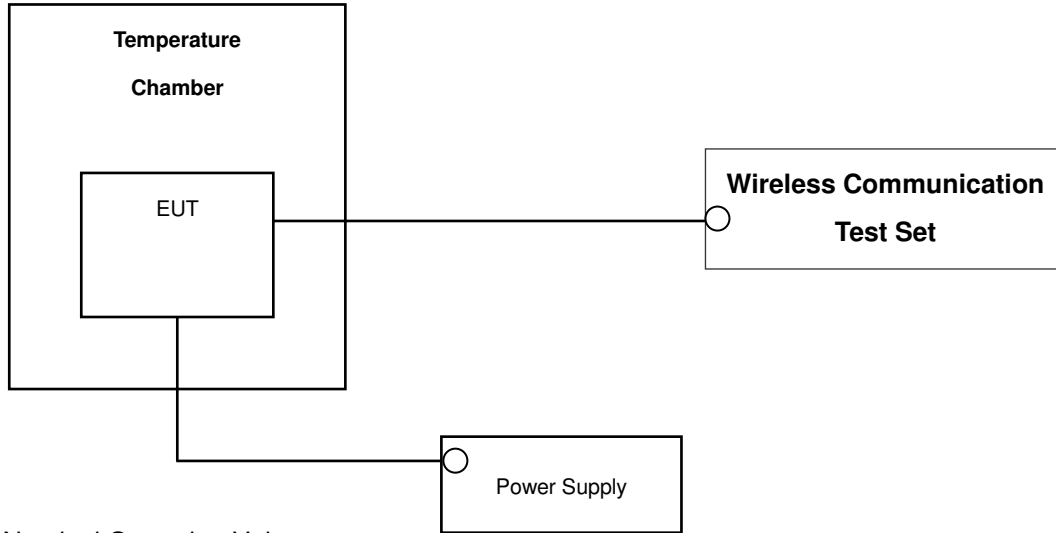

* Nominal Operating Voltage

Test Procedure

Frequency stability is tested in accordance with ANSI/TIA-603-D-2010 section 2.2.2

The frequency stability of the transmitter is measured by:

- a.) **Temperature:** The temperature is varied from - 30 °C to + 50 °C using an environmental chamber.
- b.) **Primary Supply Voltage:** The primary supply voltage is varied from the end point to 100 % of the voltage normally at the input to the device or at the power supply terminals if cables are not normally supplied.

Specification — the frequency stability shall be sufficient to ensure that the fundamental emission stays within the authorized frequency block

Time Period and Procedure:

The carrier frequency of the transmitter is measured at room temperature (20°C to provide a reference).

1. The equipment is turned on in a "standby" condition for one minute before applying power to the transmitter. Measurement of the carrier frequency of the transmitter is made within one minute after applying power to the transmitter.
2. Frequency measurements are made at 10°C intervals ranging from -30°C to +50°C. A period of at least one half-hour is provided to allow stabilization of the equipment at each temperature level.

NOTE: The EUT is tested down to the battery endpoint.

4. LIST OF TEST EQUIPMENT

Manufacture	Model/ Equipment	Serial Number	Calibration Date	Calibration Interval	Calibration Due
REOHDE & SCHWARZ	SCU 18 / AMPLIFIER	10094	04/24/2017	Annual	04/24/2018
Wainwright	WHK1.2/15G-10EF/H.P.F	4	04/10/2017	Annual	04/10/2018
Wainwright	WHK3.3/18G-10EF/H.P.F	2	04/10/2017	Annual	04/10/2018
Hewlett Packard	11667B / Power Splitter	10545	02/15/2017	Annual	02/15/2018
Hewlett Packard	11667B / Power Splitter	11275	05/04/2017	Annual	05/04/2018
Agilent	E3632A/DC Power Supply	KR75303243	07/12/2016	Annual	07/12/2017
Schwarzbeck	UHAP/ Dipole Antenna	557	03/31/2017	Biennial	03/31/2019
Schwarzbeck	UHAP/ Dipole Antenna	558	03/31/2017	Biennial	03/31/2019
EXP	EX-TH400/ Chamber	None	05/31/2016	Annual	05/31/2017
Schwarzbeck	BBHA 9120D/ Horn Antenna	147	09/09/2016	Biennial	09/09/2018
Schwarzbeck	BBHA 9120D/ Horn Antenna	1298	10/14/2016	Biennial	10/14/2018
Schwarzbeck	BBHA 9170/ Horn Antenna(15~40GHz)	BBHA9170342	04/25/2017	Biennial	04/25/2019
Schwarzbeck	BBHA 9170/ Horn Antenna(15~40GHz)	BBHA9170124	04/25/2017	Biennial	04/25/2019
Agilent	N9020A/Signal Analyzer	MY51110074	11/28/2016	Annual	11/28/2017
Hewlett Packard	8493C/ATTENUATOR	17280	06/22/2016	Annual	06/22/2017
REOHDE & SCHWARZ	FSV40/Spectrum Analyzer	1307.9002K40-100931-NK	06/15/2016	Annual	06/15/2017
Agilent	8960 (E5515C)/ Base Station	MY48360800	10/19/2016	Annual	10/19/2017
Schwarzbeck	FMZB1513/ Loop Antenna(9kHz~30MHz)	1513-175	04/06/2017	Biennial	04/06/2019
Schwarzbeck	VULB9160/ Bilog Antenna	3150	09/30/2016	Biennial	09/30/2018
Schwarzbeck	VULB9160/ Bilog Antenna	3368	10/14/2016	Biennial	10/14/2018
REOHDE & SCHWARZ	ESU / EMI TEST RECEIVER	100346	08/11/2017	Annual	08/11/2018
Anritsu Corp.	MT8820C/Wideband Radio Communication Tester	6200863156	02/15/2017	Annual	02/15/2018
Anritsu Corp.	MT8820C/Wideband Radio Communication Tester	6201026545	02/13/2017	Annual	02/13/2018
Anritsu Corp.	MT8821C/Radio Communication Analyzer	6201502997	08/04/2016	Annual	08/04/2017
REOHDE & SCHWARZ	SMB100A/ SIGNAL GENERATOR (100kHz~40GHz)	177633	07/18/2016	Annual	07/18/2017

5. MEASUREMENT UNCERTAINTY

The measurement uncertainties shown below were calculated in accordance with the requirements of ANSI C63.4:2014.

All measurement uncertainty values are shown with a coverage factor of $k = 2$ to indicate a 95 % level of confidence. The measurement data shown herein meets or exceeds the U_{CISPR} measurement uncertainty values specified in CISPR 16-4-2 and, thus, can be compared directly to specified limits to determine compliance.

Parameter	Expanded Uncertainty (\pm dB)
Conducted Disturbance (150 kHz ~ 30 MHz)	1.82
Radiated Disturbance (9 kHz ~ 30 MHz)	3.40
Radiated Disturbance (30 MHz ~ 1 GHz)	4.80
Radiated Disturbance (1 GHz ~ 18 GHz)	6.07

6. SUMMARY OF TEST RESULTS

FCC Part Section(s)	Test Description	Test Limit	Test Condition	Test Result
2.1049	Occupied Bandwidth	N/A	CONDUCTED	PASS
2.1051, 27.53(h)	Band Edge / Spurious and Harmonic Emissions at Antenna Terminal.	$< 43 + 10 \log_{10}(P[\text{Watts}])$ at Band Edge and for all-of-band emissions		PASS
27.50(d)(5)	Peak-Average Ratio	$< 13 \text{ dB}$		PASS
2.1046	* Conducted Output Power	N/A		PASS
2.1055, 27.54	Frequency stability / variation of ambient temperature	Emission must remain in band		PASS
27.50(d)(4)	Equivalent Isotropic Radiated Power	$< 1 \text{ Watts max. EIRP}$	RADIATED	PASS
				PASS
2.1053, 27.53(h)	Undesirable Out-of-Band Emissions	$< 43 + 10 \log_{10}(P[\text{Watts}])$ for all out-of-band emissions		PASS

*: See SAR Report

7. SAMPLE CALCULATION

A. EIRP Sample Calculation

Mode	Ch./ Freq.		Measured Level(dBm)	Substitute LEVEL(dBm)	Ant. Gain (dBi)	C.L	Pol.	Limit	EIRP	
	channel	Freq.(MHz)						W	W	dBm
LTE Band4	20175	1,732.50	-15.75	18.45	9.90	1.76	H	< 1.00	0.456	26.59

EIRP = Substitute LEVEL(dBm) + Ant. Gain – CL(Cable Loss)

- 1) The EUT mounted on a wooden tripod is 2.5 meter above test site ground level.
- 2) During the test , the turn table is rotated and the antenna height is found.
- 3) Record the field strength meter's level.
- 4) Replace the EUT with dipole/Horn antenna that is connected to a calibrated signal generator.
- 5) Increase the signal generator output till the field strength meter's level is equal to the item (3).
- 6) The signal generator output level with Ant. Gain and cable loss are the rating of equivalent isotropic radiated power (EIRP).

B. Emission Designator

QPSK Modulation

Emission Designator = 4M48G7D

LTE BW = 4.48 MHz

G = Phase Modulation

7 = Quantized/Digital Info

D = Data transmission; telemetry; telecommand

16QAM Modulation

Emission Designator = 4M48W7D

LTE BW = 4.48 MHz

W = main carrier modulated in a combination of two

or more of the following modes;

amplitude, angle, pulse

7 = Quantized/Digital Info

D = Data transmission; telemetry; telecommand

8. TEST DATA

8.1 EQUIVALENT ISOTROPIC RADIATED POWER (Band 4)

Freq (MHz)	Bandwidth	Modulation	Measured Level (dBm)	Substitute Level (dBm)	Ant. Gain(dBi)	C.L	Pol	Limit	EIRP	
								W	W	dBm
1710.7	1.4 MHz	QPSK	-20.74	11.84	9.37	1.92	V	< 1.00	0.085	19.29
		16-QAM	-21.78	10.80	9.37	1.92	V		0.067	18.25
1732.5		QPSK	-20.53	12.09	9.45	1.93	V		0.091	19.61
		16-QAM	-22.02	10.60	9.45	1.93	V		0.065	18.12
1754.3		QPSK	-20.93	11.68	9.52	1.94	V		0.084	19.26
		16-QAM	-21.90	10.71	9.52	1.94	V		0.067	18.29

Equivalent Isotropic Radiated Power Data (1.4 MHz Band4 LTE)

Note: All of RB size has been tested for emissions and EIRP, with the 1RB configuration observed as the worst case

Freq (MHz)	Bandwidth	Modulation	Measured Level (dBm)	Substitute Level (dBm)	Ant. Gain(dBi)	C.L	Pol	Limit	EIRP	
								W	W	dBm
1711.5	3 MHz	QPSK	-20.80	11.78	9.37	1.92	V	< 1.00	0.084	19.23
		16-QAM	-21.97	10.61	9.37	1.92	V		0.064	18.06
1732.5		QPSK	-20.44	12.18	9.45	1.93	V		0.093	19.70
		16-QAM	-21.86	10.76	9.45	1.93	V		0.067	18.28
1753.5		QPSK	-21.31	11.29	9.52	1.94	V		0.077	18.87
		16-QAM	-22.50	10.10	9.52	1.94	V		0.059	17.68

Equivalent Isotropic Radiated Power Data (3 MHz Band4 LTE)

Note: All of RB size has been tested for emissions and EIRP, with the 1RB configuration observed as the worst case

Freq (MHz)	Bandwidth	Modulation	Measured Level (dBm)	Substitute Level (dBm)	Ant. Gain(dBi)	C.L	Pol	Limit	EIRP	
								W	W	dBm
1712.5	5 MHz	QPSK	-20.58	12.00	9.37	1.92	V	< 1.00	0.088	19.45
		16-QAM	-21.86	10.72	9.37	1.92	V		0.066	18.17
1732.5		QPSK	-20.68	11.94	9.45	1.93	V		0.088	19.46
		16-QAM	-22.09	10.53	9.45	1.93	V		0.064	18.05
1752.5		QPSK	-21.28	11.32	9.52	1.94	V		0.078	18.90
		16-QAM	-22.25	10.35	9.52	1.94	V		0.062	17.93

Equivalent Isotropic Radiated Power Data (5 MHz Band4 LTE)

Note: All of RB size has been tested for emissions and EIRP, with the 1RB configuration observed as the worst case

Freq (MHz)	Bandwidth	Modulation	Measured Level (dBm)	Substitute Level (dBm)	Ant. Gain(dBi)	C.L	Pol	Limit	EIRP	
								W	W	dBm
1715.0	10 MHz	QPSK	-20.38	12.20	9.39	1.92	V	< 1.00	0.093	19.67
		16-QAM	-21.93	10.65	9.39	1.92	V		0.065	18.12
1732.5		QPSK	-20.86	11.76	9.45	1.93	V		0.085	19.28
		16-QAM	-21.56	11.06	9.45	1.93	V		0.072	18.58
1750.0		QPSK	-21.19	11.41	9.51	1.94	V		0.079	18.98
		16-QAM	-22.23	10.37	9.51	1.94	V		0.062	17.94

Equivalent Isotropic Radiated Power Data (10 MHz Band4 LTE)

Note: All of RB size has been tested for emissions and EIRP, with the 1RB configuration observed as the worst case

Freq (MHz)	Bandwidth	Modulation	Measured Level (dBm)	Substitute Level (dBm)	Ant. Gain(dBi)	C.L	Pol	Limit	EIRP	
								W	W	dBm
1717.5	15 MHz	QPSK	-20.48	12.11	9.39	1.92	V	< 1.00	0.091	19.58
		16-QAM	-21.48	11.11	9.39	1.92	V		0.072	18.58
1732.5		QPSK	-21.07	11.55	9.45	1.93	V		0.081	19.07
		16-QAM	-21.77	10.85	9.45	1.93	V		0.069	18.37
1747.5		QPSK	-20.99	11.62	9.50	1.94	V		0.083	19.18
		16-QAM	-22.11	10.50	9.50	1.94	V		0.064	18.06

Equivalent Isotropic Radiated Power Data (15 MHz Band4 LTE)

Note: All of RB size has been tested for emissions and EIRP, with the 1RB configuration observed as the worst case

Freq (MHz)	Bandwidth	Modulation	Measured Level (dBm)	Substitute Level (dBm)	Ant. Gain(dBi)	C.L	Pol	Limit	EIRP	
								W	W	dBm
1720.0	20 MHz	QPSK	-20.72	11.86	9.40	1.92	V	< 1.00	0.086	19.34
		16-QAM	-21.63	10.95	9.40	1.92	V		0.070	18.43
1732.5		QPSK	-21.07	11.55	9.45	1.93	V		0.081	19.07
		16-QAM	-21.78	10.84	9.45	1.93	V		0.069	18.36
1745.0		QPSK	-21.00	11.62	9.49	1.94	V		0.083	19.17
		16-QAM	-21.89	10.73	9.49	1.94	V		0.067	18.28

Equivalent Isotropic Radiated Power Data (20 MHz Band 4 LTE)

Note: All of RB size has been tested for emissions and EIRP, with the 1RB configuration observed as the worst case

NOTES:Equivalent Isotropic Radiated Power Measurements by Substitution Methodaccording to ANSI/TIA/EIA-603-D-2010 June 24, 2010:

The EUT was placed on a non-conductive styrofoam resin table 3-meters from the receive antenna. The receive antenna height and turntable rotation was adjusted for the highest reading on the receive spectrum analyzer. For LTE signals, RBW = 1-5% of the OBW, not to exceed 1MHz, VBW $\geq 3 \times$ RBW, Detector = RMS. A Horn antenna was substituted in place of the EUT. This Horn antenna was driven by a signal generator and the level of the signal generator was adjusted to obtain the same receive spectrum analyzer reading. The conducted power at the terminals of the Horn antenna is measured. The difference between the gain of the horn and an isotropic antenna is taken into consideration and the EIRP is recorded.

Also, we have done x, y, z planes in EUT and horizontal and vertical polarization in detecting antenna. The worst case of the EUT is z plane in LTE mode. Also worst case of detecting Antenna is vertical polarization in LTE mode.

8.2 RADIATED SPURIOUS EMISSIONS

8.2.1 RADIATED SPURIOUS EMISSIONS (1.4 MHz Band 4 LTE)

- ▣ OPERATING FREQUENCY: 1732.50 MHz
- ▣ MEASURED OUTPUT POWER: 19.61 dBm = 0.091 W
- ▣ MODULATION SIGNAL: 1.4 MHz QPSK
- ▣ DISTANCE: 3 meters
- ▣ LIMIT: $43 + 10 \log_{10}(W) =$ 32.61 dBc

Ch	Freq (MHz)	Measured Level (dBm)	Ant. Gain (dBi)	Substitute Level (dBm)	C.L	Pol	EIRP (dBm)	dBc
19957 (1710.7)	3,421.40	-56.28	12.19	-63.26	2.78	H	-53.85	73.46
	5,132.10	-55.97	12.76	-56.64	3.44	V	-47.32	66.93
	6,842.80	-56.31	12.06	-52.36	3.99	H	-44.29	63.90
20175 (1732.5)	3,465.00	-56.51	12.28	-63.15	2.76	V	-53.63	73.24
	5,197.50	-56.83	12.86	-57.73	3.47	V	-48.34	67.95
	6,930.00	-55.04	11.87	-50.34	4.06	V	-42.53	62.14
20393 (1754.3)	3,508.60	-56.43	12.36	-62.64	2.82	V	-53.10	72.71
	5,262.90	-56.90	12.95	-58.58	3.49	H	-49.12	68.73
	7,017.20	-53.94	11.73	-50.69	3.98	H	-42.94	62.55

- NOTES:**
1. Radiated Spurious Emission Measurements at 3 meters by Substitution Method according to ANSI/TIA/EIA-603-D-2010 June 24, 2010:
 2. We are performed all frequency to 10th harmonics from 9 kHz. Measurements above show only up to 3 maximum emissions noted, or would be lesser if no specific emissions from the EUT are recorded (ie: margin > 20 dB from the applicable limit) and considered that's already beyond the background noise floor.
 3. We have done x, y, z planes in EUT and horizontal and vertical polarization in detecting antenna.
 4. All of RB size has been tested for emissions and EIRP, with the 1RB configuration observed as the worst case
 5. We are performed 16QAM and QPSK modulations. The worst case data are reported in the table above.

8.2.2 RADIATED SPURIOUS EMISSIONS (3 MHz Band 4 LTE)

- ▣ OPERATING FREQUENCY: 1732.50 MHz
- ▣ MEASURED OUTPUT POWER: 19.70 dBm = 0.093 W
- ▣ MODULATION SIGNAL: 3 MHz QPSK
- ▣ DISTANCE: 3 meters
- ▣ LIMIT: $43 + 10 \log_{10}(W) =$ 32.70 dBc

Ch	Freq (MHz)	Measured Level (dBm)	Ant. Gain (dBi)	Substitute Level (dBm)	C.L	Pol	EIRP (dBm)	dBc
19965 (1711.5)	3,423.00	-55.56	12.20	-62.57	2.78	H	-53.15	72.85
	5,134.50	-56.63	12.76	-57.32	3.44	H	-48.00	67.70
	6,846.00	-56.01	12.05	-52.00	3.99	H	-43.94	63.64
20175 (1732.5)	3,465.00	-56.47	12.28	-63.11	2.76	V	-53.59	73.29
	5,197.50	-56.44	12.86	-57.34	3.47	V	-47.95	67.65
	6,930.00	-55.80	11.87	-51.10	4.06	H	-43.29	62.99
20385 (1753.5)	3,507.00	-55.88	12.36	-62.12	2.82	H	-52.58	72.28
	5,260.50	-56.72	12.95	-58.45	3.49	V	-48.99	68.69
	7,014.00	-54.57	11.73	-51.55	3.98	H	-43.80	63.50

- NOTES:**
1. Radiated Spurious Emission Measurements at 3 meters by Substitution Method according to ANSI/TIA/EIA-603-D-2010 June 24, 2010:
 2. We are performed all frequency to 10th harmonics from 9 kHz. Measurements above show only up to 3 maximum emissions noted, or would be lesser if no specific emissions from the EUT are recorded (ie: margin > 20 dB from the applicable limit) and considered that's already beyond the background noise floor.
 3. We have done x, y, z planes in EUT and horizontal and vertical polarization in detecting antenna.
 4. All of RB size has been tested for emissions and EIRP, with the 1RB configuration observed as the worst case
 5. We are performed 16QAM and QPSK modulations. The worst case data are reported in the table above.

8.2.3 RADIATED SPURIOUS EMISSIONS (5 MHz Band 4 LTE)

- ▣ OPERATING FREQUENCY: 1732.50 MHz
- ▣ MEASURED OUTPUT POWER: 19.46 dBm = 0.088 W
- ▣ MODULATION SIGNAL: 5 MHz QPSK
- ▣ DISTANCE: 3 meters
- ▣ LIMIT: $43 + 10 \log_{10}(W) =$ 32.46 dBc

Ch	Freq (MHz)	Measured Level (dBm)	Ant. Gain (dBi)	Substitute Level (dBm)	C.L	Pol	EIRP (dBm)	dBc
19975 (1712.5)	3,425.00	-57.32	12.20	-64.37	2.78	V	-54.95	74.41
	5,137.50	-56.26	12.77	-56.99	3.44	V	-47.66	67.12
	6,850.00	-56.30	12.04	-52.19	4.00	H	-44.15	63.61
20175 (1732.5)	3,465.00	-55.63	12.28	-62.27	2.76	V	-52.75	72.21
	5,197.50	-56.72	12.86	-57.62	3.47	V	-48.23	67.69
	6,930.00	-56.34	11.87	-51.64	4.06	H	-43.83	63.29
20375 (1752.5)	3,505.00	-55.95	12.36	-62.23	2.82	V	-52.69	72.15
	5,257.50	-56.19	12.94	-57.91	3.48	V	-48.45	67.91
	7,010.00	-54.16	11.73	-51.43	3.98	H	-43.68	63.14

- NOTES:**
1. Radiated Spurious Emission Measurements at 3 meters by Substitution Method according to ANSI/TIA/EIA-603-D-2010 June 24, 2010:
 2. We are performed all frequency to 10th harmonics from 9 kHz. Measurements above show only up to 3 maximum emissions noted, or would be lesser if no specific emissions from the EUT are recorded (ie: margin > 20 dB from the applicable limit) and considered that's already beyond the background noise floor.
 3. We have done x, y, z planes in EUT and horizontal and vertical polarization in detecting antenna.
 4. All of RB size has been tested for emissions and EIRP, with the 1RB configuration observed as the worst case
 5. We are performed 16QAM and QPSK modulations. The worst case data are reported in the table above.

8.2.4 RADIATED SPURIOUS EMISSIONS (10 MHz Band 4 LTE)

- ▣ OPERATING FREQUENCY: 1715.00 MHz
- ▣ MEASURED OUTPUT POWER: 19.67 dBm = 0.093 W
- ▣ MODULATION SIGNAL: 10 MHz QPSK
- ▣ DISTANCE: 3 meters
- ▣ LIMIT: $43 + 10 \log_{10}(W) =$ 32.67 dBc

Ch	Freq (MHz)	Measured Level (dBm)	Ant. Gain (dBi)	Substitute Level (dBm)	C.L	Pol	EIRP (dBm)	dBc
20000 (1715.0)	3,430.00	-56.86	12.21	-64.01	2.78	H	-54.58	74.25
	5,145.00	-56.80	12.77	-57.36	3.44	V	-48.03	67.70
	6,860.00	-54.88	12.01	-50.64	4.02	V	-42.65	62.32
20175 (1732.5)	3,465.00	-57.27	12.28	-63.91	2.76	V	-54.39	74.06
	5,197.50	-57.18	12.86	-58.08	3.47	V	-48.69	68.36
	6,930.00	-56.69	11.87	-51.99	4.06	V	-44.18	63.85
20350 (1750.0)	3,500.00	-55.62	12.35	-61.99	2.82	V	-52.46	72.13
	5,250.00	-57.06	12.93	-58.73	3.48	H	-49.28	68.95
	7,000.00	-55.68	11.73	-53.15	4.07	V	-45.49	65.16

- NOTES:**
1. Radiated Spurious Emission Measurements at 3 meters by Substitution Method according to ANSI/TIA/EIA-603-D-2010 June 24, 2010:
 2. We are performed all frequency to 10th harmonics from 9 kHz. Measurements above show only up to 3 maximum emissions noted, or would be lesser if no specific emissions from the EUT are recorded (ie: margin > 20 dB from the applicable limit) and considered that's already beyond the background noise floor.
 3. We have done x, y, z planes in EUT and horizontal and vertical polarization in detecting antenna.
 4. All of RB size has been tested for emissions and EIRP, with the 1RB configuration observed as the worst case
 5. We are performed 16QAM and QPSK modulations. The worst case data are reported in the table above.

8.2.5 RADIATED SPURIOUS EMISSIONS (15 MHz Band 4 LTE)

- ▣ OPERATING FREQUENCY: 1717.50 MHz
- ▣ MEASURED OUTPUT POWER: 19.58 dBm = 0.091 W
- ▣ MODULATION SIGNAL: 15 MHz QPSK
- ▣ DISTANCE: 3 meters
- ▣ LIMIT: $43 + 10 \log_{10}(W) =$ 32.58 dBc

Ch	Freq (MHz)	Measured Level (dBm)	Ant. Gain (dBi)	Substitute Level (dBm)	C.L	Pol	EIRP (dBm)	dBc
20025 (1717.5)	3,435.00	-56.33	12.21	-63.35	2.78	H	-53.92	73.50
	5,152.50	-56.30	12.79	-56.81	3.45	V	-47.47	67.05
	6,870.00	-56.36	11.99	-52.39	4.03	H	-44.43	64.01
20175 (1732.5)	3,465.00	-56.42	12.28	-63.06	2.76	V	-53.54	73.12
	5,197.50	-57.39	12.86	-58.29	3.47	V	-48.90	68.48
	6,930.00	-56.50	11.87	-51.80	4.06	V	-43.99	63.57
20325 (1747.5)	3,495.00	-56.01	12.34	-62.37	2.81	V	-52.84	72.42
	5,242.50	-56.18	12.92	-57.66	3.48	H	-48.22	67.80
	6,990.00	-54.53	11.75	-49.29	4.05	H	-41.59	61.17

- NOTES:**
1. Radiated Spurious Emission Measurements at 3 meters by Substitution Method according to ANSI/TIA/EIA-603-D-2010 June 24, 2010:
 2. We are performed all frequency to 10th harmonics from 9 kHz. Measurements above show only up to 3 maximum emissions noted, or would be lesser if no specific emissions from the EUT are recorded (ie: margin > 20 dB from the applicable limit) and considered that's already beyond the background noise floor.
 3. We have done x, y, z planes in EUT and horizontal and vertical polarization in detecting antenna.
 4. All of RB size has been tested for emissions and EIRP, with the 1RB configuration observed as the worst case
 5. We are performed 16QAM and QPSK modulations. The worst case data are reported in the table above.

8.2.6 RADIATED SPURIOUS EMISSIONS (20 MHz Band 4 LTE)

- ▣ OPERATING FREQUENCY: 1720.00 MHz
- ▣ MEASURED OUTPUT POWER: 19.34 dBm = 0.086 W
- ▣ MODULATION SIGNAL: 20 MHz QPSK
- ▣ DISTANCE: 3 meters
- ▣ LIMIT: $43 + 10 \log_{10}(W) =$ 32.34 dBc

Ch	Freq (MHz)	Measured Level (dBm)	Ant. Gain (dBi)	Substitute Level (dBm)	C.L	Pol	EIRP (dBm)	dBc
20050 (1720.0)	3,440.00	-56.23	12.23	-63.15	2.77	H	-53.69	73.03
	5,160.00	-55.70	12.80	-56.53	3.46	H	-47.19	66.53
	6,880.00	-57.00	11.97	-52.99	4.04	H	-45.06	64.40
20175 (1732.5)	3,465.00	-56.86	12.28	-63.50	2.76	V	-53.98	73.32
	5,197.50	-57.08	12.86	-57.98	3.47	V	-48.59	67.93
	6,930.00	-56.35	11.87	-51.65	4.06	V	-43.84	63.18
20300 (1745.0)	3,490.00	-56.57	12.33	-62.91	2.81	V	-53.39	72.73
	5,235.00	-57.11	12.91	-58.52	3.47	V	-49.08	68.42
	6,980.00	-54.81	11.77	-49.54	4.04	H	-41.81	61.15

- NOTES:**
1. Radiated Spurious Emission Measurements at 3 meters by Substitution Method according to ANSI/TIA/EIA-603-D-2010 June 24, 2010:
 2. We are performed all frequency to 10th harmonics from 9 kHz. Measurements above show only up to 3 maximum emissions noted, or would be lesser if no specific emissions from the EUT are recorded (ie: margin > 20 dB from the applicable limit) and considered that's already beyond the background noise floor.
 3. We have done x, y, z planes in EUT and horizontal and vertical polarization in detecting antenna.
 4. All of RB size has been tested for emissions and EIRP, with the 1RB configuration observed as the worst case
 5. We are performed 16QAM and QPSK modulations. The worst case data are reported in the table above.

8.3 PEAK-TO-AVERAGE RATIO

Band	Band Width	Frequency (MHz)	Modulation	Resource Block Size	Resource Block Offset	Data (dB)
4	1.4 MHz	1732.5	QPSK	6	0	4.70
			16-QAM	6		5.35
	3 MHz		QPSK	15		4.93
			16-QAM	15		5.55
	5 MHz		QPSK	25		4.84
			16-QAM	25		5.44
	10 MHz		QPSK	50		4.93
			16-QAM	50		5.72
	15 MHz		QPSK	75		4.83
			16-QAM	75		5.65
	20 MHz		QPSK	100		4.87
			16-QAM	100		5.70

- Plots of the EUT's Peak- to- Average Ratio are shown Page 43 ~ 48.

8.4 OCCUPIED BANDWIDTH

Band	Band Width	Frequency (MHz)	Modulation	Resource Block Size	Resource Block Offset	Data (MHz)
4	1.4 MHz	1732.5	QPSK	6	0	1.0957
			16-QAM	6	0	1.0968
	3 MHz		QPSK	15	0	2.6979
			16-QAM	15	0	2.6964
	5 MHz		QPSK	25	0	4.4936
			16-QAM	25	0	4.4996
	10 MHz		QPSK	50	0	8.9789
			16-QAM	50	0	8.9545
	15 MHz		QPSK	75	0	13.432
			16-QAM	75	0	13.422
	20 MHz		QPSK	100	0	17.907
			16-QAM	100	0	17.950

- Plots of the EUT's Occupied Bandwidth are shown Page 37 ~ 42.

8.5 CONDUCTED SPURIOUS EMISSIONS

■FACTORS FOR FREQUENCY

Frequency Range (GHz)	Factor [dB]
0.03 – 1	25.27
1 – 5	27.98
5 – 10	28.59
10 – 15	29.12
15 – 20	29.49
Above 20	30.13

NOTES:

Factor(dB) = Cable Loss + Attenuator +Power Splitter

Band	Band Width (MHz)	Frequency (MHz)	Frequency of Maximum Harmonic (GHz)	Factor (dB)	Measurement Maximum Data (dBm)	Result (dBm)	Limit (dBm)
4	1.4	1710.7	18.9110	30.13	-62.03	-31.90	-13.00
		1732.5	16.6370	30.13	-62.51	-32.38	
		1754.3	18.9295	30.13	-62.48	-32.35	
	3	1711.5	18.8860	30.13	-62.24	-32.11	
		1732.5	18.9370	30.13	-62.48	-32.35	
		1753.5	18.9240	30.13	-62.24	-32.11	
	5	1712.5	18.8990	30.13	-62.49	-32.36	
		1732.5	18.9430	30.13	-62.57	-32.44	
		1752.5	18.9705	30.13	-62.53	-32.40	
	10	1715.0	18.9225	30.13	-62.47	-32.34	
		1732.5	18.9135	30.13	-62.34	-32.21	
		1750.0	18.9170	30.13	-62.27	-32.14	
	15	1717.5	18.9020	30.13	-62.46	-32.33	
		1732.5	18.9210	30.13	-62.61	-32.48	
		1747.5	18.9210	30.13	-62.26	-32.13	
	20	1720.0	16.6275	30.13	-62.44	-32.31	
		1732.5	18.8640	30.13	-62.23	-32.10	
		1745.0	18.9155	30.13	-61.88	-31.75	

NOTES:

1. Conducted Spurious Emissions was Tested QPSK Modulation, Resource Block Size 1 and Resource Block Offset 0
2. Result (dBm) = Measurement Maximum Data (dBm) + Factor (dB)

- Plots of the EUT's Conducted Spurious Emissions are shown Page 67 ~ 84.

8.5.1 BAND EDGE

- Plots of the EUT's Band Edge are shown Page 49 ~ 66.

8.6 FREQUENCY STABILITY / VARIATION OF AMBIENT TEMPERATURE

8.6.1 FREQUENCY STABILITY (1.4 MHz Band 4 LTE)

- ▣ OPERATING FREQUENCY: 1732,500,000 Hz
- ▣ CHANNEL: 20175 (1.4 MHz)
- ▣ REFERENCE VOLTAGE: 3.85 VDC
- ▣ DEVIATION LIMIT: Emission must remain in band

Voltage (%)	Power (VDC)	Temp. (°C)	Frequency (Hz)	Frequency Error (Hz)	Deviation (%)	ppm
100%	3.85	+20(Ref)	1732 500 005	0.0	0.000 000	0.000
100%		-30	1732 500 013	7.8	0.000 000	0.005
100%		-20	1732 499 999	-6.7	0.000 000	-0.004
100%		-10	1732 500 001	-4.2	0.000 000	-0.002
100%		0	1732 500 011	5.9	0.000 000	0.003
100%		+10	1732 500 010	4.4	0.000 000	0.003
100%		+30	1732 500 000	-5.5	0.000 000	-0.003
100%		+40	1732 500 011	6.0	0.000 000	0.003
100%		+50	1732 500 009	4.0	0.000 000	0.002
Batt. Endpoint		3.40	+20	1732 500 011	5.6	0.000 000

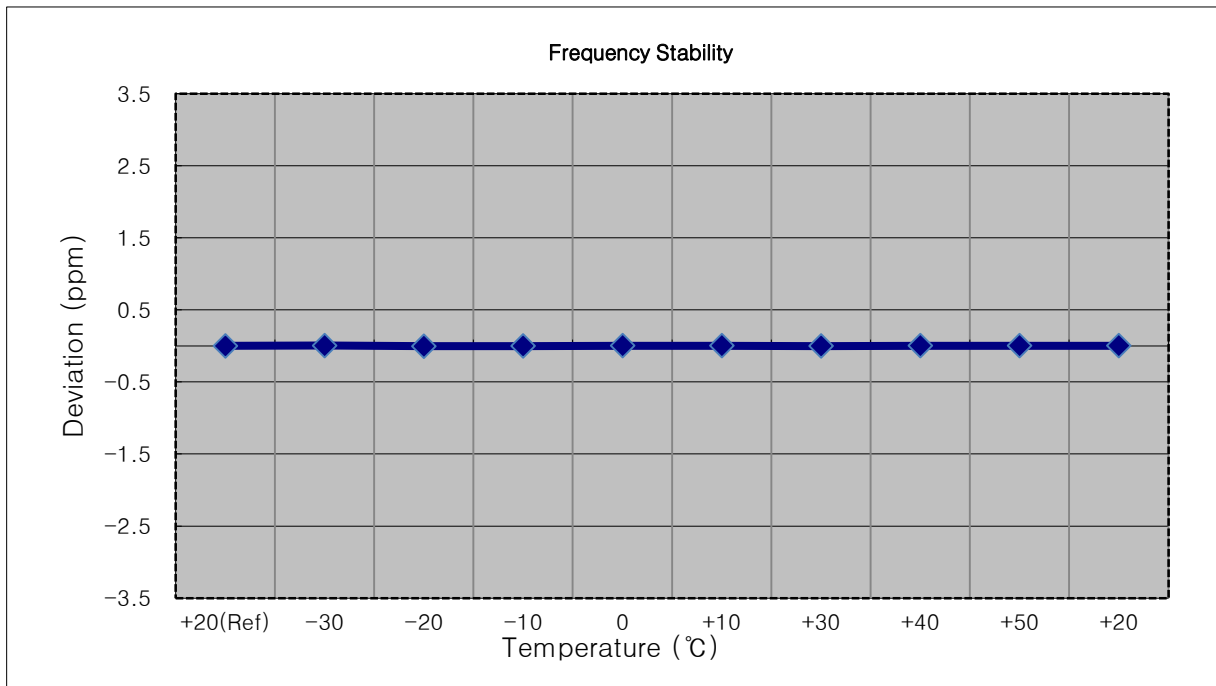

8.6.2 FREQUENCY STABILITY (3 MHz Band 4 LTE)

- ▣ OPERATING FREQUENCY: 1732,500,000 Hz
- ▣ CHANNEL: 20175 (3 MHz)
- ▣ REFERENCE VOLTAGE: 3.85 VDC
- ▣ DEVIATION LIMIT: Emission must remain in band

Voltage (%)	Power (VDC)	Temp. (°C)	Frequency (Hz)	Frequency Error (Hz)	Deviation (%)	ppm
100%	3.85	+20(Ref)	1732 500 005	0.0	0.000 000	0.000
100%		-30	1732 500 012	7.2	0.000 000	0.004
100%		-20	1732 500 011	6.2	0.000 000	0.004
100%		-10	1732 500 013	7.5	0.000 000	0.004
100%		0	1732 500 011	5.5	0.000 000	0.003
100%		+10	1732 500 011	6.2	0.000 000	0.004
100%		+30	1732 500 002	-3.6	0.000 000	-0.002
100%		+40	1732 500 011	6.0	0.000 000	0.003
100%		+50	1732 500 009	4.3	0.000 000	0.002
Batt. Endpoint		3.40	+20	1732 500 011	5.8	0.000 000

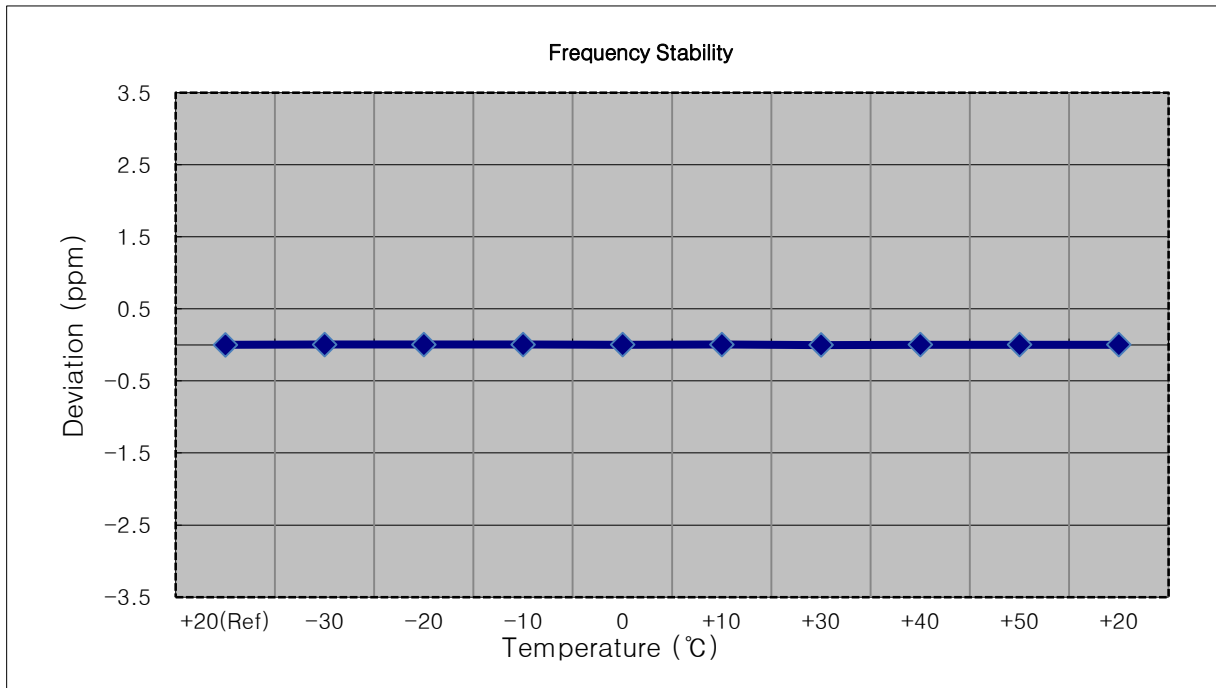

8.6.3 FREQUENCY STABILITY (5 MHz Band 4 LTE)

- ▣ OPERATING FREQUENCY: 1732,500,000 Hz
- ▣ CHANNEL: 20175 (5 MHz)
- ▣ REFERENCE VOLTAGE: 3.85 VDC
- ▣ DEVIATION LIMIT: Emission must remain in band

Voltage (%)	Power (VDC)	Temp. (°C)	Frequency (Hz)	Frequency Error (Hz)	Deviation (%)	ppm
100%	3.85	+20(Ref)	1732 500 005	0.0	0.000 000	0.000
100%		-30	1732 499 999	-6.4	0.000 000	-0.004
100%		-20	1732 500 011	5.8	0.000 000	0.003
100%		-10	1732 500 001	-4.7	0.000 000	-0.003
100%		0	1732 500 010	4.7	0.000 000	0.003
100%		+10	1732 500 001	-4.0	0.000 000	-0.002
100%		+30	1732 500 001	-4.9	0.000 000	-0.003
100%		+40	1732 500 011	5.8	0.000 000	0.003
100%		+50	1732 500 011	5.8	0.000 000	0.003
Batt. Endpoint	3.40	+20	1732 499 999	-6.6	0.000 000	-0.004

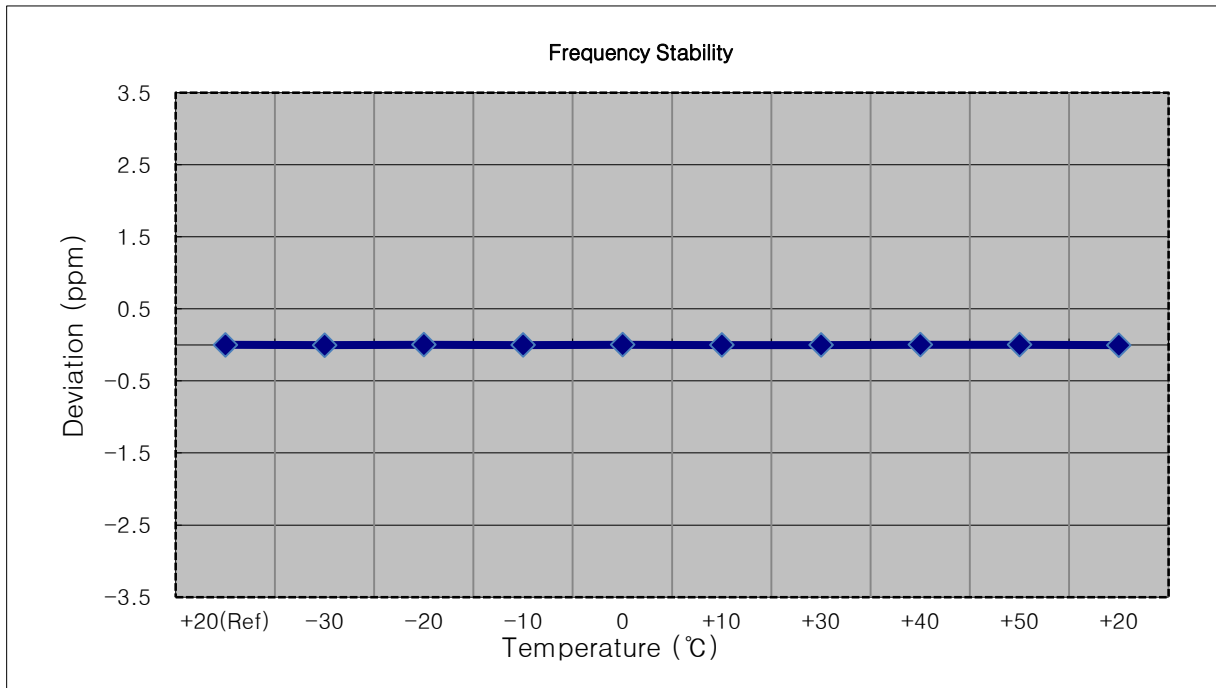

8.6.4 FREQUENCY STABILITY (10 MHz Band 4 LTE)

- ▣ OPERATING FREQUENCY: 1732,500,000 Hz
- ▣ CHANNEL: 20175 (10 MHz)
- ▣ REFERENCE VOLTAGE: 3.85 VDC
- ▣ DEVIATION LIMIT: Emission must remain in band

Voltage (%)	Power (VDC)	Temp. (°C)	Frequency (Hz)	Frequency Error (Hz)	Deviation (%)	ppm
100%	3.85	+20(Ref)	1732 499 997	0.0	0.000 000	0.000
100%		-30	1732 500 000	3.1	0.000 000	0.002
100%		-20	1732 500 003	6.0	0.000 000	0.003
100%		-10	1732 500 002	4.7	0.000 000	0.003
100%		0	1732 500 002	4.3	0.000 000	0.002
100%		+10	1732 500 004	7.1	0.000 000	0.004
100%		+30	1732 499 993	-4.2	0.000 000	-0.002
100%		+40	1732 500 002	4.5	0.000 000	0.003
100%		+50	1732 499 992	-5.5	0.000 000	-0.003
Batt. Endpoint	3.40	+20	1732 499 993	-3.9	0.000 000	-0.002

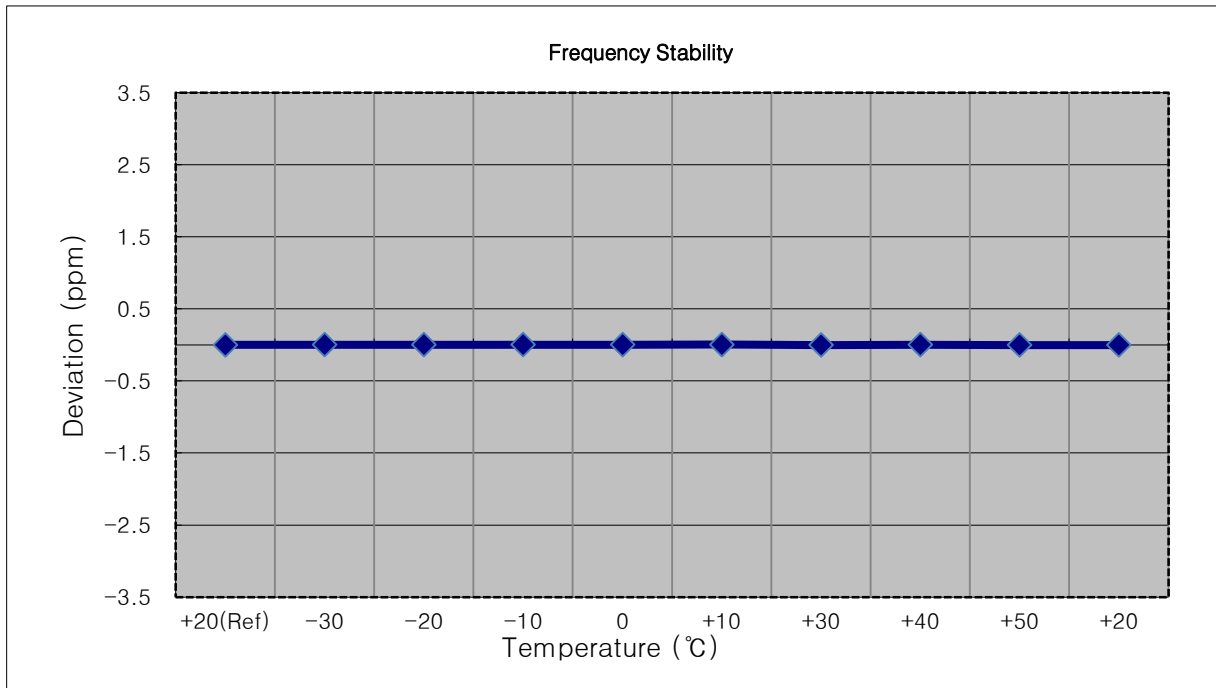

8.6.5 FREQUENCY STABILITY (15 MHz Band 4 LTE)

- ▣ OPERATING FREQUENCY: 1732,500,000 Hz
- ▣ CHANNEL: 20175 (15 MHz)
- ▣ REFERENCE VOLTAGE: 3.85 VDC
- ▣ DEVIATION LIMIT: Emission must remain in band

Voltage (%)	Power (VDC)	Temp. (°C)	Frequency (Hz)	Frequency Error (Hz)	Deviation (%)	ppm
100%	3.85	+20(Ref)	1732 499 995	0.0	0.000 000	0.000
100%		-30	1732 499 988	-6.7	0.000 000	-0.004
100%		-20	1732 499 992	-3.4	0.000 000	-0.002
100%		-10	1732 499 990	-5.0	0.000 000	-0.003
100%		0	1732 499 989	-6.3	0.000 000	-0.004
100%		+10	1732 499 989	-6.0	0.000 000	-0.003
100%		+30	1732 500 000	5.3	0.000 000	0.003
100%		+40	1732 500 003	7.6	0.000 000	0.004
100%		+50	1732 499 988	-7.3	0.000 000	-0.004
Batt. Endpoint	3.40	+20	1732 500 002	6.6	0.000 000	0.004

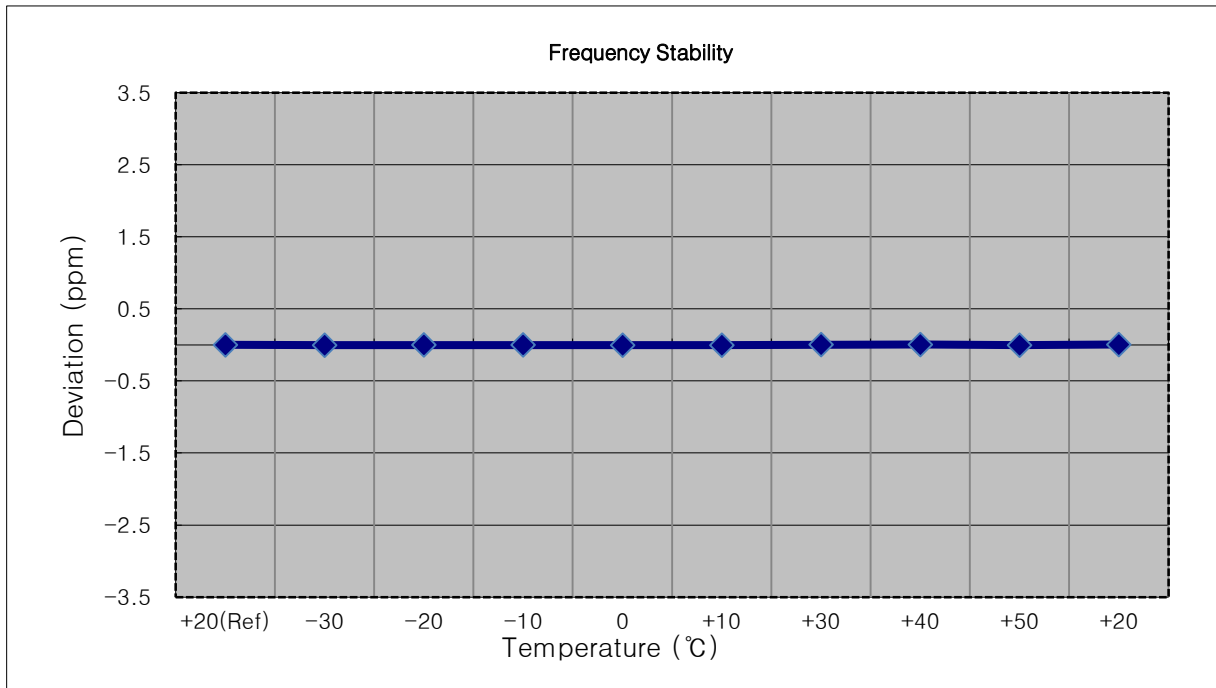

8.6.6 FREQUENCY STABILITY (20 MHz Band 4 LTE)

- ▣ OPERATING FREQUENCY: 1732,500,000 Hz
- ▣ CHANNEL: 20175 (20 MHz)
- ▣ REFERENCE VOLTAGE: 3.85 VDC
- ▣ DEVIATION LIMIT: Emission must remain in band

Voltage (%)	Power (VDC)	Temp. (°C)	Frequency (Hz)	Frequency Error (Hz)	Deviation (%)	ppm
100%	3.85	+20(Ref)	1732 500 004	0.0	0.000 000	0.000
100%		-30	1732 499 997	-6.7	0.000 000	-0.004
100%		-20	1732 499 999	-4.9	0.000 000	-0.003
100%		-10	1732 500 000	-3.8	0.000 000	-0.002
100%		0	1732 500 008	4.4	0.000 000	0.003
100%		+10	1732 500 000	-4.1	0.000 000	-0.002
100%		+30	1732 500 008	4.4	0.000 000	0.003
100%		+40	1732 500 010	5.9	0.000 000	0.003
100%		+50	1732 500 009	5.0	0.000 000	0.003
Batt. Endpoint	3.40	+20	1732 500 007	3.3	0.000 000	0.002

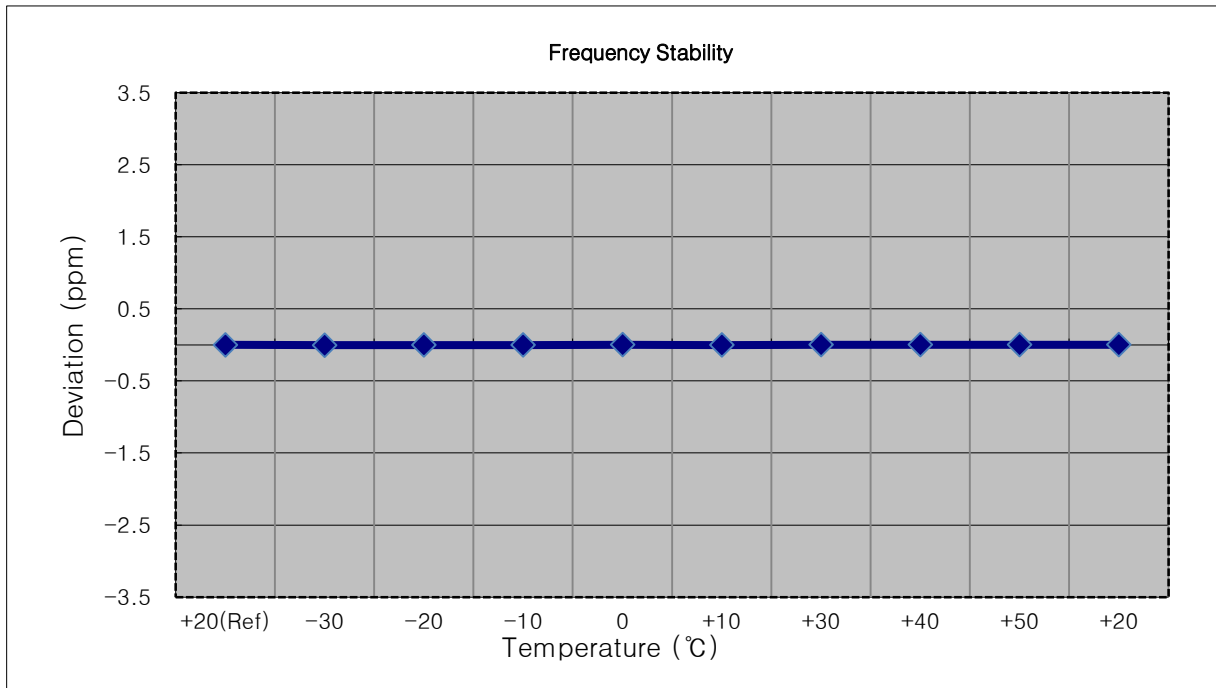

9. TEST PLOTS

BAND 4. Occupied Bandwidth Plot (1.4M BW Ch.20175 QPSK RB 6)

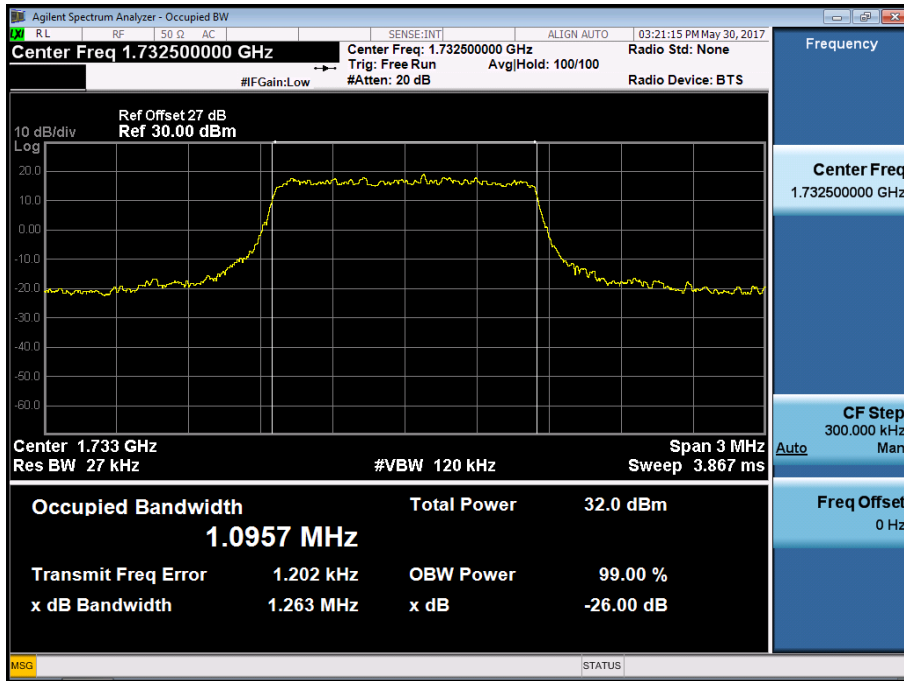

BAND 4. Occupied Bandwidth Plot (1.4M BW Ch.20175 16QAM RB 6)

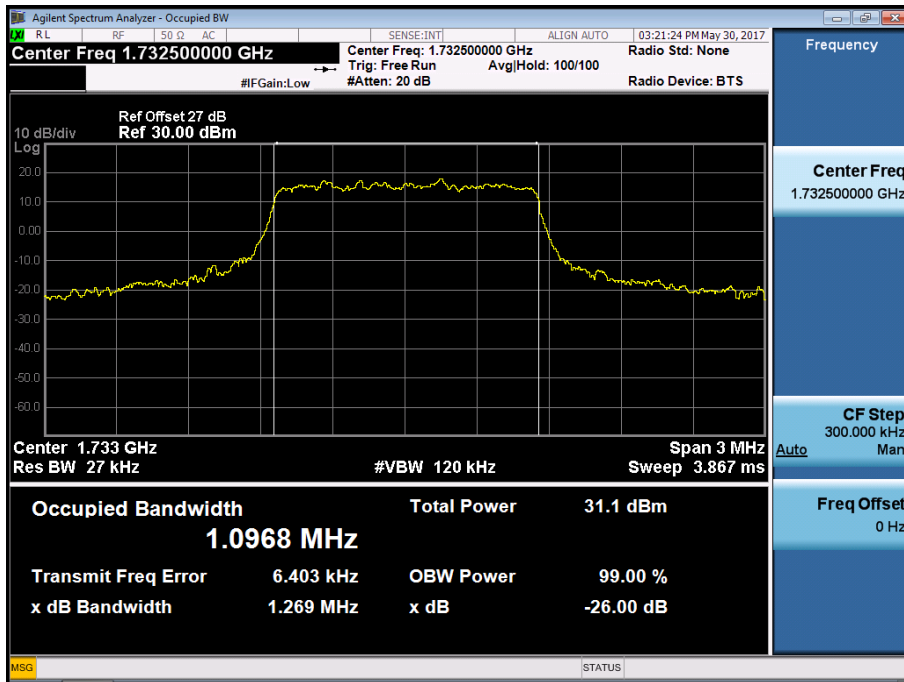

BAND 4. Occupied Bandwidth Plot (3M BW Ch.20175 QPSK RB 15)

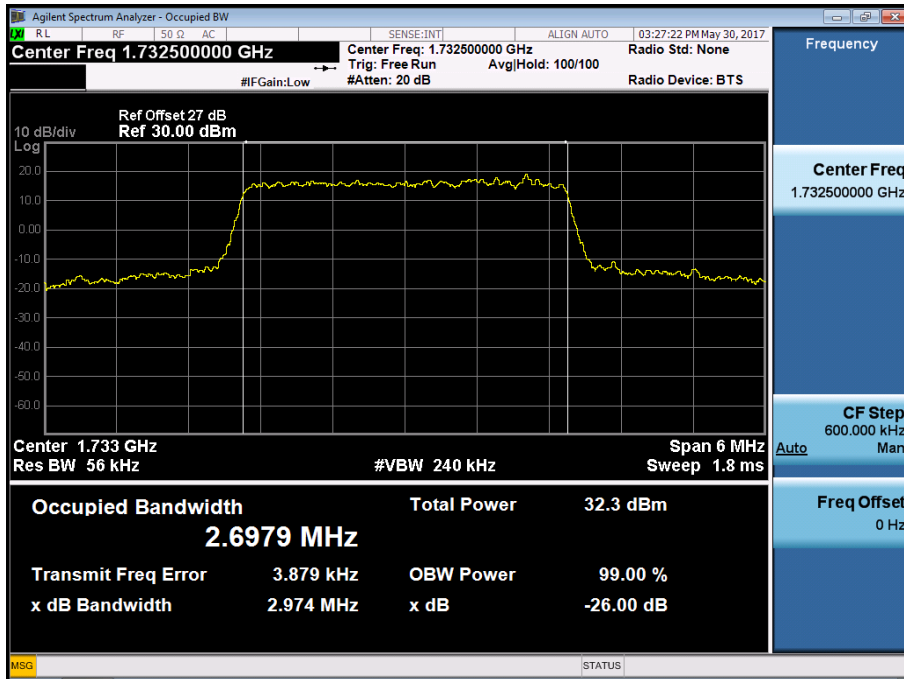

BAND 4. Occupied Bandwidth Plot (3M BW Ch.20175 16QAM RB 15)

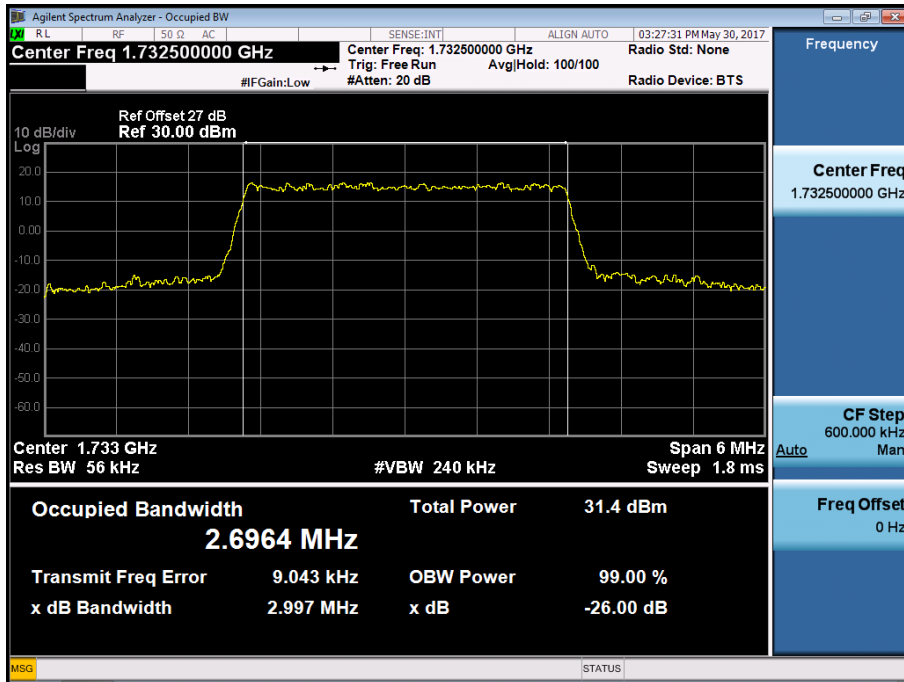

BAND 4. Occupied Bandwidth Plot (5M BW Ch.20175 QPSK RB 25)

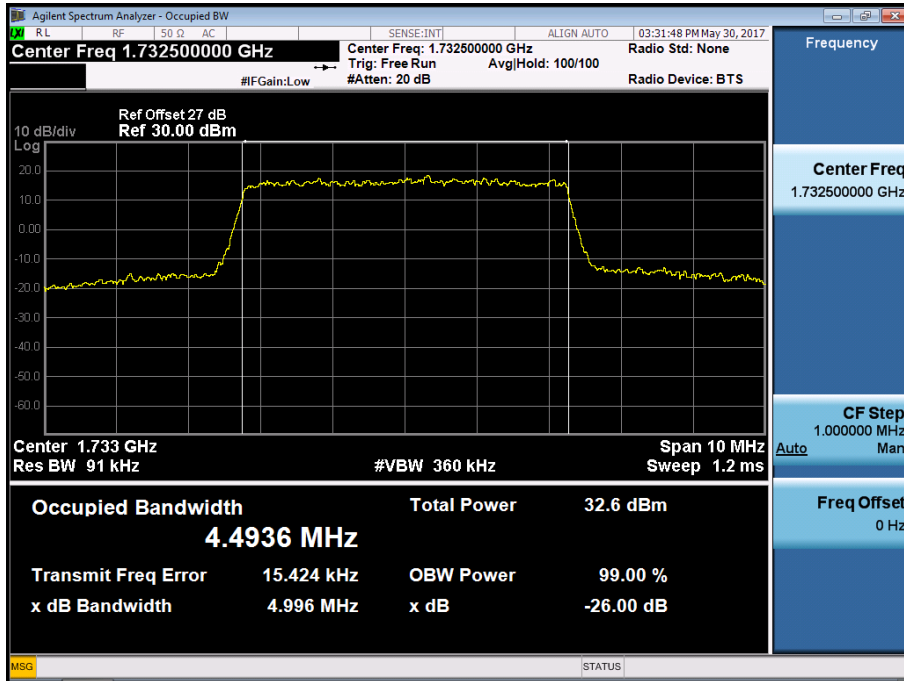

BAND 4. Occupied Bandwidth Plot (5M BW Ch.20175 16QAM RB 25)

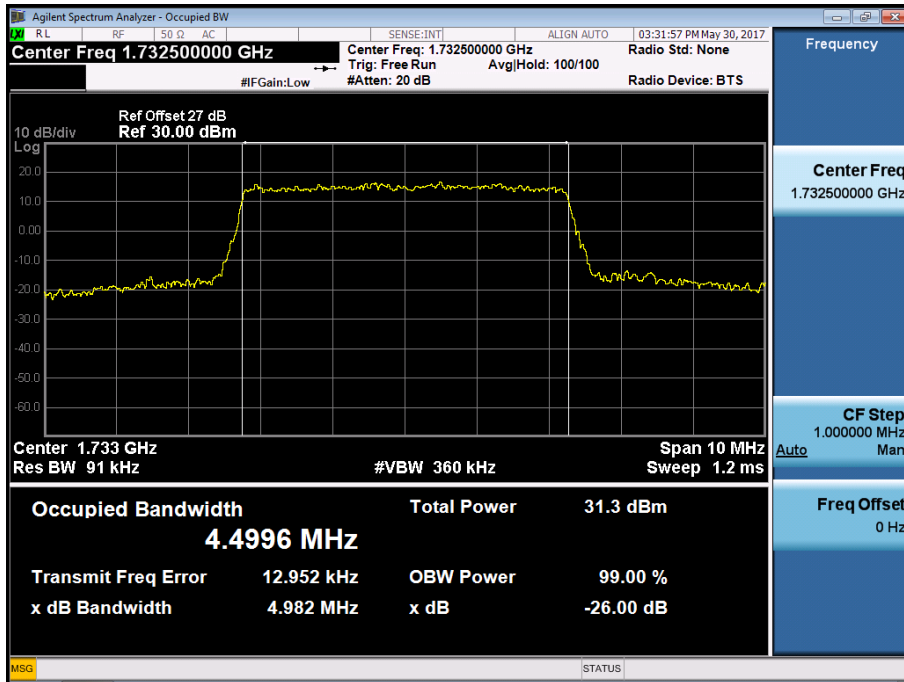

BAND 4. Occupied Bandwidth Plot (10M BW Ch.20175 QPSK RB 50)

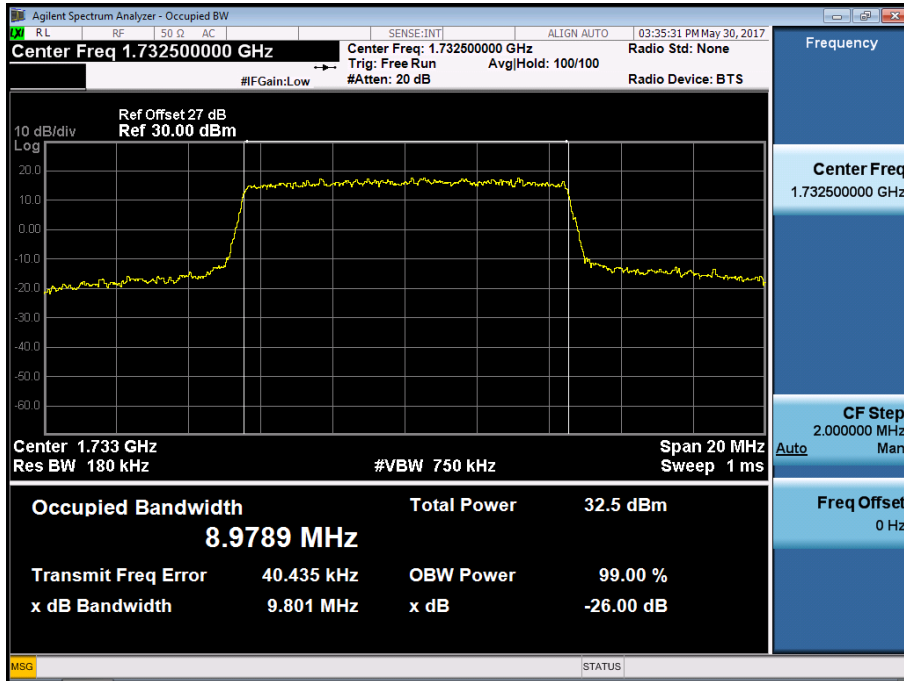

BAND 4. Occupied Bandwidth Plot (10M BW Ch.20175 16QAM RB 50)

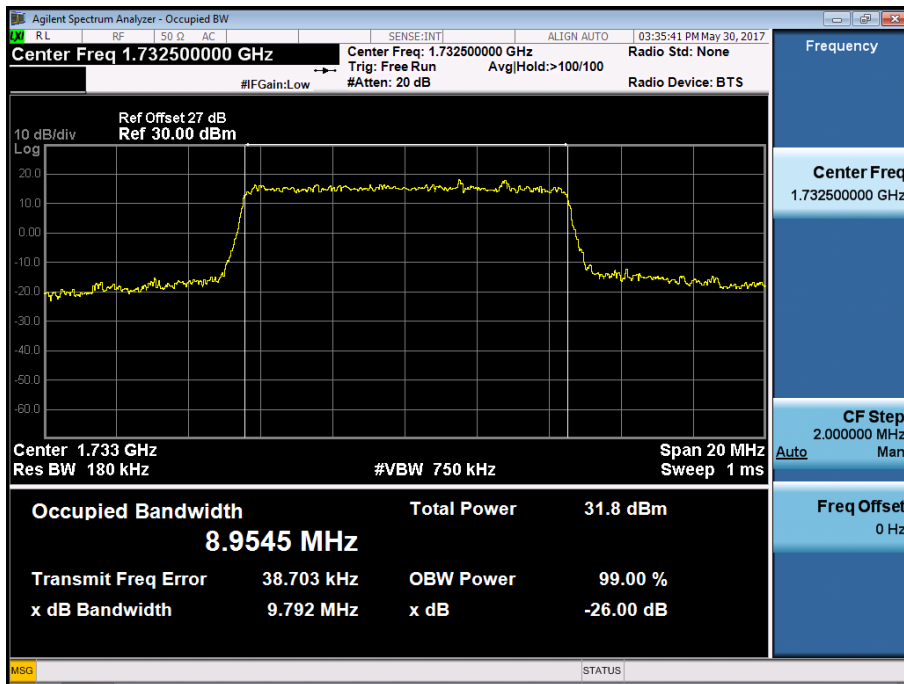

BAND 4. Occupied Bandwidth Plot (15M BW Ch.20175 QPSK RB 75)

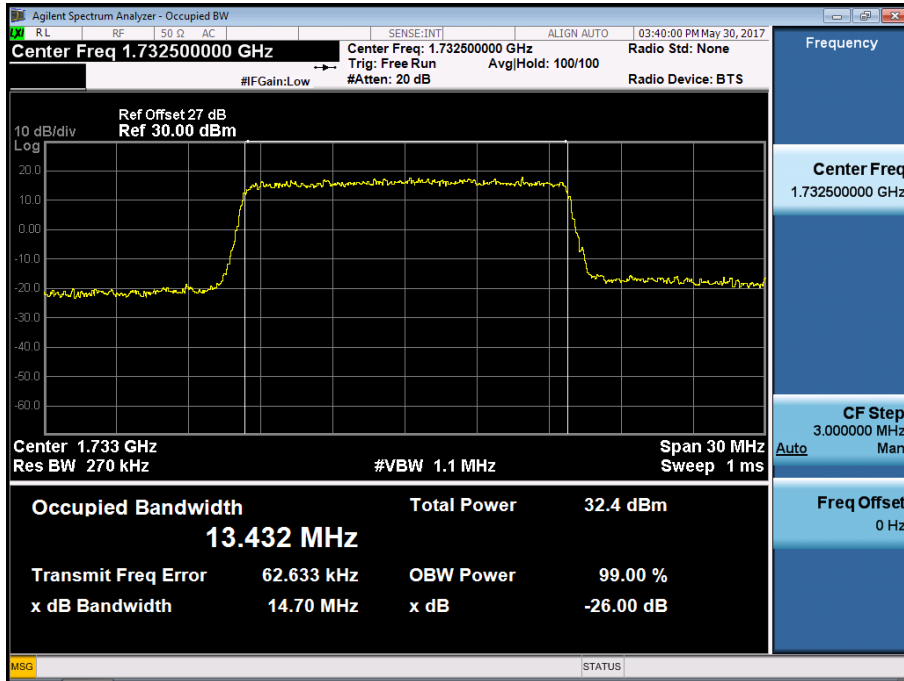

BAND 4. Occupied Bandwidth Plot (15M BW Ch.20175 16QAM RB 75)

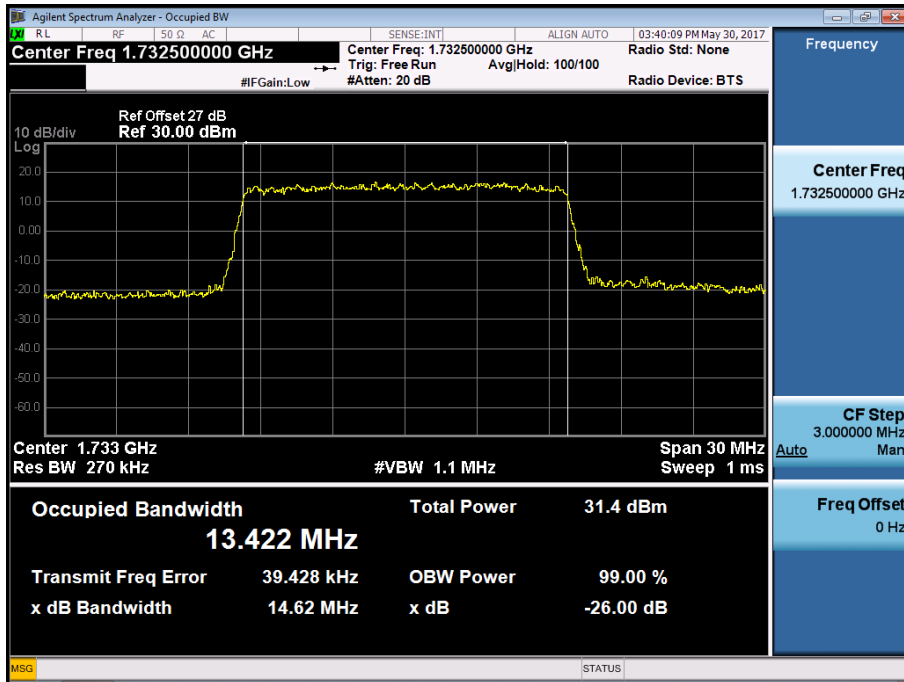

BAND 4. Occupied Bandwidth Plot (20M BW Ch.20175 QPSK RB 100)

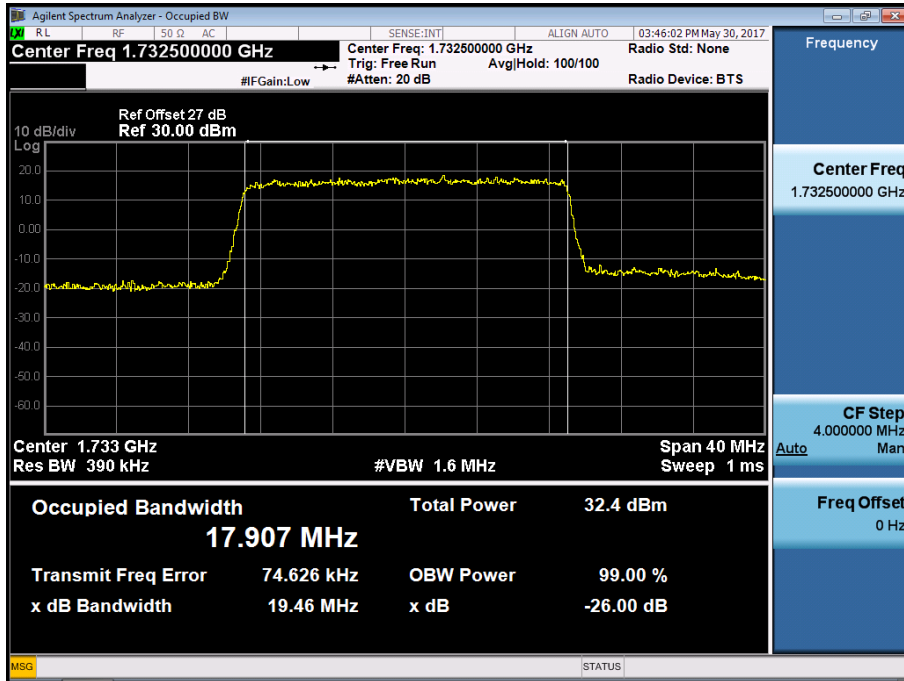

BAND 4. Occupied Bandwidth Plot (20M BW Ch.20175 16QAM RB 100)

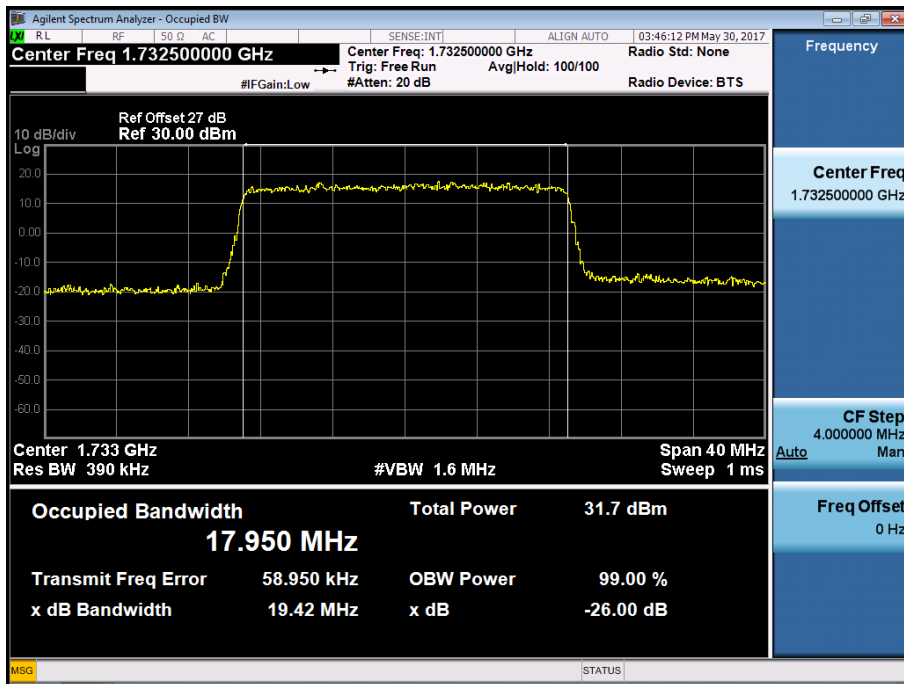

BAND 4. PAR Plot (1.4M BW_Ch.20175_QPSK_RB6_0)

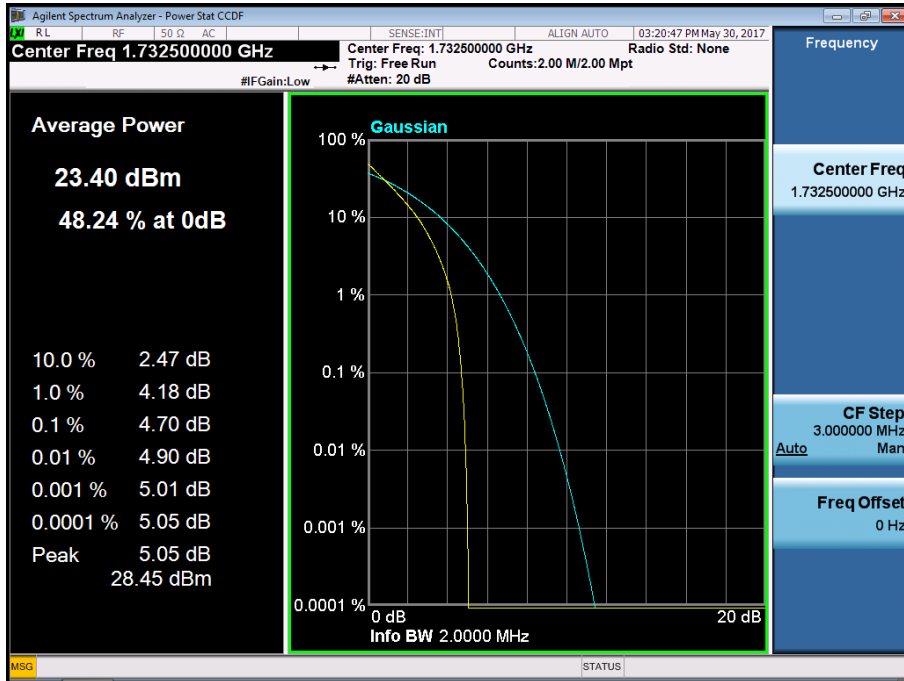

BAND 4. PAR Plot (1.4M BW_Ch.20175_16QAM_RB6_0)

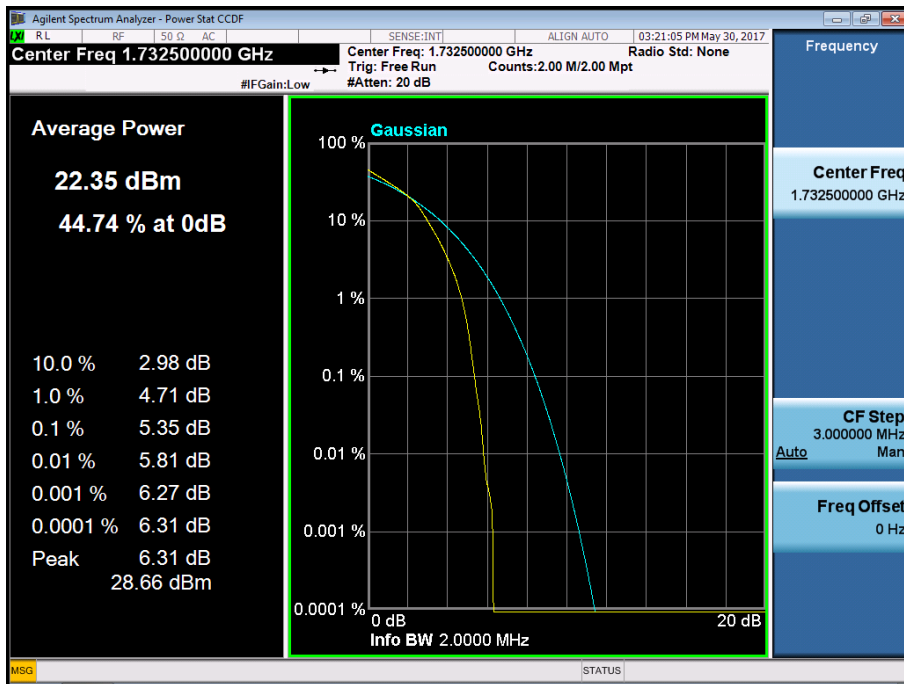

BAND 4. PAR Plot (3M BW_Ch.20175_QPSK_RB15_0)

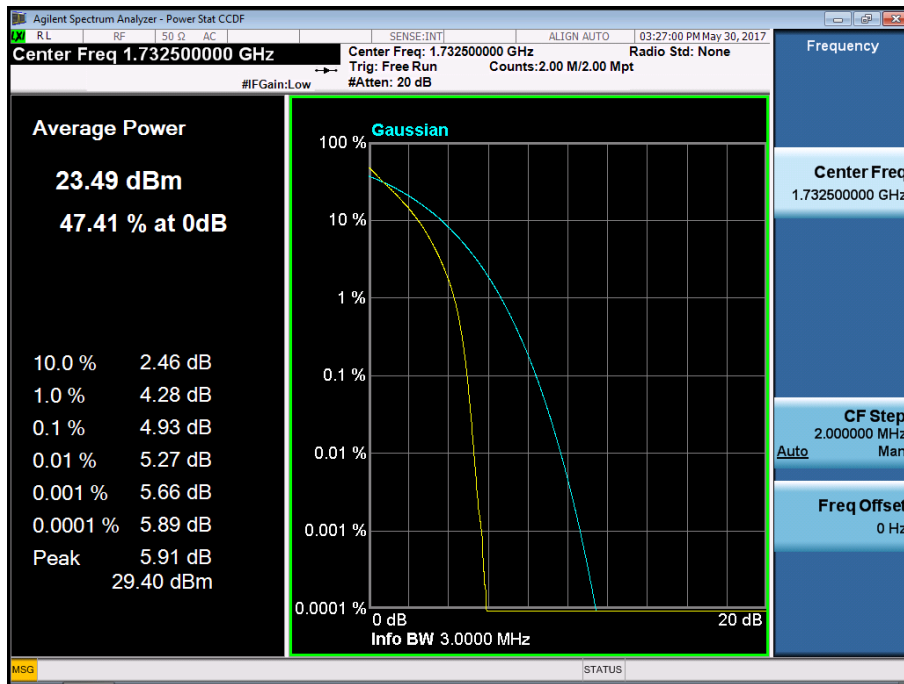

BAND 4. PAR Plot (3M BW_Ch.20175_16QAM_RB15_0)

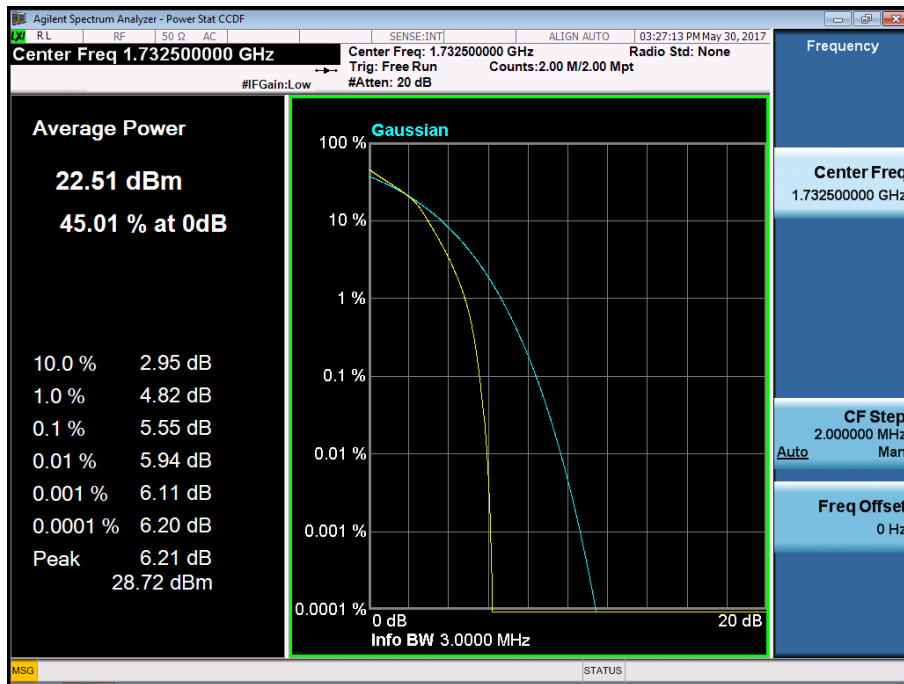

BAND 4. PAR Plot (5M BW_Ch.20175_QPSK_RB25_0)

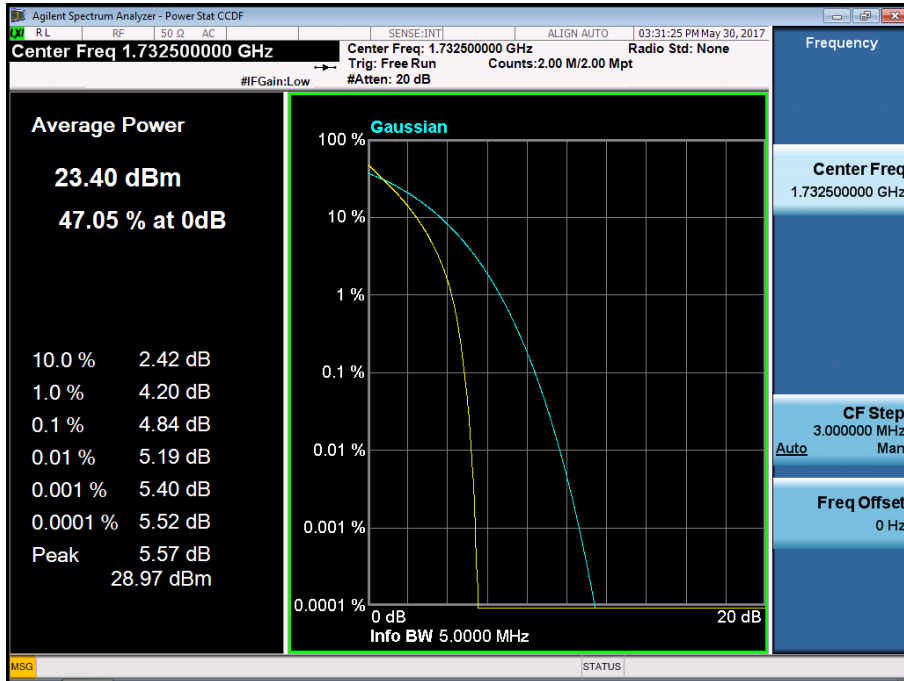

BAND 4. PAR Plot (5M BW_Ch.20175_16QAM_RB25_0)

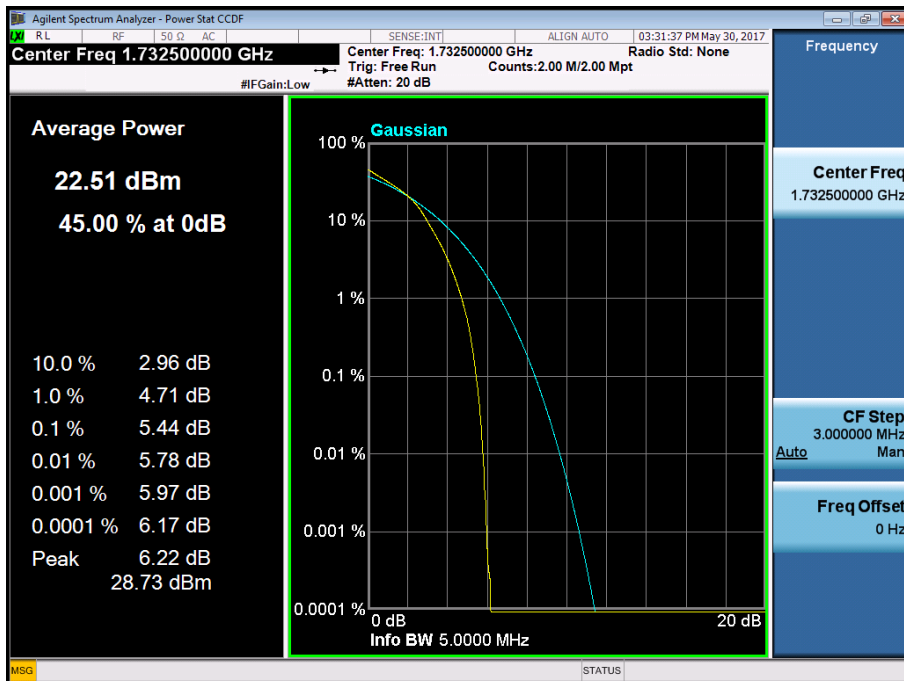

BAND 4. PAR Plot (10M BW_Ch.20175_QPSK_RB50_0)

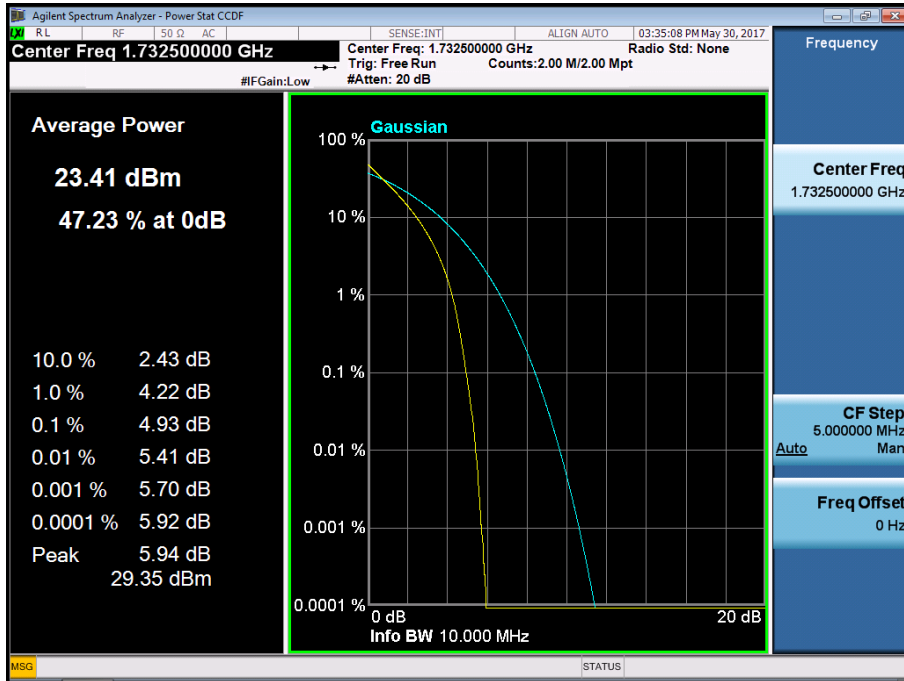

BAND 4. PAR Plot (10M BW_Ch.20175_16QAM_RB50_0)

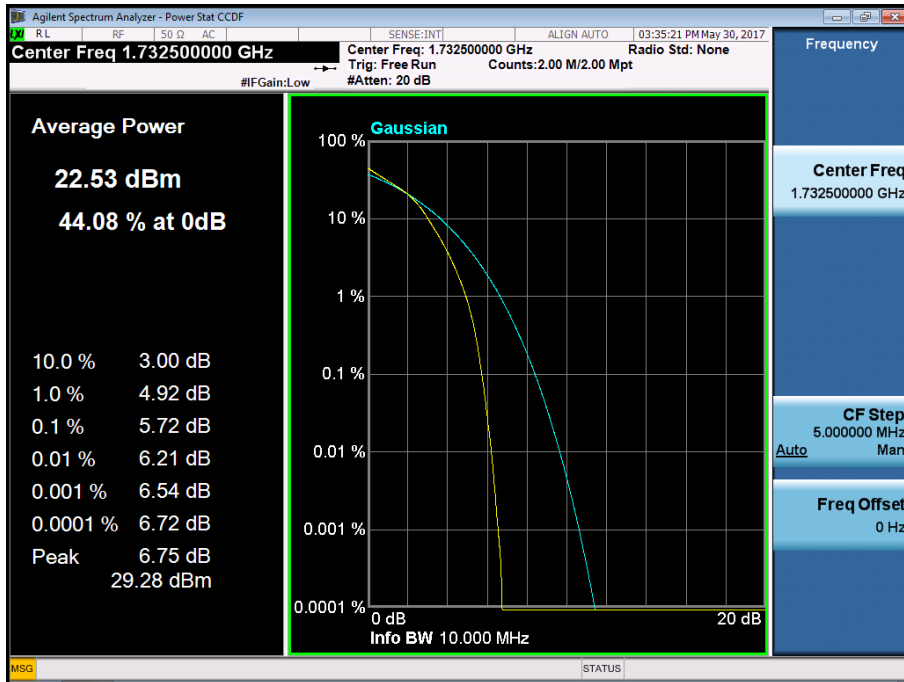

BAND 4. PAR Plot (15M BW_Ch.20175_QPSK_RB75_0)

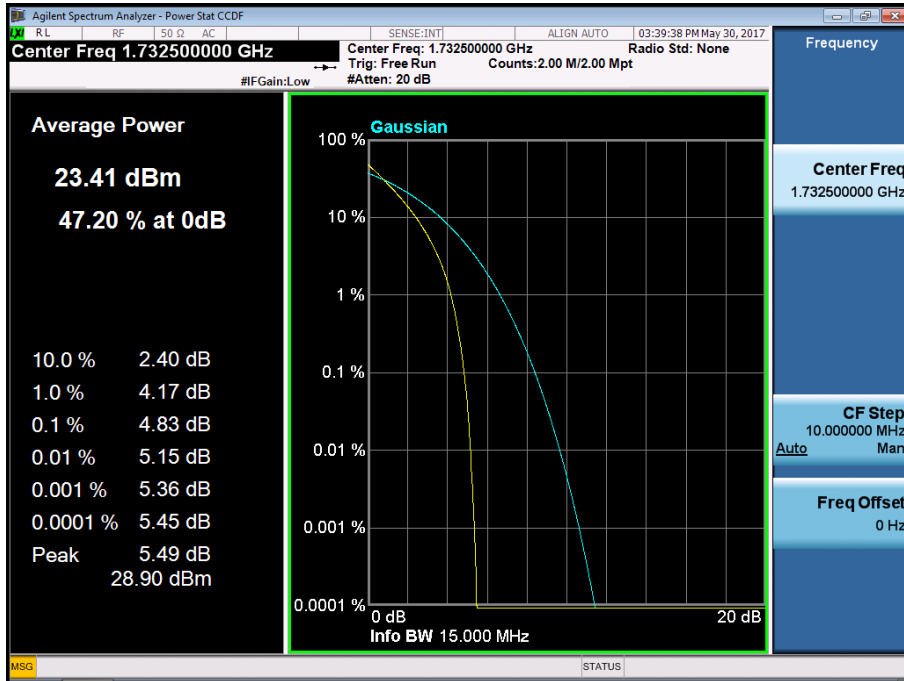

BAND 4. PAR Plot (15M BW_Ch.20175_16QAM_RB75_0)

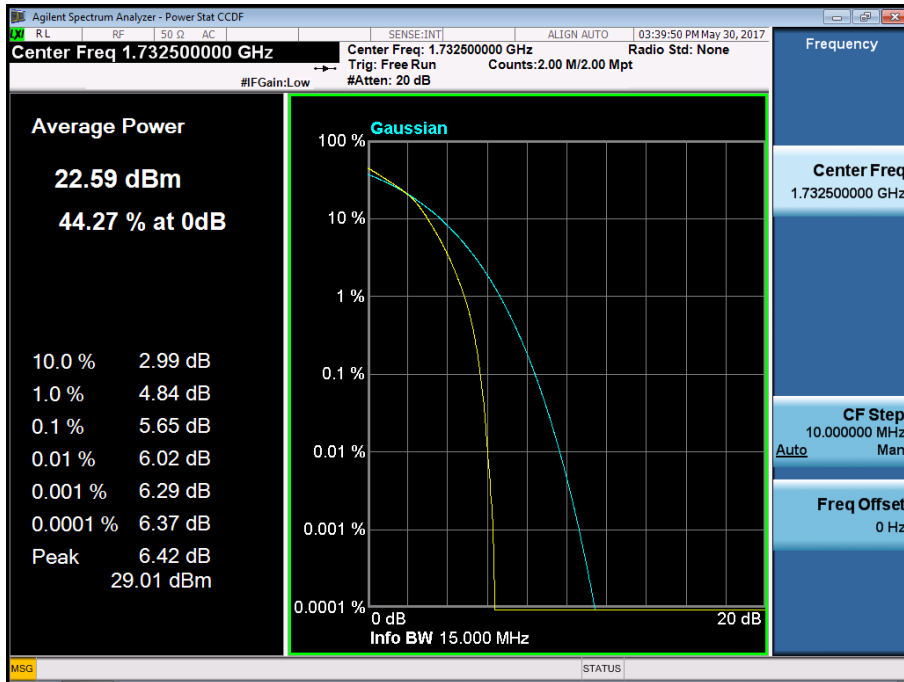

BAND 4. PAR Plot (20M BW_Ch.20175_QPSK_RB100_0)

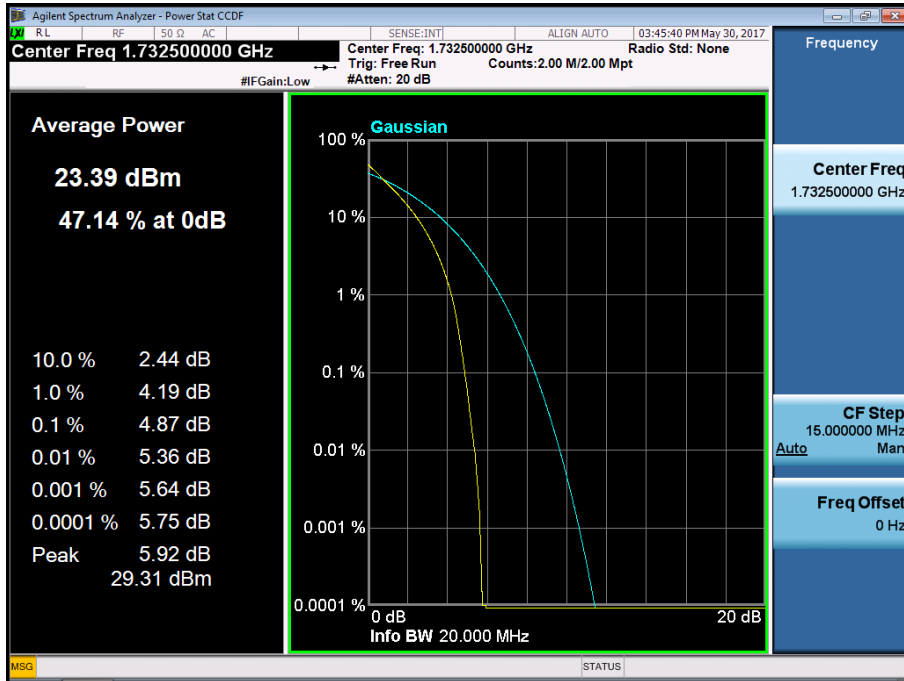

BAND 4. PAR Plot (20M BW_Ch.20175_16QAM_RB100_0)

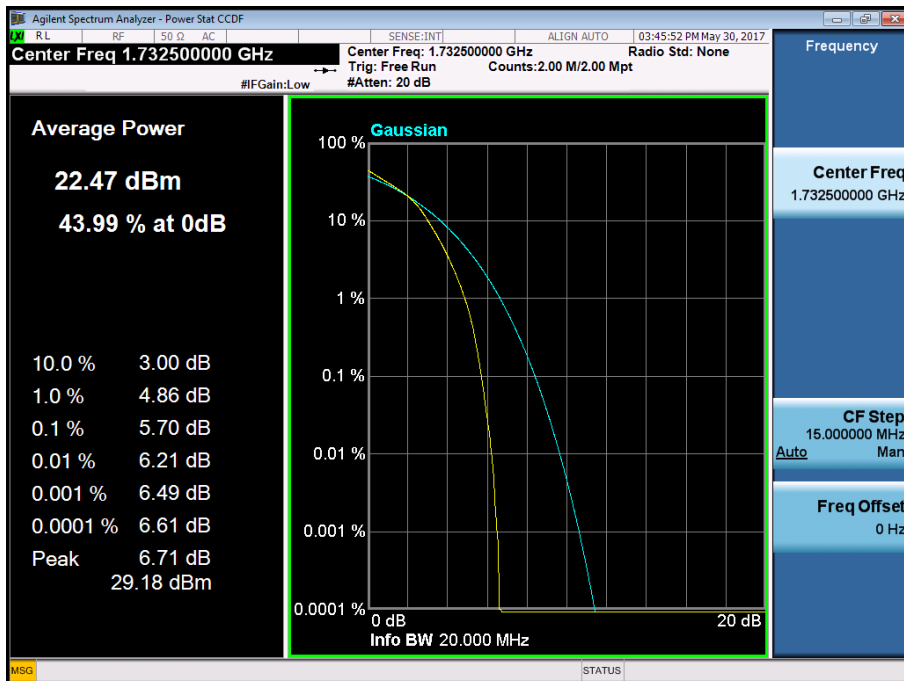

BAND 4. Lower Extended Band Edge Plot (1.4M BW Ch.19957 QPSK_RB6_0) -3

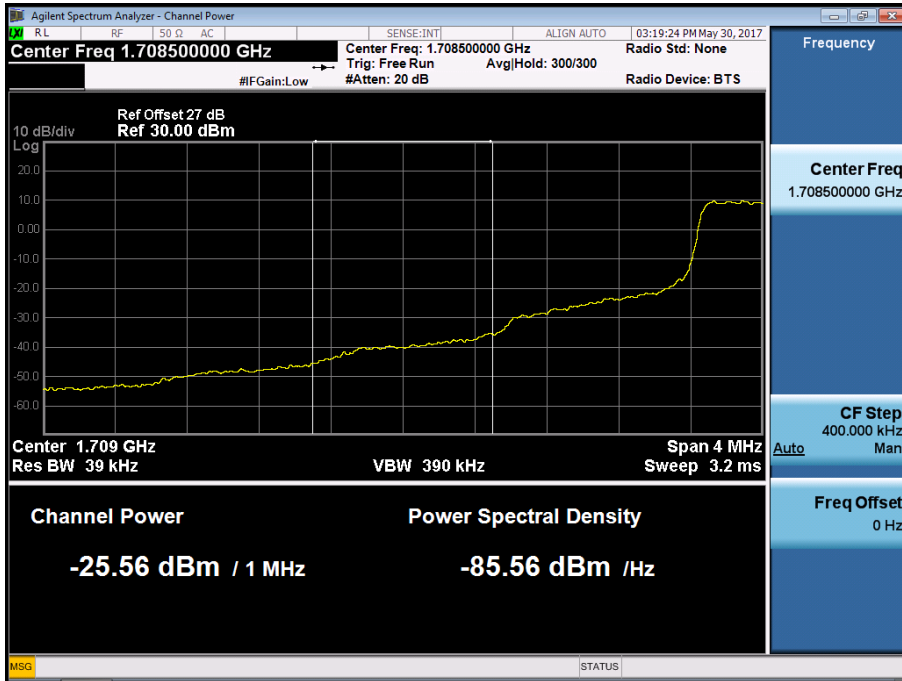

BAND 4. Lower Band Edge Plot (3M BW Ch.19965 QPSK RB 1, Offset 0) -1

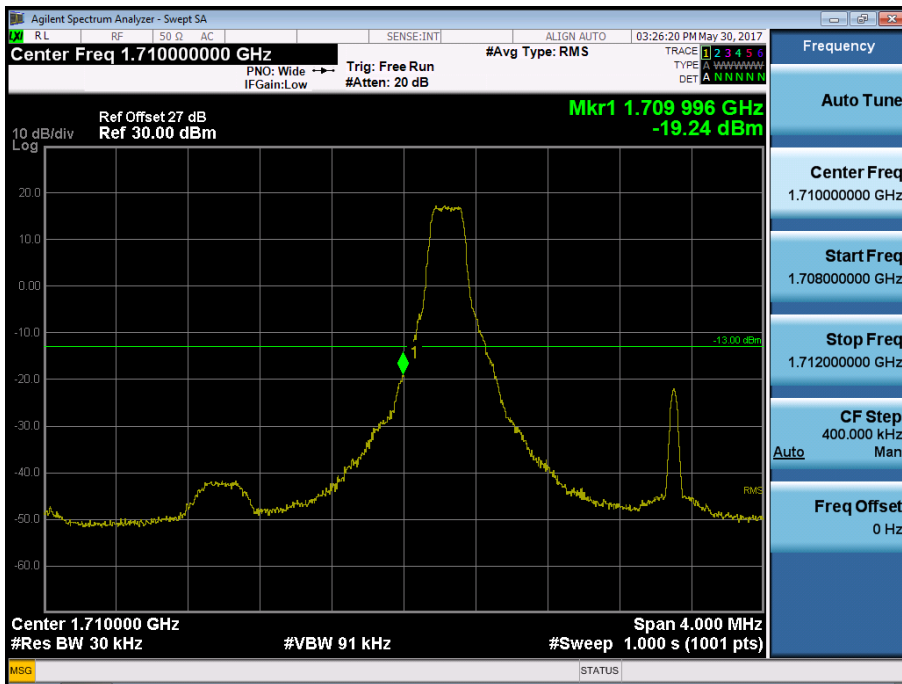

BAND 4. Lower Band Edge Plot (3M BW Ch.19965 QPSK RB 15) -2

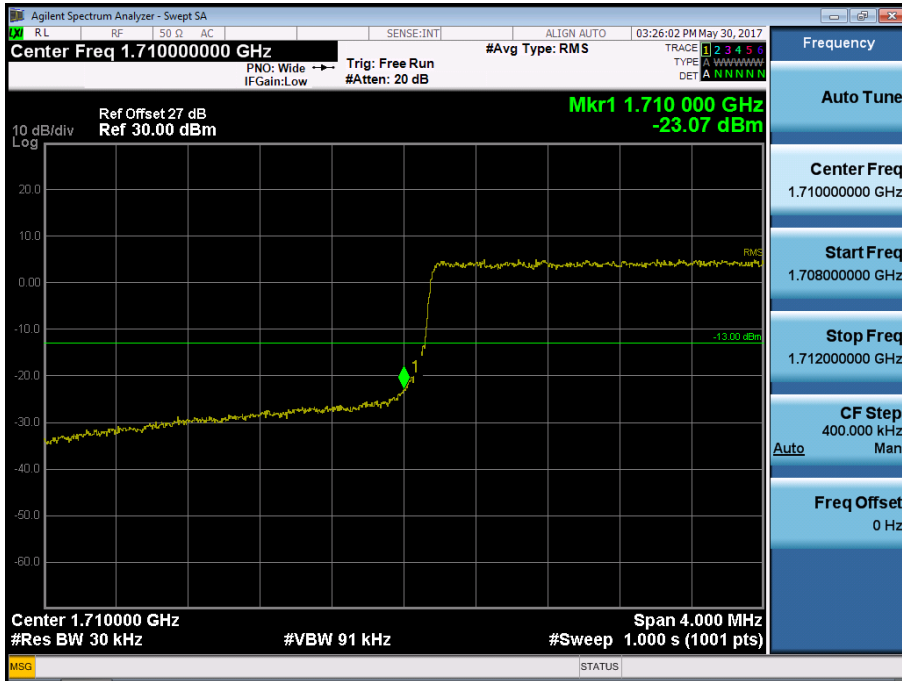

BAND 4. Lower Extended Band Edge Plot (3M BW Ch.19965 QPSK_RB15_0) -3

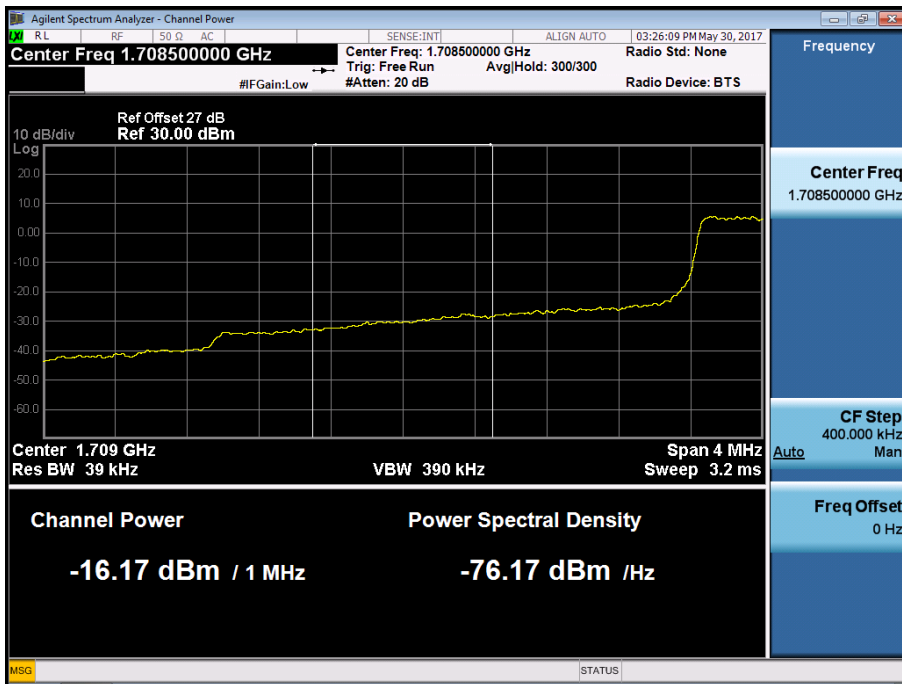

BAND 4. Lower Band Edge Plot (5M BW Ch.19975 QPSK RB 1, Offset 0) -1

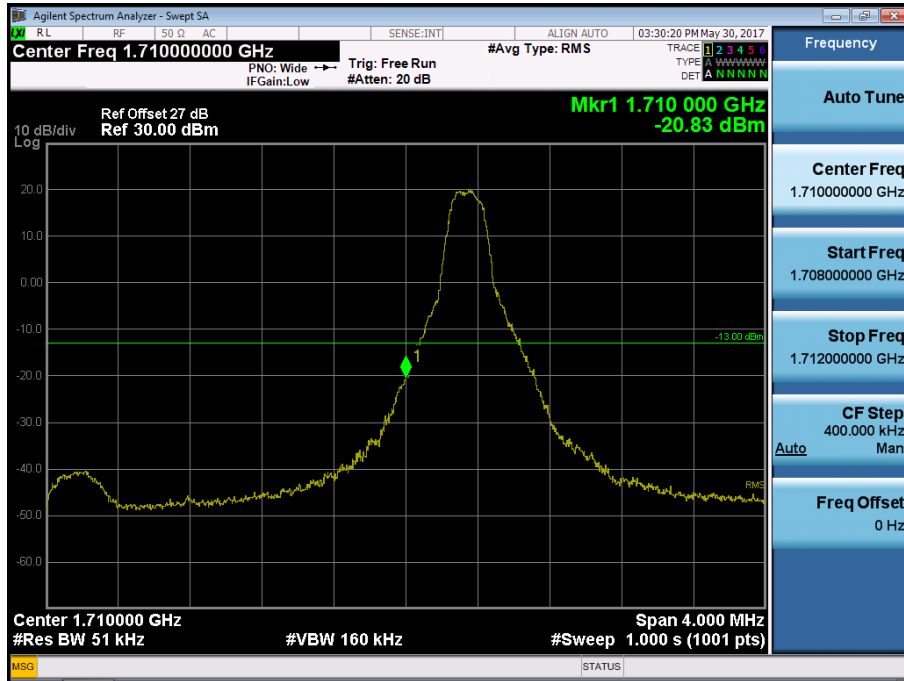

BAND 4. Lower Band Edge Plot (5M BW Ch.19975 QPSK RB 25) -2

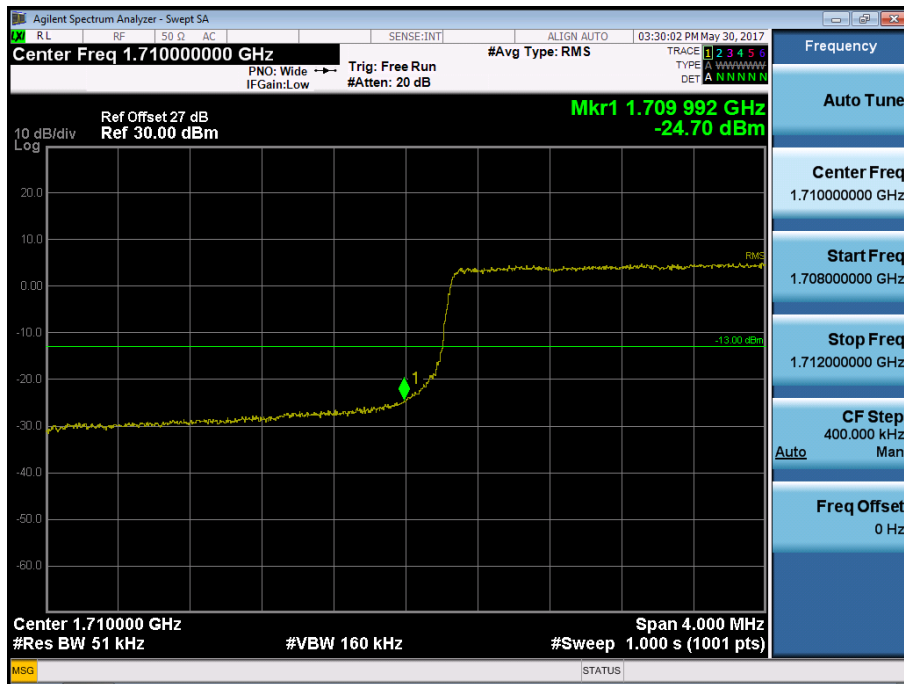

BAND 4. Lower Extended Band Edge Plot (5M BW Ch.19975 QPSK_RB25_0) -3

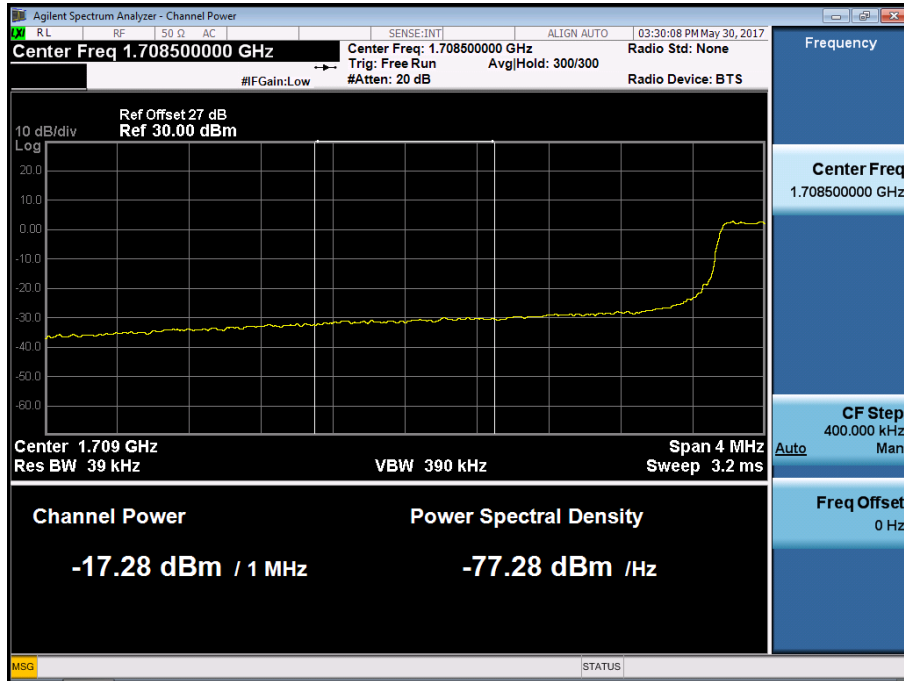

BAND 4. Lower Band Edge Plot (10M BW Ch.20000 QPSK RB 1, Offset 0) -1

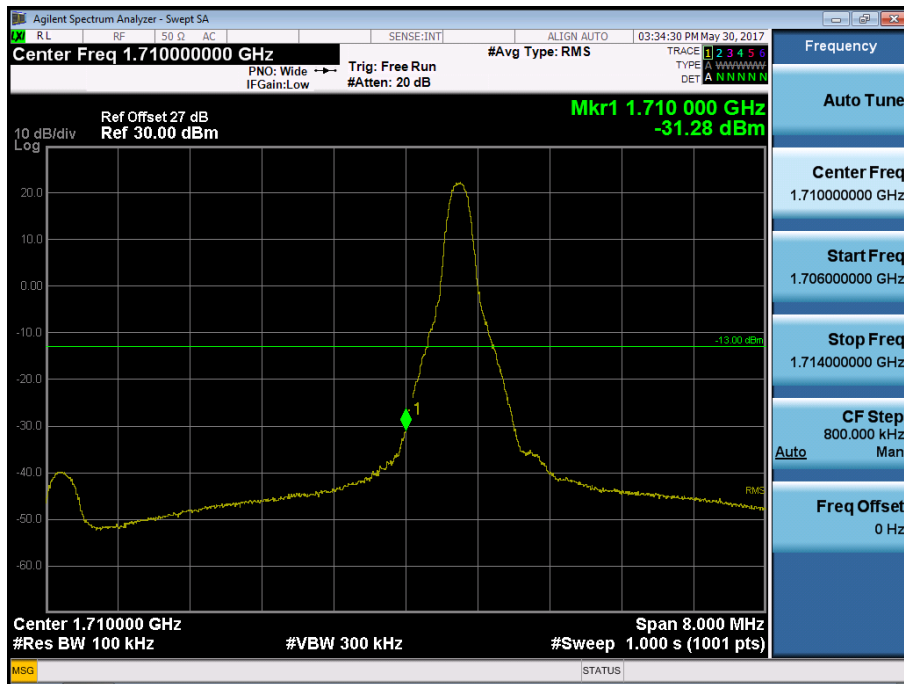

BAND 4. Lower Band Edge Plot (10M BW Ch.20000 QPSK RB 50) -2

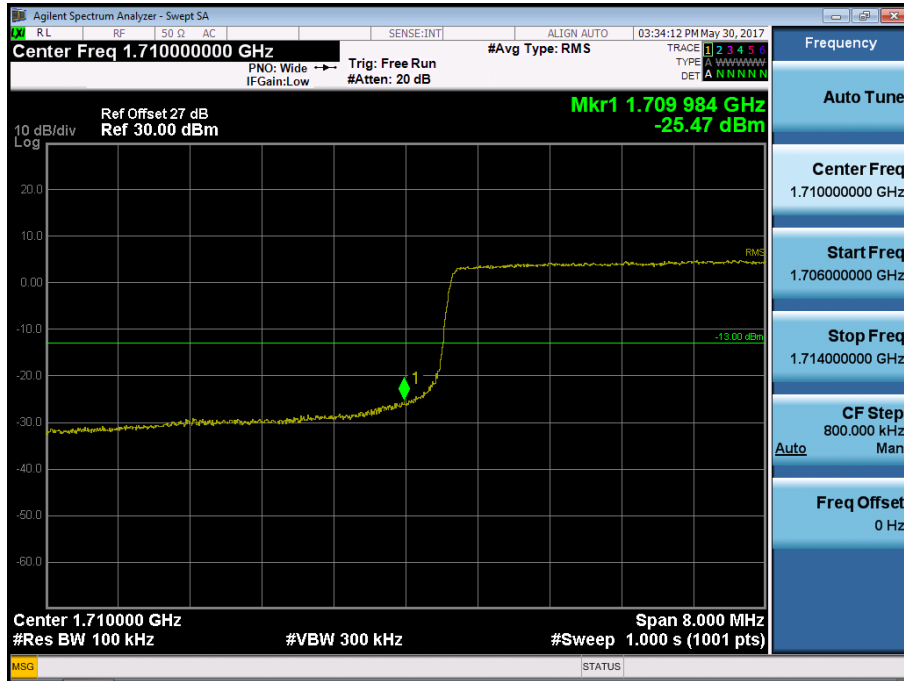

BAND 4. Lower Extended Band Edge Plot (10M BW Ch.20000 QPSK_RB50_0) -3

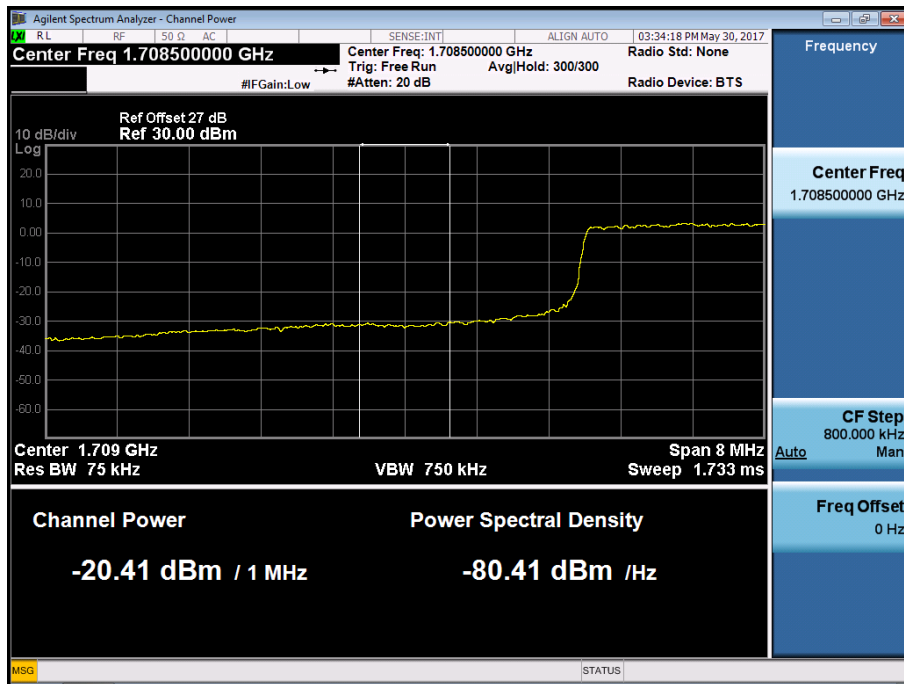

BAND 4. Lower Band Edge Plot (15M BW Ch.20025 QPSK RB 1, Offset 0) -1

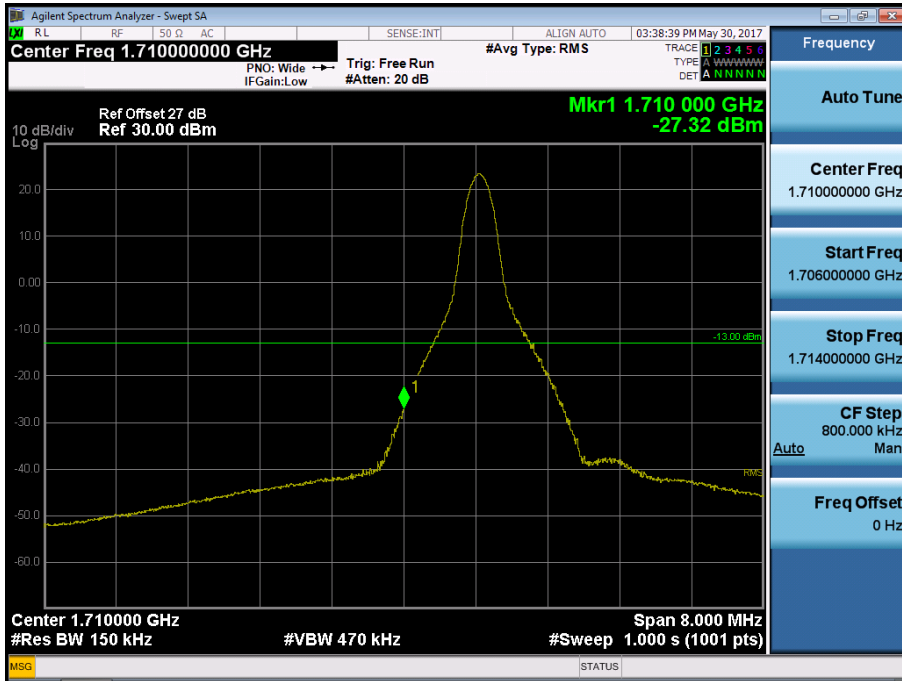

BAND 4. Lower Band Edge Plot (15M BW Ch.20025 QPSK RB 75) -2

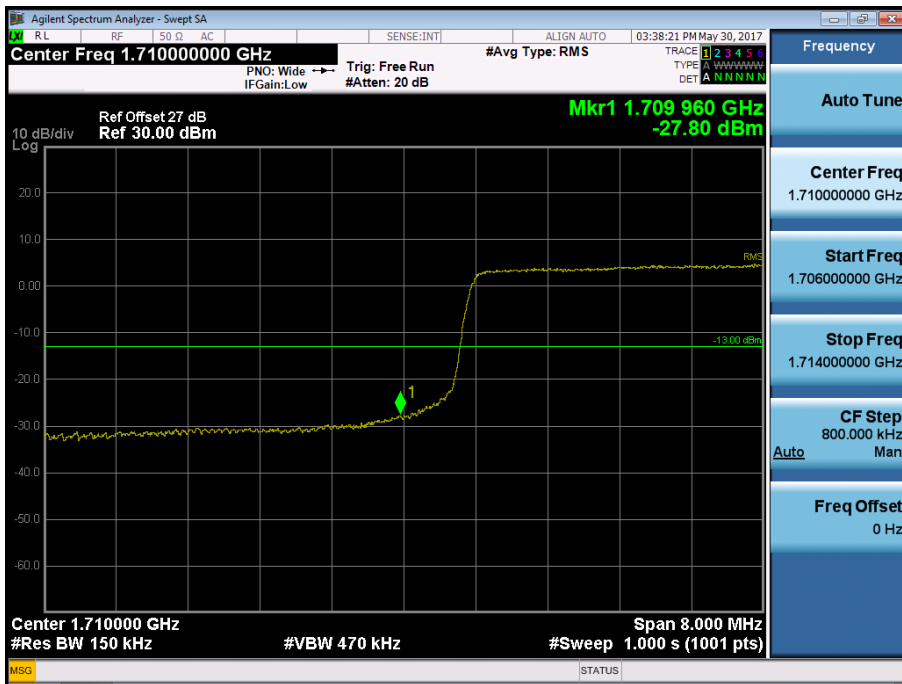

BAND 4. Lower Extended Band Edge Plot (15M BW Ch.20025 QPSK_RB75_0) -3

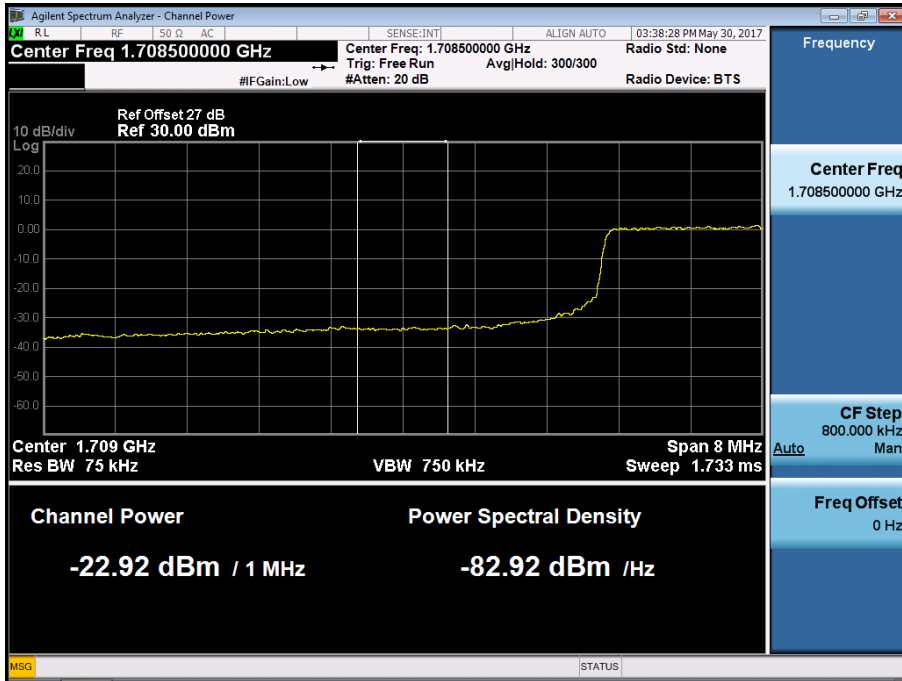

BAND 4. Lower Band Edge Plot (20M BW Ch.20050 QPSK RB 1, Offset 0) -1

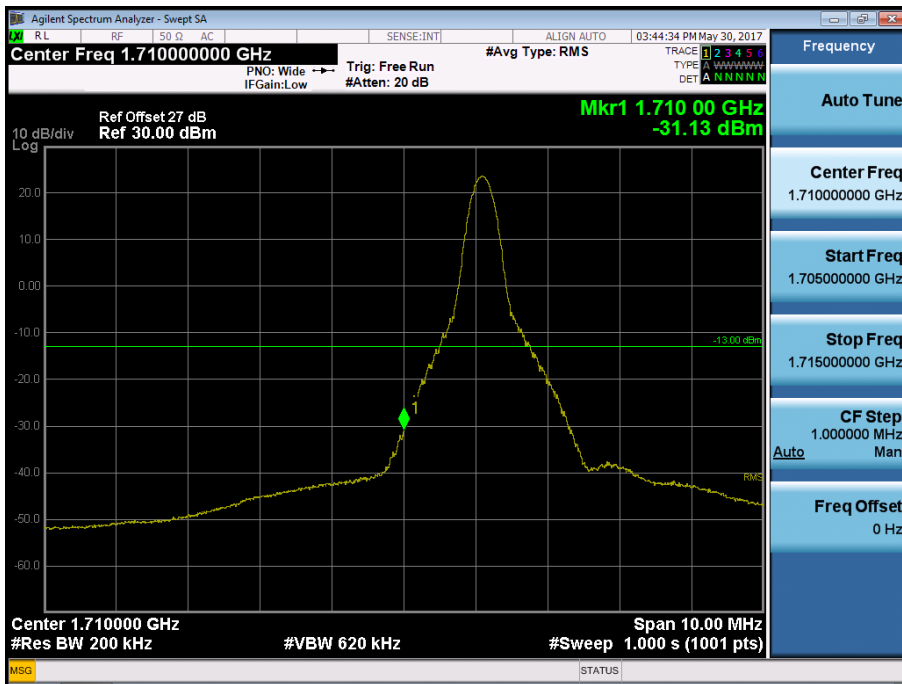

BAND 4. Lower Band Edge Plot (20M BW Ch.20050 QPSK RB 100) -2

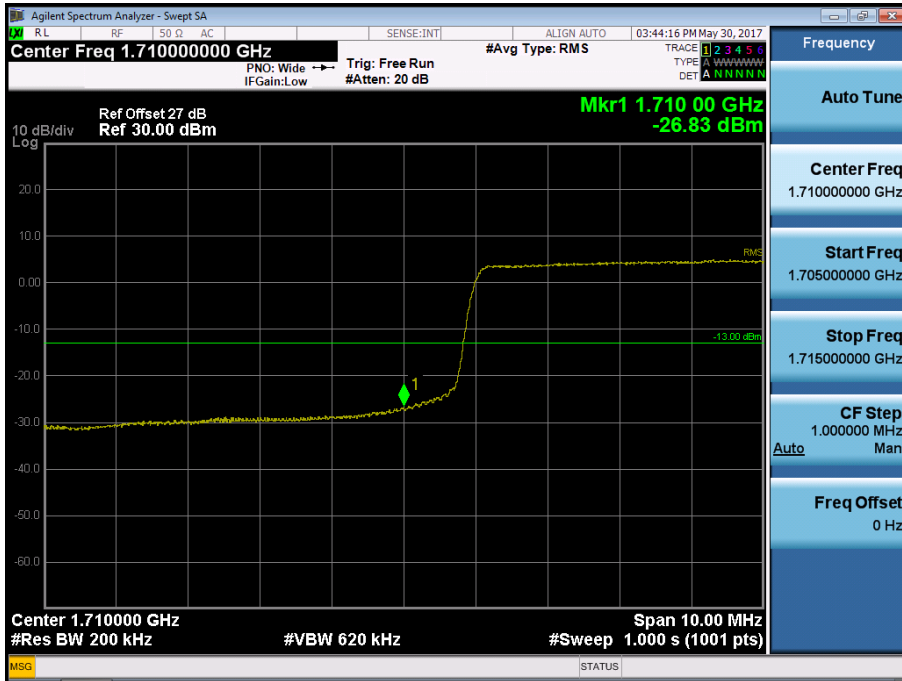

BAND 4. Lower Extended Band Edge Plot (20M BW Ch.20050 QPSK_RB100_0) -3

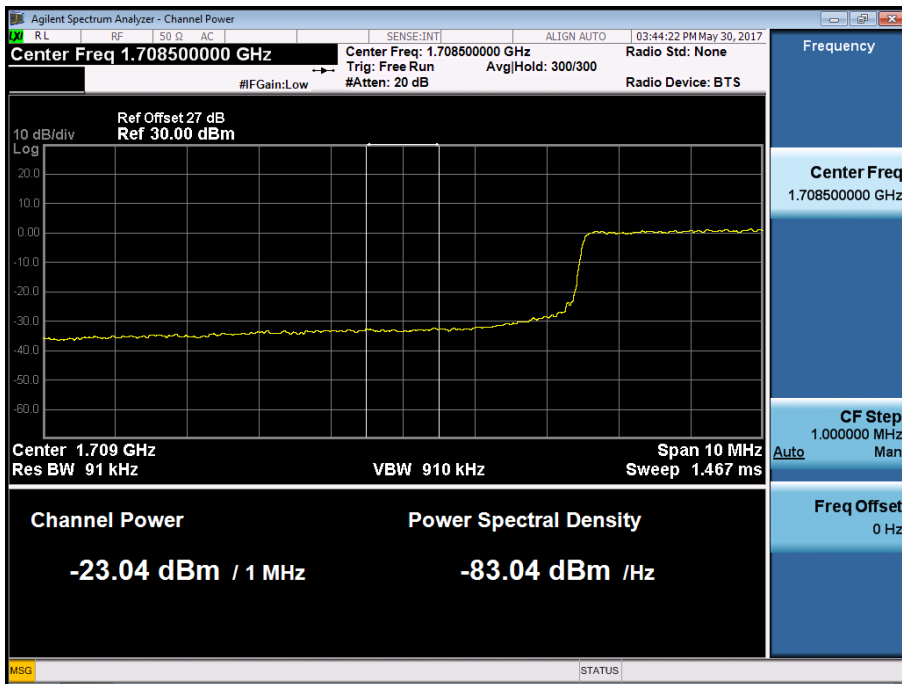

BAND 4. Upper Band Edge Plot (1.4M BW Ch.20393 QPSK_RB1_Offset 5) -1

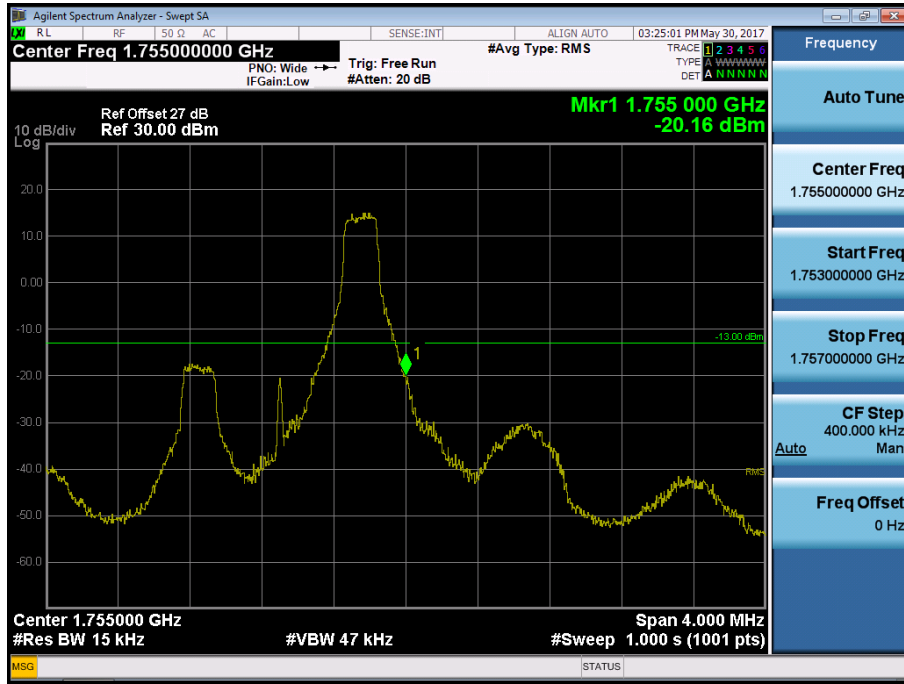

BAND 4. Upper Band Edge Plot (1.4M BW Ch.20393 QPSK_RB6) -2



BAND 4. Upper Extended Band Edge Plot (1.4M BW Ch. 20393 QPSK_RB6_0) -3

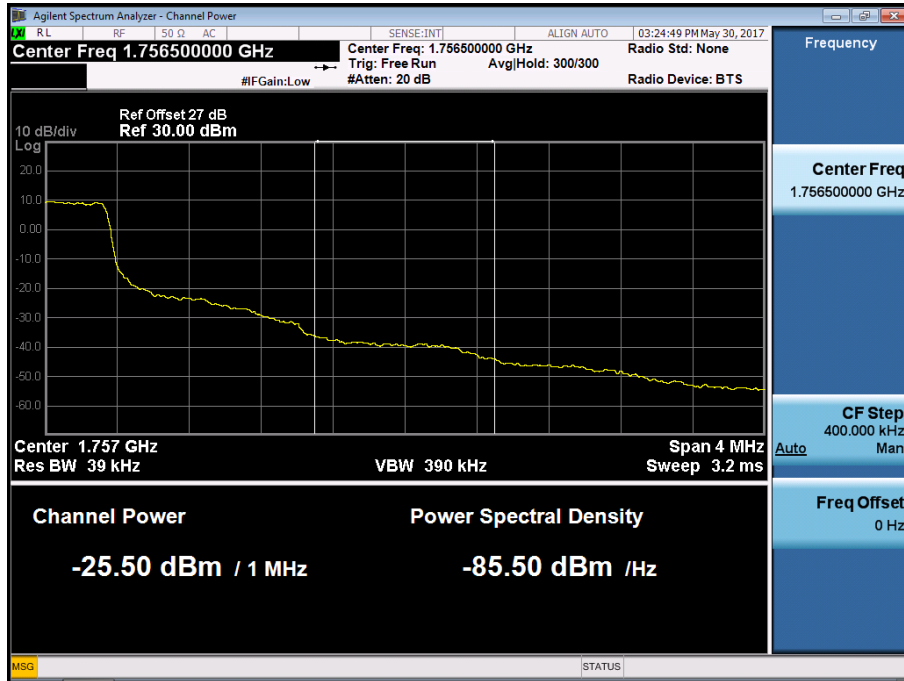

BAND 4. Upper Band Edge Plot (3M BW Ch.20385 QPSK_RB1_Offset 14) -1

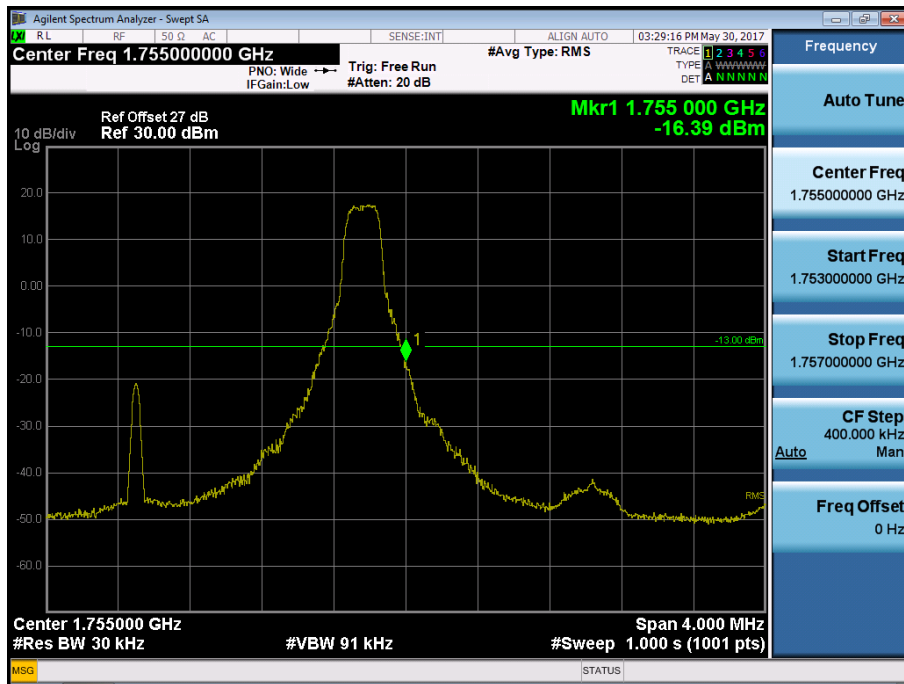

BAND 4. Upper Band Edge Plot (3M BW Ch.20385 QPSK_RB15) -2



BAND 4. Upper Extended Band Edge Plot (3M BW Ch.20385 QPSK_RB15_0) -3

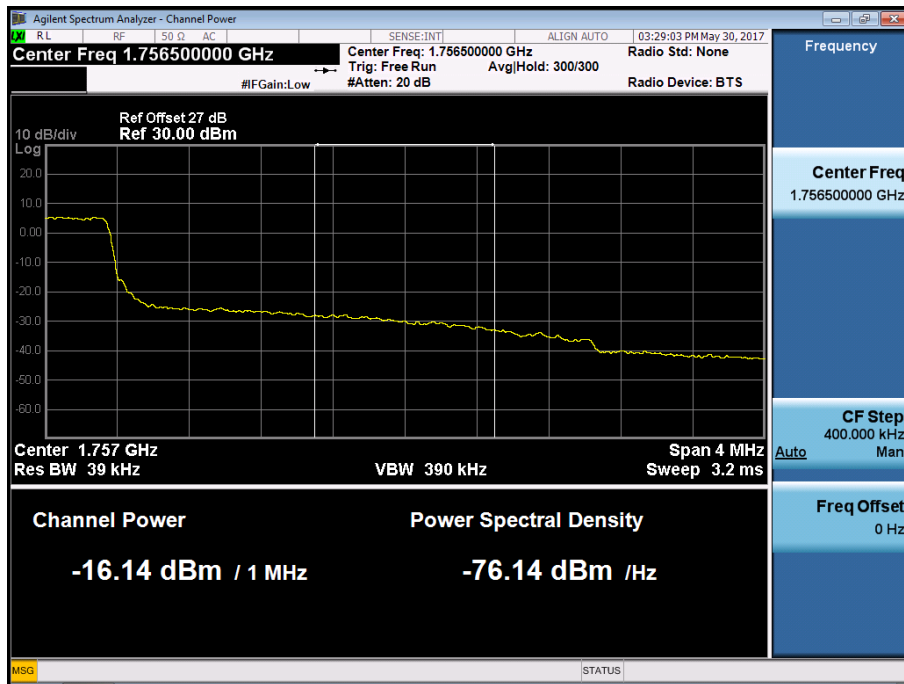

BAND 4. Upper Band Edge Plot (5M BW Ch.20375 QPSK_RB1_Offset 24) -1

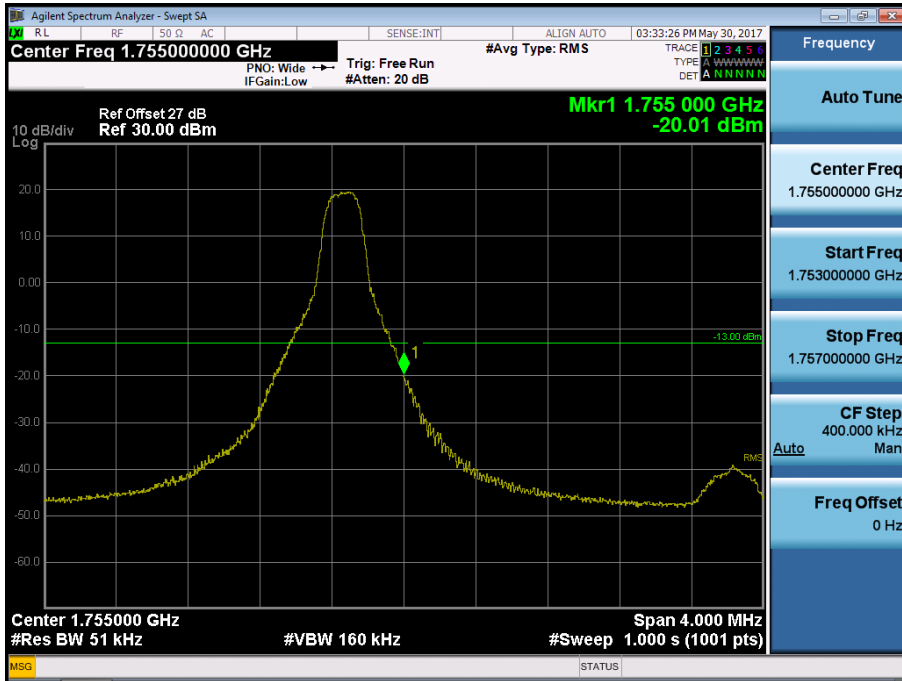

BAND 4. Upper Band Edge Plot (5M BW Ch.20375 QPSK_RB25) -2

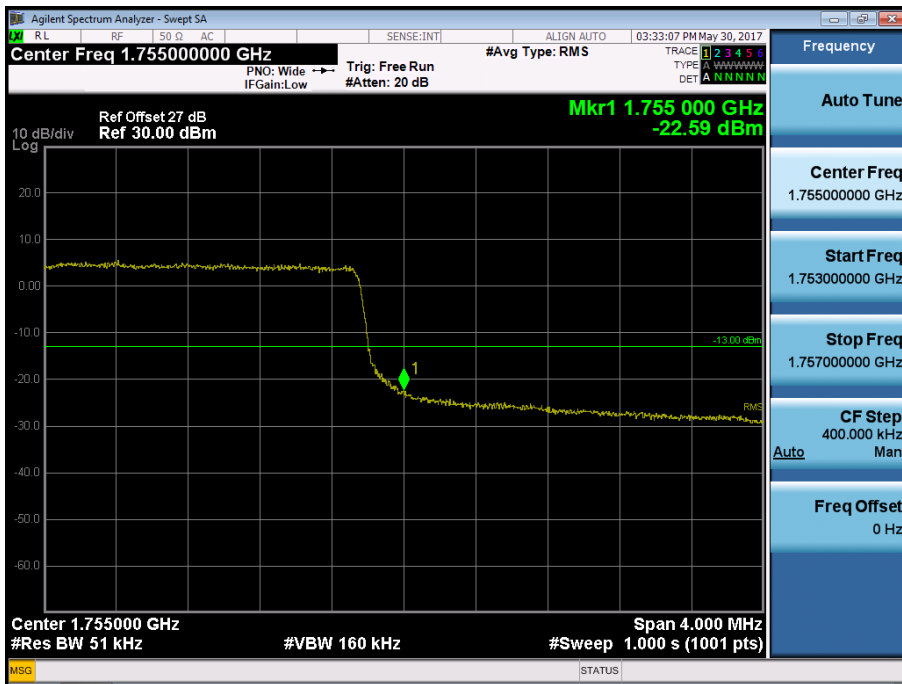

BAND 4. Upper Extended Band Edge Plot (5M BW Ch.20375 QPSK_RB25) -3

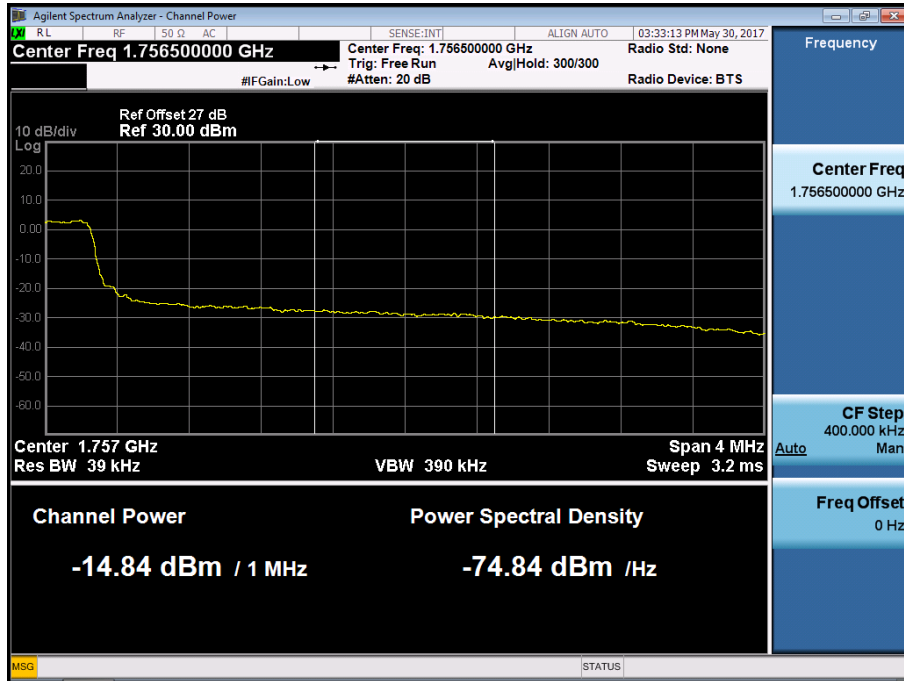

BAND 4. Upper Band Edge Plot (10M BW Ch.20350 QPSK_RB1_Offset 49) -1

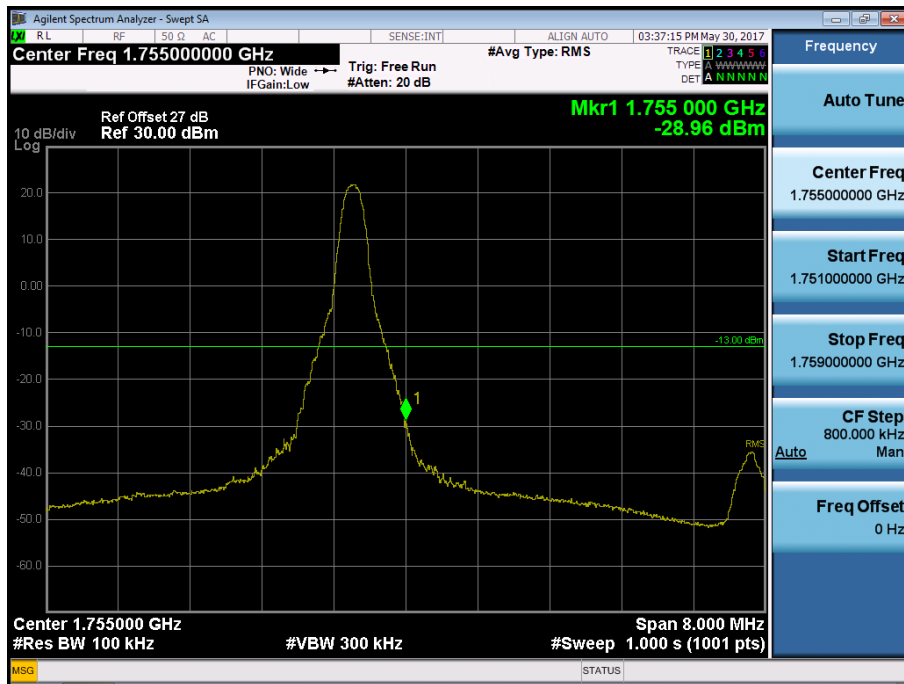

BAND 4. Upper Band Edge Plot (10M BW Ch.20350 QPSK_RB50) -2



BAND 4. Upper Extended Band Edge Plot (10M BW Ch.20350 QPSK_RB50) -3

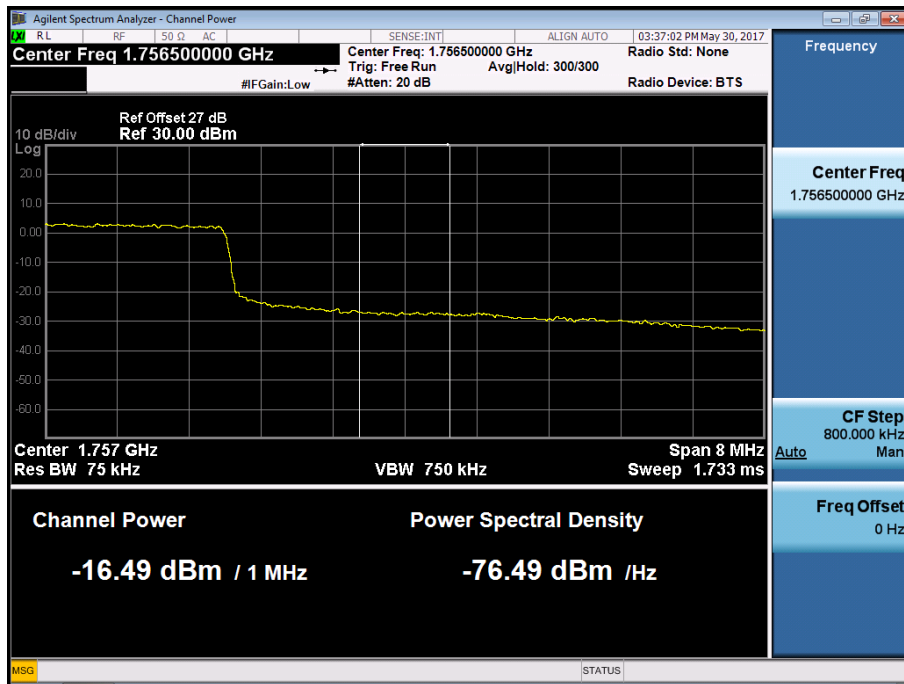

BAND 4. Upper Band Edge Plot (15M BW Ch.20325 QPSK_RB1_Offset 74) -1

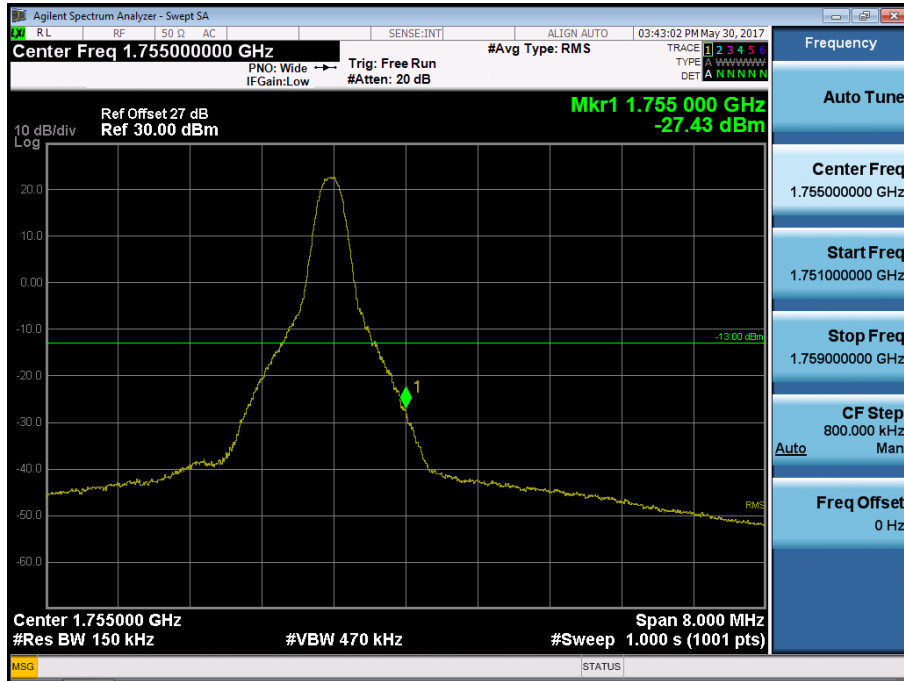

BAND 4. Upper Band Edge Plot (15M BW Ch.20325 QPSK_RB75) -2

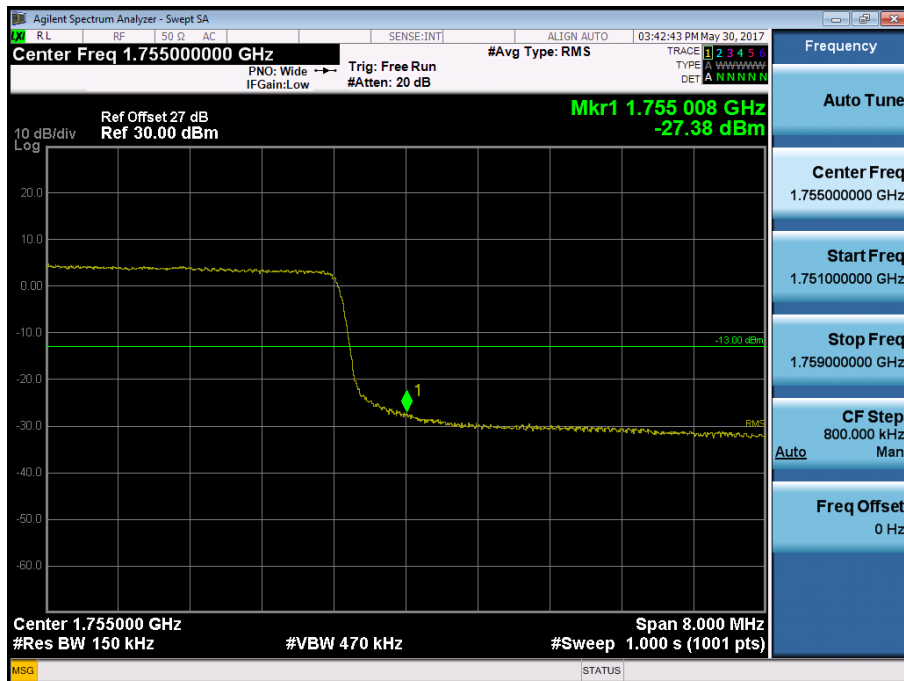

BAND 4. Upper Extended Band Edge Plot (15M BW Ch.20325 QPSK_RB75) -3

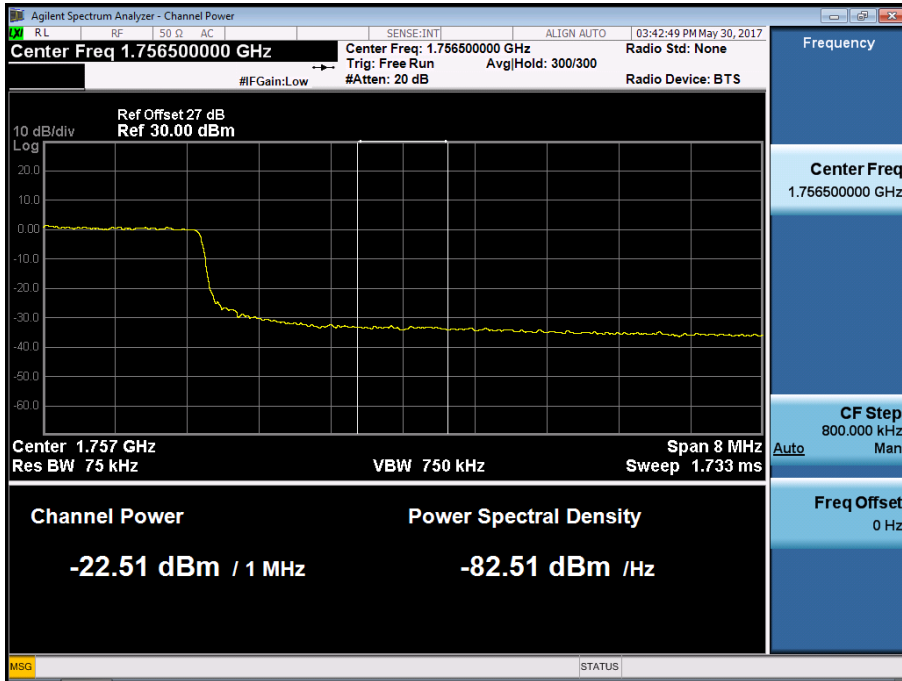

BAND 4. Upper Band Edge Plot (20M BW Ch.20300 QPSK_RB1_Offset 99) -1

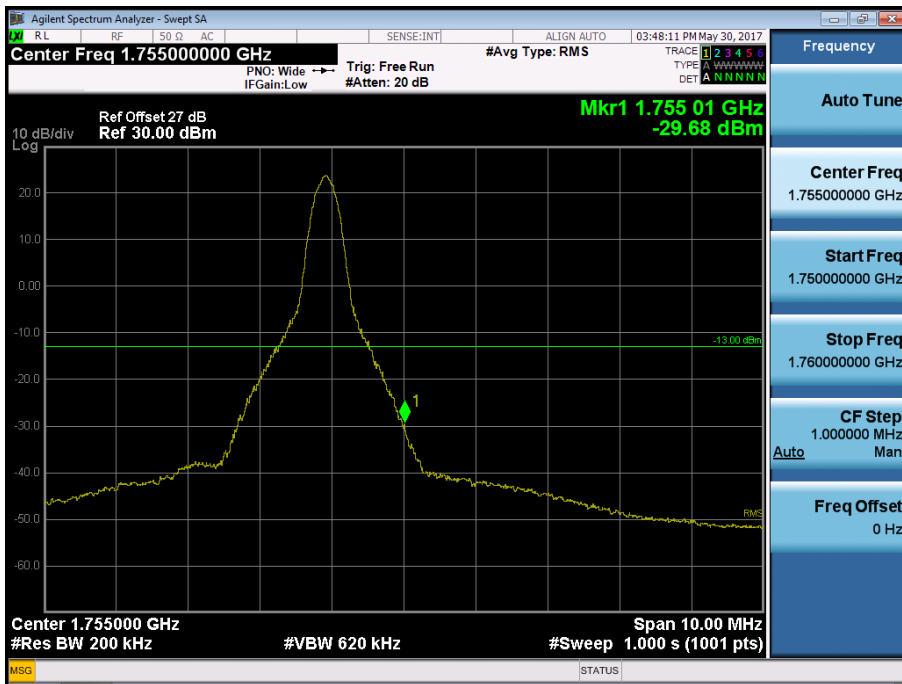

BAND 4. Upper Band Edge Plot (20M BW Ch.20300 QPSK_RB100) -2

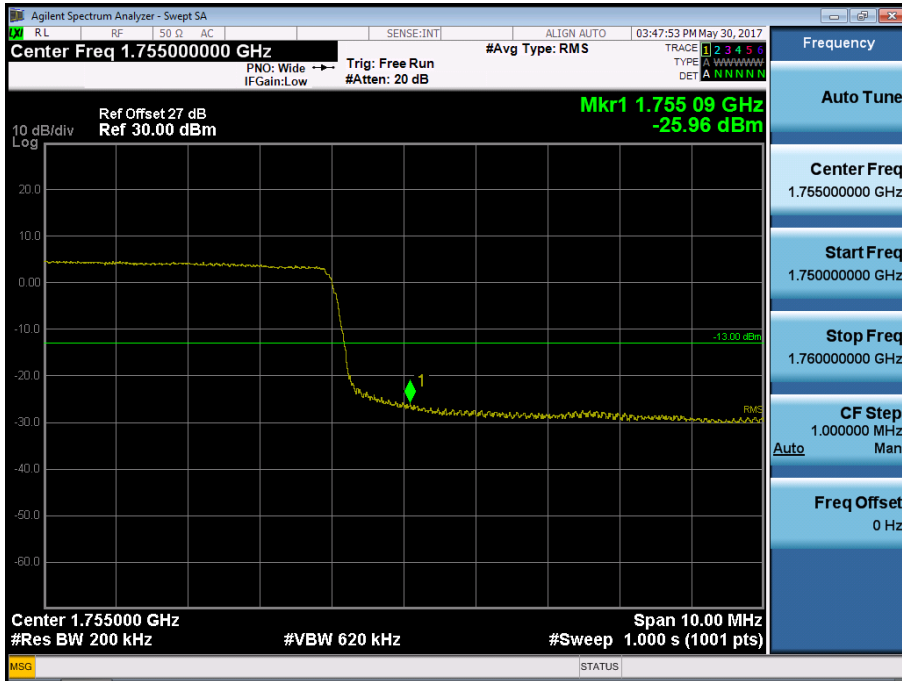

BAND 4. Upper Extended Band Edge Plot (20M BW Ch.20300 QPSK_RB100) -3

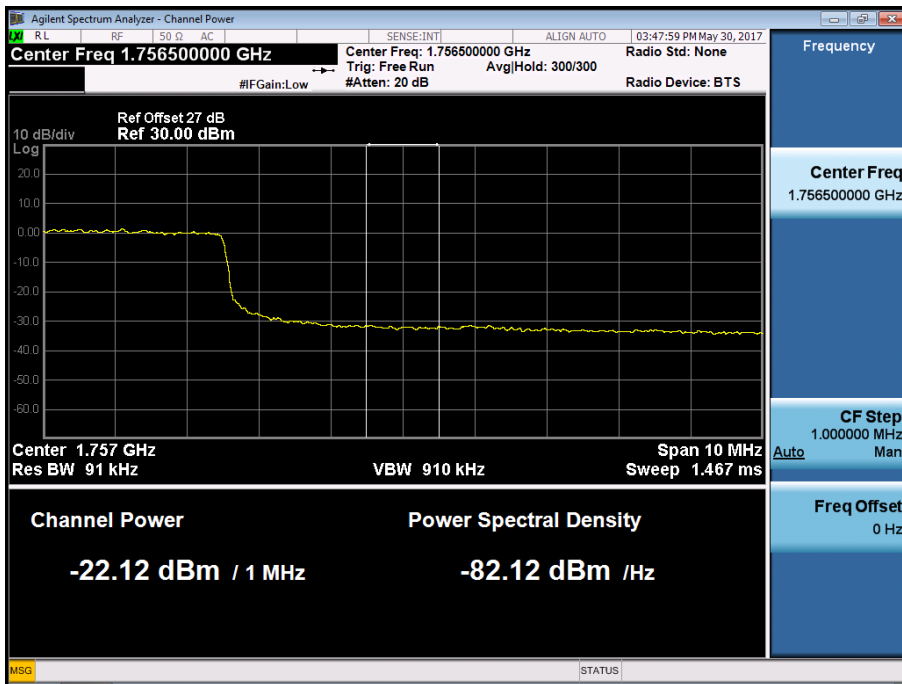

BAND 4. Conducted Spurious Plot_1 (19957ch_1.4MHz_QPSK_RB 1_0)

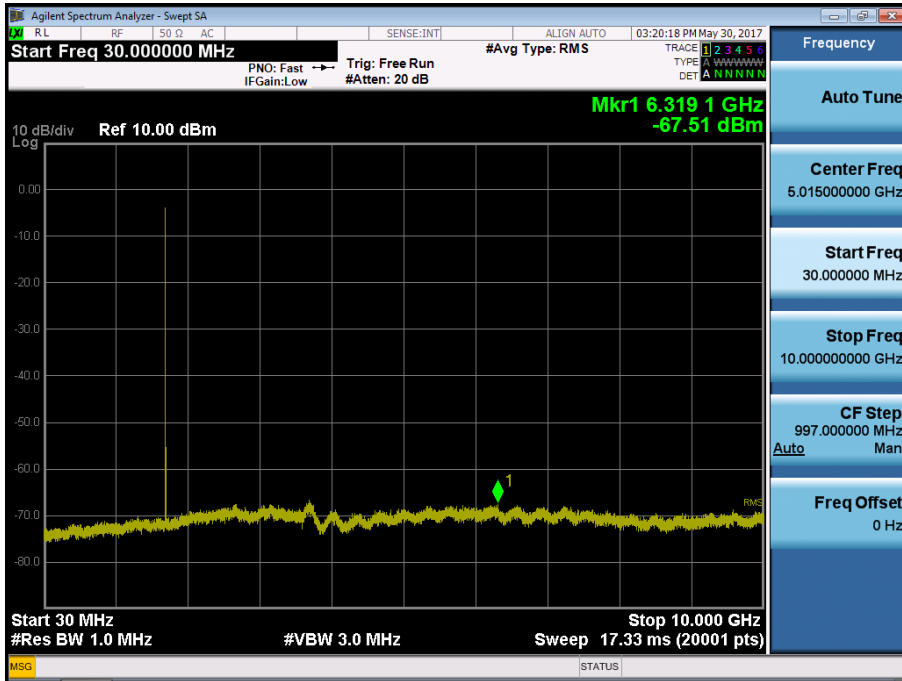

BAND 4. Conducted Spurious Plot_2 (19957ch_1.4MHz_QPSK_RB 1_0)

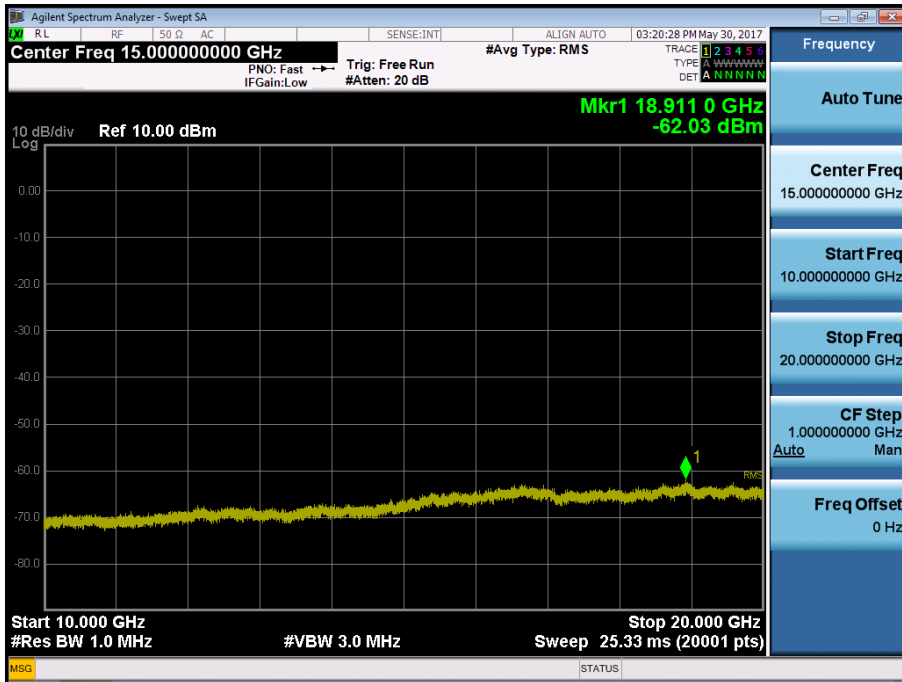

BAND 4. Conducted Spurious Plot_1 (20175ch_1.4MHz_QPSK_RB 1_0)

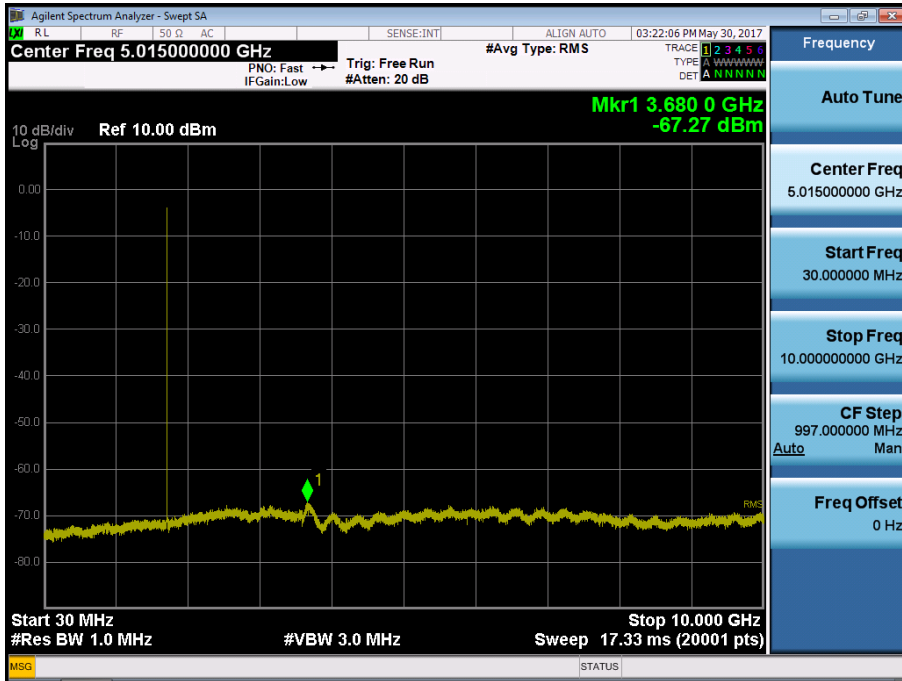

BAND 4. Conducted Spurious Plot_2 (20175ch_1.4MHz_QPSK_RB 1_0)

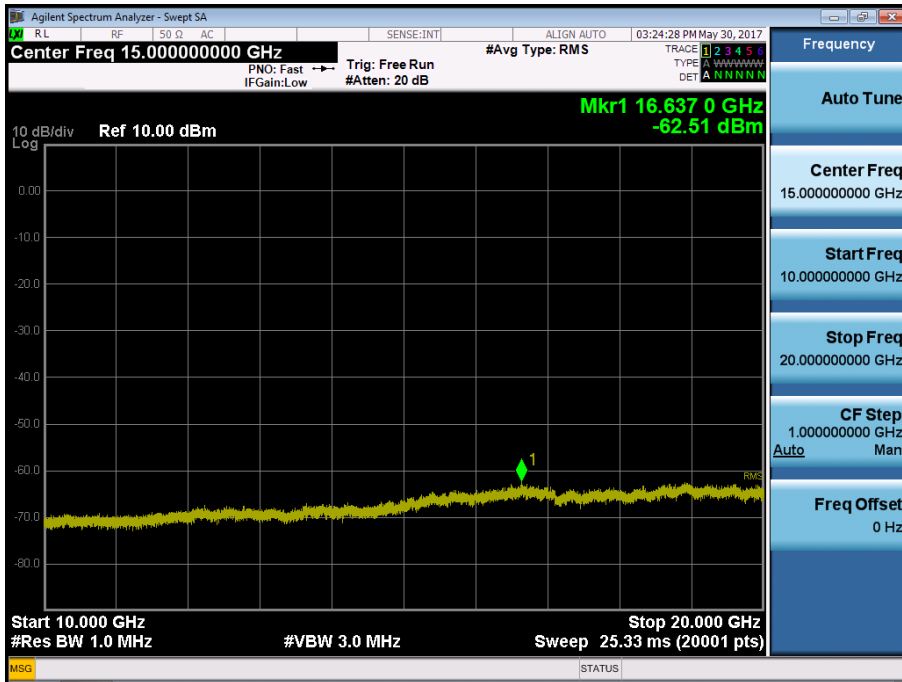

BAND 4. Conducted Spurious Plot_1 (20393ch_1.4MHz_QPSK_RB 1_0)

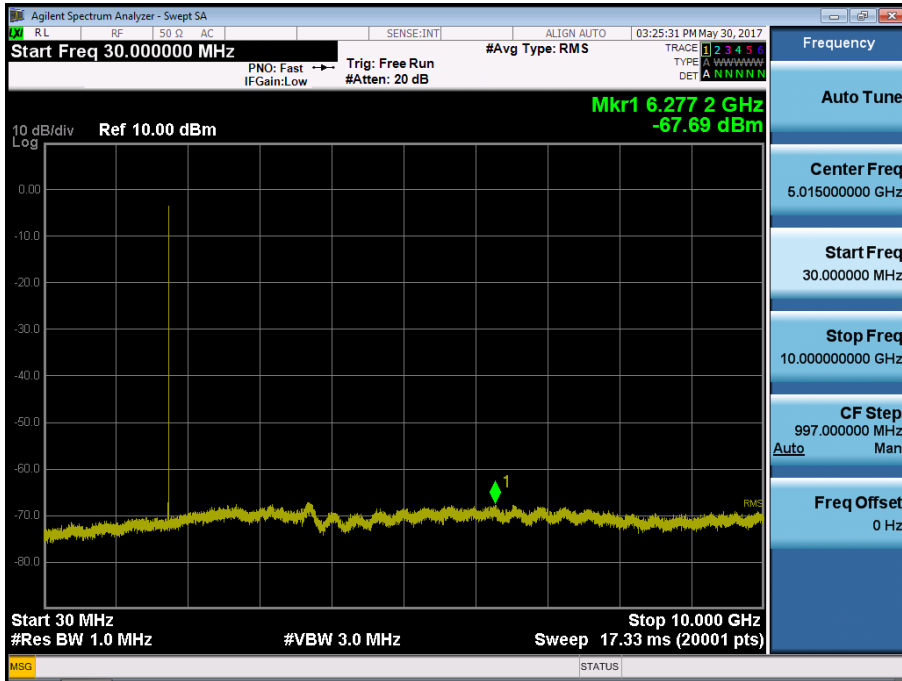

BAND 4. Conducted Spurious Plot_2 (20393ch_1.4MHz_QPSK_RB 1_0)



BAND 4. Conducted Spurious Plot_1 (19965ch_3MHz_QPSK_RB 1_0)

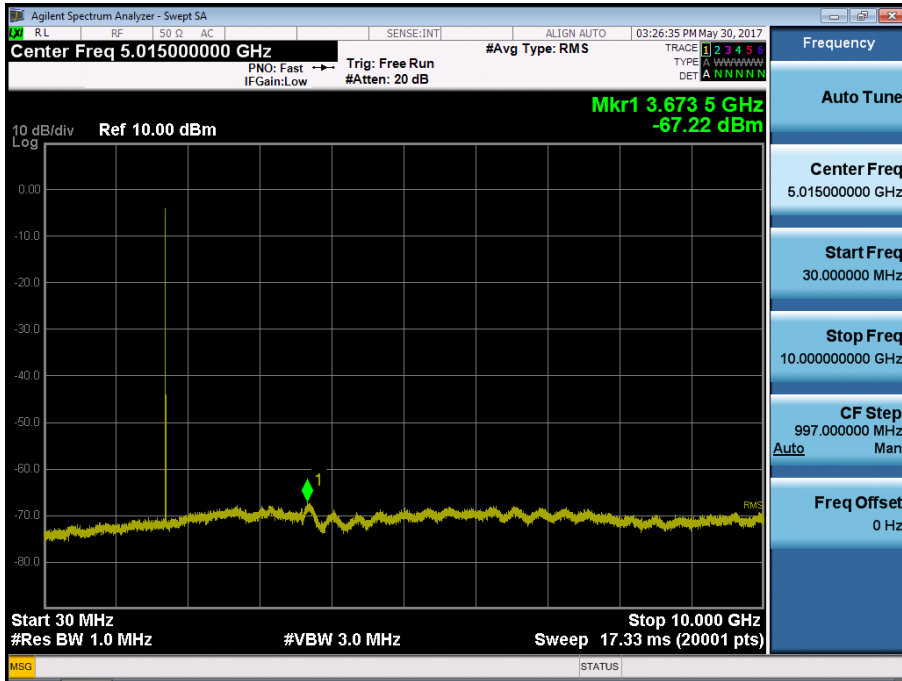

BAND 4. Conducted Spurious Plot_2 (19965ch_3MHz_QPSK_RB 1_0)

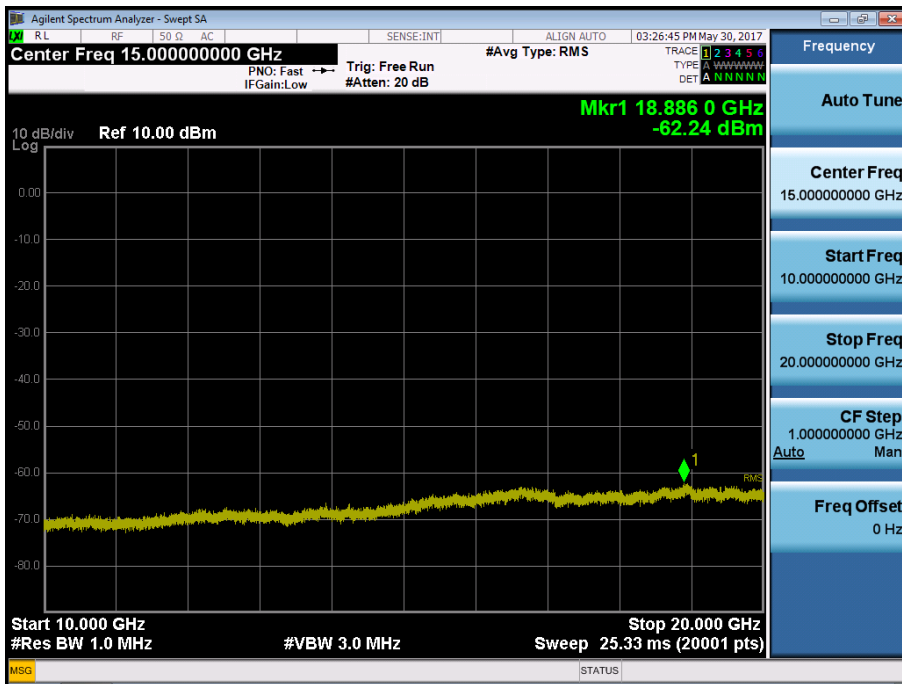

BAND 4. Conducted Spurious Plot_1 (20175ch_3MHz_QPSK_RB 1_0)

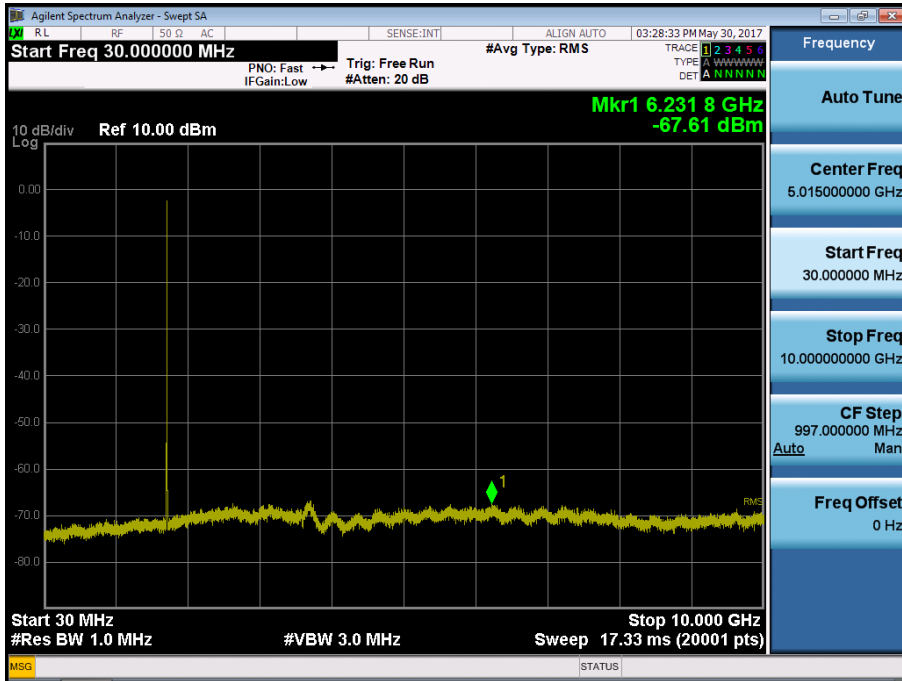

BAND 4. Conducted Spurious Plot_2 (20175ch_3MHz_QPSK_RB 1_0)

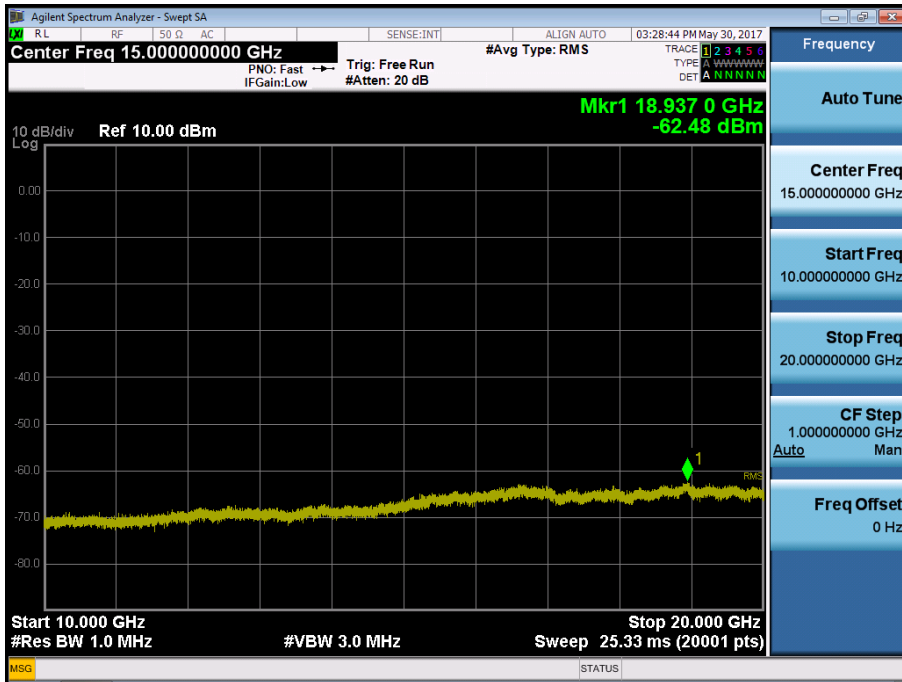

BAND 4. Conducted Spurious Plot_1 (20385ch_3MHz_QPSK_RB 1_0)

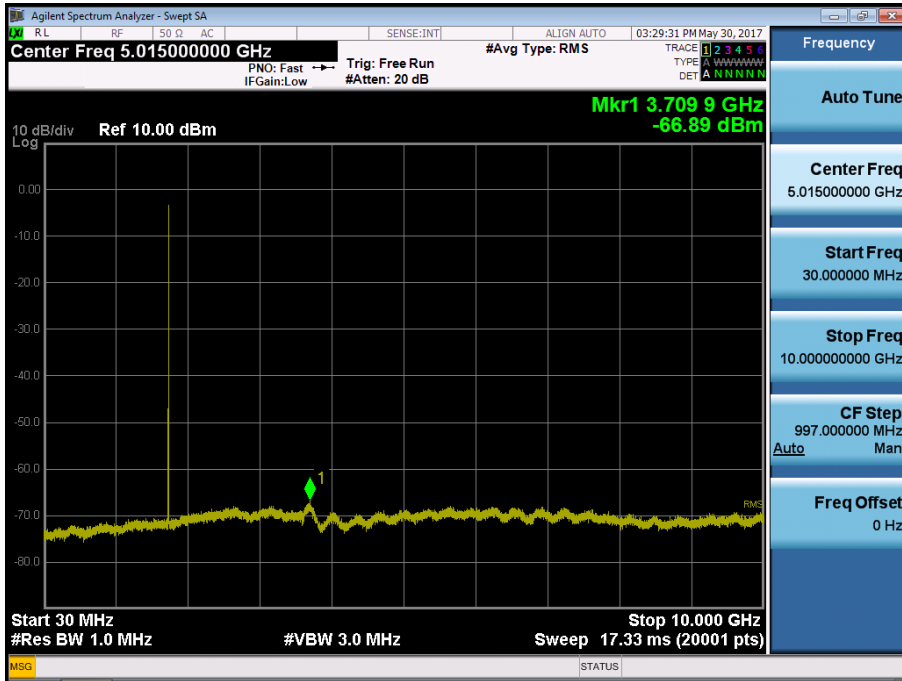

BAND 4. Conducted Spurious Plot_2 (20385ch_3MHz_QPSK_RB 1_0)

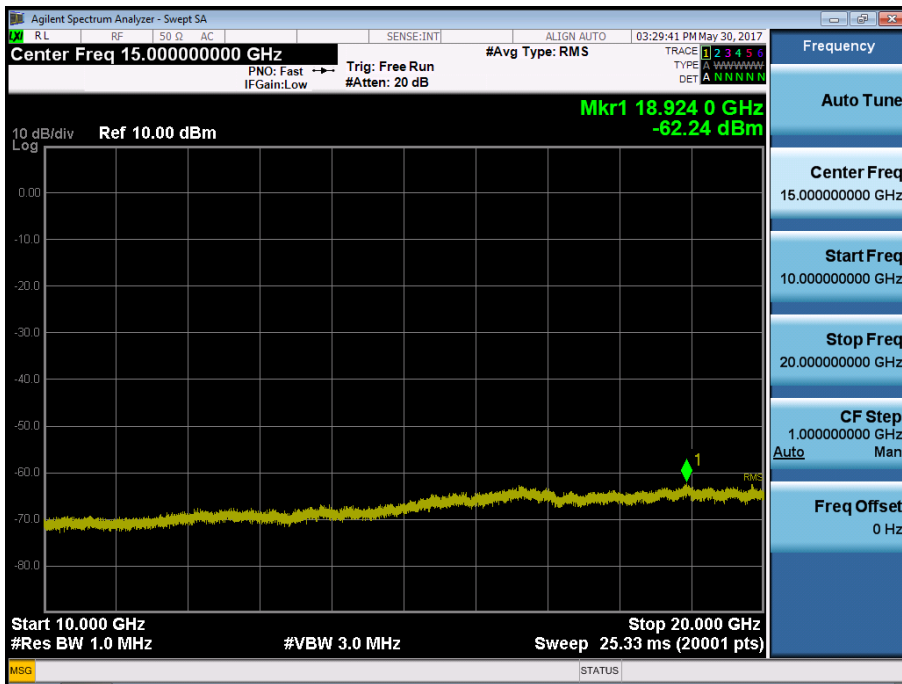

BAND 4. Conducted Spurious Plot_1 (19975ch_5MHz_QPSK_RB 1_0)

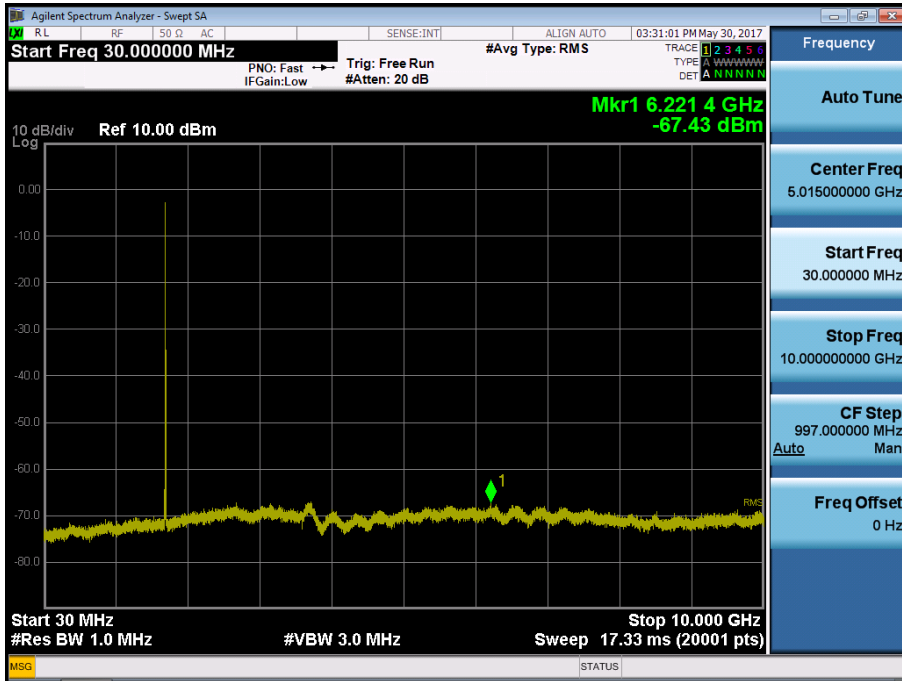

BAND 4. Conducted Spurious Plot_2 (19975ch_5MHz_QPSK_RB 1_0)

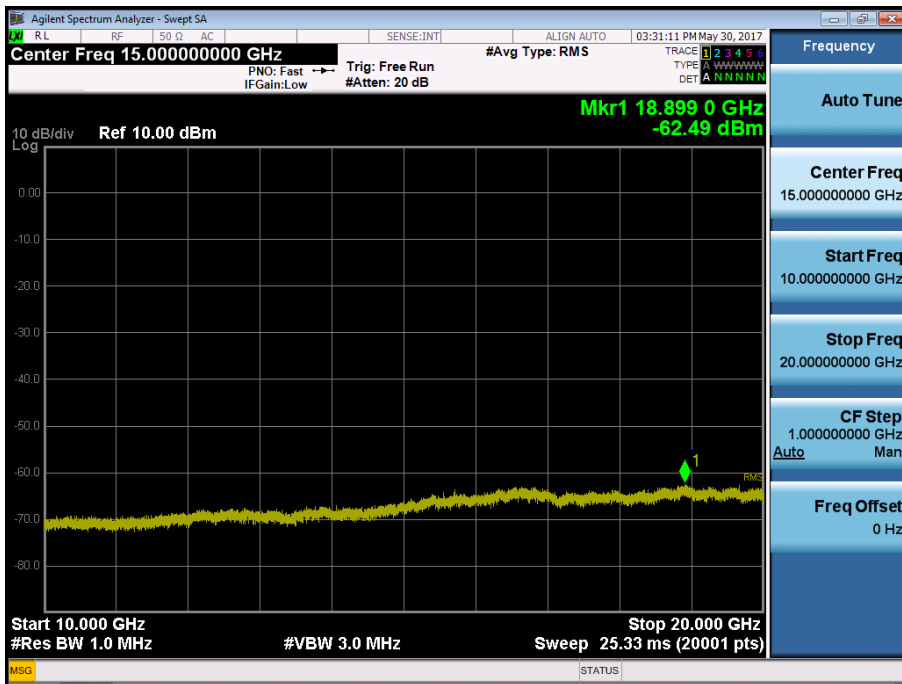

BAND 4. Conducted Spurious Plot_1 (20175ch_5MHz_QPSK_RB 1_0)

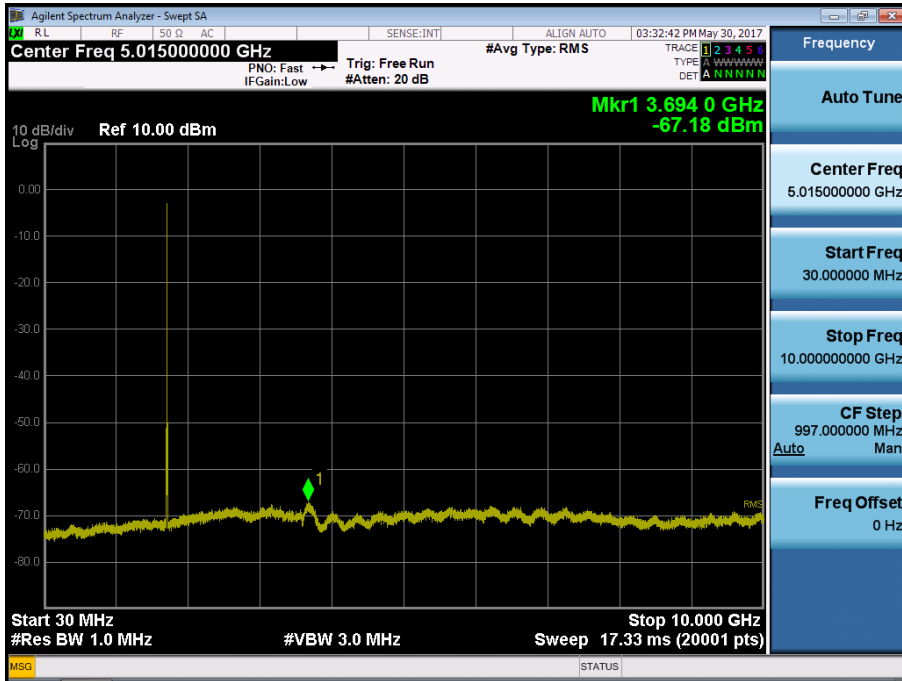

BAND 4. Conducted Spurious Plot_2 (20175ch_5MHz_QPSK_RB 1_0)

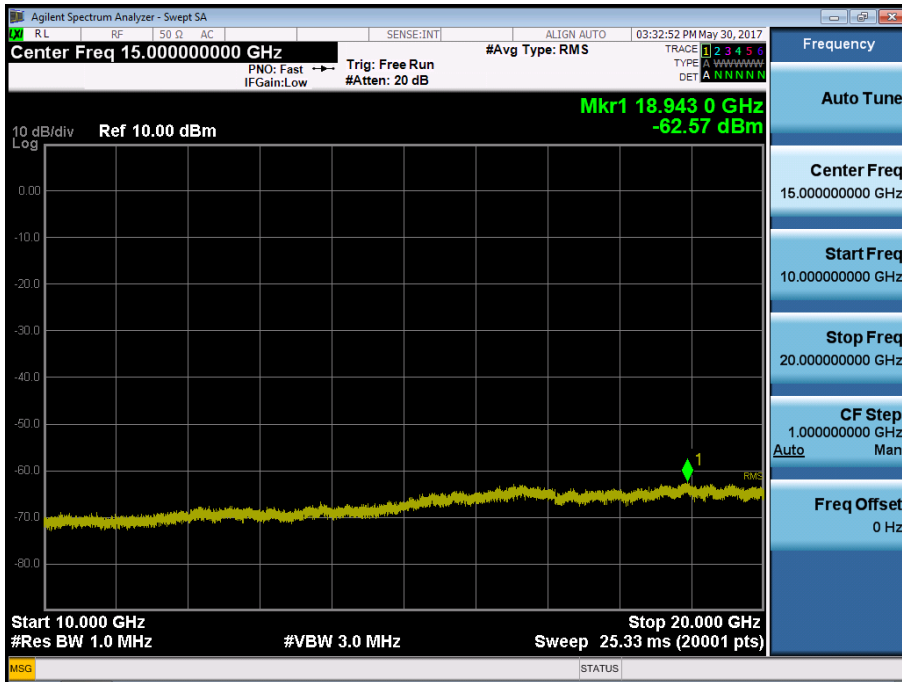

BAND 4. Conducted Spurious Plot_1 (20375ch_5MHz_QPSK_RB 1_0)

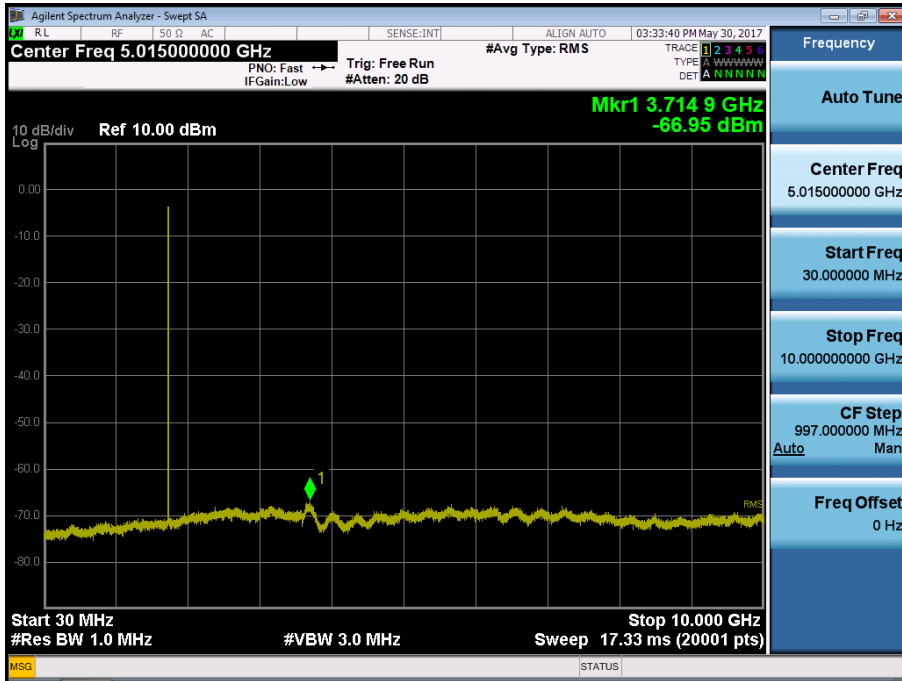

BAND 4. Conducted Spurious Plot_2 (20375ch_5MHz_QPSK_RB 1_0)

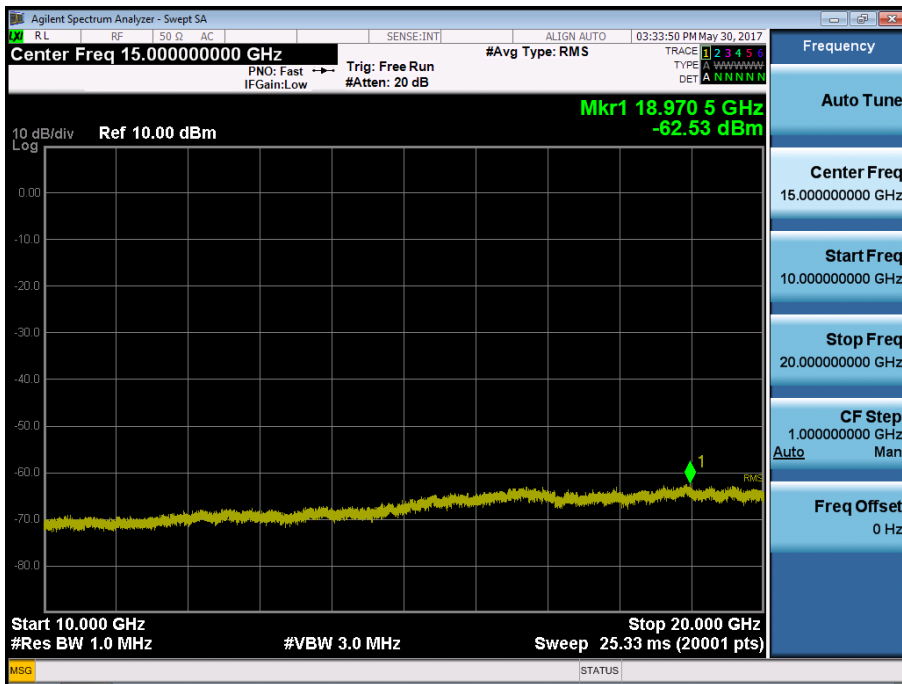

BAND 4. Conducted Spurious Plot_1 (20000ch_10MHz_QPSK_RB 1_0)

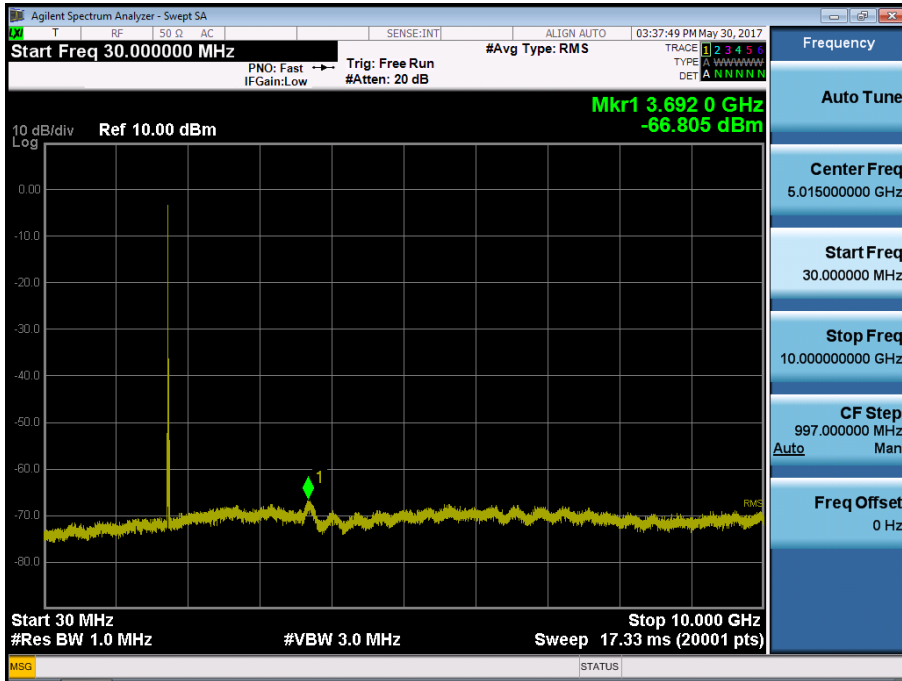

BAND 4. Conducted Spurious Plot_2 (20000ch_10MHz_QPSK_RB 1_0)

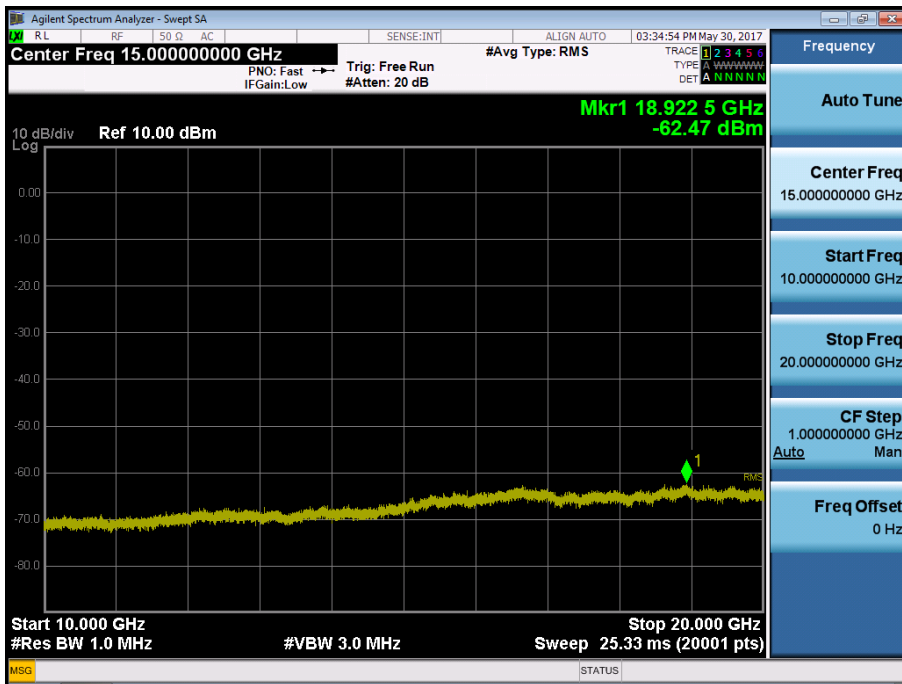

BAND 4. Conducted Spurious Plot_1 (20175ch_10MHz_QPSK_RB 1_0)

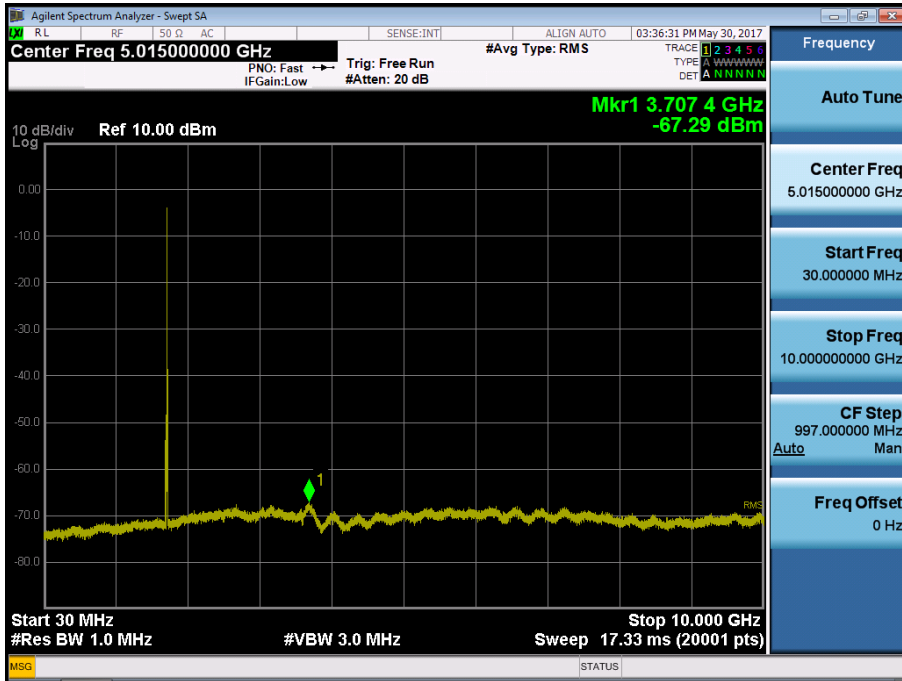

BAND 4. Conducted Spurious Plot_2 (20175ch_10MHz_QPSK_RB 1_0)

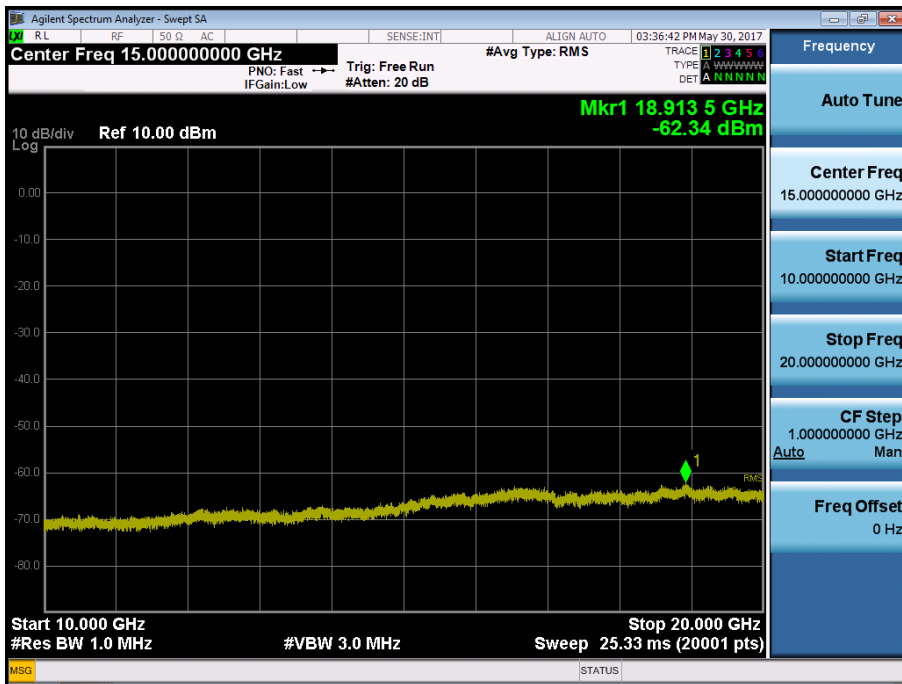

BAND 4. Conducted Spurious Plot_1 (20350ch_10MHz_QPSK_RB 1_0)

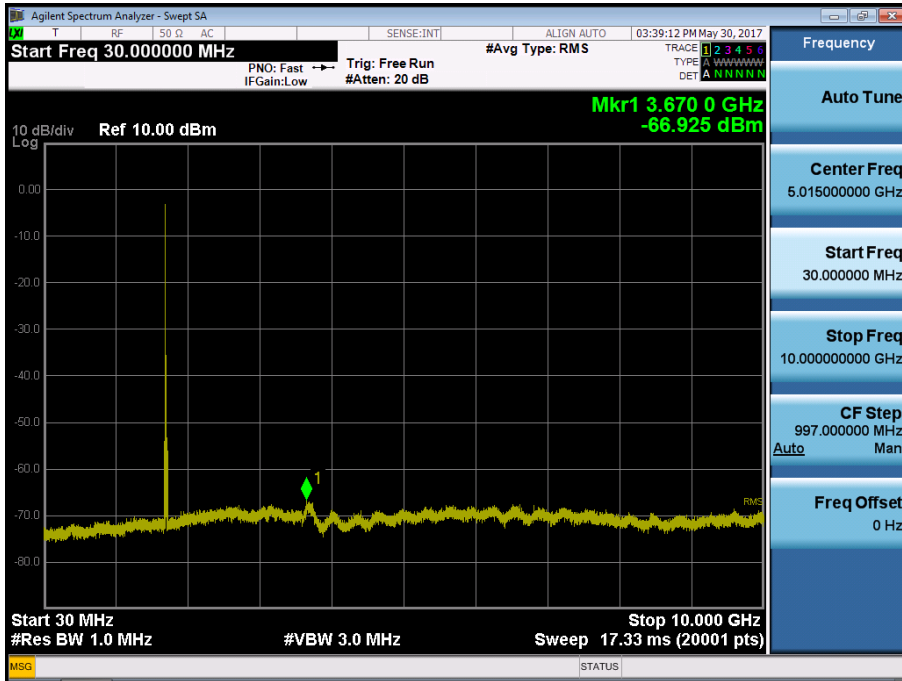

BAND 4. Conducted Spurious Plot_2 (20350ch_10MHz_QPSK_RB 1_0)

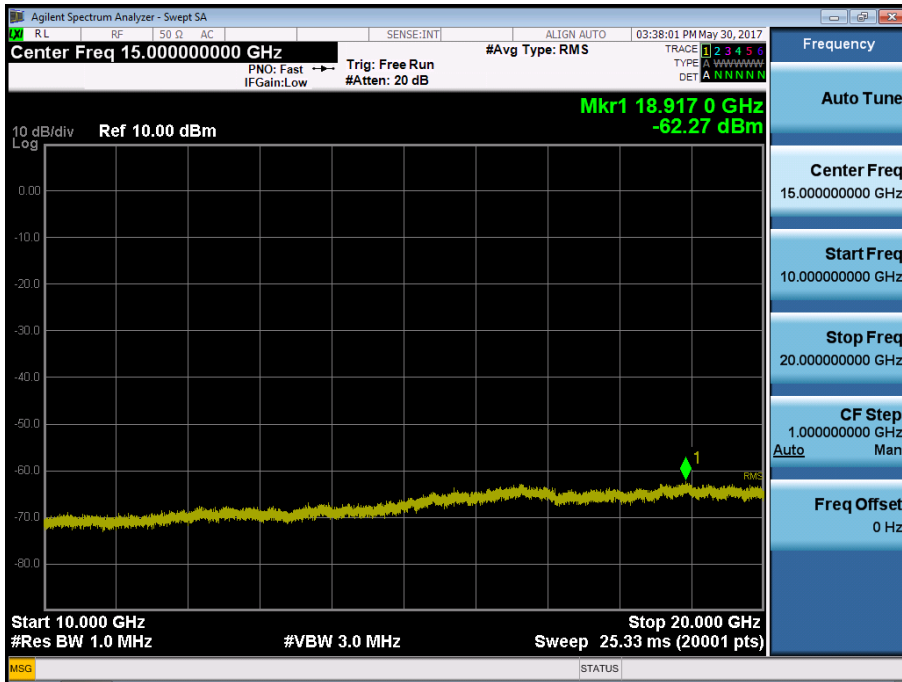

BAND 4. Conducted Spurious Plot_1 (20025ch_15MHz_QPSK_RB 1_0)

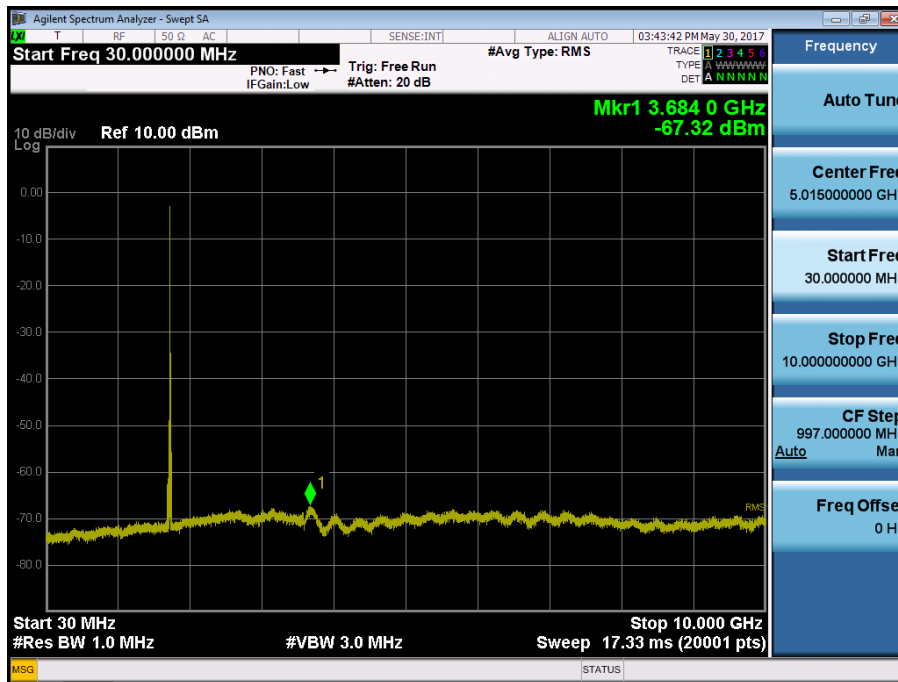

BAND 4. Conducted Spurious Plot_2 (20025ch_15MHz_QPSK_RB 1_0)

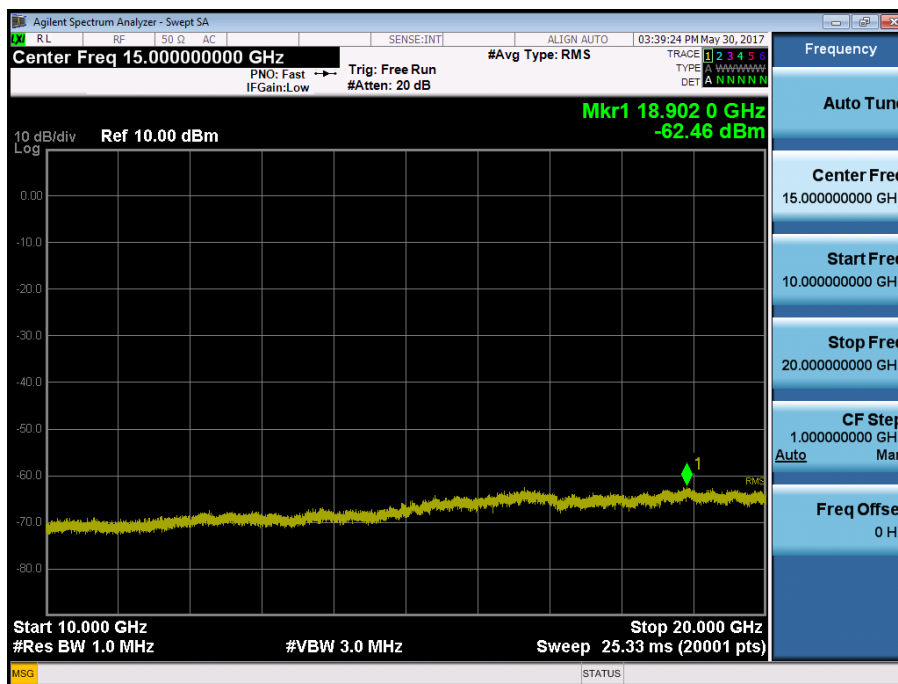

BAND 4. Conducted Spurious Plot_1 (20175ch_15MHz_QPSK_RB 1_0)

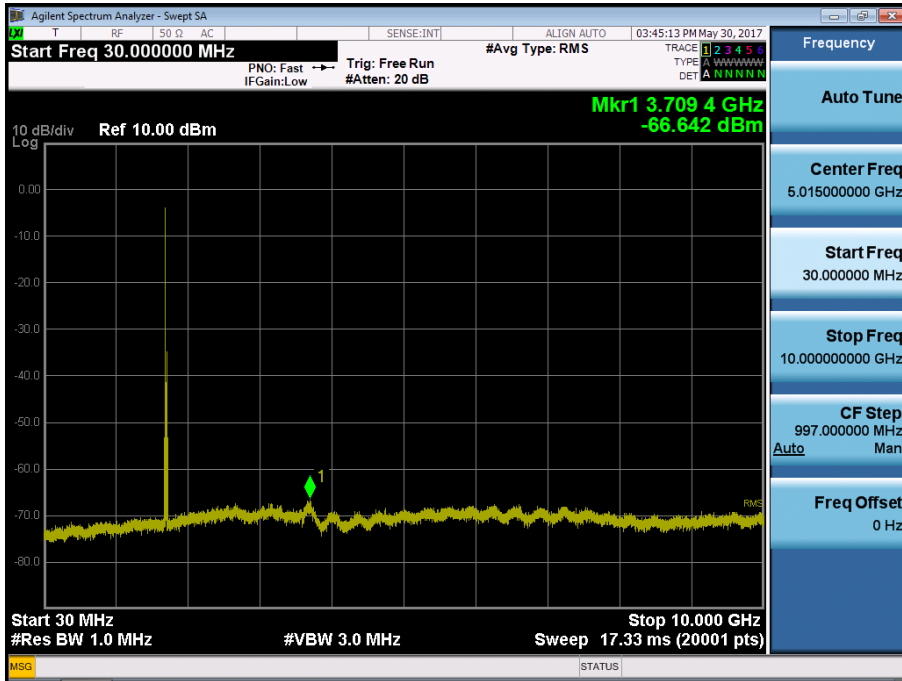

BAND 4. Conducted Spurious Plot_2 (20175ch_15MHz_QPSK_RB 1_0)



BAND 4. Conducted Spurious Plot_1 (20325ch_15MHz_QPSK_RB 1_0)

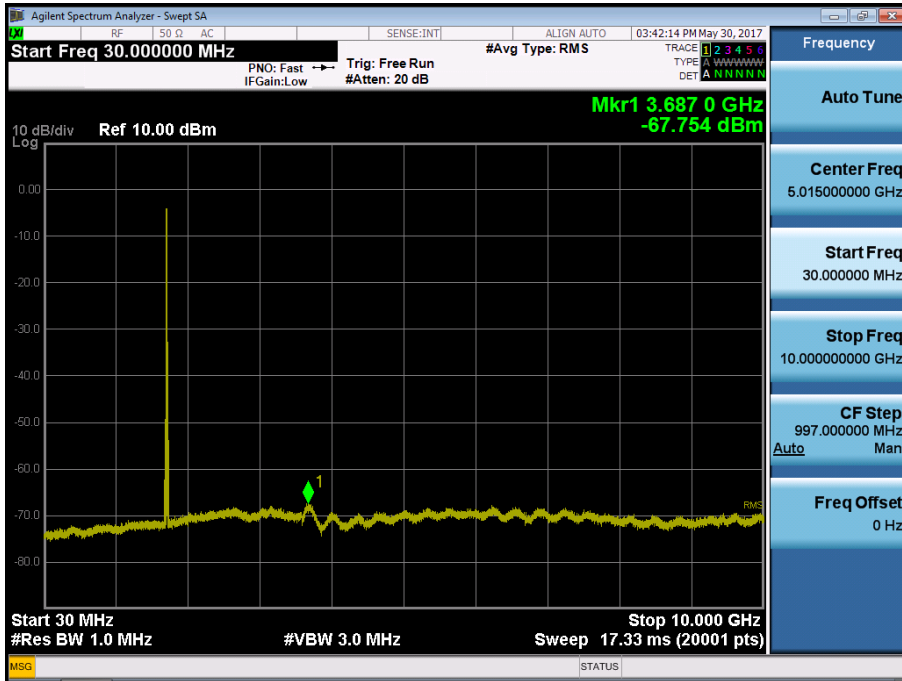

BAND 4. Conducted Spurious Plot_2 (20325ch_15MHz_QPSK_RB 1_0)

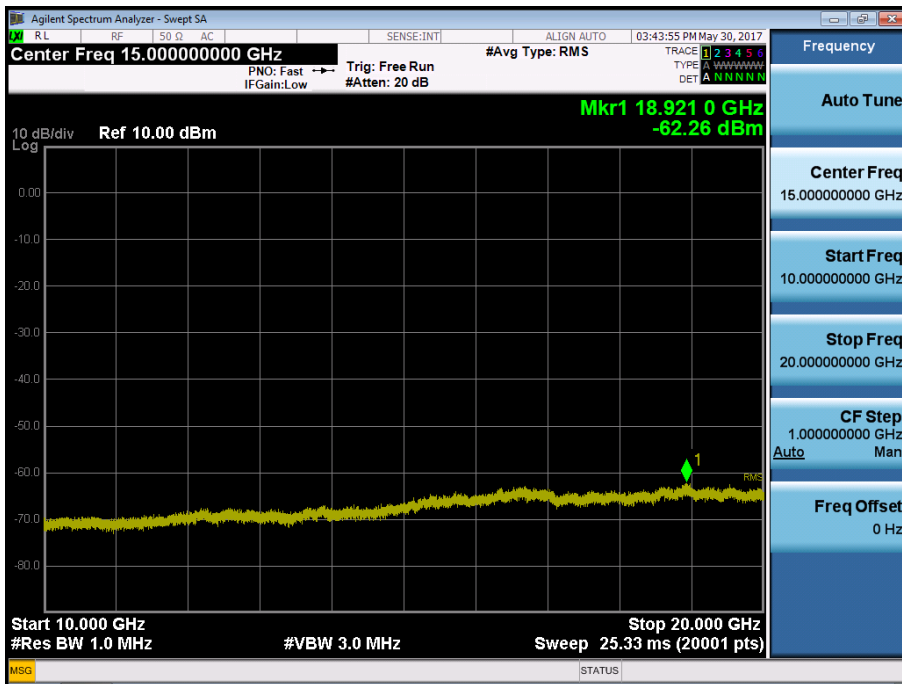

BAND 4. Conducted Spurious Plot_1 (20050ch_20MHz_QPSK_RB 1_0)

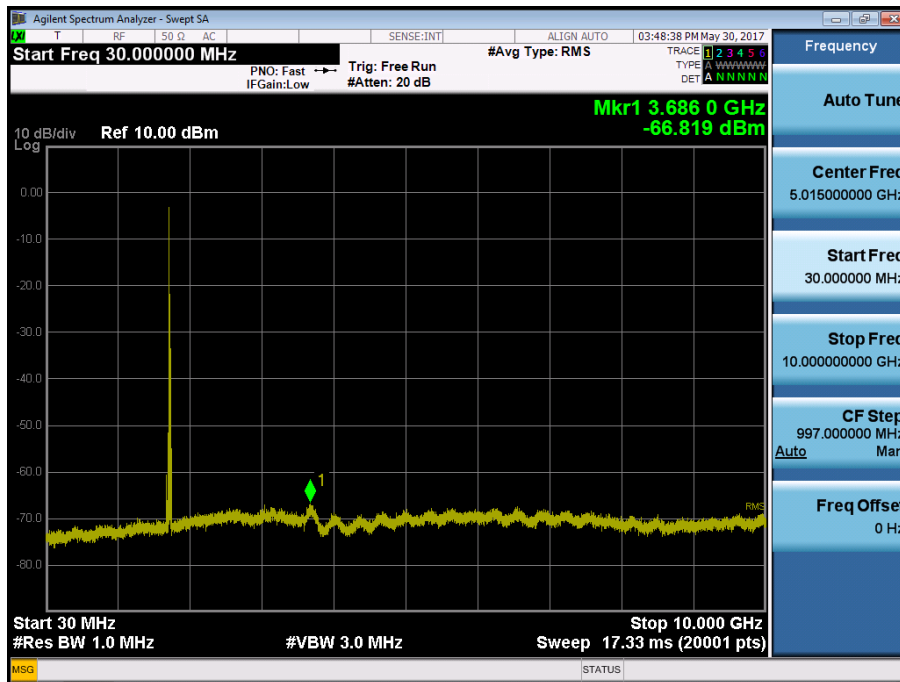

BAND 4. Conducted Spurious Plot_2 (20050ch_20MHz_QPSK_RB 1_0)

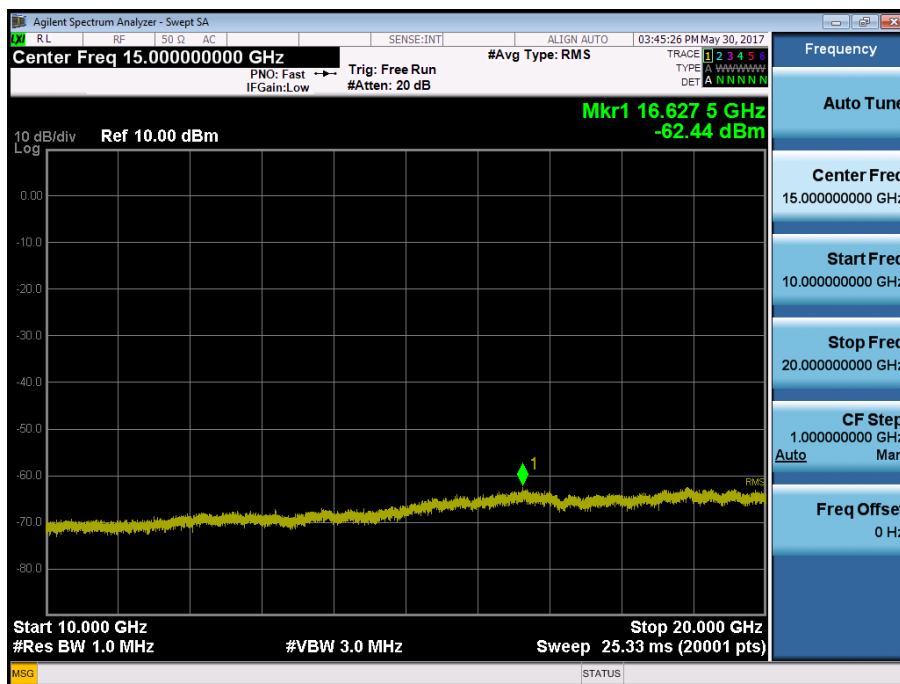

BAND 4. Conducted Spurious Plot_1 (20175ch_20MHz_QPSK_RB 1_0)

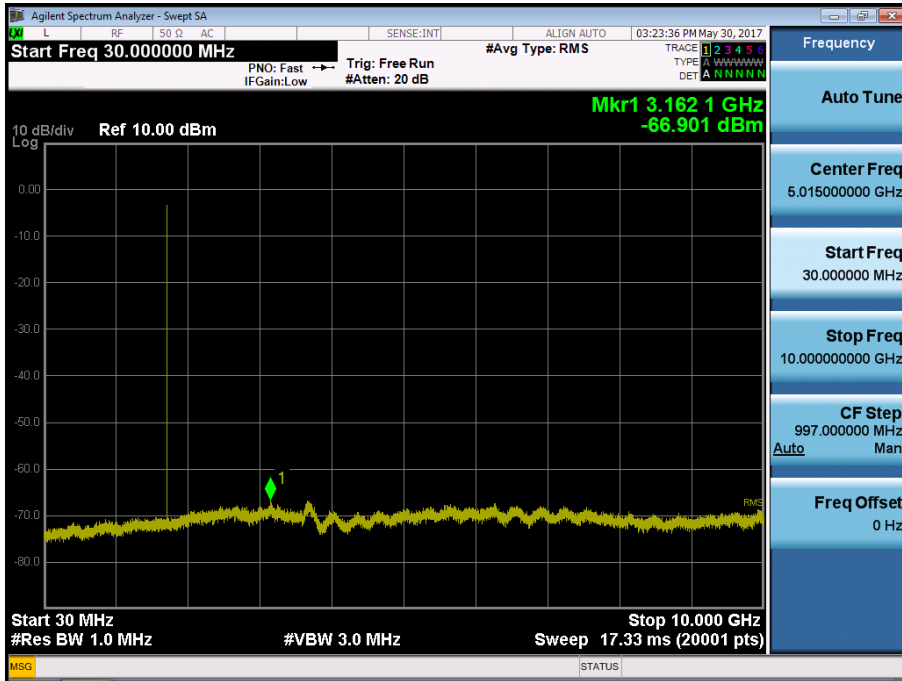

BAND 4. Conducted Spurious Plot_2 (20175ch_20MHz_QPSK_RB 1_0)

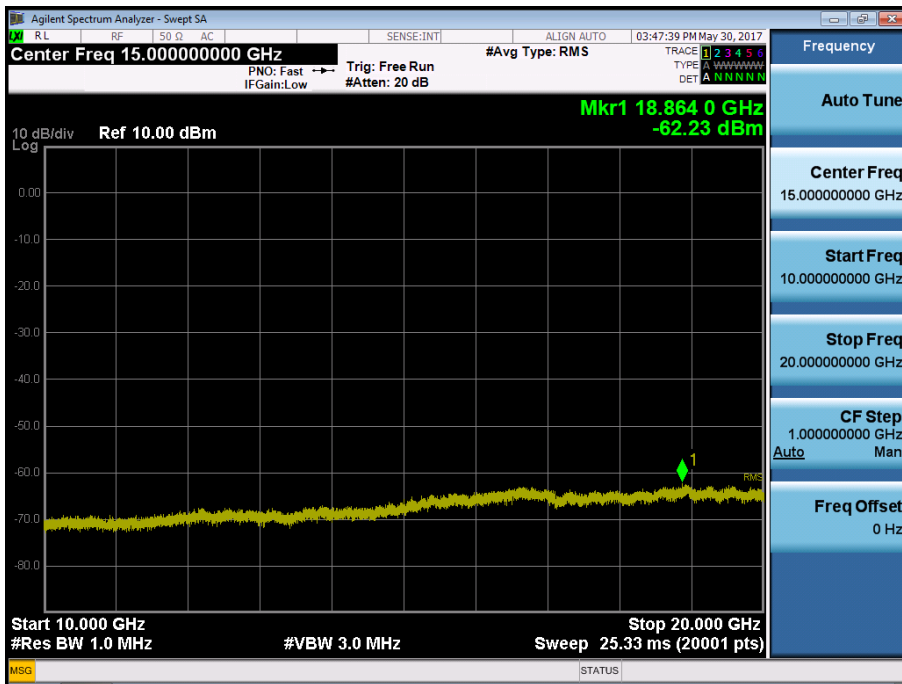

BAND 4. Conducted Spurious Plot_1 (20300ch_20MHz_QPSK_RB 1_0)

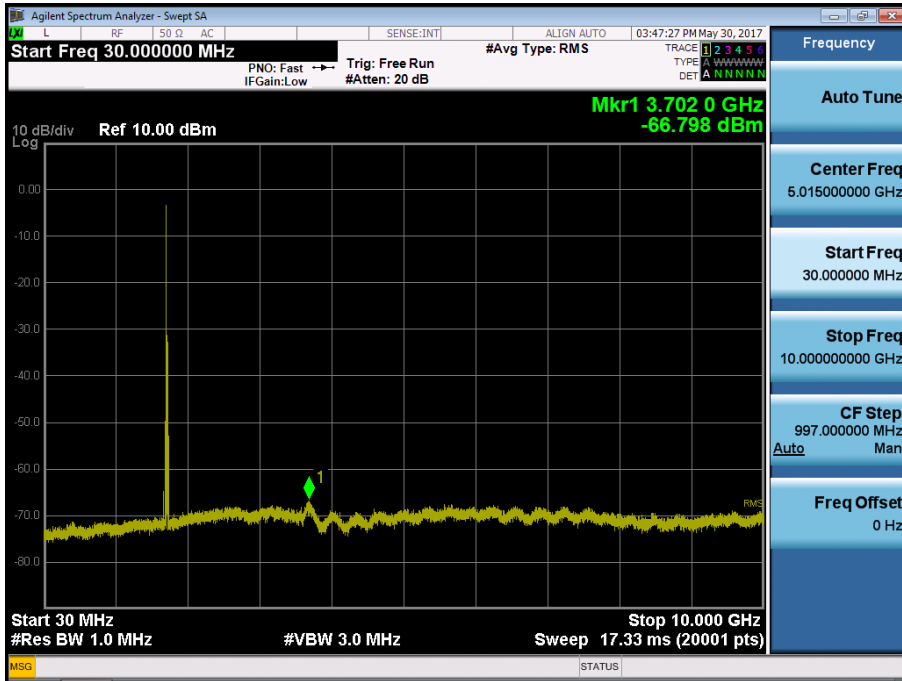

BAND 4. Conducted Spurious Plot_2 (20300ch_20MHz_QPSK_RB 1_0)

