

FCC LTE REPORT

FCC Certification

Applicant Name:
LG Electronics MobileComm U.S.A., Inc.

Date of Issue:
June 07, 2017

Address:
1000 Sylvan Avenue, Englewood Cliffs NJ 07632

Location:
HCT CO., LTD.,
74, Seoicheon-ro 578beon-gil, Majang-myeon,
Icheon-si, Gyeonggi-do, 17383, Rep. of KOREA

Report No.: HCT-R-1705-F024-1
HCT FRN: 0005866421

FCC ID: ZNFM700H

APPLICANT: LG Electronics MobileComm U.S.A., Inc.

FCC Model(s): LG-M700H

Additional FCC Model(s): LGM700H, M700H

EUT Type: GSM/WCDMA/LTE Phone with Bluetooth4.2LE, WIFI802.11 b/g/n

FCC Classification: Licensed Portable Transmitter Held to Ear (PCE)

FCC Rule Part(s): §22,§24, §2

| Mode (MHz) | Tx Frequency (MHz) | Emission Designator | Modulation | EIRP | |
|-------------------|-----------------------|------------------------|------------|-------------------|---------------------|
| | | | | Max. Power (W) | Max. Power (dBm) |
| LTE – Band2 (1.4) | 1850.7 - 1909.3 | 1M09G7D | QPSK | 0.096 | 19.83 |
| | | 1M10W7D | 16QAM | 0.073 | 18.62 |
| LTE – Band2 (3) | 1851.5 - 1908.5 | 2M70G7D | QPSK | 0.096 | 19.84 |
| | | 2M70W7D | 16QAM | 0.080 | 19.03 |
| LTE – Band2 (5) | 1852.5 - 1907.5 | 4M50G7D | QPSK | 0.092 | 19.63 |
| | | 4M49W7D | 16QAM | 0.073 | 18.63 |
| LTE – Band2 (10) | 1855.0 - 1905.0 | 8M97G7D | QPSK | 0.092 | 19.62 |
| | | 8M94W7D | 16QAM | 0.073 | 18.66 |
| LTE – Band2 (15) | 1857.5 - 1902.5 | 13M4G7D | QPSK | 0.095 | 19.79 |
| | | 13M4W7D | 16QAM | 0.071 | 18.53 |
| LTE – Band2 (20) | 1860.0 - 1900.0 | 17M9G7D | QPSK | 0.099 | 19.96 |
| | | 17M9W7D | 16QAM | 0.072 | 18.59 |

| Mode (MHz) | Tx Frequency (MHz) | Emission Designator | Modulation | ERP | |
|-------------------|-----------------------|------------------------|------------|-------------------|---------------------|
| | | | | Max. Power (W) | Max. Power (dBm) |
| LTE – Band5 (1.4) | 824.7 – 848.3 | 1M10G7D | QPSK | 0.056 | 17.46 |
| | | 1M10W7D | 16QAM | 0.042 | 16.28 |
| LTE – Band5 (3) | 825.5 – 847.5 | 2M71G7D | QPSK | 0.055 | 17.39 |
| | | 2M70W7D | 16QAM | 0.043 | 16.32 |
| LTE – Band5 (5) | 826.5 – 846.5 | 4M50G7D | QPSK | 0.054 | 17.35 |
| | | 4M49W7D | 16QAM | 0.041 | 16.09 |
| LTE – Band5 (10) | 829.0 – 844.0 | 8M96G7D | QPSK | 0.056 | 17.45 |
| | | 8M93W7D | 16QAM | 0.043 | 16.36 |

The measurements shown in this report were made in accordance with the procedures specified in CFR47 section §2.947. I assume full responsibility for the accuracy and completeness of these measurements, and for the qualifications of all persons taking them.

HCT CO., LTD. Certifies that no party to this application has subject to a denial of Federal benefits that includes FCC benefits pursuant to section 5301 of the Anti-Drug Abuse Act of 1998, 21 U.S. C.853(a)



Report prepared by : Jeong Ho Kim
Engineer of Telecommunication Testing Center



Report approved by : Jong Seok Lee
Manager of Telecommunication Testing Center

This report only responds to the tested sample and may not be reproduced, except in full, without written approval of the HCT Co., Ltd.

Version

| TEST REPORT NO. | DATE | DESCRIPTION |
|-------------------|---------------|------------------------------------------------------------------------------------------------------------------------------------|
| HCT-R-1705-F024 | May 29, 2017 | - First Approval Report |
| HCT-R-1705-F024-1 | June 07, 2017 | - Revised the conducted spurious emission results (LTE Band 2, 1.4 MHz BW, mid-channel) - Equipment List revised Page on 16. |
| | | |
| | | |

Table of Contents

| | |
|-------------------------------------------------------------------|----|
| 1. GENERAL INFORMATION | 6 |
| 2. INTRODUCTION | 8 |
| 2.1. EUT DESCRIPTION..... | 8 |
| 2.2. MEASURING INSTRUMENT CALIBRATION..... | 8 |
| 2.3. TEST FACILITY | 8 |
| 3. DESCRIPTION OF TESTS..... | 9 |
| 3.1 ERP/ EIRP RADIATED POWER AND RADIATED SPURIOUS EMISSIONS..... | 9 |
| 3.2 FREQUENCY RANGE | 10 |
| 3.3 PEAK-AVERAGE RATIO. | 11 |
| 3.4 OCCUPIED BANDWIDTH. | 13 |
| 3.5 SPURIOUS AND HARMONIC EMISSIONS AT ANTENNA TERMINAL..... | 14 |
| 3.6 FREQUENCY STABILITY / VARIATION OF AMBIENT TEMPERATURE | 15 |
| 4. LIST OF TEST EQUIPMENT | 16 |
| 5. MEASUREMENT UNCERTAINTY | 17 |
| 6. SUMMARY OF TEST RESULTS | 18 |
| 7. SAMPLE CALCULATION..... | 19 |
| 8. TEST DATA | 20 |
| 8.1 EQUIVALENT ISOTROPIC RADIATED POWER (Band 2) | 20 |
| 8.2 EFFECTIVE RADIATED POWER (Band 5)..... | 24 |
| 8.3 RADIATED SPURIOUS EMISSIONS | 26 |
| 8.3.1 RADIATED SPURIOUS EMISSIONS (1.4 MHz Band 2 LTE)..... | 26 |
| 8.3.2 RADIATED SPURIOUS EMISSIONS (3 MHz Band 2 LTE)..... | 27 |
| 8.3.3 RADIATED SPURIOUS EMISSIONS (5 MHz Band 2 LTE)..... | 28 |
| 8.3.4 RADIATED SPURIOUS EMISSIONS (10 MHz Band 2 LTE)..... | 29 |
| 8.3.5 RADIATED SPURIOUS EMISSIONS (15 MHz Band 2 LTE)..... | 30 |
| 8.3.6 RADIATED SPURIOUS EMISSIONS (20 MHz Band 2 LTE)..... | 31 |
| 8.3.7 RADIATED SPURIOUS EMISSIONS (1.4 MHz Band 5 LTE)..... | 32 |
| 8.3.8 RADIATED SPURIOUS EMISSIONS (3 MHz Band 5 LTE)..... | 33 |
| 8.3.9 RADIATED SPURIOUS EMISSIONS (5 MHz Band 5 LTE)..... | 34 |
| 8.3.10 RADIATED SPURIOUS EMISSIONS (10 MHz Band 5 LTE)..... | 35 |
| 8.4 PEAK-TO-AVERAGE RATIO | 36 |
| 8.5 OCCUPIED BANDWIDTH | 37 |
| 8.6 CONDUCTED SPURIOUS EMISSIONS | 38 |
| 8.6.1 BAND EDGE..... | 39 |
| 8.7 FREQUENCY STABILITY / VARIATION OF AMBIENT TEMPERATURE | 40 |

| | |
|------------------------------------------------------|----|
| 8.7.1 FREQUENCY STABILITY (1.4 MHz Band 2 LTE) | 40 |
| 8.7.2 FREQUENCY STABILITY (3 MHz Band 2 LTE) | 41 |
| 8.7.3 FREQUENCY STABILITY (5 MHz Band 2 LTE) | 42 |
| 8.7.4 FREQUENCY STABILITY (10 MHz Band 2 LTE) | 43 |
| 8.7.5 FREQUENCY STABILITY (15 MHz Band 2 LTE) | 44 |
| 8.7.6 FREQUENCY STABILITY (20 MHz Band 2 LTE) | 45 |
| 8.7.7 FREQUENCY STABILITY (1.4 MHz Band 5 LTE) | 46 |
| 8.7.8 FREQUENCY STABILITY (3 MHz Band 5 LTE) | 47 |
| 8.7.9 FREQUENCY STABILITY (5 MHz Band 5 LTE) | 48 |
| 8.7.10 FREQUENCY STABILITY (10 MHz Band 5 LTE) | 49 |
| 9. TEST PLOTS..... | 50 |

MEASUREMENT REPORT

1. GENERAL INFORMATION

Applicant Name: LG Electronics MobileComm U.S.A., Inc.

Address: 1000 Sylvan Avenue, Englewood Cliffs NJ 07632

FCC ID: ZNFM700H

Application Type: Certification

FCC Classification: Licensed Portable Transmitter Held to Ear (PCE)

FCC Rule Part(s): §22,§24, §2

EUT Type: GSM/WCDMA/LTE Phone with Bluetooth4.2LE, WIFI802.11 b/g/n

FCC Model(s): LG-M700H

Additional FCC Model(s): LGM700H, M700H

Tx Frequency: 1850.7 MHz – 1909.3 MHz (LTE – Band2 (1.4 MHz))
1851.5 MHz – 1908.5 MHz (LTE – Band2 (3 MHz))
1852.5 MHz – 1907.5 MHz (LTE – Band2 (5 MHz))
1855.0 MHz – 1905.0 MHz (LTE – Band2 (10 MHz))
1857.5 MHz – 1902.5 MHz (LTE – Band2 (15 MHz))
1860.0 MHz – 1900.0 MHz (LTE – Band2 (20 MHz))

824.7 MHz – 848.3 MHz (LTE – Band 5 (1.4 MHz))
825.5 MHz – 847.5 MHz (LTE – Band 5 (3 MHz))
826.5 MHz – 846.5 MHz (LTE – Band 5 (5 MHz))
829.0 MHz – 844.0 MHz (LTE – Band 5 (10 MHz))

Max. RF Output Power:

| | |
|--------------------|------------------------------|
| Band 2 (1.4 MHz) : | 0.096 W (QPSK) (19.83 dBm) |
| | 0.073 W (16-QAM) (18.62 dBm) |
| Band 2 (3 MHz) : | 0.096 W (QPSK) (19.84 dBm) |
| | 0.080 W (16-QAM) (19.03 dBm) |
| Band 2 (5 MHz) : | 0.092 W (QPSK) (19.63 dBm) |
| | 0.073 W (16-QAM) (18.63 dBm) |
| Band 2 (10 MHz) : | 0.092 W (QPSK) (19.62 dBm) |
| | 0.073 W (16-QAM) (18.66 dBm) |
| Band 2 (15 MHz) : | 0.095 W (QPSK) (19.79 dBm) |
| | 0.071 W (16-QAM) (18.53 dBm) |
| Band 2 (20 MHz) : | 0.099 W (QPSK) (19.96 dBm) |
| | 0.072 W (16-QAM) (18.59 dBm) |
| Band 5 (1.4 MHz) : | 0.056 W (QPSK) (17.46 dBm) |
| | 0.042 W (16-QAM) (16.28 dBm) |
| Band 5 (3 MHz) : | 0.055 W (QPSK) (17.39 dBm) |
| | 0.043 W (16-QAM) (16.32 dBm) |
| Band 5 (5 MHz) : | 0.054 W (QPSK) (17.35 dBm) |
| | 0.041 W (16-QAM) (16.09 dBm) |
| Band 5 (10 MHz) : | 0.056 W (QPSK) (17.45 dBm) |
| | 0.043 W (16-QAM) (16.36 dBm) |

| | | |
|--------------------------------|-----------------------------------|-----------------------------------|
| Emission Designator(s): | Band 2 (1.4 MHz) : | 1M09G7D (QPSK) / 1M10W7D (16-QAM) |
| | Band 2 (3 MHz) | 2M70G7D (QPSK) / 2M70W7D (16-QAM) |
| | Band 2 (5 MHz) : | 4M50G7D (QPSK) / 4M49W7D (16-QAM) |
| | Band 2 (10 MHz) | 8M97G7D (QPSK) / 8M94W7D (16-QAM) |
| | Band 2 (15 MHz) : | 13M4G7D (QPSK) / 13M4W7D (16-QAM) |
| | Band 2 (20 MHz) | 17M9G7D (QPSK) / 17M9W7D (16-QAM) |
| | | |
| | Band 5 (1.4 MHz) : | 1M10G7D (QPSK) / 1M10W7D (16-QAM) |
| | Band 5 (3 MHz) : | 2M71G7D (QPSK) / 2M70W7D (16-QAM) |
| | Band 5 (5 MHz) : | 4M50G7D (QPSK) / 4M49W7D (16-QAM) |
| Band 5 (10 MHz) : | 8M96G7D (QPSK) / 8M93W7D (16-QAM) | |

Date(s) of Tests: April 25, 2017 ~ May 29, 2017

Antenna Specification: Manufacturer: LS Mtron Co. Ltd.
Antenna type: PIFA Antenna (Planar Inverted F)

2. INTRODUCTION

2.1. EUT DESCRIPTION

The LG Electronics MobileComm U.S.A., Inc. LG-M700H GSM/WCDMA/LTE Phone with Bluetooth4.2LE, WIFI802.11 b/g/n consists of LTE 2 and 5.

2.2. MEASURING INSTRUMENT CALIBRATION

The measuring equipment, which was utilized in performing the tests documented herein, has been calibrated in accordance with the manufacturer's recommendations for utilizing calibration equipment, which is traceable to recognized national standards.

2.3. TEST FACILITY

The Fully-anechoic chamber and conducted measurement facility used to collect the radiated data are located at the **74, Seoicheon-ro 578beon-gil, Majang-myeon, Icheon-si, Gyeonggi-do, 17383, Rep. of KOREA.**

3. DESCRIPTION OF TESTS

3.1 ERP/ EIRP RADIATED POWER AND RADIATED SPURIOUS EMISSIONS

Note: ERP(Effective Radiated Power), EIRP(Effective Isotropic Radiated Power)

Test Procedure

Radiated emission measurements are performed in the Fully-anechoic chamber. The equipment under test is placed on a non-conductive table 3-meters away from the receive antenna in accordance with ANSI/TIA-603-D-2010 Clause 2.2.17. The turntable is rotated through 360 degrees, and the receiving antenna scans in order to determine the level of the maximized emission. The level and position of the maximized emission is recorded with the spectrum analyzer using a RMS detector.

A half wave dipole is then substituted in place of the EUT. For emissions above 1GHz, a horn antenna is substituted in place of the EUT. The substitute antenna is driven by a signal generator and the previously recorded signal was duplicated.

The power is calculated by the following formula;

$$P_{d(\text{dBm})} = P_{g(\text{dBm})} - \text{cable loss (dB)} + \text{antenna gain (dB)}$$

Where: P_d is the dipole equivalent power and P_g is the generator output power into the substitution antenna.

The maximum EIRP is calculated by adding the forward power to the calibrated source plus its appropriate gain value. These steps are repeated with the receiving antenna in both vertical and horizontal polarization. the difference between the gain of the horn and an isotropic antenna are taken into consideration

Radiated spurious emissions

: Frequency Range : 9 kHz ~ 10th Harmonics of highest channel fundamental frequency.

3.2 FREQUENCY RANGE

§ 24.229: PCS – Mobile Frequency Blocks

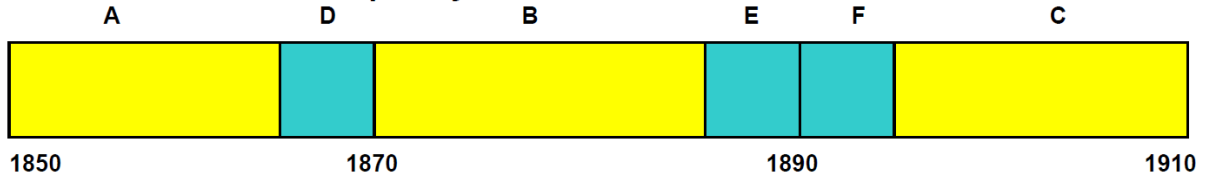

- | | |
|-------------------------------------|-------------------------------------|
| BLOCK 1: 1850 – 1865 MHz (A) | BLOCK 4: 1885 – 1890 MHz (E) |
| BLOCK 2: 1865 – 1870 MHz (D) | BLOCK 5: 1890 – 1895 MHz (F) |
| BLOCK 3: 1870 – 1885 MHz (B) | BLOCK 6: 1895 – 1910 MHz (C) |

§22.917(a): Cellular – Mobile Frequency Blocks

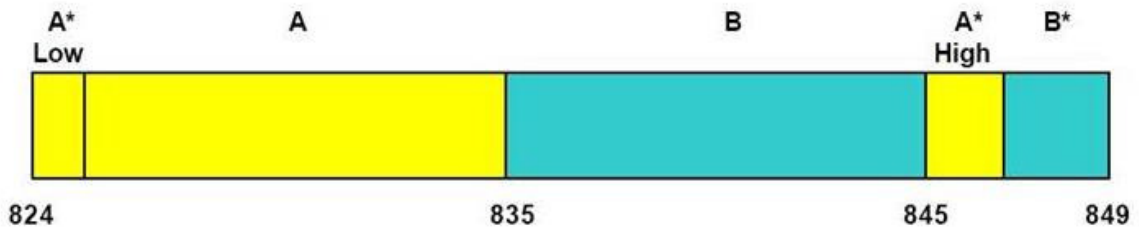

- | | |
|--------------------------------------------|-------------------------------------------|
| BLOCK 1: 824 – 835 MHz (A* Low + A) | BLOCK 3: 845 – 846.5 MHz (A* High) |
| BLOCK 2: 835 – 845 MHz (B) | BLOCK 4: 846.5 – 849 MHz (B*) |

3.3 PEAK-AVERAGE RATIO.

Test Procedure

Peak to Average Power Ratio is tested in accordance with KDB971168 D01 Power Meas License Digital Systems v02r02, October 17, 2014, Section 5.7.

- Section 5.7.1 CCDF Procedure

- a) Set resolution/measurement bandwidth \geq signal's occupied bandwidth;
- b) Set the number of counts to a value that stabilizes the measured CCDF curve;
- c) Set the measurement interval as follows:
 - 1) for continuous transmissions, set to 1 ms,
 - 2) for burst transmissions, employ an external trigger that is synchronized with the EUT burst timing sequence, or use the internal burst trigger with a trigger level that allows the burst to stabilize and set the measurement interval to a time that is less than or equal to the burst duration.
- d) Record the maximum PAPR level associated with a probability of 0.1%.

- Section 5.7.2 Alternate Procedure

Use one of the procedures presented in 5.1 to measure the total peak power and record as P_{Pk} . Use one of the applicable procedures presented 5.2 to measure the total average power and record as P_{Avg} . Determine the P.A.R. from: $P.A.R._{(dB)} = P_{Pk} \text{ (dBm)} - P_{Avg} \text{ (dBm)}$ (P_{Avg} = Average Power + Duty cycle Factor)

5.1.1 Peak power measurements with a spectrum/signal analyzer or EMI receiver

The following procedure can be used to determine the total peak output power.

- a) Set the RBW \geq OBW.
- b) Set VBW $\geq 3 \times$ RBW.
- c) Set span $\geq 2 \times$ RBW
- d) Sweep time = auto couple.
- e) Detector = peak.
- f) Ensure that the number of measurement points \geq span/RBW.
- g) Trace mode = max hold.
- h) Allow trace to fully stabilize.
- i) Use the peak marker function to determine the peak amplitude level.

5.2.2 Procedures for use with a spectrum/signal analyzer when EUT cannot be configured to transmit continuously and sweep triggering/signal gating cannot be properly implemented

If the EUT cannot be configured to transmit continuously (burst duty cycle < 98%), then one of the following procedures can be used. The selection of the applicable procedure will depend on the characteristics of the measured burst duty cycle.

Measure the burst duty cycle with a spectrum/signal analyzer or EMC receiver can be used in zero-span mode if the response time and spacing between bins on the sweep are sufficient to permit accurate measurement of the burst on/off time of the transmitted signal.

5.2.2.2 Constant burst duty cycle

If the measured burst duty cycle is constant (i.e., duty cycle variations are less than ± 2 percent), then:

- a) Set span to at least 1.5 times the OBW.
- b) Set RBW = 1-5% of the OBW, not to exceed 1 MHz.
- c) Set VBW $\geq 3 \times$ RBW.
- d) Number of points in sweep $\geq 2 \times$ span / RBW. (This gives bin-to-bin spacing \leq RBW/2, so that narrowband signals are not lost between frequency bins.)
- e) Sweep time = auto.
- f) Detector = RMS (power averaging).
- g) Set sweep trigger to "free run".
- h) Trace average at least 100 traces in power averaging (i.e., RMS) mode.
- i) Compute power by integrating the spectrum across the OBW of the signal using the instrument's band power measurement function with band limits set equal to the OBW band edges. If the instrument does not have a band power function, sum the spectrum levels (in power units) at intervals equal to the RBW extending across the entire OBW of the spectrum.
- j) Add $10 \log (1/x)$, where x is the duty cycle, to the measured power in order to compute the average power during the actual transmission times (because the measurement represents an average over both the on and off times of the transmission).

For example, add $10 \log (1/0.25) = 6$ dB if the duty cycle is a constant 25%.

3.4 OCCUPIED BANDWIDTH.

Test set-up

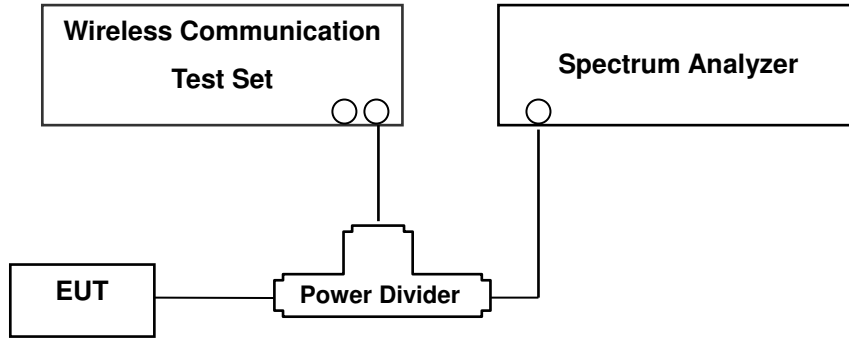

(Configuration of conducted Emission measurement)

The width of a frequency band such that, below the lower and above the upper frequency limits, the mean powers emitted are each equal to a specified percentage 0.5 % of the total mean power of a given emission.

Test Procedure

OBW is tested in accordance with KDB971168 D01 Power Meas License Digital Systems v02r02, October 17, 2014, Section 4.2.

The EUT makes a call to the communication simulator. The power was measured with R&S Spectrum Analyzer. All measurements were done at 3 channels(low, middle and high operational range.)

The conducted occupied bandwidth used the power splitter via EUT RF power connector between simulation base station and spectrum analyzer.

The communication simulator station system controlled a EUT to export maximum output power under transmission mode and specific channel frequency. Use OBW measurement function of Spectrum analyzer to measure 99 % occupied bandwidth

3.5 SPURIOUS AND HARMONIC EMISSIONS AT ANTENNA TERMINAL.

Test Procedure

Spurious and harmonic emissions at antenna terminal is tested in accordance with KDB971168 D01 Power Meas License Digital Systems v02r02, October 17, 2014, Section 6.0.

The level of the carrier and the various conducted spurious and harmonic frequencies is measured by means of a calibrated spectrum analyzer.

The EUT was setup to maximum output power at its lowest channel. The Resolution BW of the analyzer is set to 1 % of the emission bandwidth to show compliance with the -13 dBm limit, in the 1 MHz bands immediately outside and adjacent to the edge of the frequency block. The 1 MHz RBW was used to scan from 30 MHz to 10th Harmonics. A display line was placed at -13 dBm to show compliance. The high, lowest and a middle channel were tested for out of band measurements.

- Band Edge Requirement : In the 1MHz bands immediately outside and adjacent to the frequency block, a resolution bandwidth of at least 1 percent of the emission bandwidth of the fundamental emission of the transmitter may be employed to measure the out of band Emissions. Limit, -13dBm.

NOTES: The analyzer plot offsets were determined by below conditions.

- For LTE Band 2, total offset 27.1dBm = 20 dBm attenuator + 6 dBm Divider + 1.1 dBm RF cables.
- For LTE Band 5, total offset 26.8dBm = 20 dBm attenuator + 6 dBm Divider + 0.8 dBm RF cables.

3.6 FREQUENCY STABILITY / VARIATION OF AMBIENT TEMPERATURE

Test Set-up

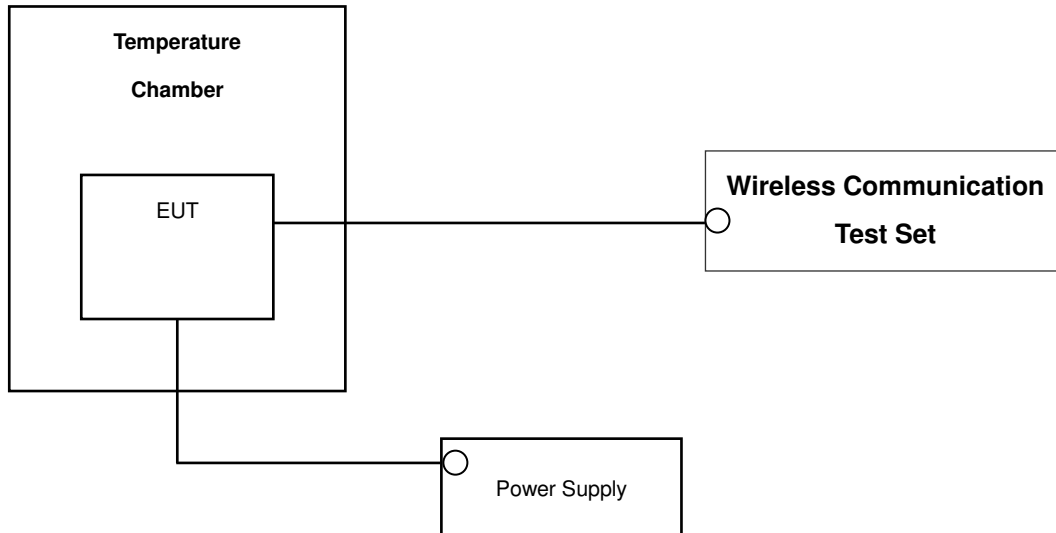

* Nominal Operating Voltage

Test Procedure

Frequency stability is tested in accordance with ANSI/TIA-603-D-2010 section 2.2.2

The frequency stability of the transmitter is measured by:

- a.) **Temperature:** The temperature is varied from - 30 °C to + 50 °C using an environmental chamber.
- b.) **Primary Supply Voltage:** The primary supply voltage is varied from the end point to 100 % of the voltage normally at the input to the device or at the power supply terminals if cables are not normally supplied.

Specification — the frequency stability shall be sufficient to ensure that the fundamental emission stays within the authorized frequency block(LTE Band2).The frequency stability of the transmitter shall be maintained within $\pm 0.00025\%$ (± 2.5 ppm) of the center frequency. (LTE Band5).

Time Period and Procedure:

The carrier frequency of the transmitter is measured at room temperature (20°C to provide a reference).

1. The equipment is turned on in a “standby” condition for one minute before applying power to the transmitter. Measurement of the carrier frequency of the transmitter is made within one minute after applying power to the transmitter.
2. Frequency measurements are made at 10°C intervals ranging from -30°C to +50°C. A period of at least one half-hour is provided to allow stabilization of the equipment at each temperature level.

NOTE: The EUT is tested down to the battery endpoint.

4. LIST OF TEST EQUIPMENT

| Manufacture | Model/ Equipment | Serial Number | Calibration Date | Calibration Interval | Calibration Due |
|------------------|---------------------------------------------|------------------------|------------------|----------------------|-----------------|
| REOHDE & SCHWARZ | SCU 18 / AMPLIFIER | 10094 | 04/24/2017 | Annual | 04/24/2018 |
| Wainwright | WHK1.2/15G-10EF/H.P.F | 4 | 04/10/2017 | Annual | 04/10/2018 |
| Wainwright | WHK3.3/18G-10EF/H.P.F | 2 | 04/10/2017 | Annual | 04/10/2018 |
| Hewlett Packard | 11667B / Power Splitter | 10545 | 02/15/2017 | Annual | 02/15/2018 |
| Hewlett Packard | 11667B / Power Splitter | 11275 | 05/04/2017 | Annual | 05/04/2018 |
| Agilent | E3632A/DC Power Supply | KR75303243 | 07/12/2016 | Annual | 07/12/2017 |
| Schwarzbeck | UHAP/ Dipole Antenna | 557 | 03/31/2017 | Biennial | 03/31/2019 |
| Schwarzbeck | UHAP/ Dipole Antenna | 558 | 03/31/2017 | Biennial | 03/31/2019 |
| EXP | EX-TH400/ Chamber | None | 05/31/2016 | Annual | 05/31/2017 |
| Schwarzbeck | BBHA 9120D/ Horn Antenna | 147 | 09/09/2016 | Biennial | 09/09/2018 |
| Schwarzbeck | BBHA 9120D/ Horn Antenna | 1298 | 10/14/2016 | Biennial | 10/14/2018 |
| Schwarzbeck | BBHA 9170/ Horn Antenna(15~40GHz) | BBHA9170342 | 04/25/2017 | Biennial | 04/25/2019 |
| Schwarzbeck | BBHA 9170/ Horn Antenna(15~40GHz) | BBHA9170124 | 04/25/2017 | Biennial | 04/25/2019 |
| Agilent | N9020A/Signal Analyzer | MY51110074 | 11/28/2016 | Annual | 11/28/2017 |
| Hewlett Packard | 8493C/ATTENUATOR | 17280 | 06/22/2016 | Annual | 06/22/2017 |
| REOHDE & SCHWARZ | FSV40/Spectrum Analyzer | 1307.9002K40-100931-NK | 06/15/2016 | Annual | 06/15/2017 |
| Agilent | 8960 (E5515C)/ Base Station | MY48360800 | 10/19/2016 | Annual | 10/19/2017 |
| Schwarzbeck | FMZB1513/ Loop Antenna(9kHz~30MHz) | 1513-175 | 04/06/2017 | Biennial | 04/06/2019 |
| Schwarzbeck | VULB9160/ Bilog Antenna | 3150 | 09/30/2016 | Biennial | 09/30/2018 |
| Schwarzbeck | VULB9160/ Bilog Antenna | 3368 | 10/14/2016 | Biennial | 10/14/2018 |
| REOHDE & SCHWARZ | ESU / EMI TEST RECEIVER | 100346 | 08/11/2017 | Annual | 08/11/2018 |
| Anritsu Corp. | MT8820C/Wideband Radio Communication Tester | 6200863156 | 02/15/2017 | Annual | 02/15/2018 |
| Anritsu Corp. | MT8820C/Wideband Radio Communication Tester | 6201026545 | 02/13/2017 | Annual | 02/13/2018 |
| Anritsu Corp. | MT8821C/Radio Communication Analyzer | 6201502997 | 08/04/2016 | Annual | 08/04/2017 |
| REOHDE & SCHWARZ | SMB100A/ SIGNAL GENERATOR (100kHz~40GHz) | 177633 | 07/18/2016 | Annual | 07/18/2017 |

5. MEASUREMENT UNCERTAINTY

The measurement uncertainties shown below were calculated in accordance with the requirements of ANSI C63.4:2014.

All measurement uncertainty values are shown with a coverage factor of $k = 2$ to indicate a 95 % level of confidence. The measurement data shown herein meets or exceeds the U_{CISPR} measurement uncertainty values specified in CISPR 16-4-2 and, thus, can be compared directly to specified limits to determine compliance.

| Parameter | Expanded Uncertainty (\pm dB) |
|------------------------------------------|----------------------------------|
| Conducted Disturbance (150 kHz ~ 30 MHz) | 1.82 |
| Radiated Disturbance (9 kHz ~ 30 MHz) | 3.40 |
| Radiated Disturbance (30 MHz ~ 1 GHz) | 4.80 |
| Radiated Disturbance (1 GHz ~ 18 GHz) | 6.07 |

6. SUMMARY OF TEST RESULTS

| FCC Part Section(s) | Test Description | Test Limit | Test Condition | Test Result |
|---------------------------------|------------------------------------------------------------------|--------------------------------------------------------------------------------------|----------------|-------------|
| 2.1049 | Occupied Bandwidth | N/A | CONDUCTED | PASS |
| 2.1051, 22.917(a), 24.238(a) | Band Edge / Spurious and Harmonic Emissions at Antenna Terminal. | < 43 + 10log ₁₀ (P[Watts]) at Band Edge and for all out-of-band emissions | | PASS |
| 2.1046 | * Conducted Output Power | N/A | | PASS |
| 24.232(d) | Peak- to- Average Ratio | < 13 dB | | PASS |
| 2.1055, 22.355 | Frequency stability / variation of ambient temperature | < 2.5 ppm (Part22) | | PASS |
| 24.235 | | Emission must remain in band (Part24) | | |
| 22.913(a)(2) | Effective Radiated Power (Band 5) | < 7 Watts max. ERP | RADIATED | PASS |
| 24.232(c) | Equivalent Isotropic Radiated Power (Band 2) | < 2 Watts max. EIRP | | PASS |
| 2.1053, 22.917(a), 24.238(a) | Radiated Spurious and Harmonic Emissions | < 43 + 10log ₁₀ (P[Watts]) for all out-of band emissions | | PASS |

*: See SAR Report

7. SAMPLE CALCULATION

A. ERP Sample Calculation

| Mode | Ch./ Freq. | | Measured Level(dBm) | Substitute LEVEL(dBm) | Ant. Gain (dBd) | C.L | Pol. | Limit W | ERP | |
|-----------|------------|------------|---------------------|-----------------------|-----------------|------|------|---------|-------|-------|
| | channel | Freq.(MHz) | | | | | | | W | dBm |
| LTE Band5 | 20525 | 836.50 | -30.11 | 32.45 | -10.54 | 1.32 | V | < 7.00 | 0.115 | 20.59 |

ERP = Substitute LEVEL(dBm) + Ant. Gain – CL(Cable Loss)

- 1) The EUT mounted on a wooden tripod is 2.5 meter above test site ground level.
- 2) During the test , the turn table is rotated until the maximum signal is found.
- 3) Record the field strength meter's level.
- 4) Replace the EUT with dipole/Horn antenna that is connected to a calibrated signal generator.
- 5) Increase the signal generator output till the field strength meter's level is equal to the item (3).
- 6) The signal generator output level with Ant. Gain and cable loss are the rating of effective radiated power(ERP).

B. Emission Designator

QPSK Modulation

5MHz Bandwidth

Emission Designator = 4M48G7D

LTE BW = 4.48 MHz

G = Phase Modulation

7 = Quantized/Digital Info

D = Data transmission; telemetry; telecommand

10MHz Bandwidth

Emission Designator = 8M95G7D

LTE BW = 8.95 MHz

G = Phase Modulation

7 = Quantized/Digital Info

D = Data transmission; telemetry; telecommand

16QAM Modulation

5MHz Bandwidth

Emission Designator = 4M48W7D

LTE BW = 4.48 MHz

W = main carrier modulated in a combination of two or more of the following modes;
amplitude, angle, pulse

7 = Quantized/Digital Info

D = Data transmission; telemetry; telecommand

10MHz Bandwidth

Emission Designator = 8M95W7D

LTE BW = 8.95 MHz

W = main carrier modulated in a combination of two or more of the following modes;
amplitude, angle, pulse

7 = Quantized/Digital Info

D = Data transmission; telemetry; telecommand

8. TEST DATA

8.1 EQUIVALENT ISOTROPIC RADIATED POWER (Band 2)

| Freq (MHz) | Bandwidth | Modulation | Measured Level (dBm) | Substitute Level (dBm) | Ant. Gain(dBi) | C.L | Pol | Limit | EIRP | |
|------------|-----------|------------|----------------------|------------------------|----------------|------|-----|--------|-------|-------|
| | | | | | | | | W | W | dBm |
| 1850.7 | 1.4 MHz | QPSK | -21.66 | 11.26 | 9.82 | 2.00 | H | < 2.00 | 0.081 | 19.08 |
| | | 16-QAM | -22.79 | 10.13 | 9.82 | 2.00 | H | | 0.062 | 17.95 |
| 1880.0 | | QPSK | -21.19 | 11.79 | 9.91 | 2.02 | H | | 0.093 | 19.68 |
| | | 16-QAM | -22.32 | 10.66 | 9.91 | 2.02 | H | | 0.072 | 18.55 |
| 1909.3 | | QPSK | -21.50 | 11.87 | 10.00 | 2.04 | H | | 0.096 | 19.83 |
| | | 16-QAM | -22.71 | 10.66 | 10.00 | 2.04 | H | | 0.073 | 18.62 |

Equivalent Isotropic Radiated Power Data (1.4 MHz Band 2 LTE)

Note: All of RB size has been tested for emissions and EIRP, with the 1RB configuration observed as the worst case

| Freq (MHz) | Bandwidth | Modulation | Measured Level (dBm) | Substitute Level (dBm) | Ant. Gain(dBi) | C.L | Pol | Limit | EIRP | |
|------------|-----------|------------|----------------------|------------------------|----------------|------|-----|--------|-------|-------|
| | | | | | | | | W | W | dBm |
| 1851.5 | 3 MHz | QPSK | -21.74 | 11.19 | 9.82 | 2.00 | H | < 2.00 | 0.080 | 19.01 |
| | | 16-QAM | -22.82 | 10.11 | 9.82 | 2.00 | H | | 0.062 | 17.93 |
| 1880.0 | | QPSK | -21.03 | 11.95 | 9.91 | 2.02 | H | | 0.096 | 19.84 |
| | | 16-QAM | -21.84 | 11.14 | 9.91 | 2.02 | H | | 0.080 | 19.03 |
| 1908.5 | | QPSK | -21.54 | 11.82 | 10.00 | 2.04 | H | | 0.095 | 19.78 |
| | | 16-QAM | -22.69 | 10.67 | 10.00 | 2.04 | H | | 0.073 | 18.63 |

Equivalent Isotropic Radiated Power Data (3 MHz Band 2 LTE)

Note: All of RB size has been tested for emissions and EIRP, with the 1RB configuration observed as the worst case

| Freq (MHz) | Bandwidth | Modulation | Measured Level (dBm) | Substitute Level (dBm) | Ant. Gain(dBi) | C.L | Pol | Limit | EIRP | |
|------------|-----------|------------|----------------------|------------------------|----------------|------|-----|--------|-------|-------|
| | | | | | | | | W | W | dBm |
| 1852.5 | 5 MHz | QPSK | -22.03 | 10.90 | 9.82 | 2.00 | H | < 2.00 | 0.074 | 18.72 |
| | | 16-QAM | -22.65 | 10.28 | 9.82 | 2.00 | H | | 0.065 | 18.10 |
| 1880.0 | | QPSK | -21.24 | 11.74 | 9.91 | 2.02 | H | | 0.092 | 19.63 |
| | | 16-QAM | -22.24 | 10.74 | 9.91 | 2.02 | H | | 0.073 | 18.63 |
| 1907.5 | | QPSK | -21.76 | 11.57 | 10.00 | 2.04 | H | | 0.090 | 19.53 |
| | | 16-QAM | -22.79 | 10.54 | 10.00 | 2.04 | H | | 0.071 | 18.50 |

Equivalent Isotropic Radiated Power Data (5 MHz Band 2 LTE)

Note: All of RB size has been tested for emissions and EIRP, with the 1RB configuration observed as the worst case

| Freq (MHz) | Bandwidth | Modulation | Measured Level (dBm) | Substitute Level (dBm) | Ant. Gain(dBi) | C.L | Pol | Limit | EIRP | |
|------------|-----------|------------|----------------------|------------------------|----------------|------|-----|--------|-------|-------|
| | | | | | | | | W | W | dBm |
| 1855.0 | 10 MHz | QPSK | -22.24 | 10.68 | 9.84 | 2.01 | H | < 2.00 | 0.071 | 18.51 |
| | | 16-QAM | -22.86 | 10.06 | 9.84 | 2.01 | H | | 0.062 | 17.89 |
| 1880.0 | | QPSK | -21.50 | 11.48 | 9.91 | 2.02 | H | | 0.086 | 19.37 |
| | | 16-QAM | -22.37 | 10.61 | 9.91 | 2.02 | H | | 0.071 | 18.50 |
| 1905.0 | | QPSK | -21.62 | 11.67 | 9.98 | 2.03 | H | | 0.092 | 19.62 |
| | | 16-QAM | -22.58 | 10.71 | 9.98 | 2.03 | H | | 0.073 | 18.66 |

Equivalent Isotropic Radiated Power Data (10 MHz Band 2 LTE)

Note: All of RB size has been tested for emissions and EIRP, with the 1RB configuration observed as the worst case

| Freq (MHz) | Bandwidth | Modulation | Measured Level (dBm) | Substitute Level (dBm) | Ant. Gain(dBi) | C.L | Pol | Limit | EIRP | |
|------------|-----------|------------|----------------------|------------------------|----------------|------|-----|--------|-------|-------|
| | | | | | | | | W | W | dBm |
| 1857.5 | 15 MHz | QPSK | -22.64 | 10.27 | 9.85 | 2.01 | H | < 2.00 | 0.065 | 18.11 |
| | | 16-QAM | -23.29 | 9.62 | 9.85 | 2.01 | H | | 0.056 | 17.46 |
| 1880.0 | | QPSK | -21.54 | 11.44 | 9.91 | 2.02 | H | | 0.086 | 19.33 |
| | | 16-QAM | -22.37 | 10.61 | 9.91 | 2.02 | H | | 0.071 | 18.50 |
| 1902.5 | | QPSK | -21.39 | 11.85 | 9.97 | 2.03 | H | | 0.095 | 19.79 |
| | | 16-QAM | -22.65 | 10.59 | 9.97 | 2.03 | H | | 0.071 | 18.53 |

Equivalent Isotropic Radiated Power Data (15 MHz Band 2 LTE)

Note: All of RB size has been tested for emissions and EIRP, with the 1RB configuration observed as the worst case

| Freq (MHz) | Bandwidth | Modulation | Measured Level (dBm) | Substitute Level (dBm) | Ant. Gain(dBi) | C.L | Pol | Limit | EIRP | |
|------------|-----------|------------|----------------------|------------------------|----------------|------|-----|--------|-------|-------|
| | | | | | | | | W | W | dBm |
| 1860.0 | 20 MHz | QPSK | -22.74 | 10.17 | 9.85 | 2.01 | H | < 2.00 | 0.063 | 18.01 |
| | | 16-QAM | -23.38 | 9.53 | 9.85 | 2.01 | H | | 0.055 | 17.37 |
| 1880.0 | | QPSK | -21.31 | 11.67 | 9.91 | 2.02 | H | | 0.090 | 19.56 |
| | | 16-QAM | -22.47 | 10.51 | 9.91 | 2.02 | H | | 0.069 | 18.40 |
| 1900.0 | | QPSK | -21.16 | 12.02 | 9.97 | 2.03 | H | | 0.099 | 19.96 |
| | | 16-QAM | -22.53 | 10.65 | 9.97 | 2.03 | H | | 0.072 | 18.59 |

Equivalent Isotropic Radiated Power Data (20 MHz Band 2 LTE)

Note: All of RB size has been tested for emissions and EIRP, with the 1RB configuration observed as the worst case

NOTES:

Equivalent Isotropic Radiated Power Measurements by Substitution Method
according to ANSI/TIA/EIA-603-D-2010 June 24, 2010:

The EUT was placed on a non-conductive styrofoam resin table 3-meters from the receive antenna. Turntable rotation was adjusted for the highest reading on the receive spectrum analyzer. For LTE signals, RBW = 1-5% of the OBW, not to exceed 1MHz, VBW $\geq 3 \times$ RBW, Detector = RMS. A Horn antenna was substituted in place of the EUT. This Horn antenna was driven by a signal generator and the level of the signal generator was adjusted to obtain the same receive spectrum analyzer reading. The conducted power at the terminals of the Horn antenna is measured. The difference between the gain of the horn and an isotropic antenna is taken into consideration and the EIRP is recorded.

Also, we have done x, y, z planes in EUT and horizontal and vertical polarization in detecting antenna. The worst case of the EUT is x plane in LTE mode. Also worst case of detecting Antenna is horizontal polarization in LTE mode.

8.2 EFFECTIVE RADIATED POWER (Band 5)

| Freq (MHz) | Bandwidth | Modulation | Measured Level (dBm) | Substitute Level (dBm) | Ant. Gain(dBd) | C.L | Pol | Limit | ERP | |
|------------|-----------|------------|----------------------|------------------------|----------------|------|-----|--------|-------|-------|
| | | | | | | | | W | W | dBm |
| 824.7 | 1.4 MHz | QPSK | -33.15 | 29.07 | -10.59 | 1.31 | V | < 7.00 | 0.052 | 17.17 |
| | | 16-QAM | -34.39 | 27.83 | -10.59 | 1.31 | V | | 0.039 | 15.93 |
| 836.5 | | QPSK | -33.24 | 29.32 | -10.54 | 1.32 | V | | 0.056 | 17.46 |
| | | 16-QAM | -34.42 | 28.14 | -10.54 | 1.32 | V | | 0.042 | 16.28 |
| 848.3 | | QPSK | -33.57 | 28.49 | -10.49 | 1.33 | V | | 0.046 | 16.67 |
| | | 16-QAM | -34.62 | 27.44 | -10.49 | 1.33 | V | | 0.036 | 15.62 |

Effective Radiated Power Data (1.4 MHz Band 5 LTE)

Note: All of RB size has been tested for emissions and ERP, with the 1RB configuration observed as the worst case

| Freq (MHz) | Bandwidth | Modulation | Measured Level (dBm) | Substitute Level (dBm) | Ant. Gain(dBd) | C.L | Pol | Limit | ERP | |
|------------|-----------|------------|----------------------|------------------------|----------------|------|-----|--------|-------|-------|
| | | | | | | | | W | W | dBm |
| 825.5 | 3 MHz | QPSK | -33.16 | 29.11 | -10.59 | 1.31 | V | < 7.00 | 0.053 | 17.21 |
| | | 16-QAM | -34.39 | 27.88 | -10.59 | 1.31 | V | | 0.040 | 15.98 |
| 836.5 | | QPSK | -33.31 | 29.25 | -10.54 | 1.32 | V | | 0.055 | 17.39 |
| | | 16-QAM | -34.38 | 28.18 | -10.54 | 1.32 | V | | 0.043 | 16.32 |
| 847.5 | | QPSK | -33.55 | 28.54 | -10.49 | 1.33 | V | | 0.047 | 16.72 |
| | | 16-QAM | -34.58 | 27.51 | -10.49 | 1.33 | V | | 0.037 | 15.69 |

Effective Radiated Power Data (3 MHz Band 5 LTE)

Note: All of RB size has been tested for emissions and ERP, with the 1RB configuration observed as the worst case

| Freq (MHz) | Bandwidth | Modulation | Measured Level (dBm) | Substitute Level (dBm) | Ant. Gain(dBd) | C.L | Pol | Limit | ERP | |
|------------|-----------|------------|----------------------|------------------------|----------------|------|-----|--------|-------|-------|
| | | | | | | | | W | W | dBm |
| 826.5 | 5 MHz | QPSK | -33.24 | 29.07 | -10.58 | 1.31 | V | < 7.00 | 0.052 | 17.18 |
| | | 16-QAM | -34.42 | 27.89 | -10.58 | 1.31 | V | | 0.040 | 16.00 |
| 836.5 | | QPSK | -33.35 | 29.21 | -10.54 | 1.32 | V | | 0.054 | 17.35 |
| | | 16-QAM | -34.61 | 27.95 | -10.54 | 1.32 | V | | 0.041 | 16.09 |
| 846.5 | | QPSK | -33.62 | 28.51 | -10.50 | 1.33 | V | | 0.047 | 16.68 |
| | | 16-QAM | -34.82 | 27.31 | -10.50 | 1.33 | V | | 0.035 | 15.48 |

Effective Radiated Power Data (5 MHz Band 5 LTE)

Note: All of RB size has been tested for emissions and ERP, with the 1RB configuration observed as the worst case

| Freq (MHz) | Bandwidth | Modulation | Measured Level (dBm) | Substitute Level (dBm) | Ant. Gain(dBd) | C.L | Pol | Limit | ERP | |
|------------|-----------|------------|----------------------|------------------------|----------------|------|-----|--------|-------|-------|
| | | | | | | | | W | W | dBm |
| 829.0 | 10 MHz | QPSK | -33.33 | 29.06 | -10.57 | 1.31 | V | < 7.00 | 0.052 | 17.18 |
| | | 16-QAM | -34.36 | 28.03 | -10.57 | 1.31 | V | | 0.041 | 16.15 |
| 836.5 | | QPSK | -33.25 | 29.31 | -10.54 | 1.32 | V | | 0.056 | 17.45 |
| | | 16-QAM | -34.34 | 28.22 | -10.54 | 1.32 | V | | 0.043 | 16.36 |
| 844.0 | | QPSK | -33.24 | 29.02 | -10.51 | 1.33 | V | | 0.052 | 17.18 |
| | | 16-QAM | -34.44 | 27.82 | -10.51 | 1.33 | V | | 0.040 | 15.98 |

Effective Radiated Power Data (10 MHz Band 5 LTE)

Note: All of RB size has been tested for emissions and ERP, with the 1RB configuration observed as the worst case

NOTES:

Effective Radiated Power Output Measurements by Substitution Method

according to ANSI/TIA/EIA-603-D-2010 June 24, 2010:

The EUT was placed on a non-conductive styrofoam resin table 3-meters from the receive antenna. The receive antenna height and turntable rotation was adjusted for the highest reading on the receive spectrum analyzer. For LTE signals, RBW = 1-5% of the OBW, not to exceed 1MHz, VBW ≥ 3 x RBW, Detector = RMS.

A half-wave dipole was substituted in place of the EUT. This dipole antenna was driven by a signal generator and the level of the signal generator was adjusted to obtain the same receive spectrum analyzer reading. The conducted power at the terminals of the dipole is measured. The ERP is recorded.

Also, we have done x, y, z planes in EUT and horizontal and vertical polarization in detecting antenna. The worst case of the EUT is y plane in LTE mode. Also worst case of detecting Antenna is vertical polarization in LTE mode.

8.3 RADIATED SPURIOUS EMISSIONS

8.3.1 RADIATED SPURIOUS EMISSIONS (1.4 MHz Band 2 LTE)

- ▣ OPERATING FREQUENCY: 1909.30 MHz
- ▣ MEASURED OUTPUT POWER: 19.83 dBm = 0.096 W
- ▣ MODULATION SIGNAL: 1.4 MHz QPSK
- ▣ DISTANCE: 3 meters
- ▣ LIMIT: $43 + 10 \log_{10}(W) =$ 32.83 dBc

| Ch | Freq (MHz) | Measured Level (dBm) | Ant. Gain (dBi) | Substitute Level (dBm) | C.L | Pol | EIRP (dBm) | dBc |
|-------------------|------------|----------------------|-----------------|------------------------|------|-----|------------|-------|
| 18607 (1850.7) | 3,701.40 | -57.00 | 12.52 | -62.75 | 2.92 | H | -53.15 | 72.98 |
| | 5,552.10 | -56.03 | 13.29 | -56.27 | 3.60 | V | -46.58 | 66.41 |
| | 7,402.80 | -54.41 | 11.72 | -49.54 | 4.26 | H | -42.08 | 61.91 |
| 18900 (1880.0) | 3,760.00 | -56.07 | 12.56 | -61.57 | 2.91 | V | -51.92 | 71.75 |
| | 5,640.00 | -55.41 | 13.30 | -55.29 | 3.64 | H | -45.63 | 65.46 |
| | 7,520.00 | -53.81 | 11.70 | -48.84 | 4.09 | H | -41.23 | 61.06 |
| 19193 (1909.3) | 3,818.60 | -56.56 | 12.60 | -61.91 | 2.97 | V | -52.28 | 72.11 |
| | 5,727.90 | -56.64 | 13.31 | -55.50 | 3.66 | V | -45.85 | 65.68 |
| | 7,637.20 | -52.57 | 11.62 | -47.99 | 4.29 | V | -40.66 | 60.49 |

- NOTES:**
1. Radiated Spurious Emission Measurements at 3 meters by Substitution Method according to ANSI/TIA/EIA-603-D-2010 June 24, 2010:
 2. We are performed all frequency to 10th harmonics from 9 kHz. Measurements above show only up to 3 maximum emissions noted, or would be lesser if no specific emissions from the EUT are recorded (ie: margin > 20 dB from the applicable limit) and considered that's already beyond the background noise floor.
 3. We have done x, y, z planes in EUT and horizontal and vertical polarization in detecting antenna.
 4. All of RB size has been tested for emissions and EIRP, with the 1RB configuration observed as the worst case
 5. We are performed 16QAM and QPSK modulations. The worst case data are reported in the table above.

8.3.2 RADIATED SPURIOUS EMISSIONS (3 MHz Band 2 LTE)

- ▣ OPERATING FREQUENCY: 1880.00 MHz
- ▣ MEASURED OUTPUT POWER: 19.84 dBm = 0.096 W
- ▣ MODULATION SIGNAL: 3 MHz QPSK
- ▣ DISTANCE: 3 meters
- ▣ LIMIT: $43 + 10 \log_{10}(W) =$ 32.84 dBc

| Ch | Freq (MHz) | Measured Level (dBm) | Ant. Gain (dBi) | Substitute Level (dBm) | C.L | Pol | EIRP (dBm) | dBc |
|-------------------|------------|----------------------|-----------------|------------------------|------|-----|------------|-------|
| 18615 (1851.5) | 3,703.00 | -54.97 | 12.52 | -60.68 | 2.92 | V | -51.08 | 70.92 |
| | 5,554.50 | -57.48 | 13.29 | -57.67 | 3.60 | V | -47.98 | 67.82 |
| | 7,406.00 | -54.80 | 11.72 | -49.81 | 4.26 | V | -42.35 | 62.19 |
| 18900 (1880.0) | 3,760.00 | -56.89 | 12.56 | -62.39 | 2.91 | V | -52.74 | 72.58 |
| | 5,640.00 | -56.06 | 13.30 | -55.94 | 3.64 | H | -46.28 | 66.12 |
| | 7,520.00 | -55.67 | 11.70 | -50.70 | 4.09 | H | -43.09 | 62.93 |
| 19185 (1908.5) | 3,817.00 | -55.59 | 12.60 | -60.98 | 2.98 | V | -51.36 | 71.20 |
| | 5,725.50 | -56.46 | 13.31 | -55.27 | 3.66 | V | -45.62 | 65.46 |
| | 7,634.00 | -53.76 | 11.62 | -49.20 | 4.29 | V | -41.87 | 61.71 |

- NOTES:**
1. Radiated Spurious Emission Measurements at 3 meters by Substitution Method according to ANSI/TIA/EIA-603-D-2010 June 24, 2010:
 2. We are performed all frequency to 10th harmonics from 9 kHz. Measurements above show only up to 3 maximum emissions noted, or would be lesser if no specific emissions from the EUT are recorded (ie: margin > 20 dB from the applicable limit) and considered that's already beyond the background noise floor.
 3. We have done x, y, z planes in EUT and horizontal and vertical polarization in detecting antenna.
 4. All of RB size has been tested for emissions and EIRP, with the 1RB configuration observed as the worst case
 5. We are performed 16QAM and QPSK modulations. The worst case data are reported in the table above.

8.3.3 RADIATED SPURIOUS EMISSIONS (5 MHz Band 2 LTE)

- ▣ OPERATING FREQUENCY: 1880.00 MHz
- ▣ MEASURED OUTPUT POWER: 19.63 dBm = 0.092 W
- ▣ MODULATION SIGNAL: 5 MHz QPSK
- ▣ DISTANCE: 3 meters
- ▣ LIMIT: $43 + 10 \log_{10}(W) =$ 32.63 dBc

| Ch | Freq (MHz) | Measured Level (dBm) | Ant. Gain (dBi) | Substitute Level (dBm) | C.L | Pol | EIRP (dBm) | dBc |
|-------------------|------------|----------------------|-----------------|------------------------|------|-----|------------|-------|
| 18625 (1852.5) | 3,705.00 | -57.38 | 12.52 | -63.02 | 2.92 | H | -53.42 | 73.05 |
| | 5,557.50 | -56.94 | 13.29 | -57.16 | 3.60 | V | -47.47 | 67.10 |
| | 7,410.00 | -55.60 | 11.72 | -50.46 | 4.26 | H | -43.00 | 62.63 |
| 18900 (1880.0) | 3,760.00 | -56.84 | 12.56 | -62.34 | 2.91 | H | -52.69 | 72.32 |
| | 5,640.00 | -57.29 | 13.30 | -57.17 | 3.64 | H | -47.51 | 67.14 |
| | 7,520.00 | -53.41 | 11.70 | -48.44 | 4.09 | V | -40.83 | 60.46 |
| 19175 (1907.5) | 3,815.00 | -56.94 | 12.60 | -62.40 | 2.97 | V | -52.77 | 72.40 |
| | 5,722.50 | -57.05 | 13.31 | -55.80 | 3.66 | V | -46.15 | 65.78 |
| | 7,630.00 | -53.30 | 11.62 | -48.72 | 4.29 | H | -41.39 | 61.02 |

- NOTES:**
1. Radiated Spurious Emission Measurements at 3 meters by Substitution Method according to ANSI/TIA/EIA-603-D-2010 June 24, 2010:
 2. We are performed all frequency to 10th harmonics from 9 kHz. Measurements above show only up to 3 maximum emissions noted, or would be lesser if no specific emissions from the EUT are recorded (ie: margin > 20 dB from the applicable limit) and considered that's already beyond the background noise floor.
 3. We have done x, y, z planes in EUT and horizontal and vertical polarization in detecting antenna.
 4. All of RB size has been tested for emissions and EIRP, with the 1RB configuration observed as the worst case
 5. We are performed 16QAM and QPSK modulations. The worst case data are reported in the table above.

8.3.4 RADIATED SPURIOUS EMISSIONS (10 MHz Band 2 LTE)

- ▣ OPERATING FREQUENCY: 1905.00 MHz
- ▣ MEASURED OUTPUT POWER: 19.62 dBm = 0.092 W
- ▣ MODULATION SIGNAL: 10 MHz QPSK
- ▣ DISTANCE: 3 meters
- ▣ LIMIT: $43 + 10 \log_{10}(W) =$ 32.62 dBc

| Ch | Freq (MHz) | Measured Level (dBm) | Ant. Gain (dBi) | Substitute Level (dBm) | C.L | Pol | EIRP (dBm) | dBc |
|-------------------|------------|----------------------|-----------------|------------------------|------|-----|------------|-------|
| 18650 (1855.0) | 3,710.00 | -57.30 | 12.52 | -62.79 | 2.90 | V | -53.17 | 72.79 |
| | 5,565.00 | -56.73 | 13.29 | -56.97 | 3.60 | V | -47.28 | 66.90 |
| | 7,420.00 | -53.78 | 11.72 | -48.24 | 4.34 | V | -40.86 | 60.48 |
| 18900 (1880.0) | 3,760.00 | -57.35 | 12.56 | -62.85 | 2.91 | H | -53.20 | 72.82 |
| | 5,640.00 | -57.02 | 13.30 | -56.90 | 3.64 | H | -47.24 | 66.86 |
| | 7,520.00 | -55.33 | 11.70 | -50.36 | 4.09 | H | -42.75 | 62.37 |
| 19150 (1905.0) | 3,810.00 | -57.93 | 12.60 | -63.53 | 2.97 | H | -53.90 | 73.52 |
| | 5,715.00 | -57.59 | 13.31 | -56.39 | 3.67 | H | -46.75 | 66.37 |
| | 7,620.00 | -55.55 | 11.62 | -51.08 | 4.33 | V | -43.79 | 63.41 |

- NOTES:**
1. Radiated Spurious Emission Measurements at 3 meters by Substitution Method according to ANSI/TIA/EIA-603-D-2010 June 24, 2010:
 2. We are performed all frequency to 10th harmonics from 9 kHz. Measurements above show only up to 3 maximum emissions noted, or would be lesser if no specific emissions from the EUT are recorded (ie: margin > 20 dB from the applicable limit) and considered that's already beyond the background noise floor.
 3. We have done x, y, z planes in EUT and horizontal and vertical polarization in detecting antenna.
 4. All of RB size has been tested for emissions and EIRP, with the 1RB configuration observed as the worst case
 5. We are performed 16QAM and QPSK modulations. The worst case data are reported in the table above.

8.3.5 RADIATED SPURIOUS EMISSIONS (15 MHz Band 2 LTE)

- ▣ OPERATING FREQUENCY: 1902.50 MHz
- ▣ MEASURED OUTPUT POWER: 19.79 dBm = 0.095 W
- ▣ MODULATION SIGNAL: 15 MHz QPSK
- ▣ DISTANCE: 3 meters
- ▣ LIMIT: $43 + 10 \log_{10} (W) =$ 32.79 dBc

| Ch | Freq (MHz) | Measured Level (dBm) | Ant. Gain (dBi) | Substitute Level (dBm) | C.L | Pol | EIRP (dBm) | dBc |
|-------------------|------------|----------------------|-----------------|------------------------|------|-----|------------|-------|
| 18675 (1857.5) | 3,715.00 | -56.11 | 12.52 | -61.77 | 2.90 | V | -52.15 | 71.94 |
| | 5,572.50 | -55.19 | 13.29 | -55.38 | 3.61 | H | -45.70 | 65.49 |
| | 7,430.00 | -53.81 | 11.72 | -48.46 | 4.30 | V | -41.04 | 60.83 |
| 18900 (1880.0) | 3,760.00 | -56.15 | 12.56 | -61.65 | 2.91 | V | -52.00 | 71.79 |
| | 5,640.00 | -57.56 | 13.30 | -57.44 | 3.64 | V | -47.78 | 67.57 |
| | 7,520.00 | -55.88 | 11.70 | -50.91 | 4.09 | V | -43.30 | 63.09 |
| 19125 (1902.5) | 3,805.00 | -56.14 | 12.59 | -61.52 | 2.94 | V | -51.87 | 71.66 |
| | 5,707.50 | -55.61 | 13.31 | -54.64 | 3.67 | V | -45.00 | 64.79 |
| | 7,610.00 | -55.30 | 11.63 | -50.63 | 4.31 | H | -43.31 | 63.10 |

- NOTES:**
1. Radiated Spurious Emission Measurements at 3 meters by Substitution Method according to ANSI/TIA/EIA-603-D-2010 June 24, 2010:
 2. We are performed all frequency to 10th harmonics from 9 kHz. Measurements above show only up to 3 maximum emissions noted, or would be lesser if no specific emissions from the EUT are recorded (ie: margin > 20 dB from the applicable limit) and considered that's already beyond the background noise floor.
 3. We have done x, y, z planes in EUT and horizontal and vertical polarization in detecting antenna.
 4. All of RB size has been tested for emissions and EIRP, with the 1RB configuration observed as the worst case
 5. We are performed 16QAM and QPSK modulations. The worst case data are reported in the table above.

8.3.6 RADIATED SPURIOUS EMISSIONS (20 MHz Band 2 LTE)

- ▣ OPERATING FREQUENCY: 1900.00 MHz
- ▣ MEASURED OUTPUT POWER: 19.96 dBm = 0.099 W
- ▣ MODULATION SIGNAL: 20 MHz QPSK
- ▣ DISTANCE: 3 meters
- ▣ LIMIT: $43 + 10 \log_{10}(W) =$ 32.96 dBc

| Ch | Freq (MHz) | Measured Level (dBm) | Ant. Gain (dBi) | Substitute Level (dBm) | C.L | Pol | EIRP (dBm) | dBc |
|-------------------|------------|----------------------|-----------------|------------------------|------|-----|------------|-------|
| 18700 (1860.0) | 3,720.00 | -57.83 | 12.53 | -63.67 | 2.90 | V | -54.04 | 74.00 |
| | 5,580.00 | -57.06 | 13.29 | -57.05 | 3.62 | V | -47.38 | 67.34 |
| | 7,440.00 | -55.51 | 11.72 | -50.35 | 4.29 | V | -42.92 | 62.88 |
| 18900 (1880.0) | 3,760.00 | -56.87 | 12.56 | -62.37 | 2.91 | V | -52.72 | 72.68 |
| | 5,640.00 | -56.55 | 13.30 | -56.43 | 3.64 | V | -46.77 | 66.73 |
| | 7,520.00 | -54.11 | 11.70 | -49.14 | 4.09 | H | -41.53 | 61.49 |
| 19100 (1900.0) | 3,800.00 | -56.84 | 12.59 | -61.99 | 2.94 | V | -52.34 | 72.30 |
| | 5,700.00 | -57.56 | 13.31 | -56.95 | 3.67 | V | -47.31 | 67.27 |
| | 7,600.00 | -54.61 | 11.64 | -49.85 | 4.27 | H | -42.48 | 62.44 |

- NOTES:**
1. Radiated Spurious Emission Measurements at 3 meters by Substitution Method according to ANSI/TIA/EIA-603-D-2010 June 24, 2010:
 2. We are performed all frequency to 10th harmonics from 9 kHz. Measurements above show only up to 3 maximum emissions noted, or would be lesser if no specific emissions from the EUT are recorded (ie: margin > 20 dB from the applicable limit) and considered that's already beyond the background noise floor.
 3. We have done x, y, z planes in EUT and horizontal and vertical polarization in detecting antenna.
 4. All of RB size has been tested for emissions and EIRP, with the 1RB configuration observed as the worst case
 5. We are performed 16QAM and QPSK modulations. The worst case data are reported in the table above.

8.3.7 RADIATED SPURIOUS EMISSIONS (1.4 MHz Band 5 LTE)

- ▣ OPERATING FREQUENCY: 836.50 MHz
- ▣ MEASURED OUTPUT POWER: 17.46 dBm = 0.056 W
- ▣ MODULATION SIGNAL: 1.4 MHz QPSK
- ▣ DISTANCE: 3 meters
- ▣ LIMIT: $43 + 10 \log_{10}(W) =$ 30.46 dBc

| Ch | Freq (MHz) | Measured Level (dBm) | Ant. Gain (dBd) | Substitute Level (dBm) | C.L | Pol | ERP (dBm) | dBc |
|------------------|------------|----------------------|-----------------|------------------------|------|-----|-----------|-------|
| 20407 (824.7) | 1,649.40 | -55.64 | 9.16 | -68.06 | 1.88 | H | -60.78 | 78.24 |
| | 2,474.10 | -35.97 | 10.93 | -44.96 | 2.33 | H | -36.36 | 53.82 |
| | 3,298.80 | -56.46 | 11.94 | -65.73 | 2.72 | V | -56.51 | 73.97 |
| 20525 (836.5) | 1,673.00 | -54.29 | 9.23 | -66.76 | 1.90 | H | -59.43 | 76.89 |
| | 2,509.50 | -33.66 | 10.96 | -42.92 | 2.36 | H | -34.32 | 51.78 |
| | 3,346.00 | -54.72 | 12.04 | -64.29 | 2.74 | V | -54.99 | 72.45 |
| 20643 (848.3) | 1,696.60 | -55.12 | 9.32 | -67.58 | 1.91 | H | -60.17 | 77.63 |
| | 2,544.90 | -35.15 | 10.99 | -44.14 | 2.39 | H | -35.54 | 53.00 |
| | 3,393.20 | -56.26 | 12.14 | -65.73 | 2.77 | V | -56.36 | 73.82 |

- NOTES:**
1. Radiated Spurious Emission Measurements at 3 meters by Substitution Method according to ANSI/TIA/EIA-603-D-2010 June 24, 2010:
 2. We are performed all frequency to 10th harmonics from 9 kHz. Measurements above show only up to 3 maximum emissions noted, or would be lesser if no specific emissions from the EUT are recorded (ie: margin > 20 dB from the applicable limit) and considered that's already beyond the background noise floor.
 3. We have done x, y, z planes in EUT and horizontal and vertical polarization in detecting antenna.
 4. All of RB size has been tested for emissions and ERP, with the 1RB configuration observed as the worst case
 5. We are performed 16QAM and QPSK modulations. The worst case data are reported in the table above.

8.3.8 RADIATED SPURIOUS EMISSIONS (3 MHz Band 5 LTE)

- ▣ OPERATING FREQUENCY: 836.50 MHz
- ▣ MEASURED OUTPUT POWER: 17.39 dBm = 0.055 W
- ▣ MODULATION SIGNAL: 3 MHz QPSK
- ▣ DISTANCE: 3 meters
- ▣ LIMIT: $43 + 10 \log_{10}(W) =$ 30.39 dBc

| Ch | Freq (MHz) | Measured Level (dBm) | Ant. Gain (dBd) | Substitute Level (dBm) | C.L | Pol | ERP (dBm) | dBc |
|------------------|------------|----------------------|-----------------|------------------------|------|-----|-----------|-------|
| 20415 (825.5) | 1,651.00 | -53.95 | 9.16 | -66.37 | 1.88 | H | -59.09 | 76.48 |
| | 2,476.50 | -30.44 | 10.92 | -39.54 | 2.33 | H | -30.95 | 48.34 |
| | 3,302.00 | -56.78 | 11.94 | -66.04 | 2.72 | H | -56.82 | 74.21 |
| 20525 (836.5) | 1,673.00 | -53.08 | 9.23 | -65.55 | 1.90 | H | -58.22 | 75.61 |
| | 2,509.50 | -31.00 | 10.96 | -40.26 | 2.36 | H | -31.66 | 49.05 |
| | 3,346.00 | -55.19 | 12.03 | -64.75 | 2.74 | H | -55.46 | 72.85 |
| 20635 (847.5) | 1,695.00 | -53.67 | 9.30 | -66.12 | 1.91 | H | -58.73 | 76.12 |
| | 2,542.50 | -32.27 | 10.98 | -41.13 | 2.39 | H | -32.54 | 49.93 |
| | 3,390.00 | -56.14 | 12.13 | -65.68 | 2.77 | V | -56.32 | 73.71 |

- NOTES:**
1. Radiated Spurious Emission Measurements at 3 meters by Substitution Method according to ANSI/TIA/EIA-603-D-2010 June 24, 2010:
 2. We are performed all frequency to 10th harmonics from 9 kHz. Measurements above show only up to 3 maximum emissions noted, or would be lesser if no specific emissions from the EUT are recorded (ie: margin > 20 dB from the applicable limit) and considered that's already beyond the background noise floor.
 3. We have done x, y, z planes in EUT and horizontal and vertical polarization in detecting antenna.
 4. All of RB size has been tested for emissions and ERP, with the 1RB configuration observed as the worst case
 5. We are performed 16QAM and QPSK modulations. The worst case data are reported in the table above.

8.3.9 RADIATED SPURIOUS EMISSIONS (5 MHz Band 5 LTE)

- ▣ OPERATING FREQUENCY: 836.50 MHz
- ▣ MEASURED OUTPUT POWER: 17.35 dBm = 0.054 W
- ▣ MODULATION SIGNAL: 5 MHz QPSK
- ▣ DISTANCE: 3 meters
- ▣ LIMIT: $43 + 10 \log_{10}(W) =$ 30.35 dBc

| Ch | Freq (MHz) | Measured Level (dBm) | Ant. Gain (dBd) | Substitute Level (dBm) | C.L | Pol | ERP (dBm) | dBc |
|------------------|------------|----------------------|-----------------|------------------------|------|-----|-----------|-------|
| 20425 (826.5) | 1,653.00 | -54.41 | 9.17 | -66.87 | 1.88 | H | -59.58 | 76.93 |
| | 2,479.50 | -34.79 | 10.92 | -44.05 | 2.33 | H | -35.46 | 52.81 |
| | 3,306.00 | -56.04 | 11.95 | -65.31 | 2.72 | H | -56.08 | 73.43 |
| 20525 (836.5) | 1,673.00 | -57.43 | 9.23 | -69.90 | 1.90 | H | -62.57 | 79.92 |
| | 2,509.50 | -31.58 | 10.96 | -40.84 | 2.36 | H | -32.24 | 49.59 |
| | 3,346.00 | -56.38 | 10.03 | -63.94 | 2.74 | H | -56.65 | 74.00 |
| 20625 (846.5) | 1,693.00 | -56.95 | 9.31 | -69.43 | 1.91 | H | -62.03 | 79.38 |
| | 2,539.50 | -30.16 | 10.98 | -38.94 | 2.38 | H | -30.34 | 47.69 |
| | 3,386.00 | -57.14 | 12.11 | -66.68 | 2.77 | V | -57.34 | 74.69 |

- NOTES:**
1. Radiated Spurious Emission Measurements at 3 meters by Substitution Method according to ANSI/TIA/EIA-603-D-2010 June 24, 2010:
 2. We are performed all frequency to 10th harmonics from 9 kHz. Measurements above show only up to 3 maximum emissions noted, or would be lesser if no specific emissions from the EUT are recorded (ie: margin > 20 dB from the applicable limit) and considered that's already beyond the background noise floor.
 3. We have done x, y, z planes in EUT and horizontal and vertical polarization in detecting antenna.
 4. All of RB size has been tested for emissions and ERP, with the 1RB configuration observed as the worst case
 5. We are performed 16QAM and QPSK modulations. The worst case data are reported in the table above.

8.3.10 RADIATED SPURIOUS EMISSIONS (10 MHz Band 5 LTE)

- ▣ OPERATING FREQUENCY: 836.50 MHz
- ▣ MEASURED OUTPUT POWER: 17.45 dBm = 0.056 W
- ▣ MODULATION SIGNAL: 10 MHz QPSK
- ▣ DISTANCE: 3 meters
- ▣ LIMIT: $43 + 10 \log_{10}(W) =$ 30.45 dBc

| Ch | Freq (MHz) | Measured Level (dBm) | Ant. Gain (dBd) | Substitute Level (dBm) | C.L | Pol | ERP (dBm) | dBc |
|------------------|------------|----------------------|-----------------|------------------------|------|-----|-----------|-------|
| 20450 (829.0) | 1,658.00 | -56.74 | 9.18 | -69.28 | 1.88 | H | -61.98 | 79.43 |
| | 2,487.00 | -30.36 | 10.93 | -39.41 | 2.34 | H | -30.82 | 48.27 |
| | 3,316.00 | -57.40 | 11.96 | -66.71 | 2.71 | V | -57.46 | 74.91 |
| 20525 (836.5) | 1,673.00 | -57.69 | 9.23 | -70.16 | 1.90 | H | -62.83 | 80.28 |
| | 2,509.50 | -31.54 | 10.96 | -40.80 | 2.36 | H | -32.20 | 49.65 |
| | 3,346.00 | -57.07 | 10.03 | -64.63 | 2.74 | V | -57.34 | 74.79 |
| 20600 (844.0) | 1,688.00 | -55.34 | 9.28 | -67.83 | 1.91 | H | -60.46 | 77.91 |
| | 2,532.00 | -30.48 | 10.98 | -39.73 | 2.38 | H | -31.13 | 48.58 |
| | 3,376.00 | -57.37 | 12.10 | -66.98 | 2.77 | V | -57.65 | 75.10 |

- NOTES:**
1. Radiated Spurious Emission Measurements at 3 meters by Substitution Method according to ANSI/TIA/EIA-603-D-2010 June 24, 2010:
 2. We are performed all frequency to 10th harmonics from 9 kHz. Measurements above show only up to 3 maximum emissions noted, or would be lesser if no specific emissions from the EUT are recorded (ie: margin > 20 dB from the applicable limit) and considered that's already beyond the background noise floor.
 3. We have done x, y, z planes in EUT and horizontal and vertical polarization in detecting antenna.
 4. All of RB size has been tested for emissions and ERP, with the 1RB configuration observed as the worst case
 5. We are performed 16QAM and QPSK modulations. The worst case data are reported in the table above.

8.4 PEAK-TO-AVERAGE RATIO

| Band | Band Width | Frequency (MHz) | Modulation | Resource Block Size | Resource Block Offset | Data (dB) |
|------|------------|-----------------|------------|---------------------|-----------------------|-------------|
| 2 | 1.4 MHz | 1880.0 | QPSK | 6 | 0 | 4.54 |
| | | | 16-QAM | 6 | 0 | 5.51 |
| | 3 MHz | | QPSK | 15 | 0 | 4.77 |
| | | | 16-QAM | 15 | 0 | 5.60 |
| | 5 MHz | | QPSK | 25 | 0 | 4.63 |
| | | | 16-QAM | 25 | 0 | 5.51 |
| | 10 MHz | | QPSK | 50 | 0 | 4.63 |
| | | | 16-QAM | 50 | 0 | 5.59 |
| | 15 MHz | | QPSK | 75 | 0 | 4.68 |
| | | | 16-QAM | 75 | 0 | 5.95 |
| | 20 MHz | | QPSK | 100 | 0 | 4.70 |
| | | | 16-QAM | 100 | 0 | 5.57 |

- Plots of the EUT's Peak- to- Average Ratio are shown Page 61 ~ 66.

8.5 OCCUPIED BANDWIDTH

| Band | Band Width | Frequency (MHz) | Modulation | Resource Block Size | Resource Block Offset | Data (MHz) |
|------|------------|-----------------|------------|---------------------|-----------------------|--------------|
| 2 | 1.4 MHz | 1880.0 | QPSK | 6 | 0 | 1.0945 |
| | | | 16-QAM | 6 | 0 | 1.0976 |
| | 3 MHz | | QPSK | 15 | 0 | 2.6953 |
| | | | 16-QAM | 15 | 0 | 2.6951 |
| | 5 MHz | | QPSK | 25 | 0 | 4.4951 |
| | | | 16-QAM | 25 | 0 | 4.4947 |
| | 10 MHz | | QPSK | 50 | 0 | 8.9725 |
| | | | 16-QAM | 50 | 0 | 8.9430 |
| | 15 MHz | | QPSK | 75 | 0 | 13.445 |
| | | | 16-QAM | 75 | 0 | 13.407 |
| | 20 MHz | | QPSK | 100 | 0 | 17.909 |
| | | | 16-QAM | 100 | 0 | 17.919 |

| Band | Band Width | Frequency (MHz) | Modulation | Resource Block Size | Resource Block Offset | Data (MHz) |
|------|------------|-----------------|------------|---------------------|-----------------------|--------------|
| 5 | 1.4 MHz | 836.5 | QPSK | 6 | 0 | 1.0976 |
| | | | 16-QAM | 6 | 0 | 1.0988 |
| | 3 MHz | | QPSK | 15 | 0 | 2.7055 |
| | | | 16-QAM | 15 | 0 | 2.6988 |
| | 5 MHz | | QPSK | 25 | 0 | 4.5013 |
| | | | 16-QAM | 25 | 0 | 4.4917 |
| | 10 MHz | | QPSK | 50 | 0 | 8.9580 |
| | | | 16-QAM | 50 | 0 | 8.9345 |

- Plots of the EUT's Occupied Bandwidth are shown Page 51 ~ 60.

8.6 CONDUCTED SPURIOUS EMISSIONS

■ FACTORS FOR FREQUENCY

| Frequency Range (GHz) | Factor [dB] |
|-----------------------|-------------|
| 0.03 – 1 | 25.27 |
| 1 – 5 | 27.98 |
| 5 – 10 | 28.59 |
| 10 – 15 | 29.12 |
| 15 – 20 | 29.49 |
| Above 20 | 30.13 |

NOTES:

Factor(dB) = Cable Loss + Attenuator + Power Splitter

| Band | Band Width (MHz) | Frequency (MHz) | Frequency of Maximum Harmonic (GHz) | Factor (dB) | Measurement Maximum Data (dBm) | Result (dBm) | Limit (dBm) |
|------|------------------|-----------------|-------------------------------------|-------------|--------------------------------|--------------|-------------|
| 2 | 1.4 | 1850.7 | 18.9195 | 29.49 | -73.39 | -43.90 | -13.00 |
| | | 1880.0 | 18.9285 | 29.49 | -73.22 | -43.73 | |
| | | 1909.3 | 18.9320 | 29.49 | -73.35 | -43.86 | |
| | 3 | 1851.5 | 18.9215 | 29.49 | -73.36 | -43.87 | |
| | | 1880.0 | 18.9105 | 29.49 | -73.41 | -43.92 | |
| | | 1908.5 | 18.8915 | 29.49 | -73.19 | -43.70 | |
| | 5 | 1852.5 | 18.9065 | 29.49 | -73.39 | -43.90 | |
| | | 1880.0 | 18.9015 | 29.49 | -73.47 | -43.98 | |
| | | 1907.5 | 18.9235 | 29.49 | -73.52 | -44.03 | |
| | 10 | 1855.0 | 18.9145 | 29.49 | -73.37 | -43.88 | |
| | | 1880.0 | 18.9135 | 29.49 | -73.44 | -43.95 | |
| | | 1905.0 | 18.9300 | 29.49 | -73.47 | -43.98 | |
| | 15 | 1857.5 | 18.9280 | 29.49 | -73.28 | -43.79 | |
| | | 1880.0 | 18.9145 | 29.49 | -73.34 | -43.85 | |
| | | 1902.5 | 18.9440 | 29.49 | -73.33 | -43.84 | |
| | 20 | 1860.0 | 18.9140 | 29.49 | -73.37 | -43.88 | |
| | | 1880.0 | 18.9130 | 29.49 | -73.21 | -43.72 | |
| | | 1900.0 | 18.9320 | 29.49 | -73.27 | -43.78 | |

| Band | Band Width (MHz) | Frequency (MHz) | Frequency of Maximum Harmonic (GHz) | Factor (dB) | Measurement Maximum Data (dBm) | Result (dBm) | Limit (dBm) |
|------|------------------|-----------------|-------------------------------------|-------------|--------------------------------|--------------|-------------|
| 5 | 1.4 | 824.7 | 3.67748 | 27.98 | -67.12 | -39.14 | -13.00 |
| | | 836.5 | 3.71078 | 27.98 | -67.21 | -39.23 | |
| | | 848.3 | 3.70084 | 27.98 | -67.11 | -39.13 | |
| | 3 | 825.5 | 3.69687 | 27.98 | -67.12 | -39.14 | |
| | | 836.5 | 3.68444 | 27.98 | -66.67 | -38.69 | |
| | | 847.5 | 3.69836 | 27.98 | -67.23 | -39.25 | |
| | 5 | 826.5 | 3.71153 | 27.98 | -67.04 | -39.06 | |
| | | 836.5 | 3.67351 | 27.98 | -67.21 | -39.23 | |
| | | 846.5 | 3.68916 | 27.98 | -67.01 | -39.03 | |
| | 10 | 829.0 | 3.68121 | 27.98 | -67.08 | -39.10 | |
| | | 836.5 | 3.70134 | 27.98 | -66.88 | -38.90 | |
| | | 844.0 | 3.70407 | 27.98 | -66.84 | -38.86 | |

NOTES:

1. Conducted Spurious Emissions was Tested QPSK Modulation, Resource Block Size 1 and Resource Block Offset 0
2. Result (dBm) = Measurement Maximum Data (dBm) + Factor (dB)

- Plots of the EUT's Conducted Spurious Emissions are shown Page 97 ~ 126.

8.6.1 BAND EDGE

- Plots of the EUT's Band Edge are shown Page 67 ~ 96.

8.7 FREQUENCY STABILITY / VARIATION OF AMBIENT TEMPERATURE

8.7.1 FREQUENCY STABILITY (1.4 MHz Band 2 LTE)

- ▣ OPERATING FREQUENCY: 1880,000,000 Hz
- ▣ CHANNEL: 18900 (1.4 MHz)
- ▣ REFERENCE VOLTAGE: 3.85 VDC
- ▣ DEVIATION LIMIT: Emission must remain in band

| Voltage (%) | Power (VDC) | Temp. (°C) | Frequency (Hz) | Frequency Error (Hz) | Deviation (%) | ppm |
|----------------|-------------|------------|----------------|----------------------|---------------|-----------|
| 100% | 3.85 | +20(Ref) | 1879 999 990 | 0 | 0.000 000 | 0.000 |
| 100% | | -30 | 1879 999 980 | -10.1 | -0.000 001 | -0.005 |
| 100% | | -20 | 1879 999 982 | -7.8 | 0.000 000 | -0.004 |
| 100% | | -10 | 1879 999 985 | -5.5 | 0.000 000 | -0.003 |
| 100% | | 0 | 1879 999 981 | -9.1 | 0.000 000 | -0.005 |
| 100% | | +10 | 1879 999 984 | -6.4 | 0.000 000 | -0.003 |
| 100% | | +30 | 1879 999 984 | -6.3 | 0.000 000 | -0.003 |
| 100% | | +40 | 1879 999 980 | -10 | -0.000 001 | -0.005 |
| 100% | | +50 | 1879 999 982 | -8.4 | 0.000 000 | -0.004 |
| Batt. Endpoint | | 3.40 | +20 | 1879 999 986 | -4.3 | 0.000 000 |

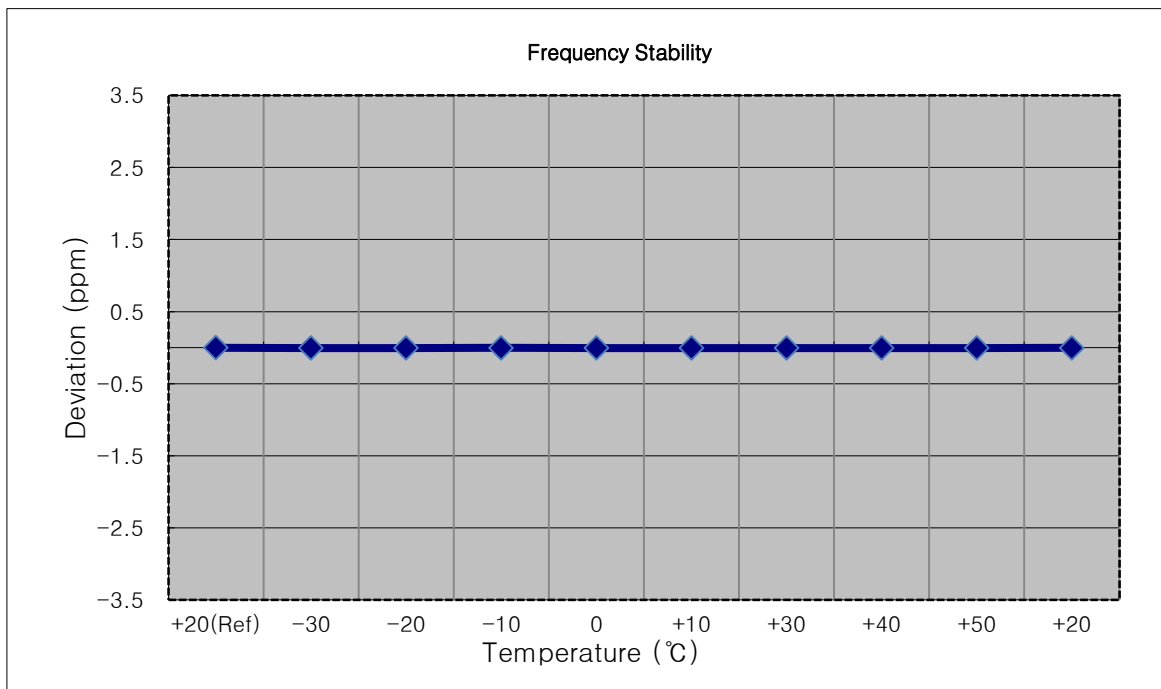

8.7.2 FREQUENCY STABILITY (3 MHz Band 2 LTE)

- ▣ OPERATING FREQUENCY: 1880,000,000 Hz
- ▣ CHANNEL: 18900 (3 MHz)
- ▣ REFERENCE VOLTAGE: 3.85 VDC
- ▣ DEVIATION LIMIT: Emission must remain in band

| Voltage (%) | Power (VDC) | Temp. (°C) | Frequency (Hz) | Frequency Error (Hz) | Deviation (%) | ppm |
|----------------|-------------|------------|----------------|----------------------|---------------|--------|
| 100% | 3.85 | +20(Ref) | 1879 999 994 | 0.0 | 0.000 000 | 0.000 |
| 100% | | -30 | 1879 999 989 | -4.4 | 0.000 000 | -0.002 |
| 100% | | -20 | 1879 999 983 | -10.4 | -0.000 001 | -0.006 |
| 100% | | -10 | 1879 999 984 | -9.5 | -0.000 001 | -0.005 |
| 100% | | 0 | 1879 999 984 | -9.7 | -0.000 001 | -0.005 |
| 100% | | +10 | 1879 999 987 | -7.2 | 0.000 000 | -0.004 |
| 100% | | +30 | 1879 999 985 | -8.4 | 0.000 000 | -0.004 |
| 100% | | +40 | 1879 999 986 | -7.6 | 0.000 000 | -0.004 |
| 100% | | +50 | 1879 999 987 | -6.9 | 0.000 000 | -0.004 |
| Batt. Endpoint | 3.40 | +20 | 1879 999 988 | -6.3 | 0.000 000 | -0.003 |

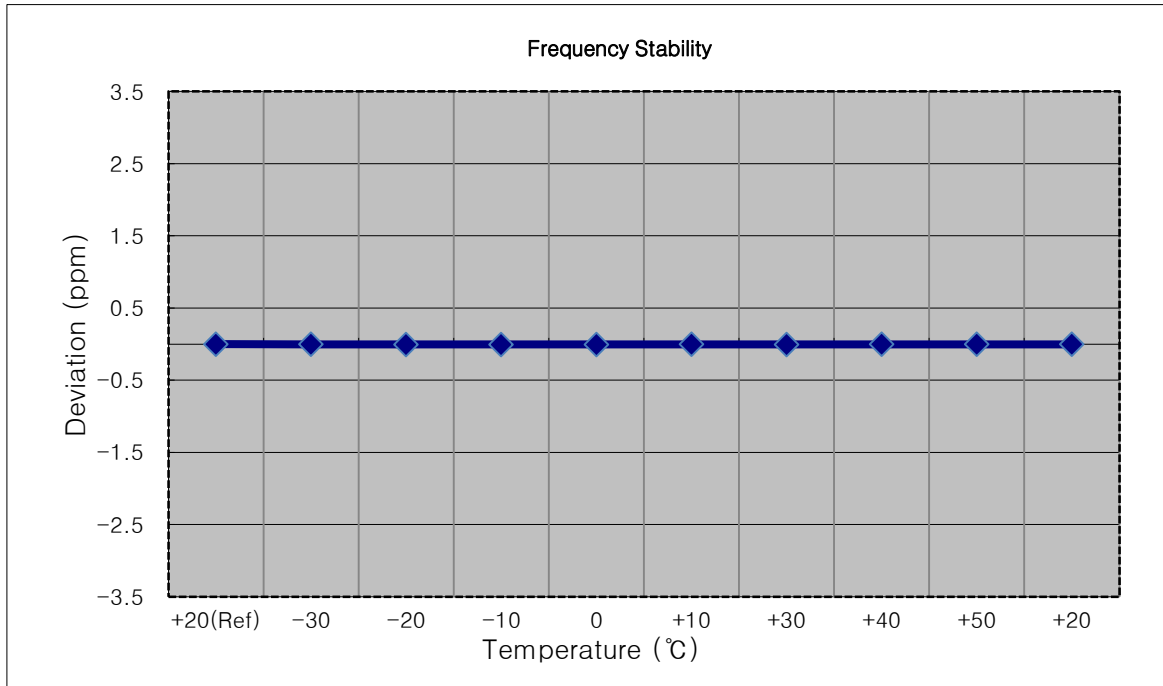

8.7.3 FREQUENCY STABILITY (5 MHz Band 2 LTE)

- ▣ OPERATING FREQUENCY: 1880,000,000 Hz
- ▣ CHANNEL: 18900 (5 MHz)
- ▣ REFERENCE VOLTAGE: 3.85 VDC
- ▣ DEVIATION LIMIT: Emission must remain in band

| Voltage (%) | Power (VDC) | Temp. (°C) | Frequency (Hz) | Frequency Error (Hz) | Deviation (%) | ppm |
|----------------|-------------|------------|----------------|----------------------|---------------|-----------|
| 100% | 3.85 | +20(Ref) | 1879 999 995 | 0.0 | 0.000 000 | 0.000 |
| 100% | | -30 | 1879 999 986 | -8.7 | 0.000 000 | -0.005 |
| 100% | | -20 | 1879 999 986 | -8.7 | 0.000 000 | -0.005 |
| 100% | | -10 | 1879 999 988 | -6.3 | 0.000 000 | -0.003 |
| 100% | | 0 | 1879 999 986 | -8.3 | 0.000 000 | -0.004 |
| 100% | | +10 | 1879 999 989 | -6.2 | 0.000 000 | -0.003 |
| 100% | | +30 | 1879 999 988 | -6.7 | 0.000 000 | -0.004 |
| 100% | | +40 | 1879 999 989 | -5.7 | 0.000 000 | -0.003 |
| 100% | | +50 | 1879 999 986 | -8.6 | 0.000 000 | -0.005 |
| Batt. Endpoint | | 3.40 | +20 | 1879 999 989 | -6.2 | 0.000 000 |

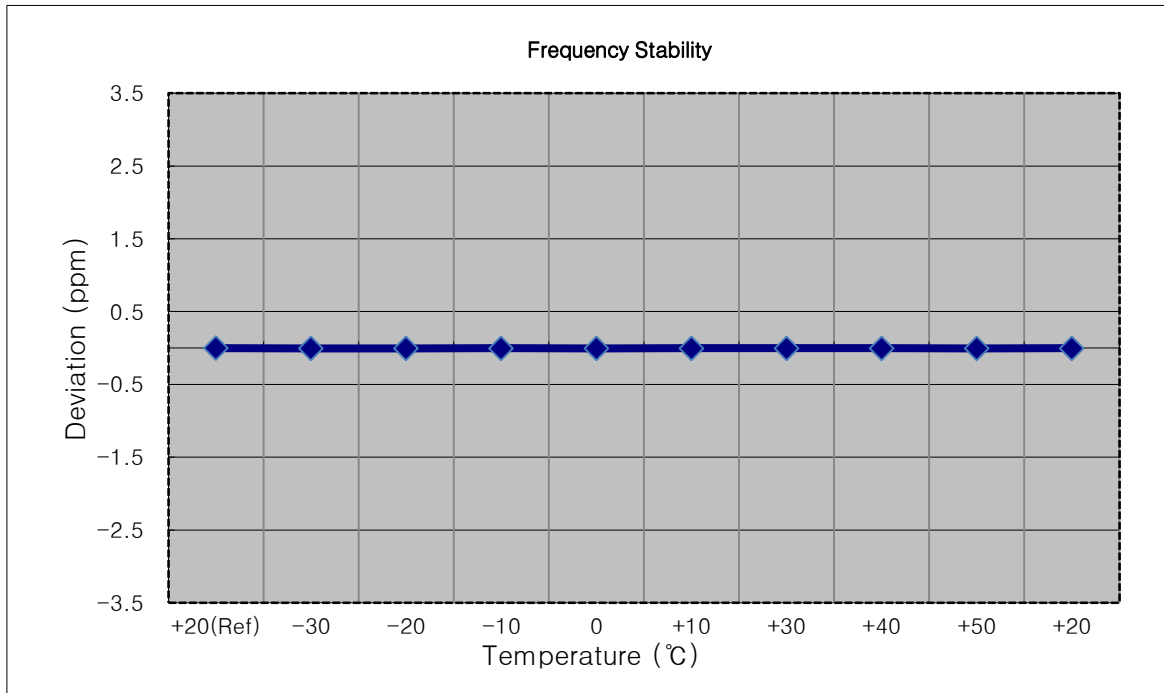

8.7.4 FREQUENCY STABILITY (10 MHz Band 2 LTE)

- ▣ OPERATING FREQUENCY: 1880,000,000 Hz
- ▣ CHANNEL: 18900 (10 MHz)
- ▣ REFERENCE VOLTAGE: 3.85 VDC
- ▣ DEVIATION LIMIT: Emission must remain in band

| Voltage (%) | Power (VDC) | Temp. (°C) | Frequency (Hz) | Frequency Error (Hz) | Deviation (%) | ppm |
|----------------|-------------|------------|----------------|----------------------|---------------|-----------|
| 100% | 3.85 | +20(Ref) | 1879 999 992 | 0.0 | 0.000 000 | 0.000 |
| 100% | | -30 | 1879 999 984 | -7.9 | 0.000 000 | -0.004 |
| 100% | | -20 | 1879 999 984 | -7.8 | 0.000 000 | -0.004 |
| 100% | | -10 | 1879 999 986 | -5.8 | 0.000 000 | -0.003 |
| 100% | | 0 | 1879 999 986 | -6.3 | 0.000 000 | -0.003 |
| 100% | | +10 | 1879 999 986 | -6.2 | 0.000 000 | -0.003 |
| 100% | | +30 | 1879 999 987 | -5.0 | 0.000 000 | -0.003 |
| 100% | | +40 | 1879 999 985 | -6.7 | 0.000 000 | -0.004 |
| 100% | | +50 | 1879 999 983 | -9.4 | -0.000 001 | -0.005 |
| Batt. Endpoint | | 3.40 | +20 | 1879 999 987 | -5.4 | 0.000 000 |

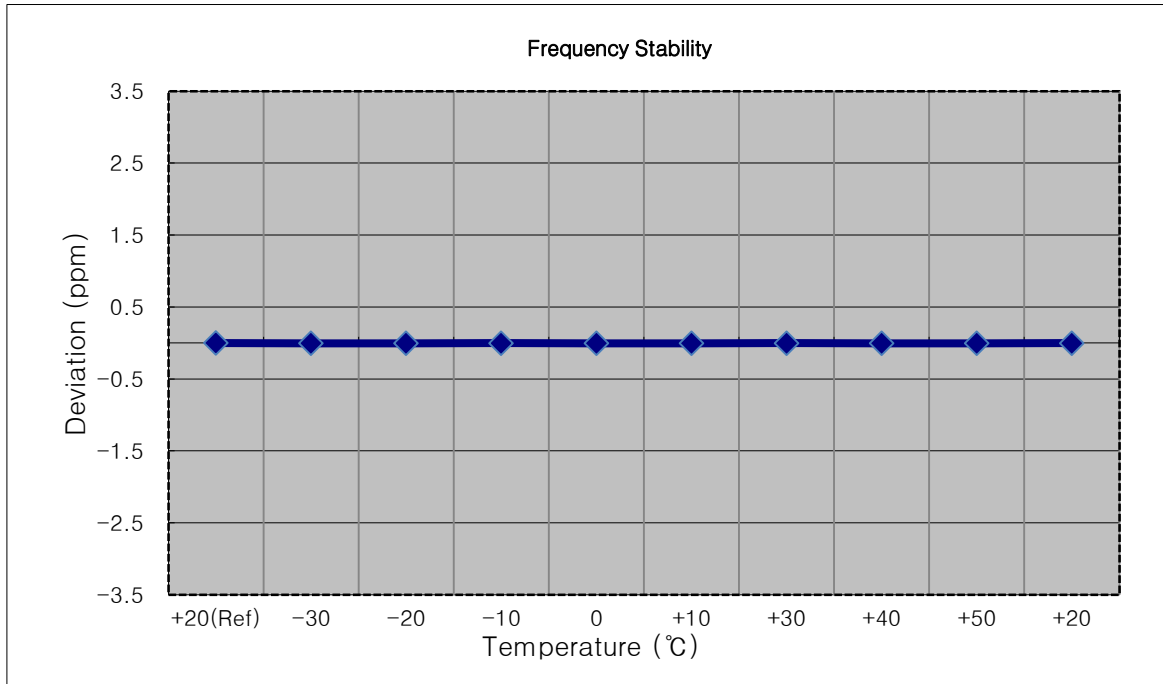

8.7.5 FREQUENCY STABILITY (15 MHz Band 2 LTE)

- ▣ OPERATING FREQUENCY: 1880,000,000 Hz
- ▣ CHANNEL: 18900 (15 MHz)
- ▣ REFERENCE VOLTAGE: 3.85 VDC
- ▣ DEVIATION LIMIT: Emission must remain in band

| Voltage (%) | Power (VDC) | Temp. (°C) | Frequency (Hz) | Frequency Error (Hz) | Deviation (%) | ppm |
|----------------|-------------|------------|----------------|----------------------|---------------|-----------|
| 100% | 3.85 | +20(Ref) | 1879 999 990 | 0.0 | 0.000 000 | 0.000 |
| 100% | | -30 | 1879 999 980 | -10.0 | -0.000 001 | -0.005 |
| 100% | | -20 | 1879 999 983 | -6.9 | 0.000 000 | -0.004 |
| 100% | | -10 | 1879 999 983 | -6.7 | 0.000 000 | -0.004 |
| 100% | | 0 | 1879 999 982 | -7.9 | 0.000 000 | -0.004 |
| 100% | | +10 | 1879 999 984 | -5.9 | 0.000 000 | -0.003 |
| 100% | | +30 | 1879 999 982 | -8.0 | 0.000 000 | -0.004 |
| 100% | | +40 | 1879 999 984 | -6.5 | 0.000 000 | -0.003 |
| 100% | | +50 | 1879 999 981 | -8.6 | 0.000 000 | -0.005 |
| Batt. Endpoint | | 3.40 | +20 | 1879 999 984 | -6.2 | 0.000 000 |

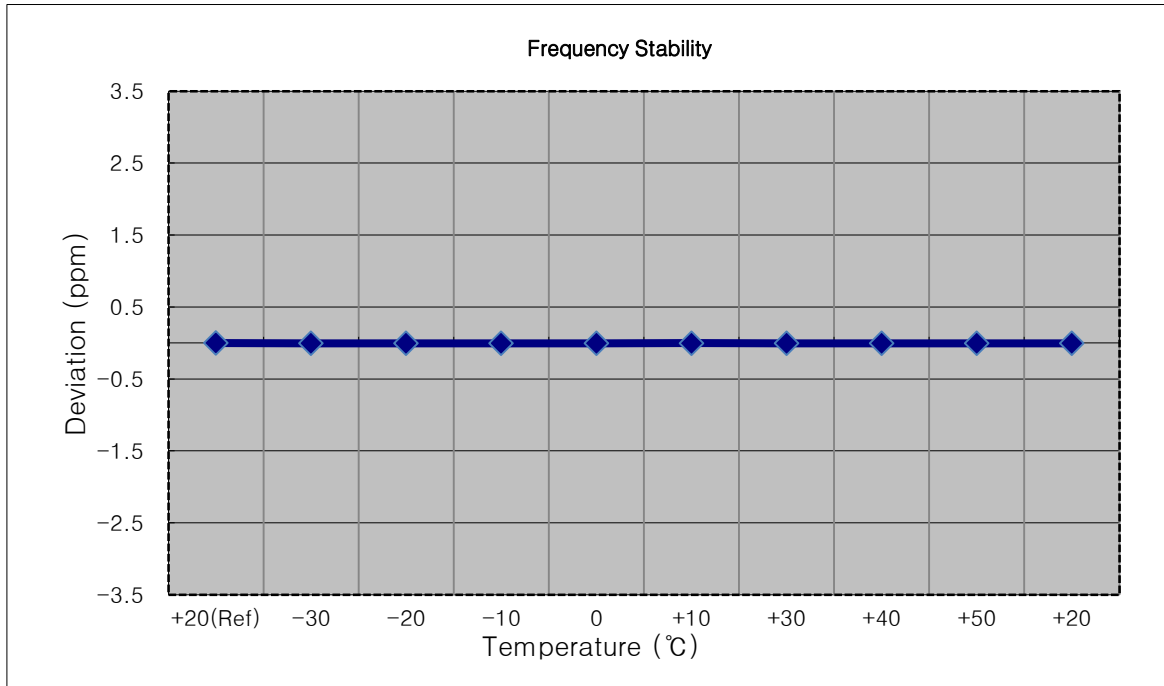

8.7.6 FREQUENCY STABILITY (20 MHz Band 2 LTE)

- ▣ OPERATING FREQUENCY: 1880,000,000 Hz
- ▣ CHANNEL: 18900 (20 MHz)
- ▣ REFERENCE VOLTAGE: 3.85 VDC
- ▣ DEVIATION LIMIT: Emission must remain in band

| Voltage (%) | Power (VDC) | Temp. (°C) | Frequency (Hz) | Frequency Error (Hz) | Deviation (%) | ppm |
|----------------|-------------|------------|----------------|----------------------|---------------|-----------|
| 100% | 3.85 | +20(Ref) | 1879 999 994 | 0.0 | 0.000 000 | 0.000 |
| 100% | | -30 | 1879 999 986 | -7.5 | 0.000 000 | -0.004 |
| 100% | | -20 | 1879 999 989 | -4.9 | 0.000 000 | -0.003 |
| 100% | | -10 | 1879 999 988 | -5.7 | 0.000 000 | -0.003 |
| 100% | | 0 | 1879 999 987 | -6.3 | 0.000 000 | -0.003 |
| 100% | | +10 | 1879 999 989 | -5.1 | 0.000 000 | -0.003 |
| 100% | | +30 | 1879 999 987 | -6.4 | 0.000 000 | -0.003 |
| 100% | | +40 | 1879 999 990 | -3.6 | 0.000 000 | -0.002 |
| 100% | | +50 | 1879 999 987 | -6.4 | 0.000 000 | -0.003 |
| Batt. Endpoint | | 3.40 | +20 | 1879 999 989 | -5.1 | 0.000 000 |

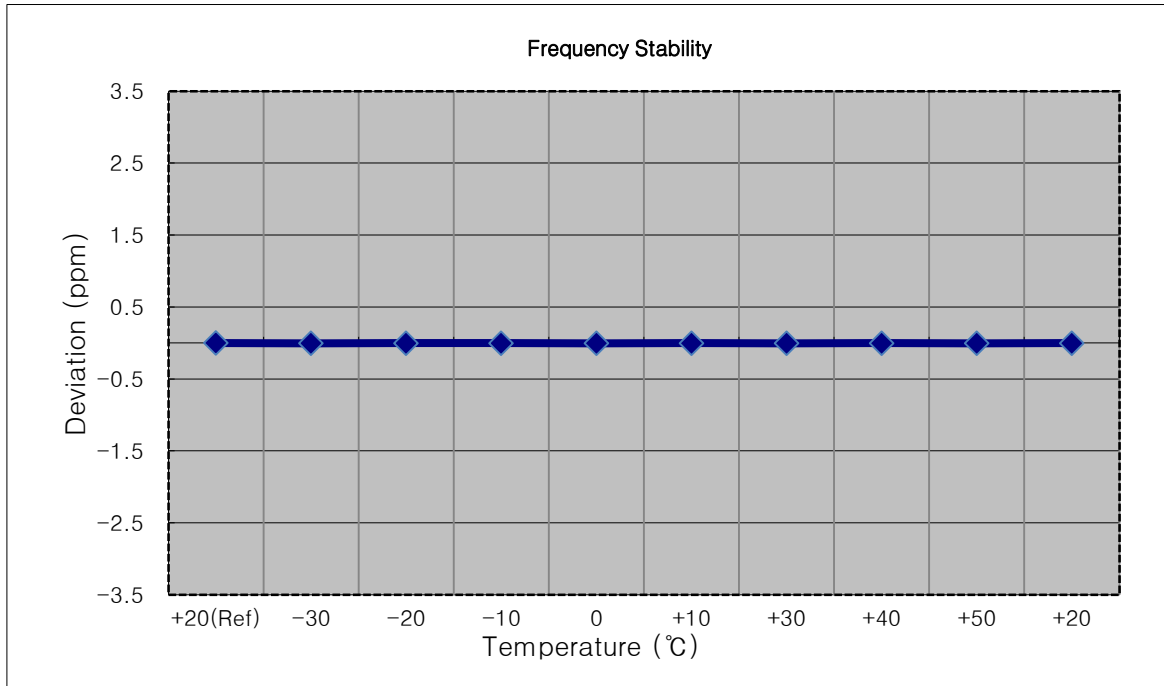

8.7.7 FREQUENCY STABILITY (1.4 MHz Band 5 LTE)

- ▣ OPERATING FREQUENCY: 836,500,000 Hz
- ▣ CHANNEL: 20525 (1.4 MHz)
- ▣ REFERENCE VOLTAGE: 3.85 VDC
- ▣ DEVIATION LIMIT: ± 0.000 25 % or 2.5 ppm

| Voltage (%) | Power (VDC) | Temp. (°C) | Frequency (Hz) | Frequency Error (Hz) | Deviation (%) | ppm |
|----------------|-------------|------------|----------------|----------------------|---------------|-----------|
| 100% | 3.85 | +20(Ref) | 836 499 995 | 0.0 | 0.000 000 | 0.000 |
| 100% | | -30 | 836 499 991 | -4.0 | 0.000 000 | -0.005 |
| 100% | | -20 | 836 499 990 | -5.0 | -0.000 001 | -0.006 |
| 100% | | -10 | 836 499 998 | 3.2 | 0.000 000 | 0.004 |
| 100% | | 0 | 836 499 992 | -2.7 | 0.000 000 | -0.003 |
| 100% | | +10 | 836 499 998 | 3.2 | 0.000 000 | 0.004 |
| 100% | | +30 | 836 499 992 | -3.0 | 0.000 000 | -0.004 |
| 100% | | +40 | 836 499 989 | -5.9 | -0.000 001 | -0.007 |
| 100% | | +50 | 836 499 988 | -6.7 | -0.000 001 | -0.008 |
| Batt. Endpoint | | 3.40 | +20 | 836 499 990 | -4.1 | 0.000 000 |

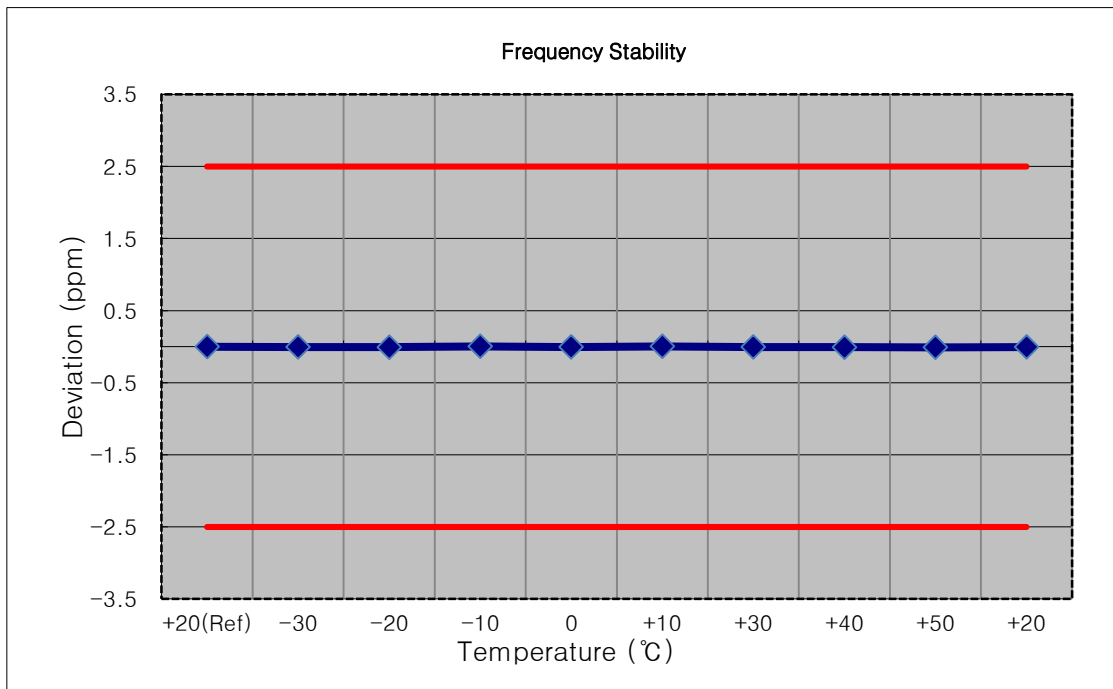

8.7.8 FREQUENCY STABILITY (3 MHz Band 5 LTE)

- ▣ OPERATING FREQUENCY: 836,500,000 Hz
- ▣ CHANNEL: 20525 (3 MHz)
- ▣ REFERENCE VOLTAGE: 3.85 VDC
- ▣ DEVIATION LIMIT: ± 0.000 25 % or 2.5 ppm

| Voltage (%) | Power (VDC) | Temp. (°C) | Frequency (Hz) | Frequency Error (Hz) | Deviation (%) | ppm |
|----------------|-------------|------------|----------------|----------------------|---------------|-----------|
| 100% | 3.85 | +20(Ref) | 836 499 996 | 0.0 | 0.000 000 | 0.000 |
| 100% | | -30 | 836 499 993 | -3.3 | 0.000 000 | -0.004 |
| 100% | | -20 | 836 500 000 | 3.5 | 0.000 000 | 0.004 |
| 100% | | -10 | 836 499 993 | -3.4 | 0.000 000 | -0.004 |
| 100% | | 0 | 836 500 000 | 4.1 | 0.000 000 | 0.005 |
| 100% | | +10 | 836 499 993 | -3.2 | 0.000 000 | -0.004 |
| 100% | | +30 | 836 499 999 | 2.9 | 0.000 000 | 0.003 |
| 100% | | +40 | 836 499 991 | -4.8 | -0.000 001 | -0.006 |
| 100% | | +50 | 836 499 993 | -3.6 | 0.000 000 | -0.004 |
| Batt. Endpoint | | 3.40 | +20 | 836 499 993 | -3.1 | 0.000 000 |

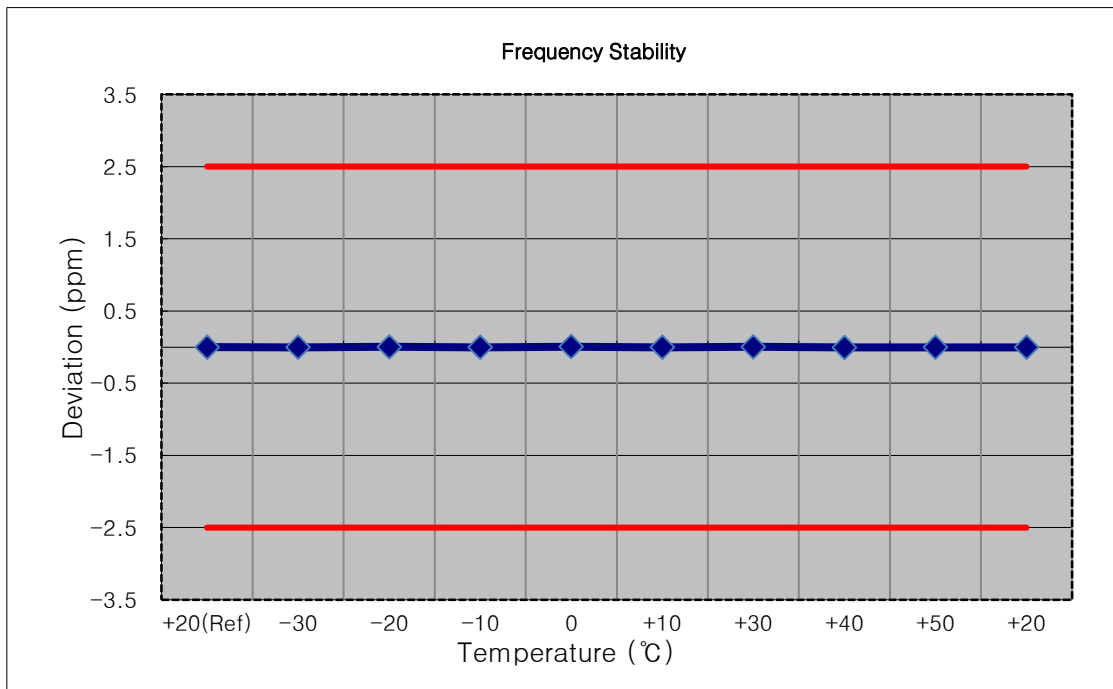

8.7.9 FREQUENCY STABILITY (5 MHz Band 5 LTE)

- ▣ OPERATING FREQUENCY: 836,500,000 Hz
- ▣ CHANNEL: 20525 (5 MHz)
- ▣ REFERENCE VOLTAGE: 3.85 VDC
- ▣ DEVIATION LIMIT: ± 0.000 25 % or 2.5 ppm

| Voltage (%) | Power (VDC) | Temp. (°C) | Frequency (Hz) | Frequency Error (Hz) | Deviation (%) | ppm |
|----------------|-------------|------------|----------------|----------------------|---------------|-----------|
| 100% | 3.85 | +20(Ref) | 836 499 998 | 0.0 | 0.000 000 | 0.000 |
| 100% | | -30 | 836 499 993 | -4.7 | -0.000 001 | -0.006 |
| 100% | | -20 | 836 499 994 | -3.9 | 0.000 000 | -0.005 |
| 100% | | -10 | 836 499 994 | -3.6 | 0.000 000 | -0.004 |
| 100% | | 0 | 836 499 994 | -3.1 | 0.000 000 | -0.004 |
| 100% | | +10 | 836 499 995 | -3.0 | 0.000 000 | -0.004 |
| 100% | | +30 | 836 500 000 | 2.0 | 0.000 000 | 0.002 |
| 100% | | +40 | 836 499 996 | -1.7 | 0.000 000 | -0.002 |
| 100% | | +50 | 836 499 993 | -4.2 | -0.000 001 | -0.005 |
| Batt. Endpoint | | 3.40 | +20 | 836 499 995 | -3.0 | 0.000 000 |

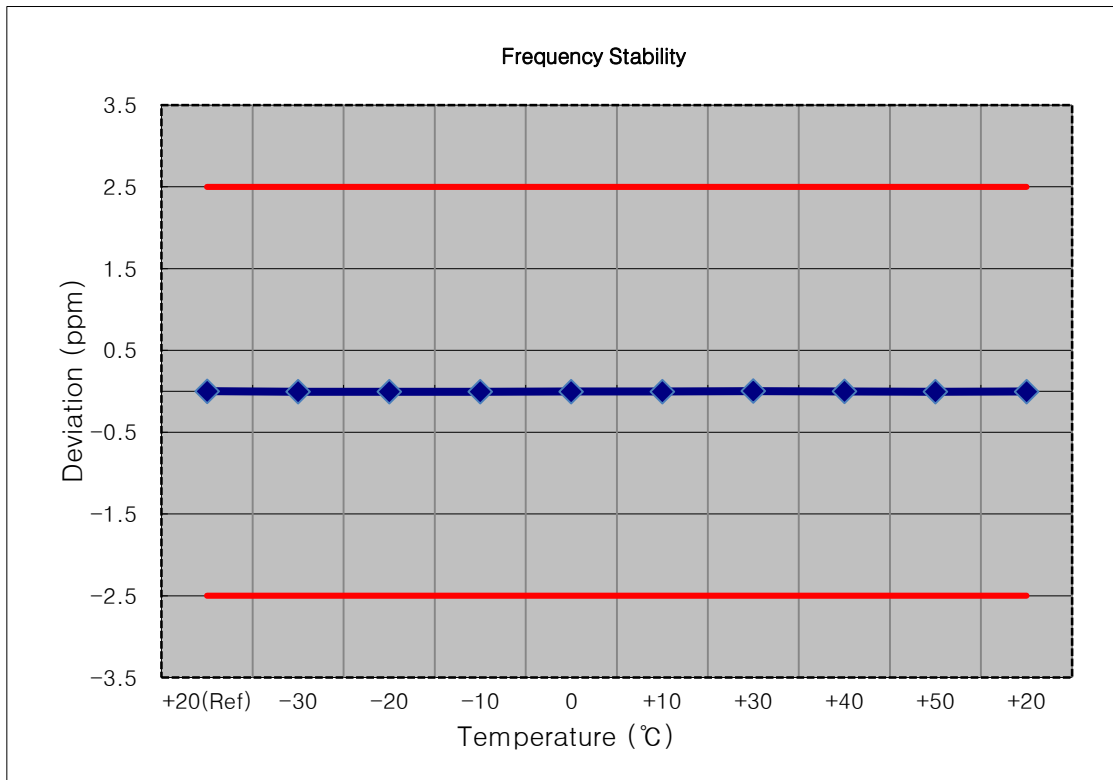

8.7.10 FREQUENCY STABILITY (10 MHz Band 5 LTE)

- ▣ OPERATING FREQUENCY: 836,500,000 Hz
- ▣ CHANNEL: 20525 (10 MHz)
- ▣ REFERENCE VOLTAGE: 3.85 VDC
- ▣ DEVIATION LIMIT: ± 0.000 25 % or 2.5 ppm

| Voltage (%) | Power (VDC) | Temp. (°C) | Frequency (Hz) | Frequency Error (Hz) | Deviation (%) | ppm |
|----------------|-------------|------------|----------------|----------------------|---------------|-----------|
| 100% | 3.85 | +20(Ref) | 836 500 003 | 0.0 | 0.000 000 | 0.000 |
| 100% | | -30 | 836 500 001 | -2.2 | 0.000 000 | -0.003 |
| 100% | | -20 | 836 500 006 | 2.6 | 0.000 000 | 0.003 |
| 100% | | -10 | 836 500 001 | -2.5 | 0.000 000 | -0.003 |
| 100% | | 0 | 836 500 000 | -3.1 | 0.000 000 | -0.004 |
| 100% | | +10 | 836 500 000 | -3.2 | 0.000 000 | -0.004 |
| 100% | | +30 | 836 500 000 | -3.1 | 0.000 000 | -0.004 |
| 100% | | +40 | 836 500 005 | 2.1 | 0.000 000 | 0.003 |
| 100% | | +50 | 836 500 006 | 2.6 | 0.000 000 | 0.003 |
| Batt. Endpoint | | 3.40 | +20 | 836 500 001 | -2.4 | 0.000 000 |

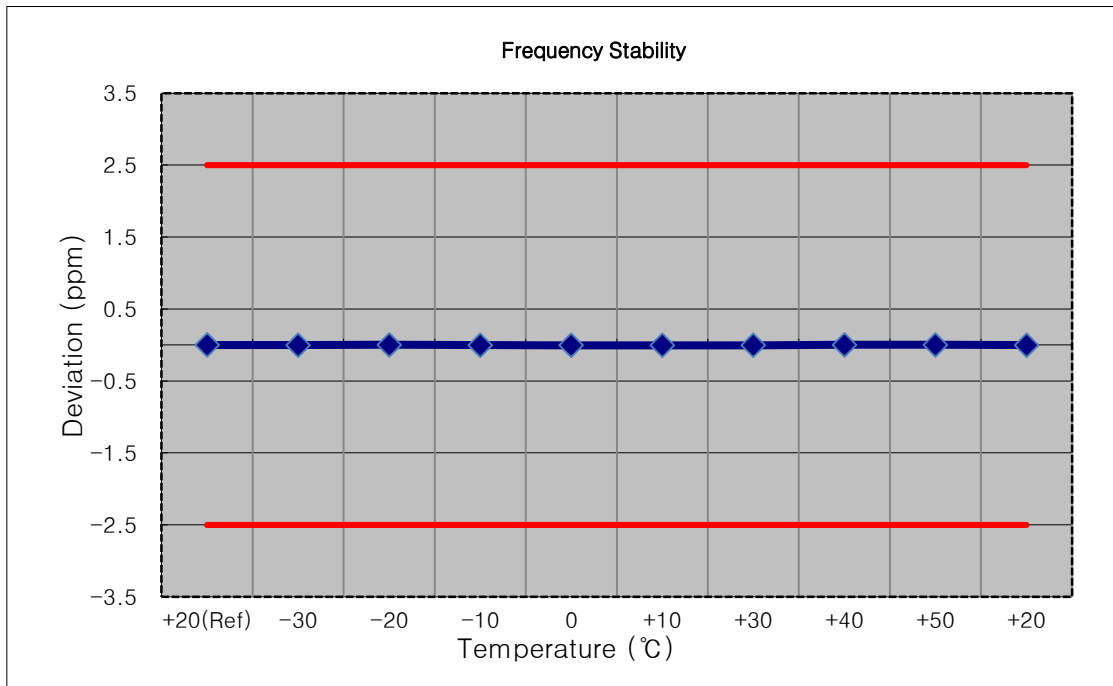

9. TEST PLOTS

BAND 2. Occupied Bandwidth Plot (1.4M BW Ch.18900 QPSK RB 6_0)

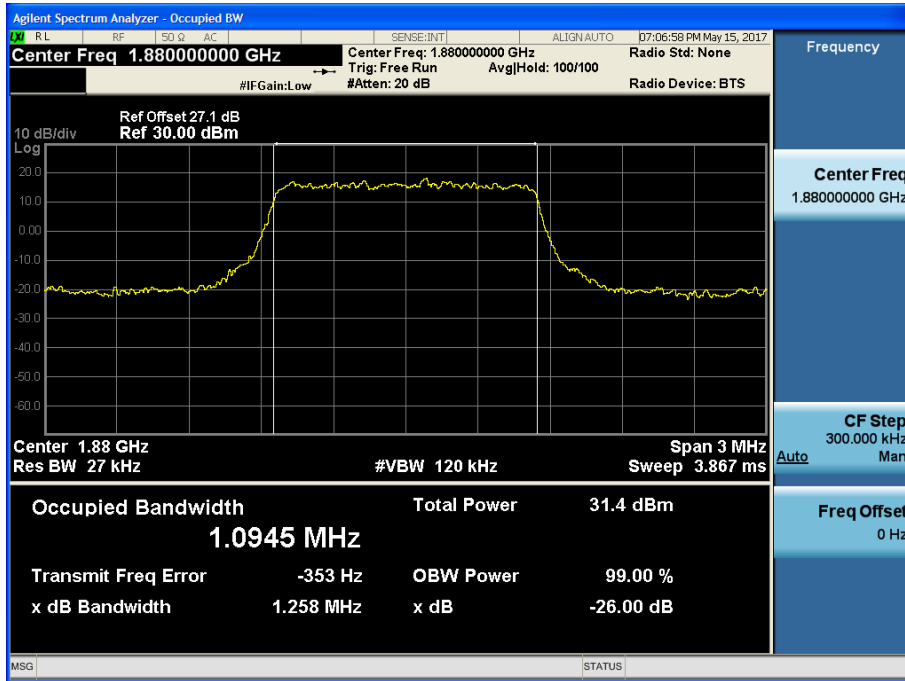

BAND 2. Occupied Bandwidth Plot (1.4M BW Ch.18900 16QAM RB 6_0)

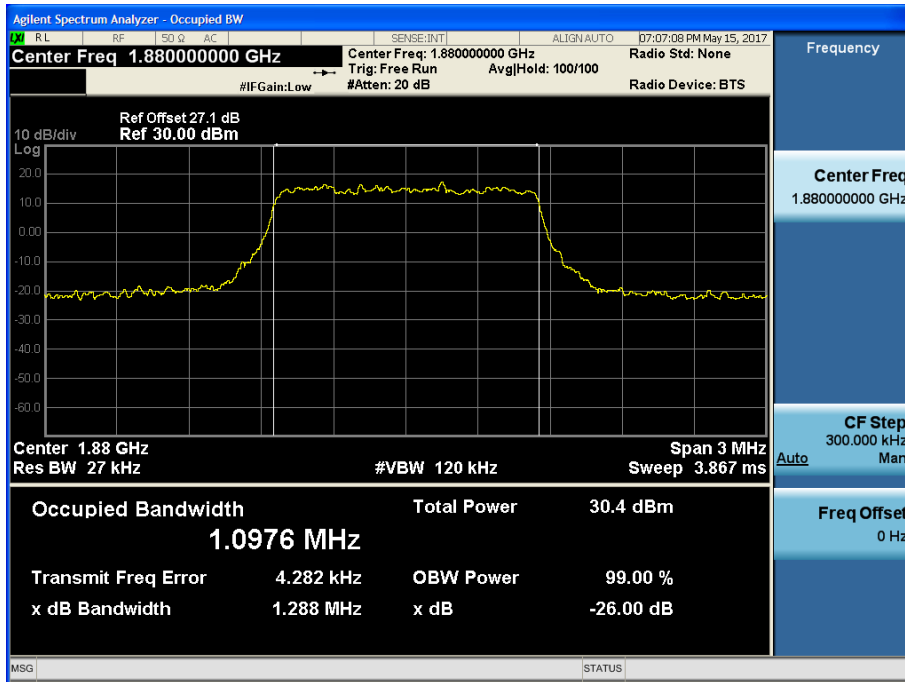

BAND 2. Occupied Bandwidth Plot (3M BW Ch.18900 QPSK RB 15_0)

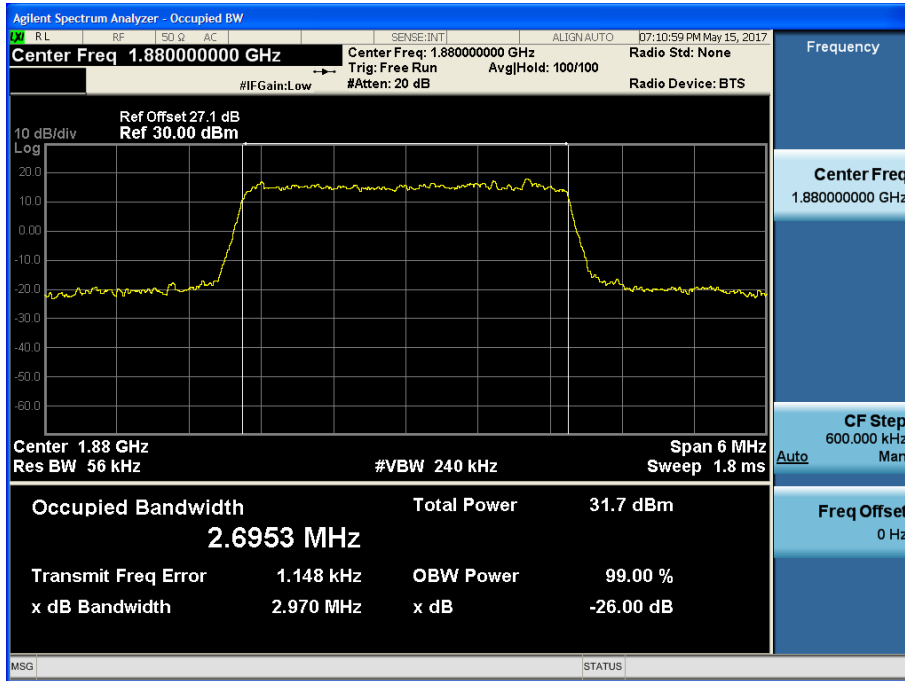

BAND 2. Occupied Bandwidth Plot (3M BW Ch.18900 16QAM RB 15_0)

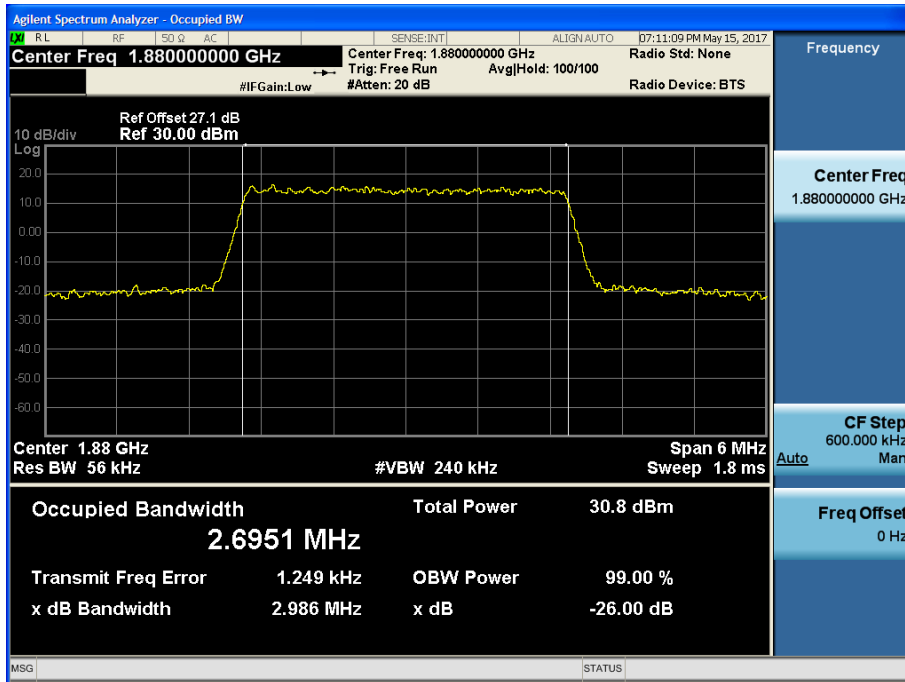

BAND 2. Occupied Bandwidth Plot (5M BW Ch.18900 QPSK RB 25_0)

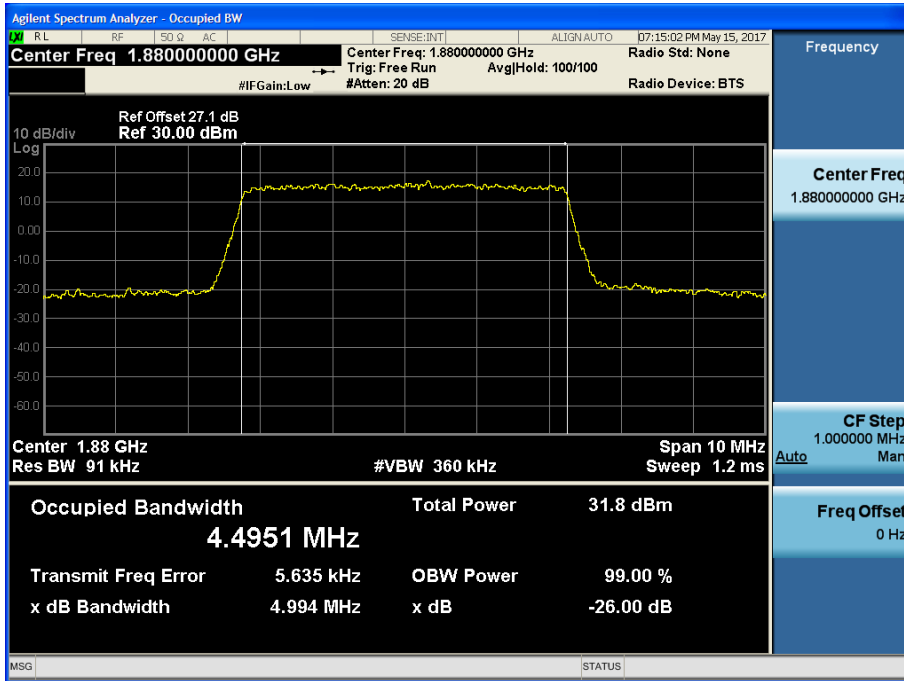

BAND 2. Occupied Bandwidth Plot (5M BW Ch.18900 16QAM RB 25_0)

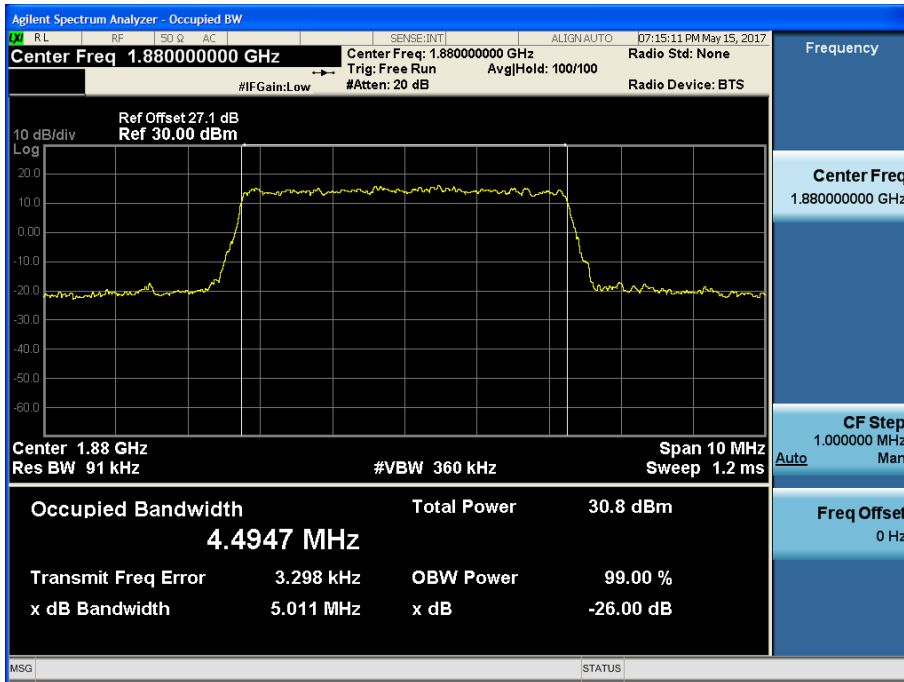

BAND 2. Occupied Bandwidth Plot (10M BW Ch.18900 QPSK RB 50_0)

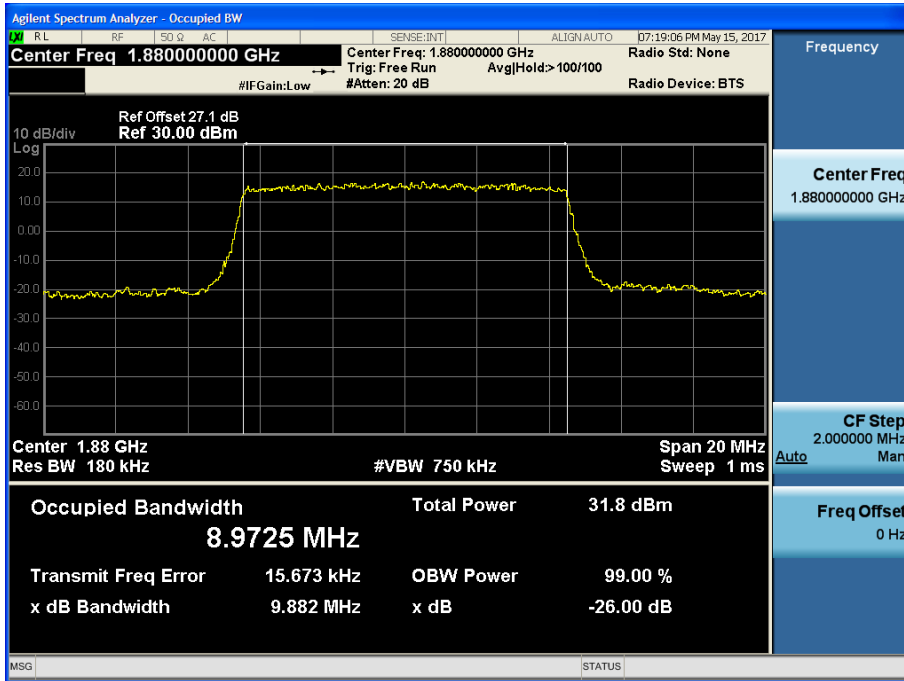

BAND 2. Occupied Bandwidth Plot (10M BW Ch.18900 16QAM RB 50_0)

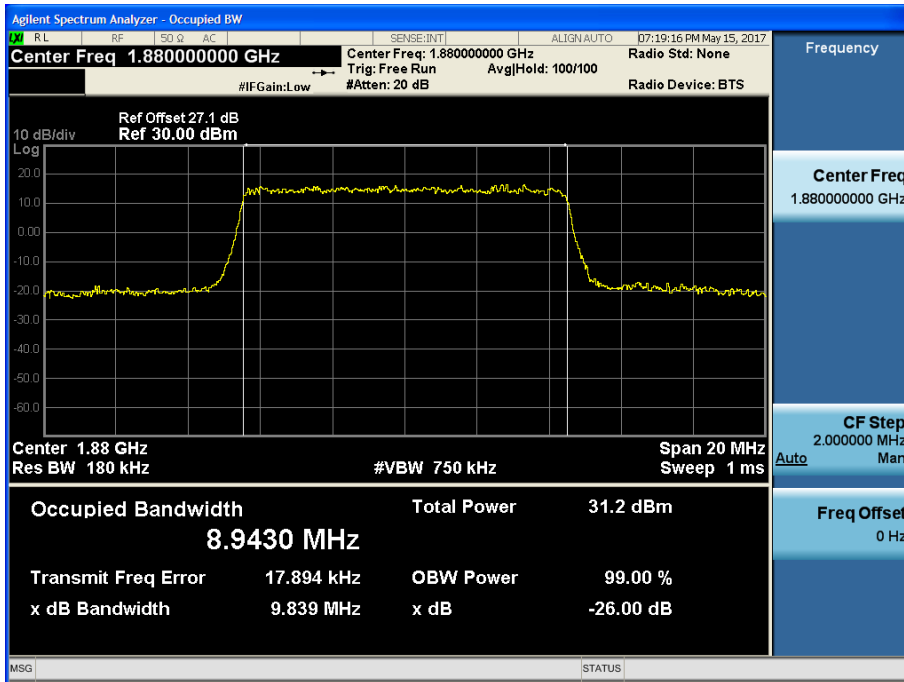

BAND 2. Occupied Bandwidth Plot (15M BW Ch.18900 QPSK RB 75_0)

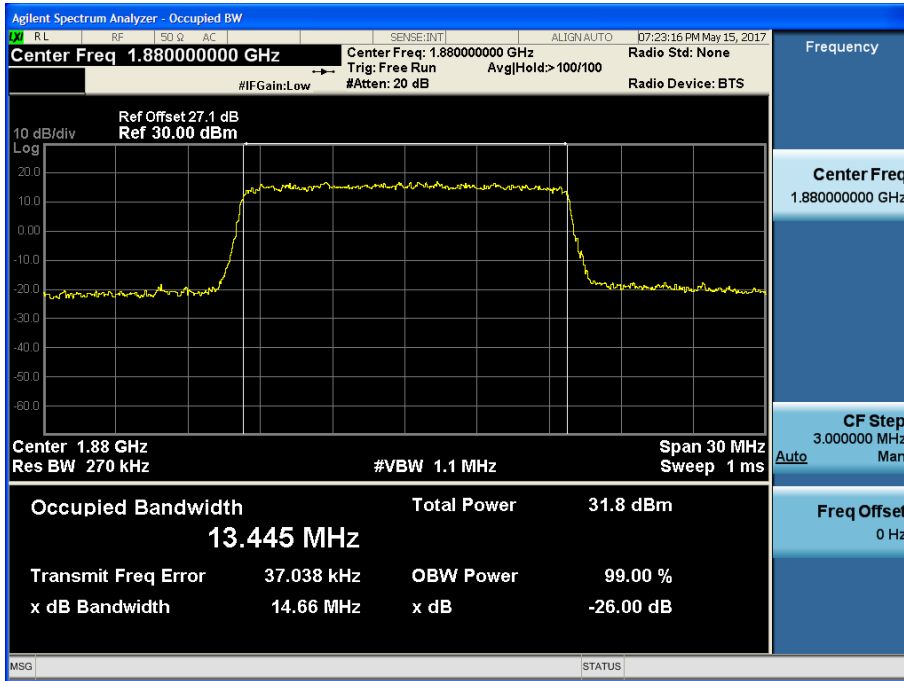

BAND 2. Occupied Bandwidth Plot (15M BW Ch.18900 16QAM RB 75_0)

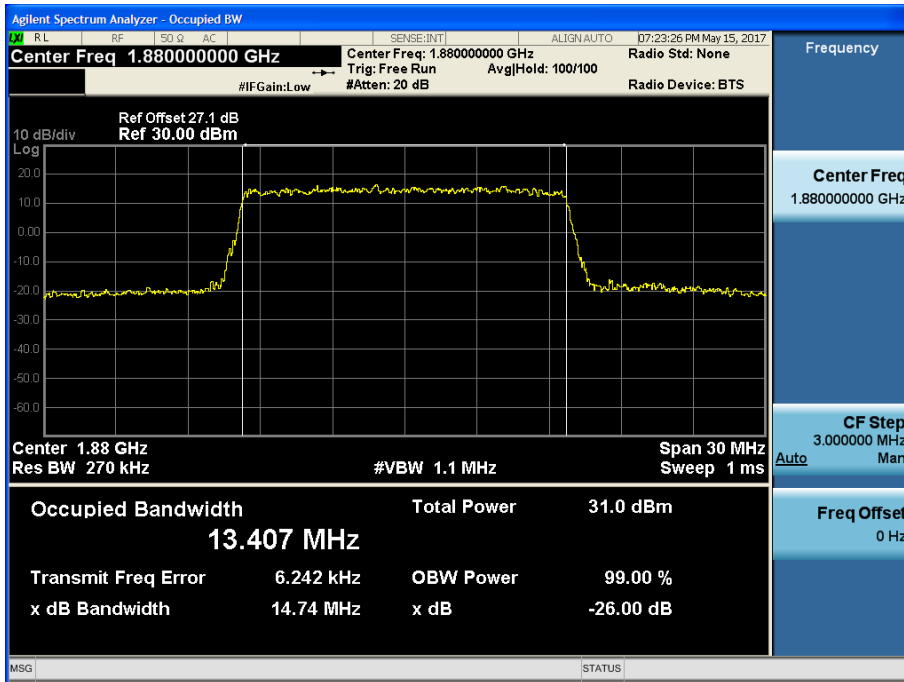

BAND 2. Occupied Bandwidth Plot (20M BW Ch.18900 QPSK RB 100_0)

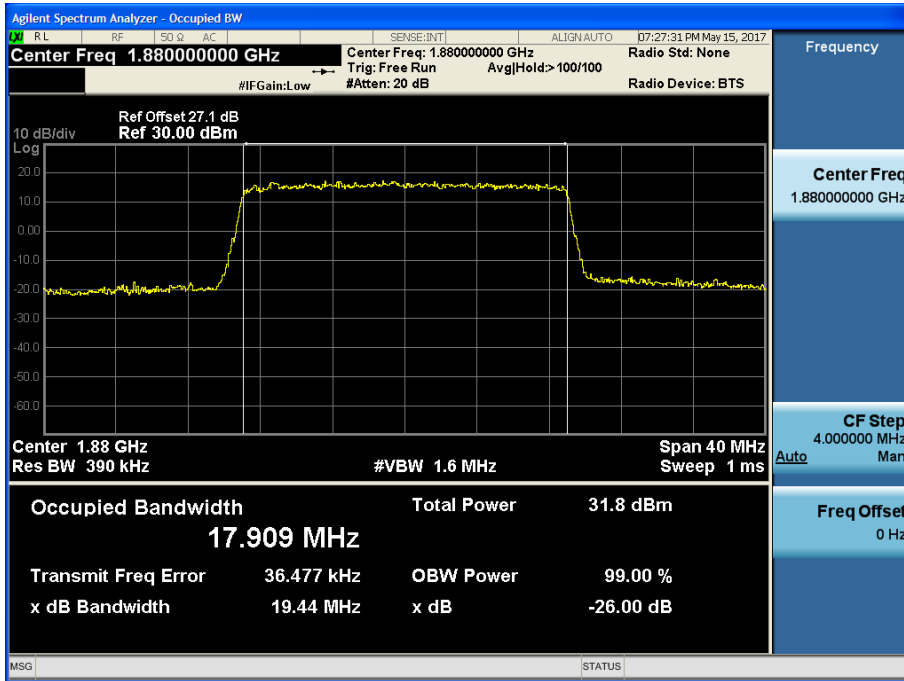

BAND 2. Occupied Bandwidth Plot (20M BW Ch.18900 16QAM RB 100_0)

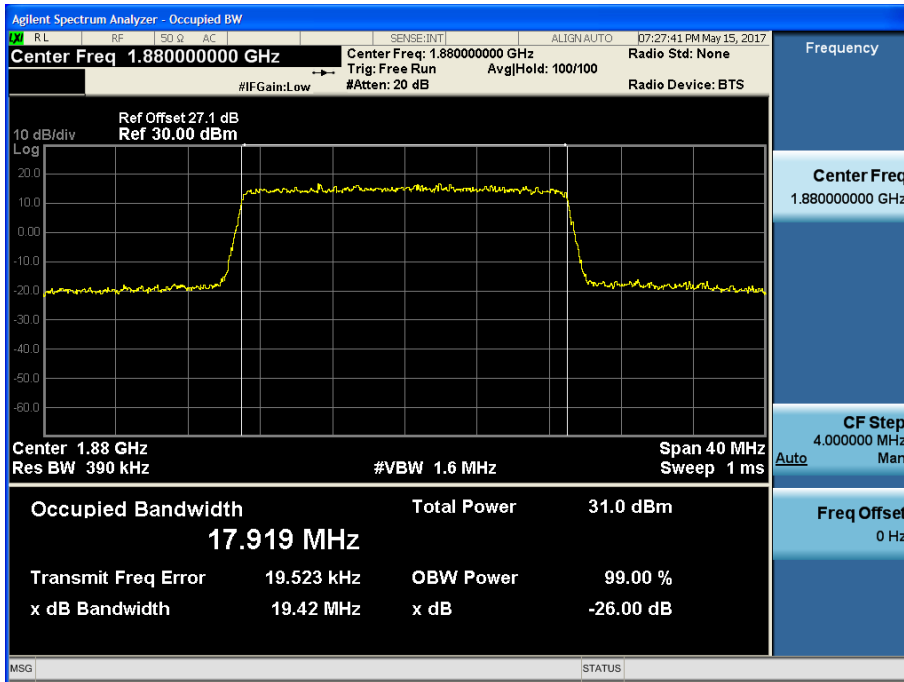

BAND 5. Occupied Bandwidth Plot (1.4M BW Ch.20525 QPSK_RB6_0)

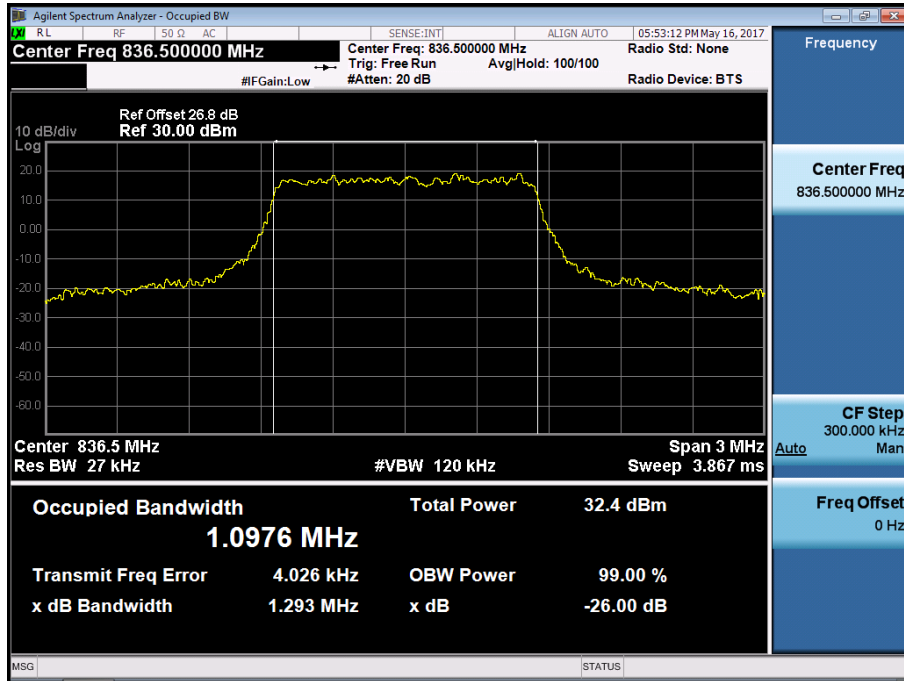

BAND 5. Occupied Bandwidth Plot (1.4M BW Ch.20525 16QAM_RB6_0)

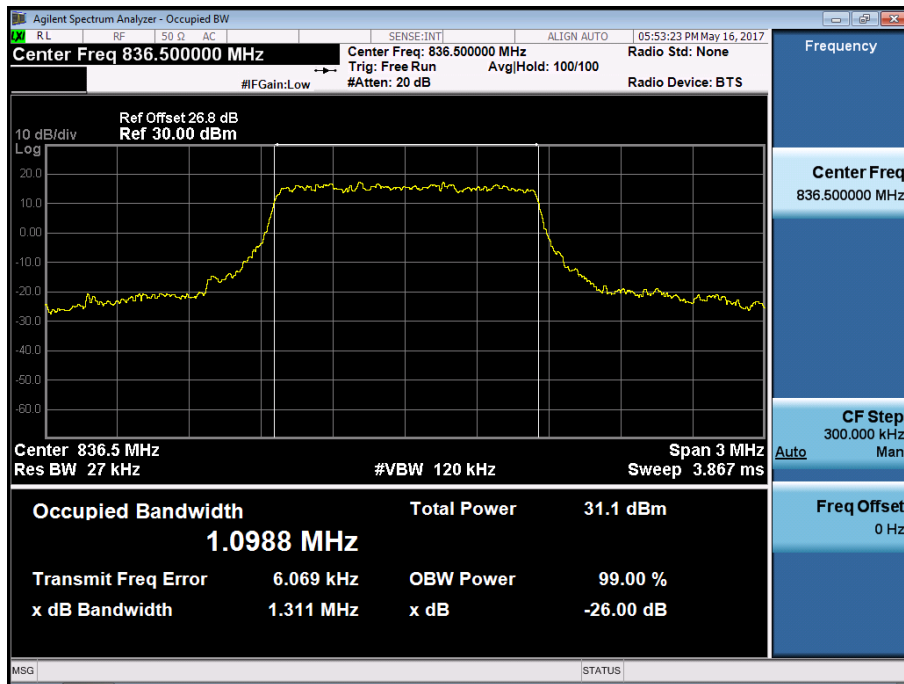

BAND 5. Occupied Bandwidth Plot (3M BW Ch.20525 QPSK_RB15_0)

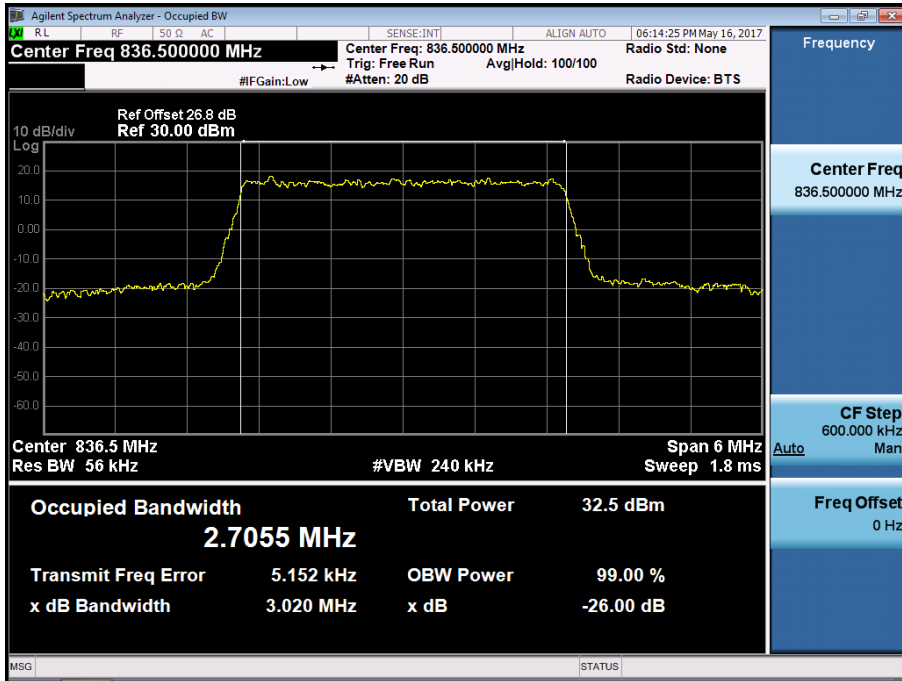

BAND 5. Occupied Bandwidth Plot (3M BW Ch.20525 16QAM_RB15_0)

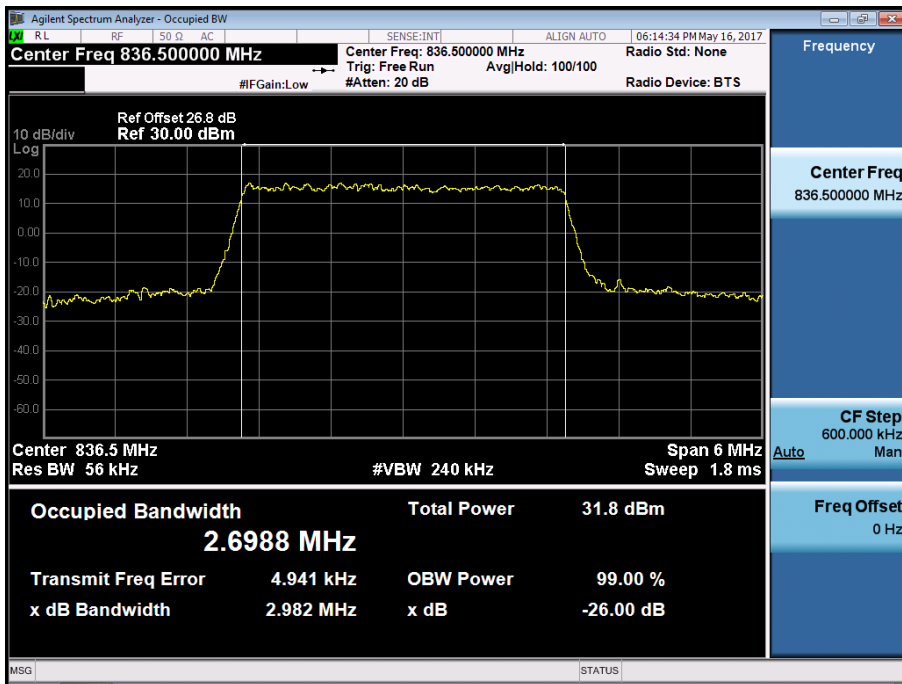

BAND 5. Occupied Bandwidth Plot (5M BW Ch.20525 QPSK_RB25_0)

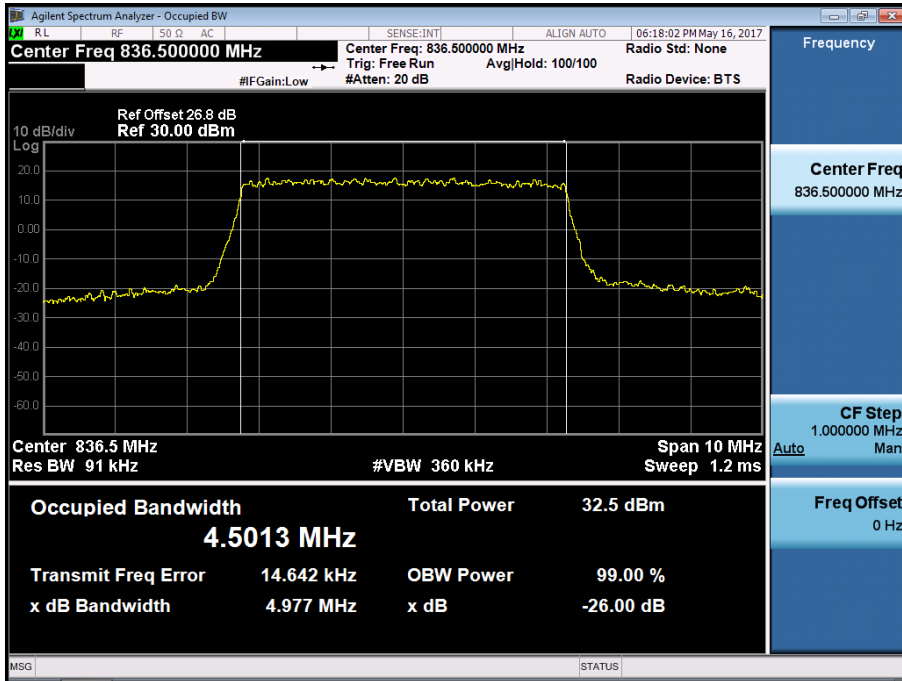

BAND 5. Occupied Bandwidth Plot (5M BW Ch.20525 16QAM_RB25_0)

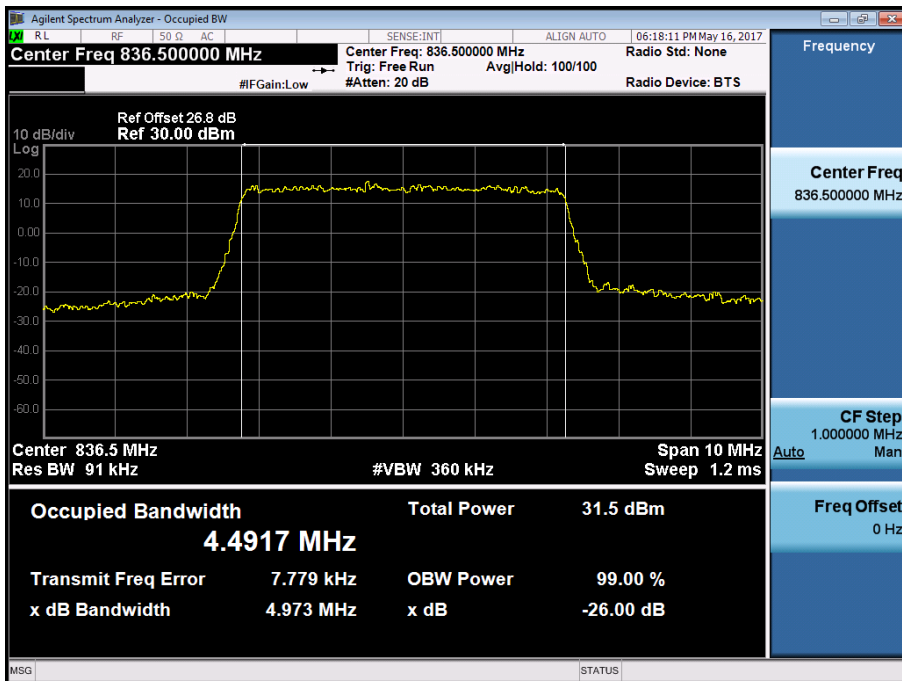

BAND 5. Occupied Bandwidth Plot (10M BW Ch.20525 QPSK_RB50_0)

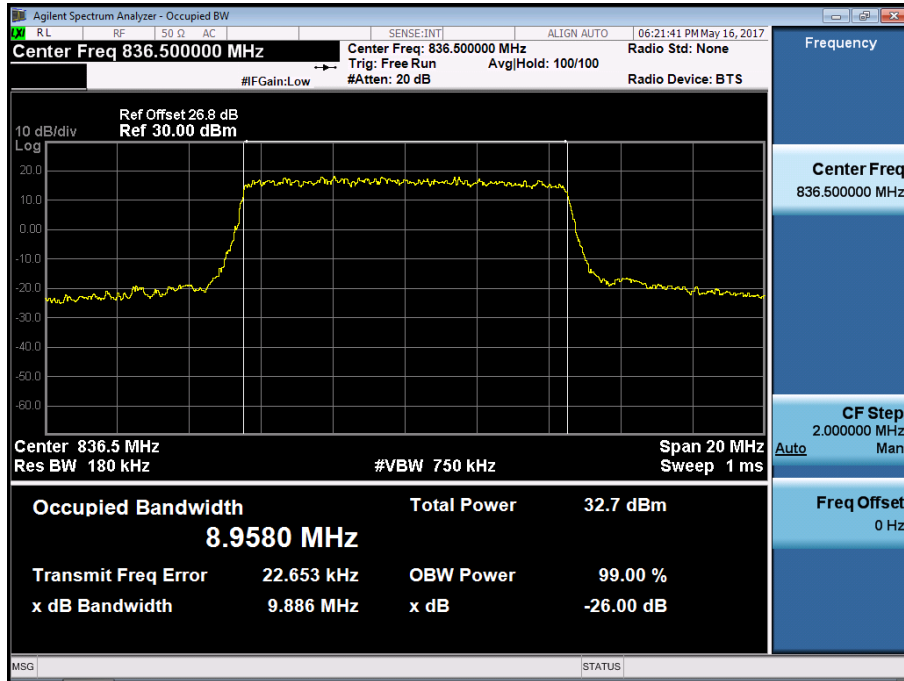

BAND 5. Occupied Bandwidth Plot (10M BW Ch.20525 16QAM_RB50_0)

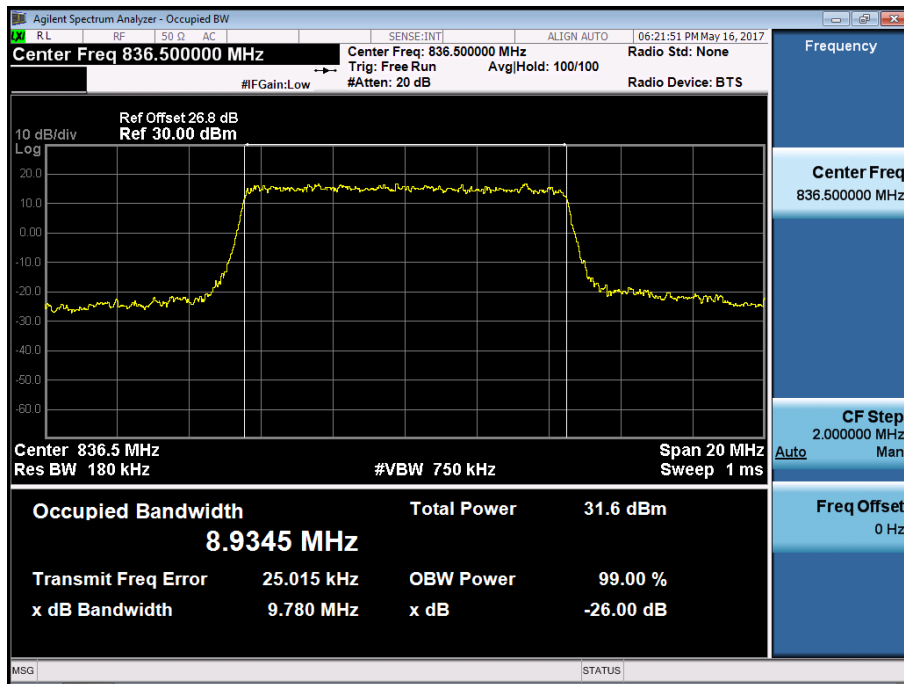

BAND 2. PAR Plot (1.4M BW Ch.18900 QPSK RB 6_0)

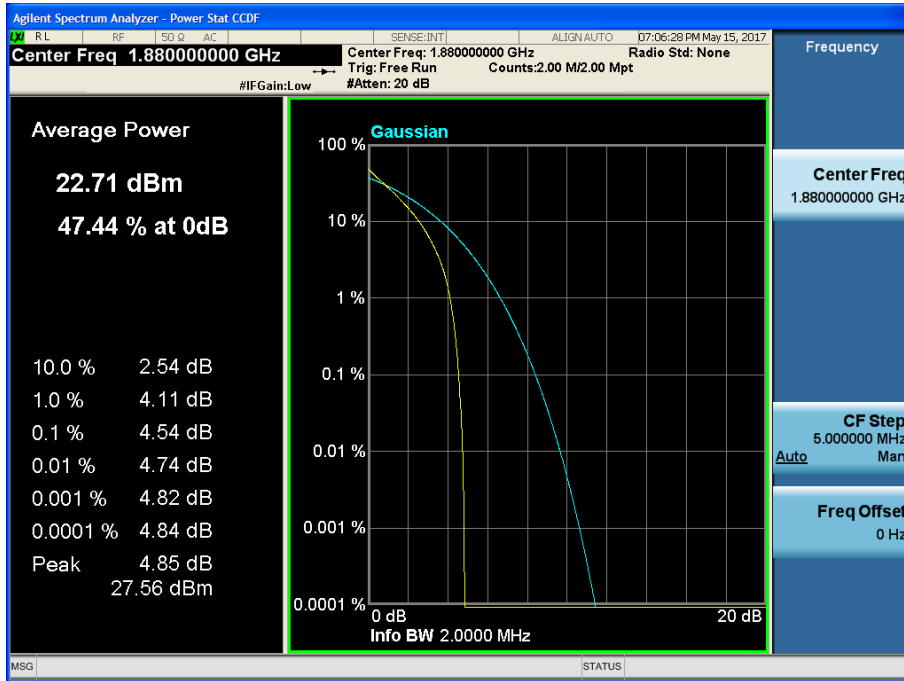

BAND 2. PAR Plot (1.4M BW Ch.18900 16QAM RB 6_0)

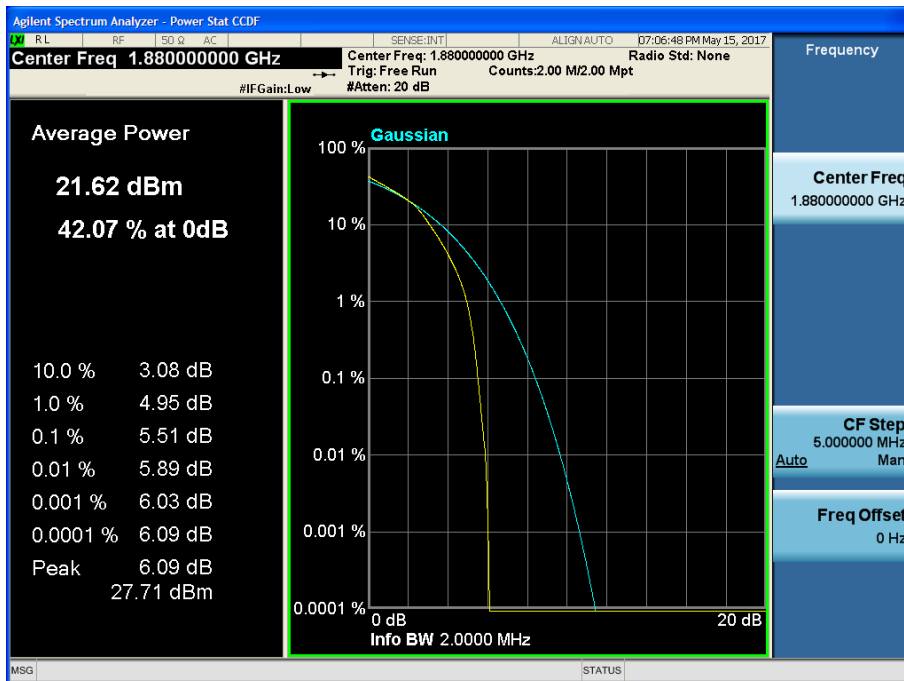

BAND 2. PAR Plot (3M BW Ch.18900 QPSK RB 15_0)

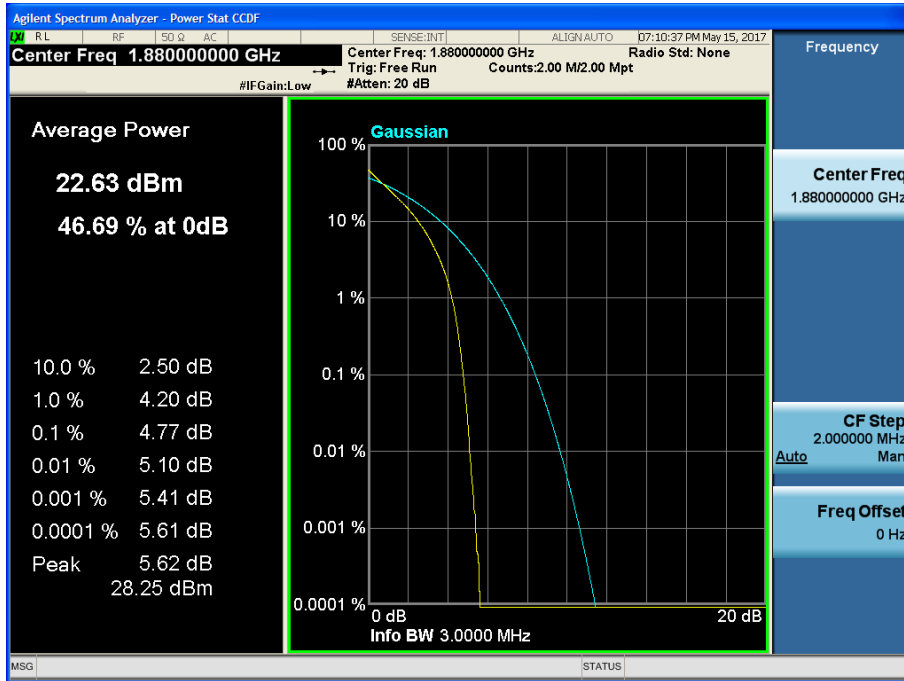

BAND 2. PAR Plot (3M BW Ch.18900 16QAM RB 15_0)



BAND 2. PAR Plot (5M BW Ch.18900 QPSK RB 25_0)

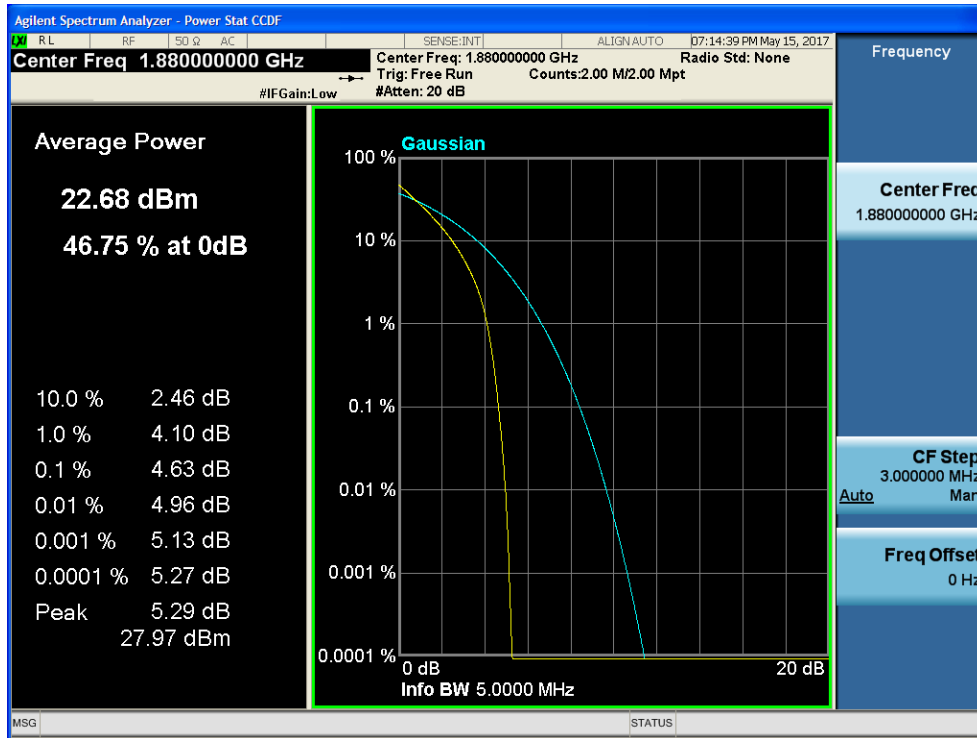

BAND 2. PAR Plot (5M BW Ch.18900 16QAM RB 25_0)

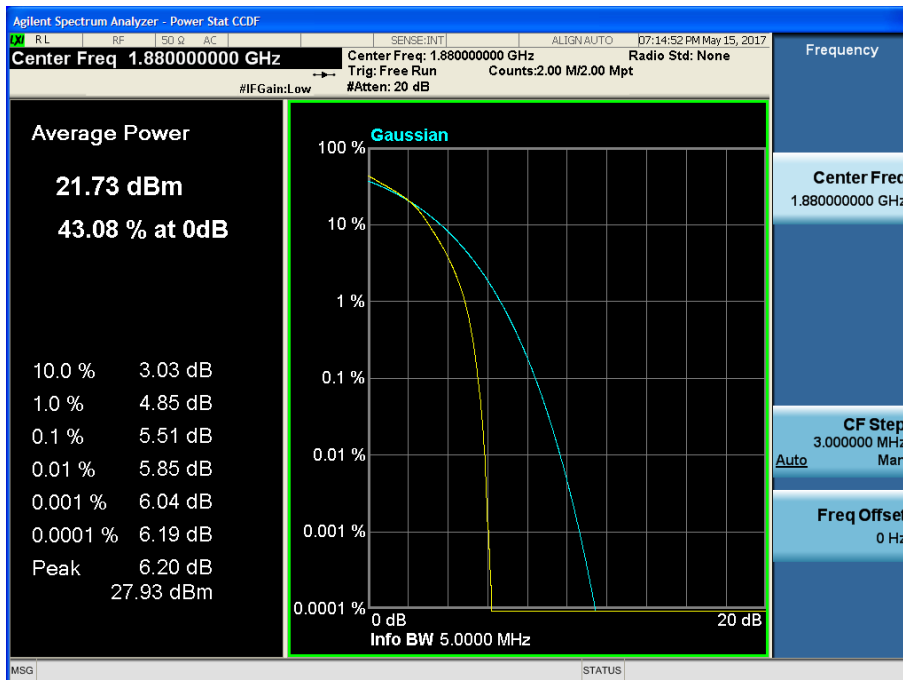

BAND 2. PAR Plot (10M BW Ch.18900 QPSK RB 50_0)

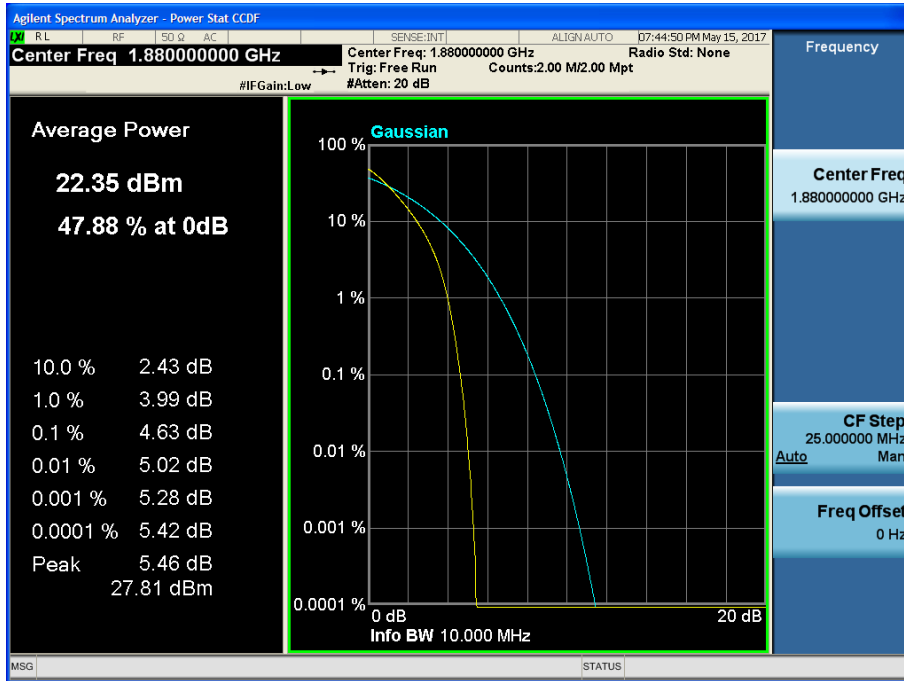

BAND 2. PAR Plot (10M BW Ch.18900 16QAM RB 50_0)



BAND 2. PAR Plot (15M BW Ch.18900 QPSK RB 75_0)

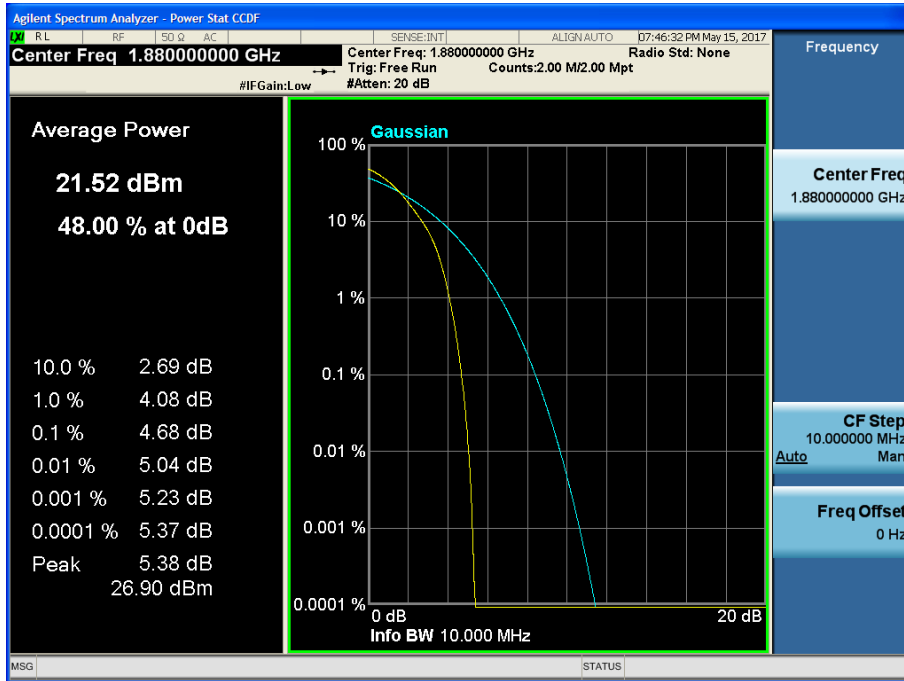

BAND 2. PAR Plot (15M BW Ch.18900 16QAM RB 75_0)

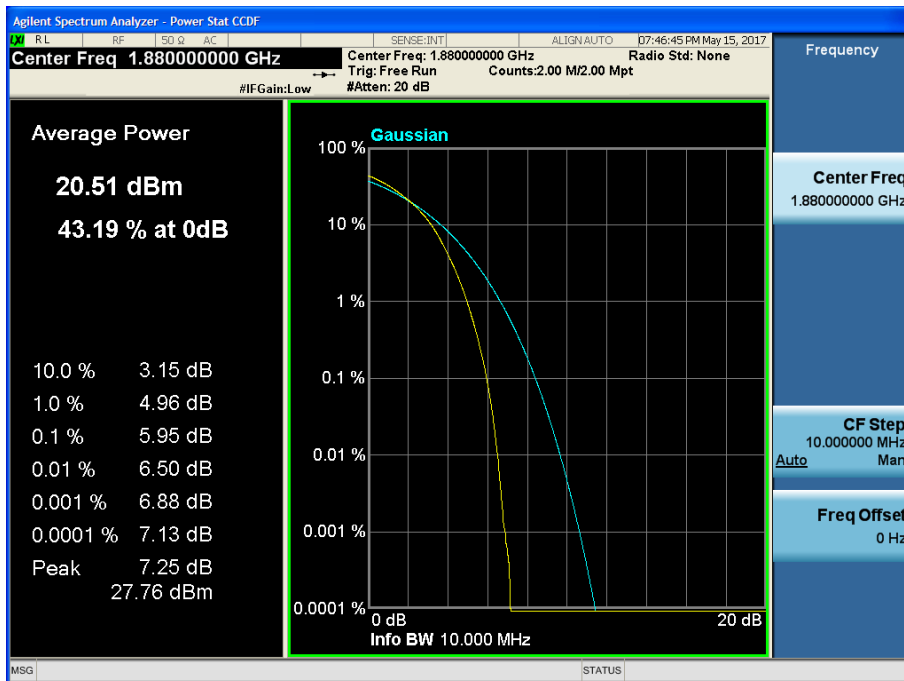

BAND 2. PAR Plot (20M BW Ch.18900 QPSK RB 100_0)

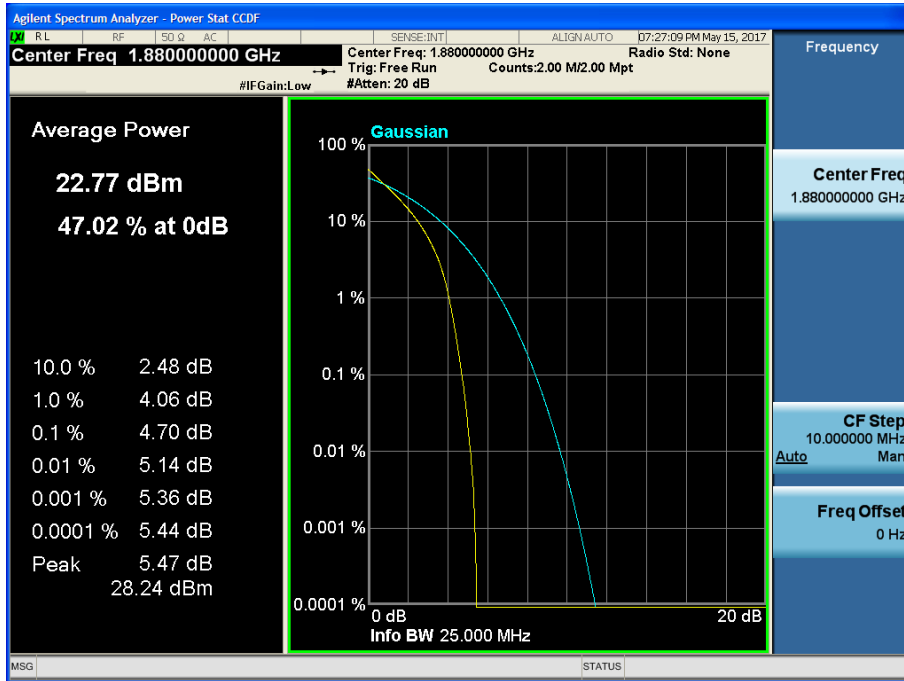

BAND 2. PAR Plot (20M BW Ch.18900 16QAM RB 100_0)

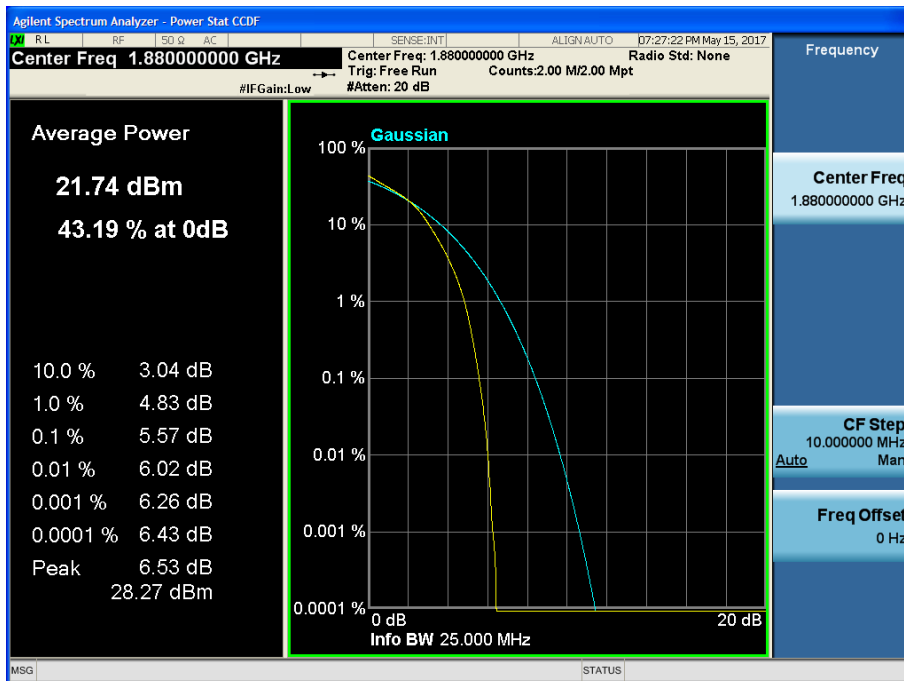

BAND 2. Lower Band Edge Plot (1.4M BW Ch.18607 QPSK_RB1_Offset 0) -1

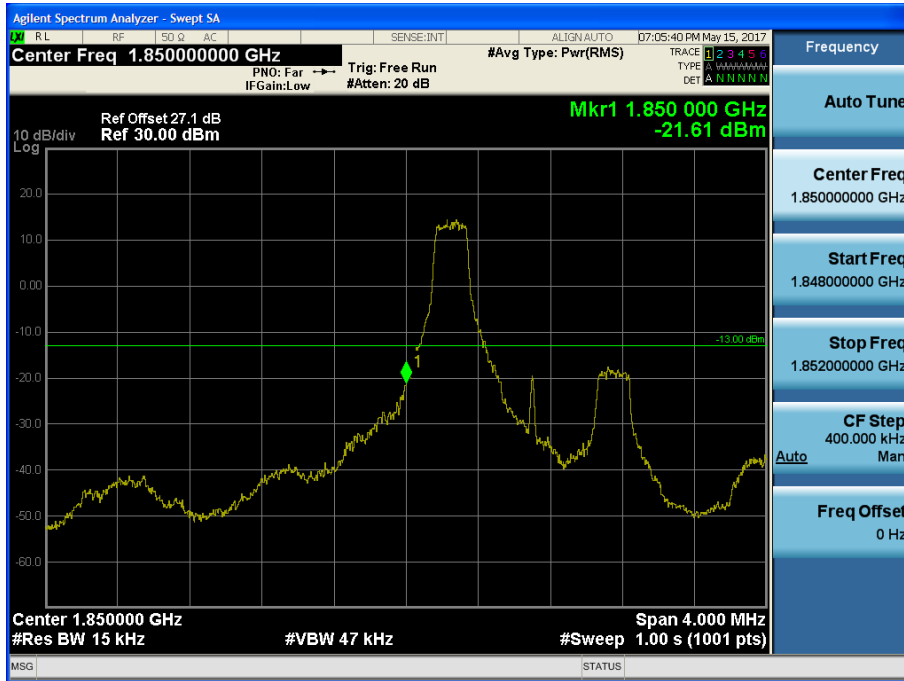

BAND 2. Lower Band Edge Plot (1.4M BW Ch.18607 QPSK_RB6_Offset 0) -2

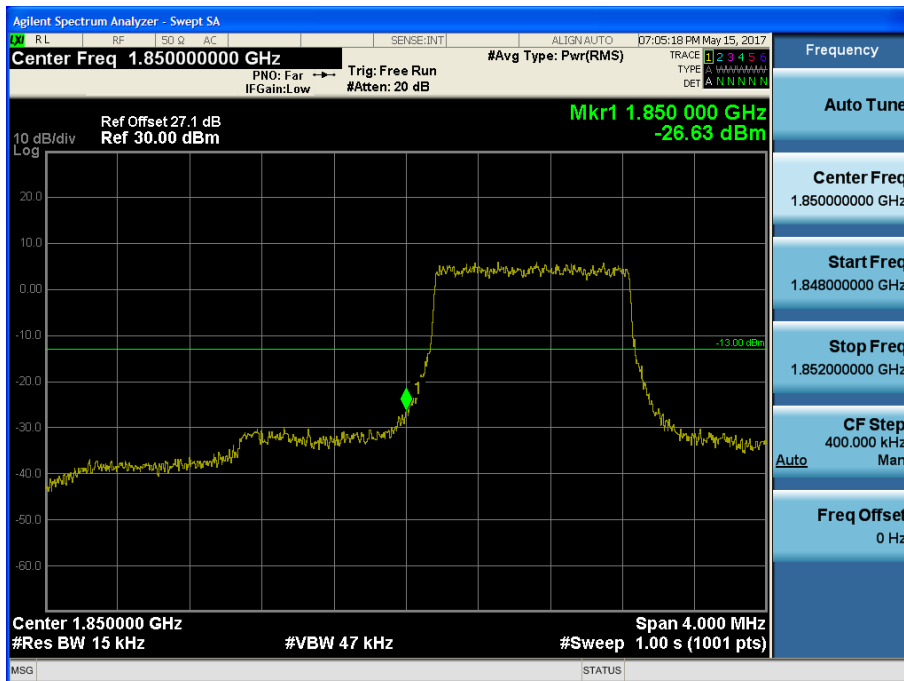

BAND 2. Lower Extended Band Edge Plot (1.4M BW Ch.18607 QPSK_RB6_0) -3



BAND 2. Lower Band Edge Plot (3M BW Ch.18615 QPSK_RB1_Offset 0) -1

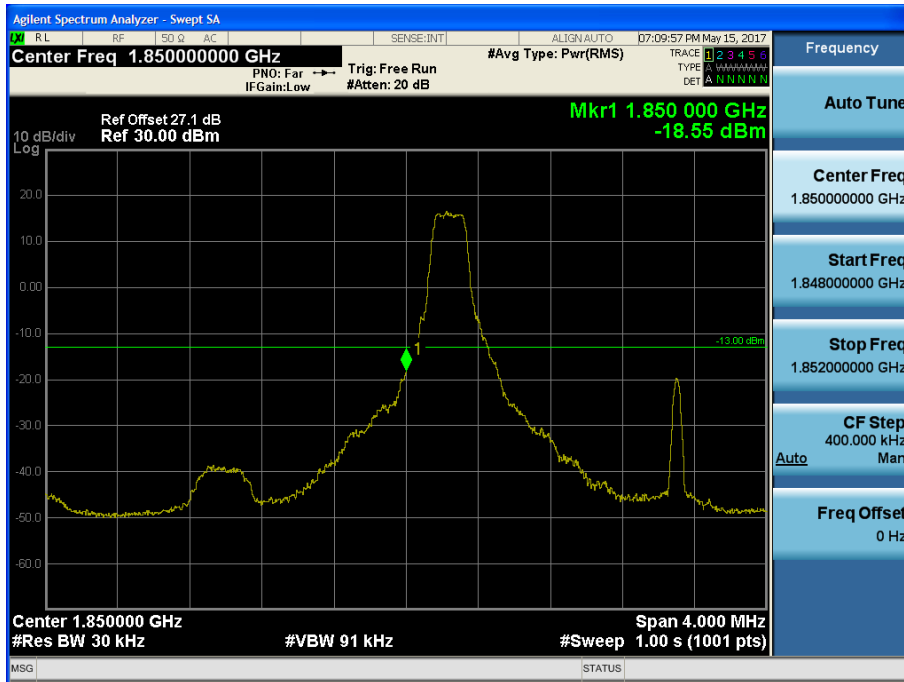

BAND 2. Lower Band Edge Plot (3M BW Ch.18615 QPSK_RB15_Offset 0) -2

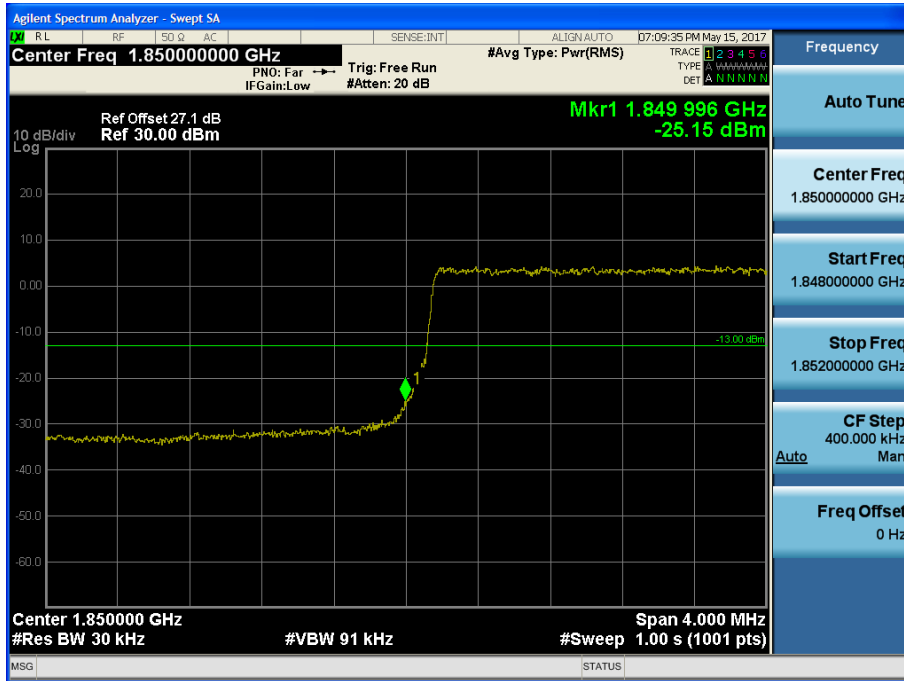

BAND 2. Lower Extended Band Edge Plot (3M BW Ch.18615 QPSK_RB15_0) -3

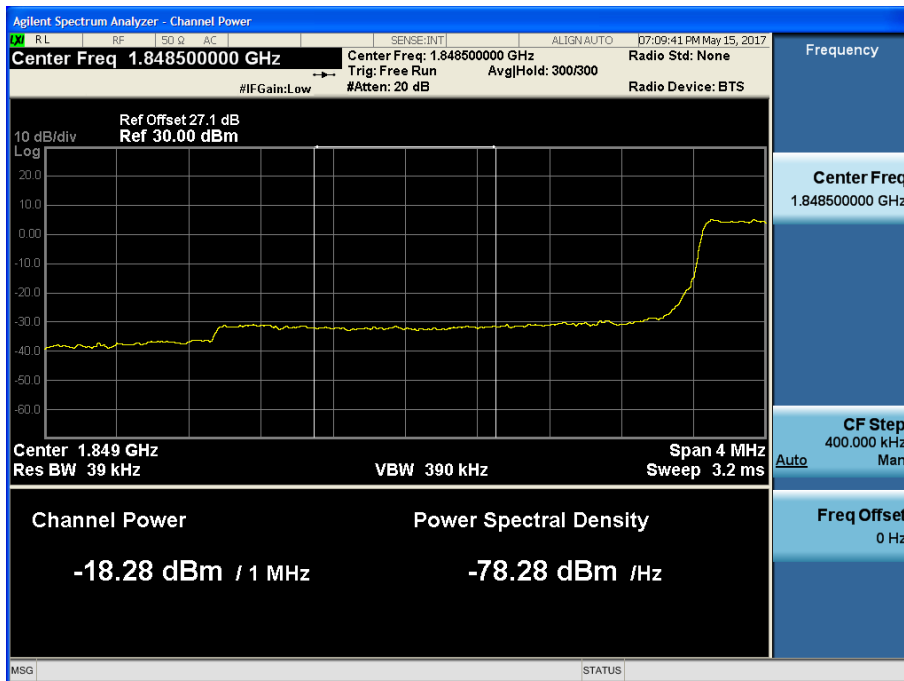

BAND 2. Lower Band Edge Plot (5M BW Ch.18625 QPSK_RB1_Offset 0) -1

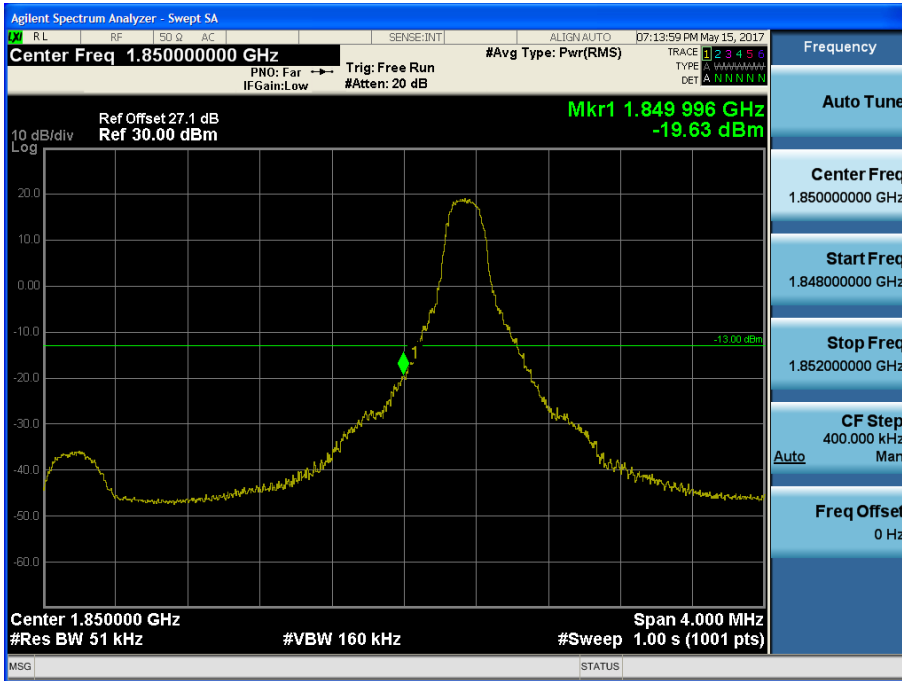

BAND 2. Lower Band Edge Plot (5M BW Ch.18625 QPSK_RB25_Offset 0) -2

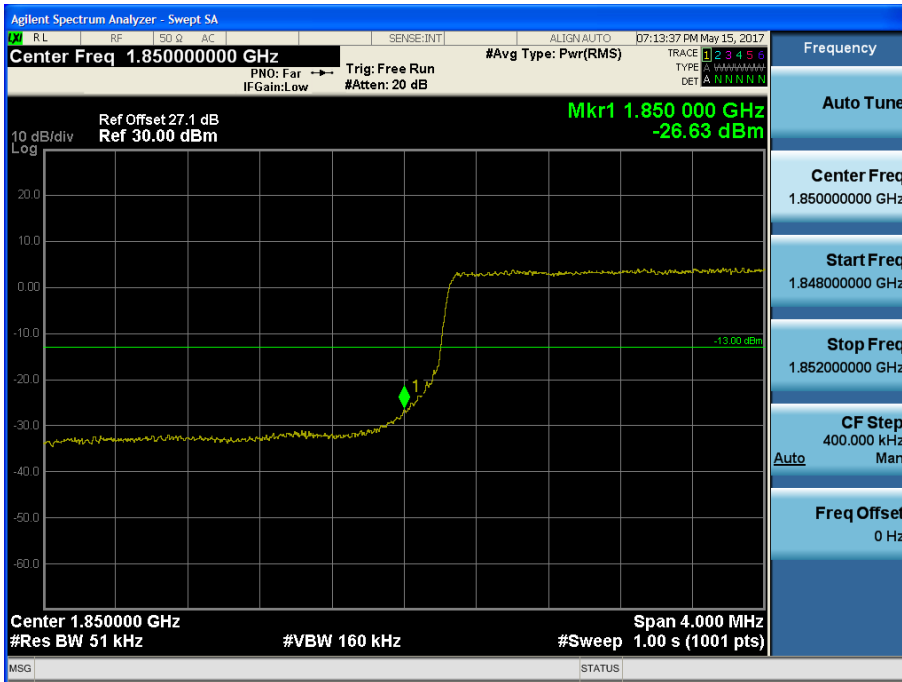

BAND 2. Lower Extended Band Edge Plot (5M BW Ch.18625 QPSK_RB25_0) -3

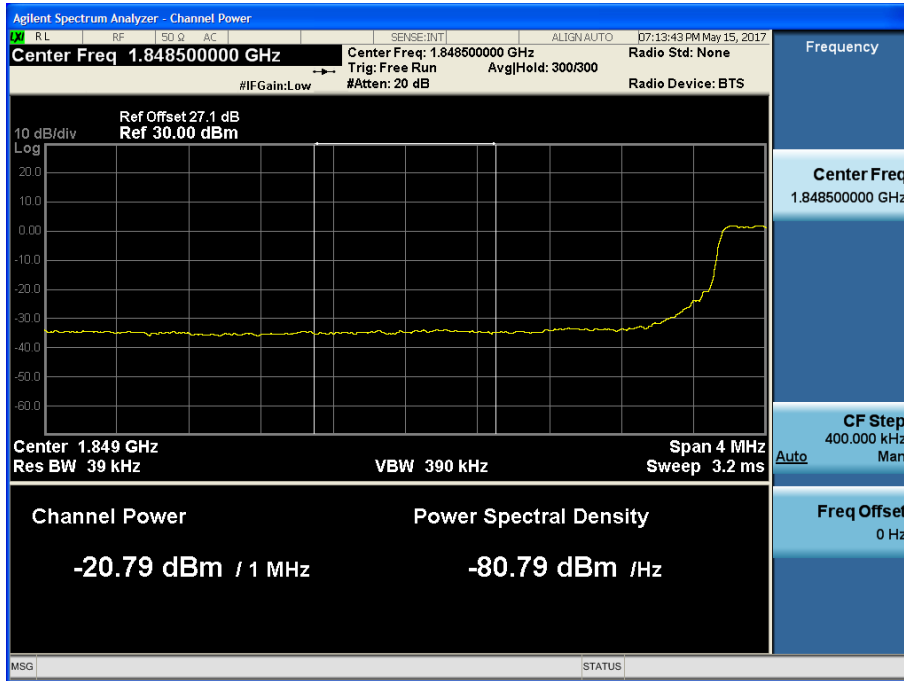

BAND 2. Lower Band Edge Plot (10M BW Ch.18650 QPSK_RB1_Offset 0) -1

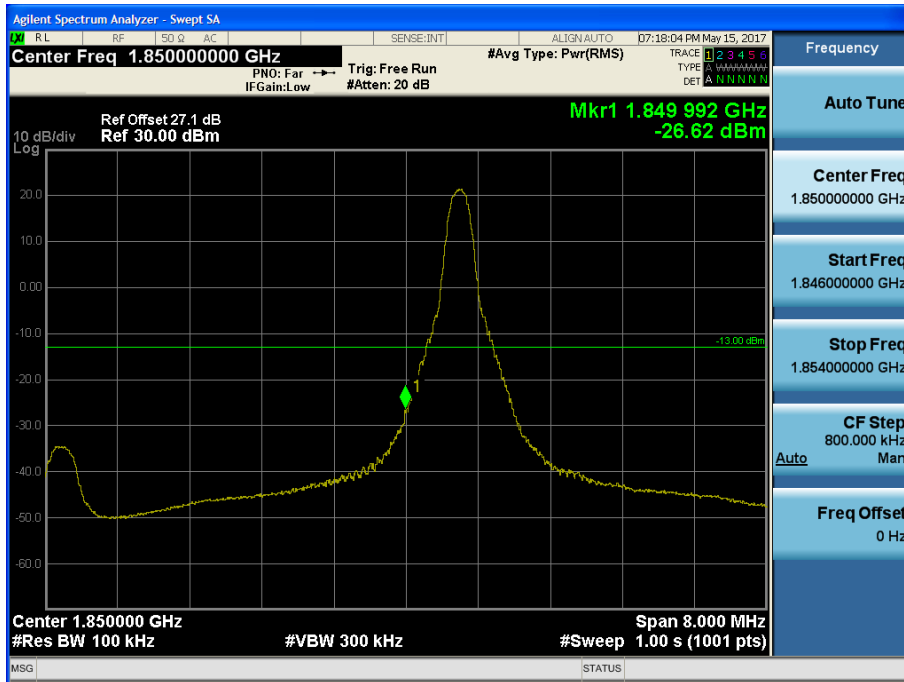

BAND 2. Lower Band Edge Plot (10M BW Ch.18650 QPSK_RB50_Offset 0) -2

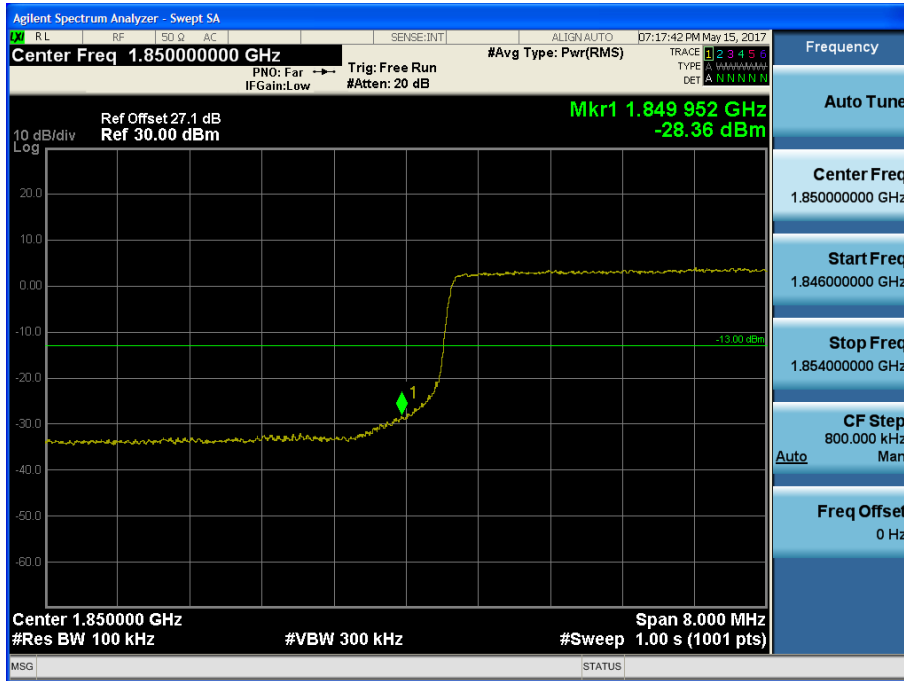

BAND 2. Lower Extended Band Edge Plot (10M BW Ch.18650 QPSK_RB50_0) -3

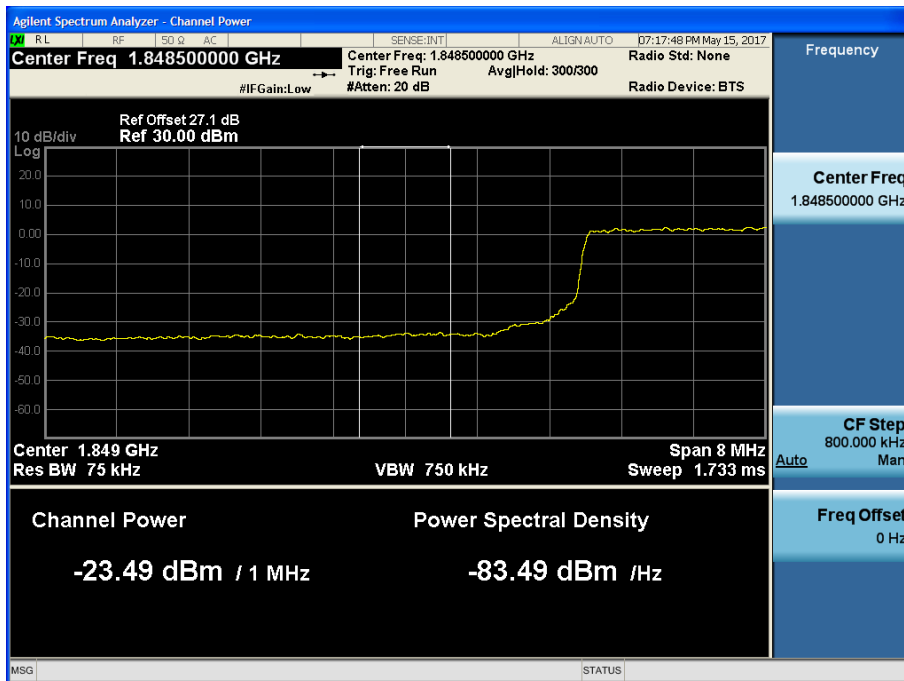

BAND 2. Lower Band Edge Plot (15M BW Ch.18675 QPSK_RB75_Offset 0) -1

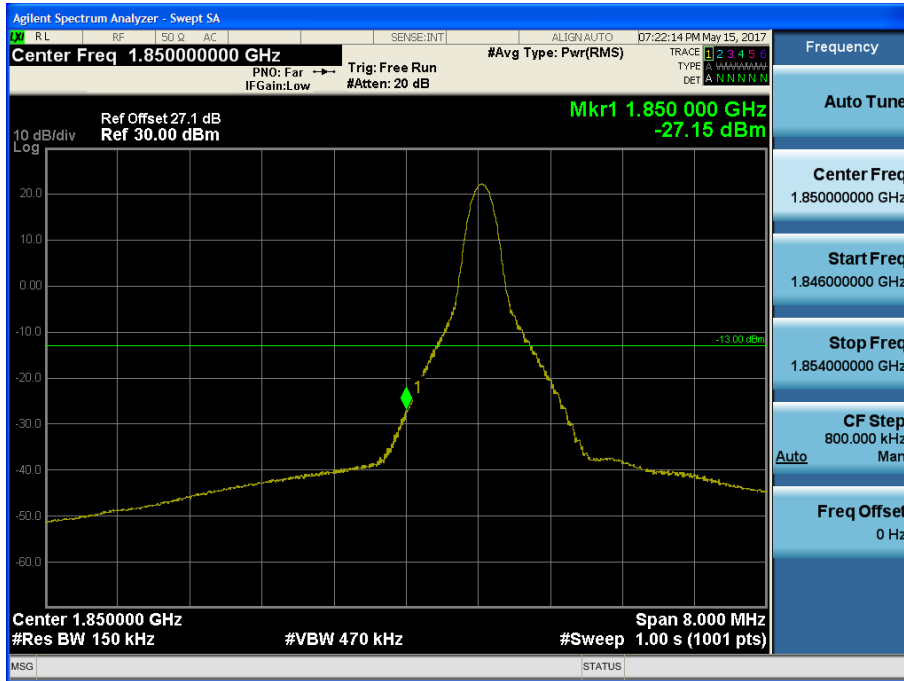

BAND 2. Lower Band Edge Plot (15M BW Ch.18675 QPSK_RB75_Offset 0) -2

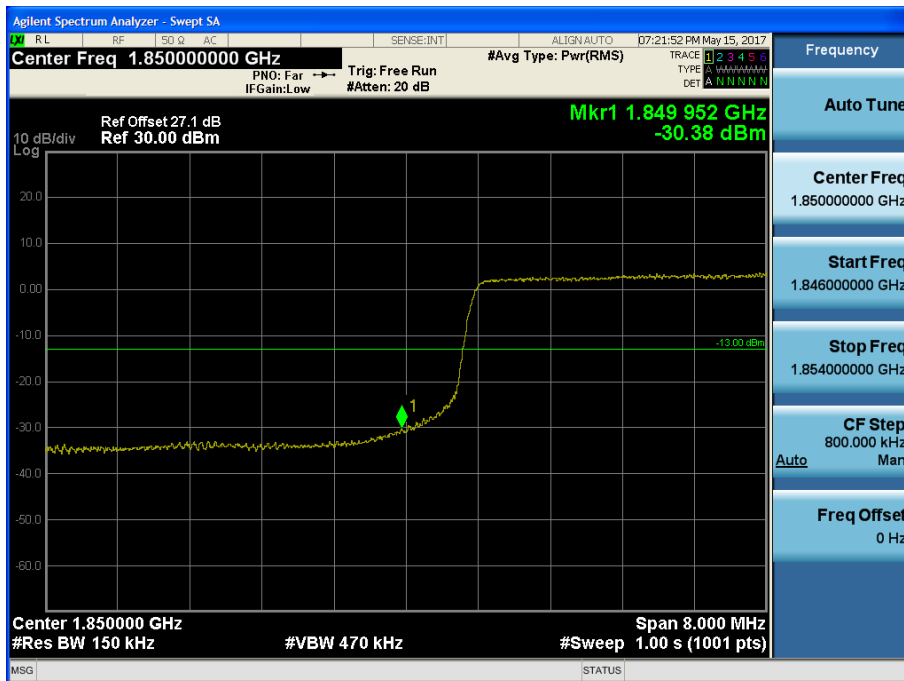

BAND 2. Lower Extended Band Edge Plot (15M BW Ch.18675 QPSK_RB75_0) -3

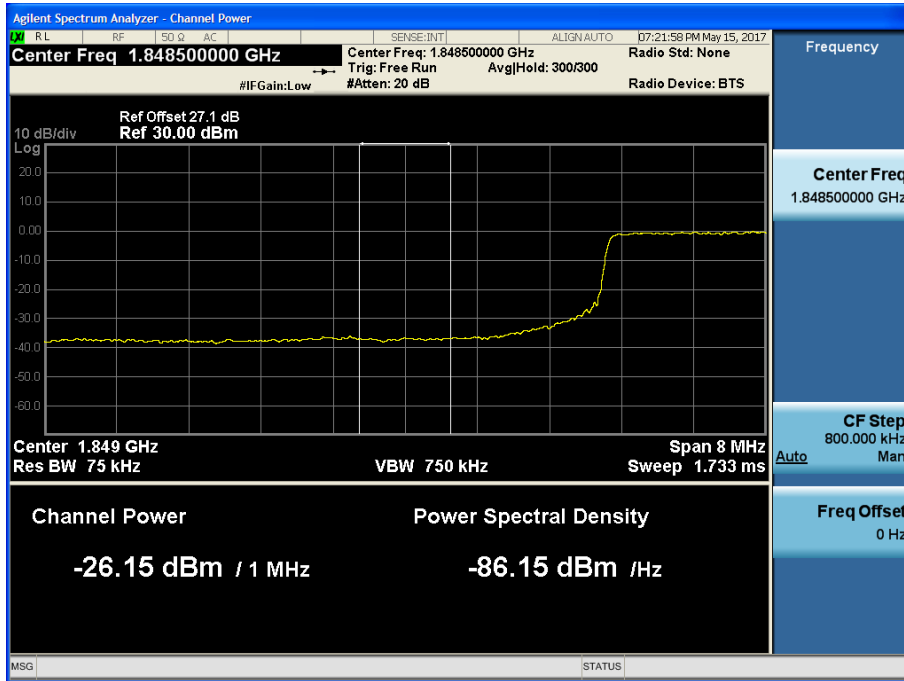

BAND 2. Lower Band Edge Plot (20M BW Ch.18700 QPSK_RB1_Offset 0) -1

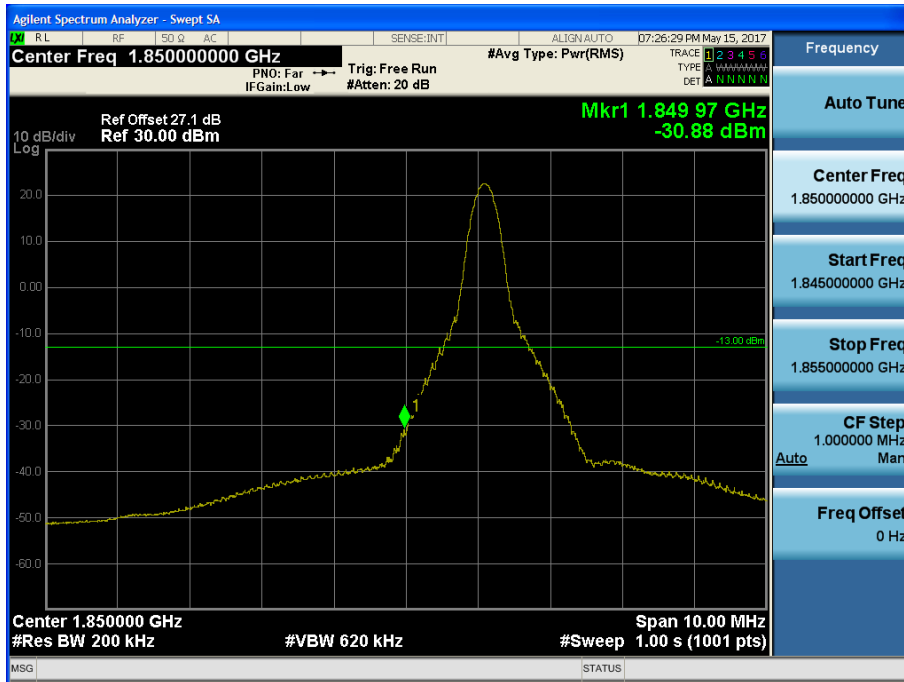

BAND 2. Lower Band Edge Plot (20M BW Ch.18700 QPSK_RB100_Offset 0) -2



BAND 2. Lower Extended Band Edge Plot (20M BW Ch.18700 QPSK_RB100_0) -3

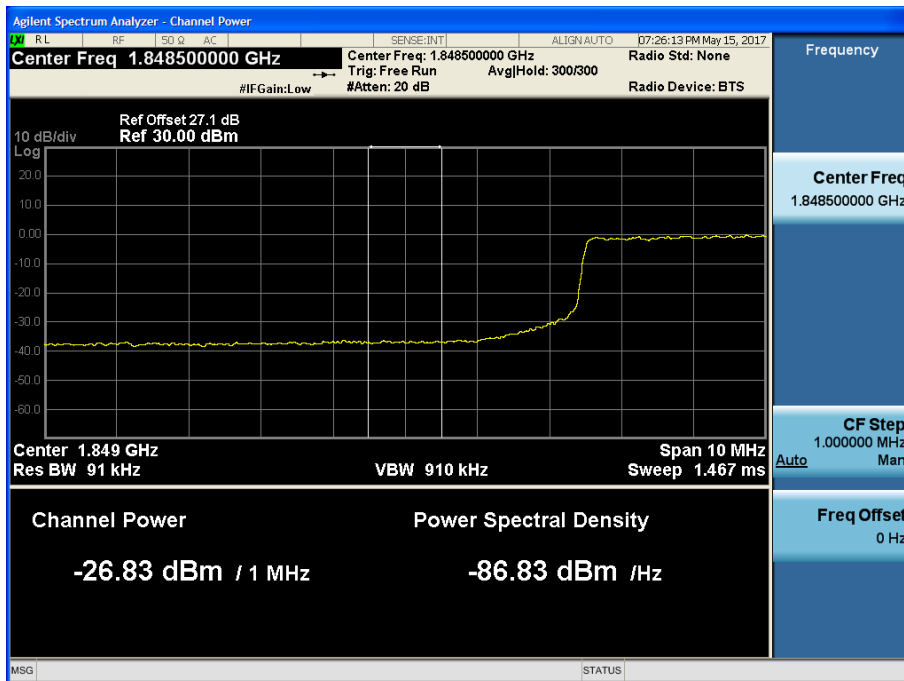

BAND 2. Upper Band Edge Plot (1.4M BW Ch.19193 QPSK_RB1_Offset 5) -1

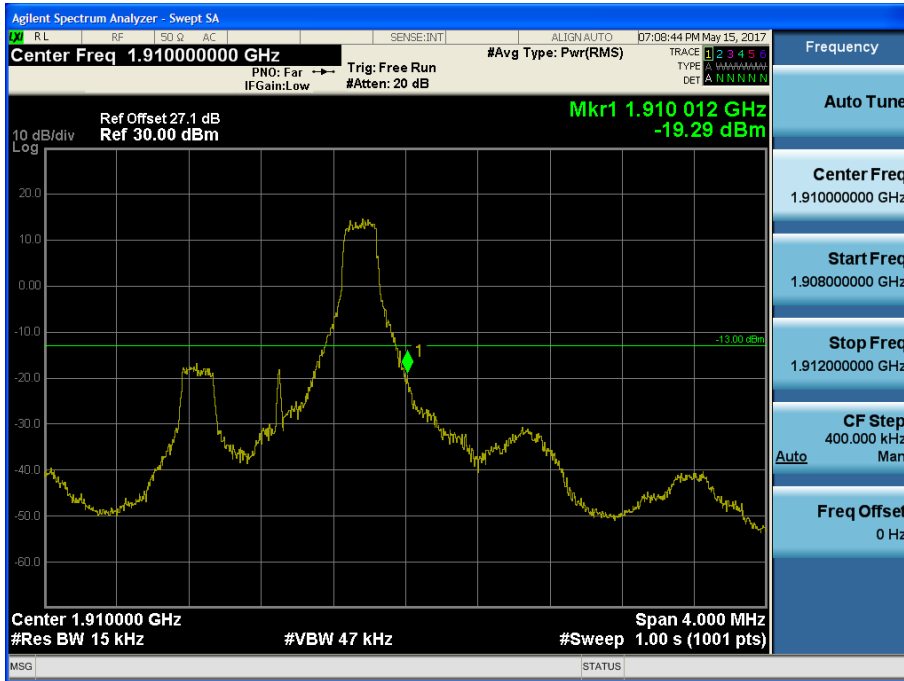

BAND 2. Upper Band Edge Plot (1.4M BW Ch.19193 QPSK_RB6_Offset 0) -2

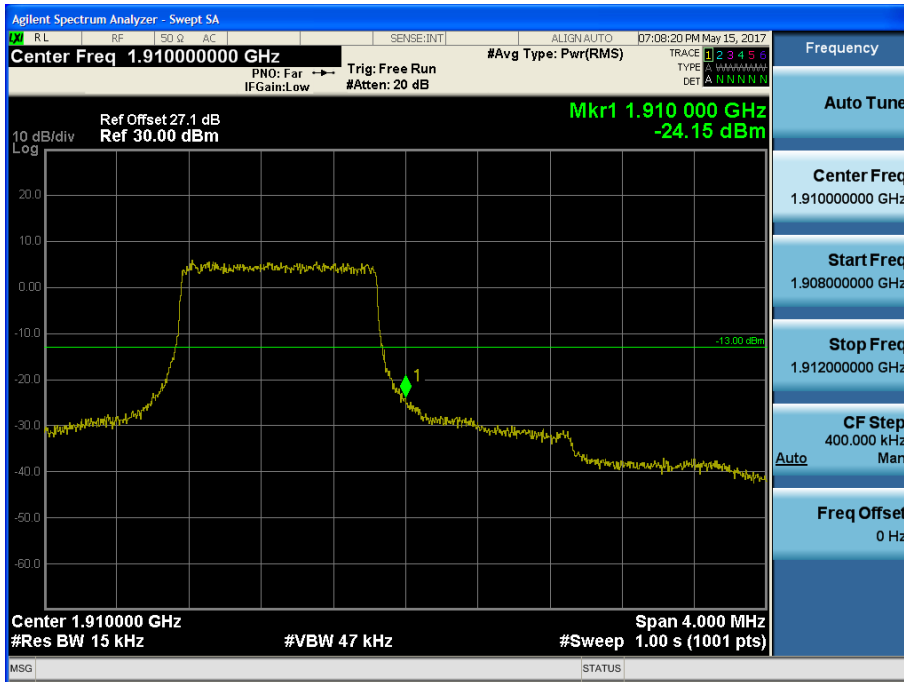

BAND 2. Upper Extended Band Edge Plot (1.4M BW Ch.19193 QPSK_RB6_0) -3

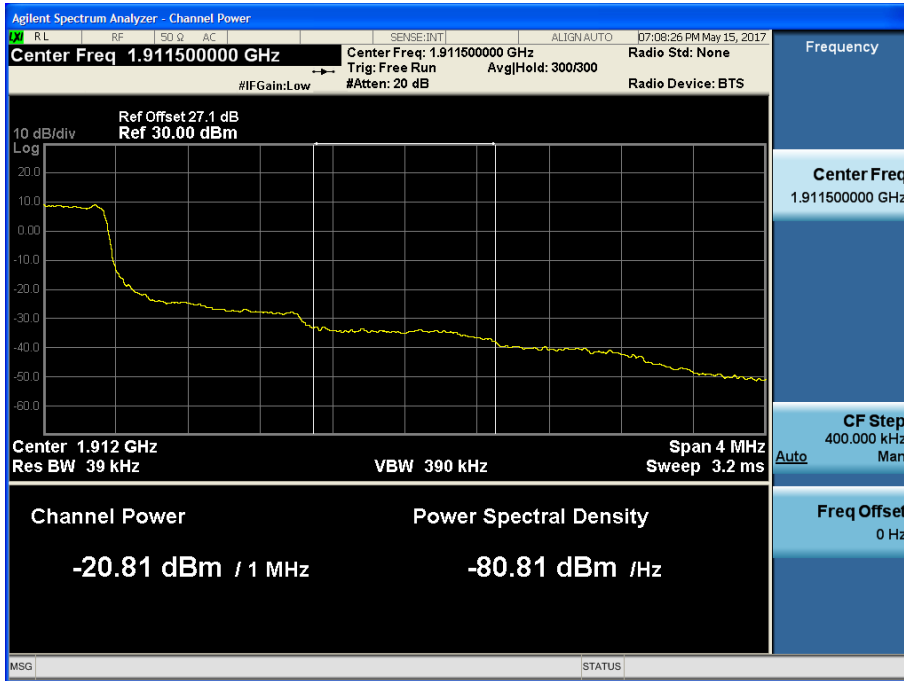

BAND 2. Upper Band Edge Plot (3M BW Ch.19185 QPSK_RB1_Offset 14) -1

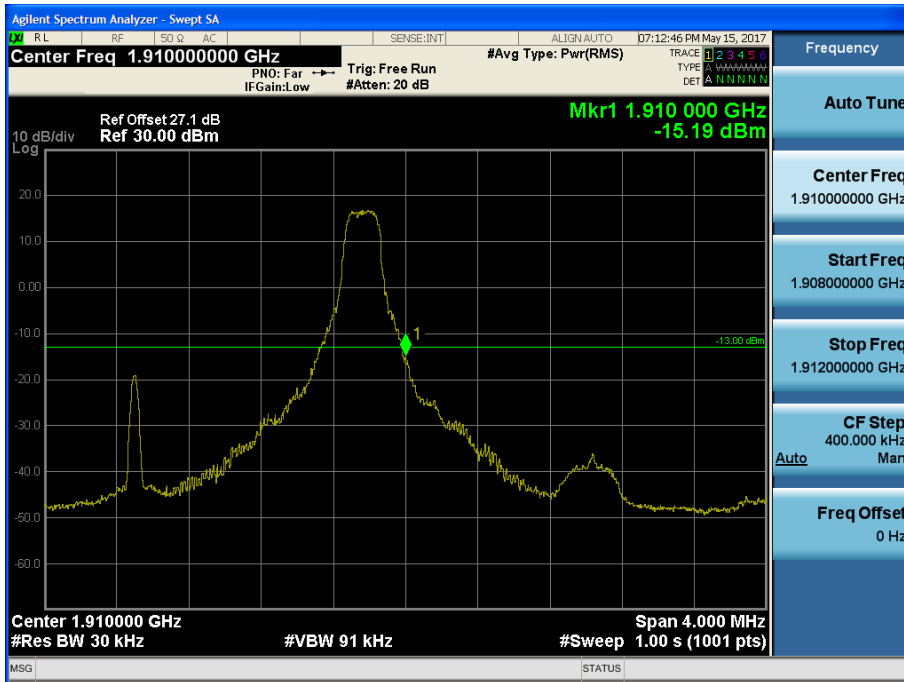

BAND 2. Upper Band Edge Plot (3M BW Ch.19185 QPSK_RB15_Offset 0) -2

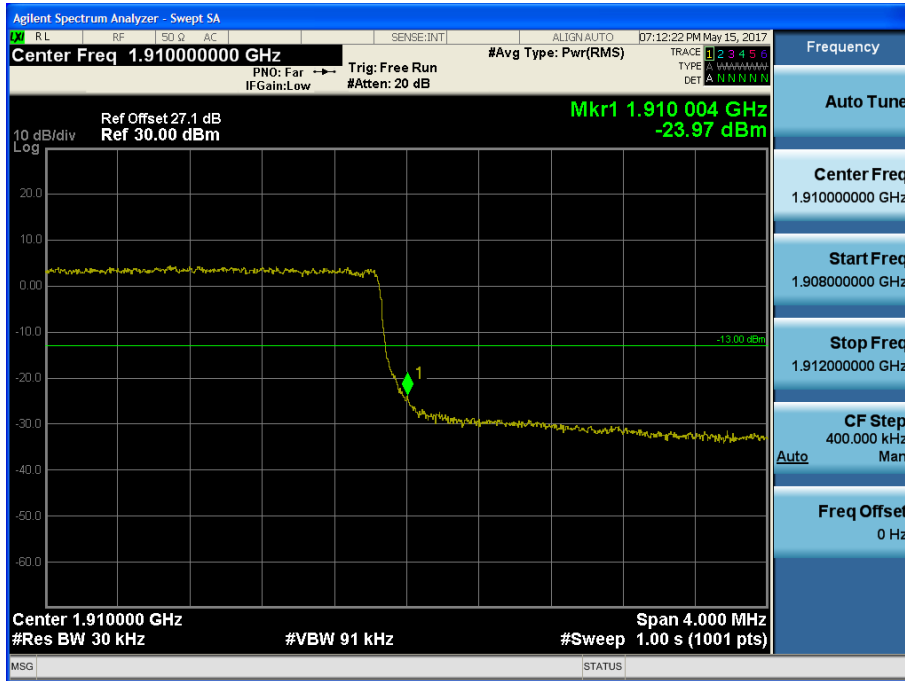

BAND 2. Upper Extended Band Edge Plot (3M BW Ch.19185 QPSK_RB15 0) -3

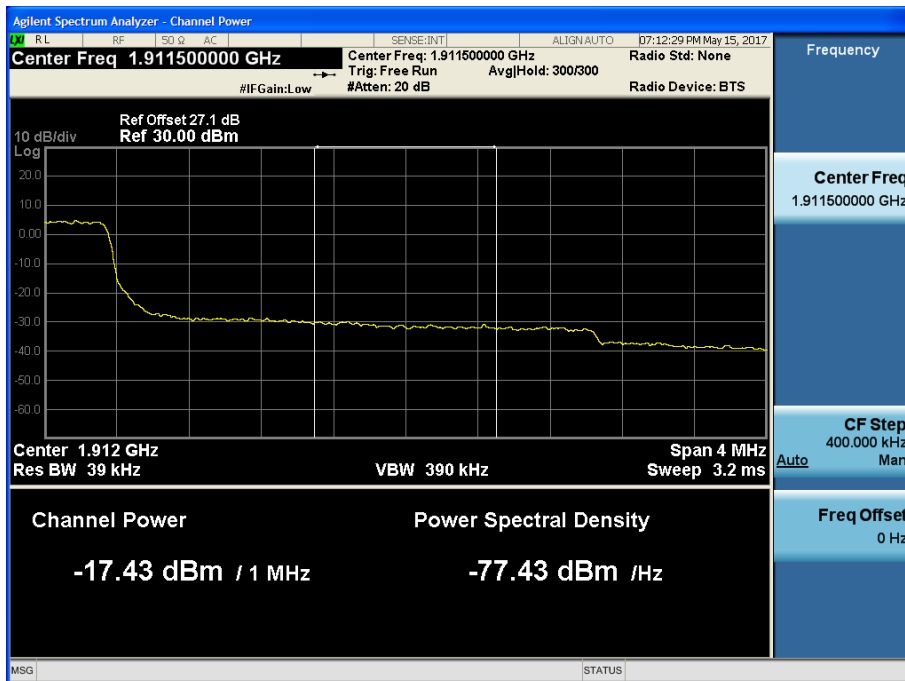

BAND 2. Upper Band Edge Plot (5M BW Ch.19175 QPSK_RB1_Offset 24) -1

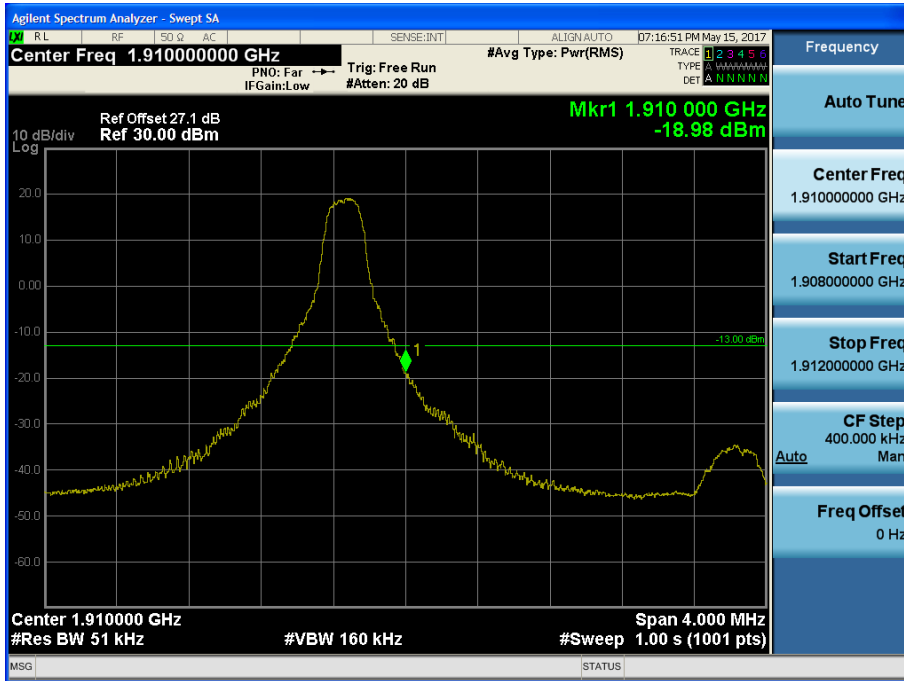

BAND 2. Upper Band Edge Plot (5M BW Ch.19175 QPSK_RB25_Offset 0) -2

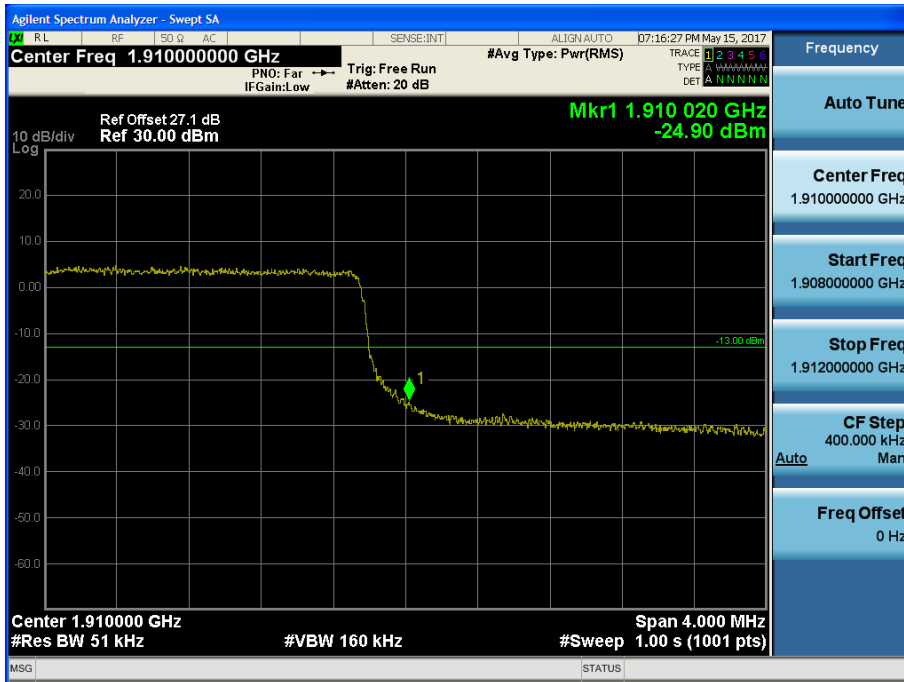

BAND 2. Upper Extended Band Edge Plot (5M BW Ch.19175 QPSK_RB25_0) -3

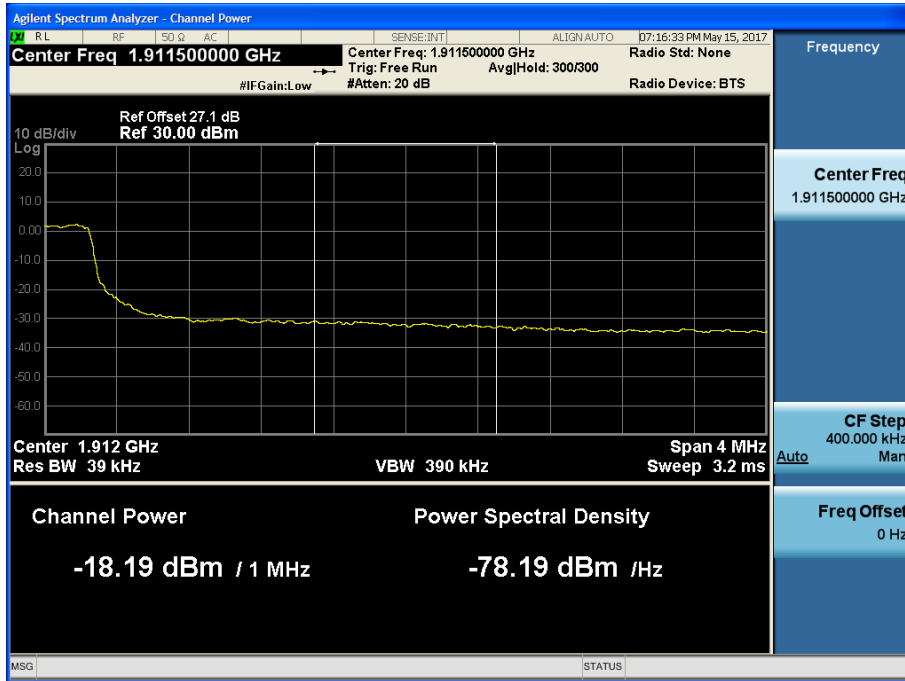

BAND 2. Upper Band Edge Plot (10M BW Ch.19150 QPSK_RB1_Offset 49) -1

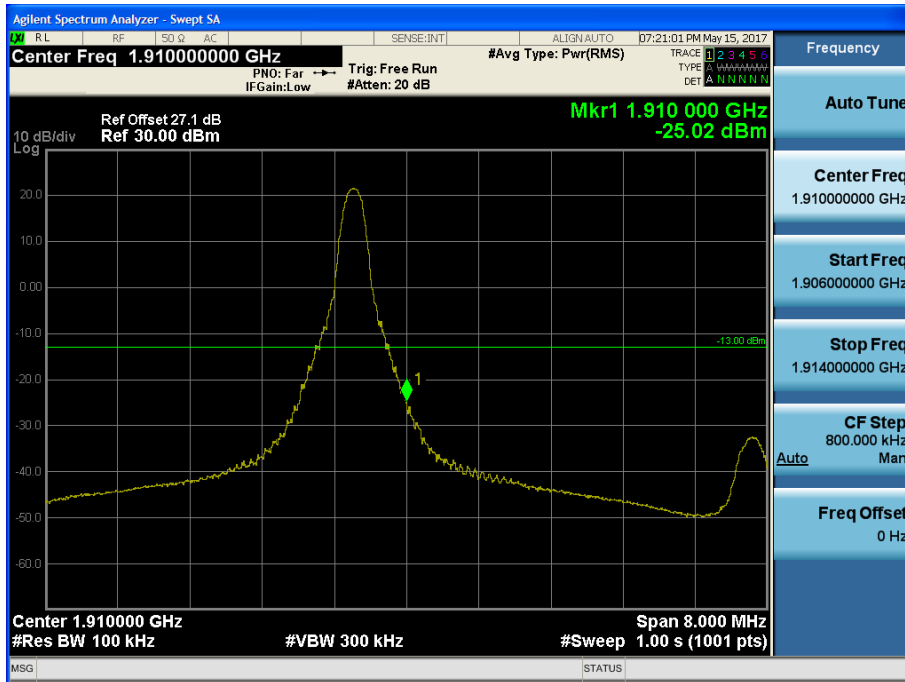

BAND 2. Upper Band Edge Plot (10M BW Ch.19150 QPSK_RB50_Offset 0) -2

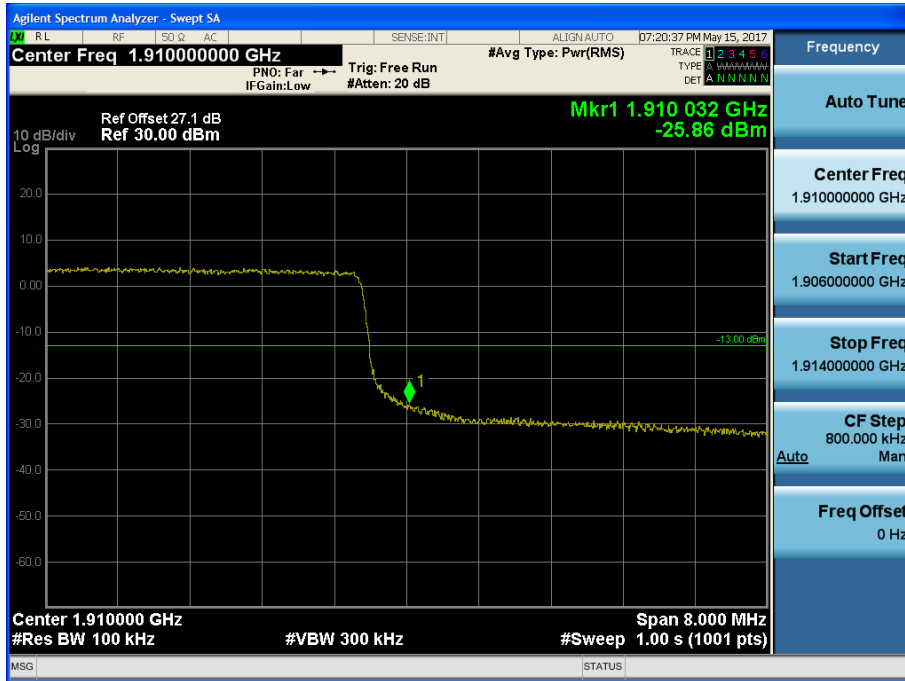

BAND 2. Upper Extended Band Edge Plot (10M BW Ch.19150 QPSK_RB50_0) -3

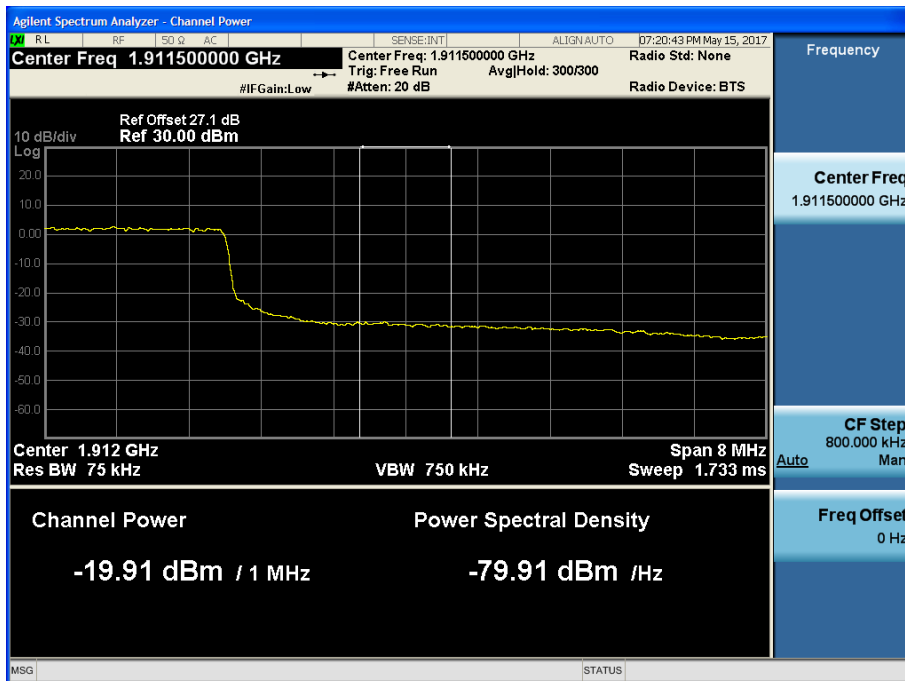

BAND 2. Upper Band Edge Plot (15M BW Ch.19125 QPSK_RB1_Offset 74) -1

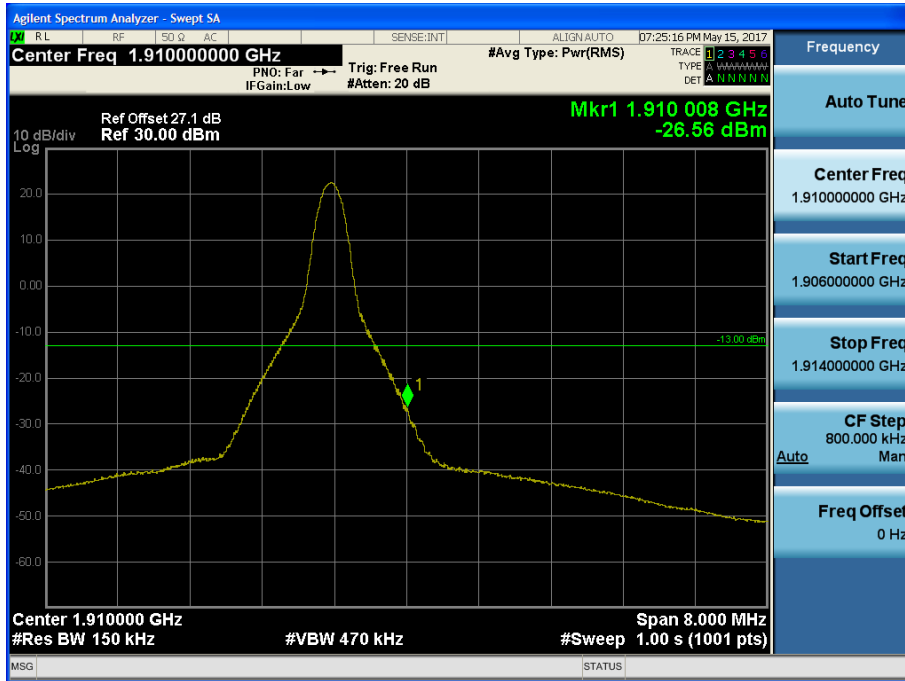

BAND 2. Upper Band Edge Plot (15M BW Ch.19125 QPSK_RB75_Offset 0) -2

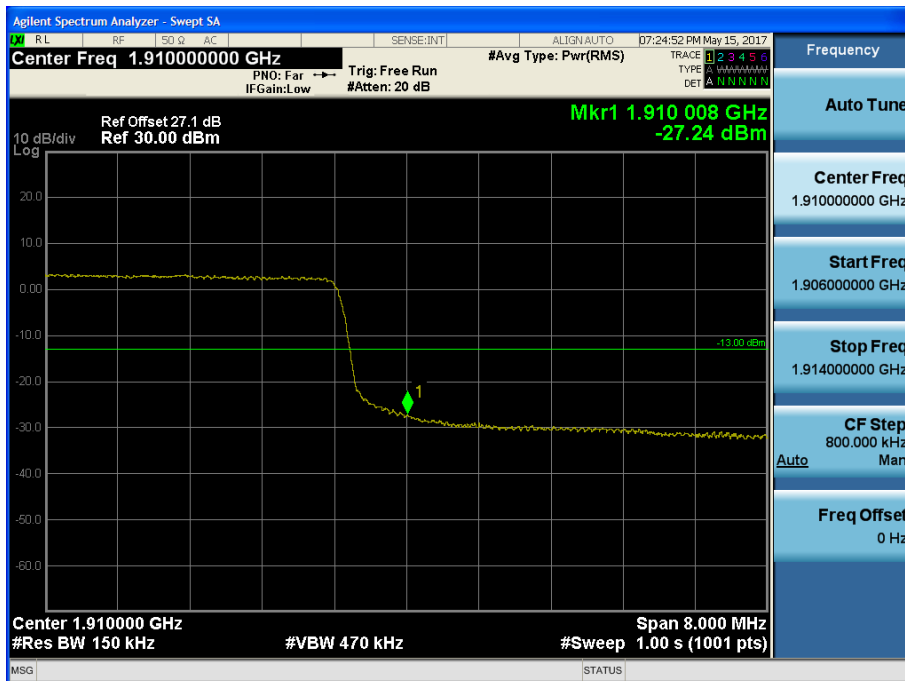

BAND 2. Upper Extended Band Edge Plot (15M BW Ch.19125 QPSK_RB75_0) -3

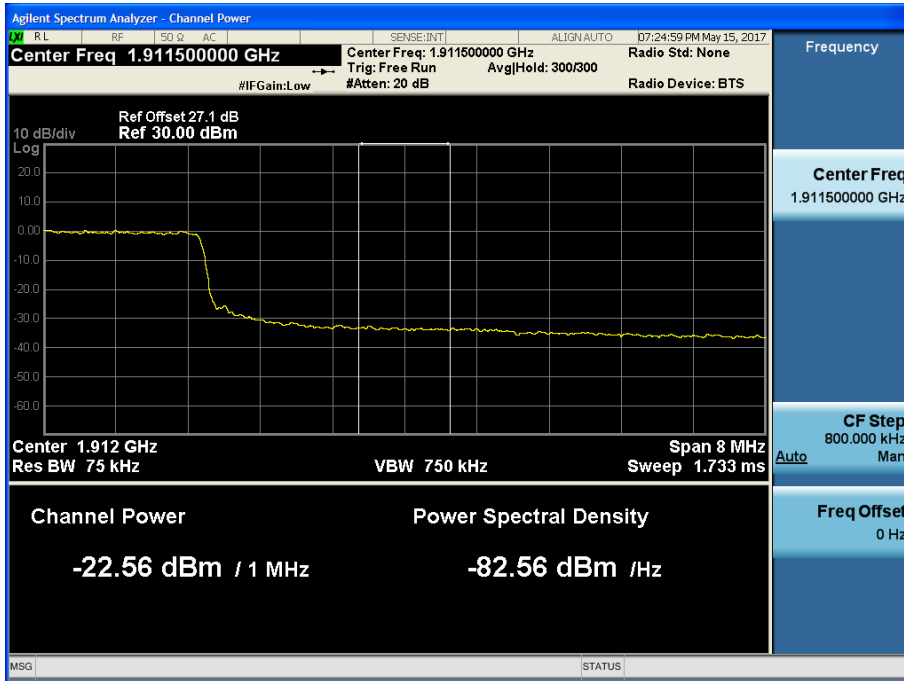

BAND 2. Upper Band Edge Plot (20M BW Ch.19100 QPSK_RB1_Offset 99) -1

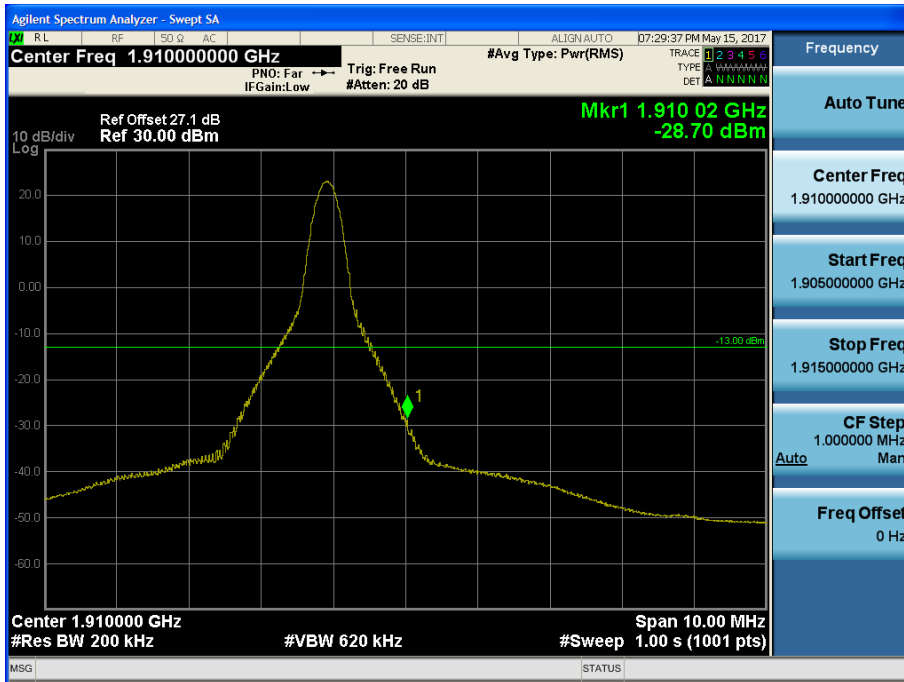

BAND 2. Upper Band Edge Plot (20M BW Ch.19100 QPSK_RB100_Offset 0) -2

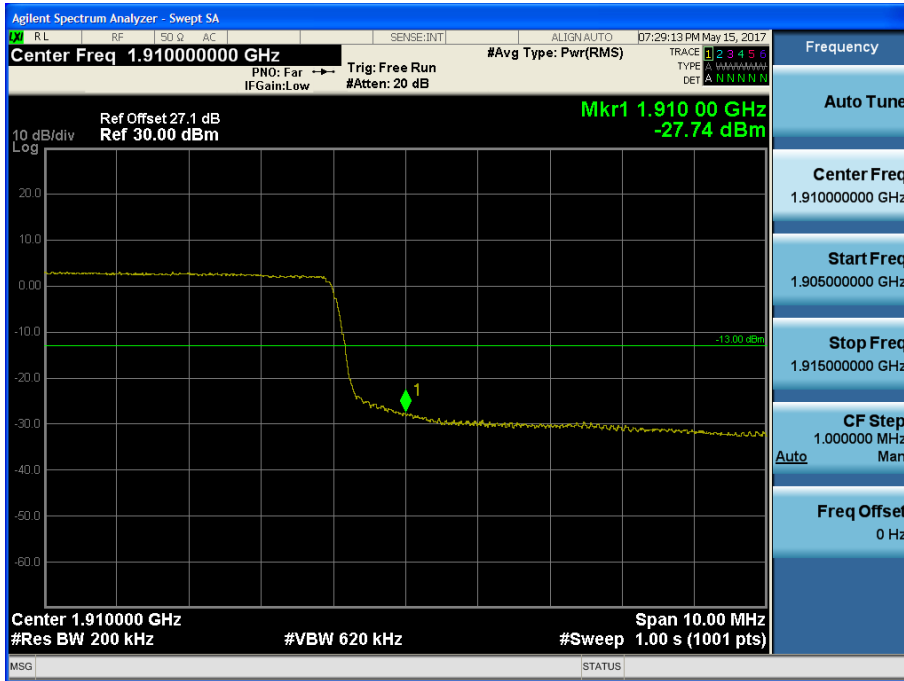

BAND 2. Upper Extended Band Edge Plot (20M BW Ch.19100 QPSK_RB100_0) -3

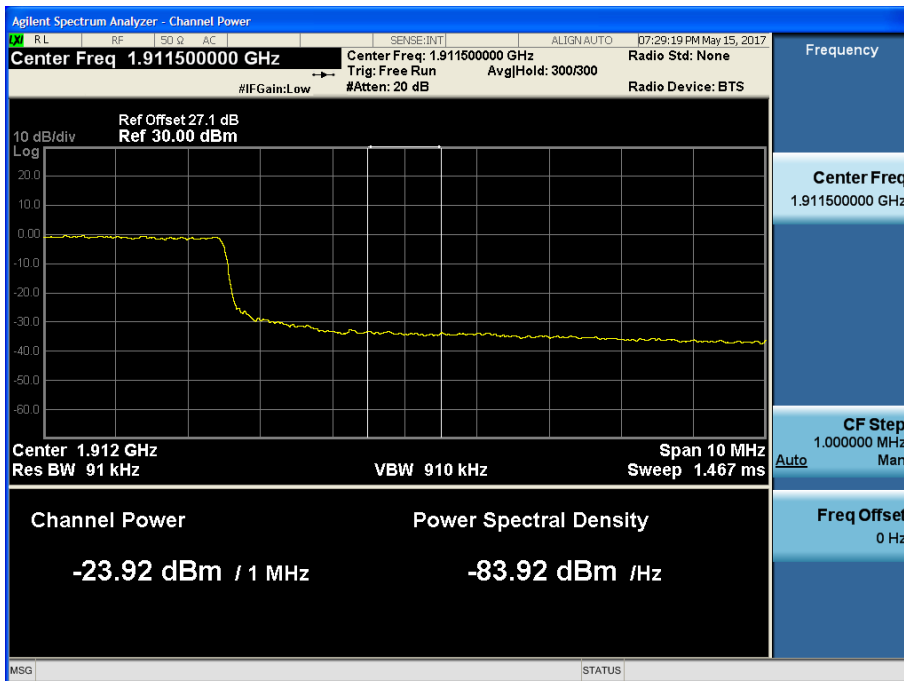

BAND 5. Lower Band Edge Plot (1.4M BW Ch.20407 QPSK_RB1_Offset 0)

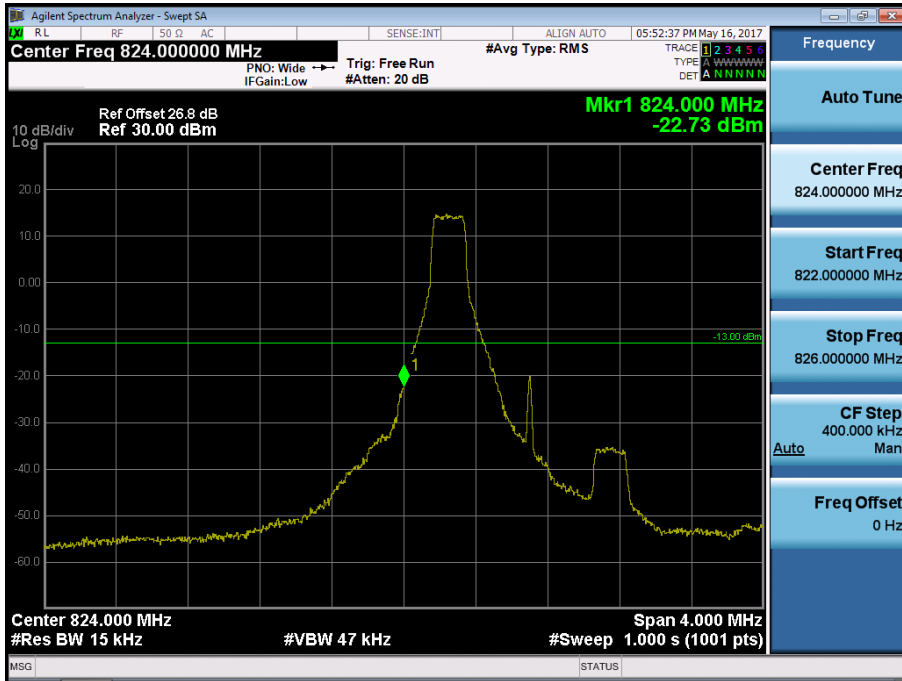

BAND 5. Lower Band Edge Plot (1.4M BW Ch.20407 QPSK_RB6_Offset 0)

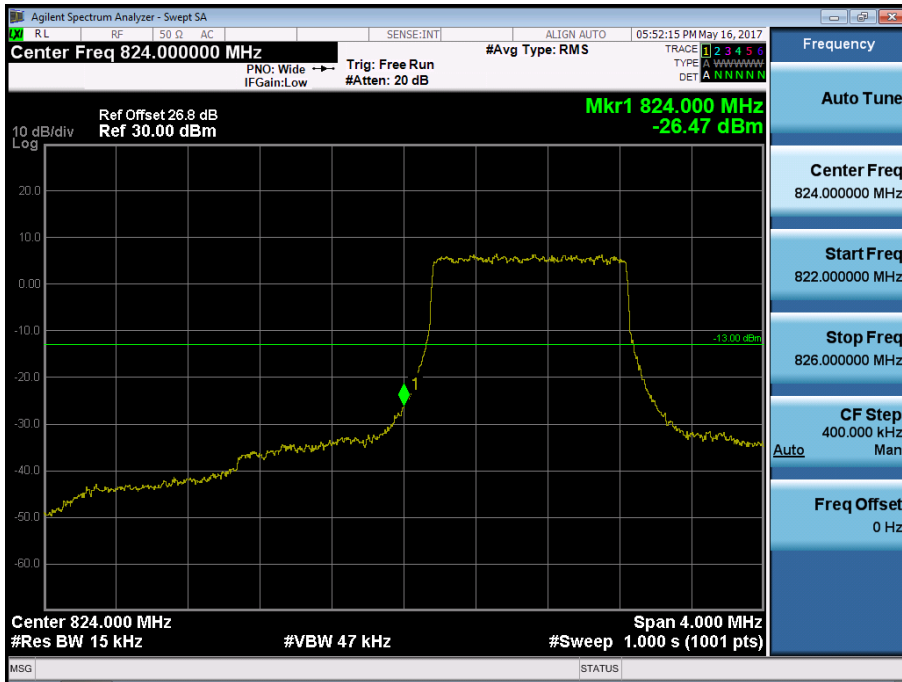

BAND 5. Lower Extended Band Edge Plot (1.4M BW Ch.20407 QPSK_RB6_0)



BAND 5. Lower Band Edge Plot (3M BW Ch.20415 QPSK_RB1_Offset 0)

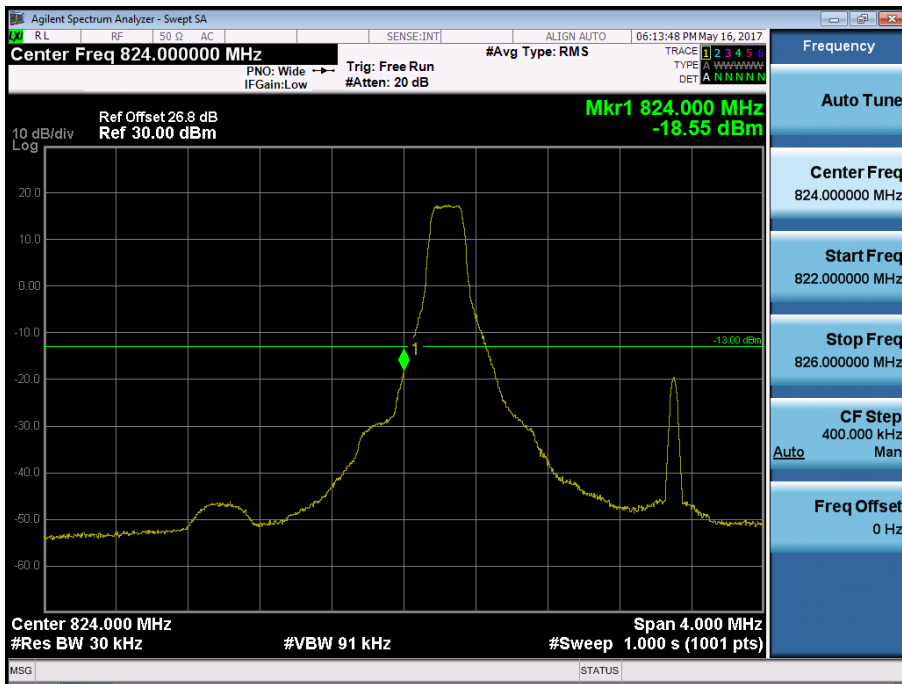

BAND 5. Lower Band Edge Plot (3M BW Ch.20415 QPSK_RB15_Offset 0)

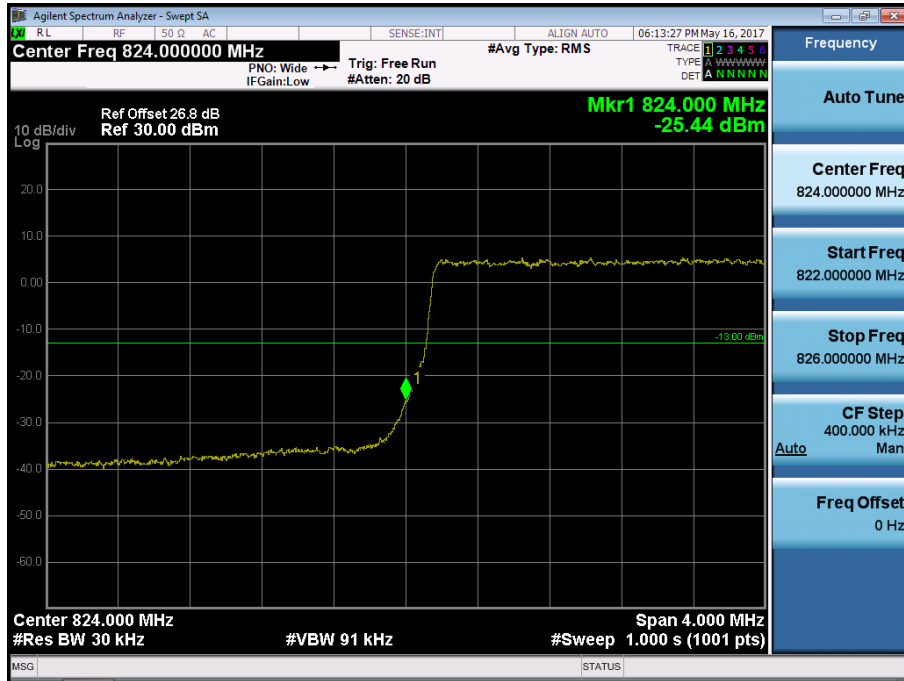

BAND 5. Lower Extended Band Edge Plot (3M BW Ch.20415 QPSK_RB15_0)

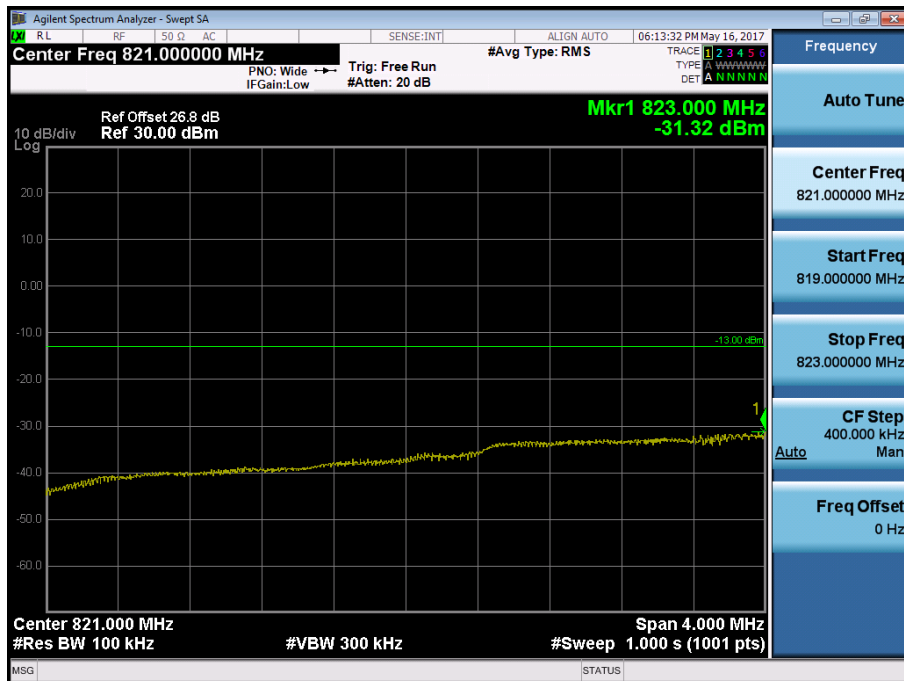

BAND 5. Lower Band Edge Plot (5M BW Ch.20425 QPSK_RB1_Offset 0)

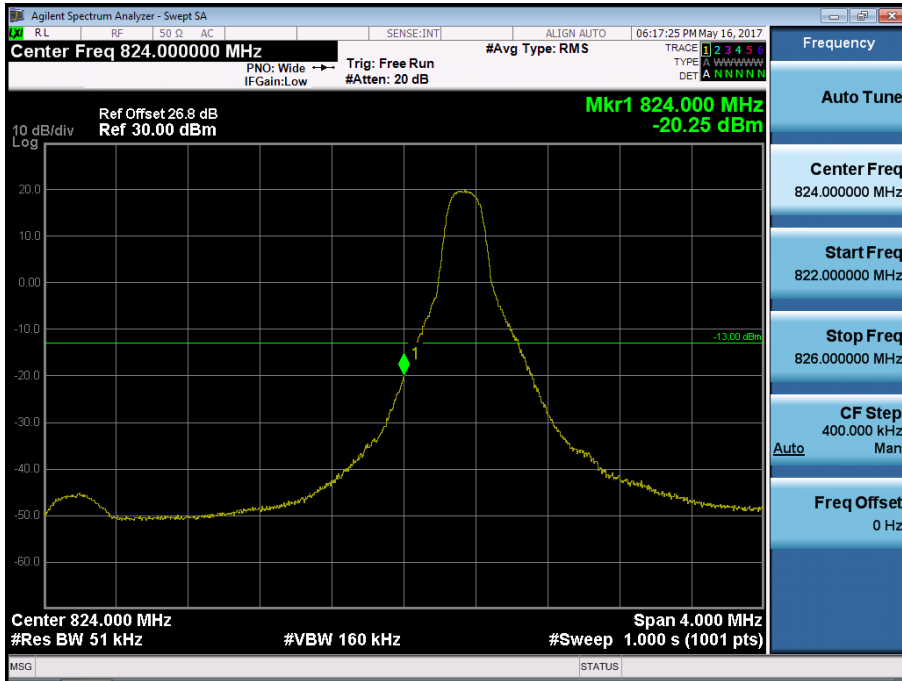

BAND 5. Lower Band Edge Plot (5M BW Ch.20425 QPSK_RB25_Offset 0)

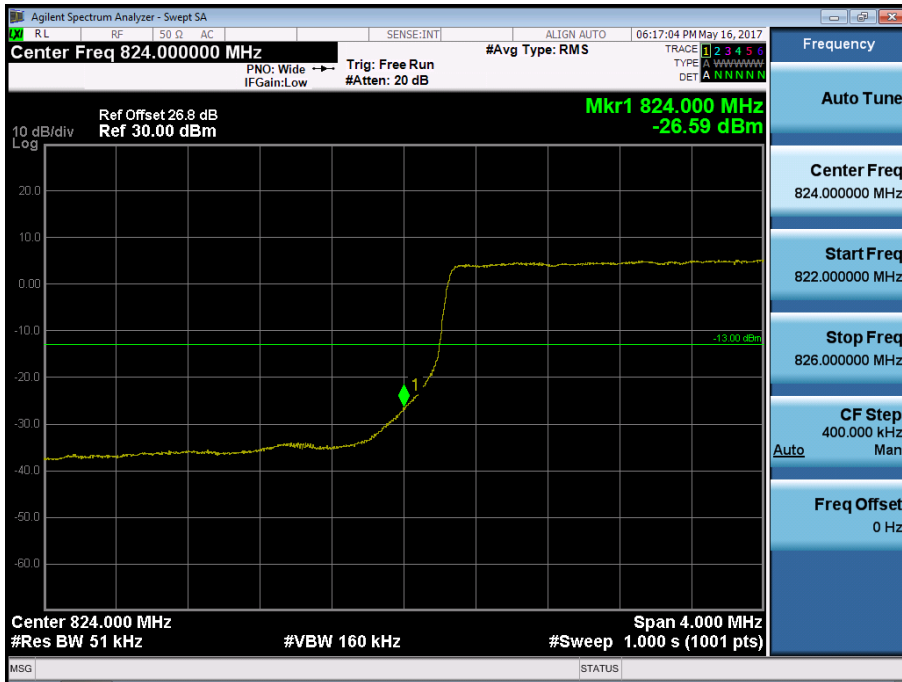

BAND 5. Lower Extended Band Edge Plot (5M BW Ch.20425 QPSK_RB25_0)



BAND 5. Lower Band Edge Plot (10M BW Ch.20450 QPSK_RB1_Offset 0)

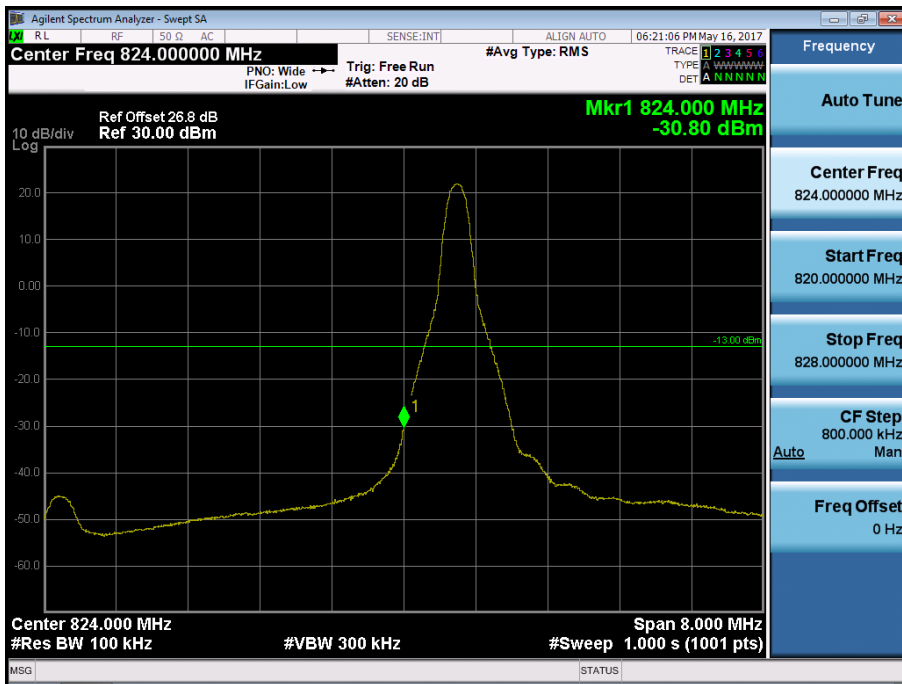

BAND 5. Lower Band Edge Plot (10M BW Ch.20450 QPSK_RB50_Offset 0)

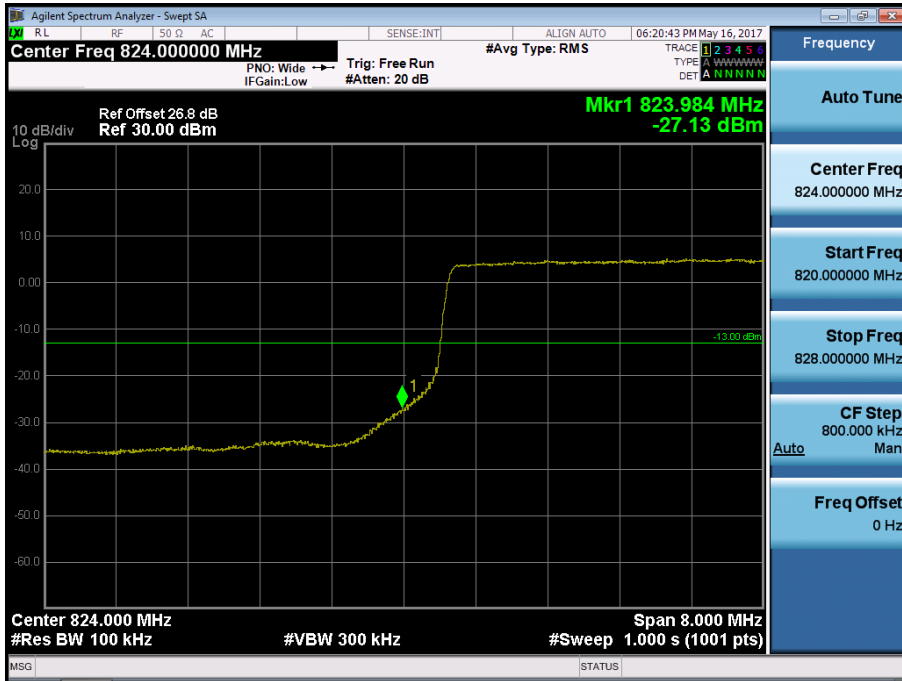

BAND 5. Lower Extended Band Edge Plot (10M BW Ch.20450 QPSK_RB50_0)

