

FCC LTE REPORT

FCC Certification

Applicant Name:
 LG Electronics MobileComm U.S.A., Inc.

Date of Issue:
 January 17, 2017

Address:
 1000 Sylvan Avenue, Englewood Cliffs NJ 07632

Location:
 HCT CO., LTD.,
 74, Seoicheon-ro 578beon-gil, Majang-myeon,
 Icheon-si, Gyeonggi-do, 17383, Rep. of KOREA
Report No.: HCT-R-1701-F019
HCT FRN: 0005866421

FCC ID: ZNFM400F

APPLICANT: LG Electronics MobileComm U.S.A., Inc.

According to the Evaluation report, all of the data contained herein is reused from the reference FCC ID: ZNFM400MT report.

FCC Model(s): LG-M400F

Additional FCC Model(s): LGM400F, M400F, LG-M400AR, LGM400AR, M400AR

EUT Type: Multi-band GSM/EDGE/WCDMA/LTE phone with Bluetooth, WLAN

FCC Classification: Licensed Portable Transmitter Held to Ear (PCE)

FCC Rule Part(s): §22, §24, §2

Mode (MHz)	Tx Frequency (MHz)	Emission Designator	Modulation	EIRP	
				Max. Power (W)	Max. Power (dBm)
LTE – Band2 (1.4)	1850.7 - 1909.3	1M09G7D	QPSK	0.269	24.30
		1M09W7D	16QAM	0.228	23.57
LTE – Band2 (3)	1851.5 - 1908.5	2M69G7D	QPSK	0.275	24.40
		2M69W7D	16QAM	0.231	23.64
LTE – Band2 (5)	1852.5 - 1907.5	4M50G7D	QPSK	0.272	24.35
		4M50W7D	16QAM	0.229	23.59
LTE – Band2 (10)	1855.0 - 1905.0	9M00G7D	QPSK	0.277	24.42
		8M97W7D	16QAM	0.233	23.67
LTE – Band2 (15)	1857.5 - 1902.5	13M5G7D	QPSK	0.283	24.52
		13M5W7D	16QAM	0.237	23.74
LTE – Band2 (20)	1860.0 - 1900.0	17M9G7D	QPSK	0.287	24.58
		18M0W7D	16QAM	0.239	23.78

Mode (MHz)	Tx Frequency (MHz)	Emission Designator	Modulation	ERP	
				Max. Power (W)	Max. Power (dBm)
LTE – Band5 (1.4)	824.7 – 848.3	1M10G7D	QPSK	0.103	20.12
		1M10W7D	16QAM	0.086	19.35
LTE – Band5 (3)	825.5 – 847.5	2M71G7D	QPSK	0.107	20.31
		2M70W7D	16QAM	0.089	19.48
LTE – Band5 (5)	826.5 – 846.5	4M51G7D	QPSK	0.107	20.28
		4M50W7D	16QAM	0.088	19.46
LTE – Band5 (10)	829.0 – 844.0	8M99G7D	QPSK	0.111	20.47
		8M98W7D	16QAM	0.093	19.69

The measurements shown in this report were made in accordance with the procedures specified in CFR47 section §2.947. I assume full responsibility for the accuracy and completeness of these measurements, and for the qualifications of all persons taking them.

HCT CO., LTD. Certifies that no party to this application has subject to a denial of Federal benefits that includes FCC benefits pursuant to section 5301 of the Anti-Drug Abuse Act of 1998, 21 U.S. C.853(a)



Report prepared by
: Jeong Ho Kim
Test engineer of RF Team

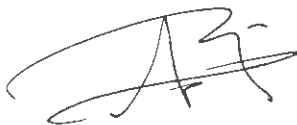

Approved by
: Jong Seok Lee
Manager of RF Team

This report only responds to the tested sample and may not be reproduced, except in full, without written approval of the HCT Co., Ltd.

Version

TEST REPORT NO.	DATE	DESCRIPTION
HCT-R-1701-F019	January 17, 2017	- First Approval Report

Table of Contents

1. GENERAL INFORMATION	6
2. INTRODUCTION	8
2.1. EUT DESCRIPTION.....	8
2.2. MEASURING INSTRUMENT CALIBRATION.....	8
2.3. TEST FACILITY	8
3. DESCRIPTION OF TESTS	9
3.1 ERP/ EIRP RADIATED POWER AND RADIATED SPURIOUS EMISSIONS.....	9
3.2 FREQUENCY RANGE.....	10
3.3 PEAK-AVERAGE RATIO.	11
3.4 OCCUPIED BANDWIDTH.	13
3.5 SPURIOUS AND HARMONIC EMISSIONS AT ANTENNA TERMINAL.....	14
3.6 FREQUENCY STABILITY / VARIATION OF AMBIENT TEMPERATURE	15
4. LIST OF TEST EQUIPMENT	16
5. MEASUREMENT UNCERTAINTY.....	17
6. SUMMARY OF TEST RESULTS	18
7. SAMPLE CALCULATION.....	19
8. TEST DATA	20
8.1 EQUIVALENT ISOTROPIC RADIATED POWER (Band 2)	20
8.2 EFFECTIVE RADIATED POWER (Band 5).....	24
8.3 RADIATED SPURIOUS EMISSIONS.....	26
8.3.1 RADIATED SPURIOUS EMISSIONS (1.4 MHz Band 2 LTE).....	26
8.3.2 RADIATED SPURIOUS EMISSIONS (3 MHz Band 2 LTE).....	27
8.3.3 RADIATED SPURIOUS EMISSIONS (5 MHz Band 2 LTE).....	28
8.3.4 RADIATED SPURIOUS EMISSIONS (10 MHz Band 2 LTE).....	29
8.3.5 RADIATED SPURIOUS EMISSIONS (15 MHz Band 2 LTE).....	30
8.3.6 RADIATED SPURIOUS EMISSIONS (20 MHz Band 2 LTE).....	31
8.3.7 RADIATED SPURIOUS EMISSIONS (1.4 MHz Band 5 LTE).....	32
8.3.8 RADIATED SPURIOUS EMISSIONS (3 MHz Band 5 LTE).....	33
8.3.9 RADIATED SPURIOUS EMISSIONS (5 MHz Band 5 LTE).....	34
8.3.10 RADIATED SPURIOUS EMISSIONS (10 MHz Band 5 LTE).....	35
8.4 PEAK-TO-AVERAGE RATIO	36
8.5 OCCUPIED BANDWIDTH	37
8.6 CONDUCTED SPURIOUS EMISSIONS	38
8.6.1 BAND EDGE.....	39
8.7 FREQUENCY STABILITY / VARIATION OF AMBIENT TEMPERATURE	40

8.7.1 FREQUENCY STABILITY (1.4 MHz Band 2 LTE)	40
8.7.2 FREQUENCY STABILITY (3 MHz Band 2 LTE)	41
8.7.3 FREQUENCY STABILITY (5 MHz Band 2 LTE)	42
8.7.4 FREQUENCY STABILITY (10 MHz Band 2 LTE)	43
8.7.5 FREQUENCY STABILITY (15 MHz Band 2 LTE)	44
8.7.6 FREQUENCY STABILITY (20 MHz Band 2 LTE)	45
8.7.7 FREQUENCY STABILITY (1.4 MHz Band 5 LTE)	46
8.7.8 FREQUENCY STABILITY (3 MHz Band 5 LTE)	47
8.7.9 FREQUENCY STABILITY (5 MHz Band 5 LTE)	48
8.7.10 FREQUENCY STABILITY (10 MHz Band 5 LTE)	49
9. TEST PLOTS.....	50

MEASUREMENT REPORT

1. GENERAL INFORMATION

Applicant Name: LG Electronics MobileComm U.S.A., Inc.

Address: 1000 Sylvan Avenue, Englewood Cliffs NJ 07632

FCC ID: ZNFM400F

Application Type: Certification

FCC Classification: Licensed Portable Transmitter Held to Ear (PCE)

FCC Rule Part(s): §22,§24, §2

EUT Type: Multi-band GSM/EDGE/WCDMA/LTE phone with Bluetooth, WLAN

FCC Model(s): LG-M400F

Additional FCC Model(s): LGM400F, M400F, LG-M400AR, LGM400AR, M400AR

Tx Frequency: 1850.7 MHz – 1909.3 MHz (LTE – Band2 (1.4 MHz))
1851.5 MHz – 1908.5 MHz (LTE – Band2 (3 MHz))
1852.5 MHz – 1907.5 MHz (LTE – Band2 (5 MHz))
1855.0 MHz – 1905.0 MHz (LTE – Band2 (10 MHz))
1857.5 MHz – 1902.5 MHz (LTE – Band2 (15 MHz))
1860.0 MHz – 1900.0 MHz (LTE – Band2 (20 MHz))

824.7 MHz – 848.3 MHz (LTE – Band 5 (1.4 MHz))
825.5 MHz – 847.5 MHz (LTE – Band 5 (3 MHz))
826.5 MHz – 846.5 MHz (LTE – Band 5 (5 MHz))
829.0 MHz – 844.0 MHz (LTE – Band 5 (10 MHz))

Max. RF Output Power:

Band 2 (1.4 MHz) :	0.269 W (QPSK) (24.30 dBm)
	0.228 W (16-QAM) (23.57 dBm)
Band 2 (3 MHz) :	0.275 W (QPSK) (24.40 dBm)
	0.231 W (16-QAM) (23.64 dBm)
Band 2 (5 MHz) :	0.272 W (QPSK) (24.35 dBm)
	0.229 W (16-QAM) (23.59 dBm)
Band 2 (10 MHz) :	0.277 W (QPSK) (24.42 dBm)
	0.233 W (16-QAM) (23.67 dBm)
Band 2 (15 MHz) :	0.283 W (QPSK) (24.52 dBm)
	0.237 W (16-QAM) (23.74 dBm)
Band 2 (20 MHz) :	0.287 W (QPSK) (24.58 dBm)
	0.239 W (16-QAM) (23.78 dBm)
Band 5 (1.4 MHz) :	0.103 W (QPSK) (20.12 dBm)
	0.086 W (16-QAM) (19.35 dBm)
Band 5 (3 MHz) :	0.107 W (QPSK) (20.31 dBm)
	0.089 W (16-QAM) (19.48 dBm)
Band 5 (5 MHz) :	0.107 W (QPSK) (20.28 dBm)
	0.088 W (16-QAM) (19.46 dBm)
Band 5 (10 MHz) :	0.111 W (QPSK) (20.47 dBm)
	0.093 W (16-QAM) (19.69 dBm)

Emission Designator(s):

Band 2 (1.4 MHz) :	1M09G7D (QPSK) / 1M09W7D (16-QAM)
Band 2 (3 MHz)	2M69G7D (QPSK) / 2M69W7D (16-QAM)
Band 2 (5 MHz) :	4M50G7D (QPSK) / 4M50W7D (16-QAM)
Band 2 (10 MHz)	9M00G7D (QPSK) / 8M97W7D (16-QAM)
Band 2 (15 MHz) :	13M5G7D (QPSK) / 13M5W7D (16-QAM)
Band 2 (20 MHz)	17M9G7D (QPSK) / 18M0W7D (16-QAM)
Band 5 (1.4 MHz) :	1M10G7D (QPSK) / 1M10W7D (16-QAM)
Band 5 (3 MHz) :	2M71G7D (QPSK) / 2M70W7D (16-QAM)
Band 5 (5 MHz) :	4M51G7D (QPSK) / 4M50W7D (16-QAM)
Band 5 (10 MHz) :	8M99G7D (QPSK) / 8M98W7D (16-QAM)

Date(s) of Tests: December 09, 2016 ~ January 13, 2017

Antenna Specification:

Manufacturer:	Ace Technology
Antenna type:	PIFA Antenna (Planar Inverted F)
Peak Gain:	Band 2 : -0.12 dBi
	Band 5 : -3.77 dBi

2. INTRODUCTION

2.1. EUT DESCRIPTION

The LG Electronics MobileComm U.S.A., Inc. LG-M400F Multi-band GSM/EDGE/WCDMA/LTE phone with Bluetooth, WLAN consists of LTE 2 and 5.

2.2. MEASURING INSTRUMENT CALIBRATION

The measuring equipment, which was utilized in performing the tests documented herein, has been calibrated in accordance with the manufacturer's recommendations for utilizing calibration equipment, which is traceable to recognized national standards.

2.3. TEST FACILITY

The Fully-anechoic chamber and conducted measurement facility used to collect the radiated data are located at the **74, Seoicheon-ro 578beon-gil, Majang-myeon, Icheon-si, Gyeonggi-do, 17383, Rep. of KOREA.**

3. DESCRIPTION OF TESTS

3.1 ERP/ EIRP RADIATED POWER AND RADIATED SPURIOUS EMISSIONS

Note: ERP(Effective Radiated Power), EIRP(Effective Isotropic Radiated Power)

Test Procedure

Radiated emission measurements are performed in the Fully-anechoic chamber. The equipment under test is placed on a non-conductive table 3-meters away from the receive antenna in accordance with ANSI/TIA-603-D-2010 Clause 2.2.17. The turntable is rotated through 360 degrees, and the receiving antenna scans in order to determine the level of the maximized emission. The level and position of the maximized emission is recorded with the spectrum analyzer using a RMS detector.

A half wave dipole is then substituted in place of the EUT. For emissions above 1GHz, a horn antenna is substituted in place of the EUT. The substitute antenna is driven by a signal generator and the previously recorded signal was duplicated.

The power is calculated by the following formula;

$$P_{d(\text{dBm})} = P_{g(\text{dBm})} - \text{cable loss}_{(\text{dB})} + \text{antenna gain}_{(\text{dB})}$$

Where: P_d is the dipole equivalent power and P_g is the generator output power into the substitution antenna.

The maximum EIRP is calculated by adding the forward power to the calibrated source plus its appropriate gain value. These steps are repeated with the receiving antenna in both vertical and horizontal polarization. the difference between the gain of the horn and an isotropic antenna are taken into consideration

Radiated spurious emissions

: Frequency Range : 9 kHz ~ 10th Harmonics of highest channel fundamental frequency.

3.2 FREQUENCY RANGE

§ 24.229: PCS – Mobile Frequency Blocks

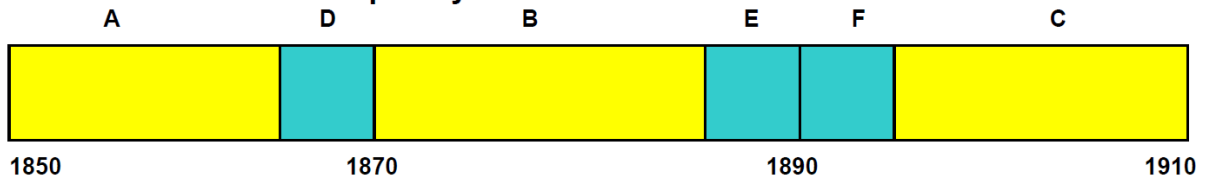

- | | |
|-------------------------------------|-------------------------------------|
| BLOCK 1: 1850 – 1865 MHz (A) | BLOCK 4: 1885 – 1890 MHz (E) |
| BLOCK 2: 1865 – 1870 MHz (D) | BLOCK 5: 1890 – 1895 MHz (F) |
| BLOCK 3: 1870 – 1885 MHz (B) | BLOCK 6: 1895 – 1910 MHz (C) |

§22.917(a): Cellular – Mobile Frequency Blocks

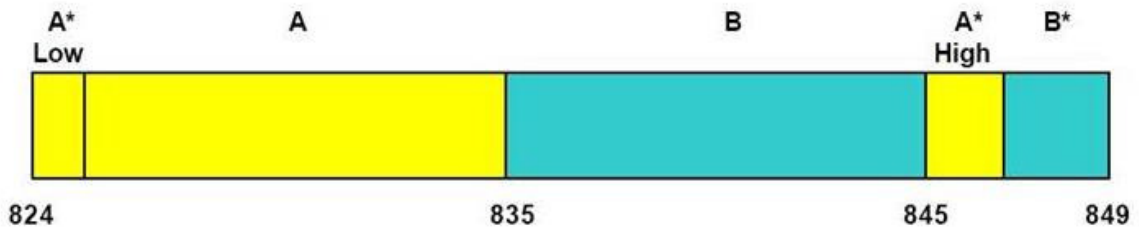

- | | |
|--|---|
| BLOCK 1: 824 – 835 MHz (A* Low + A) | BLOCK 3: 845 – 846.5 MHz (A* High) |
| BLOCK 2: 835 – 845 MHz (B) | BLOCK 4: 846.5 – 849 MHz (B*) |

3.3 PEAK-AVERAGE RATIO.

Test Procedure

Peak to Average Power Ratio is tested in accordance with KDB971168 D01 Power Meas License Digital Systems v02r02, October 17, 2014, Section 5.7.

- Section 5.7.1 CCDF Procedure

- a) Set resolution/measurement bandwidth \geq signal's occupied bandwidth;
- b) Set the number of counts to a value that stabilizes the measured CCDF curve;
- c) Set the measurement interval as follows:
 - 1) for continuous transmissions, set to 1 ms,
 - 2) for burst transmissions, employ an external trigger that is synchronized with the EUT burst timing sequence, or use the internal burst trigger with a trigger level that allows the burst to stabilize and set the measurement interval to a time that is less than or equal to the burst duration.
- d) Record the maximum PAPR level associated with a probability of 0.1%.

- Section 5.7.2 Alternate Procedure

Use one of the procedures presented in 5.1 to measure the total peak power and record as P_{Pk} . Use one of the applicable procedures presented 5.2 to measure the total average power and record as P_{Avg} . Determine the P.A.R. from: $P.A.R_{(dB)} = P_{Pk (dBm)} - P_{Avg (dBm)}$ (P_{Avg} = Average Power + Duty cycle Factor)

5.1.1 Peak power measurements with a spectrum/signal analyzer or EMI receiver

The following procedure can be used to determine the total peak output power.

- a) Set the RBW \geq OBW.
- b) Set VBW $\geq 3 \times$ RBW.
- c) Set span $\geq 2 \times$ RBW
- d) Sweep time = auto couple.
- e) Detector = peak.
- f) Ensure that the number of measurement points \geq span/RBW.
- g) Trace mode = max hold.
- h) Allow trace to fully stabilize.
- i) Use the peak marker function to determine the peak amplitude level.

5.2.2 Procedures for use with a spectrum/signal analyzer when EUT cannot be configured to transmit continuously and sweep triggering/signal gating cannot be properly implemented

If the EUT cannot be configured to transmit continuously (burst duty cycle < 98%), then one of the following procedures can be used. The selection of the applicable procedure will depend on the characteristics of the measured burst duty cycle.

Measure the burst duty cycle with a spectrum/signal analyzer or EMC receiver can be used in zero-span mode if the response time and spacing between bins on the sweep are sufficient to permit accurate measurement of the burst on/off time of the transmitted signal.

5.2.2.2 Constant burst duty cycle

If the measured burst duty cycle is constant (i.e., duty cycle variations are less than ± 2 percent), then:

- a) Set span to at least 1.5 times the OBW.
- b) Set RBW = 1-5% of the OBW, not to exceed 1 MHz.
- c) Set VBW $\geq 3 \times$ RBW.
- d) Number of points in sweep $\geq 2 \times$ span / RBW. (This gives bin-to-bin spacing \leq RBW/2, so that narrowband signals are not lost between frequency bins.)
- e) Sweep time = auto.
- f) Detector = RMS (power averaging).
- g) Set sweep trigger to "free run".
- h) Trace average at least 100 traces in power averaging (i.e., RMS) mode.
- i) Compute power by integrating the spectrum across the OBW of the signal using the instrument's band power measurement function with band limits set equal to the OBW band edges. If the instrument does not have a band power function, sum the spectrum levels (in power units) at intervals equal to the RBW extending across the entire OBW of the spectrum.
- j) Add $10 \log (1/x)$, where x is the duty cycle, to the measured power in order to compute the average power during the actual transmission times (because the measurement represents an average over both the on and off times of the transmission).

For example, add $10 \log (1/0.25) = 6$ dB if the duty cycle is a constant 25%.

3.4 OCCUPIED BANDWIDTH.

Test set-up

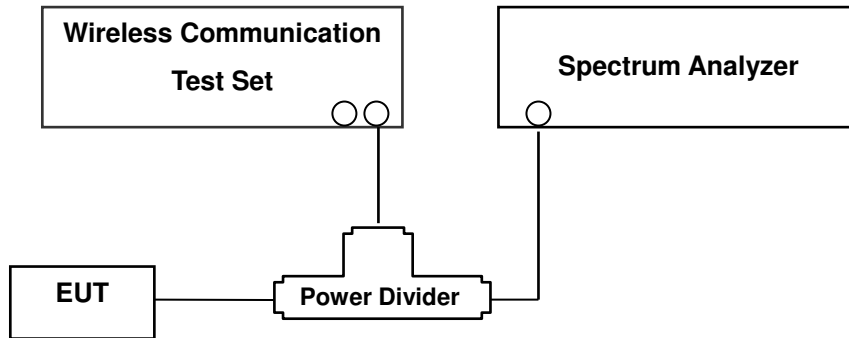

(Configuration of conducted Emission measurement)

The width of a frequency band such that, below the lower and above the upper frequency limits, the mean powers emitted are each equal to a specified percentage 0.5 % of the total mean power of a given emission.

Test Procedure

OBW is tested in accordance with KDB971168 D01 Power Meas License Digital Systems v02r02, October 17, 2014, Section 4.2.

The EUT makes a call to the communication simulator. The power was measured with R&S Spectrum Analyzer. All measurements were done at 3 channels(low, middle and high operational range.)

The conducted occupied bandwidth used the power splitter via EUT RF power connector between simulation base station and spectrum analyzer.

The communication simulator station system controlled a EUT to export maximum output power under transmission mode and specific channel frequency. Use OBW measurement function of Spectrum analyzer to measure 99 % occupied bandwidth

3.5 SPURIOUS AND HARMONIC EMISSIONS AT ANTENNA TERMINAL.

Test Procedure

Spurious and harmonic emissions at antenna terminal is tested in accordance with KDB971168 D01 Power Meas License Digital Systems v02r02, October 17, 2014, Section 6.0.

The level of the carrier and the various conducted spurious and harmonic frequencies is measured by means of a calibrated spectrum analyzer.

The EUT was setup to maximum output power at its lowest channel. The Resolution BW of the analyzer is set to 1 % of the emission bandwidth to show compliance with the -13 dBm limit, in the 1 MHz bands immediately outside and adjacent to the edge of the frequency block. The 1 MHz RBW was used to scan from 30 MHz to 10th Harmonics. A display line was placed at -13 dBm to show compliance. The high, lowest and a middle channel were tested for out of band measurements.

- Band Edge Requirement : In the 1MHz bands immediately outside and adjacent to the frequency block, a resolution bandwidth of at least 1 percent of the emission bandwidth of the fundamental emission of the transmitter may be employed to measure the out of band Emissions. Limit, -13dBm.

NOTES: The analyzer plot offsets were determined by below conditions.

- For LTE Band 2, total offset 27.6dBm = 20 dBm attenuator + 6 dBm Divider + 1.6 dBm RF cables.
- For LTE Band 5, total offset 27.0dBm = 20 dBm attenuator + 6 dBm Divider + 1.0 dBm RF cables.

3.6 FREQUENCY STABILITY / VARIATION OF AMBIENT TEMPERATURE

Test Set-up

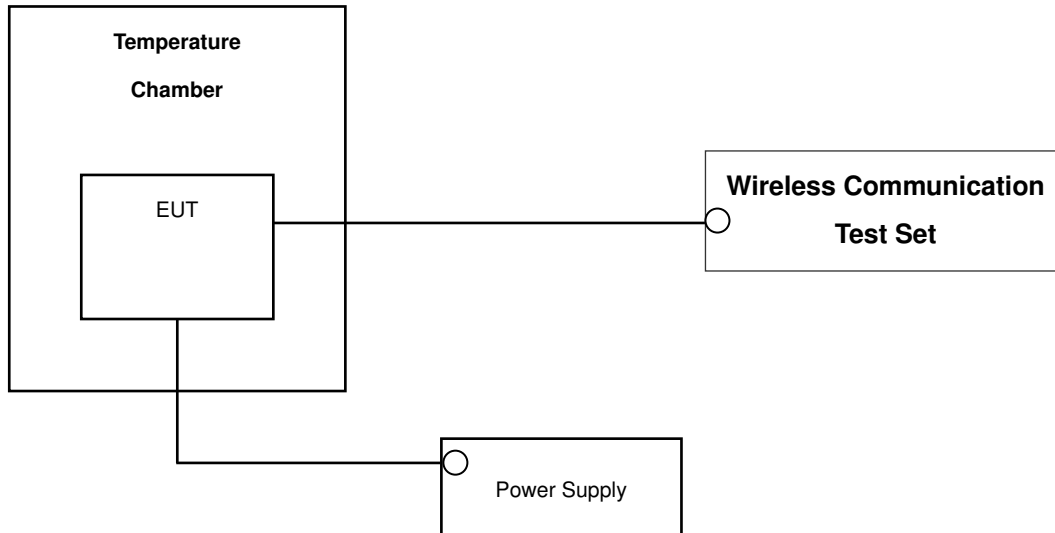

* Nominal Operating Voltage

Test Procedure

Frequency stability is tested in accordance with ANSI/TIA-603-D-2010 section 2.2.2

The frequency stability of the transmitter is measured by:

- a.) **Temperature:** The temperature is varied from - 30 °C to + 50 °C using an environmental chamber.
- b.) **Primary Supply Voltage:** The primary supply voltage is varied from the end point to 100 % of the voltage normally at the input to the device or at the power supply terminals if cables are not normally supplied.

Specification — the frequency stability shall be sufficient to ensure that the fundamental emission stays within the authorized frequency block(LTE Band2).The frequency stability of the transmitter shall be maintained within $\pm 0.00025\%$ (± 2.5 ppm) of the center frequency. (LTE Band5).

Time Period and Procedure:

The carrier frequency of the transmitter is measured at room temperature (20°C to provide a reference).

1. The equipment is turned on in a “standby” condition for one minute before applying power to the transmitter. Measurement of the carrier frequency of the transmitter is made within one minute after applying power to the transmitter.
2. Frequency measurements are made at 10°C intervals ranging from -30°C to +50°C. A period of at least one half-hour is provided to allow stabilization of the equipment at each temperature level.

NOTE: The EUT is tested down to the battery endpoint.

4. LIST OF TEST EQUIPMENT

Manufacture	Model/ Equipment	Serial Number	Calibration Date	Calibration Interval	Calibration Due
REOHDE&SCHWARZ	SCU 18 / AMPLIFIER	10094	09/07/2016	Annual	09/07/2017
Wainwright	WHK1.2/15G-10EF/H.P.F	4	04/11/2016	Annual	04/11/2017
Wainwright	WHK3.3/18G-10EF/H.P.F	2	04/11/2016	Annual	04/11/2017
Hewlett Packard	11667B / Power Splitter	10545	02/15/2016	Annual	02/15/2017
Hewlett Packard	11667B / Power Splitter	11275	04/29/2016	Annual	04/29/2017
Agilent	E3632A/DC Power Supply	KR75303243	07/12/2016	Annual	07/12/2017
Schwarzbeck	UHAP/ Dipole Antenna	557	03/23/2015	Biennial	03/23/2017
Schwarzbeck	UHAP/ Dipole Antenna	558	03/23/2015	Biennial	03/23/2017
EXP	EX-TH400/ Chamber	None	05/31/2016	Annual	05/31/2017
Schwarzbeck	BBHA 9120D/ Horn Antenna	147	09/09/2016	Biennial	09/09/2018
Schwarzbeck	BBHA 9120D/ Horn Antenna	1299	05/15/2015	Biennial	05/15/2017
Schwarzbeck	BBHA 9170/ Horn Antenna(15~40GHz)	BBHA9170342	04/30/2015	Biennial	04/30/2017
Schwarzbeck	BBHA 9170/ Horn Antenna(15~35GHz)	BBHA9170124	04/30/2015	Biennial	04/30/2017
Agilent	N9020A/Signal Analyzer	MY52090906	05/13/2016	Annual	05/13/2017
Hewlett Packard	8493C/ATTENUATOR	17280	06/22/2016	Annual	06/22/2017
REOHDE&SCHWARZ	FSV40/Spectrum Analyzer	1307.9002K40-100931-NK	06/15/2016	Annual	06/15/2017
Agilent	8960 (E5515C)/ Base Station(Now)	MY48360800	10/19/2016	Annual	10/19/2017
Schwarzbeck	FMZB1513/ Loop Antenna(9kHz~30MHz)	1513-175	02/23/2016	Biennial	02/23/2018
Schwarzbeck	VULB9160/ Bilog Antenna	3150	09/30/2016	Biennial	09/30/2018
Schwarzbeck	VULB9160/ Bilog Antenna	3368	10/14/2016	Biennial	10/14/2018
Anritsu Corp.	MT8820C/Wideband Radio Communication Tester	6200863156	02/26/2016	Annual	02/26/2017
Anritsu Corp.	MT8820C/Wideband Radio Communication Tester	6201026545	02/16/2016	Annual	02/16/2017

5. MEASUREMENT UNCERTAINTY

The measurement uncertainties shown below were calculated in accordance with the requirements of ANSI C63.4:2014.

All measurement uncertainty values are shown with a coverage factor of $k = 2$ to indicate a 95 % level of confidence. The measurement data shown herein meets or exceeds the U_{CISPR} measurement uncertainty values specified in CISPR 16-4-2 and, thus, can be compared directly to specified limits to determine compliance.

Parameter	Expanded Uncertainty (\pm dB)
Conducted Disturbance (150 kHz ~ 30 MHz)	1.82
Radiated Disturbance (9 kHz ~ 30 MHz)	3.40
Radiated Disturbance (30 MHz ~ 1 GHz)	4.80
Radiated Disturbance (1 GHz ~ 18 GHz)	6.07

6. SUMMARY OF TEST RESULTS

FCC Part Section(s)	Test Description	Test Limit	Test Condition	Test Result
2.1049	Occupied Bandwidth	N/A	CONDUCTED	PASS
2.1051, 22.917(a), 24.238(a)	Band Edge / Spurious and Harmonic Emissions at Antenna Terminal.	$< 43 + 10\log_{10}(P[\text{Watts}])$ at Band Edge and for all out-of-band emissions		PASS
2.1046	* Conducted Output Power	N/A		PASS
24.232(d)	Peak- to- Average Ratio	$< 13 \text{ dB}$		PASS
2.1055, 22.355	Frequency stability / variation of ambient temperature	$< 2.5 \text{ ppm}$ (Part22)		PASS
24.235		Emission must remain in band (Part24)		
22.913(a)(2)	Effective Radiated Power (Band 5)	$< 7 \text{ Watts max. ERP}$	RADIATED	PASS
24.232(c)	Equivalent Isotropic Radiated Power (Band 2)	$< 2 \text{ Watts max. EIRP}$		PASS
2.1053, 22.917(a), 24.238(a)	Radiated Spurious and Harmonic Emissions	$< 43 + 10\log_{10}(P[\text{Watts}])$ for all out-of band emissions		PASS

*: See SAR Report

7. SAMPLE CALCULATION

A. ERP Sample Calculation

Mode	Ch./ Freq.		Measured Level(dBm)	Substitute LEVEL(dBm)	Ant. Gain (dBd)	C.L	Pol.	Limit W	ERP	
	channel	Freq.(MHz)							W	dBm
LTE Band5	20525	836.50	-6.73	40.89	-10.54	0.96	V	< 7.00	0.869	29.39

ERP = Substitute LEVEL(dBm) + Ant. Gain – CL(Cable Loss)

- 1) The EUT mounted on a wooden tripod is 2.5 meter above test site ground level.
- 2) During the test , the turn table is rotated until the maximum signal is found.
- 3) Record the field strength meter's level.
- 4) Replace the EUT with dipole/Horn antenna that is connected to a calibrated signal generator.
- 5) Increase the signal generator output till the field strength meter's level is equal to the item (3).
- 6) The signal generator output level with Ant. Gain and cable loss are the rating of effective radiated power(ERP).

B. Emission Designator

QPSK Modulation

5MHz Bandwidth

Emission Designator = 4M48G7D

LTE BW = 4.48 MHz

G = Phase Modulation

7 = Quantized/Digital Info

D = Data transmission; telemetry; telecommand

10MHz Bandwidth

Emission Designator = 8M95G7D

LTE BW = 8.95 MHz

G = Phase Modulation

7 = Quantized/Digital Info

D = Data transmission; telemetry; telecommand

16QAM Modulation

5MHz Bandwidth

Emission Designator = 4M48W7D

LTE BW = 4.48 MHz

W = main carrier modulated in a combination of two
or more of the following modes;
amplitude, angle, pulse

7 = Quantized/Digital Info

D = Data transmission; telemetry; telecommand

10MHz Bandwidth

Emission Designator = 8M95W7D

LTE BW = 8.95 MHz

W = main carrier modulated in a combination of two
or more of the following modes;
amplitude, angle, pulse

7 = Quantized/Digital Info

D = Data transmission; telemetry; telecommand

8. TEST DATA

8.1 EQUIVALENT ISOTROPIC RADIATED POWER (Band 2)

Freq (MHz)	Bandwidth	Modulation	Measured Level (dBm)	Substitute Level (dBm)	Ant. Gain(dBi)	C.L	Pol	Limit	EIRP	
								W	W	dBm
1850.7	1.4 MHz	QPSK	-16.59	17.02	9.82	2.54	H	< 2.00	0.269	24.30
		16-QAM	-17.32	16.29	9.82	2.54	H		0.228	23.57
1880.0		QPSK	-17.01	16.87	9.91	2.57	H		0.263	24.21
		16-QAM	-17.70	16.18	9.91	2.57	H		0.225	23.52
1909.3		QPSK	-17.77	16.47	10.00	2.60	H		0.244	23.87
		16-QAM	-18.40	15.89	10.00	2.60	H		0.213	23.29

Equivalent Isotropic Radiated Power Data (1.4 MHz Band 2 LTE)

Note: All of RB size has been tested for emissions and EIRP, with the 1RB configuration observed as the worst case

Freq (MHz)	Bandwidth	Modulation	Measured Level (dBm)	Substitute Level (dBm)	Ant. Gain(dBi)	C.L	Pol	Limit	EIRP	
								W	W	dBm
1851.5	3 MHz	QPSK	-16.49	17.12	9.82	2.54	H	< 2.00	0.275	24.40
		16-QAM	-17.25	16.36	9.82	2.54	H		0.231	23.64
1880.0		QPSK	-16.85	17.03	9.91	2.57	H		0.273	24.37
		16-QAM	-17.61	16.27	9.91	2.57	H		0.229	23.61
1908.5		QPSK	-17.52	16.49	10.00	2.60	H		0.245	23.89
		16-QAM	-18.21	15.80	10.00	2.60	H		0.209	23.20

Equivalent Isotropic Radiated Power Data (3 MHz Band 2 LTE)

Note: All of RB size has been tested for emissions and EIRP, with the 1RB configuration observed as the worst case

Freq (MHz)	Bandwidth	Modulation	Measured Level (dBm)	Substitute Level (dBm)	Ant. Gain(dBi)	C.L	Pol	Limit	EIRP	
								W	W	dBm
1852.5	5 MHz	QPSK	-16.54	17.07	9.82	2.54	H	< 2.00	0.272	24.35
		16-QAM	-17.30	16.31	9.82	2.54	H		0.229	23.59
1880.0		QPSK	-16.95	16.93	9.91	2.57	H		0.267	24.27
		16-QAM	-17.70	16.18	9.91	2.57	H		0.225	23.52
1907.5		QPSK	-17.60	16.41	10.00	2.60	H		0.240	23.81
		16-QAM	-18.28	15.73	10.00	2.60	H		0.205	23.13

Equivalent Isotropic Radiated Power Data (5 MHz Band 2 LTE)

Note: All of RB size has been tested for emissions and EIRP, with the 1RB configuration observed as the worst case

Freq (MHz)	Bandwidth	Modulation	Measured Level (dBm)	Substitute Level (dBm)	Ant. Gain(dBi)	C.L	Pol	Limit	EIRP	
								W	W	dBm
1855.0	10 MHz	QPSK	-16.52	17.13	9.83	2.54	H	< 2.00	0.277	24.42
		16-QAM	-17.27	16.38	9.83	2.54	H		0.233	23.67
1880.0		QPSK	-17.04	16.84	9.91	2.57	H		0.262	24.18
		16-QAM	-17.79	16.09	9.91	2.57	H		0.220	23.43
1905.0		QPSK	-17.34	16.79	9.98	2.59	H		0.262	24.18
		16-QAM	-18.00	16.13	9.98	2.59	H		0.225	23.52

Equivalent Isotropic Radiated Power Data (10 MHz Band 2 LTE)

Note: All of RB size has been tested for emissions and EIRP, with the 1RB configuration observed as the worst case

Freq (MHz)	Bandwidth	Modulation	Measured Level (dBm)	Substitute Level (dBm)	Ant. Gain(dBi)	C.L	Pol	Limit	EIRP	
								W	W	dBm
1857.5	15 MHz	QPSK	-16.47	17.22	9.85	2.55	H	< 2.00	0.283	24.52
		16-QAM	-17.25	16.44	9.85	2.55	H		0.237	23.74
1880.0		QPSK	-16.92	16.96	9.91	2.57	H		0.269	24.30
		16-QAM	-17.69	16.19	9.91	2.57	H		0.225	23.53
1902.5		QPSK	-17.36	16.67	9.97	2.59	H		0.254	24.05
		16-QAM	-18.05	15.98	9.97	2.59	H		0.217	23.36

Equivalent Isotropic Radiated Power Data (15 MHz Band 2 LTE)

Note: All of RB size has been tested for emissions and EIRP, with the 1RB configuration observed as the worst case

Freq (MHz)	Bandwidth	Modulation	Measured Level (dBm)	Substitute Level (dBm)	Ant. Gain(dBi)	C.L	Pol	Limit	EIRP	
								W	W	dBm
1860.0	20 MHz	QPSK	-16.41	17.28	9.85	2.55	H	< 2.00	0.287	24.58
		16-QAM	-17.21	16.48	9.85	2.55	H		0.239	23.78
1880.0		QPSK	-16.81	17.07	9.91	2.57	H		0.276	24.41
		16-QAM	-17.58	16.30	9.91	2.57	H		0.231	23.64
1900.0		QPSK	-16.99	17.04	9.97	2.59	H		0.277	24.42
		16-QAM	-17.70	16.33	9.97	2.59	H		0.235	23.71

Equivalent Isotropic Radiated Power Data (20 MHz Band 2 LTE)

Note: All of RB size has been tested for emissions and EIRP, with the 1RB configuration observed as the worst case

NOTES:

Equivalent Isotropic Radiated Power Measurements by Substitution Method
according to ANSI/TIA/EIA-603-D-2010 June 24, 2010:

The EUT was placed on a non-conductive styrofoam resin table 3-meters from the receive antenna. Turntable rotation was adjusted for the highest reading on the receive spectrum analyzer. For LTE signals, RBW = 1-5% of the OBW, not to exceed 1MHz, VBW $\geq 3 \times$ RBW, Detector = RMS. A Horn antenna was substituted in place of the EUT. This Horn antenna was driven by a signal generator and the level of the signal generator was adjusted to obtain the same receive spectrum analyzer reading. The conducted power at the terminals of the Horn antenna is measured. The difference between the gain of the horn and an isotropic antenna is taken into consideration and the EIRP is recorded.

Also, we have done x, y, z planes in EUT and horizontal and vertical polarization in detecting antenna. The worst case of the EUT is x plane in LTE mode. Also worst case of detecting Antenna is horizontal polarization in LTE mode.

8.2 EFFECTIVE RADIATED POWER (Band 5)

Freq (MHz)	Bandwidth	Modulation	Measured Level (dBm)	Substitute Level (dBm)	Ant. Gain(dBd)	C.L	Pol	Limit	ERP	
								W	W	dBm
824.7	1.4 MHz	QPSK	-30.64	31.98	-10.59	1.67	V	< 7.00	0.094	19.72
		16-QAM	-31.34	31.28	-10.59	1.67	V		0.080	19.02
836.5		QPSK	-31.22	32.34	-10.54	1.68	V		0.103	20.12
		16-QAM	-31.99	31.57	-10.54	1.68	V		0.086	19.35
848.3		QPSK	-32.01	31.08	-10.49	1.69	V		0.078	18.90
		16-QAM	-32.80	30.29	-10.49	1.69	V		0.065	18.11

Effective Radiated Power Data (1.4 MHz Band 5 LTE)

Note: All of RB size has been tested for emissions and ERP, with the 1RB configuration observed as the worst case

Freq (MHz)	Bandwidth	Modulation	Measured Level (dBm)	Substitute Level (dBm)	Ant. Gain(dBd)	C.L	Pol	Limit	ERP	
								W	W	dBm
825.5	3 MHz	QPSK	-30.47	32.23	-10.59	1.67	V	< 7.00	0.099	19.97
		16-QAM	-31.23	31.47	-10.59	1.67	V		0.083	19.21
836.5		QPSK	-31.03	32.53	-10.54	1.68	V		0.107	20.31
		16-QAM	-31.86	31.70	-10.54	1.68	V		0.089	19.48
847.5		QPSK	-31.68	31.41	-10.49	1.69	V		0.084	19.23
		16-QAM	-32.47	30.62	-10.49	1.69	V		0.070	18.44

Effective Radiated Power Data (3 MHz Band 5 LTE)

Note: All of RB size has been tested for emissions and ERP, with the 1RB configuration observed as the worst case

Freq (MHz)	Bandwidth	Modulation	Measured Level (dBm)	Substitute Level (dBm)	Ant. Gain(dBd)	C.L	Pol	Limit	ERP	
								W	W	dBm
826.5	5 MHz	QPSK	-30.57	32.25	-10.58	1.67	V	< 7.00	0.100	20.00
		16-QAM	-31.32	31.50	-10.58	1.67	V		0.084	19.25
836.5		QPSK	-31.06	32.50	-10.54	1.68	V		0.107	20.28
		16-QAM	-31.88	31.68	-10.54	1.68	V		0.088	19.46
846.5		QPSK	-31.59	31.58	-10.50	1.69	V		0.087	19.39
		16-QAM	-32.33	30.84	-10.50	1.69	V		0.073	18.65

Effective Radiated Power Data (5 MHz Band 5 LTE)

Note: All of RB size has been tested for emissions and ERP, with the 1RB configuration observed as the worst case

Freq (MHz)	Bandwidth	Modulation	Measured Level (dBm)	Substitute Level (dBm)	Ant. Gain(dBd)	C.L	Pol	Limit	ERP	
								W	W	dBm
829.0	10 MHz	QPSK	-30.55	32.55	-10.57	1.67	V	< 7.00	0.107	20.31
		16-QAM	-31.29	31.81	-10.57	1.67	V		0.091	19.57
836.5		QPSK	-30.87	32.69	-10.54	1.68	V		0.111	20.47
		16-QAM	-31.65	31.91	-10.54	1.68	V		0.093	19.69
844.0		QPSK	-31.27	32.09	-10.51	1.69	V		0.098	19.89
		16-QAM	-32.06	31.30	-10.51	1.69	V		0.081	19.10

Effective Radiated Power Data (10 MHz Band 5 LTE)

Note: All of RB size has been tested for emissions and ERP, with the 1RB configuration observed as the worst case

NOTES:

Effective Radiated Power Output Measurements by Substitution Method

according to ANSI/TIA/EIA-603-D-2010 June 24, 2010:

The EUT was placed on a non-conductive styrofoam resin table 3-meters from the receive antenna. The receive antenna height and turntable rotation was adjusted for the highest reading on the receive spectrum analyzer. For LTE signals, RBW = 1-5% of the OBW, not to exceed 1MHz, VBW ≥ 3 x RBW, Detector = RMS.

A half-wave dipole was substituted in place of the EUT. This dipole antenna was driven by a signal generator and the level of the signal generator was adjusted to obtain the same receive spectrum analyzer reading. The conducted power at the terminals of the dipole is measured. The ERP is recorded.

Also, we have done x, y, z planes in EUT and horizontal and vertical polarization in detecting antenna. The worst case of the EUT is y plane in LTE mode. Also worst case of detecting Antenna is vertical polarization in LTE mode.

8.3 RADIATED SPURIOUS EMISSIONS

8.3.1 RADIATED SPURIOUS EMISSIONS (1.4 MHz Band 2 LTE)

- ▣ OPERATING FREQUENCY: 1850.70 MHz
- ▣ MEASURED OUTPUT POWER: 24.30 dBm = 0.269 W
- ▣ MODULATION SIGNAL: 1.4 MHz QPSK
- ▣ DISTANCE: 3 meters
- ▣ LIMIT: $43 + 10 \log_{10}(W) =$ 37.30 dBc

Ch	Freq (MHz)	Measured Level (dBm)	Ant. Gain (dBi)	Substitute Level (dBm)	C.L	Pol	EIRP (dBm)	dBc
18607 (1850.7)	3,701.40	-52.39	12.52	-58.44	1.69	V	-47.61	71.91
	5,552.10	-56.13	13.29	-56.70	2.82	H	-46.23	70.53
	7,402.80	-54.18	11.72	-49.84	3.85	H	-41.97	66.27
18900 (1880.0)	3,760.00	-55.75	12.56	-61.58	1.67	V	-50.69	74.99
	5,640.00	-56.53	13.30	-56.67	2.90	H	-46.27	70.57
	7,520.00	-55.21	11.70	-50.93	3.98	V	-43.21	67.51
19193 (1909.3)	3,818.60	-53.53	12.60	-59.03	1.65	H	-48.08	72.38
	5,727.90	-55.56	13.31	-54.65	2.92	H	-44.26	68.56
	7,637.20	-54.44	11.62	-50.37	3.99	H	-42.74	67.04

- NOTES:**
1. Radiated Spurious Emission Measurements at 3 meters by Substitution Method according to ANSI/TIA/EIA-603-D-2010 June 24, 2010:
 2. We are performed all frequency to 10th harmonics from 9 kHz. Measurements above show only up to 3 maximum emissions noted, or would be lesser if no specific emissions from the EUT are recorded (ie: margin > 20 dB from the applicable limit) and considered that's already beyond the background noise floor.
 3. We have done x, y, z planes in EUT and horizontal and vertical polarization in detecting antenna.
 4. All of RB size has been tested for emissions and EIRP, with the 1RB configuration observed as the worst case
 5. We are performed 16QAM and QPSK modulations. The worst case data are reported in the table above.

8.3.2 RADIATED SPURIOUS EMISSIONS (3 MHz Band 2 LTE)

- ▣ OPERATING FREQUENCY: 1851.50 MHz
- ▣ MEASURED OUTPUT POWER: 24.40 dBm = 0.275 W
- ▣ MODULATION SIGNAL: 3 MHz QPSK
- ▣ DISTANCE: 3 meters
- ▣ LIMIT: $43 + 10 \log_{10}(W) =$ 37.40 dBc

Ch	Freq (MHz)	Measured Level (dBm)	Ant. Gain (dBi)	Substitute Level (dBm)	C.L	Pol	EIRP (dBm)	dBc
18615 (1851.5)	3,703.00	-52.16	12.52	-58.21	1.69	H	-47.38	71.78
	5,554.50	-54.97	13.29	-55.45	2.82	H	-44.97	69.37
	7,406.00	-54.19	11.72	-49.69	3.88	V	-41.84	66.24
18900 (1880.0)	3,760.00	-55.51	12.56	-61.34	1.67	H	-50.45	74.85
	5,640.00	-55.49	13.30	-55.63	2.90	V	-45.23	69.63
	7,520.00	-54.23	11.70	-49.95	3.98	H	-42.23	66.63
19185 (1908.5)	3,817.00	-53.73	12.60	-59.43	1.66	H	-48.48	72.88
	5,725.50	-57.14	13.31	-56.09	2.92	H	-45.69	70.09
	7,634.00	-55.44	11.62	-51.37	3.99	H	-43.74	68.14

- NOTES:**
1. Radiated Spurious Emission Measurements at 3 meters by Substitution Method according to ANSI/TIA/EIA-603-D-2010 June 24, 2010:
 2. We are performed all frequency to 10th harmonics from 9 kHz. Measurements above show only up to 3 maximum emissions noted, or would be lesser if no specific emissions from the EUT are recorded (ie: margin > 20 dB from the applicable limit) and considered that's already beyond the background noise floor.
 3. We have done x, y, z planes in EUT and horizontal and vertical polarization in detecting antenna.
 4. All of RB size has been tested for emissions and EIRP, with the 1RB configuration observed as the worst case
 5. We are performed 16QAM and QPSK modulations. The worst case data are reported in the table above.

8.3.3 RADIATED SPURIOUS EMISSIONS (5 MHz Band 2 LTE)

- ▣ OPERATING FREQUENCY: 1852.50 MHz
- ▣ MEASURED OUTPUT POWER: 24.35 dBm = 0.272 W
- ▣ MODULATION SIGNAL: 5 MHz QPSK
- ▣ DISTANCE: 3 meters
- ▣ LIMIT: $43 + 10 \log_{10}(W) =$ 37.35 dBc

Ch	Freq (MHz)	Measured Level (dBm)	Ant. Gain (dBi)	Substitute Level (dBm)	C.L	Pol	EIRP (dBm)	dBc
18625 (1852.5)	3,705.00	-52.00	12.52	-57.91	1.68	H	-47.07	71.42
	5,557.50	-54.80	13.29	-55.23	2.83	H	-44.76	69.11
	7,410.00	-54.88	11.72	-50.21	3.90	V	-42.39	66.74
18900 (1880.0)	3,760.00	-53.93	12.56	-59.76	1.67	V	-48.87	73.22
	5,640.00	-55.56	13.30	-55.70	2.90	V	-45.30	69.65
	7,520.00	-53.65	11.70	-49.37	3.98	H	-41.65	66.00
19175 (1907.5)	3,815.00	-55.85	12.60	-61.55	1.66	H	-50.60	74.95
	5,722.50	-57.42	13.31	-56.23	2.91	V	-45.83	70.18
	7,630.00	-54.62	11.62	-50.59	3.98	V	-42.95	67.30

- NOTES:**
1. Radiated Spurious Emission Measurements at 3 meters by Substitution Method according to ANSI/TIA/EIA-603-D-2010 June 24, 2010:
 2. We are performed all frequency to 10th harmonics from 9 kHz. Measurements above show only up to 3 maximum emissions noted, or would be lesser if no specific emissions from the EUT are recorded (ie: margin > 20 dB from the applicable limit) and considered that's already beyond the background noise floor.
 3. We have done x, y, z planes in EUT and horizontal and vertical polarization in detecting antenna.
 4. All of RB size has been tested for emissions and EIRP, with the 1RB configuration observed as the worst case
 5. We are performed 16QAM and QPSK modulations. The worst case data are reported in the table above.

8.3.4 RADIATED SPURIOUS EMISSIONS (10 MHz Band 2 LTE)

- ▣ OPERATING FREQUENCY: 1855.00 MHz
- ▣ MEASURED OUTPUT POWER: 24.42 dBm = 0.277 W
- ▣ MODULATION SIGNAL: 10 MHz QPSK
- ▣ DISTANCE: 3 meters
- ▣ LIMIT: $43 + 10 \log_{10}(W) =$ 37.42 dBc

Ch	Freq (MHz)	Measured Level (dBm)	Ant. Gain (dBi)	Substitute Level (dBm)	C.L	Pol	EIRP (dBm)	dBc
18650 (1855.0)	3,710.00	-52.45	12.52	-58.22	1.67	H	-47.37	71.79
	5,565.00	-55.45	13.29	-55.95	2.82	H	-45.48	69.90
	7,420.00	-54.23	11.72	-49.54	3.87	H	-41.69	66.11
18900 (1880.0)	3,760.00	-54.60	12.56	-60.43	1.67	H	-49.54	73.96
	5,640.00	-55.80	13.30	-55.94	2.90	V	-45.54	69.96
	7,520.00	-54.33	11.70	-50.05	3.98	V	-42.33	66.75
19150 (1905.0)	3,810.00	-53.46	12.60	-59.36	1.66	H	-48.42	72.84
	5,715.00	-55.47	13.31	-54.47	2.90	V	-44.06	68.48
	7,620.00	-54.27	11.62	-50.31	3.97	H	-42.66	67.08

- NOTES:**
1. Radiated Spurious Emission Measurements at 3 meters by Substitution Method according to ANSI/TIA/EIA-603-D-2010 June 24, 2010:
 2. We are performed all frequency to 10th harmonics from 9 kHz. Measurements above show only up to 3 maximum emissions noted, or would be lesser if no specific emissions from the EUT are recorded (ie: margin > 20 dB from the applicable limit) and considered that's already beyond the background noise floor.
 3. We have done x, y, z planes in EUT and horizontal and vertical polarization in detecting antenna.
 4. All of RB size has been tested for emissions and EIRP, with the 1RB configuration observed as the worst case
 5. We are performed 16QAM and QPSK modulations. The worst case data are reported in the table above.

8.3.5 RADIATED SPURIOUS EMISSIONS (15 MHz Band 2 LTE)

- ▣ OPERATING FREQUENCY: 1857.50 MHz
- ▣ MEASURED OUTPUT POWER: 24.52 dBm = 0.283 W
- ▣ MODULATION SIGNAL: 15 MHz QPSK
- ▣ DISTANCE: 3 meters
- ▣ LIMIT: $43 + 10 \log_{10} (W) =$ 37.52 dBc

Ch	Freq (MHz)	Measured Level (dBm)	Ant. Gain (dBi)	Substitute Level (dBm)	C.L	Pol	EIRP (dBm)	dBc
18675 (1857.5)	3,715.00	-52.29	12.52	-58.22	1.66	H	-47.36	71.88
	5,572.50	-55.45	13.29	-56.05	2.83	H	-45.59	70.11
	7,430.00	-55.27	11.72	-50.75	3.87	V	-42.90	67.42
18900 (1880.0)	3,760.00	-52.14	12.56	-57.97	1.67	H	-47.08	71.60
	5,640.00	-55.59	13.30	-55.73	2.90	H	-45.33	69.85
	7,520.00	-54.81	11.70	-50.53	3.98	H	-42.81	67.33
19125 (1902.5)	3,805.00	-55.96	12.59	-61.61	1.67	V	-50.69	75.21
	5,707.50	-55.49	13.31	-54.67	2.89	V	-44.25	68.77
	7,610.00	-55.04	11.63	-50.95	3.95	V	-43.27	67.79

- NOTES:**
1. Radiated Spurious Emission Measurements at 3 meters by Substitution Method according to ANSI/TIA/EIA-603-D-2010 June 24, 2010:
 2. We are performed all frequency to 10th harmonics from 9 kHz. Measurements above show only up to 3 maximum emissions noted, or would be lesser if no specific emissions from the EUT are recorded (ie: margin > 20 dB from the applicable limit) and considered that's already beyond the background noise floor.
 3. We have done x, y, z planes in EUT and horizontal and vertical polarization in detecting antenna.
 4. All of RB size has been tested for emissions and EIRP, with the 1RB configuration observed as the worst case
 5. We are performed 16QAM and QPSK modulations. The worst case data are reported in the table above.

8.3.6 RADIATED SPURIOUS EMISSIONS (20 MHz Band 2 LTE)

- ▣ OPERATING FREQUENCY: 1860.00 MHz
- ▣ MEASURED OUTPUT POWER: 24.58 dBm = 0.287 W
- ▣ MODULATION SIGNAL: 20 MHz QPSK
- ▣ DISTANCE: 3 meters
- ▣ LIMIT: $43 + 10 \log_{10}(W) =$ 37.58 dBc

Ch	Freq (MHz)	Measured Level (dBm)	Ant. Gain (dBi)	Substitute Level (dBm)	C.L	Pol	EIRP (dBm)	dBc
18700 (1860.0)	3,720.00	-52.06	12.53	-58.16	1.64	V	-47.27	71.85
	5,580.00	-55.65	13.29	-55.90	2.82	H	-45.43	70.01
	7,440.00	-53.97	11.72	-49.42	3.87	V	-41.57	66.15
18900 (1880.0)	3,760.00	-53.01	12.56	-58.84	1.67	H	-47.95	72.53
	5,640.00	-55.72	13.30	-55.86	2.90	V	-45.46	70.04
	7,520.00	-54.38	11.70	-50.10	3.98	V	-42.38	66.96
19100 (1900.0)	3,800.00	-55.50	12.59	-60.91	1.68	V	-50.00	74.58
	5,700.00	-56.25	13.31	-55.67	2.87	V	-45.23	69.81
	7,600.00	-54.78	11.64	-50.39	3.94	H	-42.69	67.27

- NOTES:**
1. Radiated Spurious Emission Measurements at 3 meters by Substitution Method according to ANSI/TIA/EIA-603-D-2010 June 24, 2010:
 2. We are performed all frequency to 10th harmonics from 9 kHz. Measurements above show only up to 3 maximum emissions noted, or would be lesser if no specific emissions from the EUT are recorded (ie: margin > 20 dB from the applicable limit) and considered that's already beyond the background noise floor.
 3. We have done x, y, z planes in EUT and horizontal and vertical polarization in detecting antenna.
 4. All of RB size has been tested for emissions and EIRP, with the 1RB configuration observed as the worst case
 5. We are performed 16QAM and QPSK modulations. The worst case data are reported in the table above.

8.3.7 RADIATED SPURIOUS EMISSIONS (1.4 MHz Band 5 LTE)

- ▣ OPERATING FREQUENCY: 836.50 MHz
- ▣ MEASURED OUTPUT POWER: 20.12 dBm = 0.103 W
- ▣ MODULATION SIGNAL: 1.4 MHz QPSK
- ▣ DISTANCE: 3 meters
- ▣ LIMIT: $43 + 10 \log_{10}(W) =$ 33.12 dBc

Ch	Freq (MHz)	Measured Level (dBm)	Ant. Gain (dBd)	Substitute Level (dBm)	C.L	Pol	ERP (dBm)	dBc
20407 (824.7)	1,649.40	-56.45	9.16	-67.16	1.17	V	-59.17	79.29
	2,474.10	-54.79	10.93	-62.22	1.18	H	-52.48	72.60
	3,298.80	-56.91	11.94	-64.43	1.41	V	-53.90	74.02
20525 (836.5)	1,673.00	-56.86	9.23	-67.54	1.17	H	-59.48	79.60
	2,509.50	-52.74	10.96	-60.37	1.24	H	-50.65	70.77
	3,346.00	-56.57	12.04	-64.33	1.46	V	-53.75	73.87
20643 (848.3)	1,696.60	-55.38	9.32	-66.10	1.16	V	-57.94	78.06
	2,544.90	-53.92	10.99	-61.38	1.21	H	-51.61	71.73
	3,393.20	-55.47	12.14	-63.09	1.49	V	-52.44	72.56

- NOTES:**
1. Radiated Spurious Emission Measurements at 3 meters by Substitution Method according to ANSI/TIA/EIA-603-D-2010 June 24, 2010:
 2. We are performed all frequency to 10th harmonics from 9 kHz. Measurements above show only up to 3 maximum emissions noted, or would be lesser if no specific emissions from the EUT are recorded (ie: margin > 20 dB from the applicable limit) and considered that's already beyond the background noise floor.
 3. We have done x, y, z planes in EUT and horizontal and vertical polarization in detecting antenna.
 4. All of RB size has been tested for emissions and ERP, with the 1RB configuration observed as the worst case
 5. We are performed 16QAM and QPSK modulations. The worst case data are reported in the table above.

8.3.8 RADIATED SPURIOUS EMISSIONS (3 MHz Band 5 LTE)

- ▣ OPERATING FREQUENCY: 836.50 MHz
- ▣ MEASURED OUTPUT POWER: 20.31 dBm = 0.107 W
- ▣ MODULATION SIGNAL: 3 MHz QPSK
- ▣ DISTANCE: 3 meters
- ▣ LIMIT: $43 + 10 \log_{10}(W) =$ 33.31 dBc

Ch	Freq (MHz)	Measured Level (dBm)	Ant. Gain (dBd)	Substitute Level (dBm)	C.L	Pol	ERP (dBm)	dBc
20415 (825.5)	1,651.00	-55.93	9.16	-66.64	1.17	H	-58.65	78.96
	2,476.50	-53.63	10.93	-61.06	1.18	H	-51.32	71.63
	3,302.00	-55.56	11.94	-63.08	1.41	V	-52.55	72.86
20525 (836.5)	1,673.00	-56.67	9.23	-67.35	1.17	V	-59.29	79.60
	2,509.50	-53.80	10.96	-61.43	1.24	H	-51.71	72.02
	3,346.00	-55.98	10.03	-61.74	1.46	H	-53.16	73.47
20635 (847.5)	1,695.00	-57.53	9.32	-68.25	1.16	V	-60.09	80.40
	2,542.50	-51.66	10.98	-58.90	1.21	H	-49.13	69.44
	3,390.00	-56.63	12.13	-64.36	1.48	H	-53.71	74.02

- NOTES:**
1. Radiated Spurious Emission Measurements at 3 meters by Substitution Method according to ANSI/TIA/EIA-603-D-2010 June 24, 2010:
 2. We are performed all frequency to 10th harmonics from 9 kHz. Measurements above show only up to 3 maximum emissions noted, or would be lesser if no specific emissions from the EUT are recorded (ie: margin > 20 dB from the applicable limit) and considered that's already beyond the background noise floor.
 3. We have done x, y, z planes in EUT and horizontal and vertical polarization in detecting antenna.
 4. All of RB size has been tested for emissions and ERP, with the 1RB configuration observed as the worst case
 5. We are performed 16QAM and QPSK modulations. The worst case data are reported in the table above.

8.3.9 RADIATED SPURIOUS EMISSIONS (5 MHz Band 5 LTE)

- ▣ OPERATING FREQUENCY: 836.50 MHz
- ▣ MEASURED OUTPUT POWER: 20.28 dBm = 0.107 W
- ▣ MODULATION SIGNAL: 5 MHz QPSK
- ▣ DISTANCE: 3 meters
- ▣ LIMIT: $43 + 10 \log_{10}(W) =$ 33.28 dBc

Ch	Freq (MHz)	Measured Level (dBm)	Ant. Gain (dBd)	Substitute Level (dBm)	C.L	Pol	ERP (dBm)	dBc
20425 (826.5)	1,653.00	-56.82	9.18	-67.59	1.17	V	-59.58	79.86
	2,479.50	-54.50	10.93	-62.12	1.18	H	-52.37	72.65
	3,306.00	-56.94	11.95	-64.46	1.42	H	-53.92	74.20
20525 (836.5)	1,673.00	-56.01	9.23	-66.69	1.17	V	-58.63	78.91
	2,509.50	-55.11	10.96	-62.74	1.24	H	-53.02	73.30
	3,346.00	-56.82	10.03	-62.58	1.46	V	-54.00	74.28
20625 (846.5)	1,693.00	-56.60	9.32	-67.32	1.16	H	-59.16	79.44
	2,539.50	-53.45	10.98	-60.69	1.21	H	-50.92	71.20
	3,386.00	-56.36	12.22	-64.22	1.48	V	-53.47	73.75

- NOTES:**
1. Radiated Spurious Emission Measurements at 3 meters by Substitution Method according to ANSI/TIA/EIA-603-D-2010 June 24, 2010:
 2. We are performed all frequency to 10th harmonics from 9 kHz. Measurements above show only up to 3 maximum emissions noted, or would be lesser if no specific emissions from the EUT are recorded (ie: margin > 20 dB from the applicable limit) and considered that's already beyond the background noise floor.
 3. We have done x, y, z planes in EUT and horizontal and vertical polarization in detecting antenna.
 4. All of RB size has been tested for emissions and ERP, with the 1RB configuration observed as the worst case
 5. We are performed 16QAM and QPSK modulations. The worst case data are reported in the table above.

8.3.10 RADIATED SPURIOUS EMISSIONS (10 MHz Band 5 LTE)

- ▣ OPERATING FREQUENCY: 836.50 MHz
- ▣ MEASURED OUTPUT POWER: 20.47 dBm = 0.111 W
- ▣ MODULATION SIGNAL: 10 MHz QPSK
- ▣ DISTANCE: 3 meters
- ▣ LIMIT: $43 + 10 \log_{10}(W) =$ 33.47 dBc

Ch	Freq (MHz)	Measured Level (dBm)	Ant. Gain (dBd)	Substitute Level (dBm)	C.L	Pol	ERP (dBm)	dBc
20450 (829.0)	1,658.00	-55.36	9.20	-66.19	1.17	V	-58.16	78.63
	2,487.00	-56.03	10.94	-63.36	1.20	V	-53.62	74.09
	3,316.00	-56.04	11.97	-63.65	1.43	V	-53.10	73.57
20525 (836.5)	1,673.00	-56.20	9.23	-66.88	1.17	H	-58.82	79.29
	2,509.50	-51.83	10.96	-59.46	1.24	H	-49.74	70.21
	3,346.00	-55.22	10.03	-60.98	1.46	V	-52.40	72.87
20600 (844.0)	1,688.00	-56.11	9.30	-66.81	1.16	V	-58.67	79.14
	2,532.00	-50.47	10.98	-58.19	1.20	H	-48.41	68.88
	3,376.00	-55.04	12.10	-62.85	1.47	V	-52.22	72.69

- NOTES:**
1. Radiated Spurious Emission Measurements at 3 meters by Substitution Method according to ANSI/TIA/EIA-603-D-2010 June 24, 2010:
 2. We are performed all frequency to 10th harmonics from 9 kHz. Measurements above show only up to 3 maximum emissions noted, or would be lesser if no specific emissions from the EUT are recorded (ie: margin > 20 dB from the applicable limit) and considered that's already beyond the background noise floor.
 3. We have done x, y, z planes in EUT and horizontal and vertical polarization in detecting antenna.
 4. All of RB size has been tested for emissions and ERP, with the 1RB configuration observed as the worst case
 5. We are performed 16QAM and QPSK modulations. The worst case data are reported in the table above.

8.4 PEAK-TO-AVERAGE RATIO

Band	Band Width	Frequency (MHz)	Modulation	Resource Block Size	Resource Block Offset	Data (dB)
2	1.4 MHz	1880.0	QPSK	6	0	5.39
			16-QAM	6	0	6.18
	3 MHz		QPSK	15	0	5.58
			16-QAM	15	0	6.34
	5 MHz		QPSK	25	0	5.52
			16-QAM	25	0	6.23
	10 MHz		QPSK	50	0	5.58
			16-QAM	50	0	6.24
	15 MHz		QPSK	75	0	5.48
			16-QAM	75	0	6.18
	20 MHz		QPSK	100	0	5.46
			16-QAM	100	0	6.24

- Plots of the EUT's Peak- to- Average Ratio are shown Page 61 ~ 66.

8.5 OCCUPIED BANDWIDTH

Band	Band Width	Frequency (MHz)	Modulation	Resource Block Size	Resource Block Offset	Data (MHz)
2	1.4 MHz	1880.0	QPSK	6	0	1.0925
			16-QAM	6	0	1.0935
	3 MHz		QPSK	15	0	2.6938
			16-QAM	15	0	2.6935
	5 MHz		QPSK	25	0	4.4983
			16-QAM	25	0	4.4955
	10 MHz		QPSK	50	0	8.9998
			16-QAM	50	0	8.9681
	15 MHz		QPSK	75	0	13.483
			16-QAM	75	0	13.450
	20 MHz		QPSK	100	0	17.943
			16-QAM	100	0	17.976

Band	Band Width	Frequency (MHz)	Modulation	Resource Block Size	Resource Block Offset	Data (MHz)
5	1.4 MHz	836.5	QPSK	6	0	1.0972
			16-QAM	6	0	1.0978
	3 MHz		QPSK	15	0	2.7068
			16-QAM	15	0	2.6963
	5 MHz		QPSK	25	0	4.5052
			16-QAM	25	0	4.5035
	10 MHz		QPSK	50	0	8.9934
			16-QAM	50	0	8.9759

- Plots of the EUT's Occupied Bandwidth are shown Page 51 ~ 60.

8.6 CONDUCTED SPURIOUS EMISSIONS

■FACTORS FOR FREQUENCY

Frequency Range (GHz)	Factor [dB]
0.03 – 1	27.145
1 – 5	26.960
5 – 10	27.542
10 – 15	28.439
15 – 20	29.144
Above 20	30.148

NOTES:

Factor(dB) = Cable Loss + Attenuator +Power Splitter

Band	Band Width (MHz)	Frequency (MHz)	Frequency of Maximum Harmonic (GHz)	Factor (dB)	Measurement Maximum Data (dBm)	Result (dBm)	Limit (dBm)
2	1.4	1850.7	18.9265	29.144	-62.22	-33.076	-13.00
		1880.0	18.8700	29.144	-62.28	-33.136	
		1909.3	16.6380	29.144	-62.46	-33.316	
	3	1851.5	18.9320	29.144	-62.67	-33.526	
		1880.0	18.9330	29.144	-62.24	-33.096	
		1908.5	18.9560	29.144	-61.87	-32.726	
	5	1852.5	16.7060	29.144	-62.24	-33.096	
		1880.0	18.9275	29.144	-62.13	-32.986	
		1907.5	18.8740	29.144	-62.33	-33.186	
	10	1855.0	18.6250	29.144	-62.41	-33.266	
		1880.0	18.8650	29.144	-62.31	-33.166	
		1905.0	18.9155	29.144	-62.53	-33.386	
	15	1857.5	18.9265	29.144	-62.36	-33.216	
		1880.0	18.9305	29.144	-62.49	-33.346	
		1902.5	18.9805	29.144	-62.50	-33.356	
	20	1860.0	18.8980	29.144	-62.19	-33.046	
		1880.0	18.8780	29.144	-61.96	-32.816	
		1900.0	18.9175	29.144	-62.42	-33.276	

Band	Band Width (MHz)	Frequency (MHz)	Frequency of Maximum Harmonic (GHz)	Factor (dB)	Measurement Maximum Data (dBm)	Result (dBm)	Limit (dBm)
5	1.4	824.7	3.67276	26.960	-66.81	-39.85	-13.00
		836.5	3.67326	26.960	-66.73	-39.77	
		848.3	3.71526	26.960	-66.72	-39.76	
	3	825.5	3.72892	26.960	-66.65	-39.69	
		836.5	3.67102	26.960	-66.85	-39.89	
		847.5	3.70681	26.960	-67.01	-40.05	
	5	826.5	3.70830	26.960	-66.98	-40.02	
		836.5	3.68270	26.960	-66.98	-40.02	
		846.5	3.70532	26.960	-66.78	-39.82	
	10	829.0	3.68370	26.960	-66.81	-39.85	
		836.5	3.71376	26.960	-66.90	-39.94	
		844.0	3.68519	26.960	-67.01	-40.05	

NOTES:

1. Conducted Spurious Emissions was Tested QPSK Modulation, Resource Block Size 1 and Resource Block Offset 0
2. Result (dBm) = Measurement Maximum Data (dBm) + Factor (dB)

- Plots of the EUT's Conducted Spurious Emissions are shown Page 97 ~ 126.

8.6.1 BAND EDGE

- Plots of the EUT's Band Edge are shown Page 67 ~ 96.

8.7 FREQUENCY STABILITY / VARIATION OF AMBIENT TEMPERATURE

8.7.1 FREQUENCY STABILITY (1.4 MHz Band 2 LTE)

- ▣ OPERATING FREQUENCY: 1880,000,000 Hz
- ▣ CHANNEL: 18900 (1.4 MHz)
- ▣ REFERENCE VOLTAGE: 3.85 VDC
- ▣ DEVIATION LIMIT: Emission must remain in band

Voltage (%)	Power (VDC)	Temp. (°C)	Frequency (Hz)	Frequency Error (Hz)	Deviation (%)	ppm
100%	3.85	+20(Ref)	1879 999 960	0.0	0.000 000	0.000
100%		-30	1879 999 997	36.8	0.000 002	0.020
100%		-20	1879 999 924	-36.3	-0.000 002	-0.019
100%		-10	1879 999 922	-38.0	-0.000 002	-0.020
100%		0	1879 999 999	38.7	0.000 002	0.021
100%		+10	1879 999 925	-35.1	-0.000 002	-0.019
100%		+30	1880 000 001	40.8	0.000 002	0.022
100%		+40	1879 999 924	-36.5	-0.000 002	-0.019
100%		+50	1880 000 000	39.8	0.000 002	0.021
Batt. Endpoint		3.70	+20	1879 999 922	-37.8	-0.000 002

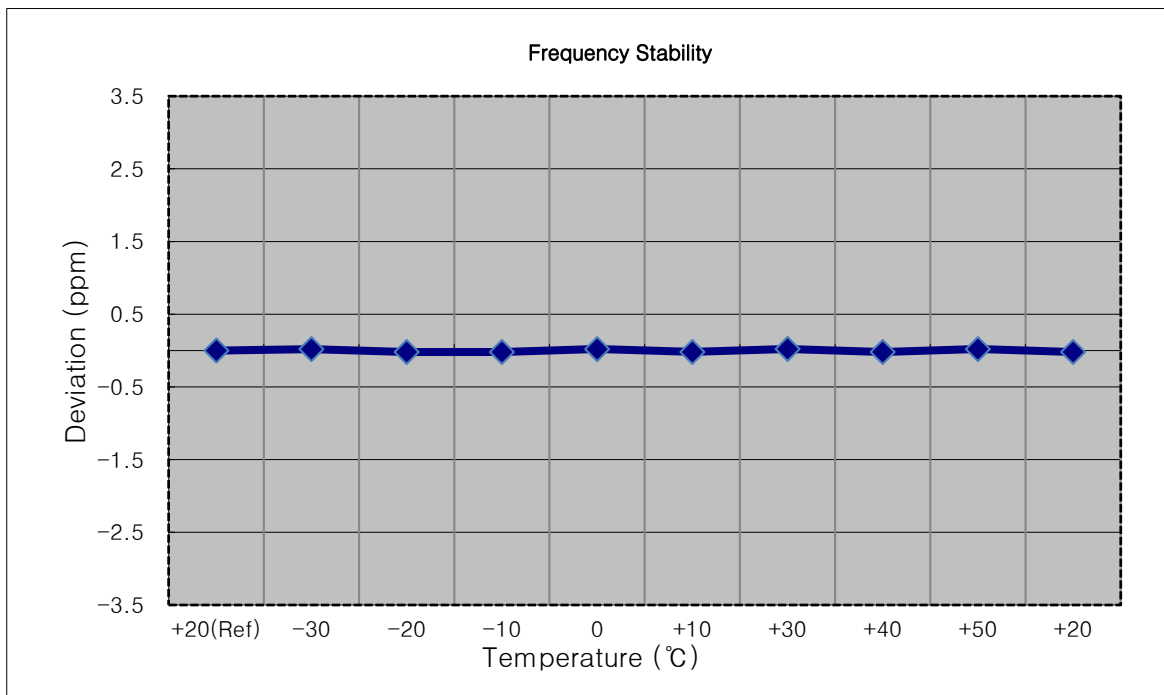

8.7.2 FREQUENCY STABILITY (3 MHz Band 2 LTE)

- ▣ OPERATING FREQUENCY: 1880,000,000 Hz
- ▣ CHANNEL: 18900 (3 MHz)
- ▣ REFERENCE VOLTAGE: 3.85 VDC
- ▣ DEVIATION LIMIT: Emission must remain in band

Voltage (%)	Power (VDC)	Temp. (°C)	Frequency (Hz)	Frequency Error (Hz)	Deviation (%)	ppm
100%	3.85	+20(Ref)	1880 000 037	0.0	0.000 000	0.000
100%		-30	1880 000 076	39.0	0.000 002	0.021
100%		-20	1880 000 075	37.7	0.000 002	0.020
100%		-10	1880 000 077	39.9	0.000 002	0.021
100%		0	1880 000 076	39.3	0.000 002	0.021
100%		+10	1879 999 999	-37.7	-0.000 002	-0.020
100%		+30	1880 000 000	-36.8	-0.000 002	-0.020
100%		+40	1880 000 077	40.2	0.000 002	0.021
100%		+50	1880 000 002	-34.8	-0.000 002	-0.019
Batt. Endpoint		3.70	+20	1880 000 001	-35.7	-0.000 002

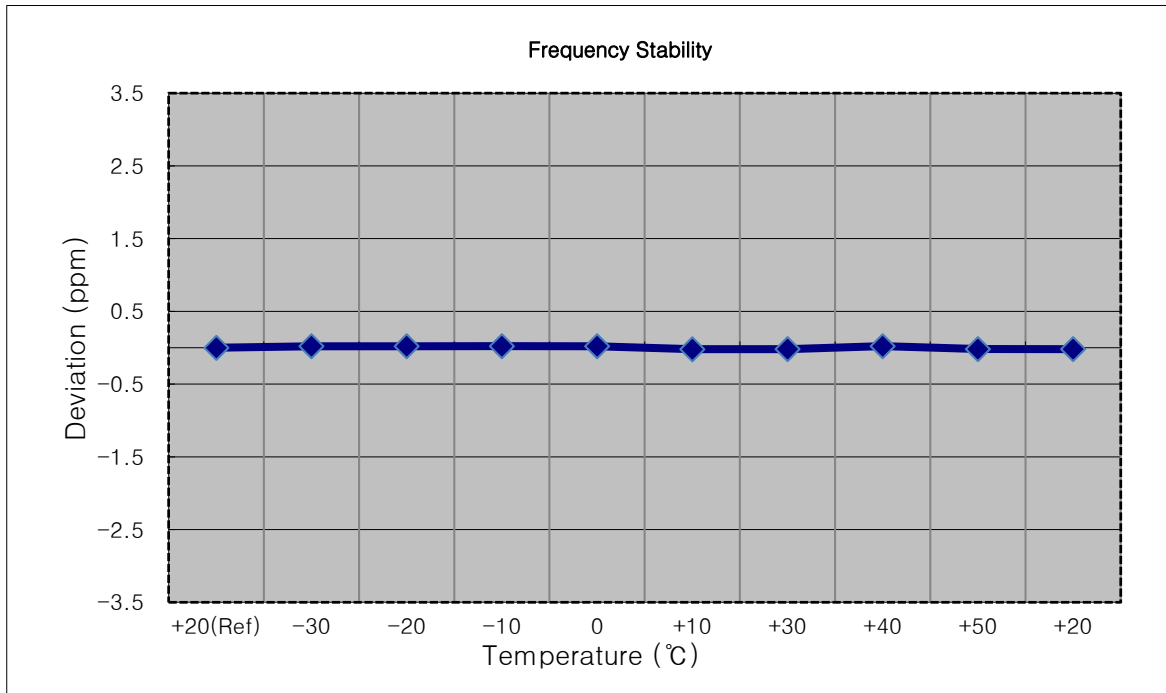

8.7.3 FREQUENCY STABILITY (5 MHz Band 2 LTE)

- ▣ OPERATING FREQUENCY: 1880,000,000 Hz
- ▣ CHANNEL: 18900 (5 MHz)
- ▣ REFERENCE VOLTAGE: 3.85 VDC
- ▣ DEVIATION LIMIT: Emission must remain in band

Voltage (%)	Power (VDC)	Temp. (°C)	Frequency (Hz)	Frequency Error (Hz)	Deviation (%)	ppm
100%	3.85	+20(Ref)	1879 999 962	0.0	0.000 000	0.000
100%		-30	1879 999 922	-39.4	-0.000 002	-0.021
100%		-20	1880 000 001	39.3	0.000 002	0.021
100%		-10	1879 999 920	-41.7	-0.000 002	-0.022
100%		0	1879 999 924	-37.6	-0.000 002	-0.020
100%		+10	1879 999 924	-38.0	-0.000 002	-0.020
100%		+30	1879 999 927	-34.6	-0.000 002	-0.018
100%		+40	1879 999 924	-37.2	-0.000 002	-0.020
100%		+50	1880 000 004	42.4	0.000 002	0.023
Batt. Endpoint		3.70	+20	1879 999 921	-40.7	-0.000 002

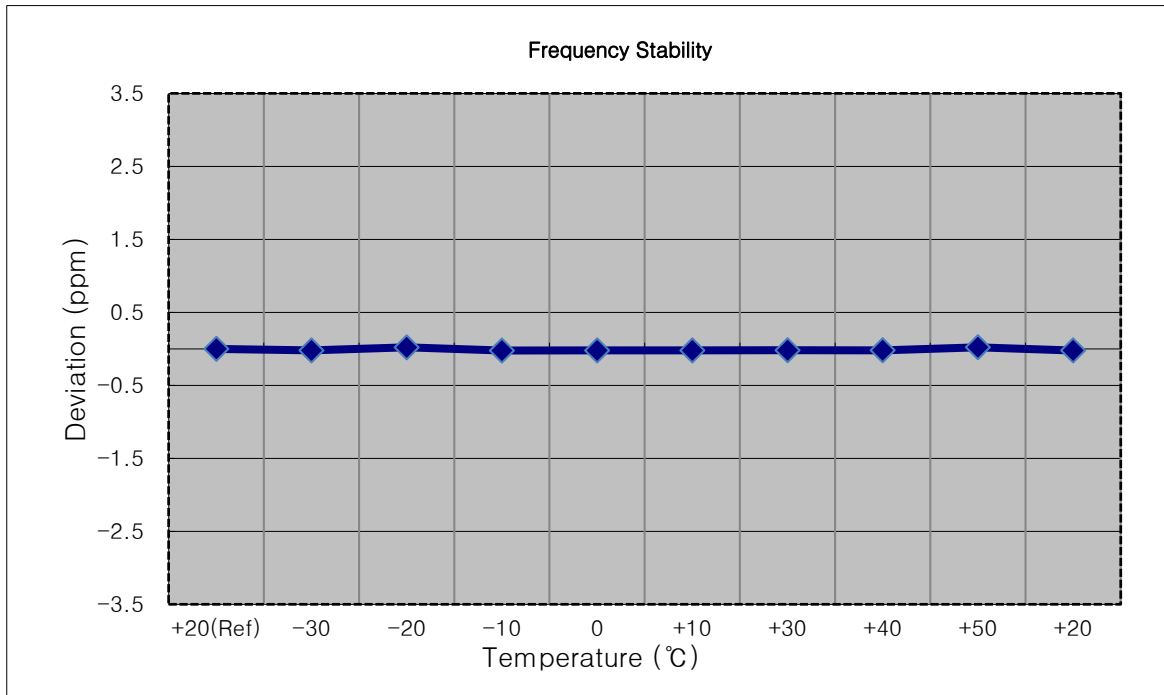

8.7.4 FREQUENCY STABILITY (10 MHz Band 2 LTE)

- ▣ OPERATING FREQUENCY: 1880,000,000 Hz
- ▣ CHANNEL: 18900 (10 MHz)
- ▣ REFERENCE VOLTAGE: 3.85 VDC
- ▣ DEVIATION LIMIT: Emission must remain in band

Voltage (%)	Power (VDC)	Temp. (°C)	Frequency (Hz)	Frequency Error (Hz)	Deviation (%)	ppm
100%	3.85	+20(Ref)	1880 000 036	0.0	0.000 000	0.000
100%		-30	1880 000 074	38.7	0.000 002	0.021
100%		-20	1880 000 080	44.7	0.000 002	0.024
100%		-10	1880 000 074	38.0	0.000 002	0.020
100%		0	1880 000 079	42.8	0.000 002	0.023
100%		+10	1880 000 078	42.1	0.000 002	0.022
100%		+30	1880 000 073	37.1	0.000 002	0.020
100%		+40	1880 000 080	44.4	0.000 002	0.024
100%		+50	1879 999 994	-41.5	-0.000 002	-0.022
Batt. Endpoint		3.70	+20	1880 000 077	41.6	0.000 002

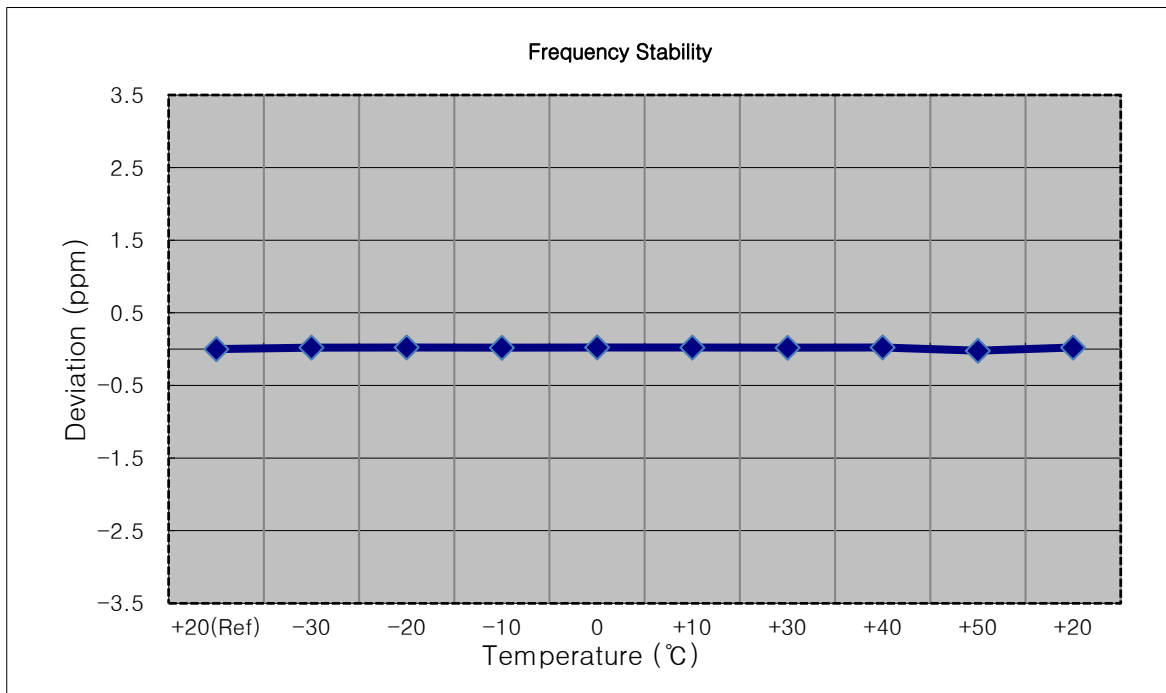

8.7.5 FREQUENCY STABILITY (15 MHz Band 2 LTE)

- ▣ OPERATING FREQUENCY: 1880,000,000 Hz
- ▣ CHANNEL: 18900 (15 MHz)
- ▣ REFERENCE VOLTAGE: 3.85 VDC
- ▣ DEVIATION LIMIT: Emission must remain in band

Voltage (%)	Power (VDC)	Temp. (°C)	Frequency (Hz)	Frequency Error (Hz)	Deviation (%)	ppm
100%	3.85	+20(Ref)	1880 000 039	0.0	0.000 000	0.000
100%		-30	1880 000 002	-37.1	-0.000 002	-0.020
100%		-20	1880 000 081	42.4	0.000 002	0.023
100%		-10	1880 000 002	-36.9	-0.000 002	-0.020
100%		0	1880 000 077	38.7	0.000 002	0.021
100%		+10	1880 000 074	35.8	0.000 002	0.019
100%		+30	1879 999 996	-42.2	-0.000 002	-0.022
100%		+40	1880 000 079	40.0	0.000 002	0.021
100%		+50	1879 999 998	-40.5	-0.000 002	-0.022
Batt. Endpoint		3.70	+20	1880 000 083	44.3	0.000 002

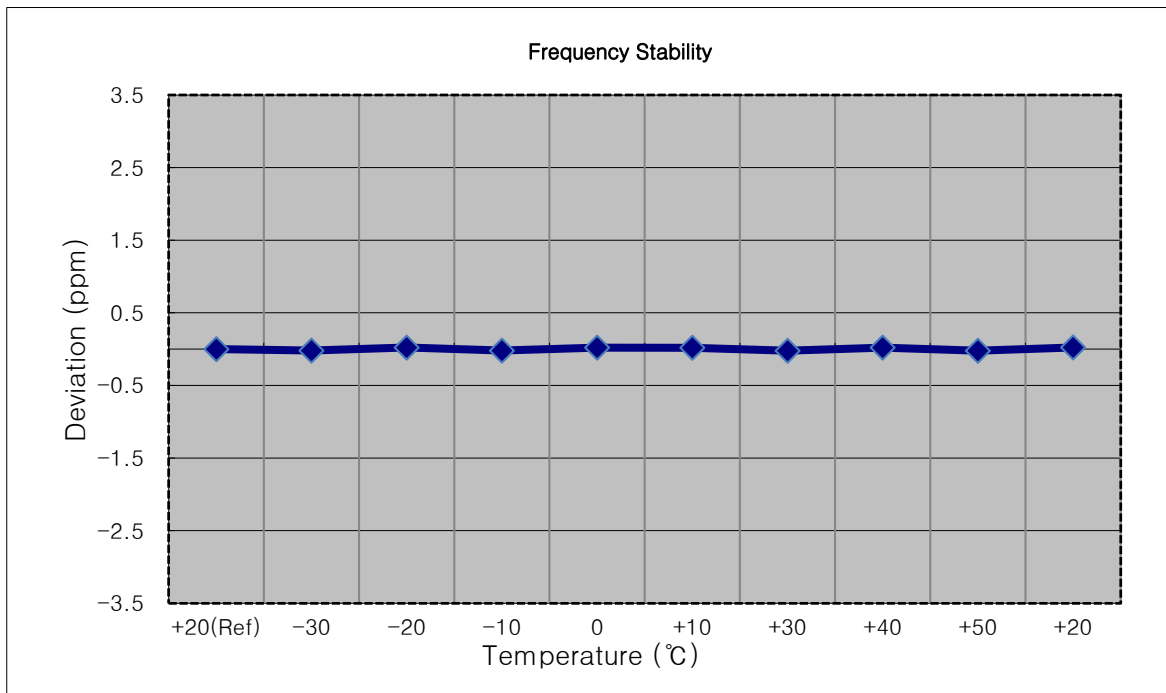

8.7.6 FREQUENCY STABILITY (20 MHz Band 2 LTE)

- ▣ OPERATING FREQUENCY: 1880,000,000 Hz
- ▣ CHANNEL: 18900 (20 MHz)
- ▣ REFERENCE VOLTAGE: 3.85 VDC
- ▣ DEVIATION LIMIT: Emission must remain in band

Voltage (%)	Power (VDC)	Temp. (°C)	Frequency (Hz)	Frequency Error (Hz)	Deviation (%)	ppm
100%	3.85	+20(Ref)	1879 999 959	0.0	0.000 000	0.000
100%		-30	1879 999 998	39.5	0.000 002	0.021
100%		-20	1879 999 919	-39.5	-0.000 002	-0.021
100%		-10	1879 999 916	-42.5	-0.000 002	-0.023
100%		0	1879 999 996	36.9	0.000 002	0.020
100%		+10	1879 999 918	-41.0	-0.000 002	-0.022
100%		+30	1879 999 921	-38.2	-0.000 002	-0.020
100%		+40	1879 999 919	-39.9	-0.000 002	-0.021
100%		+50	1879 999 920	-38.4	-0.000 002	-0.020
Batt. Endpoint		3.70	+20	1879 999 920	-38.7	-0.000 002

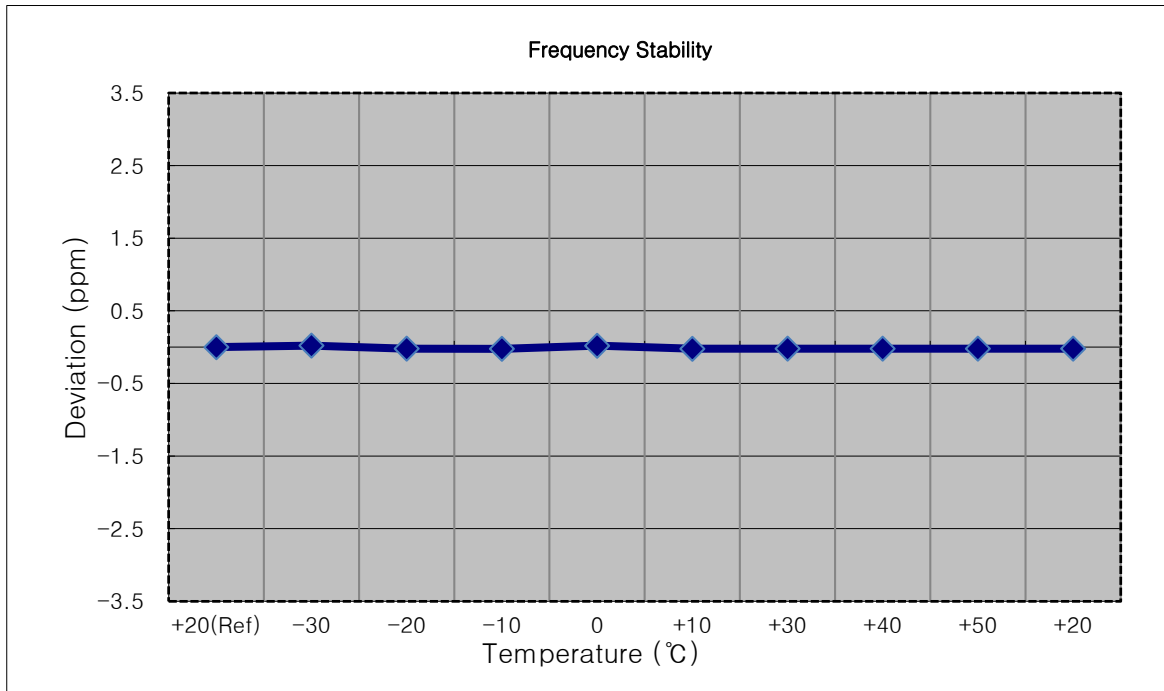

8.7.7 FREQUENCY STABILITY (1.4 MHz Band 5 LTE)

- ▣ OPERATING FREQUENCY: 836,500,000 Hz
- ▣ CHANNEL: 20525 (1.4 MHz)
- ▣ REFERENCE VOLTAGE: 3.85 VDC
- ▣ DEVIATION LIMIT: ± 0.000 25 % or 2.5 ppm

Voltage (%)	Power (VDC)	Temp. (°C)	Frequency (Hz)	Frequency Error (Hz)	Deviation (%)	ppm
100%	3.85	+20(Ref)	836 500 040	0.0	0.000 000	0.000
100%		-30	836 500 078	38.0	0.000 005	0.045
100%		-20	836 500 085	44.7	0.000 005	0.053
100%		-10	836 500 078	38.1	0.000 005	0.046
100%		0	836 500 087	47.2	0.000 006	0.056
100%		+10	836 500 086	46.3	0.000 006	0.055
100%		+30	836 500 081	40.6	0.000 005	0.049
100%		+40	836 500 086	45.4	0.000 005	0.054
100%		+50	836 500 083	43.3	0.000 005	0.052
Batt. Endpoint		3.70	+20	836 500 080	40.2	0.000 005

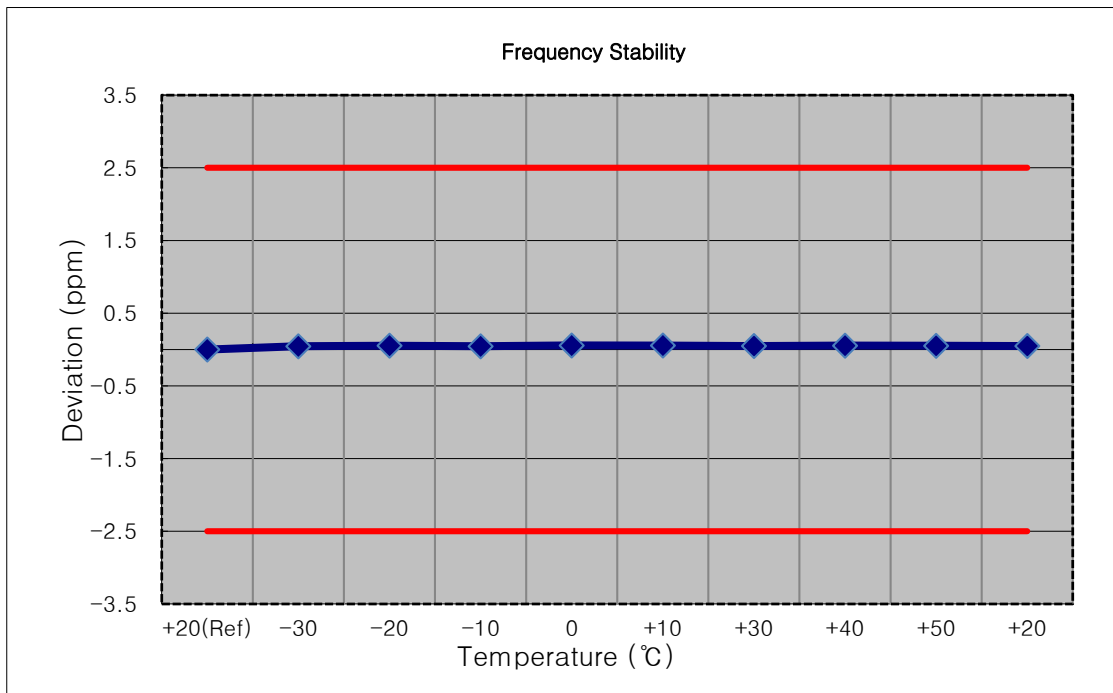

8.7.8 FREQUENCY STABILITY (3 MHz Band 5 LTE)

- ▣ OPERATING FREQUENCY: 836,500,000 Hz
- ▣ CHANNEL: 20525 (3 MHz)
- ▣ REFERENCE VOLTAGE: 3.85 VDC
- ▣ DEVIATION LIMIT: ± 0.000 25 % or 2.5 ppm

Voltage (%)	Power (VDC)	Temp. (°C)	Frequency (Hz)	Frequency Error (Hz)	Deviation (%)	ppm
100%	3.85	+20(Ref)	836 500 041	0.0	0.000 000	0.000
100%		-30	836 500 084	43.5	0.000 005	0.052
100%		-20	836 500 085	44.8	0.000 005	0.054
100%		-10	836 500 084	43.0	0.000 005	0.051
100%		0	836 500 078	37.9	0.000 005	0.045
100%		+10	836 500 081	40.4	0.000 005	0.048
100%		+30	836 500 085	44.8	0.000 005	0.054
100%		+40	836 500 087	46.0	0.000 005	0.055
100%		+50	836 500 086	45.4	0.000 005	0.054
Batt. Endpoint		3.70	+20	836 500 083	42.0	0.000 005

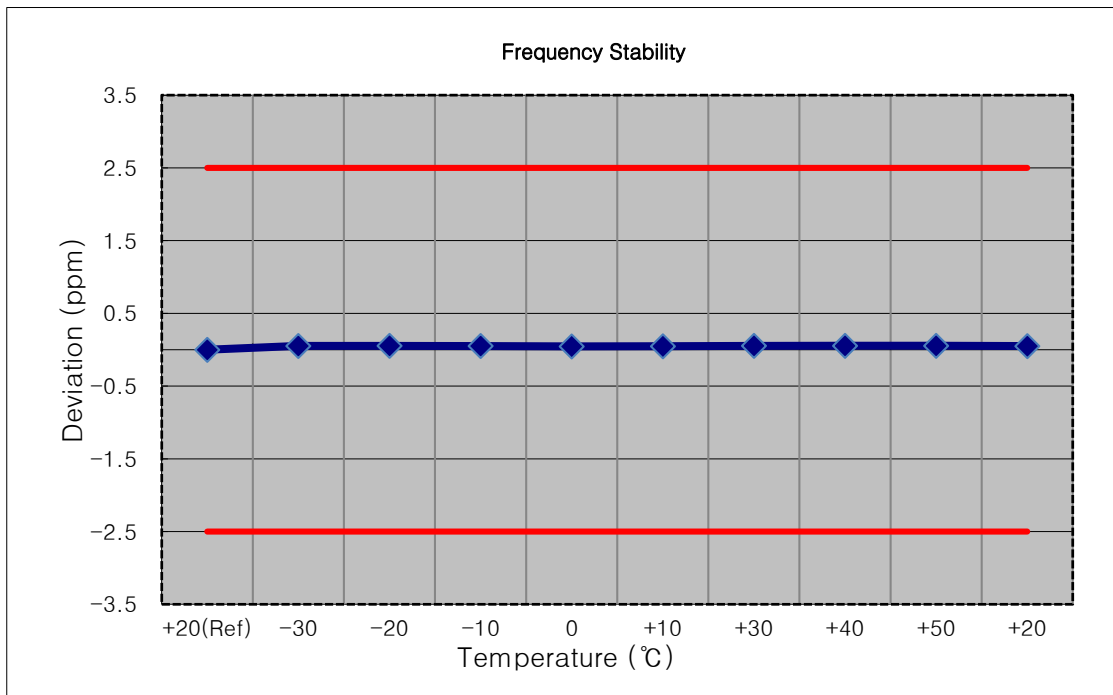

8.7.9 FREQUENCY STABILITY (5 MHz Band 5 LTE)

- ▣ OPERATING FREQUENCY: 836,500,000 Hz
- ▣ CHANNEL: 20525 (5 MHz)
- ▣ REFERENCE VOLTAGE: 3.85 VDC
- ▣ DEVIATION LIMIT: ± 0.000 25 % or 2.5 ppm

Voltage (%)	Power (VDC)	Temp. (°C)	Frequency (Hz)	Frequency Error (Hz)	Deviation (%)	ppm
100%	3.85	+20(Ref)	836 500 044	0.0	0.000 000	0.000
100%		-30	836 500 082	38.1	0.000 005	0.046
100%		-20	836 500 089	45.1	0.000 005	0.054
100%		-10	836 500 091	46.5	0.000 006	0.056
100%		0	836 500 084	40.1	0.000 005	0.048
100%		+10	836 500 087	43.0	0.000 005	0.051
100%		+30	836 500 086	41.6	0.000 005	0.050
100%		+40	836 500 090	46.0	0.000 005	0.055
100%		+50	836 500 086	42.0	0.000 005	0.050
Batt. Endpoint		3.70	+20	836 500 088	43.8	0.000 005

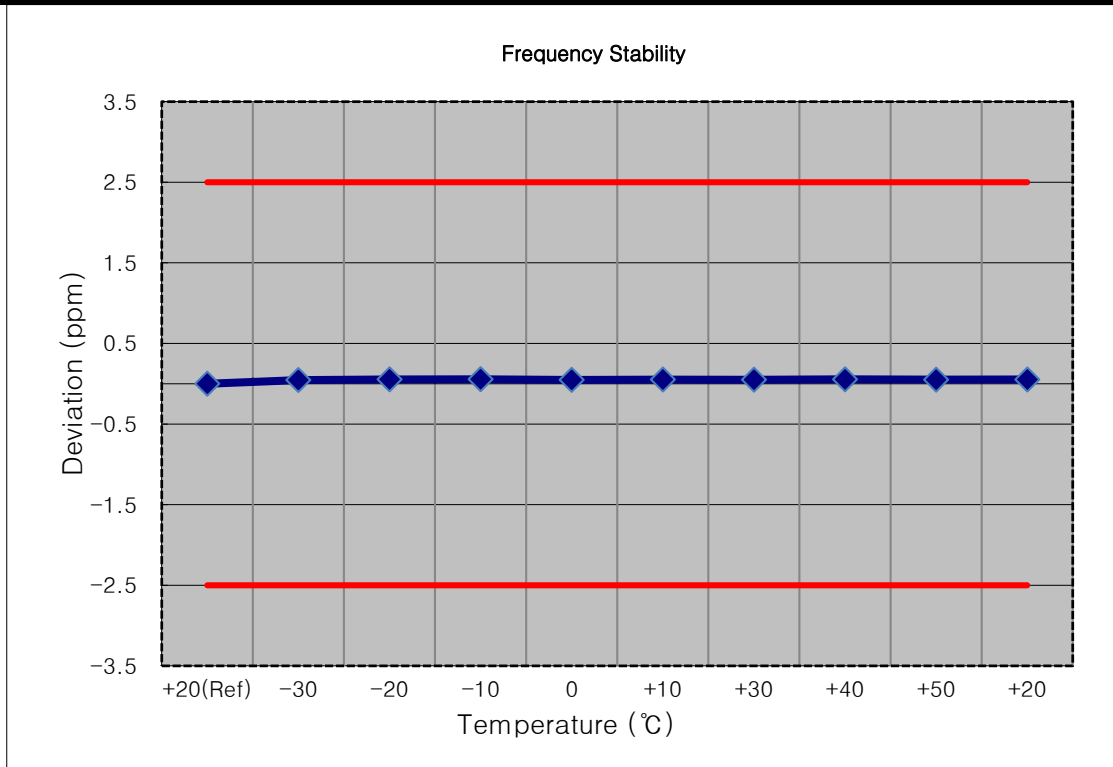

8.7.10 FREQUENCY STABILITY (10 MHz Band 5 LTE)

- ▣ OPERATING FREQUENCY: 836,500,000 Hz
- ▣ CHANNEL: 20525 (10 MHz)
- ▣ REFERENCE VOLTAGE: 3.85 VDC
- ▣ DEVIATION LIMIT: ± 0.000 25 % or 2.5 ppm

Voltage (%)	Power (VDC)	Temp. (°C)	Frequency (Hz)	Frequency Error (Hz)	Deviation (%)	ppm
100%	3.85	+20(Ref)	836 500 039	0.0	0.000 000	0.000
100%		-30	836 500 080	40.3	0.000 005	0.048
100%		-20	836 500 079	39.2	0.000 005	0.047
100%		-10	836 500 081	41.7	0.000 005	0.050
100%		0	836 500 081	41.8	0.000 005	0.050
100%		+10	836 500 079	39.5	0.000 005	0.047
100%		+30	836 500 079	39.6	0.000 005	0.047
100%		+40	836 500 082	42.6	0.000 005	0.051
100%		+50	836 500 081	42.0	0.000 005	0.050
Batt. Endpoint		3.70	+20	836 500 080	40.1	0.000 005

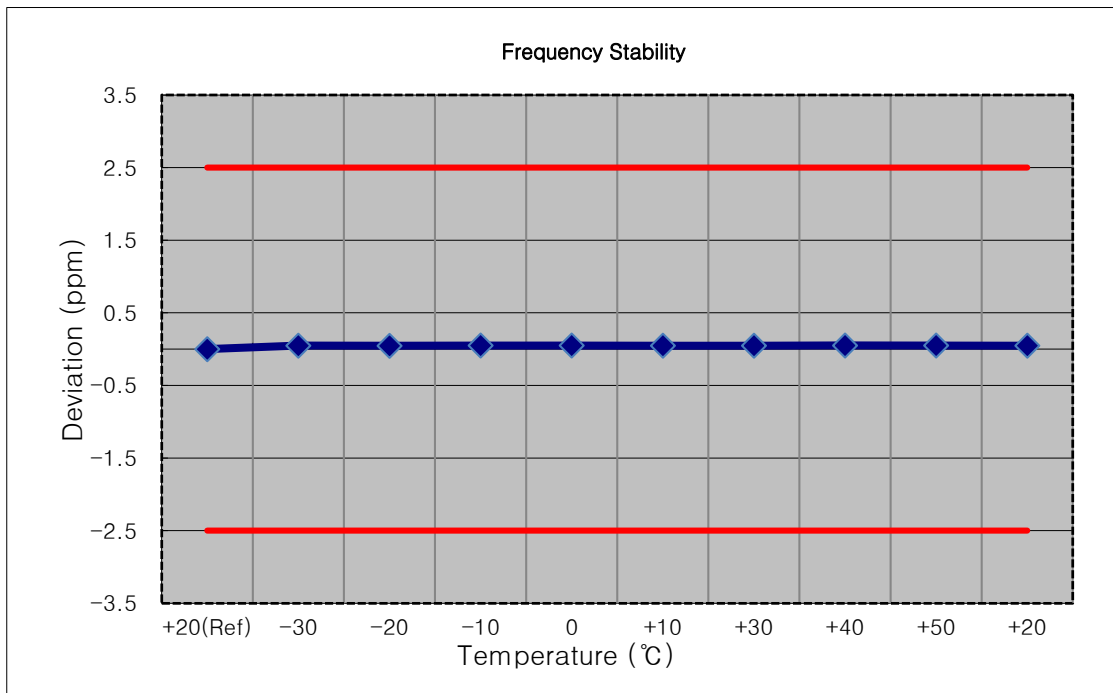

9. TEST PLOTS

BAND 2. Occupied Bandwidth Plot (1.4M BW Ch.18900 QPSK RB 6_0)

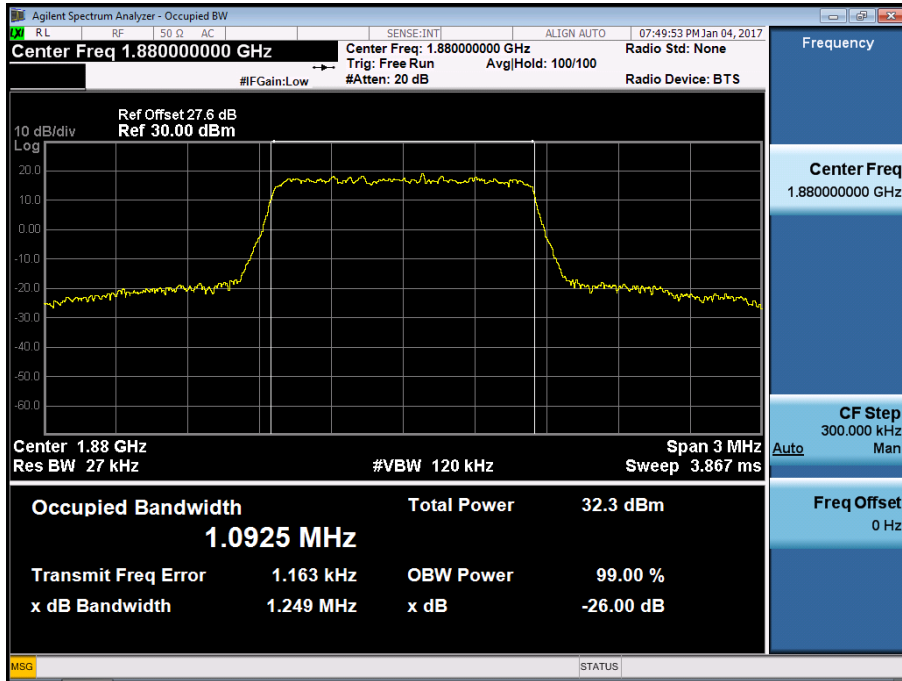

BAND 2. Occupied Bandwidth Plot (1.4M BW Ch.18900 16QAM RB 6_0)

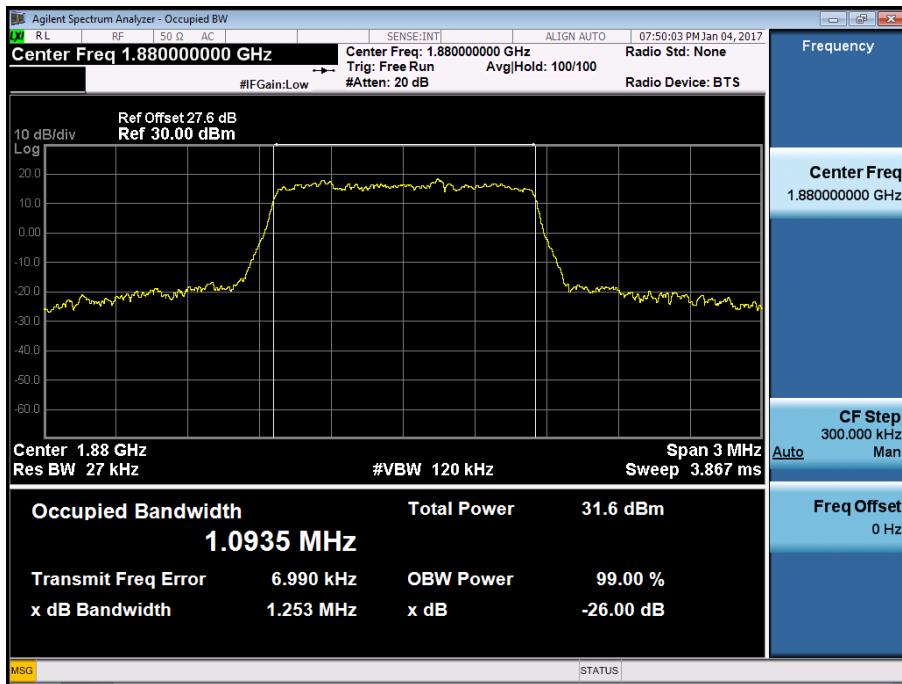

BAND 2. Occupied Bandwidth Plot (3M BW Ch.18900 QPSK RB 15_0)

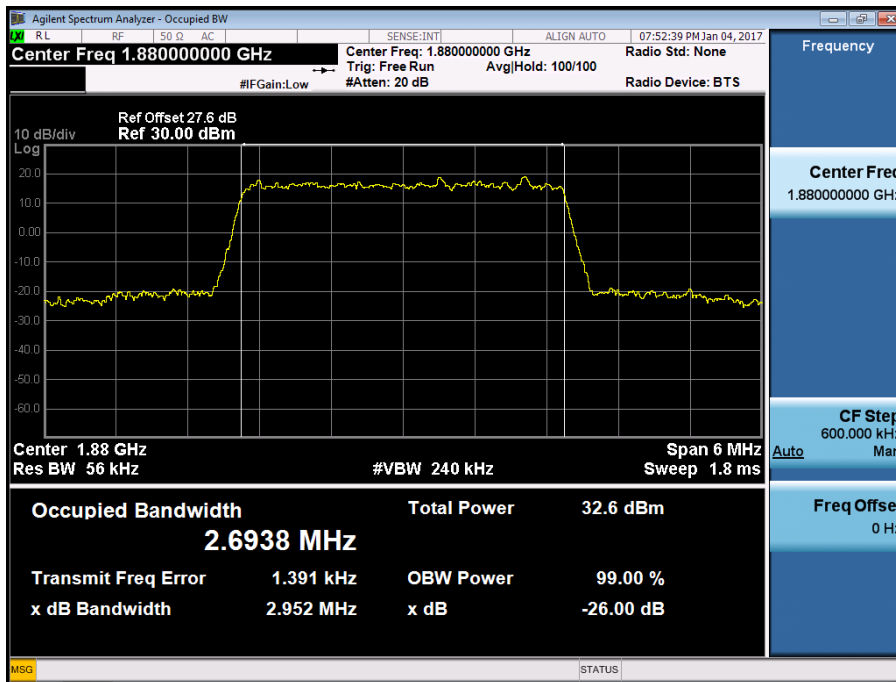

BAND 2. Occupied Bandwidth Plot (3M BW Ch.18900 16QAM RB 15_0)

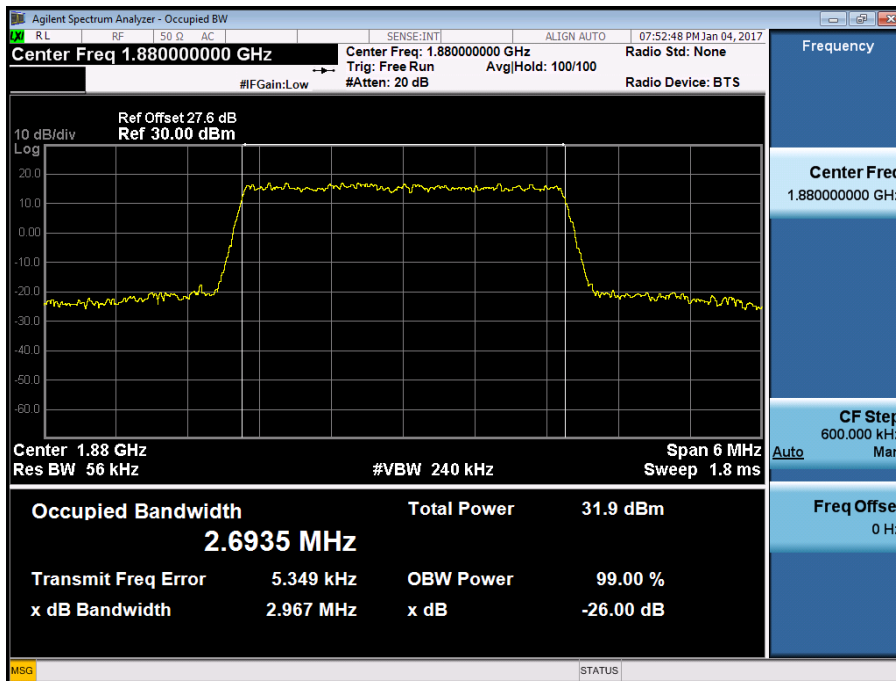

BAND 2. Occupied Bandwidth Plot (5M BW Ch.18900 QPSK RB 25_0)

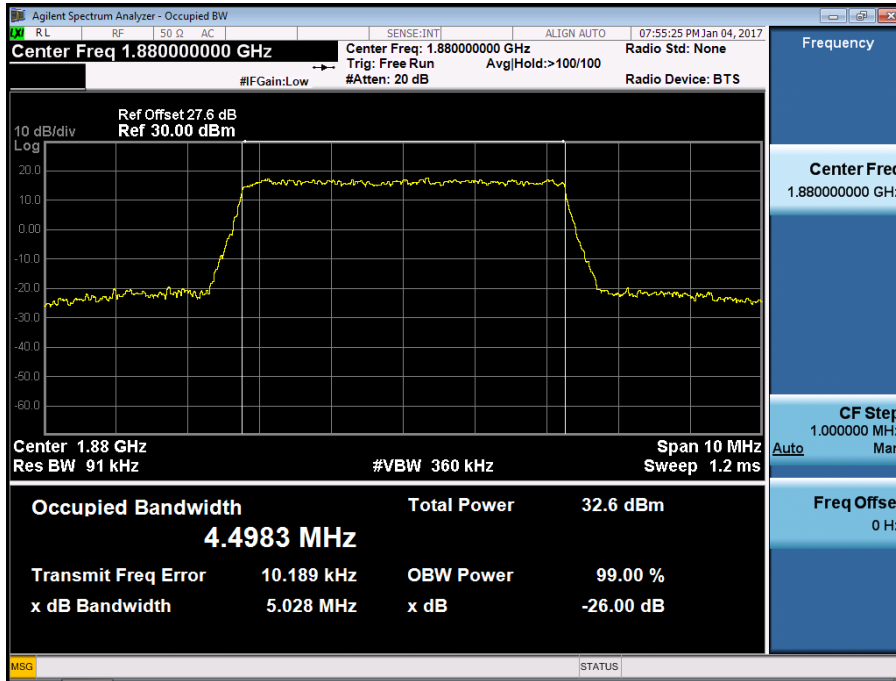

BAND 2. Occupied Bandwidth Plot (5M BW Ch.18900 16QAM RB 25_0)

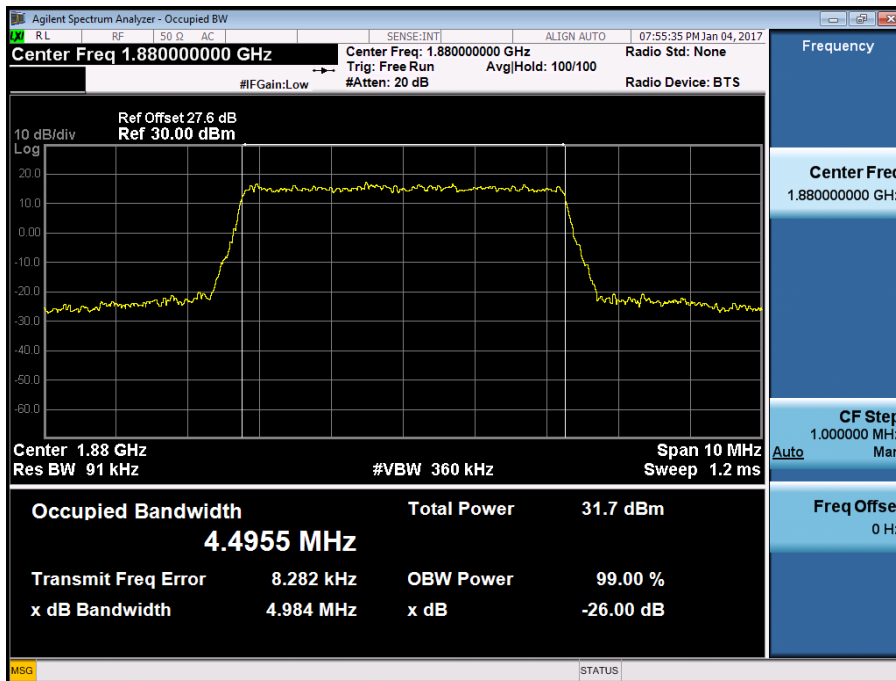

BAND 2. Occupied Bandwidth Plot (10M BW Ch.18900 QPSK RB 50_0)

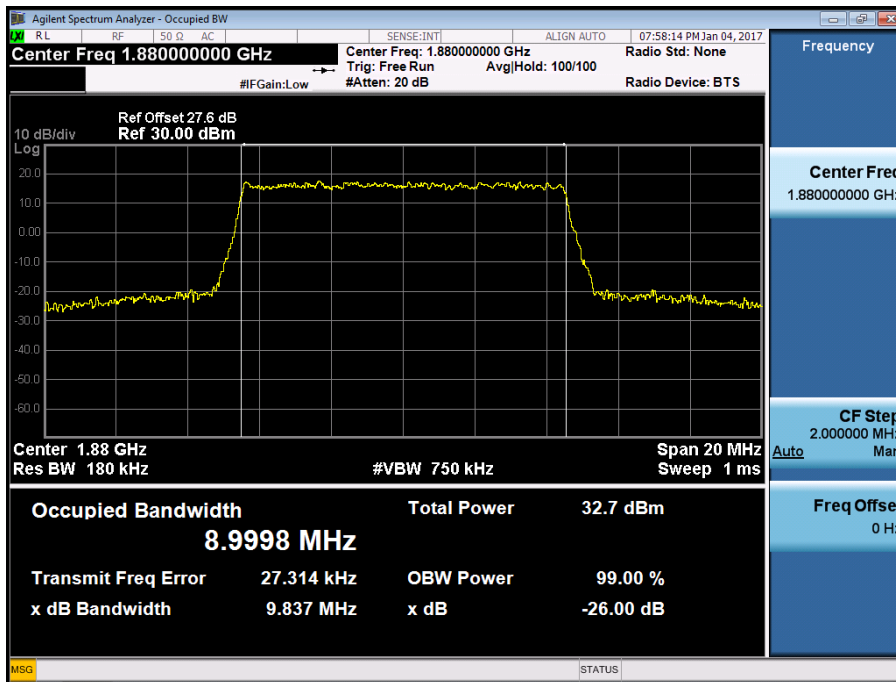

BAND 2. Occupied Bandwidth Plot (10M BW Ch.18900 16QAM RB 50_0)

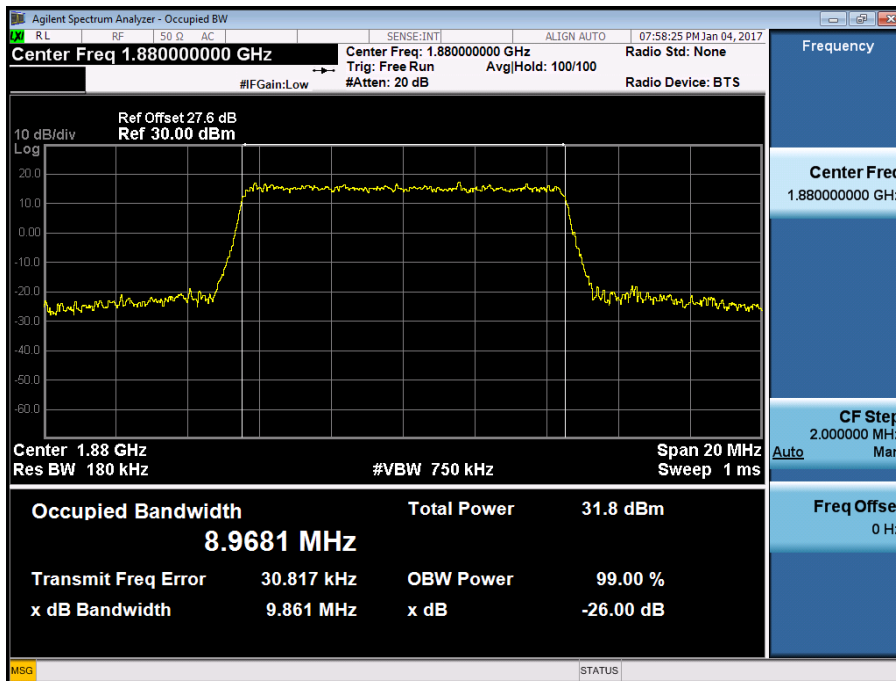

BAND 2. Occupied Bandwidth Plot (15M BW Ch.18900 QPSK RB 75_0)

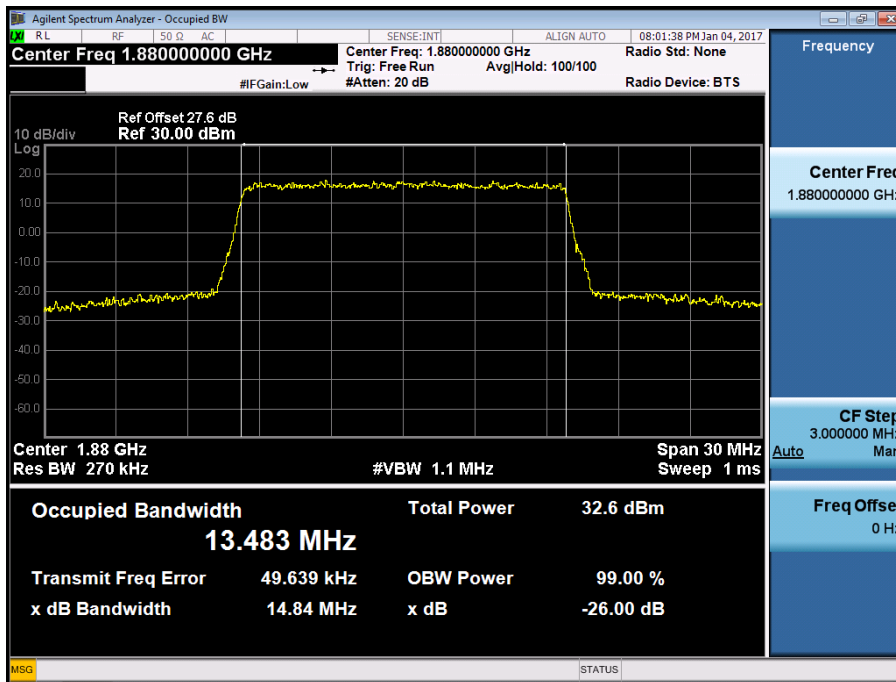

BAND 2. Occupied Bandwidth Plot (15M BW Ch.18900 16QAM RB 75_0)



BAND 2. Occupied Bandwidth Plot (20M BW Ch.18900 QPSK RB 100_0)

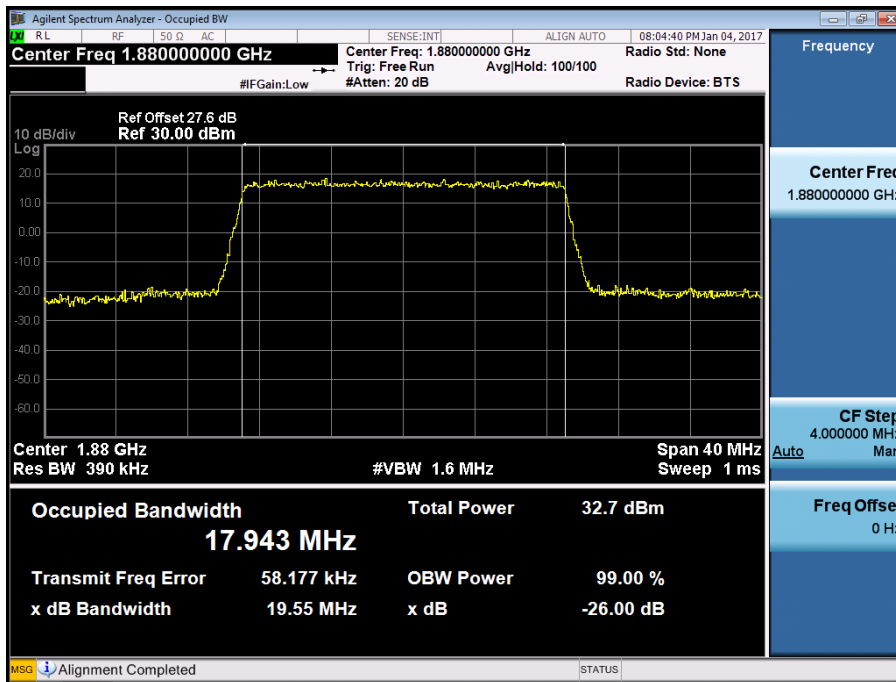

BAND 2. Occupied Bandwidth Plot (20M BW Ch.18900 16QAM RB 100_0)

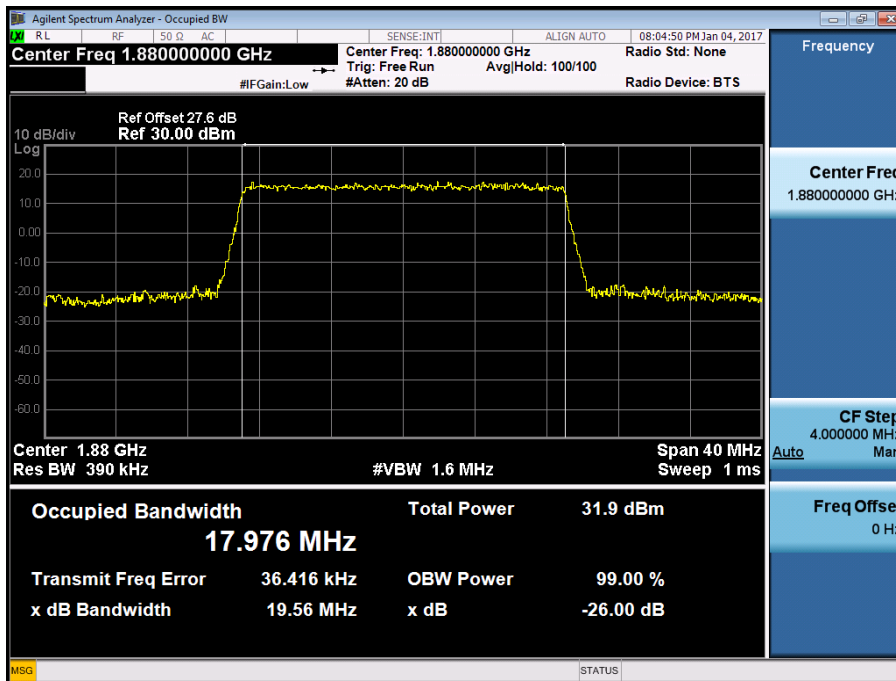

BAND 5. Occupied Bandwidth Plot (1.4M BW Ch.20525 QPSK_RB6_0)

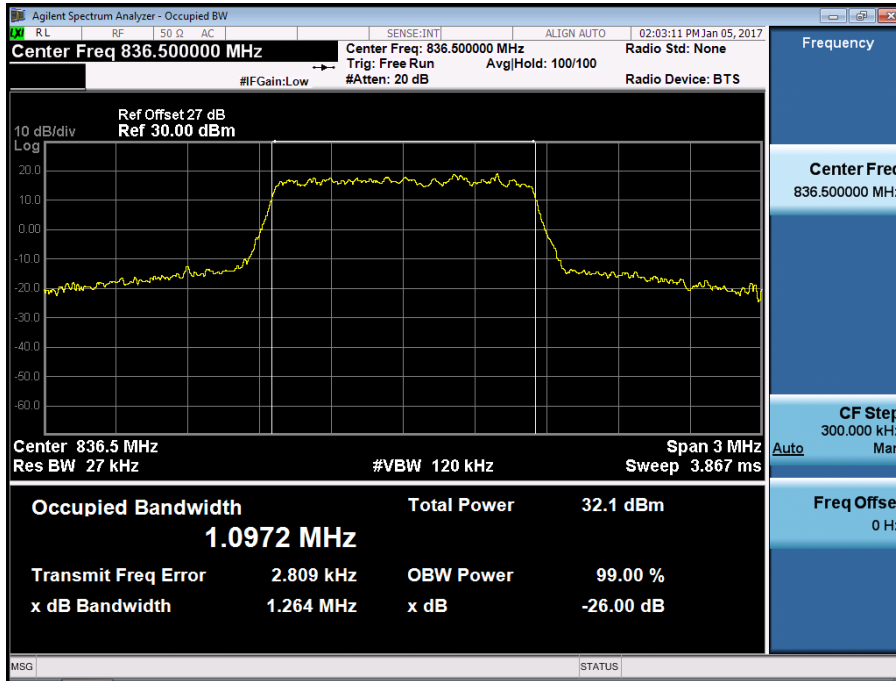

BAND 5. Occupied Bandwidth Plot (1.4M BW Ch.20525 16QAM_RB6_0)

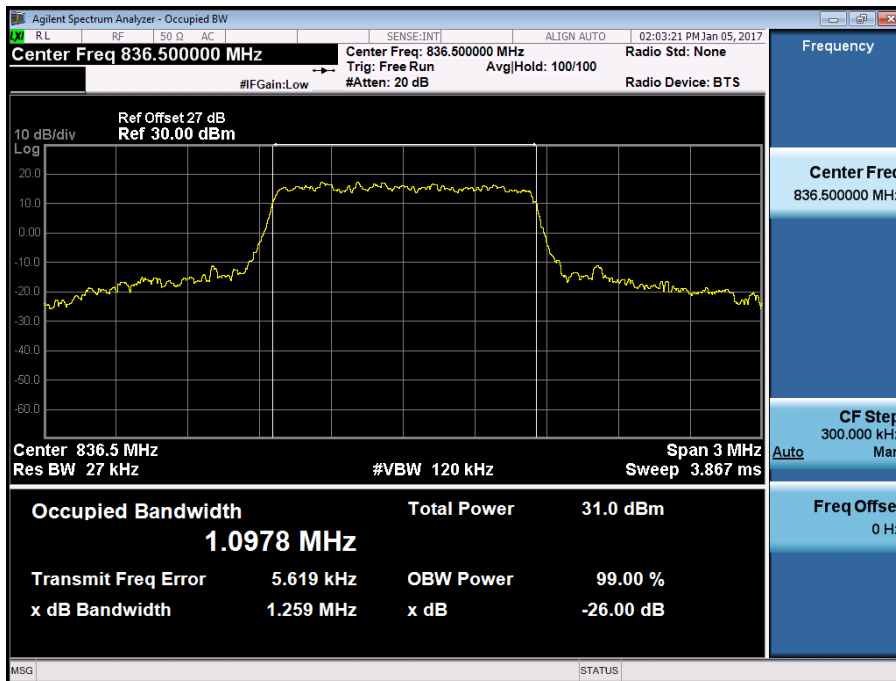

BAND 5. Occupied Bandwidth Plot (3M BW Ch.20525 QPSK_RB15_0)

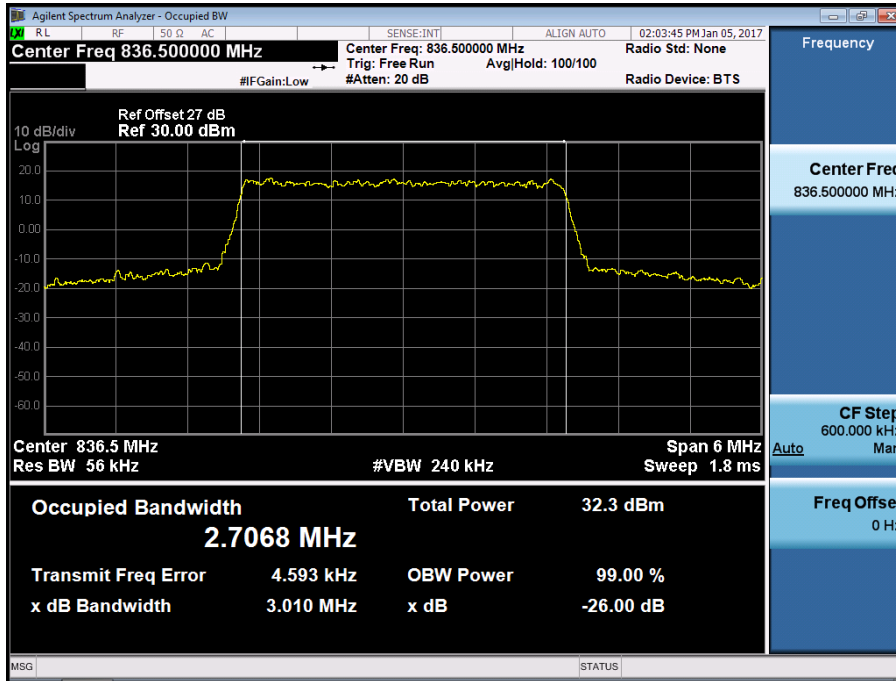

BAND 5. Occupied Bandwidth Plot (3M BW Ch.20525 16QAM_RB15_0)

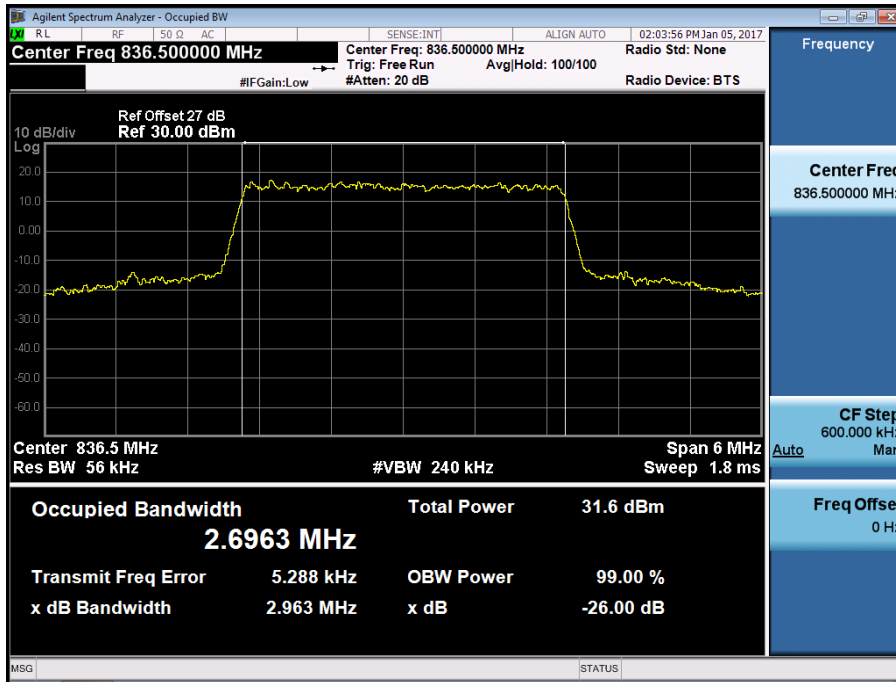

BAND 5. Occupied Bandwidth Plot (5M BW Ch.20525 QPSK_RB25_0)

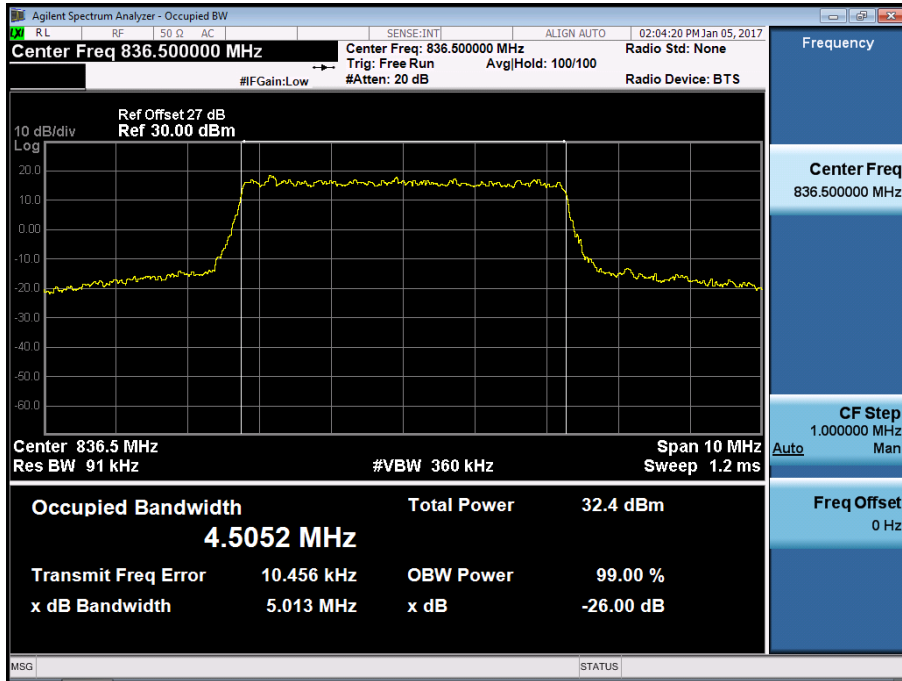

BAND 5. Occupied Bandwidth Plot (5M BW Ch.20525 16QAM_RB25_0)

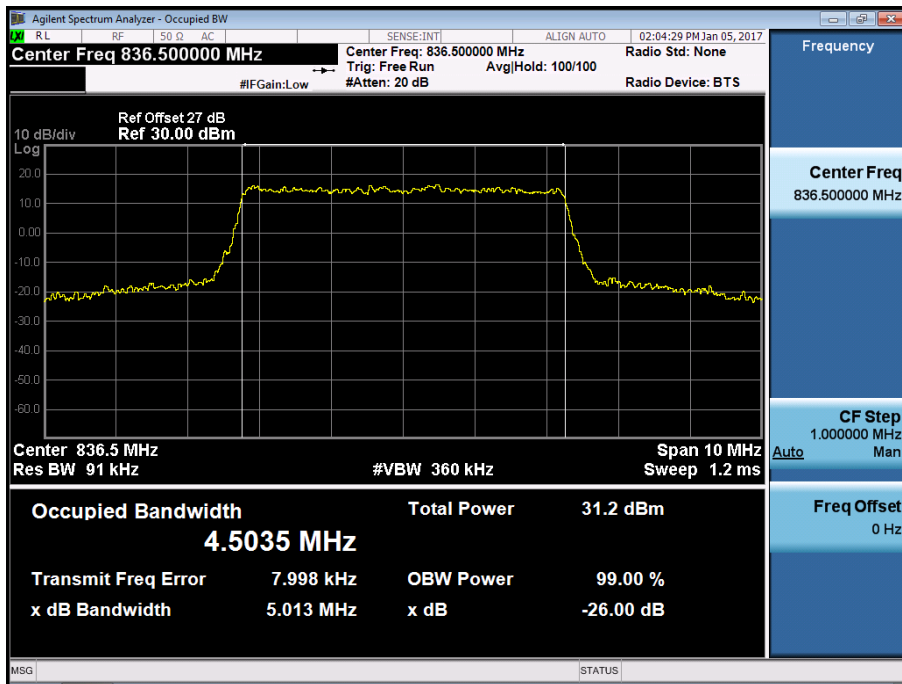

BAND 5. Occupied Bandwidth Plot (10M BW Ch.20525 QPSK_RB50_0)

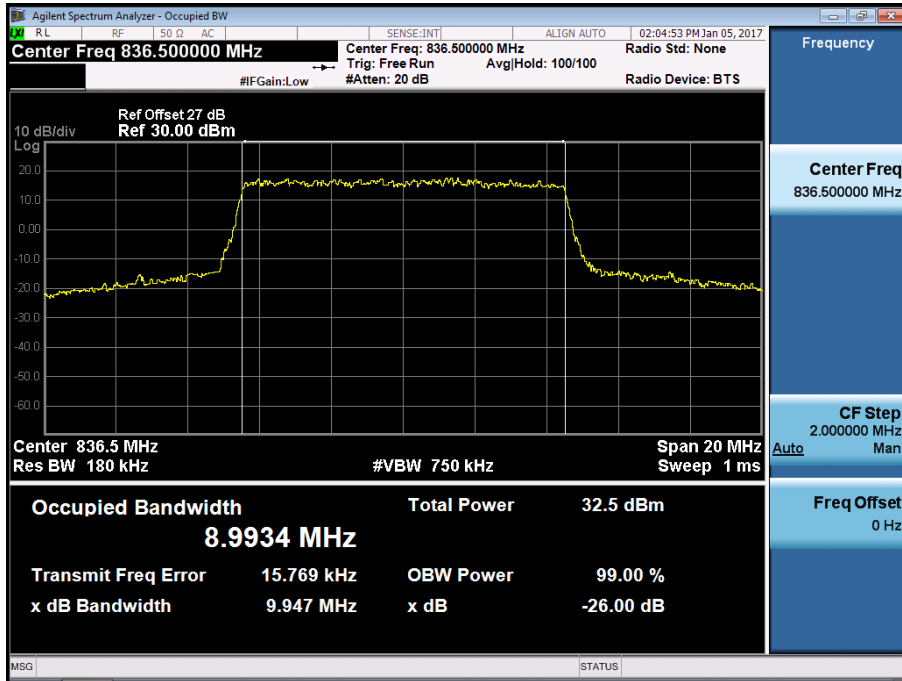

BAND 5. Occupied Bandwidth Plot (10M BW Ch.20525 16QAM_RB50_0)

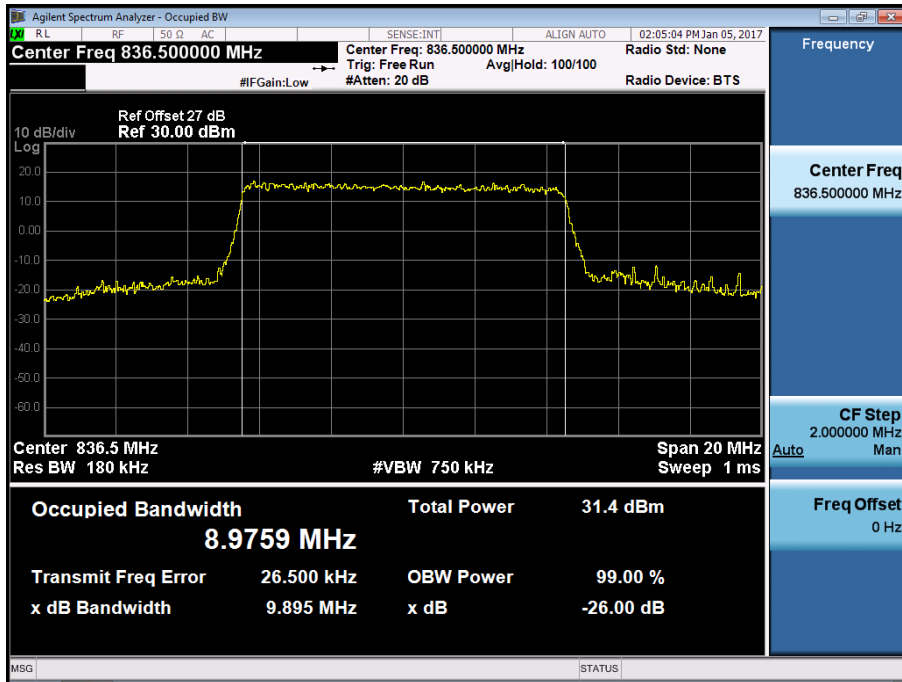

BAND 2. PAR Plot (1.4M BW Ch.18900 QPSK RB 6_0)

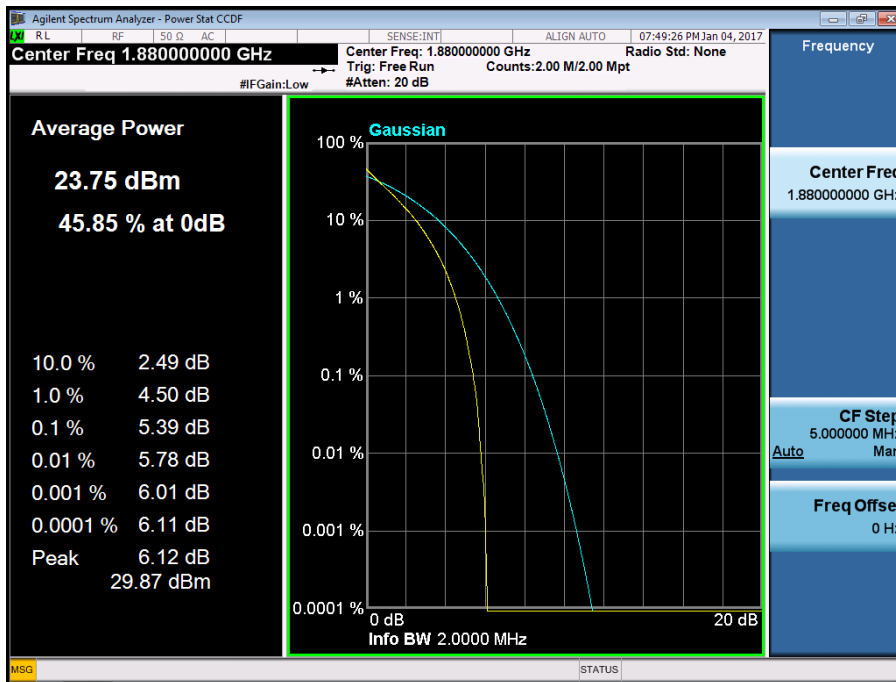

BAND 2. PAR Plot (1.4M BW Ch.18900 16QAM RB 6_0)

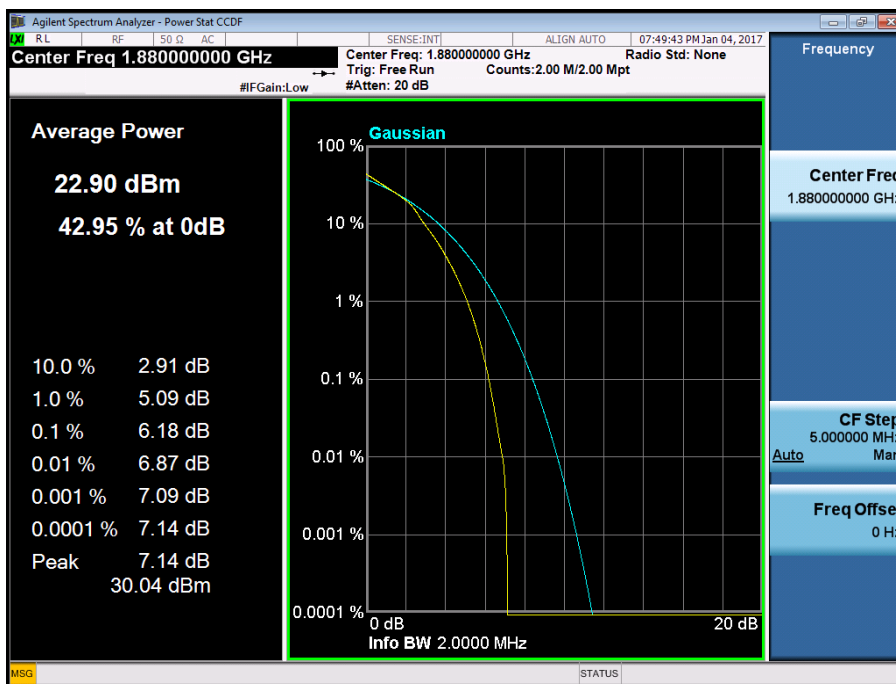

BAND 2. PAR Plot (3M BW Ch.18900 QPSK RB 15_0)

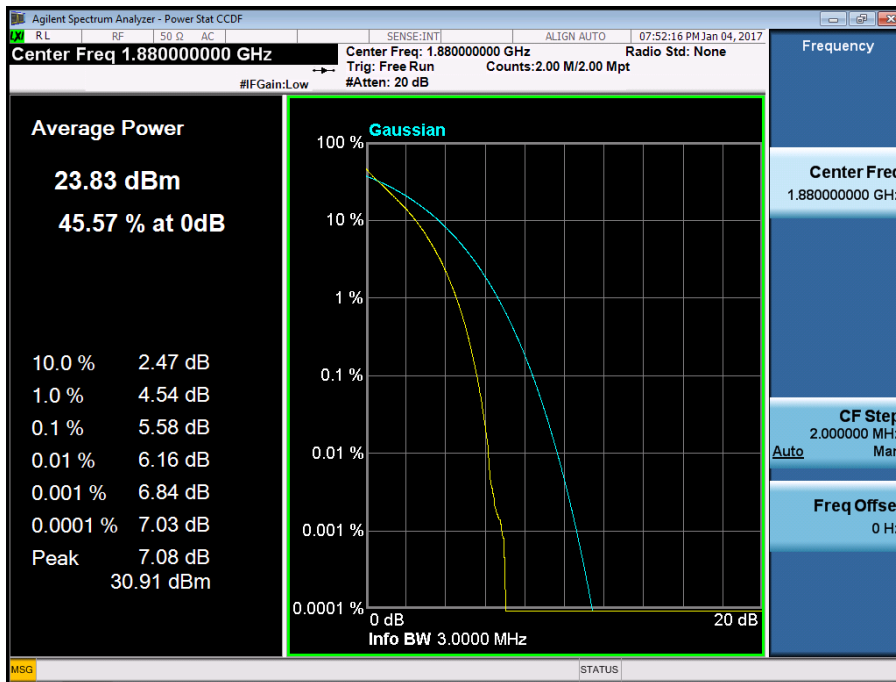

BAND 2. PAR Plot (3M BW Ch.18900 16QAM RB 15_0)

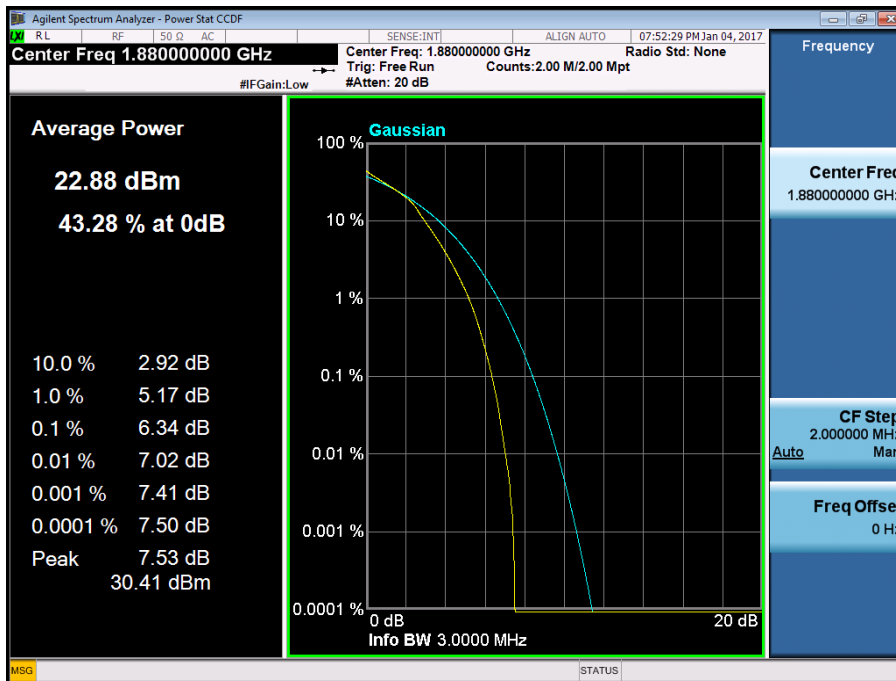

BAND 2. PAR Plot (5M BW Ch.18900 QPSK RB 25_0)

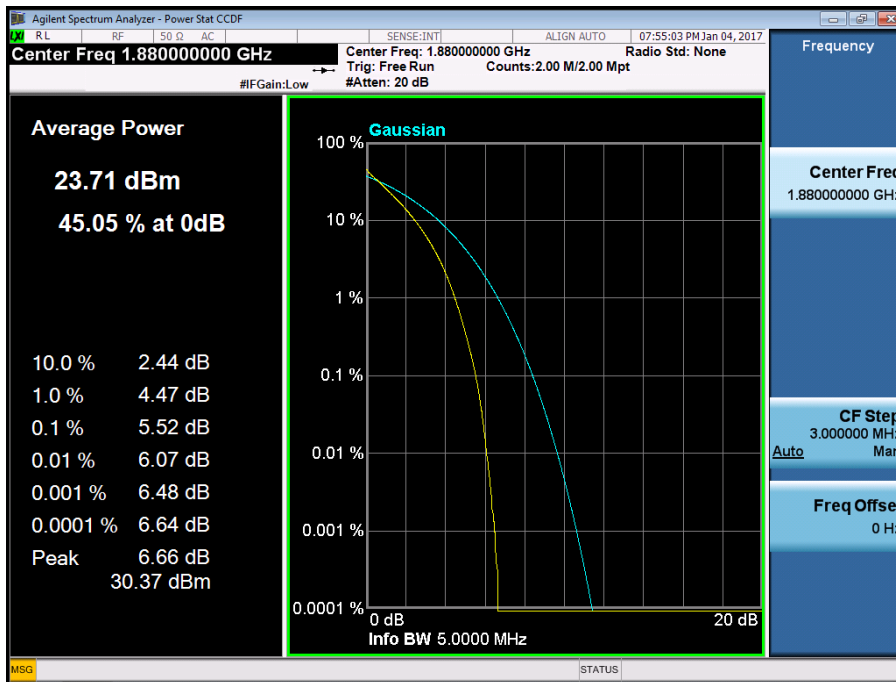

BAND 2. PAR Plot (5M BW Ch.18900 16QAM RB 25_0)

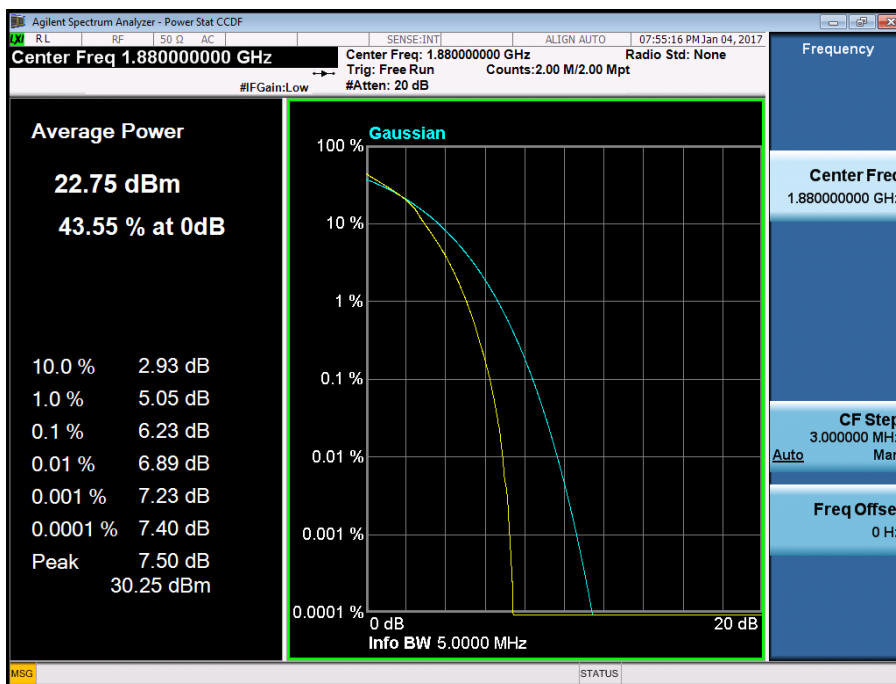

BAND 2. PAR Plot (10M BW Ch.18900 QPSK RB 50_0)

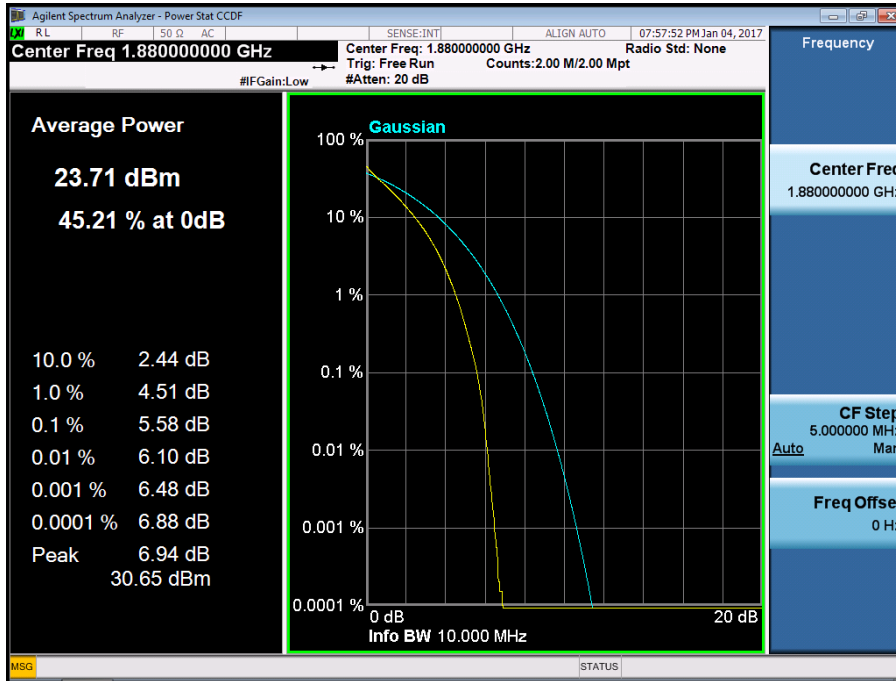

BAND 2. PAR Plot (10M BW Ch.18900 16QAM RB 50_0)

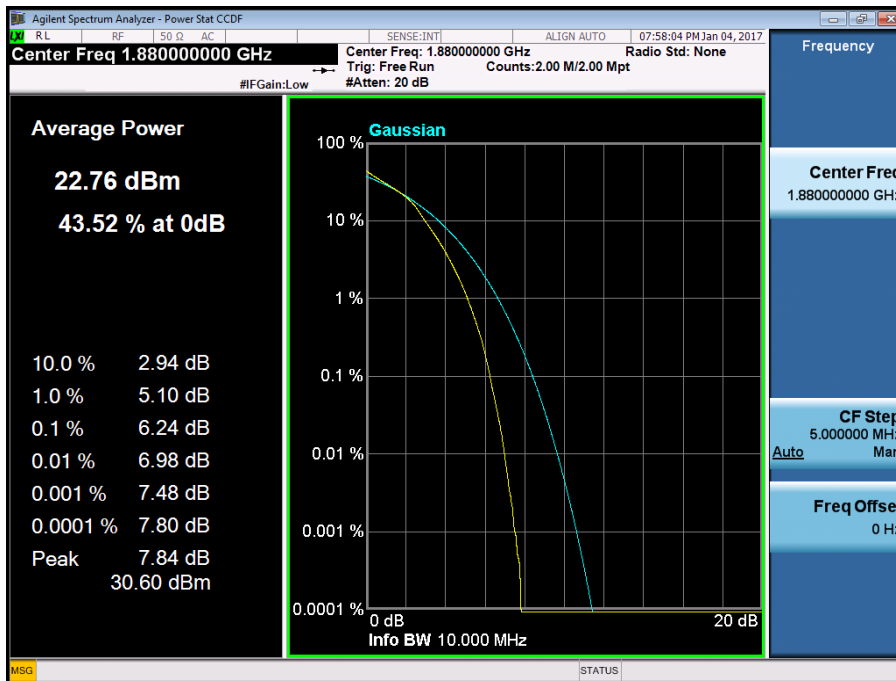

BAND 2. PAR Plot (15M BW Ch.18900 QPSK RB 75_0)

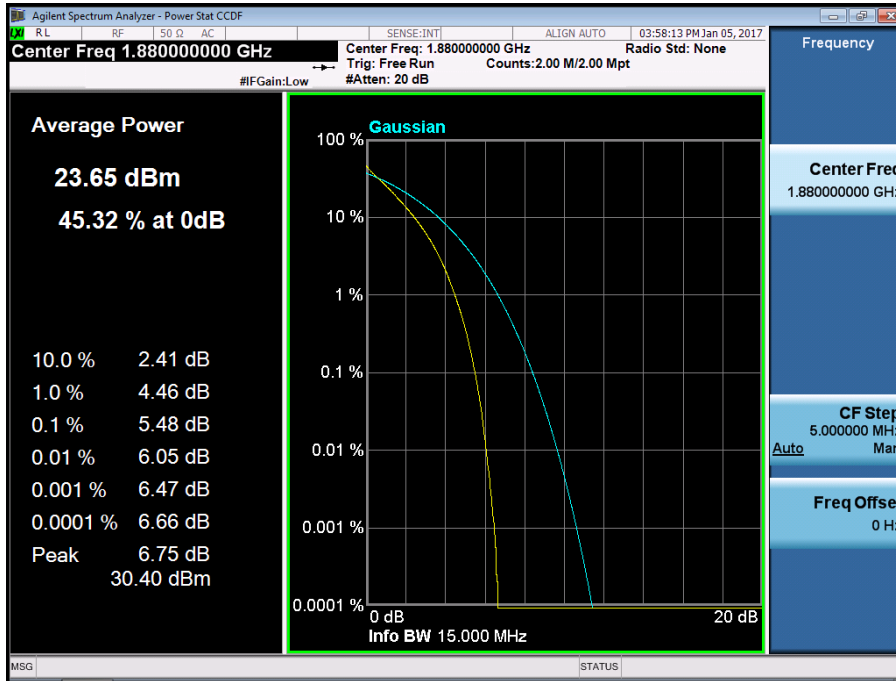

BAND 2. PAR Plot (15M BW Ch.18900 16QAM RB 75_0)

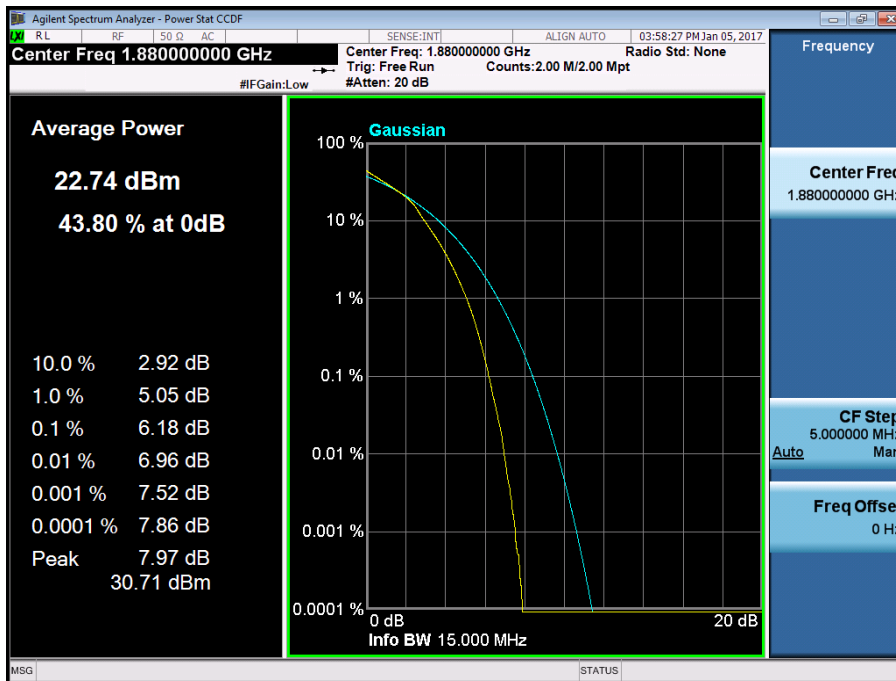

BAND 2. PAR Plot (20M BW Ch.18900 QPSK RB 100_0)

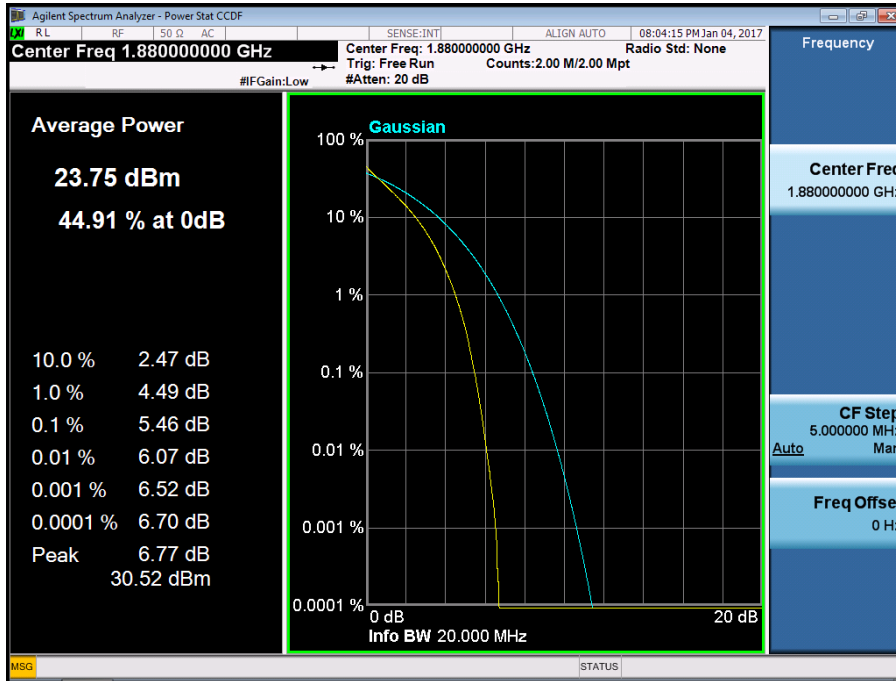

BAND 2. PAR Plot (20M BW Ch.18900 16QAM RB 100_0)

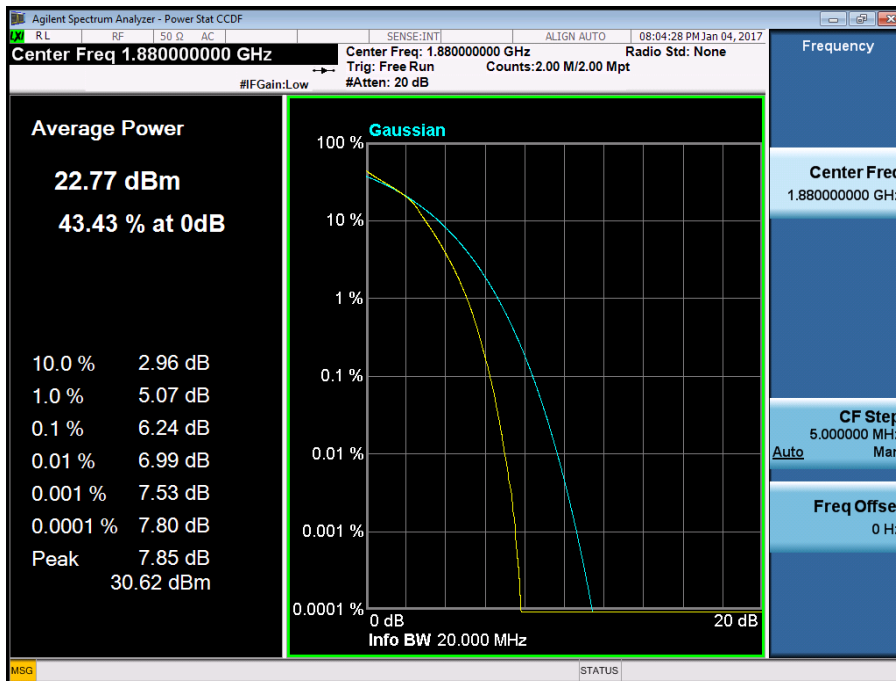

BAND 2. Lower Band Edge Plot (1.4M BW Ch.18607 QPSK_RB1_Offset 0) -1

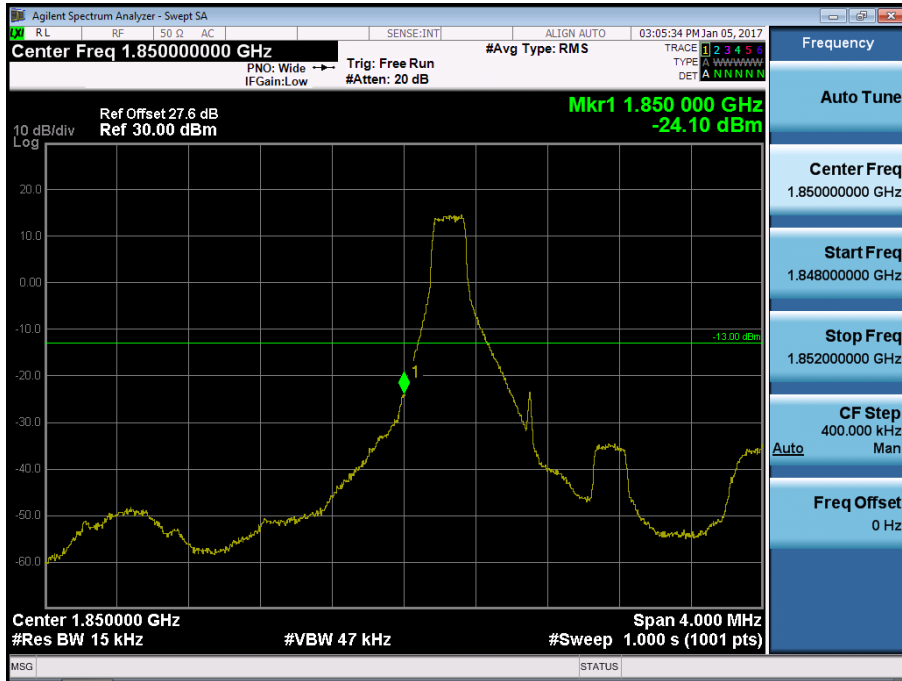

BAND 2. Lower Band Edge Plot (1.4M BW Ch.18607 QPSK_RB6_Offset 0) -2

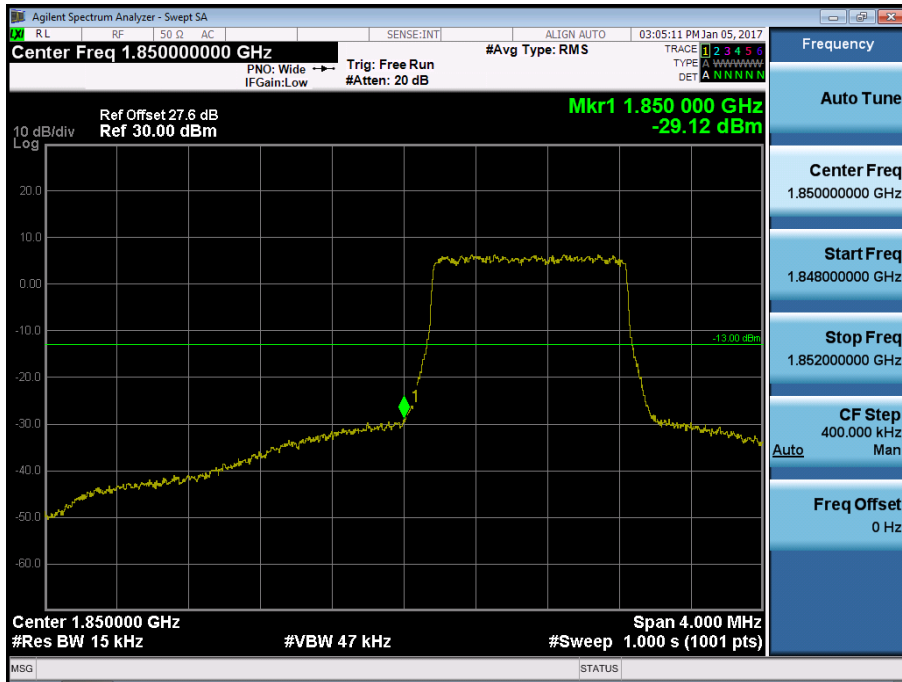

BAND 2. Lower Extended Band Edge Plot (1.4M BW Ch.18607 QPSK_RB6_0) -3



BAND 2. Lower Band Edge Plot (3M BW Ch.18615 QPSK_RB1_Offset 0) -1

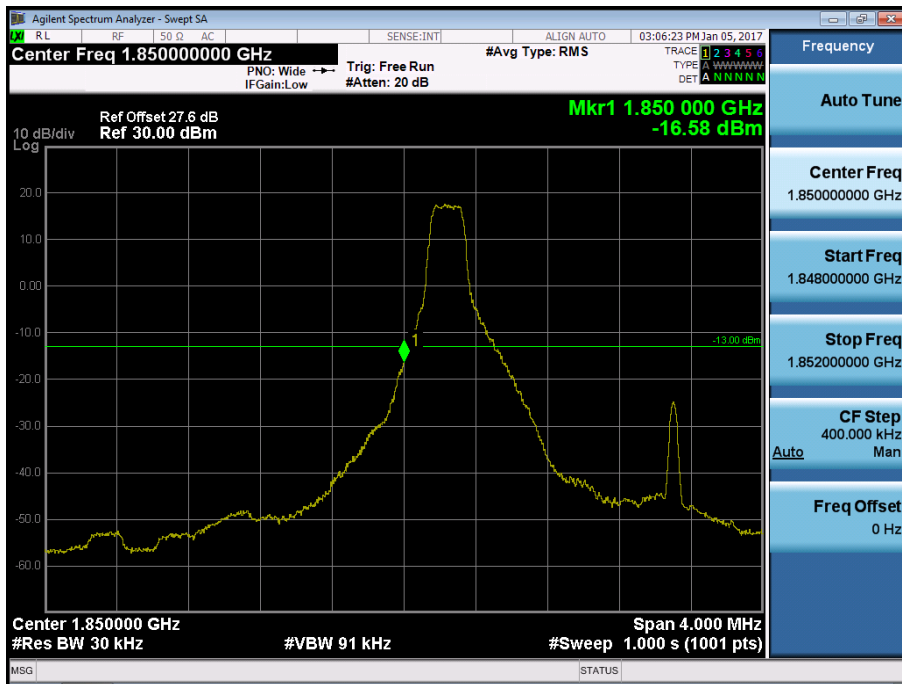

BAND 2. Lower Band Edge Plot (3M BW Ch.18615 QPSK_RB15_Offset 0) -2

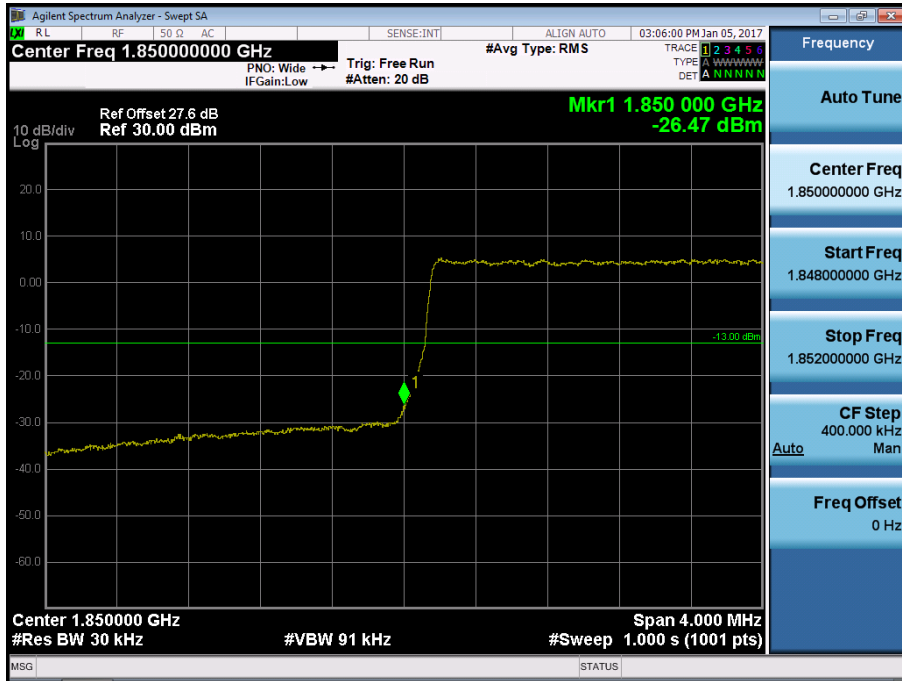

BAND 2. Lower Extended Band Edge Plot (3M BW Ch.18615 QPSK_RB15_0) -3

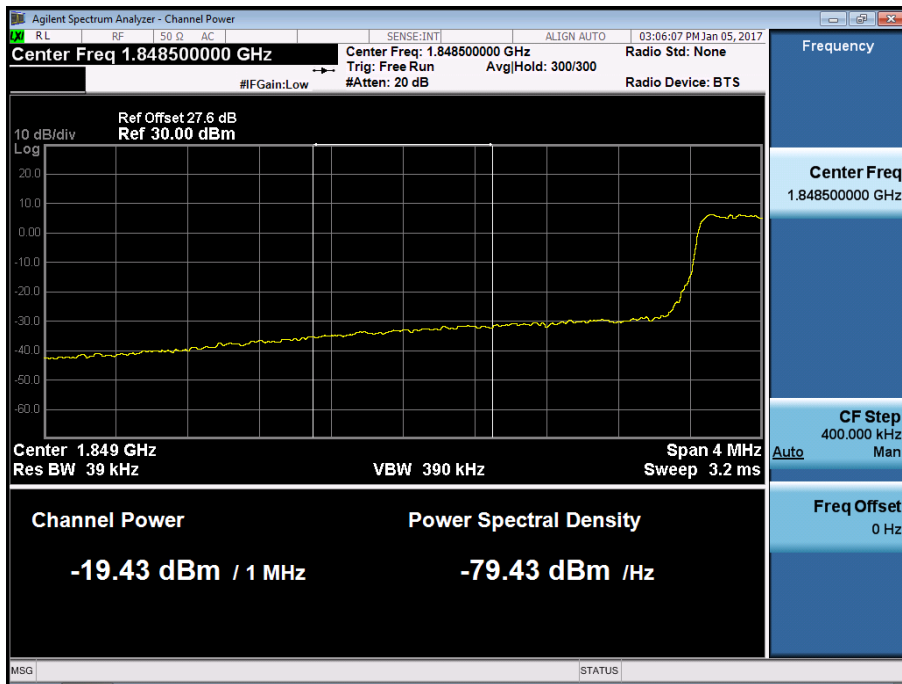

BAND 2. Lower Band Edge Plot (5M BW Ch.18625 QPSK_RB1_Offset 0) -1

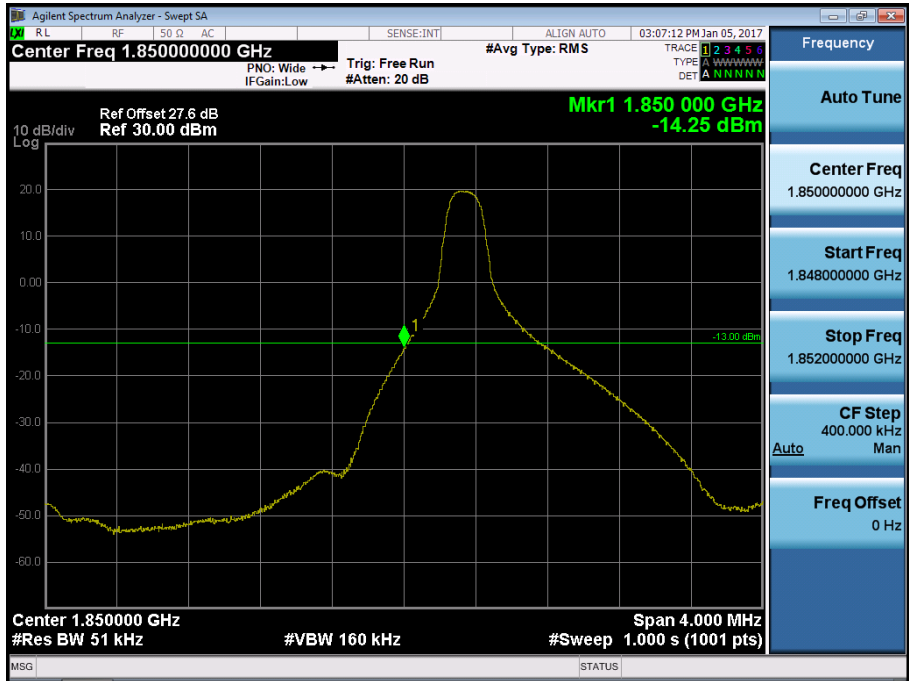

BAND 2. Lower Band Edge Plot (5M BW Ch.18625 QPSK_RB25_Offset 0) -2

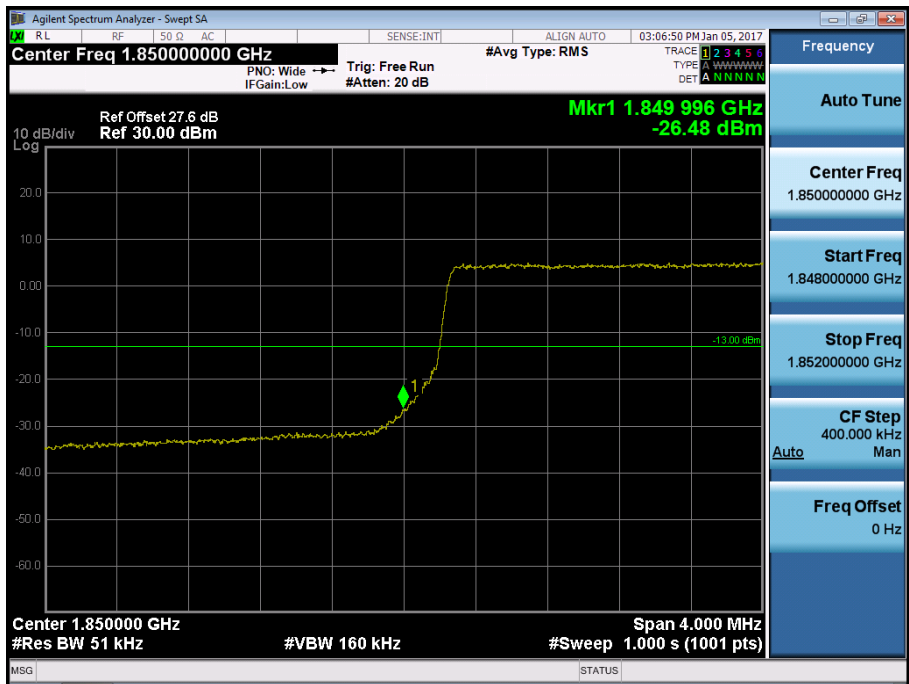

BAND 2. Lower Extended Band Edge Plot (5M BW Ch.18625 QPSK_RB25_0) -3

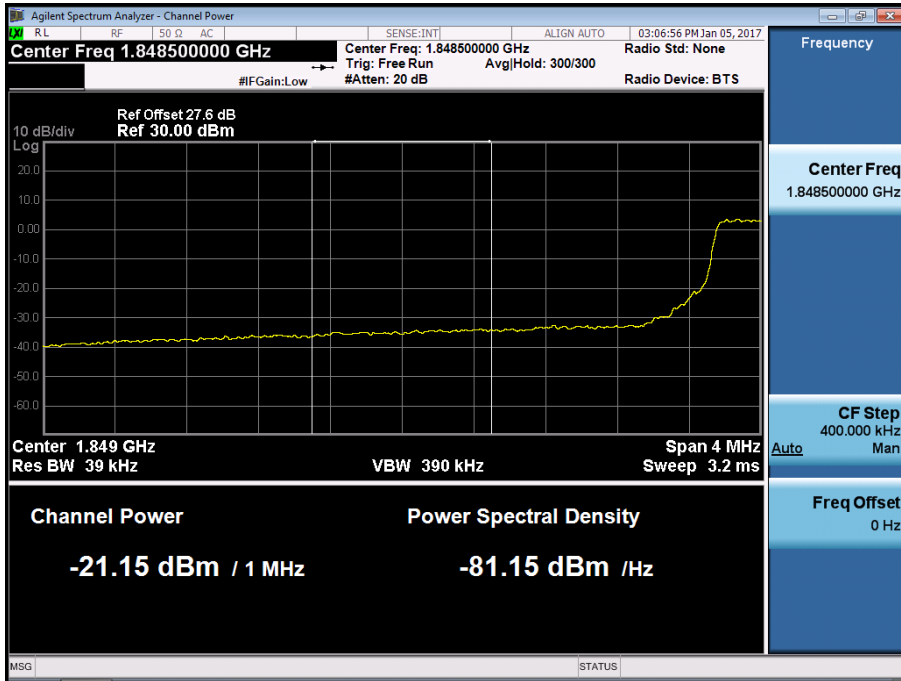

BAND 2. Lower Band Edge Plot (10M BW Ch.18650 QPSK_RB1_Offset 0) -1

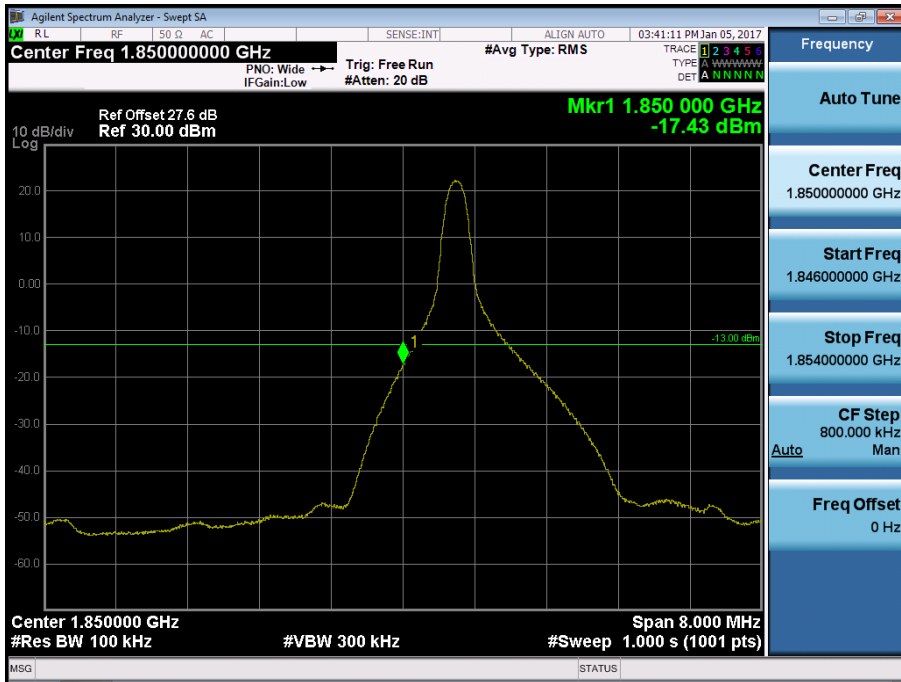

BAND 2. Lower Band Edge Plot (10M BW Ch.18650 QPSK_RB50_Offset 0) -2

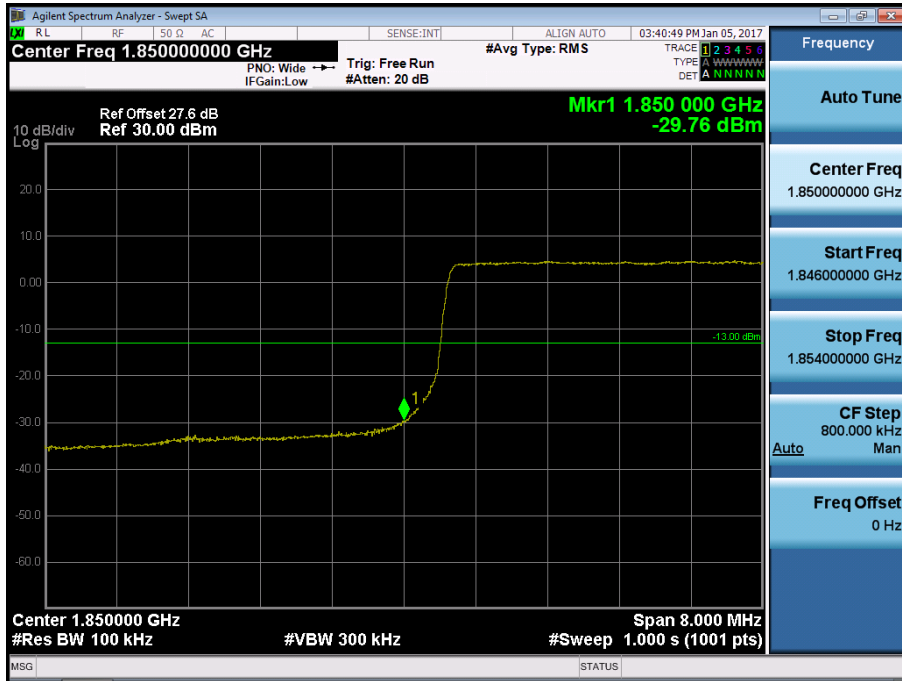

BAND 2. Lower Extended Band Edge Plot (10M BW Ch.18650 QPSK_RB50_0) -3

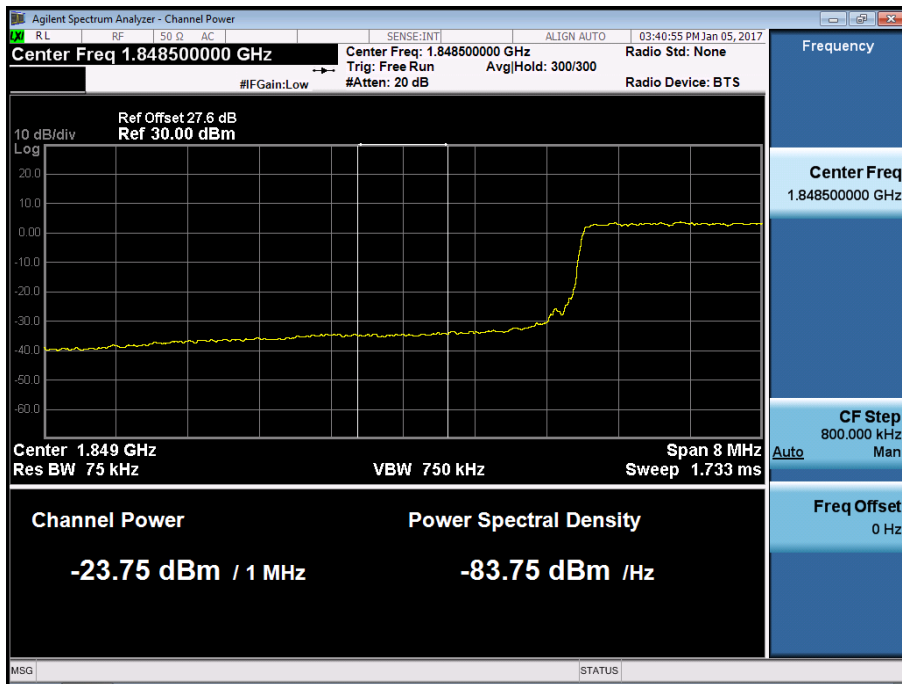

BAND 2. Lower Band Edge Plot (15M BW Ch.18675 QPSK_RB75_Offset 0) -1

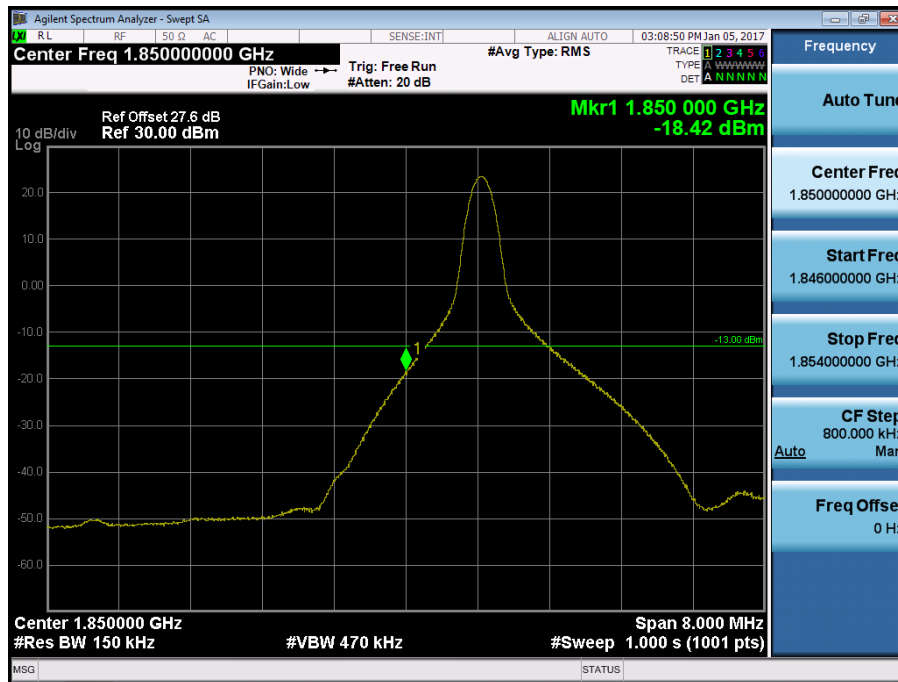

BAND 2. Lower Band Edge Plot (15M BW Ch.18675 QPSK_RB75_Offset 0) -2

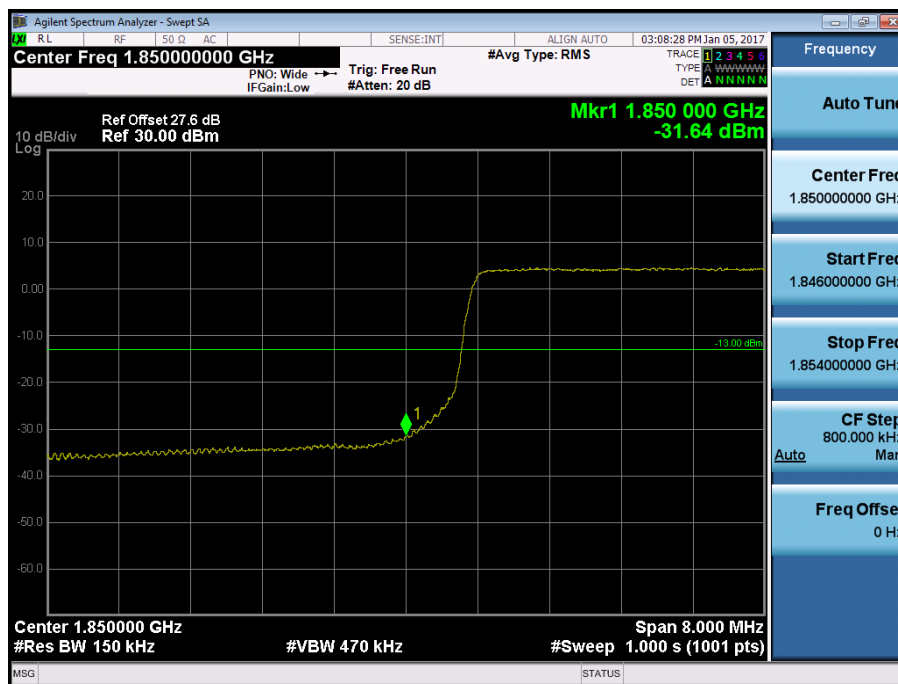

BAND 2. Lower Extended Band Edge Plot (15M BW Ch.18675 QPSK_RB75_0) -3

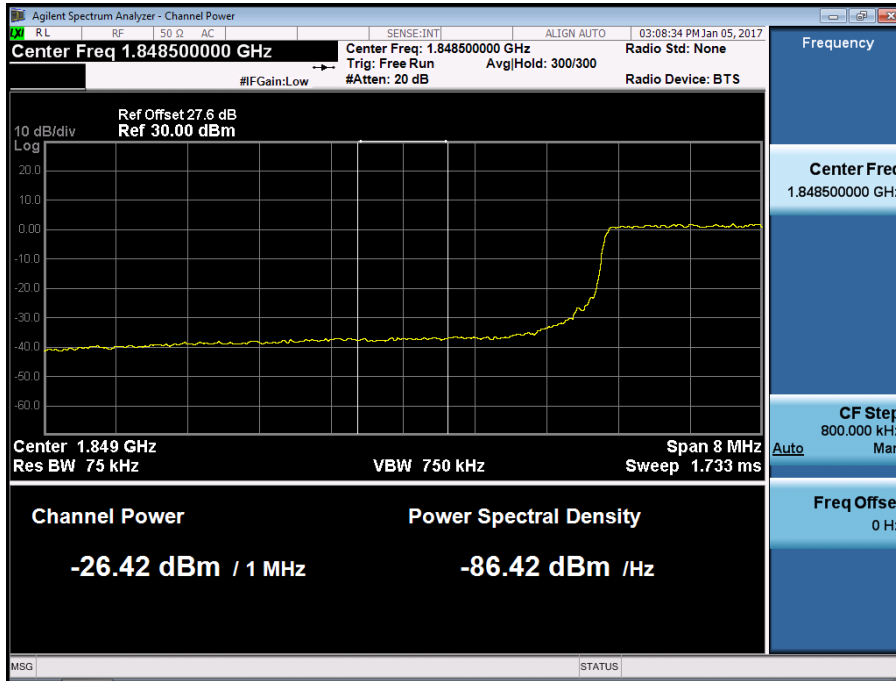

BAND 2. Lower Band Edge Plot (20M BW Ch.18700 QPSK_RB1_Offset 0) -1

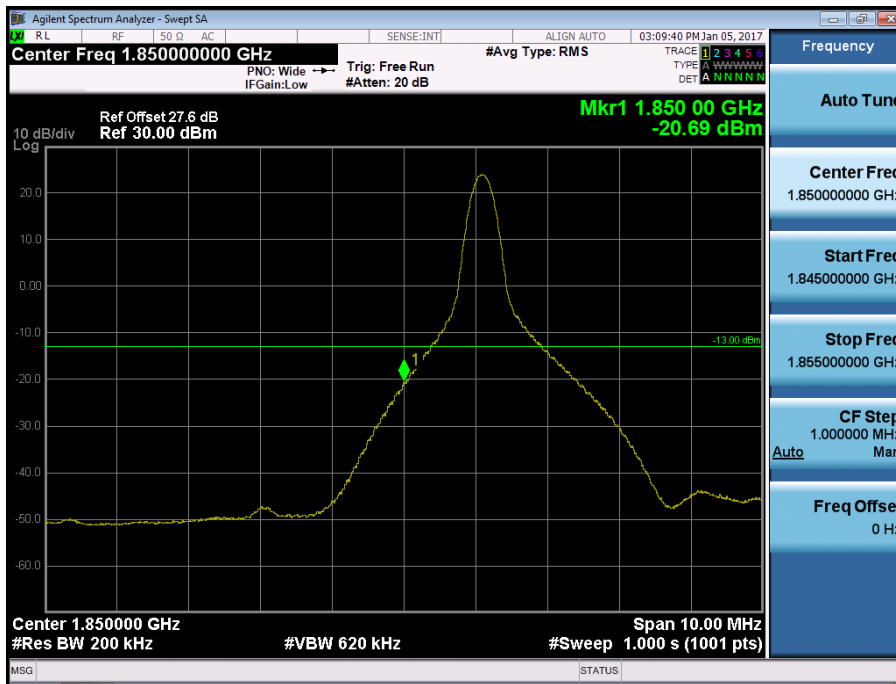

BAND 2. Lower Band Edge Plot (20M BW Ch.18700 QPSK_RB100_Offset 0) -2

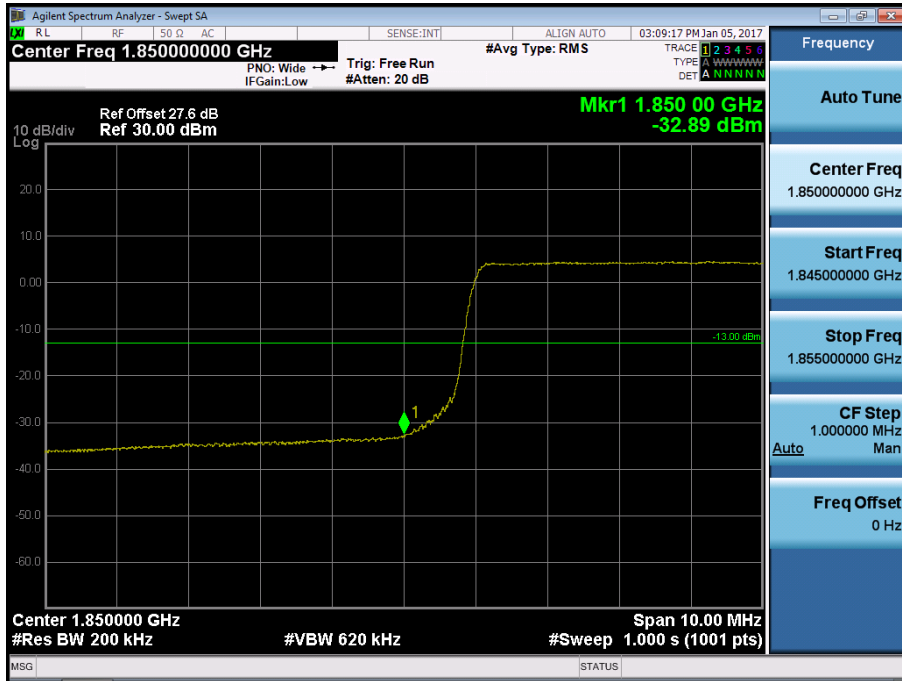

BAND 2. Lower Extended Band Edge Plot (20M BW Ch.18700 QPSK_RB100_0) -3

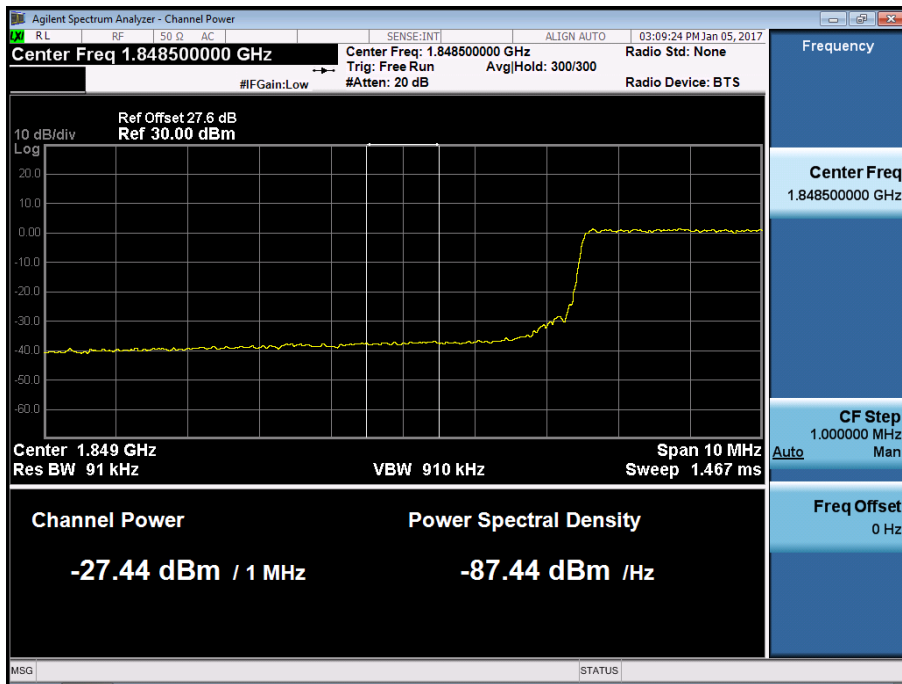

BAND 2. Upper Band Edge Plot (1.4M BW Ch.19193 QPSK_RB1_Offset 5) -1

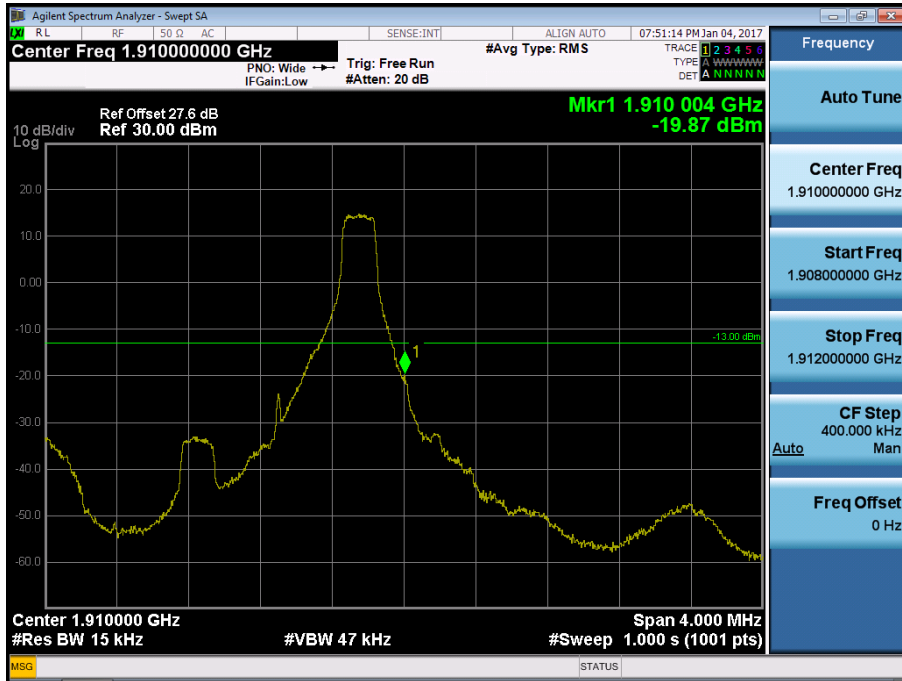

BAND 2. Upper Band Edge Plot (1.4M BW Ch.19193 QPSK_RB6_Offset 0) -2

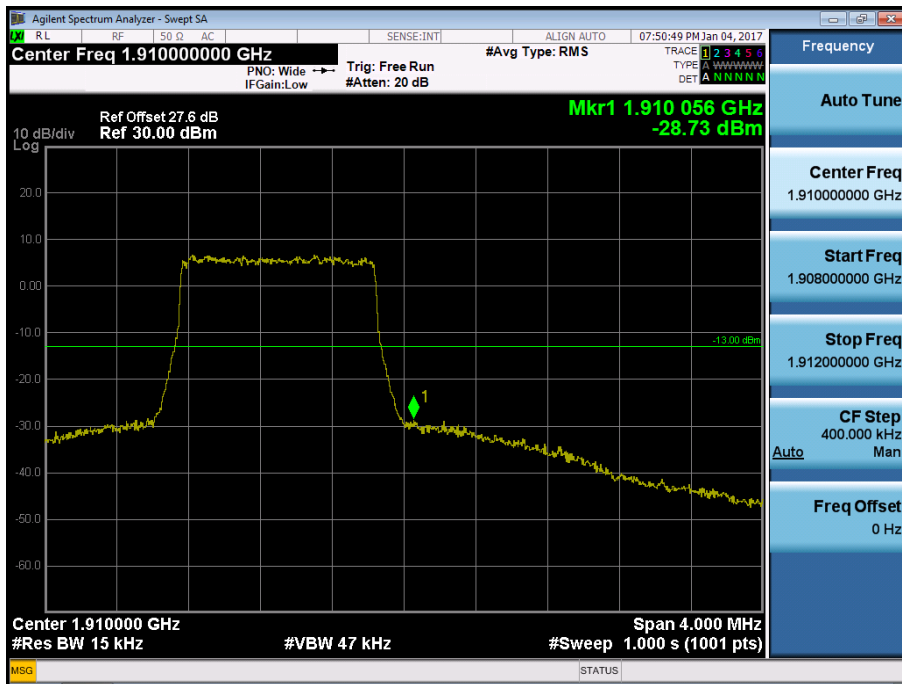

BAND 2. Upper Extended Band Edge Plot (1.4M BW Ch.19193 QPSK_RB6_0) -3



BAND 2. Upper Band Edge Plot (3M BW Ch.19185 QPSK_RB1_Offset 14) -1

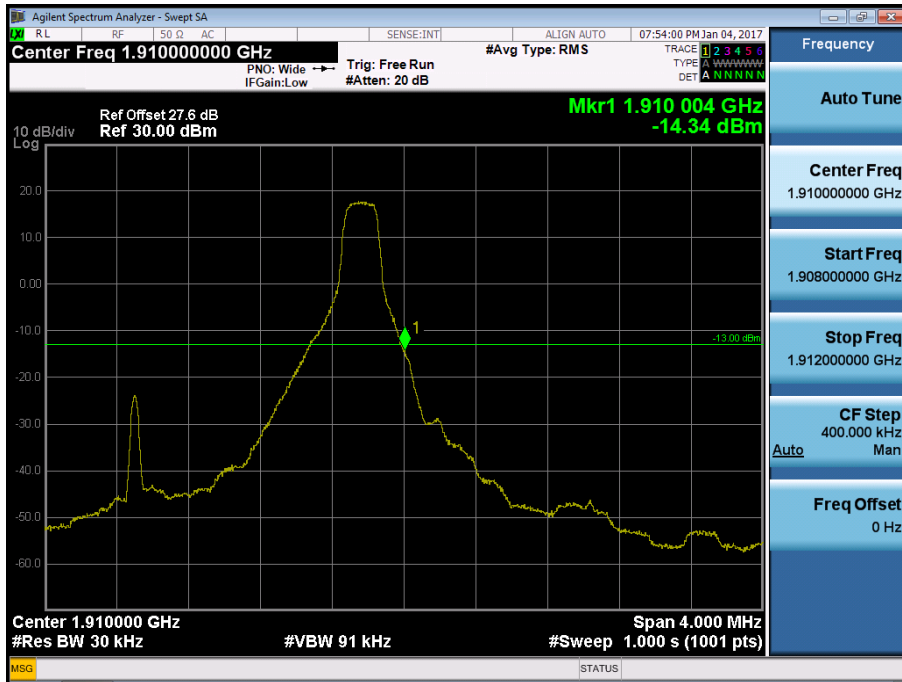

BAND 2. Upper Band Edge Plot (3M BW Ch.19185 QPSK_RB15_Offset 0) -2



BAND 2. Upper Extended Band Edge Plot (3M BW Ch.19185 QPSK_RB15 0) -3

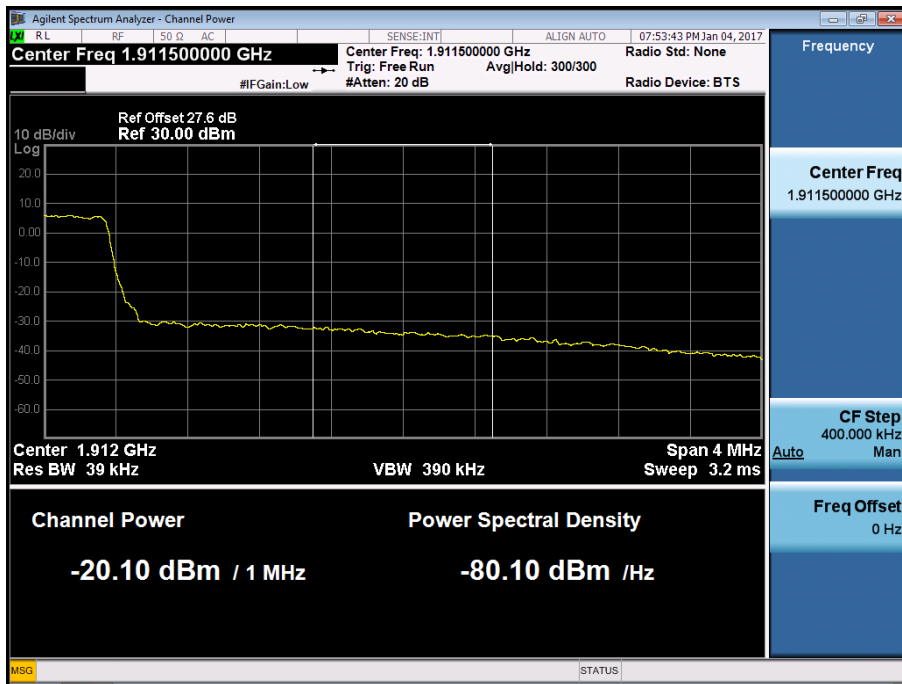

BAND 2. Upper Band Edge Plot (5M BW Ch.19175 QPSK_RB1_Offset 24) -1

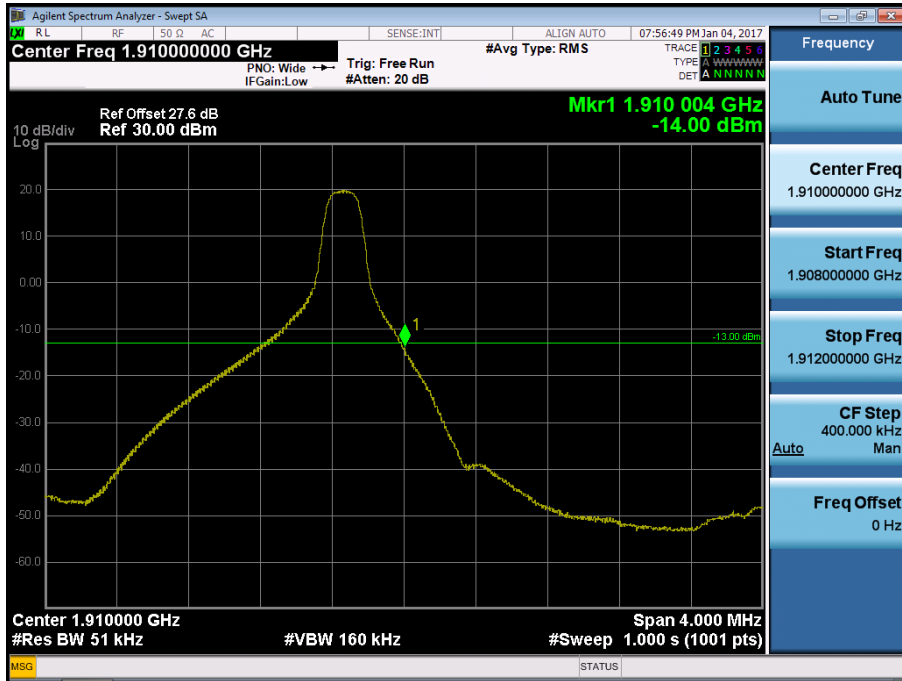

BAND 2. Upper Band Edge Plot (5M BW Ch.19175 QPSK_RB25_Offset 0) -2



BAND 2. Upper Extended Band Edge Plot (5M BW Ch.19175 QPSK_RB25_0) -3

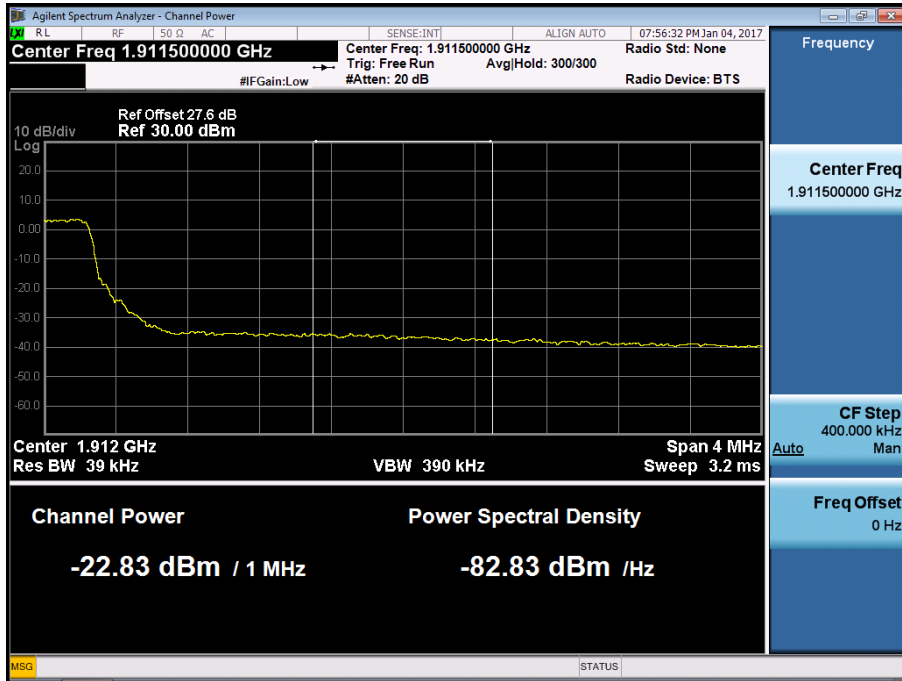

BAND 2. Upper Band Edge Plot (10M BW Ch.19150 QPSK_RB1_Offset 49) -1

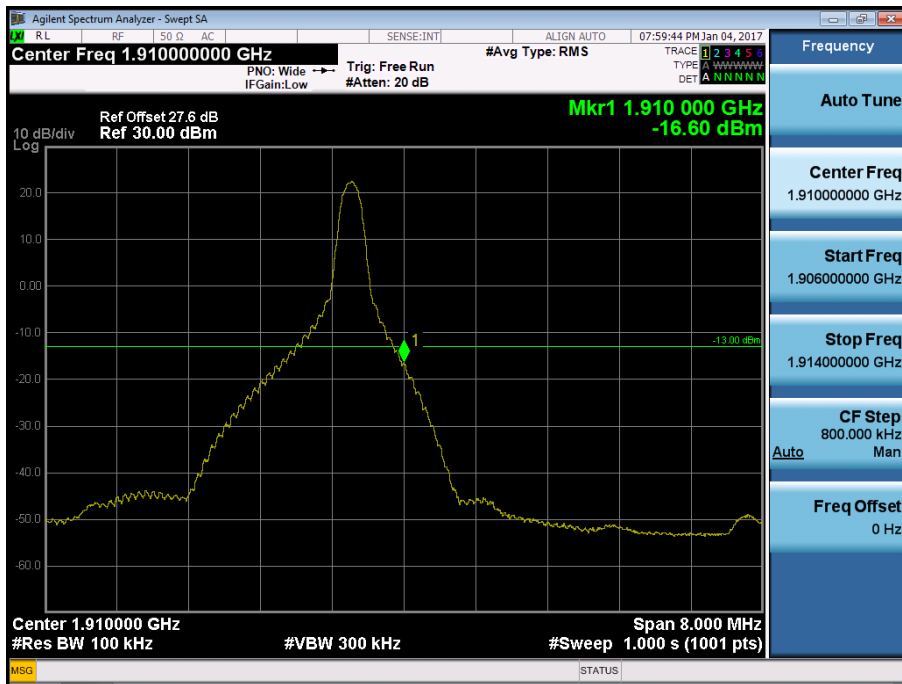

BAND 2. Upper Band Edge Plot (10M BW Ch.19150 QPSK_RB50_Offset 0) -2



BAND 2. Upper Extended Band Edge Plot (10M BW Ch.19150 QPSK_RB50_0) -3

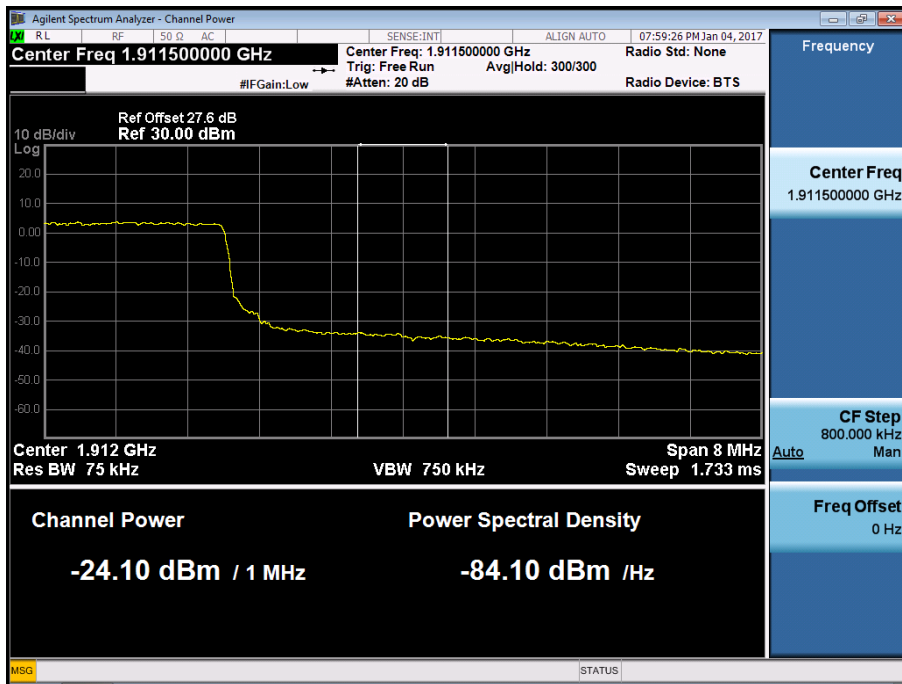

BAND 2. Upper Band Edge Plot (15M BW Ch.19125 QPSK_RB1_Offset 74) -1

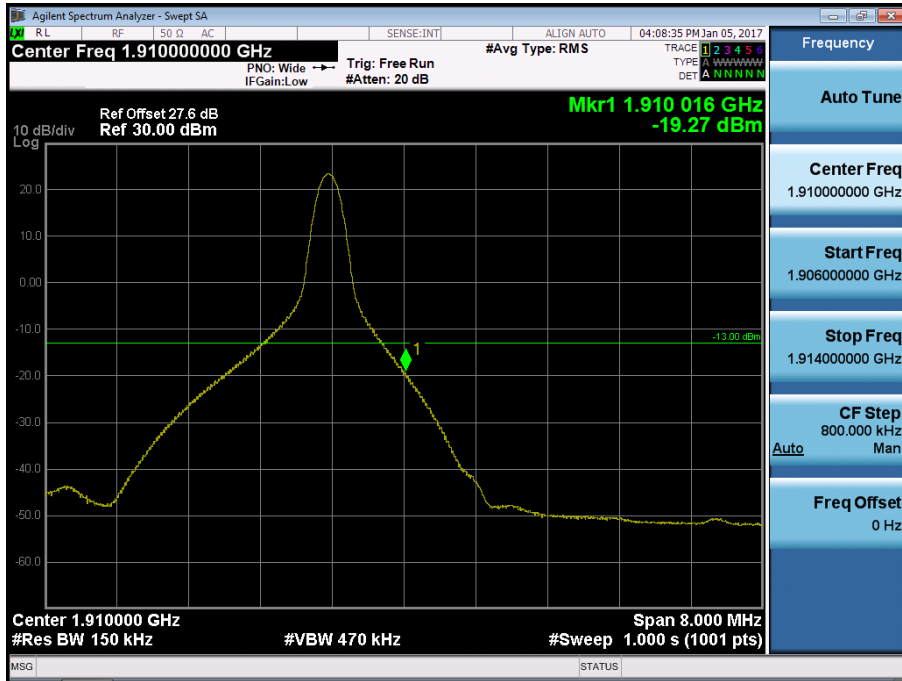

BAND 2. Upper Band Edge Plot (15M BW Ch.19125 QPSK_RB75_Offset 0) -2



BAND 2. Upper Extended Band Edge Plot (15M BW Ch.19125 QPSK_RB75_0) -3

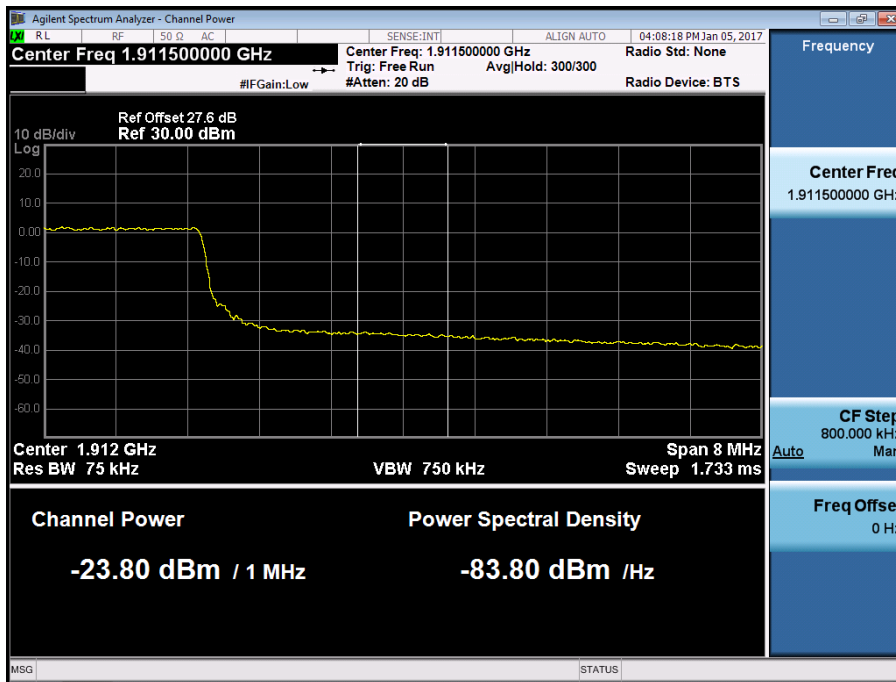

BAND 2. Upper Band Edge Plot (20M BW Ch.19100 QPSK_RB1_Offset 99) -1

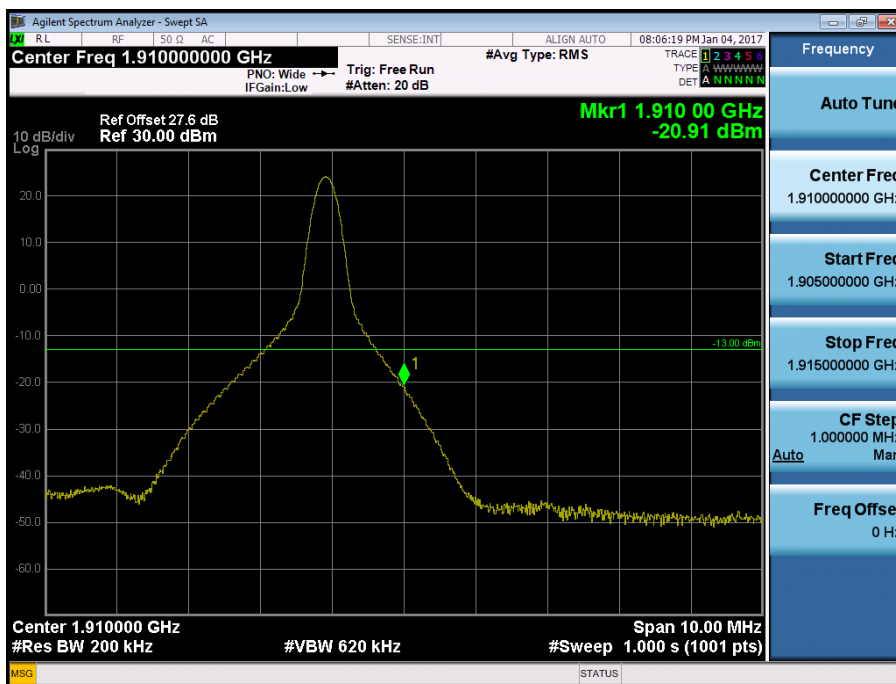

BAND 2. Upper Band Edge Plot (20M BW Ch.19100 QPSK_RB100_Offset 0) -2

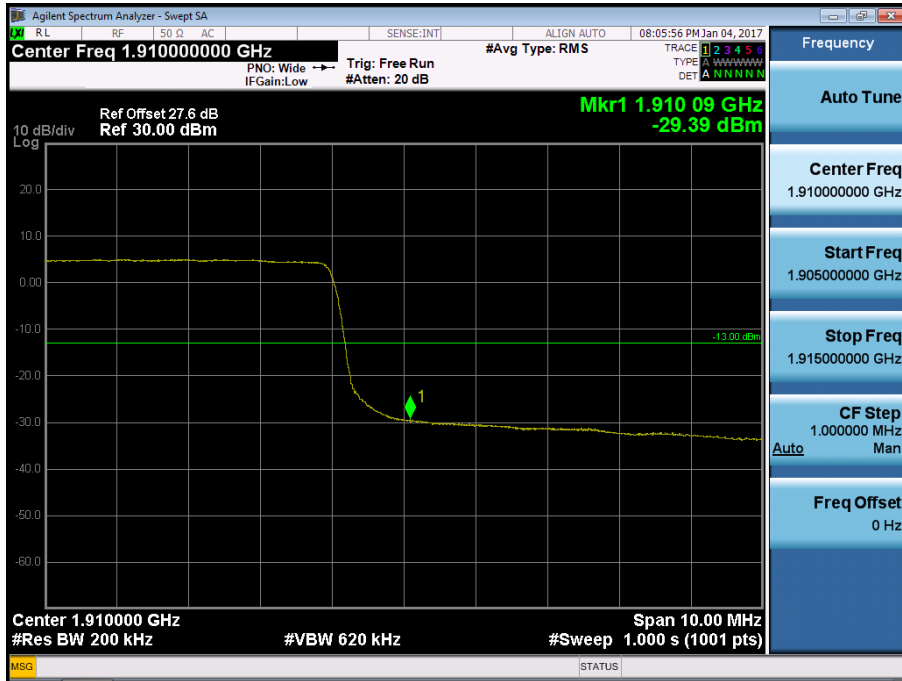

BAND 2. Upper Extended Band Edge Plot (20M BW Ch.19100 QPSK_RB100_0) -3

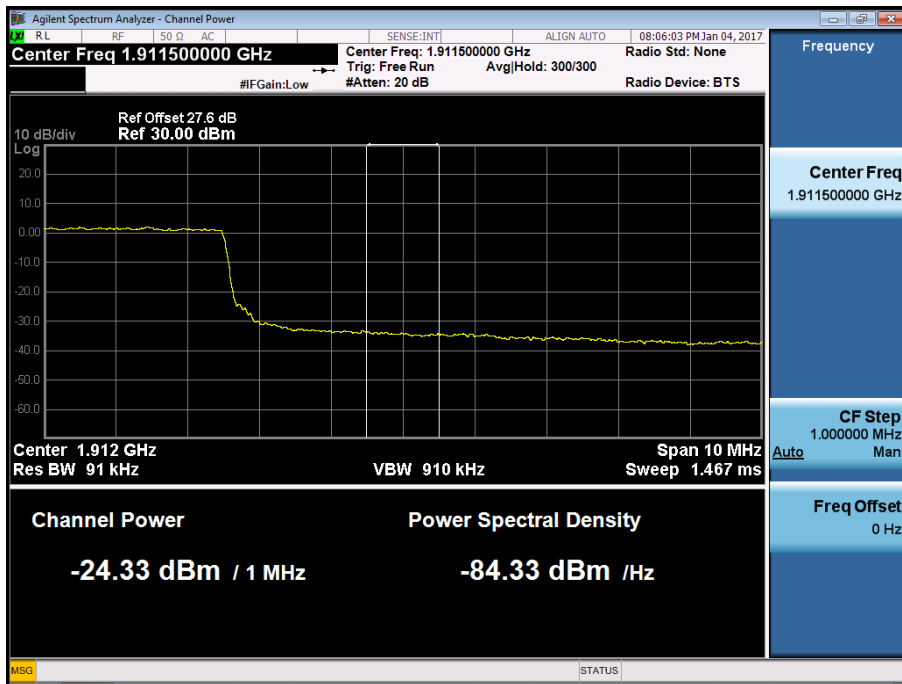

BAND 5. Lower Band Edge Plot (1.4M BW Ch.20407 QPSK_RB1_Offset 0)

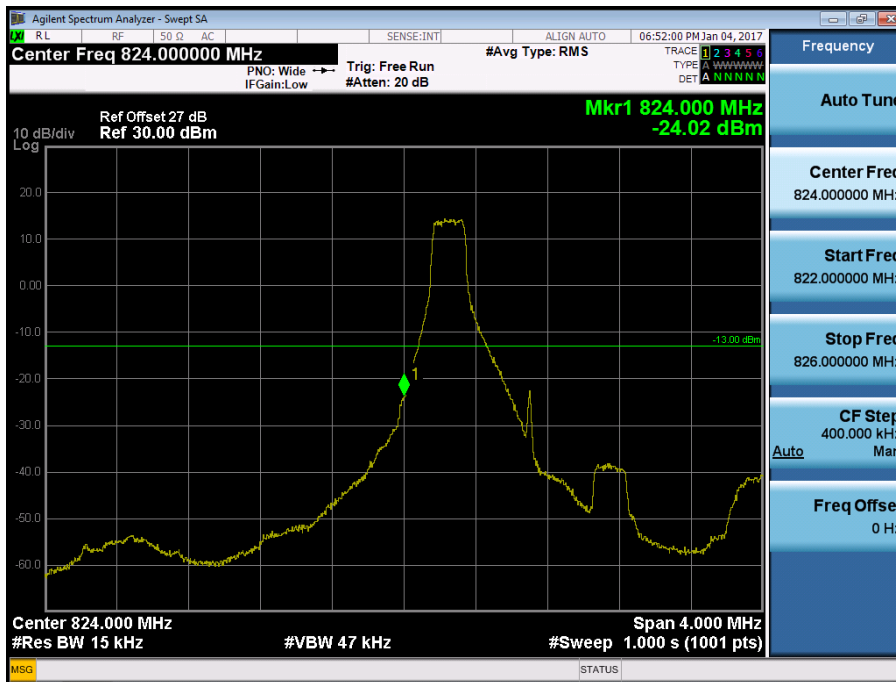

BAND 5. Lower Band Edge Plot (1.4M BW Ch.20407 QPSK_RB6_Offset 0)

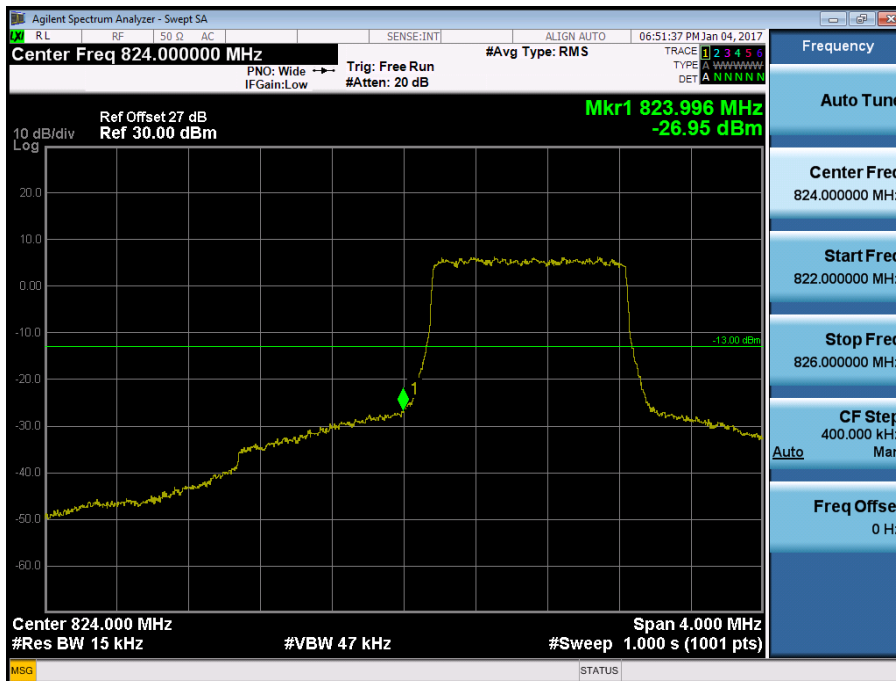

BAND 5. Lower Extended Band Edge Plot (1.4M BW Ch.20407 QPSK_RB6_0)

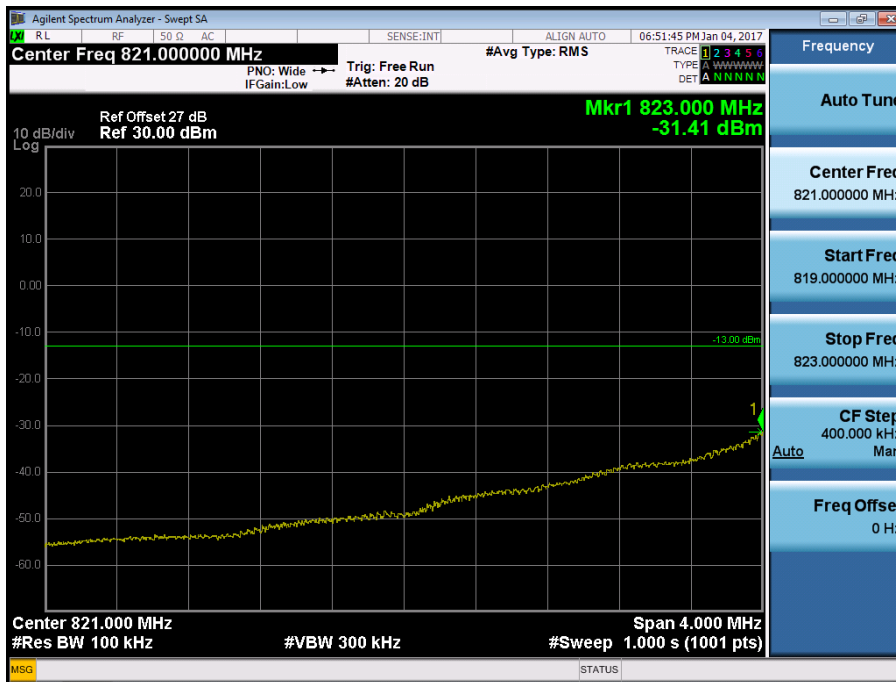

BAND 5. Lower Band Edge Plot (3M BW Ch.20415 QPSK_RB1_Offset 0)

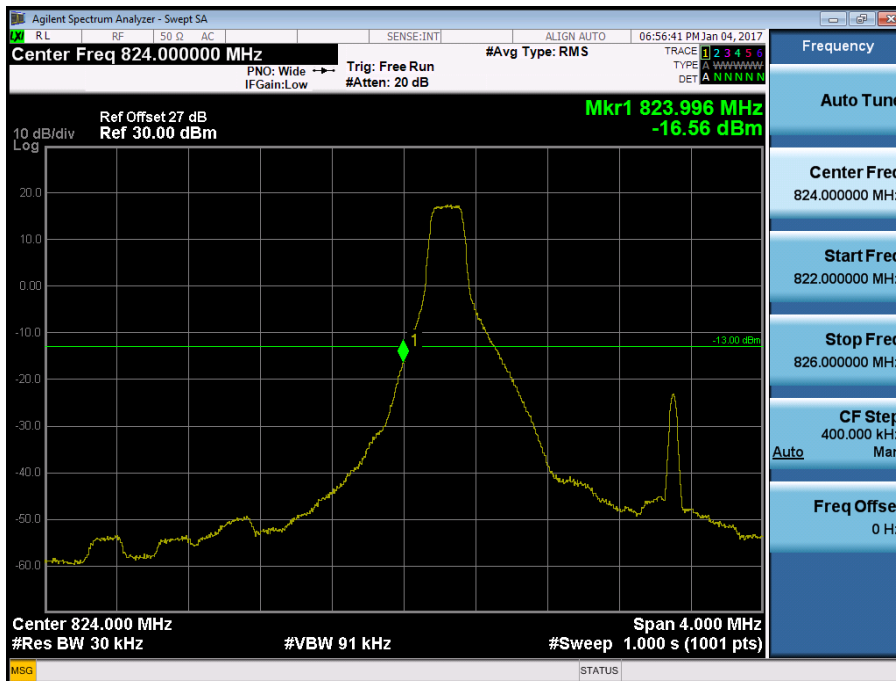

BAND 5. Lower Band Edge Plot (3M BW Ch.20415 QPSK_RB15_Offset 0)

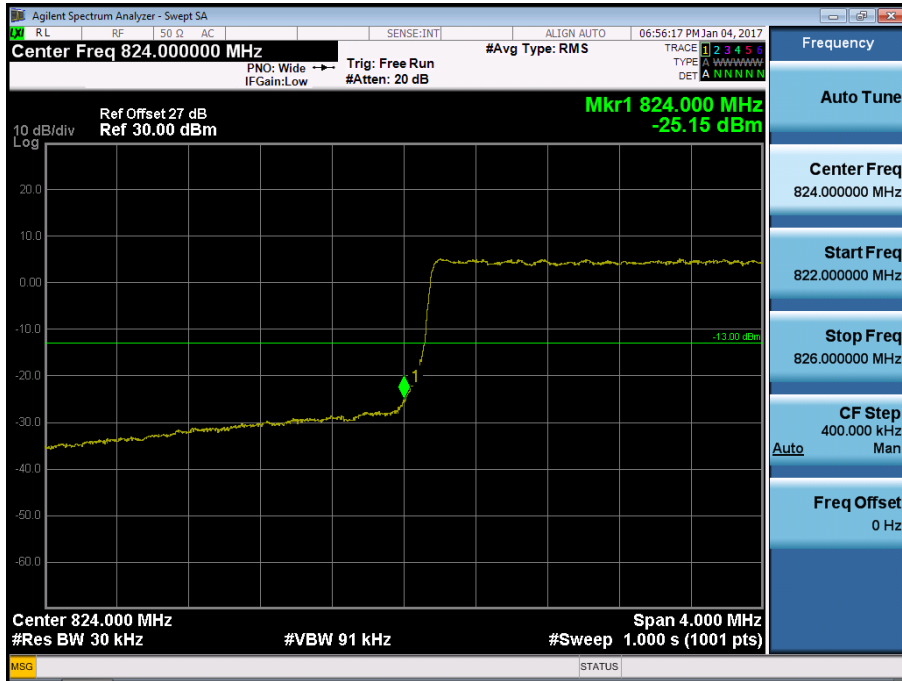

BAND 5. Lower Extended Band Edge Plot (3M BW Ch.20415 QPSK_RB15_0)

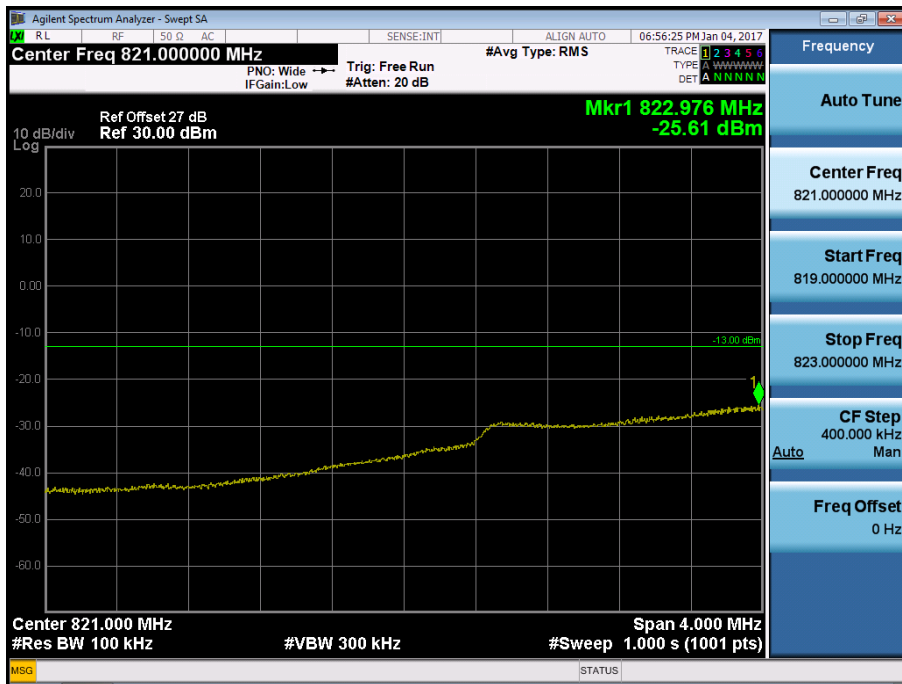

BAND 5. Lower Band Edge Plot (5M BW Ch.20425 QPSK_RB1_Offset 0)

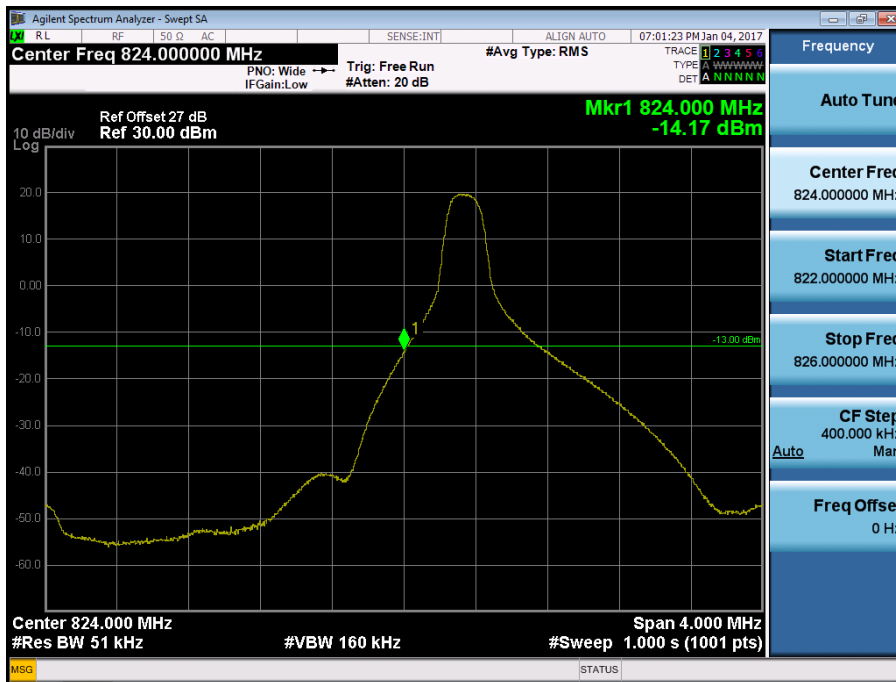

BAND 5. Lower Band Edge Plot (5M BW Ch.20425 QPSK_RB25_Offset 0)

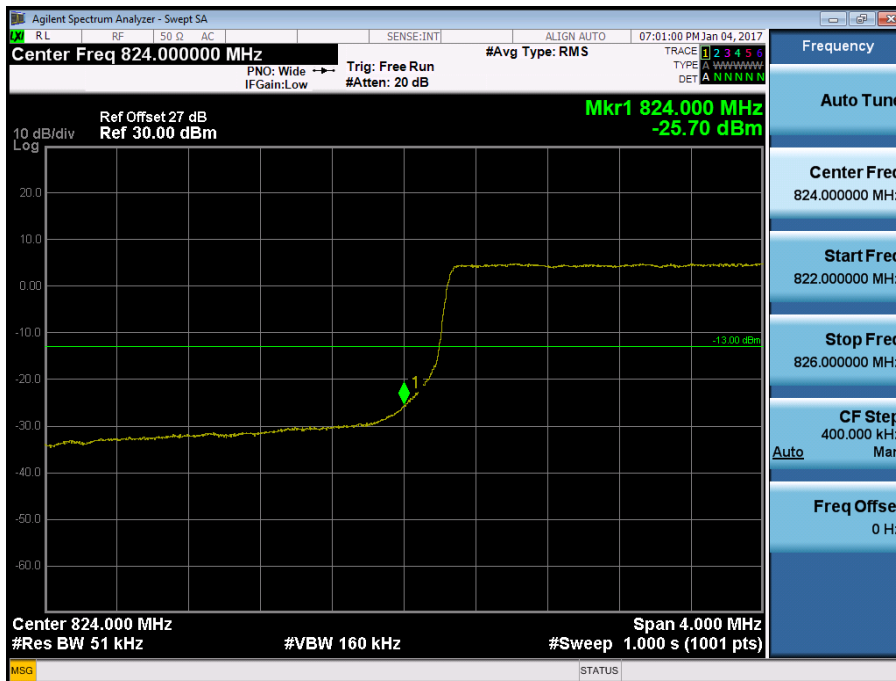

BAND 5. Lower Extended Band Edge Plot (5M BW Ch.20425 QPSK_RB25_0)

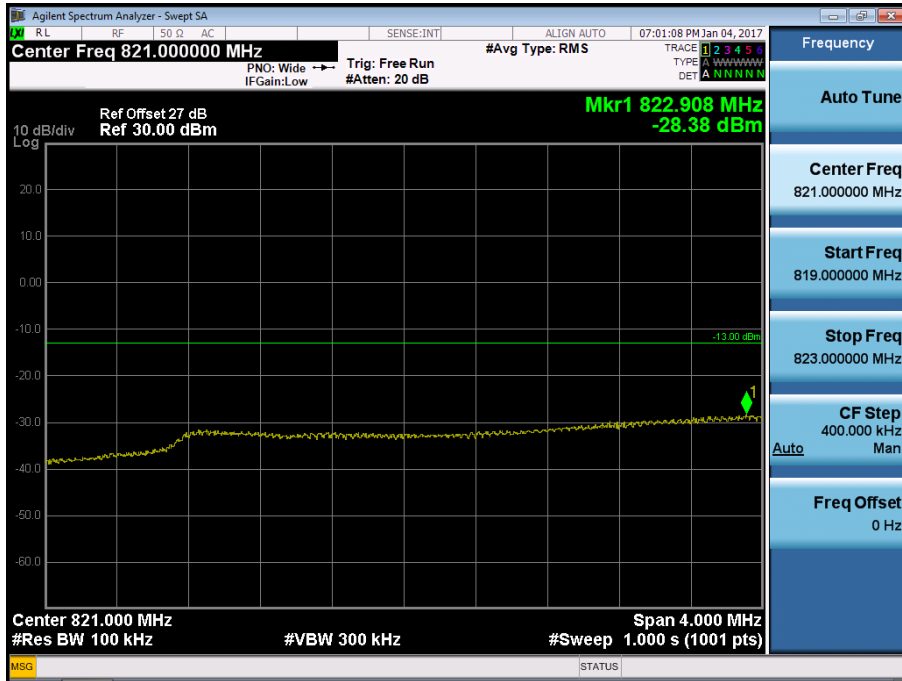

BAND 5. Lower Band Edge Plot (10M BW Ch.20450 QPSK_RB1_Offset 0)

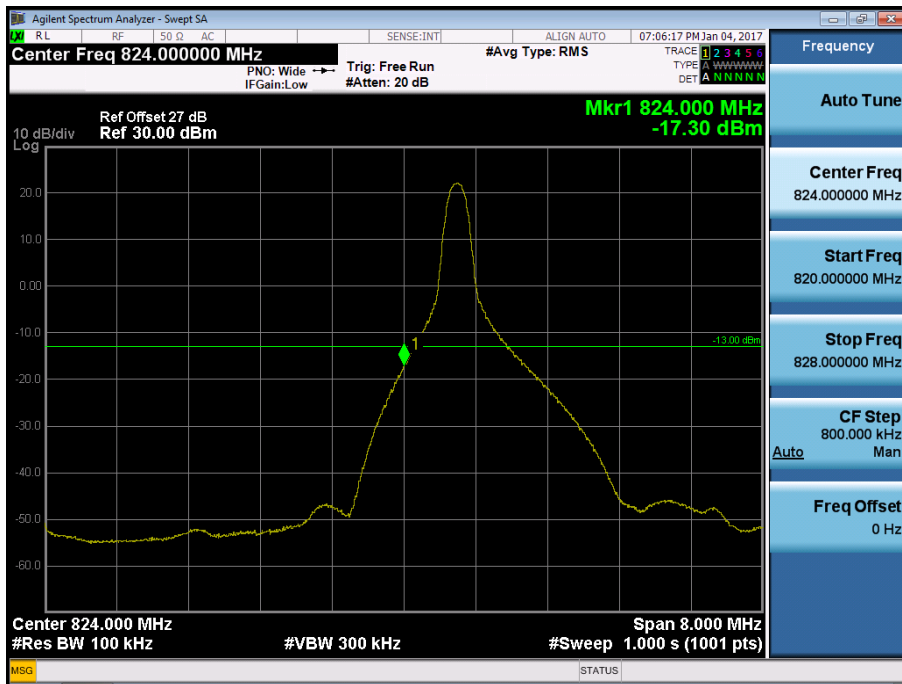

BAND 5. Lower Band Edge Plot (10M BW Ch.20450 QPSK_RB50_Offset 0)

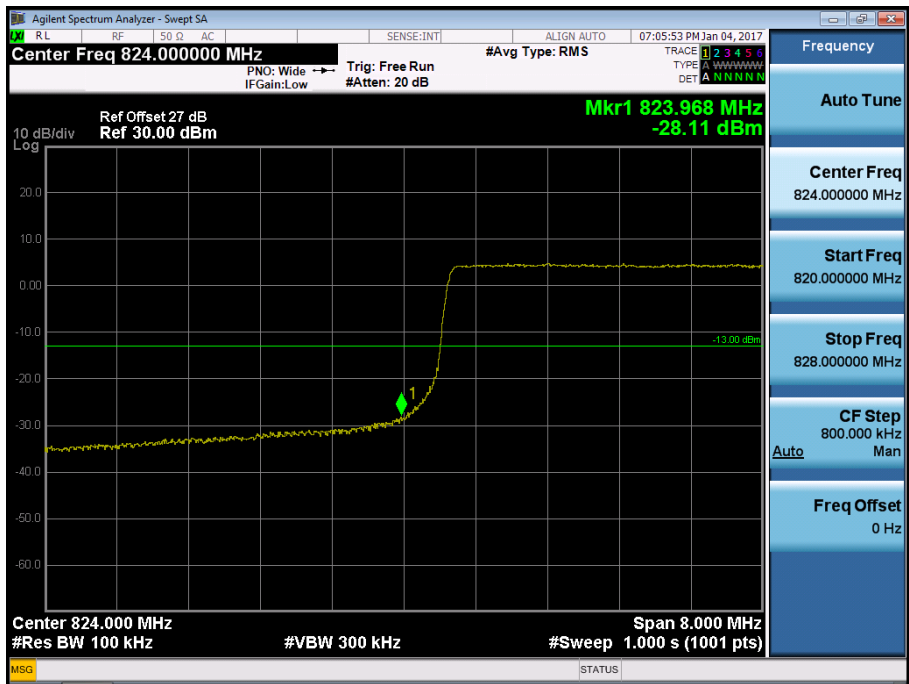

BAND 5. Lower Extended Band Edge Plot (10M BW Ch.20450 QPSK_RB50_0)

