

# FCC LTE REPORT

## FCC Certification

**Applicant Name:**  
 LG Electronics MobileComm U.S.A., Inc.

**Date of Issue:**  
 December 13, 2016

**Location:**

**Address:**  
 1000 Sylvan Avenue, Englewood Cliffs NJ 07632

HCT CO., LTD.,  
 74, Seoicheon-ro 578beon-gil, Majang-myeon,  
 Icheon-si, Gyeonggi-do, 17383, Rep. of KOREA

**Report No.:** HCT-R-1612-F037

**HCT FRN:** 0005866421

**FCC ID:** ZNFM250Y

**APPLICANT:** LG Electronics MobileComm U.S.A., Inc.

According to the Evaluation report, all of the data contained herein is reused from the reference FCC ID: ZNFM250H report.

**FCC Model(s):** LG-M250Y  
**EUT Type:** Portable Handset  
**FCC Classification:** Licensed Portable Transmitter Held to Ear (PCE)  
**FCC Rule Part(s):** §27, §2

Mode (MHz)	Tx Frequency (MHz)	Emission Designator	Modulation	EIRP	
				Max. Power (W)	Max. Power (dBm)
LTE – Band7 (5)	2502.5 – 2567.5	4M53G7D	QPSK	0.093	19.68
		4M50W7D	16QAM	0.078	18.90
LTE – Band7 (10)	2505.0 – 2565.0	8M98G7D	QPSK	0.113	20.51
		9M00W7D	16QAM	0.094	19.71
LTE – Band7 (15)	2507.5 – 2562.5	13M5G7D	QPSK	0.112	20.49
		13M5W7D	16QAM	0.094	19.71
LTE – Band7 (20)	2510.0 – 2560.0	18M0G7D	QPSK	0.114	20.58
		18M0W7D	16QAM	0.095	19.77

The measurements shown in this report were made in accordance with the procedures specified in CFR47 section §2.947. I assume full responsibility for the accuracy and completeness of these measurements, and for the qualifications of all persons taking them.

HCT CO., LTD. Certifies that no party to this application has subject to a denial of Federal benefits that includes FCC benefits pursuant to section 5301 of the Anti-Drug Abuse Act of 1998, 21 U.S.C. 853(a)



**Report prepared by**  
**: Jeong Ho Kim**  
**Test engineer of RF Team**



**Approved by**  
**: Jong Seok Lee**  
**Manager of RF Team**

This report only responds to the tested sample and may not be reproduced, except in full, without written approval of the HCT Co., Ltd.

## Version

TEST REPORT NO.	DATE	DESCRIPTION
HCT-R-1612-F037	December 13, 2016	- First Approval Report

---

---

# Table of Contents

1. GENERAL INFORMATION .....	4
2. INTRODUCTION .....	5
2.1. EUT DESCRIPTION.....	5
2.2. MEASURING INSTRUMENT CALIBRATION.....	5
2.3. TEST FACILITY .....	5
3. DESCRIPTION OF TESTS .....	6
3.1 EIRP RADIATED POWER AND RADIATED SPURIOUS EMISSIONS .....	6
3.2 OCCUPIED BANDWIDTH. ....	7
3.3 SPURIOUS AND HARMONIC EMISSIONS AT ANTENNA TERMINAL.....	8
3.4 FREQUENCY STABILITY / VARIATION OF AMBIENT TEMPERATURE .....	9
4. LIST OF TEST EQUIPMENT .....	10
5. MEASUREMENT UNCERTAINTY .....	11
6. SUMMARY OF TEST RESULTS .....	12
7. SAMPLE CALCULATION.....	13
8. TEST DATA .....	14
8.1 EQUIVALENT ISOTROPIC RADIATED POWER (Band 7) .....	14
8.2 RADIATED SPURIOUS EMISSIONS.....	16
8.2.1 RADIATED SPURIOUS EMISSIONS (5 MHz Band 7 LTE) .....	16
8.2.2 RADIATED SPURIOUS EMISSIONS (10 MHz Band 7 LTE) .....	17
8.2.3 RADIATED SPURIOUS EMISSIONS (15 MHz Band 7 LTE) .....	18
8.2.4 RADIATED SPURIOUS EMISSIONS (20 MHz Band 7 LTE) .....	19
8.3 OCCUPIED BANDWIDTH .....	20
8.4 CONDUCTED SPURIOUS EMISSIONS .....	21
8.4.1 BAND EDGE.....	22
8.5 REQUENCY STABILITY / VARIATION OF AMBIENT TEMPERATURE .....	23
8.5.1 FREQUENCY STABILITY (5 MHz Band 7 LTE) .....	23
8.5.2 FREQUENCY STABILITY (10 MHz Band 7 LTE) .....	24
8.5.3 FREQUENCY STABILITY (15 MHz Band 7 LTE) .....	25
8.5.4 FREQUENCY STABILITY (20 MHz Band 7 LTE) .....	26
9. TEST PLOTS.....	27

# MEASUREMENT REPORT

## 1. GENERAL INFORMATION

**Applicant Name:** LG Electronics MobileComm U.S.A., Inc.

**Address:** 1000 Sylvan Avenue, Englewood Cliffs NJ 07632

**FCC ID:** ZNFM250Y

**Application Type:** Certification

**FCC Classification:** Licensed Portable Transmitter Held to Ear (PCE)

**FCC Rule Part(s):** §2 , §27

**EUT Type:** Portable Handset

**FCC Model(s):** LG-M250Y

**Tx Frequency:** 2502.5 MHz – 2567.5 MHz (LTE – Band 7): 5 MHz  
2505.0 MHz – 2565.0 MHz (LTE – Band 7): 10 MHz  
2507.5 MHz – 2562.5 MHz (LTE – Band 7): 15 MHz  
2510.0 MHz – 2560.0 MHz (LTE – Band 7): 20 MHz

**Max. RF Output Power:**

Band 7 (5 MHz) :	0.093 W (QPSK) (19.68 dBm)
	0.078 W (16-QAM) (18.90 dBm)
Band 7 (10 MHz) :	0.113 W (QPSK) (20.51 dBm)
	0.094 W (16-QAM) (19.71 dBm)
Band 7 (15 MHz) :	0.112 W (QPSK) (20.49 dBm)
	0.094 W (16-QAM) (19.71 dBm)
Band 7 (20 MHz) :	0.114 W (QPSK) (20.58 dBm)
	0.095 W (16-QAM) (19.77 dBm)

**Emission Designator(s):**

Band 7 (5 MHz) :	4M53G7D (QPSK) / 4M50W7D (16-QAM)
Band 7 (10 MHz) :	8M98G7D (QPSK) / 9M00W7D (16-QAM)
Band 7 (15 MHz) :	13M5G7D (QPSK) / 13M5W7D (16-QAM)
Band 7 (20 MHz) :	18M0G7D (QPSK) / 18M0W7D (16-QAM)

**Date(s) of Tests:** October 24, 2016 ~ December 8, 2016

**Antenna Specification:**

Manufacturer:	AT&C Co.LTD.
Antenna type:	PIFA Antenna (Planar Inverted F)
Peak Gain:	Band 7: 2.14 dBi

## **2. INTRODUCTION**

### **2.1. EUT DESCRIPTION**

The LG Electronics MobileComm U.S.A., Inc. LG-M250Y Portable Handset consists of LTE 7.

### **2.2. MEASURING INSTRUMENT CALIBRATION**

The measuring equipment, which was utilized in performing the tests documented herein, has been calibrated in accordance with the manufacturer's recommendations for utilizing calibration equipment, which is traceable to recognized national standards.

### **2.3. TEST FACILITY**

The Fully-anechoic chamber and conducted measurement facility used to collect the radiated data are located at the **74, Seoicheon-ro 578beon-gil, Majang-myeon, Icheon-si, Gyeonggi-do, 17383, Rep. of KOREA.**

## **3. DESCRIPTION OF TESTS**

### **3.1 EIRP RADIATED POWER AND RADIATED SPURIOUS EMISSIONS**

Note: EIRP(Equivalent Isotropic Radiated Power)

Test Procedure

Radiated emission measurements are performed in the Fully-anechoic chamber. The equipment under test is placed on a non-conductive table 3-meters away from the receive antenna in accordance with ANSI/TIA-603-D-2010 Clause 2.2.17. The turntable is rotated through 360 degrees, and the receiving antenna scans in order to determine the level of the maximized emission. The level and position of the maximized emission is recorded with the spectrum analyzer using RMS detector.

A half wave dipole is then substituted in place of the EUT. For emissions above 1GHz, a horn antenna is substituted in place of the EUT. The substitute antenna is driven by a signal generator and the previously recorded signal was duplicated.

The power is calculated by the following formula;

$$P_{d(\text{dBm})} = P_{g(\text{dBm})} - \text{cable loss (dB)} + \text{antenna gain (dB)}$$

Where:  $P_d$  is the dipole equivalent power and  $P_g$  is the generator output power into the substitution antenna.

The maximum EIRP is calculated by adding the forward power to the calibrated source plus its appropriate gain value. These steps are repeated with the receiving antenna in both vertical and horizontal polarization. the difference between the gain of the horn and an isotropic antenna are taken into consideration

#### **Radiated spurious emissions**

1. Frequency Range : 9 kHz ~ 10<sup>th</sup> Harmonics of highest channel fundamental frequency.
2. Measured distance : 30 MHz ~ 11 GHz at 3 m  
11 GHz ~ 26 GHz at 1m
3. The EUT was setup to maximum output power. The 100 kHz RBW was used to scan from 30 MHz to 1 GHz. Also, the 1 MHz RBW was used to scan from 1 GHz to 26.5 GHz. And limit is -25 dBm. The high, low and a middle channel were tested for out of band measurements.

### 3.2 OCCUPIED BANDWIDTH.

#### Test set-up

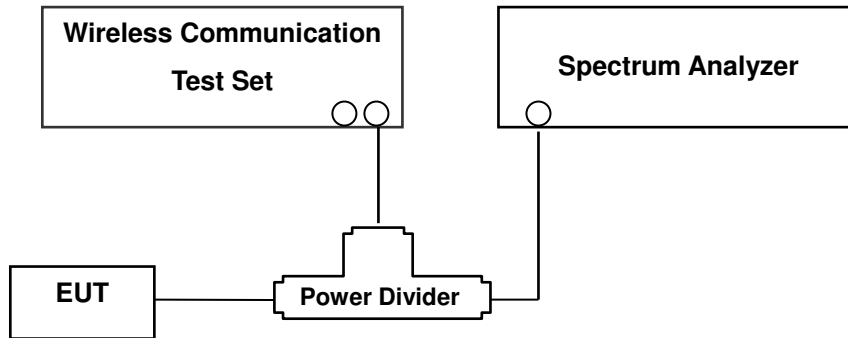

(Configuration of conducted Emission measurement)

The width of a frequency band such that, below the lower and above the upper frequency limits, the mean powers emitted are each equal to a specified percentage 0.5 % of the total mean power of a given emission.

#### Test Procedure

OBW is tested in accordance with KDB971168 D01 Power Meas License Digital Systems v02r02, October 17, 2014, Section 4.2.

The EUT makes a call to the communication simulator. The power was measured with R&S Spectrum Analyzer. All measurements were done at 3 channels(low, middle and high operational range.)

The conducted occupied bandwidth used the power splitter via EUT RF power connector between simulation base station and spectrum analyzer.

The communication simulator station system controlled a EUT to export maximum output power under transmission mode and specific channel frequency. Use OBW measurement function of Spectrum analyzer to measure 99 % occupied bandwidth

### 3.3 SPURIOUS AND HARMONIC EMISSIONS AT ANTENNA TERMINAL.

#### Test Procedure

Spurious and harmonic emissions at antenna terminal is tested in accordance with KDB971168 D01 Power Meas License Digital Systems v02r02, October 17, 2014, Section 6.0.

The level of the carrier and the various conducted spurious and harmonic frequencies is measured by means of a calibrated spectrum analyzer.

The EUT was setup to maximum output power. The 1 MHz RBW was used to scan from 30 MHz to 26.5 GHz. And limit is -25 dBm. The high, low and a middle channel were tested for out of band measurements.

- Channel Edge Requirement : In the 1 MHz bands immediately outside and adjacent to the channel, a resolution bandwidth of at least 1 percent of the emission bandwidth of the fundamental emission of the transmitter may be employed to measure the out of band Emissions.

**NOTES:** The analyzer plot offsets were determined by below conditions.

- For LTE Band 7, total offset 27.9 dBm = 20 dBm attenuator + 6 dBm Divider + 1.9 dBm RF cables.



### 3.4 FREQUENCY STABILITY / VARIATION OF AMBIENT TEMPERATURE

#### Test Set-up

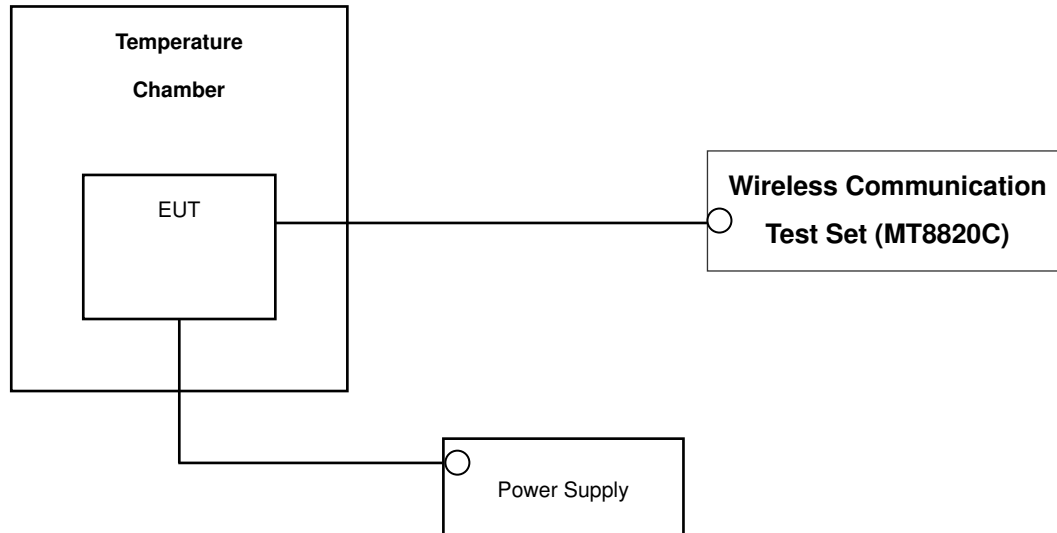

\* Nominal Operating Voltage

#### Test Procedure

Frequency stability is tested in accordance with ANSI/TIA-603-D-2010 section 2.2.2.

The frequency stability of the transmitter is measured by:

- a.) **Temperature:** The temperature is varied from - 30 °C to + 50 °C using an environmental chamber.
- b.) **Primary Supply Voltage:** The primary supply voltage is varied from battery end point to 100 % of the voltage normally at the input to the device or at the power supply terminals if cables are not normally supplied.

Specification — the frequency stability shall be sufficient to ensure that the fundamental emission stays within the authorized frequency block .

#### Time Period and Procedure:

The carrier frequency of the transmitter is measured at room temperature (20°C to provide a reference).

1. The equipment is turned on in a "standby" condition for one minute before applying power to the transmitter. Measurement of the carrier frequency of the transmitter is made within one minute after applying power to the transmitter.
2. Frequency measurements are made at 10°C intervals ranging from -30°C to +50°C. A period of at least one half-hour is provided to allow stabilization of the equipment at each temperature level.

**NOTE: The EUT is tested down to the battery endpoint.**

## 4. LIST OF TEST EQUIPMENT

Manufacture	Model/ Equipment	Serial Number	Calibration Date	Calibration Interval	Calibration Due
REOHDE & SCHWARZ	SCU 18 / AMPLIFIER	10094	09/07/2016	Annual	09/07/2017
Wainwright	WHK1.2/15G-10EF/H.P.F	4	04/11/2016	Annual	04/11/2017
Wainwright	WHK3.3/18G-10EF/H.P.F	2	04/11/2016	Annual	04/11/2017
Hewlett Packard	11667B / Power Splitter	10545	02/15/2016	Annual	02/15/2017
Hewlett Packard	11667B / Power Splitter	11275	04/29/2016	Annual	04/29/2017
Agilent	E3632A/DC Power Supply	KR75303243	07/12/2016	Annual	07/12/2017
Schwarzbeck	UHAP/ Dipole Antenna	557	03/23/2015	Biennial	03/23/2017
Schwarzbeck	UHAP/ Dipole Antenna	558	03/23/2015	Biennial	03/23/2017
EXP	EX-TH400/ Chamber	None	05/31/2016	Annual	05/31/2017
Schwarzbeck	BBHA 9120D/ Horn Antenna	147	09/09/2016	Biennial	09/09/2018
Schwarzbeck	BBHA 9120D/ Horn Antenna	1299	05/15/2015	Biennial	05/15/2017
Schwarzbeck	BBHA 9170/ Horn Antenna(15~40GHz)	BBHA9170342	04/30/2015	Biennial	04/30/2017
Schwarzbeck	BBHA 9170/ Horn Antenna(15~35GHz)	BBHA9170124	04/30/2015	Biennial	04/30/2017
Agilent	N9020A/Signal Analyzer	MY52090906	05/13/2016	Annual	05/13/2017
Hewlett Packard	8493C/ATTENUATOR	17280	06/22/2016	Annual	06/22/2017
REOHDE & SCHWARZ	FSV40/Spectrum Analyzer	1307.9002K40-100931-NK	06/15/2016	Annual	06/15/2017
Agilent	8960 (E5515C)/ Base Station(Now)	MY48360800	10/19/2016	Annual	10/19/2017
Schwarzbeck	FMZB1513/ Loop Antenna(9kHz~30MHz)	1513-175	02/23/2016	Biennial	02/23/2018
Schwarzbeck	VULB9160/ Bilog Antenna	3150	09/30/2016	Biennial	09/30/2018
Schwarzbeck	VULB9160/ Bilog Antenna	3368	10/14/2016	Biennial	10/14/2018
Anritsu Corp.	MT8820C/Wideband Radio Communication Tester	6200863156	02/26/2016	Annual	02/26/2017
Anritsu Corp.	MT8820C/Wideband Radio Communication Tester	6201026545	02/16/2016	Annual	02/16/2017

## 5. MEASUREMENT UNCERTAINTY

The measurement uncertainties shown below were calculated in accordance with the requirements of ANSI C63.4:2014.

All measurement uncertainty values are shown with a coverage factor of  $k = 2$  to indicate a 95 % level of confidence. The measurement data shown herein meets or exceeds the  $U_{\text{CISPR}}$  measurement uncertainty values specified in CISPR 16-4-2 and, thus, can be compared directly to specified limits to determine compliance.

Parameter	Expanded Uncertainty ( $\pm$ dB)
Conducted Disturbance (150 kHz ~ 30 MHz)	1.82
Radiated Disturbance (9 kHz ~ 30 MHz)	3.40
Radiated Disturbance (30 MHz ~ 1 GHz)	4.80
Radiated Disturbance (1 GHz ~ 18 GHz)	6.07

## 6. SUMMARY OF TEST RESULTS

FCC Part Section(s)	Test Description	Test Limit	Test Condition	Test Result
2.1049	Occupied Bandwidth	N/A	CONDUCTED	PASS
2.1051, 27.53(m)(4)	Band Edge / Conducted Spurious Emissions.	< 40 + 10log10 (P[Watts]) at Channel edges < 43 + 10log10 (P[Watts]) between 5 and X MHz from Channel edges < 55 + 10log10 (P[Watts]) beyond X MHz beyond from Channel edges		PASS
2.1046	* Conducted Output Power	N/A		PASS
2.1055, 27.54	Frequency stability	Emission must remain in band		PASS
27.50(h)(2)	Equivalent Isotropic Radiated Power	< 2 Watts max. EIRP	RADIATED	PASS
2.1053, 27.53(m)(4)	Undesirable Emissions	< 40 + 10log10 (P[Watts]) at Channel edges < 43 + 10log10 (P[Watts]) between 5 and X MHz from Channel edges < 55 + 10log10 (P[Watts]) beyond X MHz beyond from Channel edges		PASS

\*: See SAR Report

## 7. SAMPLE CALCULATION

### A. EIRP Sample Calculation

Mode	Ch./ Freq.		Measured Level(dBm)	Substitute LEVEL(dBm)	Ant. Gain (dBi)	C.L	Pol.	Limit W	EIRP	
	channel	Freq.(MHz)							W	dBm
LTE Band7	21100	2,535.00	-15.36	19.46	10.72	1.78	V	< 2.00	0.69	28.40

#### EIRP = Substitute LEVEL(dBm) + Ant. Gain – CL(Cable Loss)

- 1) The EUT mounted on a wooden tripod is 2.5 meter above test site ground level.
- 2) During the test , the turn table is rotated until the maximum signal is found.
- 3) Record the field strength meter's level.
- 4) Replace the EUT with dipole/Horn antenna that is connected to a calibrated signal generator.
- 5) Increase the signal generator output till the field strength meter's level is equal to the item (3).
- 6) The signal generator output level with Ant. Gain and cable loss are the rating of Equivalent Isotropic Radiated Power (**EIRP**).

## B. Emission Designator

### QPSK Modulation

**Emission Designator = 4M48G7D**

LTE BW = 4.48 MHz

G = Phase Modulation

7 = Quantized/Digital Info

D = Data transmission; telemetry; telecommand

### 16QAM Modulation

**Emission Designator = 4M48W7D**

LTE BW = 4.48 MHz

W = main carrier modulated in a combination of two

or more of the following modes;

amplitude, angle, pulse

7 = Quantized/Digital Info

D = Data transmission; telemetry; telecommand

## 8. TEST DATA

### 8.1 EQUIVALENT ISOTROPIC RADIATED POWER (Band 7)

Freq (MHz)	Bandwidth	Modulation	Measured Level (dBm)	Substitute Level (dBm)	Ant. Gain(dBi)	C.L	Pol	Limit	EIRP	
								W	W	dBm
2502.5	5 MHz	QPSK	-24.83	11.60	10.95	2.87	V	< 2.00	0.093	19.68
		16-QAM	-25.61	10.82	10.95	2.87	V		0.078	18.90
2535.0		QPSK	-25.08	11.41	10.98	2.95	V		0.088	19.44
		16-QAM	-25.91	10.58	10.98	2.95	V		0.073	18.61
2567.5		QPSK	-26.74	10.04	11.00	2.97	V		0.064	18.07
		16-QAM	-27.56	9.22	11.00	2.97	V		0.053	17.25

Equivalent Isotropic Radiated Power Data (5 MHz Band 7 LTE)

Note: All of RB size has been tested for emissions and EIRP, with the 1RB configuration observed as the worst case

Freq (MHz)	Bandwidth	Modulation	Measured Level (dBm)	Substitute Level (dBm)	Ant. Gain(dBi)	C.L	Pol	Limit	EIRP	
								W	W	dBm
2505.0	10 MHz	QPSK	-23.96	12.44	10.95	2.88	V	< 2.00	0.113	20.51
		16-QAM	-24.76	11.64	10.95	2.88	V		0.094	19.71
2535.0		QPSK	-25.13	11.36	10.98	2.95	V		0.087	19.39
		16-QAM	-25.97	10.52	10.98	2.95	V		0.072	18.55
2565.0		QPSK	-26.56	10.22	11.00	2.97	V		0.067	18.25
		16-QAM	-27.44	9.34	11.00	2.97	V		0.055	17.37

Equivalent Isotropic Radiated Power Data (10 MHz Band 7 LTE)

Note: All of RB size has been tested for emissions and EIRP, with the 1RB configuration observed as the worst case

Freq (MHz)	Bandwidth	Modulation	Measured Level (dBm)	Substitute Level (dBm)	Ant. Gain(dBi)	C.L	Pol	Limit	EIRP	
								W	W	dBm
2507.5	15 MHz	QPSK	-23.89	12.42	10.96	2.89	V	< 2.00	0.112	20.49
		16-QAM	-24.67	11.64	10.96	2.89	V		0.094	19.71
2535.0		QPSK	-25.08	11.41	10.98	2.95	V		0.088	19.44
		16-QAM	-25.93	10.56	10.98	2.95	V		0.072	18.59
2562.5		QPSK	-26.14	10.67	11.00	2.97	V		0.074	18.70
		16-QAM	-26.99	9.82	11.00	2.97	V		0.061	17.85

Equivalent Isotropic Radiated Power Data (15 MHz Band 7 LTE)

Note: All of RB size has been tested for emissions and EIRP, with the 1RB configuration observed as the worst case

Freq (MHz)	Bandwidth	Modulation	Measured Level (dBm)	Substitute Level (dBm)	Ant. Gain(dBi)	C.L	Pol	Limit	EIRP	
								W	W	dBm
2510.0	20 MHz	QPSK	-23.86	12.51	10.96	2.89	V	< 2.00	0.114	20.58
		16-QAM	-24.67	11.70	10.96	2.89	V		0.095	19.77
2535.0		QPSK	-25.04	11.45	10.98	2.95	V		0.089	19.48
		16-QAM	-25.90	10.59	10.98	2.95	V		0.073	18.62
2560.0		QPSK	-26.21	10.60	11.00	2.97	V		0.073	18.63
		16-QAM	-27.01	9.80	11.00	2.97	V		0.061	17.83

Equivalent Isotropic Radiated Power Data (20 MHz Band 7 LTE)

Note: All of RB size has been tested for emissions and EIRP, with the 1RB configuration observed as the worst case

NOTES:

Equivalent Isotropic Radiated Power Measurements by Substitution Method

according to ANSI/TIA/EIA-603-D-2010 June 24, 2010:

The EUT was placed on a non-conductive styrofoam resin table 3-meters from the receive antenna. The receive antenna height and turntable rotation was adjusted for the highest reading on the receive spectrum analyzer. For 5 MHz, 10MHz BW signals, RBW = 1-5% of the OBW, not to exceed 1MHz, VBW ≥ 3 x RBW, Detector = RMS. A Horn antenna was substituted in place of the EUT. This dipole antenna was driven by a signal generator and the level of the signal generator was adjusted to obtain the same receive spectrum analyzer reading. The conducted power at the terminals of the Horn antenna is measured. The difference between the gain of the horn and an isotropic antenna is taken into consideration and the EIRP is recorded.

Also, we have done x, y, z planes in EUT and horizontal and vertical polarization in detecting antenna. The worst case of the EUT is z plane in LTE mode. Also worst case of detecting Antenna is vertical polarization in LTE mode.

## 8.2 RADIATED SPURIOUS EMISSIONS

### 8.2.1 RADIATED SPURIOUS EMISSIONS (5 MHz Band 7 LTE)

- ▣ OPERATING FREQUENCY : 2502.50 MHz
- ▣ MEASURED OUTPUT POWER: 19.68 dBm = 0.093 W
- ▣ MODULATION SIGNAL: 5 MHz QPSK
- ▣ DISTANCE: 3 meters
- ▣ LIMIT:  $55 + 10 \log_{10}(W) =$  44.68 dBc

Ch	Freq (MHz)	Measured Level (dBm)	Ant. Gain (dBi)	Substitute Level (dBm)	C.L	Pol	EIRP (dBm)	dBc
20775 (2502.5)	5,005.00	-60.65	12.57	-62.62	2.45	H	-52.50	72.18
	7,507.50	-52.26	11.71	-47.78	3.96	V	-40.03	59.71
	10,010.00	-65.21	11.01	-55.12	4.92	V	-49.03	68.71
21100 (2535.0)	5,070.00	-60.36	12.67	-61.37	2.49	V	-51.19	70.87
	7,605.00	-53.66	11.64	-49.44	3.94	H	-41.74	61.42
	10,140.00	-65.39	10.94	-55.59	5.00	H	-49.65	69.33
21425 (2567.5)	5,135.00	-61.29	12.75	-62.14	2.49	V	-51.88	71.56
	7,702.50	-53.03	11.56	-49.04	3.94	H	-41.42	61.10
	10,270.00	-64.28	10.87	-54.41	5.02	H	-48.56	68.24

- NOTES: 1. Radiated Spurious Emission Measurements at 1 meter and 3 meter by Substitution Method according to ANSI/TIA/EIA-603-D-2010 June 24, 2010:
2. We are performed all frequency to 10<sup>th</sup> harmonics from 9 kHz. Measurements above show only up to 3 maximum emissions noted, or would be lesser if no specific emissions from the EUT are recorded (ie: margin > 20 dB from the applicable limit) and considered that's already beyond the background noise floor.
3. We have done x, y, z planes in EUT and horizontal and vertical polarization in detecting antenna.
4. All of RB size has been tested for emissions and EIRP, with the 1RB configuration observed as the worst case
5. We are performed 16QAM and QPSK modulations. The worst case data are reported in the table above.



### 8.2.2 RADIATED SPURIOUS EMISSIONS (10 MHz Band 7 LTE)

- ▣ OPERATING FREQUENCY : 2505.00 MHz
- ▣ MEASURED OUTPUT POWER: 20.51 dBm = 0.113 W
- ▣ MODULATION SIGNAL: 10 MHz QPSK
- ▣ DISTANCE: 3 meters
- ▣ LIMIT:  $55 + 10 \log_{10}(W) =$  45.51 dBc

Ch	Freq (MHz)	Measured Level (dBm)	Ant. Gain (dBi)	Substitute Level (dBm)	C.L	Pol	EIRP (dBm)	dBc
20800 (2505.0)	5,010.00	-59.12	12.58	-61.02	2.45	V	-50.89	71.40
	7,515.00	-52.17	11.70	-47.82	3.95	V	-40.07	60.58
	10,020.00	-65.53	11.01	-55.44	4.92	V	-49.35	69.86
21100 (2535.0)	5,070.00	-61.08	12.67	-62.09	2.49	V	-51.91	72.42
	7,605.00	-54.58	11.64	-50.36	3.94	V	-42.66	63.18
	10,140.00	-66.00	10.94	-56.20	5.00	V	-50.26	70.78
21400 (2565.0)	5,130.00	-63.20	12.76	-64.08	2.49	H	-53.81	74.33
	7,695.00	-53.82	11.57	-49.75	3.95	H	-42.13	62.65
	10,260.00	-64.43	10.87	-54.42	5.03	V	-48.58	69.10

- NOTES:
1. Radiated Spurious Emission Measurements at 1 meter and 3 meter by Substitution Method according to ANSI/TIA/EIA-603-D-2010 June 24, 2010:
  2. We are performed all frequency to 10<sup>th</sup> harmonics from 9 kHz. Measurements above show only up to 3 maximum emissions noted, or would be lesser if no specific emissions from the EUT are recorded (ie: margin > 20 dB from the applicable limit) and considered that's already beyond the background noise floor.
  3. We have done x, y, z planes in EUT and horizontal and vertical polarization in detecting antenna.
  4. All of RB size has been tested for emissions and EIRP, with the 1RB configuration observed as the worst case
  5. We are performed 16QAM and QPSK modulations. The worst case data are reported in the table above.

### 8.2.3 RADIATED SPURIOUS EMISSIONS (15 MHz Band 7 LTE)

- ▣ OPERATING FREQUENCY : 2507.50 MHz
- ▣ MEASURED OUTPUT POWER: 20.49 dBm = 0.112 W
- ▣ MODULATION SIGNAL: 15 MHz QPSK
- ▣ DISTANCE: 3 meters
- ▣ LIMIT:  $55 + 10 \log_{10}(W) =$  45.49 dBc

Ch	Freq (MHz)	Measured Level (dBm)	Ant. Gain (dBi)	Substitute Level (dBm)	C.L	Pol	EIRP (dBm)	dBc
20825 (2507.5)	5,015.00	-59.04	12.59	-60.80	2.45	V	-50.66	71.15
	7,522.50	-51.88	11.70	-47.60	3.98	V	-39.88	60.37
	10,030.00	-64.69	11.00	-54.23	5.11	H	-48.34	68.83
21100 (2535.0)	5,070.00	-61.90	12.67	-62.91	2.49	V	-52.73	73.22
	7,605.00	-54.35	11.64	-50.13	3.94	H	-42.43	62.92
	10,140.00	-65.37	10.94	-55.57	5.00	H	-49.63	70.12
21375 (2562.5)	5,125.00	-61.56	12.75	-62.50	2.50	V	-52.25	72.74
	7,687.50	-55.58	11.57	-51.43	3.96	V	-43.82	64.31
	10,250.00	-63.85	10.88	-54.48	5.01	H	-48.61	69.10

- NOTES:
1. Radiated Spurious Emission Measurements at 1 meter and 3 meter by Substitution Method according to ANSI/TIA/EIA-603-D-2010 June 24, 2010:
  2. We are performed all frequency to 10<sup>th</sup> harmonics from 9 kHz. Measurements above show only up to 3 maximum emissions noted, or would be lesser if no specific emissions from the EUT are recorded (ie: margin > 20 dB from the applicable limit) and considered that's already beyond the background noise floor.
  3. We have done x, y, z planes in EUT and horizontal and vertical polarization in detecting antenna.
  4. All of RB size has been tested for emissions and EIRP, with the 1RB configuration observed as the worst case
  5. We are performed 16QAM and QPSK modulations. The worst case data are reported in the table above.

### 8.2.4 RADIATED SPURIOUS EMISSIONS (20 MHz Band 7 LTE)

- ▣ OPERATING FREQUENCY : 2510.00 MHz
- ▣ MEASURED OUTPUT POWER: 20.58 dBm = 0.114 W
- ▣ MODULATION SIGNAL: 20 MHz QPSK
- ▣ DISTANCE: 3 meters
- ▣ LIMIT:  $55 + 10 \log_{10}(W) =$  45.58 dBc

Ch	Freq (MHz)	Measured Level (dBm)	Ant. Gain (dBi)	Substitute Level (dBm)	C.L	Pol	EIRP (dBm)	dBc
20850 (2510.0)	5,020.00	-59.12	12.60	-60.73	2.46	V	-50.59	71.17
	7,530.00	-51.83	11.69	-47.53	3.98	V	-39.82	60.40
	10,040.00	-64.45	11.00	-53.93	5.01	H	-47.94	68.51
21100 (2535.0)	5,070.00	-62.40	12.67	-63.41	2.49	V	-53.23	73.80
	7,605.00	-54.62	11.64	-50.40	3.94	H	-42.70	63.28
	10,140.00	-65.08	10.94	-55.28	5.00	H	-49.34	69.92
21350 (2560.0)	5,120.00	-59.77	12.75	-60.78	2.50	V	-50.53	71.11
	7,680.00	-54.06	11.58	-49.99	3.95	H	-42.36	62.94
	10,240.00	-63.72	10.88	-54.47	5.03	H	-48.62	69.20

- NOTES:**
1. Radiated Spurious Emission Measurements at 1 meter and 3 meter by Substitution Method according to ANSI/TIA/EIA-603-D-2010 June 24, 2010:
  2. We are performed all frequency to 10<sup>th</sup> harmonics from 9 kHz. Measurements above show only up to 3 maximum emissions noted, or would be lesser if no specific emissions from the EUT are recorded (ie: margin > 20 dB from the applicable limit) and considered that's already beyond the background noise floor.
  3. We have done x, y, z planes in EUT and horizontal and vertical polarization in detecting antenna.
  4. All of RB size has been tested for emissions and EIRP, with the 1RB configuration observed as the worst case
  5. We are performed 16QAM and QPSK modulations. The worst case data are reported in the table above.

**8.3 OCCUPIED BANDWIDTH**

Band	Band Width	Frequency (MHz)	Modulation	Resource Block Size	Resource Block Offset	Data ( MHz )
7	5 MHz	2535.0	QPSK	25	0	4.5254
			16-QAM	25	0	4.4979
	10 MHz		QPSK	50	0	8.9785
			16-QAM	50	0	9.0017
	15 MHz		QPSK	75	0	13.454
			16-QAM	75	0	13.478
	20 MHz		QPSK	100	0	17.985
			16-QAM	100	0	17.958

- Plots of the EUT's Occupied Bandwidth are shown Page 28 ~ 31.

## 8.4 CONDUCTED SPURIOUS EMISSIONS

### ■ FACTORS FOR FREQUENCY

Frequency Range (GHz)	Factor [dB]
0.03 – 1	27.145
1 – 5	26.960
5 – 10	27.542
10 – 15	28.439
15 – 20	29.144
Above 20	30.148

### NOTES:

Factor(dB) = Cable Loss + Attenuator + Power Splitter

Band	Band Width (MHz)	Frequency (MHz)	Frequency of Maximum Harmonic (GHz)	Factor (dB)	Measurement Maximum Data (dBm)	Result (dBm)	Limit (dBm)
7	5	2,502.5	3.7408	26.960	-59.057	-32.097	-25.00
		2,535.0	3.6576	26.960	-59.699	-32.739	
		2,567.5	3.7109	26.960	-60.112	-33.152	
	10	2,505.0	3.7094	26.960	-59.790	-32.830	
		2,535.0	3.6975	26.960	-59.667	-32.707	
		2,565.0	6.5344	27.542	-59.867	-32.325	
	15	2,507.5	6.2164	27.542	-60.394	-32.852	
		2,535.0	2.7628	26.960	-59.730	-32.770	
		2,562.5	3.7264	26.960	-59.798	-32.838	
	20	2,510.0	5.6800	27.542	-59.717	-32.175	
		2,535.0	3.6666	26.960	-59.385	-32.425	
		2,560.0	5.6282	27.542	-59.732	-32.190	

### NOTES:

1. Conducted Spurious Emissions was Tested QPSK Modulation, Resource Block Size 1 and Resource Block Offset 0
2. Result (dBm) = Measurement Maximum Data (dBm) + Factor (dB)

- Plots of the EUT's Conducted Spurious Emissions are shown Page 40 ~ 51.

**8.4.1 BAND EDGE**

Band	Band Width (MHz)	Frequency (MHz)	Modulation	Resource Block Size	Resource Block Offset	Channel Edge ~ -1MHz (Limit : -10 dBm)	-1MHz ~ -4MHz (Limit : -10 dBm)	-4MHz ~ -9.5MHz (Limit : -13 dBm)	-9.5MHz ~ (Limit : -25 dBm)
						Lower	Lower	Lower	Lower
7	5	2502.5	QPSK	25	0	-24.81	-21.28	-28.46	-41.86
	10	2505.0	QPSK	50	0	-26.46	-22.57	-26.78	-38.28
	15	2507.5	QPSK	75	0	-27.35	-24.30	-26.98	-33.43
	20	2510.0	QPSK	100	0	-28.29	-25.45	-27.23	-32.14

Band	Band Width (MHz)	Frequency (MHz)	Modulation	Resource Block Size	Resource Block Offset	Channel Edge ~±1MHz (Limit : -10 dBm)		±1 MHz ~ ±5 MHz (Limit : -10 dBm)		±5 MHz ~ ±6 MHz (Limit : -13 dBm)		±6 MHz ~ (Limit : -25 dBm)	
						Lower	Upper	Lower	Upper	Lower	Upper	Lower	Upper
7	5	2502.5	QPSK	25	0	-	-24.59	-	-20.19	-	-34.67	-	-37.15
		2535.0	QPSK	25	0	-24.61	-24.32	-20.86	-20.40	-34.18	-35.01	-36.76	-37.56
		2567.5	QPSK	25	0	-25.06	-25.25	-23.33	-22.42	-33.24	-33.19	-35.98	-36.03
	10	2505.0	QPSK	50	0	-	-26.07	-	-21.57	-	-26.34	-	-37.61
		2535.0	QPSK	50	0	-26.58	-26.37	-22.60	-22.41	-27.43	-26.95	-37.28	-38.16
		2565.0	QPSK	50	0	-28.11	-27.80	-24.90	-24.32	-27.78	-27.61	-37.19	-36.12
	15	2507.5	QPSK	75	0	-	-26.78	-	-23.54	-	-26.43	-	-38.08
		2535.0	QPSK	75	0	-27.40	-27.30	-24.25	-24.18	-27.40	-26.69	-38.50	-39.32
		2562.5	QPSK	75	0	-28.13	-27.64	-25.12	-24.64	-26.87	-27.22	-39.26	-38.03
	20	2510.0	QPSK	100	0	-	-28.03	-	-24.62	-	-26.84	-	-38.22
		2535.0	QPSK	100	0	-27.86	-28.16	-24.75	-25.17	-27.35	-26.85	-38.88	-39.63
		2560.0	QPSK	100	0	-27.55	-27.67	-24.54	-24.53	-25.80	-27.15	-40.28	-40.73

**NOTES:** Channel Edge was Tested QPSK Modulation and Full RB (Resource Block) Size

- Plots of the EUT's Band Edge are shown Page 32 ~ 39.

## 8.5 REQUENCY STABILITY / VARIATION OF AMBIENT TEMPERATURE

### 8.5.1 FREQUENCY STABILITY (5 MHz Band 7 LTE)

- ▣ OPERATING FREQUENCY: 2,535,000,000 Hz
- ▣ CHANNEL: 21100 (5 MHz)
- ▣ REFERENCE VOLTAGE: 3.85 VDC
- ▣ DEVIATION LIMIT: Emission must remain in band

Voltage (%)	Power (VDC)	Temp. (°C)	Frequency (Hz)	Frequency Error (Hz)	Deviation (%)	ppm
100%	3.85	+20(Ref)	2534 999 994	0.0	0.000 000	0.0000
100%		-30	2534 999 987	-6.9	0.000 000	-0.0027
100%		-20	2534 999 998	4.3	0.000 000	0.0017
100%		-10	2534 999 998	4.3	0.000 000	0.0017
100%		0	2534 999 986	-7.6	0.000 000	-0.0030
100%		+10	2534 999 998	4.6	0.000 000	0.0018
100%		+30	2534 999 984	-9.5	0.000 000	-0.0037
100%		+40	2535 000 001	7.7	0.000 000	0.0030
100%		+50	2534 999 987	-6.9	0.000 000	-0.0027
Batt. Endpoint		3.60	+20	2535 000 000	6.6	0.000 000

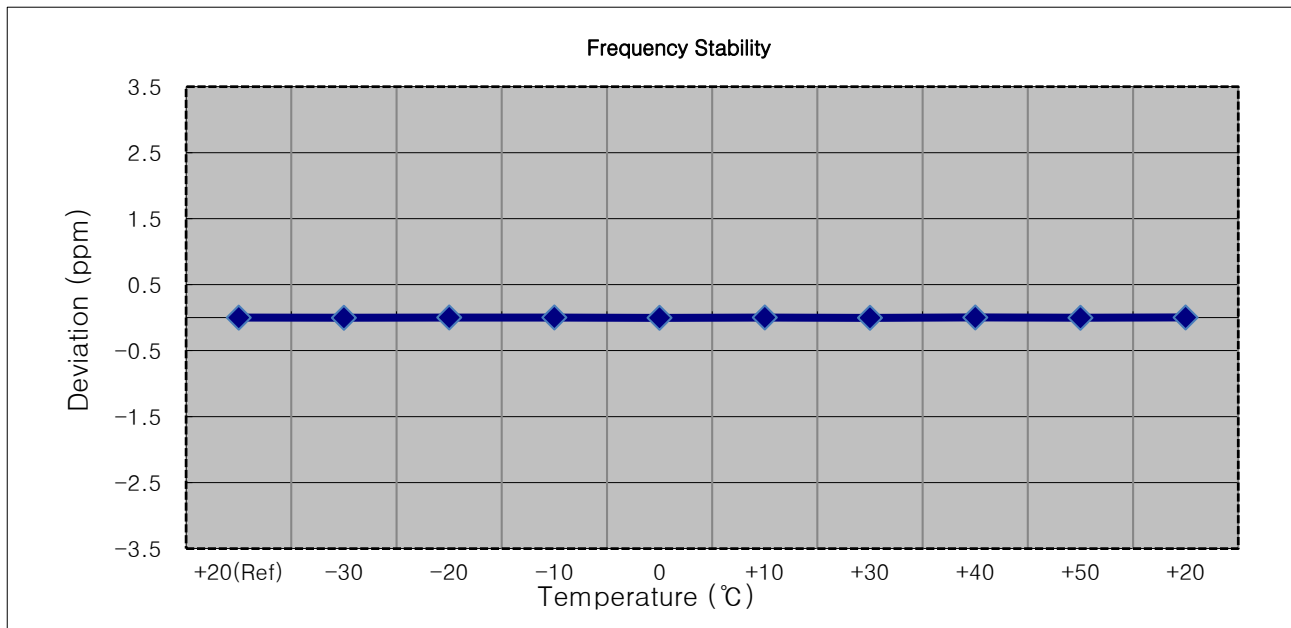

**8.5.2 FREQUENCY STABILITY (10 MHz Band 7 LTE)**

- ▣ OPERATING FREQUENCY: 2,535,000,000 Hz
- ▣ CHANNEL: 21100 (10 MHz)
- ▣ REFERENCE VOLTAGE: 3.85 VDC
- ▣ DEVIATION LIMIT: Emission must remain in band

Voltage (%)	Power (VDC)	Temp. (°C)	Frequency (Hz)	Frequency Error (Hz)	Deviation (%)	ppm
100%	3.85	+20(Ref)	2535 000 004	0.0	0.000 000	0.0000
100%		-30	2535 000 010	6.3	0.000 000	0.0025
100%		-20	2535 000 011	7.3	0.000 000	0.0029
100%		-10	2535 000 010	5.9	0.000 000	0.0023
100%		0	2535 000 010	6.2	0.000 000	0.0024
100%		+10	2535 000 008	4.1	0.000 000	0.0016
100%		+30	2535 000 009	5.1	0.000 000	0.0020
100%		+40	2535 000 013	8.8	0.000 000	0.0035
100%		+50	2535 000 011	7.2	0.000 000	0.0028
Batt. Endpoint	3.60	+20	2535 000 010	6.3	0.000 000	0.0025

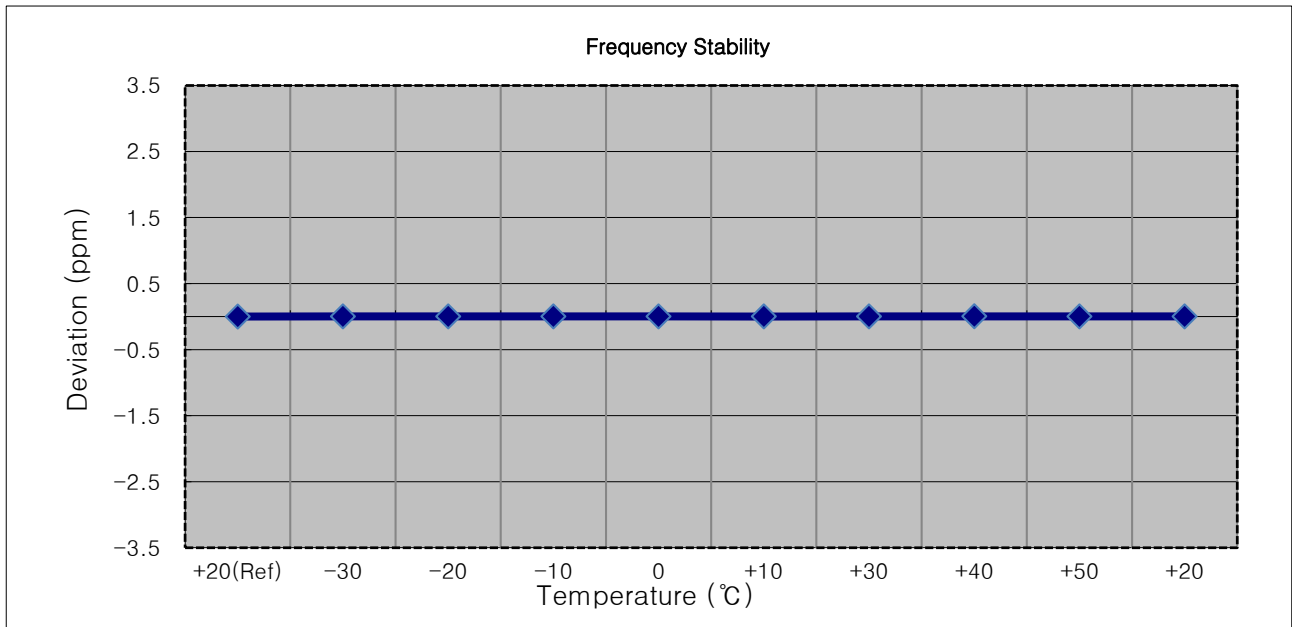



**8.5.3 FREQUENCY STABILITY (15 MHz Band 7 LTE)**

- ▣ OPERATING FREQUENCY: 2,535,000,000 Hz
- ▣ CHANNEL: 21100 (15 MHz)
- ▣ REFERENCE VOLTAGE: 3.85 VDC
- ▣ DEVIATION LIMIT: Emission must remain in band

Voltage (%)	Power (VDC)	Temp. (°C)	Frequency (Hz)	Frequency Error (Hz)	Deviation (%)	ppm
100%	3.85	+20(Ref)	2534 999 992	0.0	0.000 000	0.000
100%		-30	2534 999 985	-7.3	0.000 000	-0.003
100%		-20	2534 999 987	-5.3	0.000 000	-0.002
100%		-10	2534 999 985	-6.9	0.000 000	-0.003
100%		0	2534 999 986	-5.6	0.000 000	-0.002
100%		+10	2534 999 982	-9.6	0.000 000	-0.004
100%		+30	2534 999 999	6.7	0.000 000	0.003
100%		+40	2534 999 987	-4.9	0.000 000	-0.002
100%		+50	2534 999 986	-6.0	0.000 000	-0.002
Batt. Endpoint	3.60	+20	2534 999 987	-5.1	0.000 000	-0.002

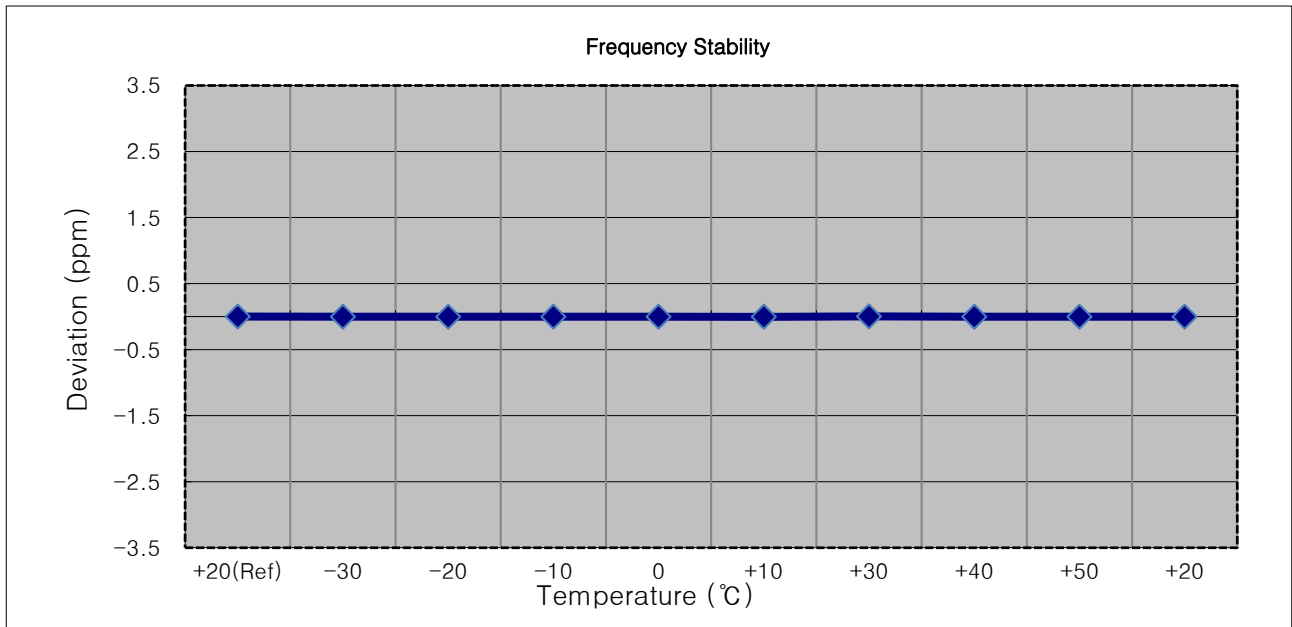

**8.5.4 FREQUENCY STABILITY (20 MHz Band 7 LTE)**

- ▣ OPERATING FREQUENCY: 2,535,000,000 Hz
- ▣ CHANNEL: 21100 (20 MHz)
- ▣ REFERENCE VOLTAGE: 3.85 VDC
- ▣ DEVIATION LIMIT: Emission must remain in band

Voltage (%)	Power (VDC)	Temp. (°C)	Frequency (Hz)	Frequency Error (Hz)	Deviation (%)	ppm
100%	3.85	+20(Ref)	2534 999 992	0.0	0.000 000	0.000
100%		-30	2534 999 984	-7.5	0.000 000	-0.003
100%		-20	2535 000 000	8.9	0.000 000	0.004
100%		-10	2534 999 997	5.4	0.000 000	0.002
100%		0	2534 999 985	-6.6	0.000 000	-0.003
100%		+10	2534 999 997	5.9	0.000 000	0.002
100%		+30	2534 999 988	-3.4	0.000 000	-0.001
100%		+40	2534 999 984	-7.9	0.000 000	-0.003
100%		+50	2534 999 983	-8.3	0.000 000	-0.003
Batt. Endpoint	3.60	+20	2534 999 986	-5.4	0.000 000	-0.002

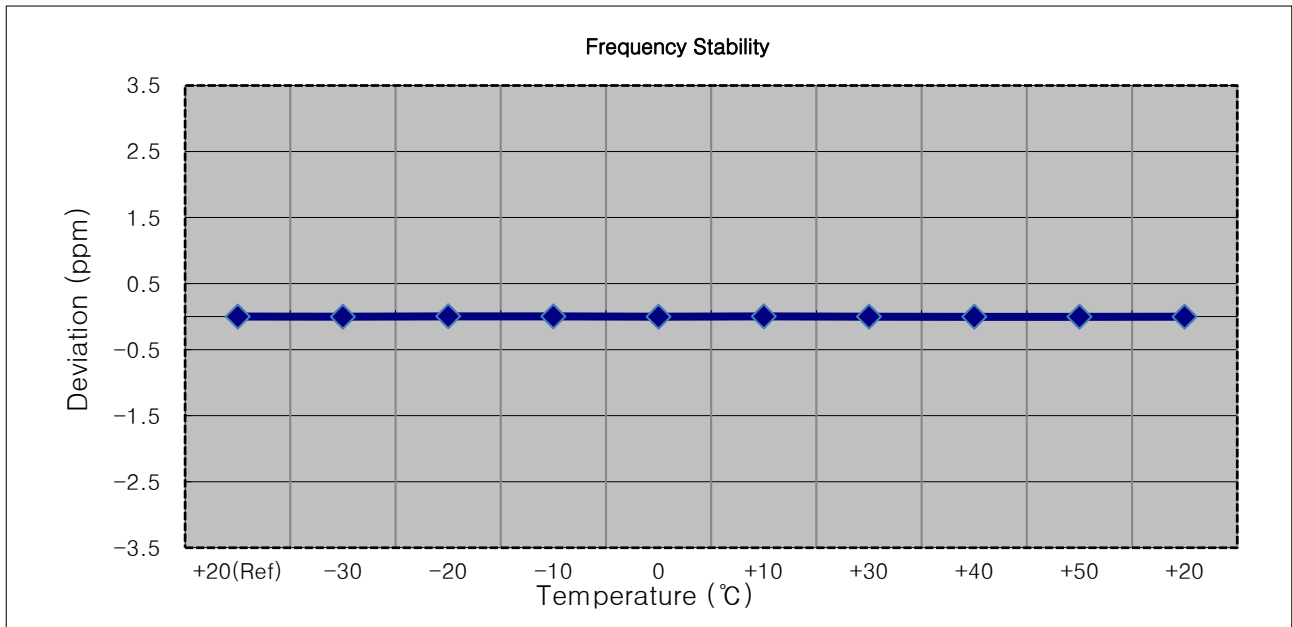

## 9. TEST PLOTS

BAND7. Occupied Bandwidth Plot (5MHz Ch.21100 QPSK RB 25)

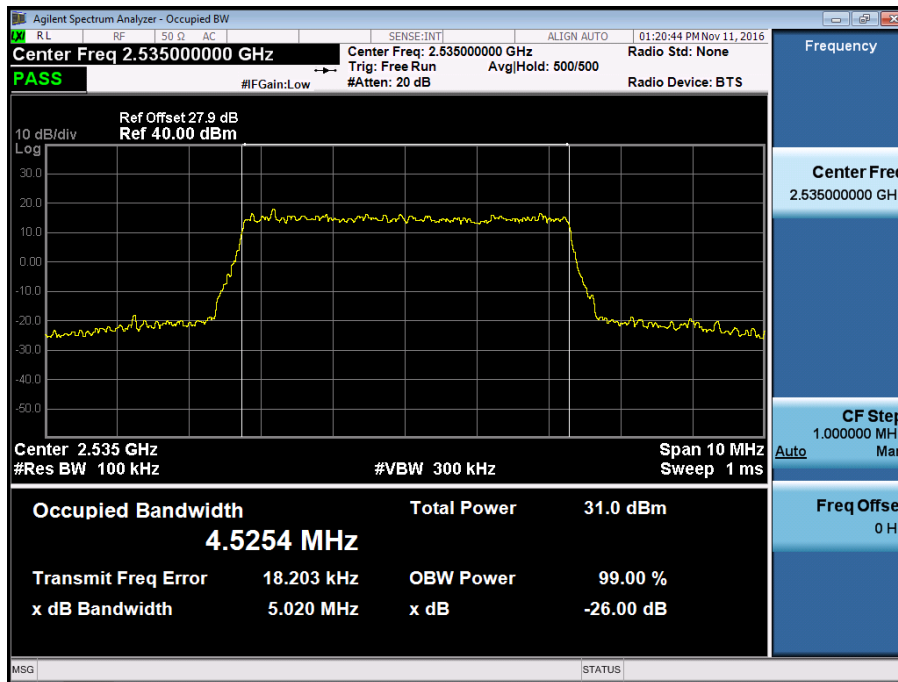

BAND7. Occupied Bandwidth Plot (5MHz Ch.21100 16-QAM RB 25)

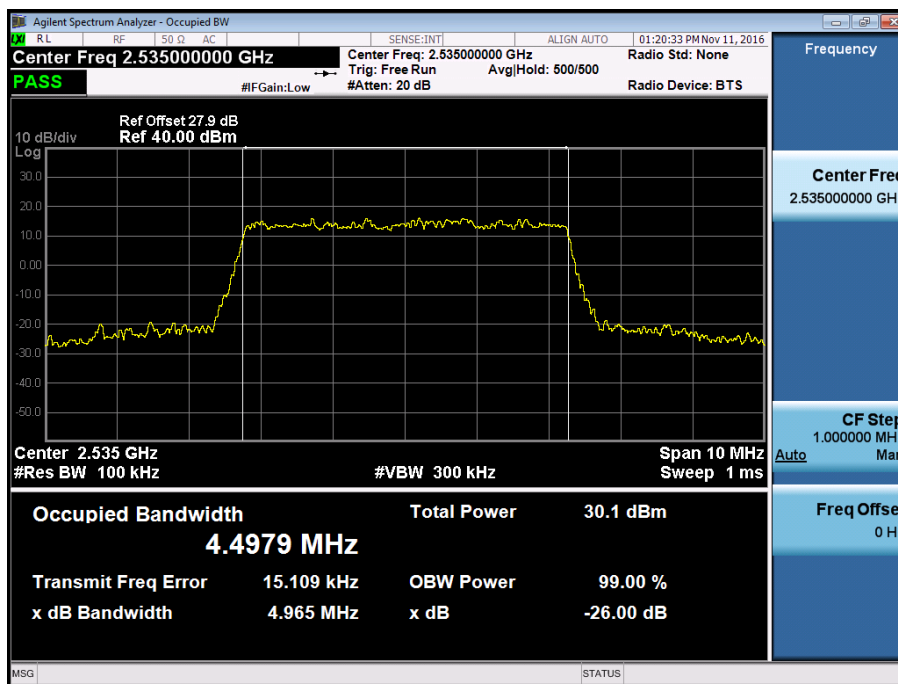

BAND7. Occupied Bandwidth Plot (10MHz Ch.21100 QPSK RB 50)

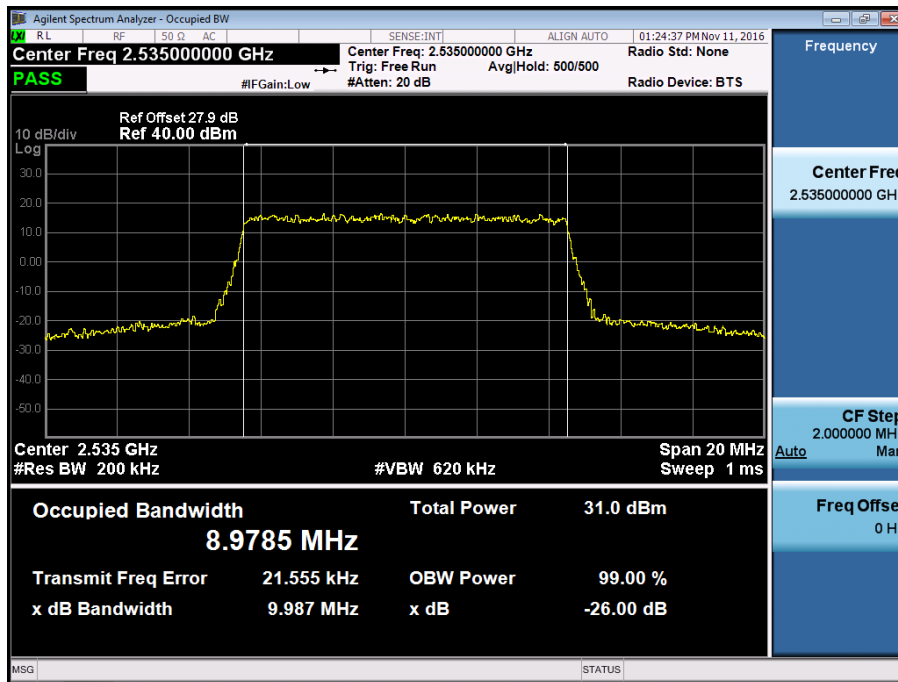

BAND7. Occupied Bandwidth Plot (10MHz Ch.21100 16-QAM RB 50)

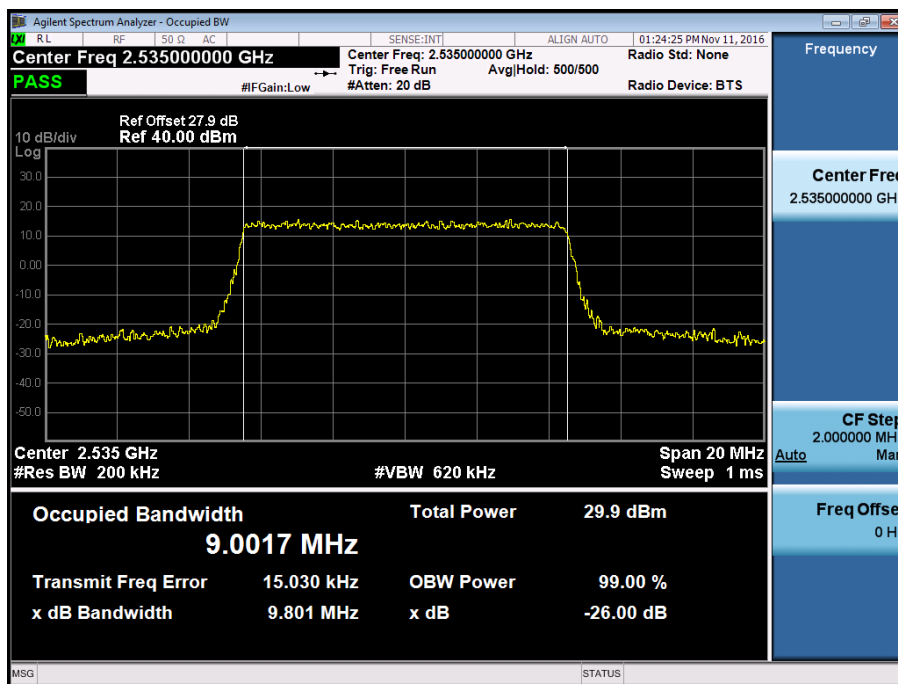

BAND7. Occupied Bandwidth Plot (15MHz Ch.21100 QPSK RB 75)

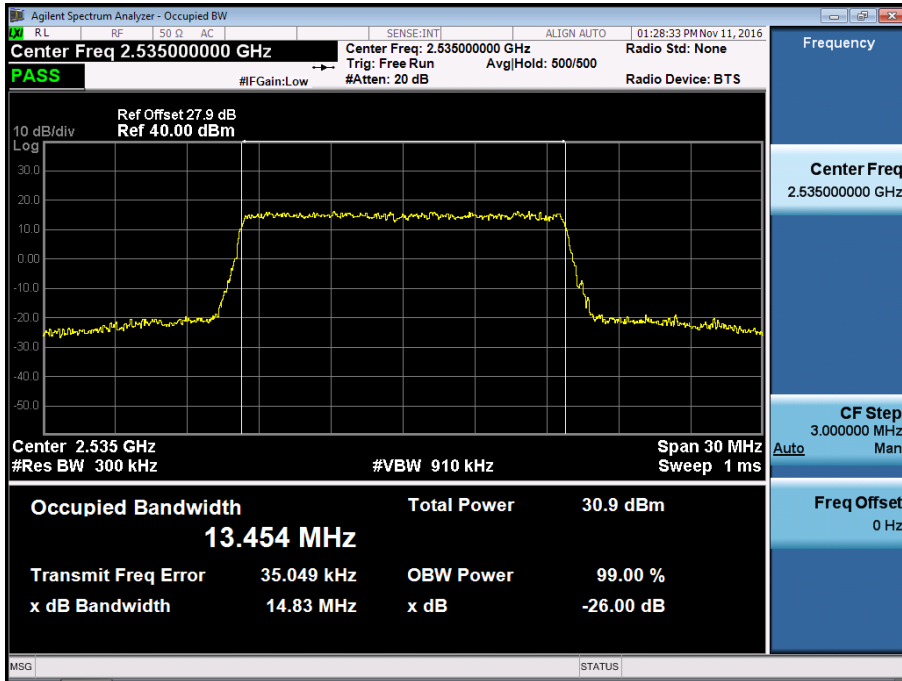

BAND7. Occupied Bandwidth Plot (15MHz Ch.21100 16-QAM RB 75)

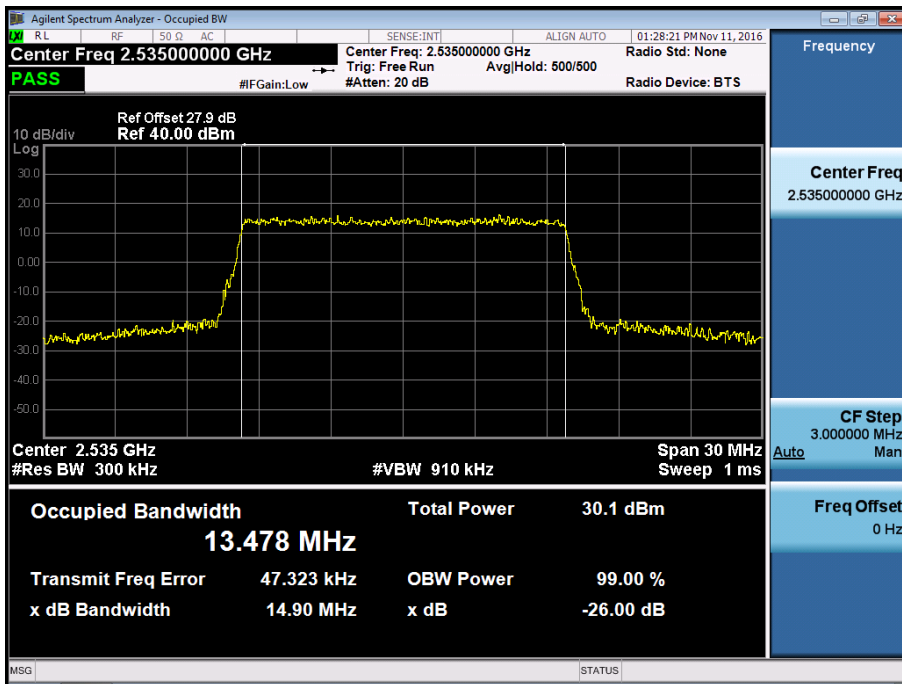

BAND7. Occupied Bandwidth Plot (20MHz Ch.21100 QPSK RB 100)

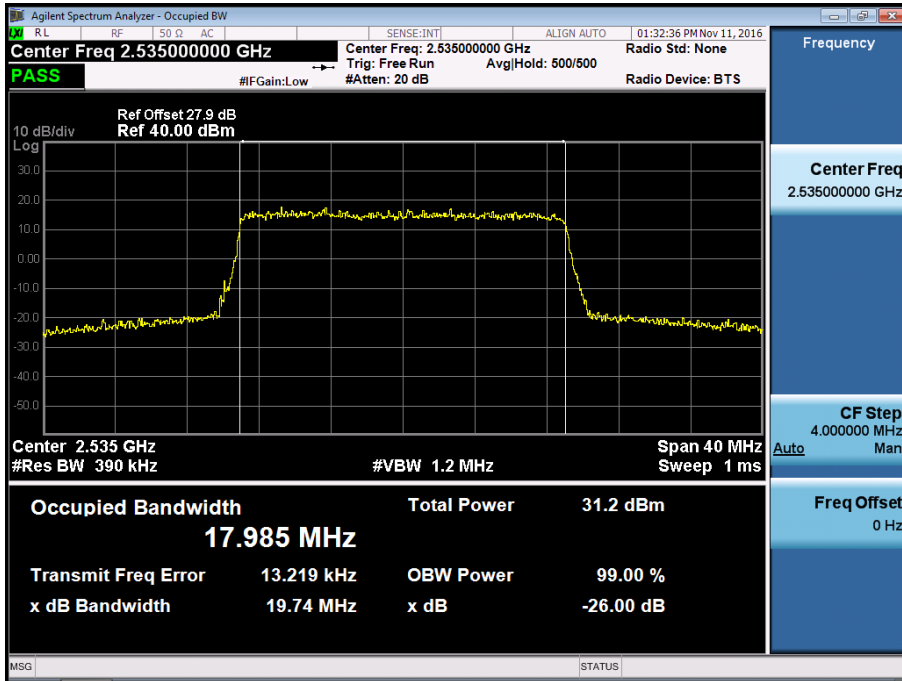

BAND7. Occupied Bandwidth Plot (20MHz Ch.21100 16-QAM RB 100)

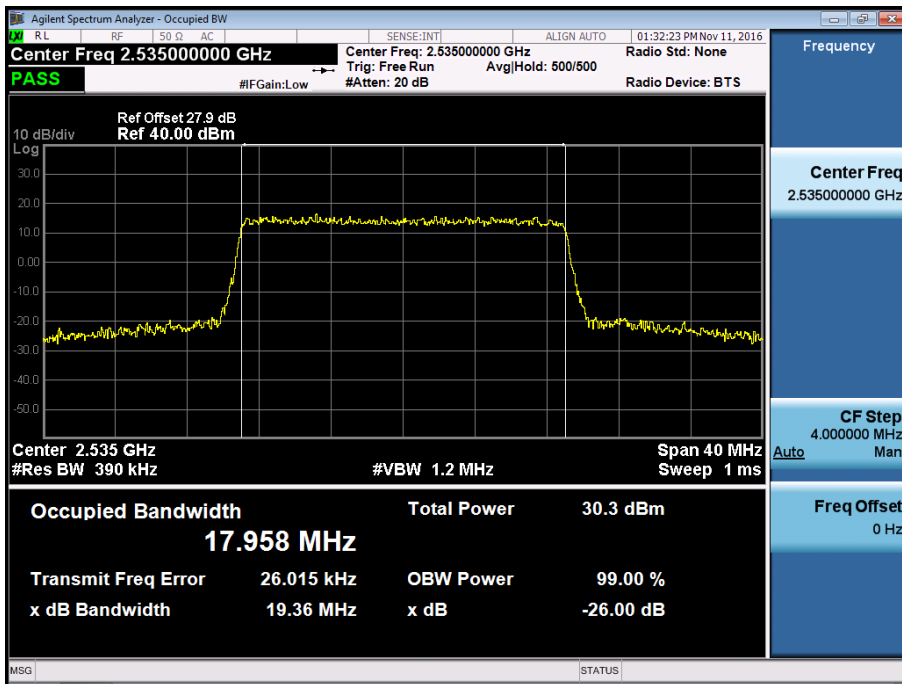

BAND7. Low Channel Edge Plot (5MHz Ch.20775 QPSK RB 25)-1



BAND7. Low Channel Edge Plot (5MHz Ch.20775 QPSK RB 25)-2

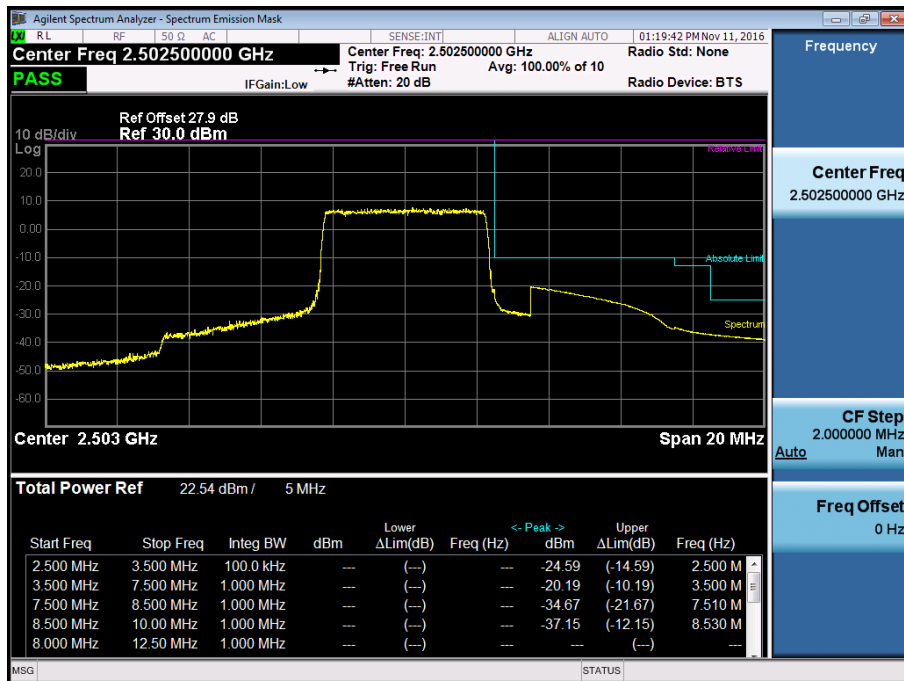



BAND7. Mid Channel Edge Plot (5MHz Ch.21100 QPSK RB 25)

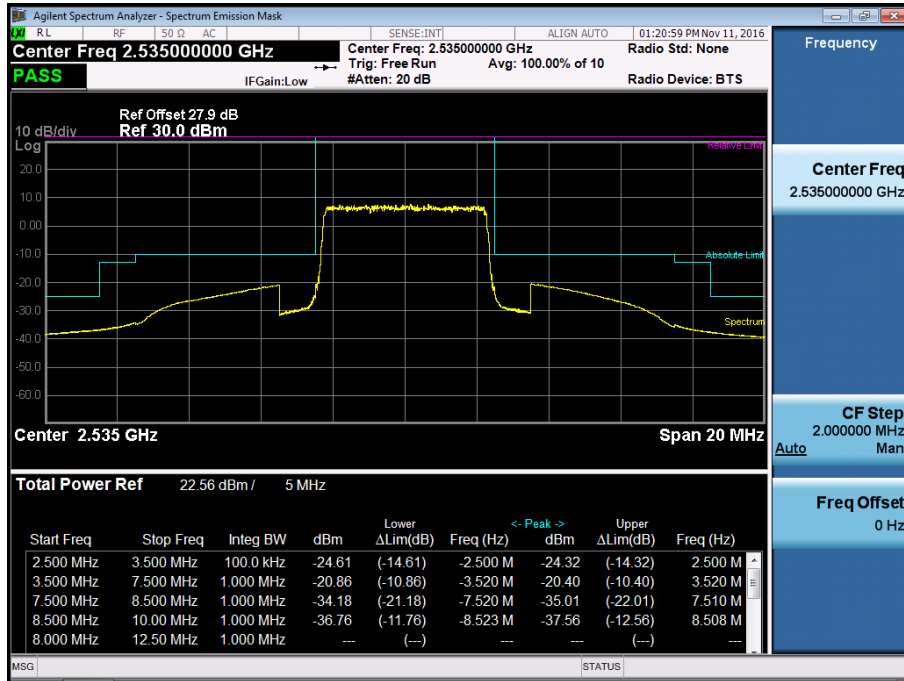

BAND7. High Channel Edge Plot (5MHz Ch.21425 QPSK RB 25)

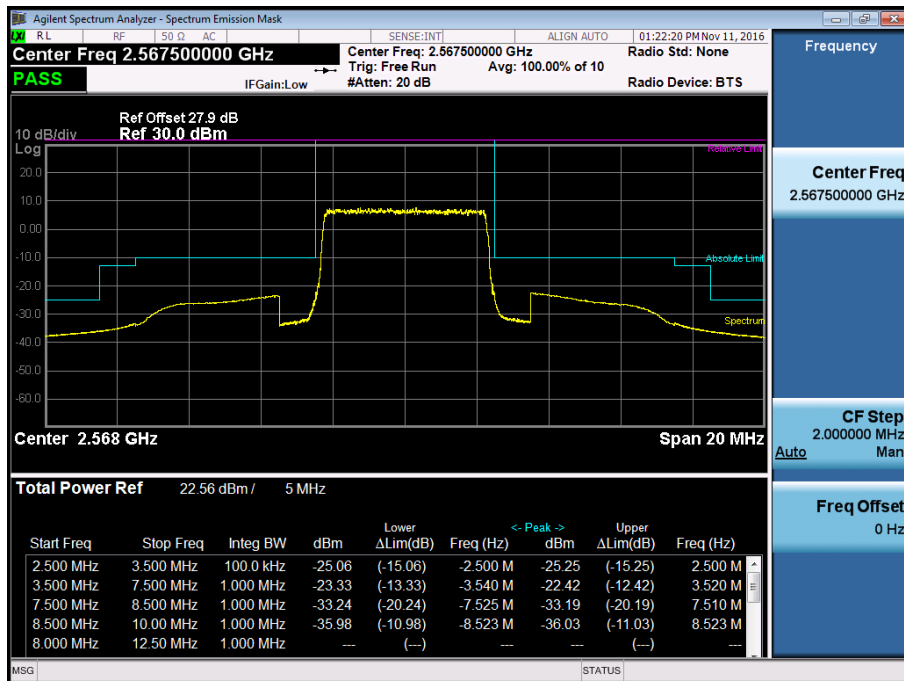

BAND7. Low Channel Edge Plot (10MHz Ch.20800 QPSK RB 50)-1



BAND7. Low Channel Edge Plot (10MHz Ch.20800 QPSK RB 50)-2

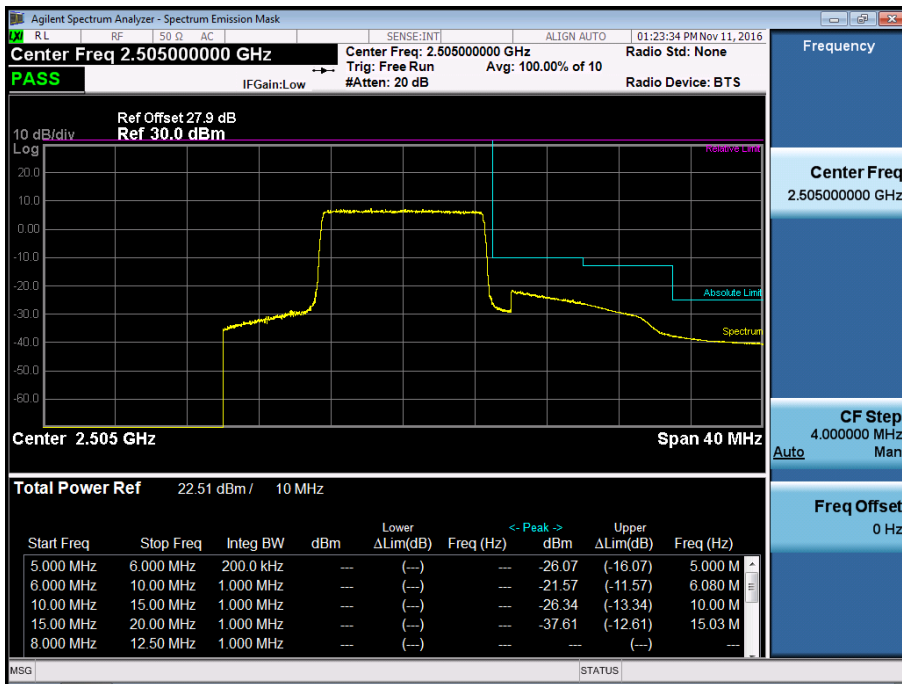

BAND7. Mid Channel Edge Plot (10MHz Ch.21100 QPSK RB 50)

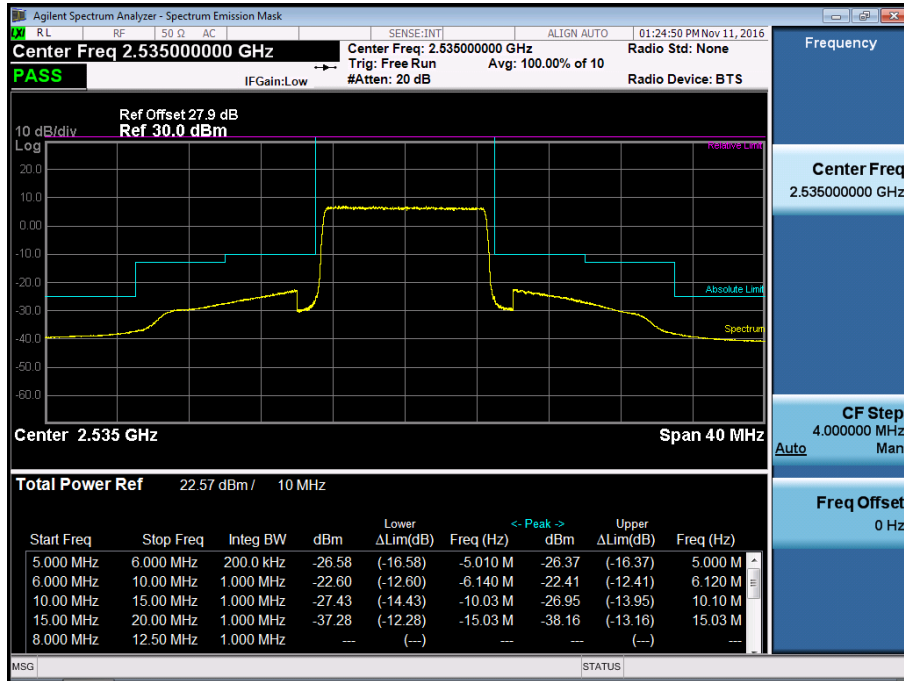

BAND7. High Channel Edge Plot (10MHz Ch.21400 QPSK RB 50)

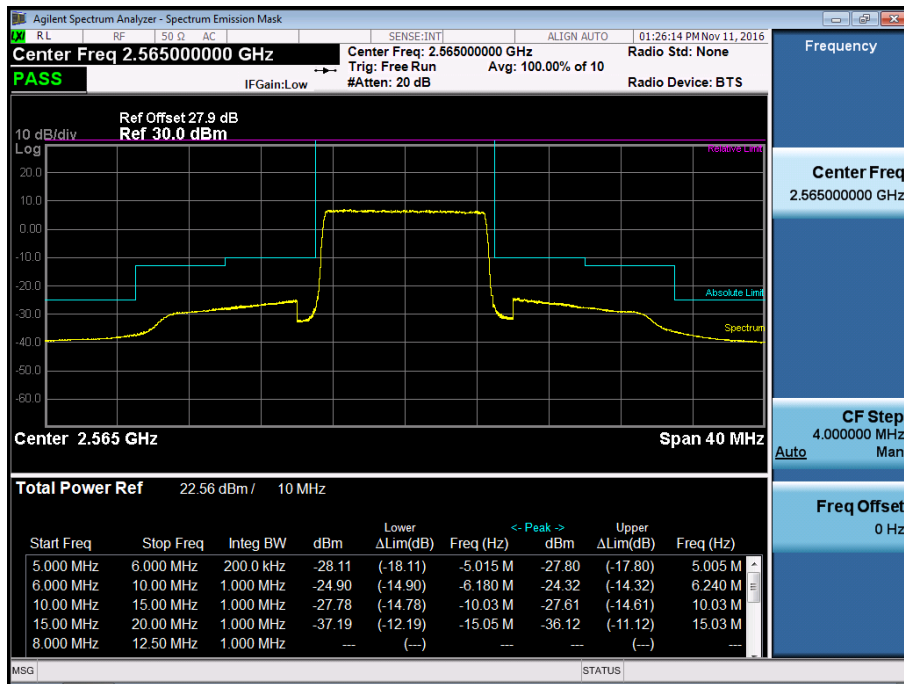

BAND7. Low Channel Edge Plot (15MHz Ch.20825 QPSK RB 75)-1



BAND7. Low Channel Edge Plot (15MHz Ch.20825 QPSK RB 75)-2

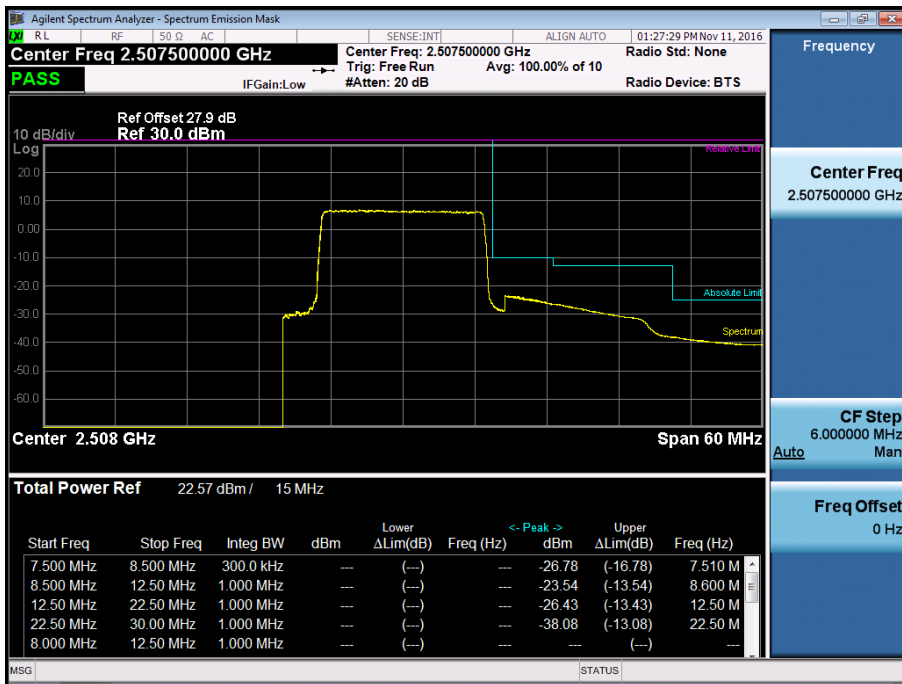

BAND7. Mid Channel Edge Plot (15MHz Ch.21100 QPSK RB 75)

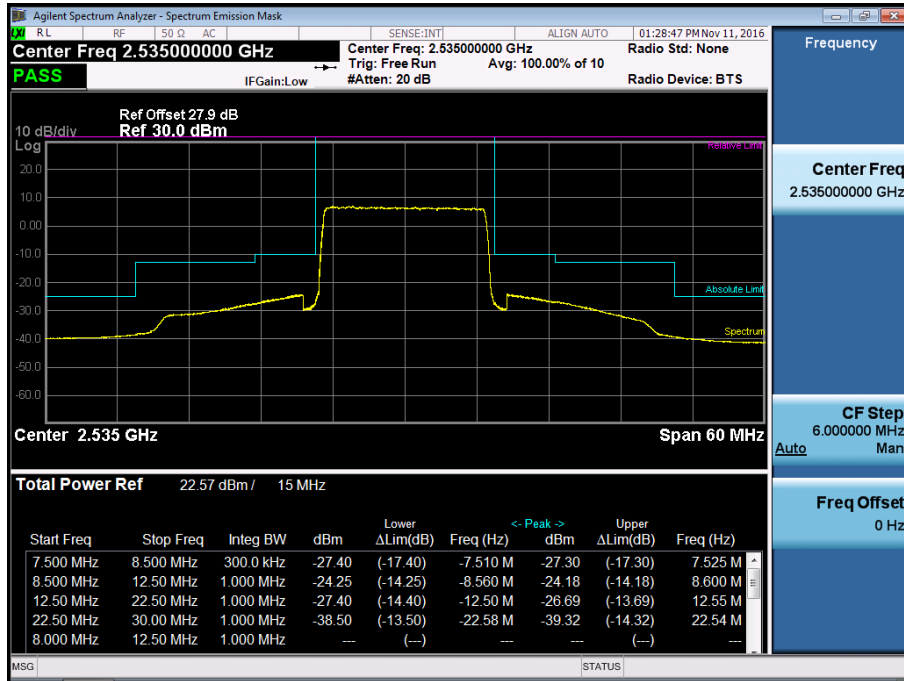

BAND7. High Channel Edge Plot (15MHz Ch.21375 QPSK RB 75)

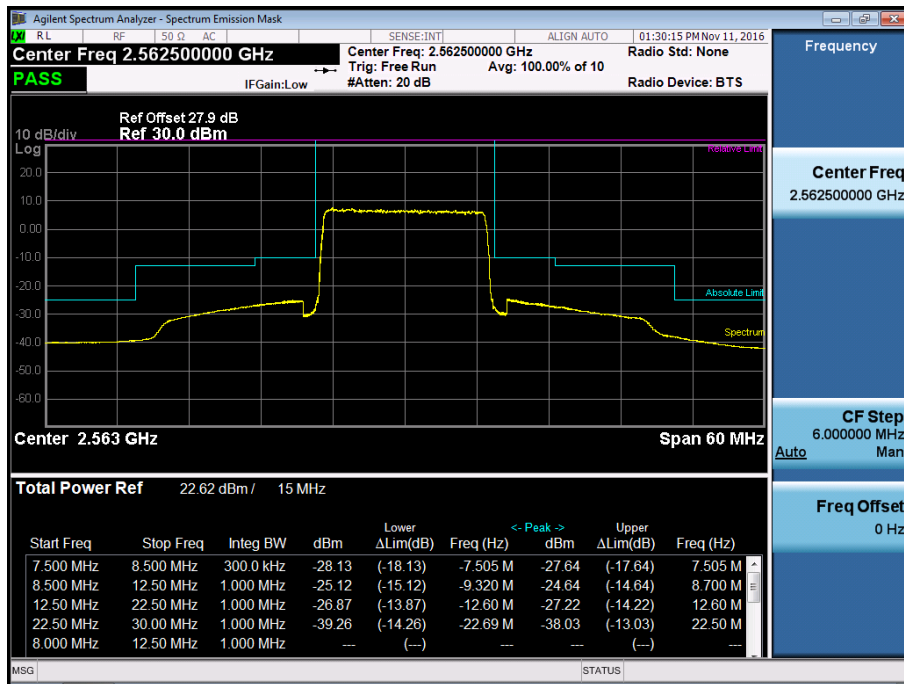

BAND7. Low Channel Edge Plot (20MHz Ch.20850 QPSK RB 100)-1



BAND7. Low Channel Edge Plot (20MHz Ch.20850 QPSK RB 100)-2



BAND7. Mid Channel Edge Plot (20MHz Ch.21100 QPSK RB 100)

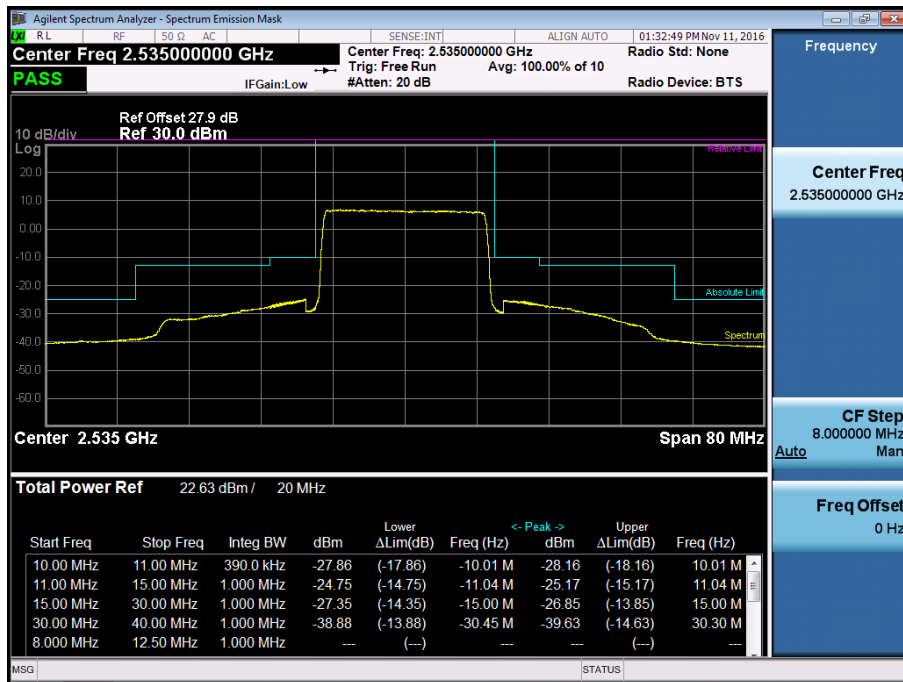

BAND7. High Channel Edge Plot (20MHz Ch.21350 QPSK RB 100)



BAND7. Conducted Spurious Plot 1 (5MHz Ch.20775 QPSK RB 1, Offset 0)

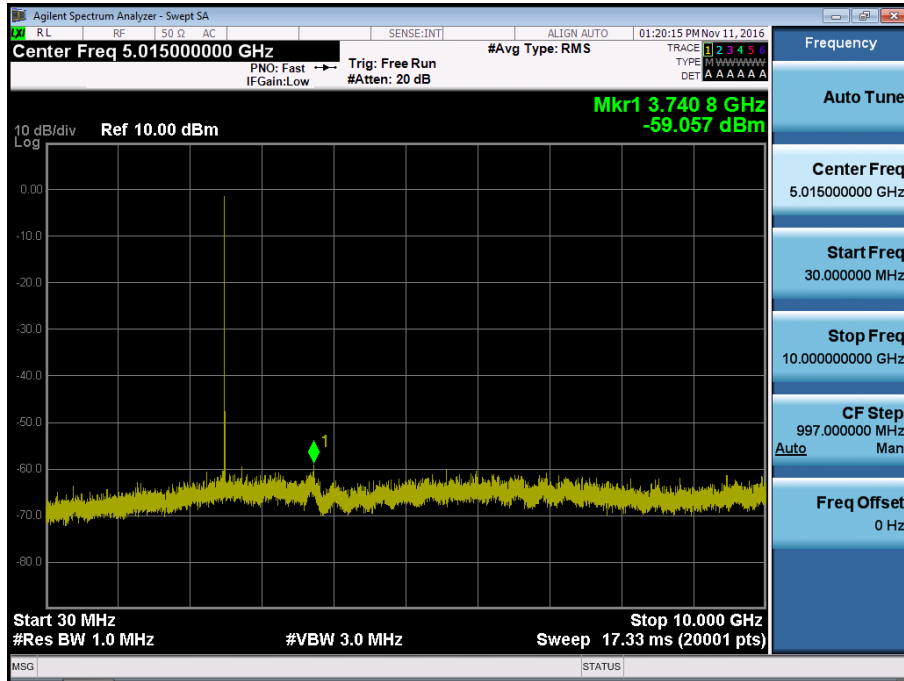

BAND7. Conducted Spurious Plot 2 (5MHz Ch.20775 QPSK RB 1, Offset 0)

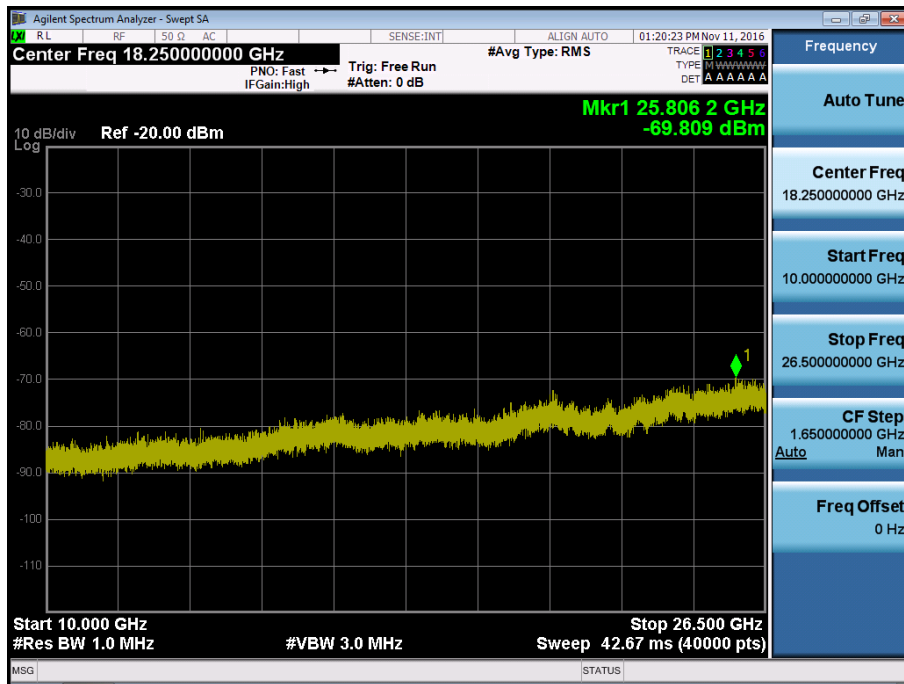



BAND7. Conducted Spurious Plot 1 (5MHz Ch.21100 QPSK RB 1, Offset 0)

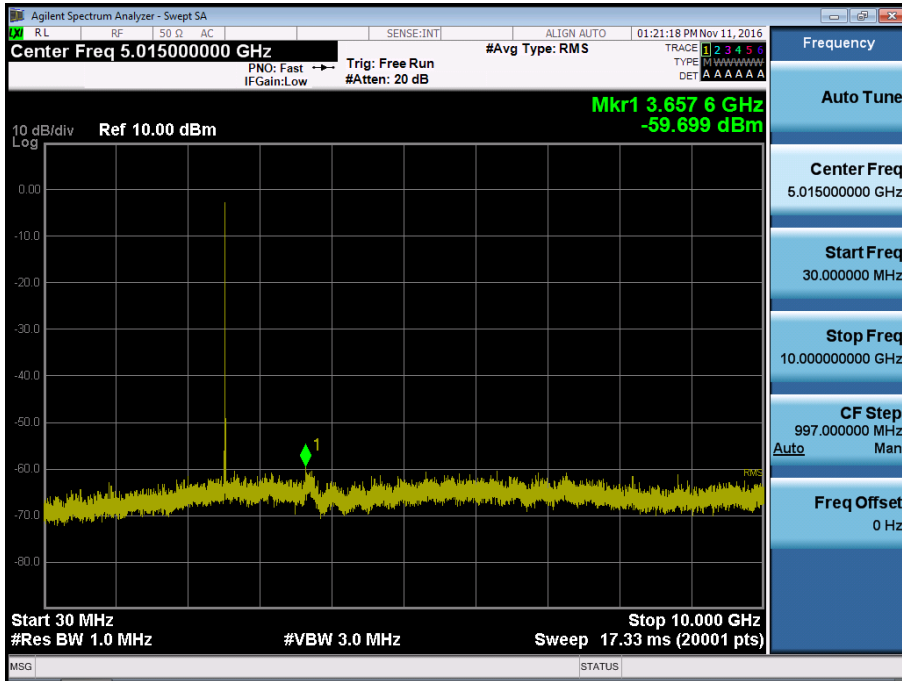

BAND7. Conducted Spurious Plot 2 (5MHz Ch.21100 QPSK RB 1, Offset 0)

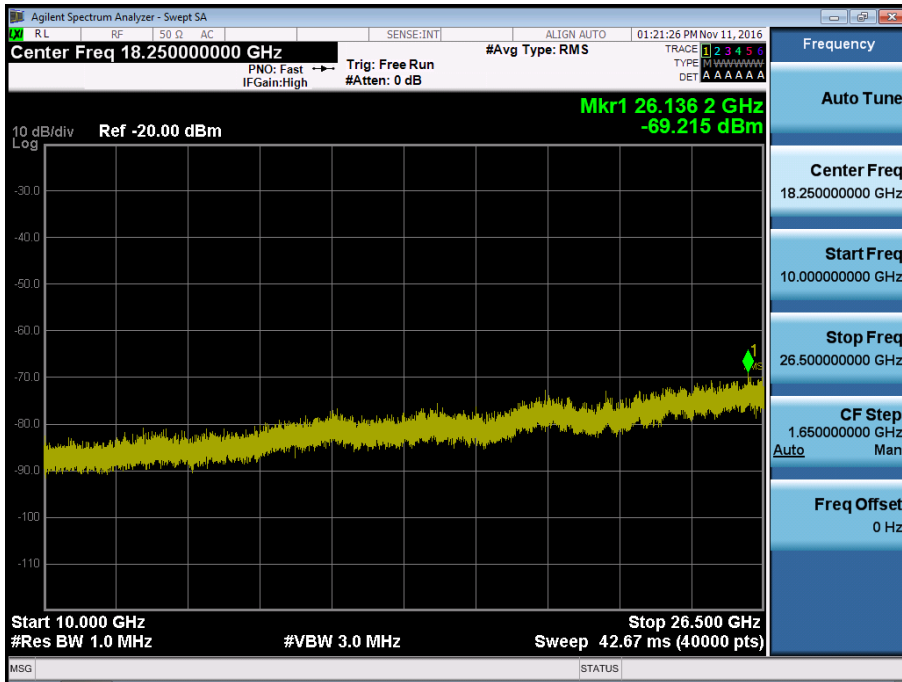

BAND7. Conducted Spurious Plot 1 (5MHz Ch.21425 QPSK RB 1, Offset 0)

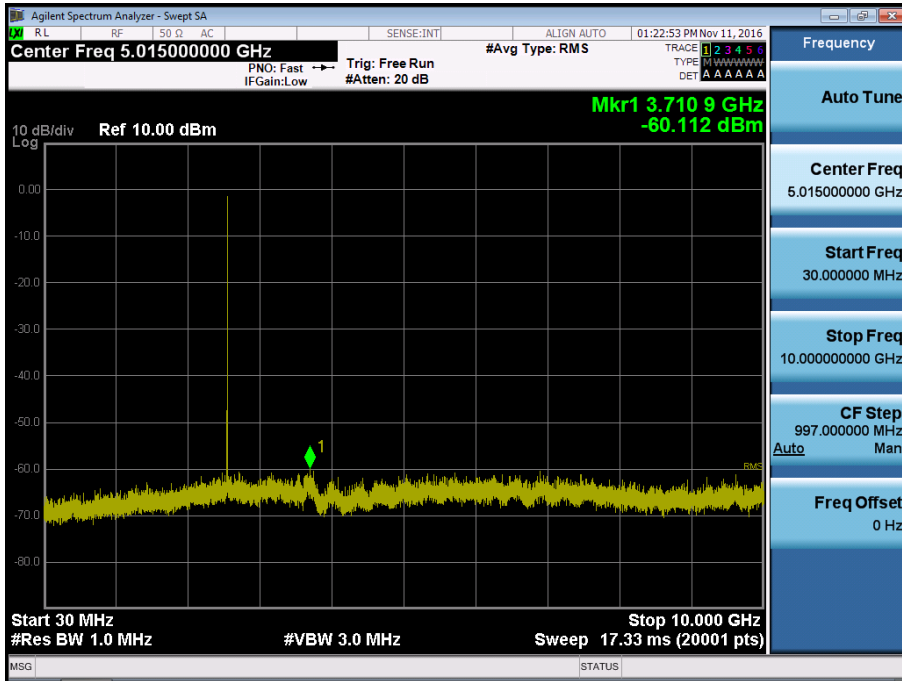

BAND7. Conducted Spurious Plot 2 (5MHz Ch.21425 QPSK RB 1, Offset 0)

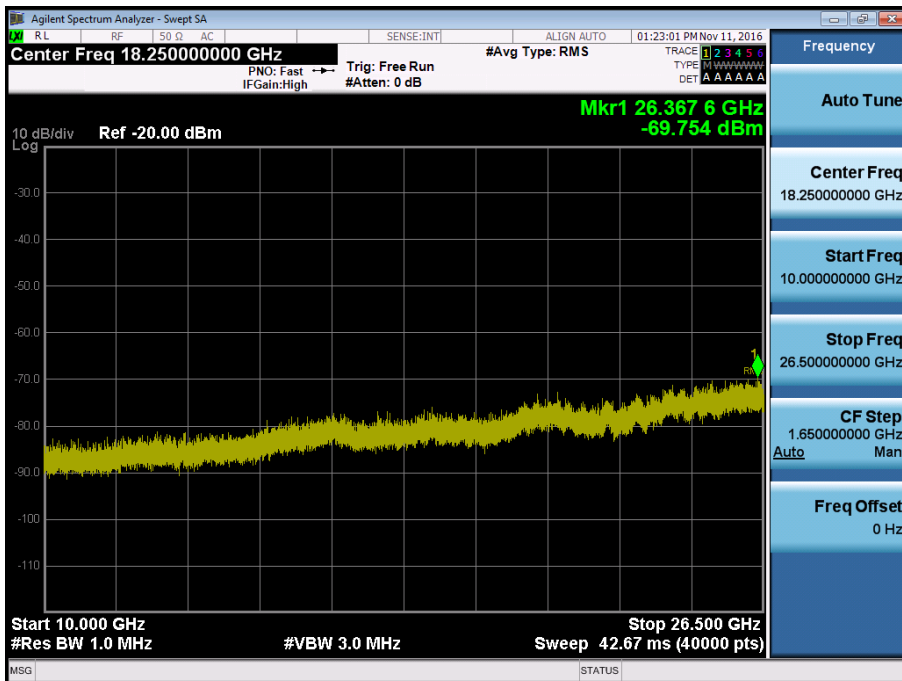

BAND7. Conducted Spurious Plot 1 (10MHz Ch.20800 QPSK RB 1, Offset 0)

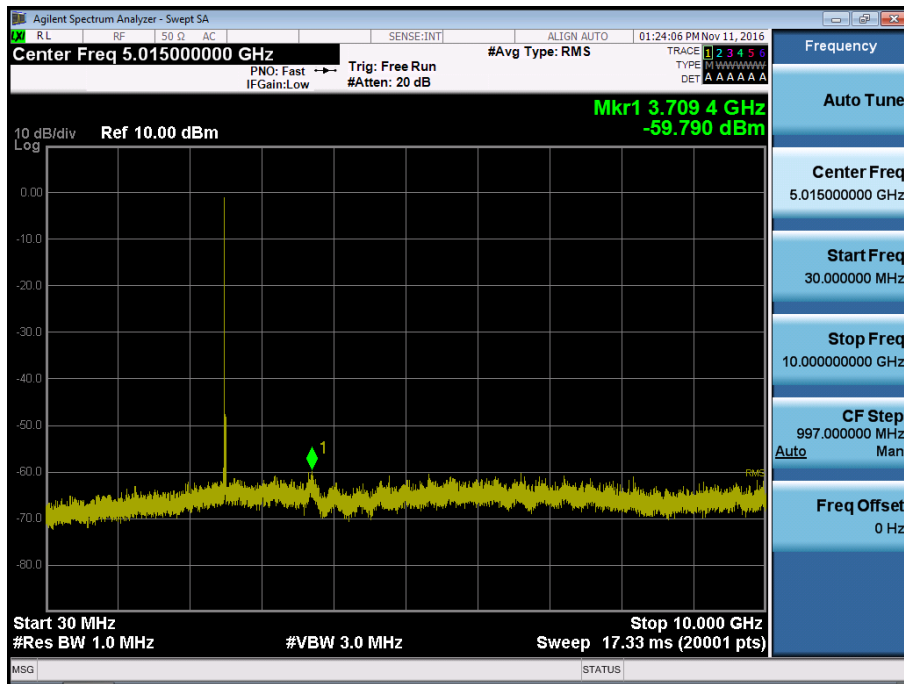

BAND7. Conducted Spurious Plot 2 (10MHz Ch.20800 QPSK RB 1, Offset 0)

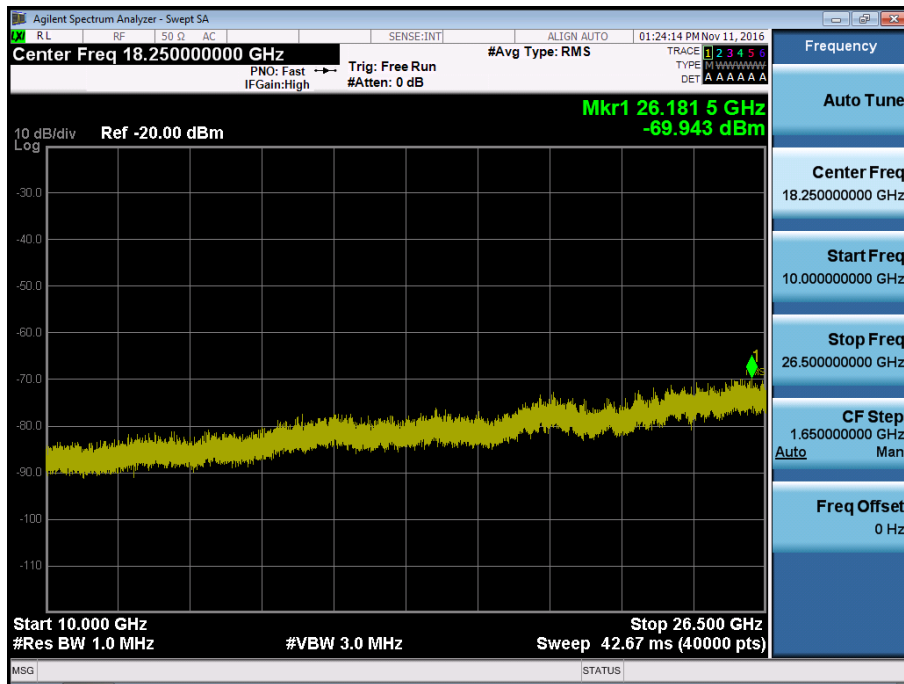

BAND7. Conducted Spurious Plot 1 (10MHz Ch.21100 QPSK RB 1, Offset 0)

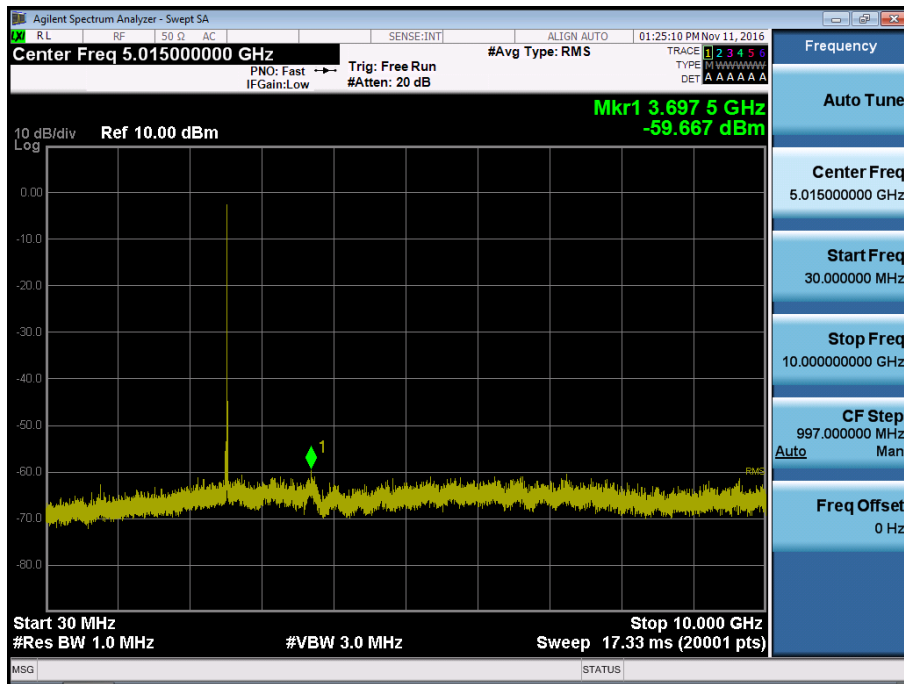

BAND7. Conducted Spurious Plot 2 (10MHz Ch.21100 QPSK RB 1, Offset 0)

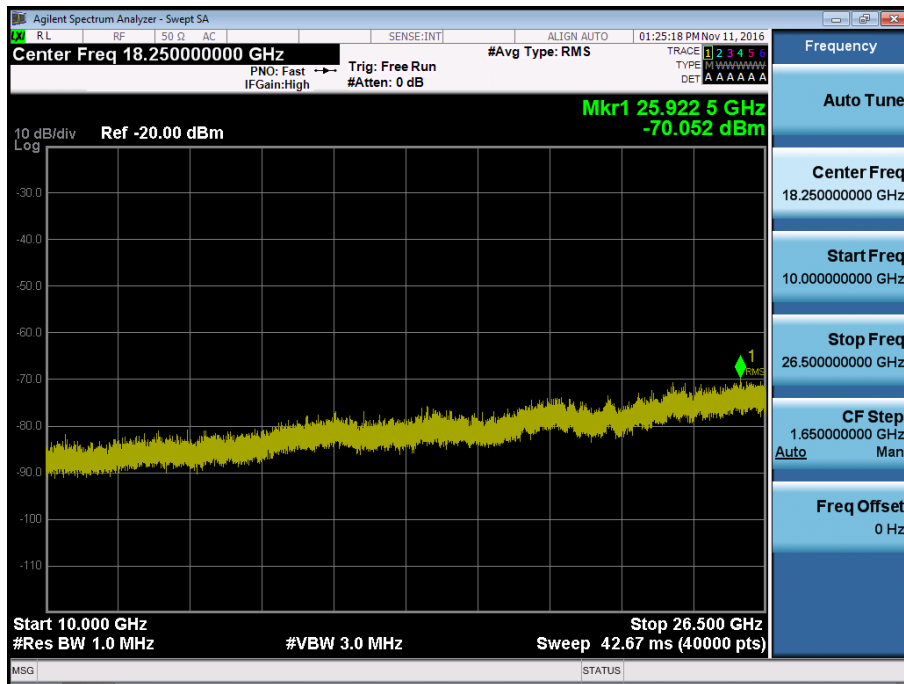

BAND7. Conducted Spurious Plot 1 (10MHz Ch.21400 QPSK RB 1, Offset 0)

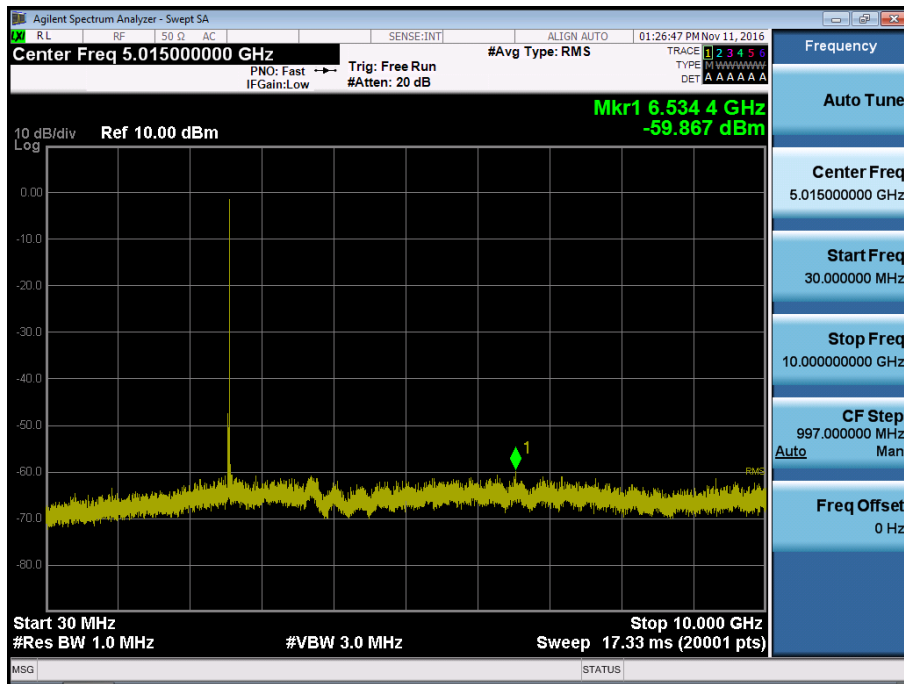

BAND7. Conducted Spurious Plot 2 (10MHz Ch.21400 QPSK RB 1, Offset 0)

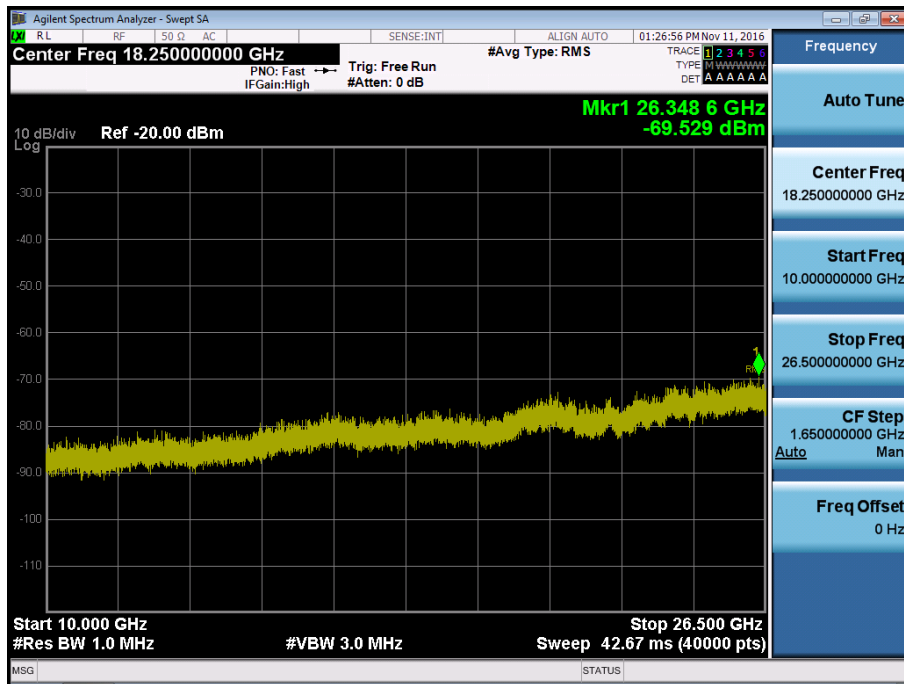

BAND7. Conducted Spurious Plot 1 (15MHz Ch.20825 QPSK RB 1, Offset 0)

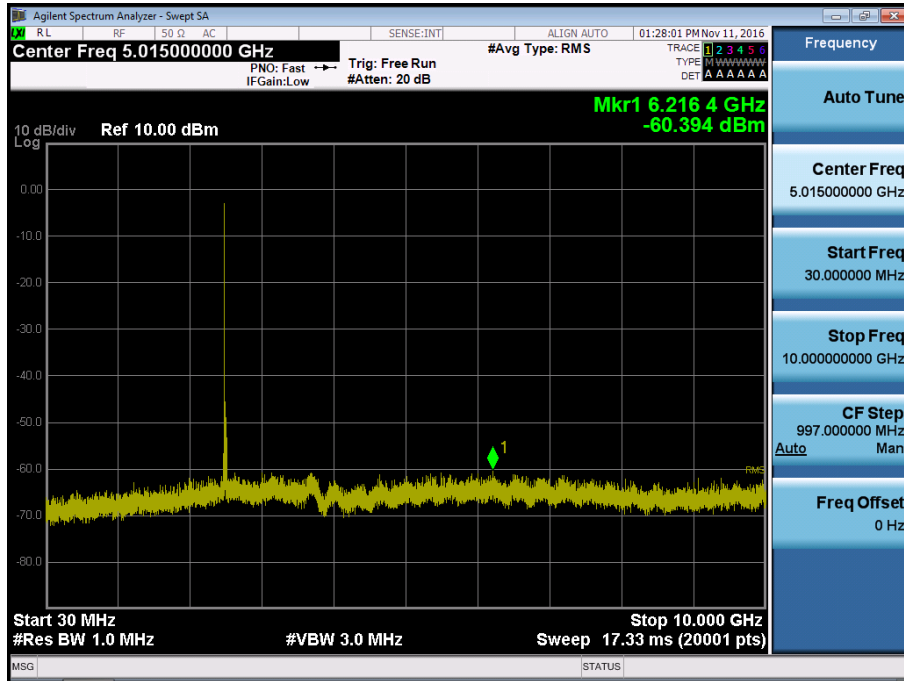

BAND7. Conducted Spurious Plot 2 (15MHz Ch.20825 QPSK RB 1, Offset 0)

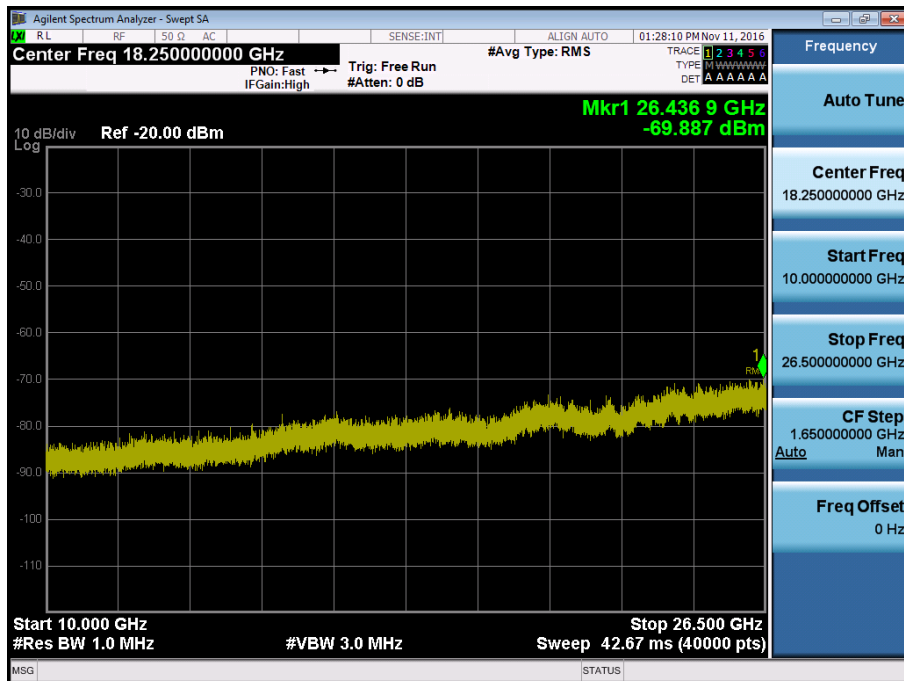

BAND7. Conducted Spurious Plot 1 (15MHz Ch.21100 QPSK RB 1, Offset 0)

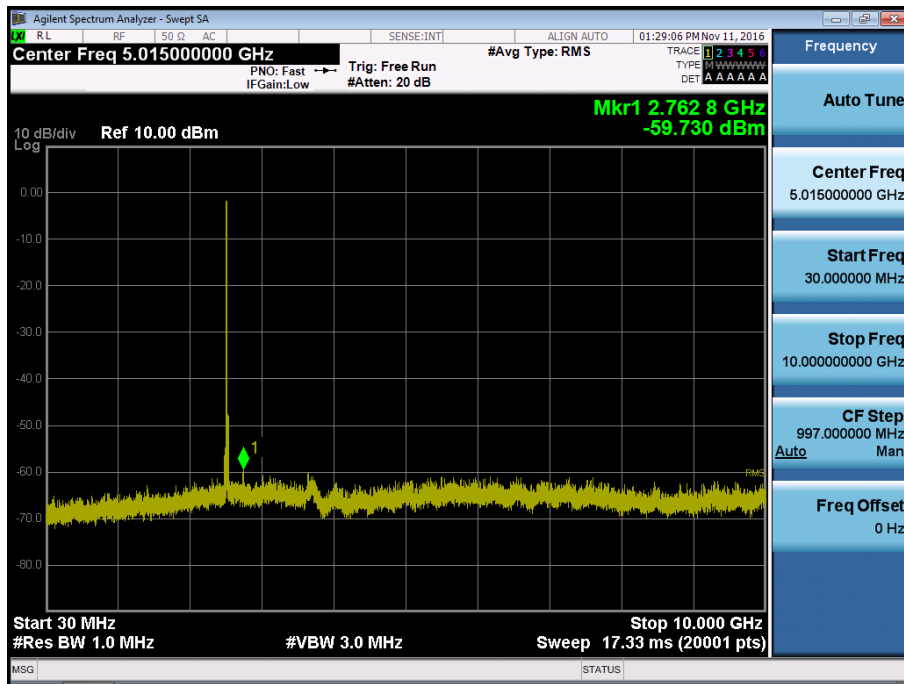

BAND7. Conducted Spurious Plot 2 (15MHz Ch.21100 QPSK RB 1, Offset 0)

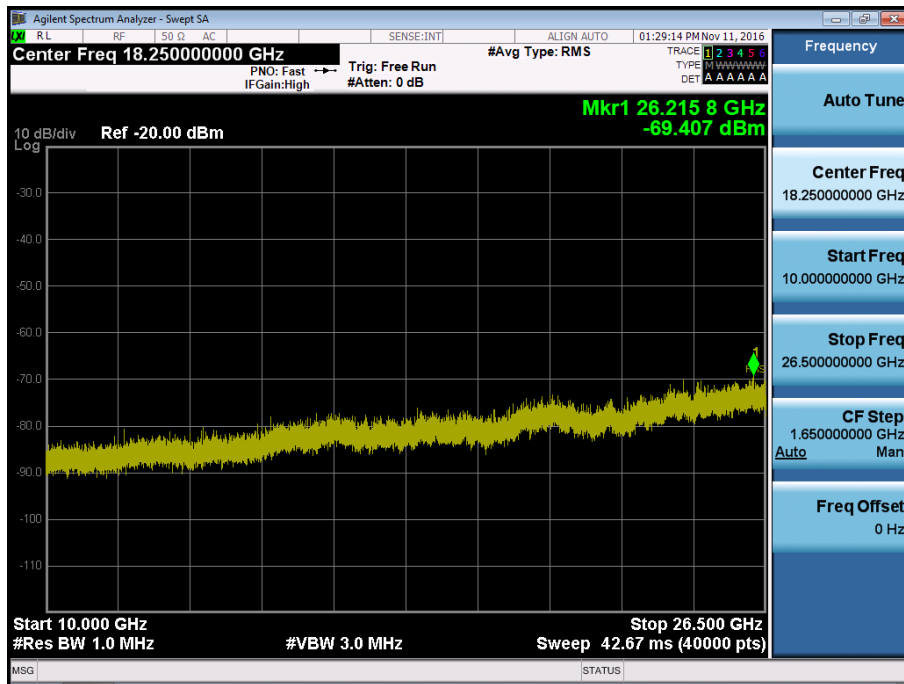

BAND7. Conducted Spurious Plot 1 (15MHz Ch.21375 QPSK RB 1, Offset 0)

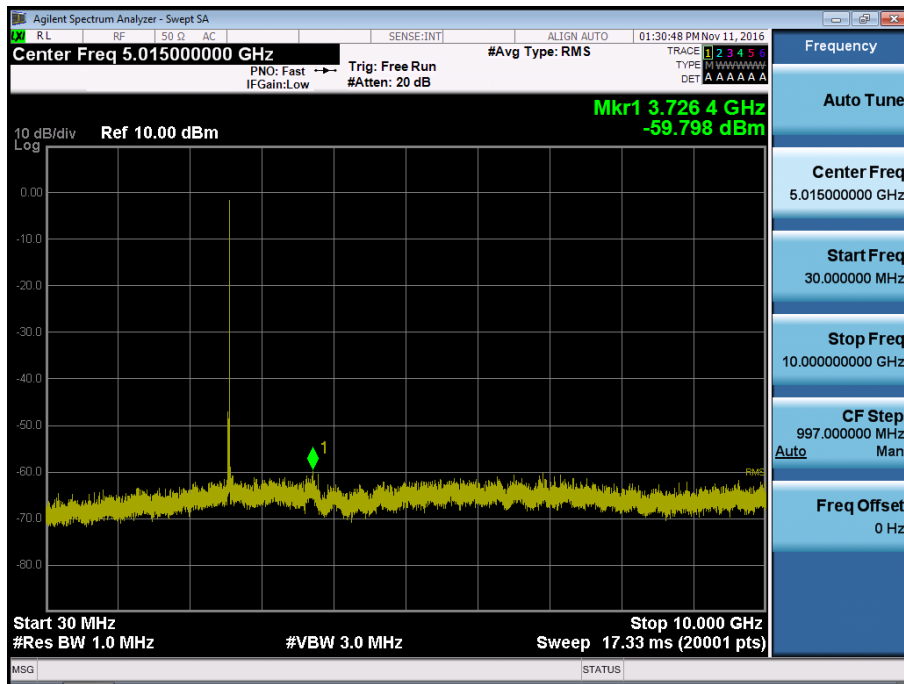

BAND7. Conducted Spurious Plot 2 (15MHz Ch.21375 QPSK RB 1, Offset 0)

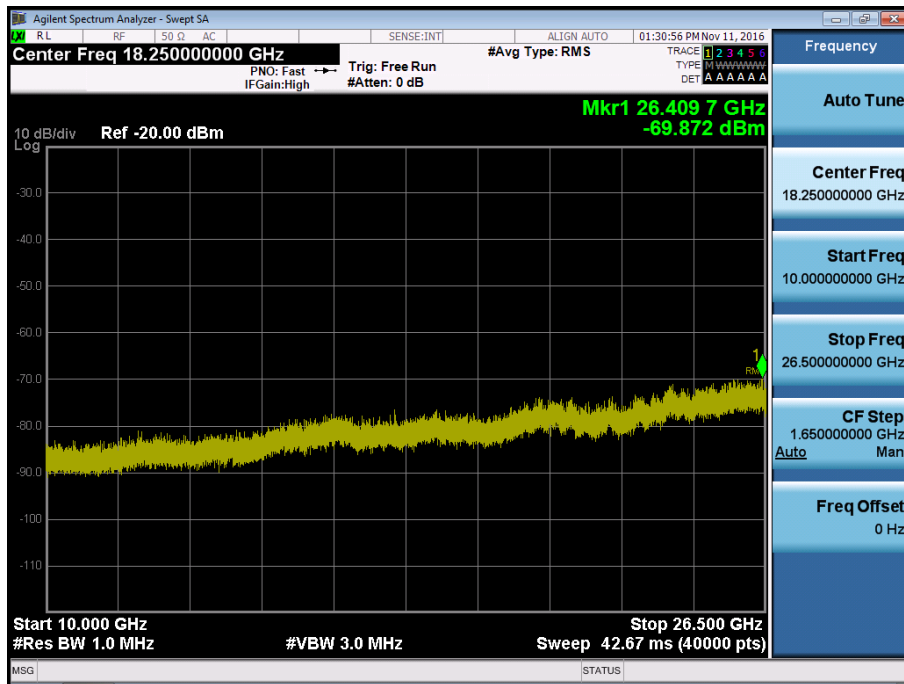



BAND7. Conducted Spurious Plot 1 (20MHz Ch.20850 QPSK RB 1, Offset 0)

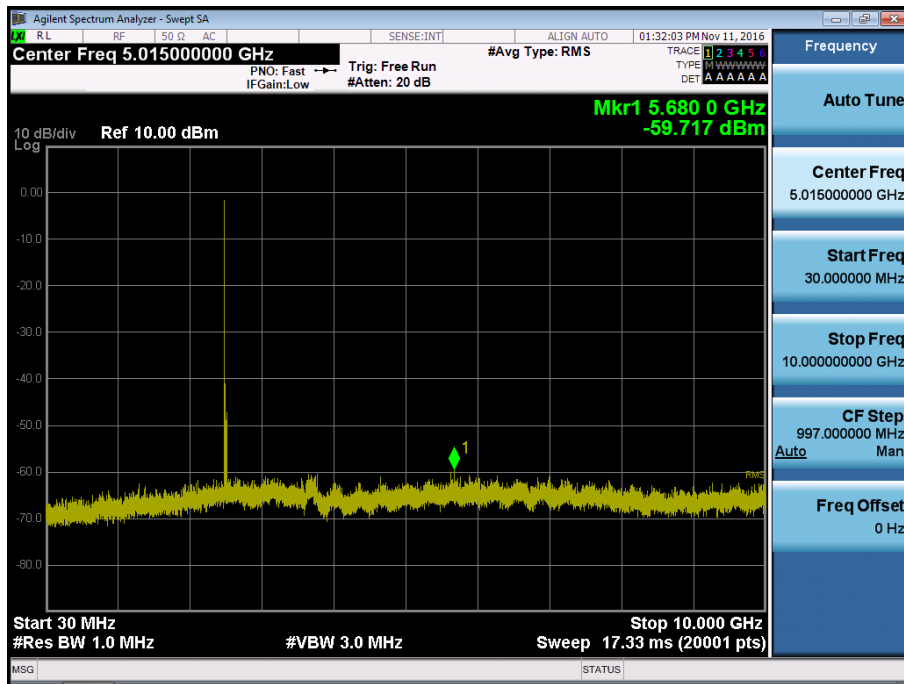

BAND7. Conducted Spurious Plot 2 (20MHz Ch.20850 QPSK RB 1, Offset 0)

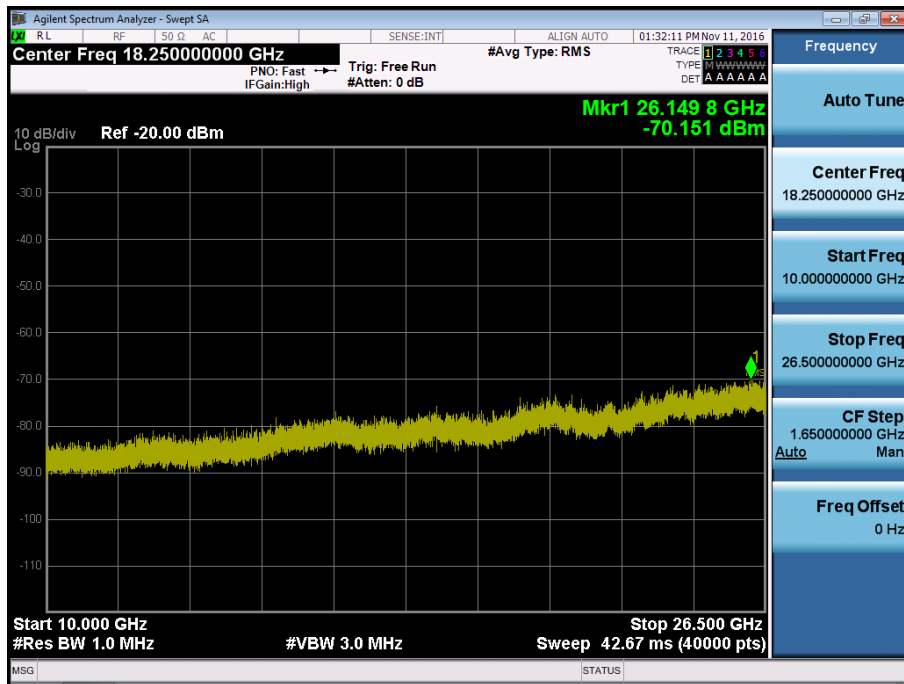

BAND7. Conducted Spurious Plot 1 (20MHz Ch.21100 QPSK RB 1, Offset 0)

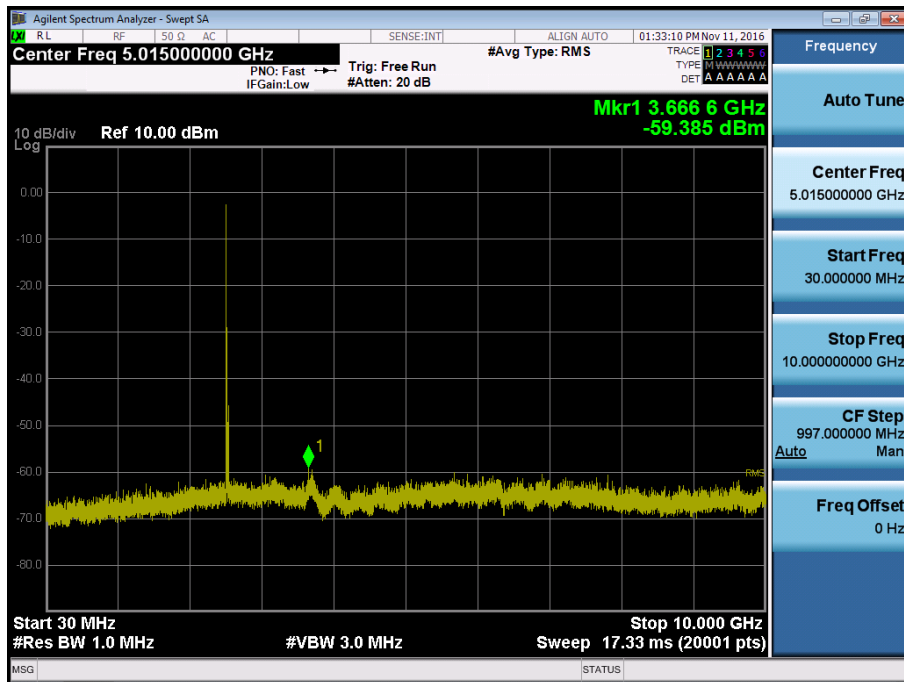

BAND7. Conducted Spurious Plot 2 (20MHz Ch.21100 QPSK RB 1, Offset 0)

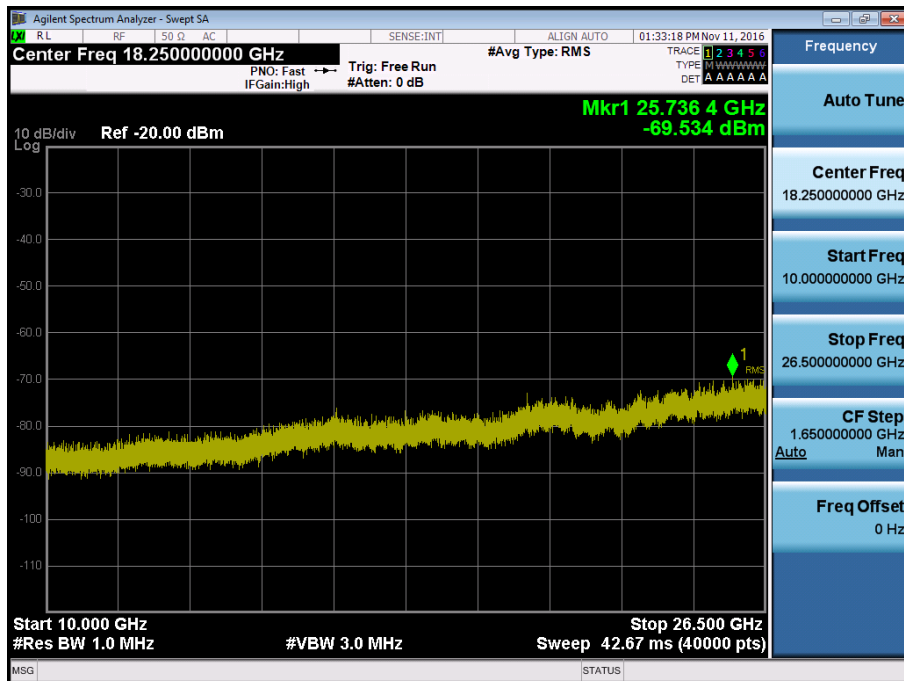

BAND7. Conducted Spurious Plot 1 (20MHz Ch.21350 QPSK RB 1, Offset 0)

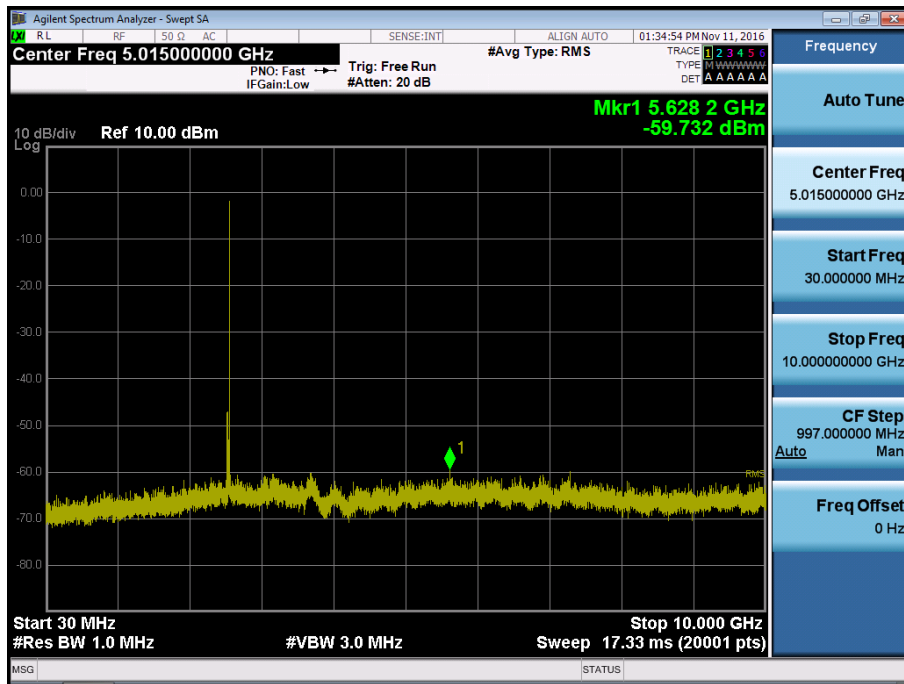

BAND7. Conducted Spurious Plot 2 (20MHz Ch.21350 QPSK RB 1, Offset 0)

