



# PCTEST ENGINEERING LABORATORY, INC.

7185 Oakland Mills Road, Columbia, MD 21045 USA  
Tel. 410.290.6652 / Fax 410.290.6654  
http://www.pctestlab.com



## MEASUREMENT REPORT FCC PART 15.407 / IC RSS-210 DFS

**Company Name:**  
LG Electronics MobileComm U.S.A  
1000 Sylvan Avenue  
Englewood Cliffs, NJ 07632  
United States

**Date of Testing:**  
8/6/2013  
**Test Site/Location:**  
PCTEST Lab. Columbia, MD, USA  
**Test Report Serial No.:**  
0Y1307031180.ZNF

<b>FCC ID:</b>	<b>ZNFLS980</b>
<b>COMPANY:</b>	<b>LG Electronics MobileComm U.S.A</b>



**Model(s):** LS-980  
**EUT Type:** Portable Handset  
**Type of Device:** Client Only Device, No Radar Detection Capability  
**Frequency Range:** 5260 – 5320 MHz (UNII-II Band)  
5500 – 5700 MHz (UNII-III Band)  
**FCC Classification:** Unlicensed National Information Infrastructure (UNII)  
**FCC Rule Part(s):** Part 15.407(UNII)  
**Class II Permissive Change:** Please see FCC change documents.  
**Original Grant Date:** 7/23/2013

This equipment has been shown to be capable of compliance with the applicable technical standards as indicated in the measurement report and was tested in accordance with the measurement procedures specified in FCC 06-96 Appendix B Compliance Measurement Procedures for Unlicensed-National Information Infrastructure Devices Operating in the 5.25 – 5.35 GHz and 5.47 – 5.725 GHz Bands Incorporating Dynamic Frequency Selection. Test results reported herein relate only to the item(s) tested.

I attest to the accuracy of data. All measurements reported herein were performed by me or were made under my supervision and are correct to the best of my knowledge and belief. I assume full responsibility for the completeness of these measurements and vouch for the qualifications of all persons taking them.

  
Randy Ortanez  
President





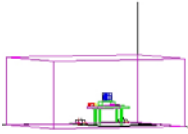
<b>FCC ID:</b> ZNFLS980		<b>FCC Pt. 15.407 DFS TEST REPORT (CLASS II PERMISSIVE CHANGE)</b>		<b>Reviewed by:</b> Quality Manager
<b>Test Report S/N:</b> 0Y1307031180.ZNF	<b>Test Dates:</b> 8/6/2013	<b>EUT Type:</b> Portable Handset		Page 1 of 20

## TABLE OF CONTENTS

---

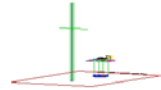
FCC PART 15.407 MEASUREMENT REPORT .....		3
1.0 INTRODUCTION.....		4
1.1 SCOPE.....		4
1.2 EVALUATION PROCEDURE.....		4
1.3 SUMMARY OF TEST RESULTS .....		4
2.0 PRODUCT INFORMATION .....		5
2.1 EQUIPMENT DESCRIPTION.....		5
2.2 EUT CAPABILITIES .....		5
2.3 MODIFICATIONS.....		5
3.0 DESCRIPTION OF DYNAMIC FREQUENCY SELECTION TEST .....		6
3.1 APPLICABILITY .....		6
3.2 REQUIREMENTS .....		6
3.3 DFS DETECTION THRESHOLD VALUES .....		8
3.4 PARAMETERS OF DFS TEST SIGNALS.....		8
3.5 PROCEDURE .....		9
4.0 TEST EQUIPMENT.....		11
4.1 ADDITIONAL EQUIPMENT .....		11
5.0 TEST PLOTS AND DATA - UNII BAND II .....		12
6.0 TEST PLOTS AND DATA - UNII BAND III .....		16
7.0 CONCLUSION .....		20

<b>FCC ID:</b> ZNFLS980		<b>FCC Pt. 15.407 DFS TEST REPORT (CLASS II PERMISSIVE CHANGE)</b>		<b>Reviewed by:</b> Quality Manager
<b>Test Report S/N:</b> 0Y1307031180.ZNF	<b>Test Dates:</b> 8/6/2013	<b>EUT Type:</b> Portable Handset	Page 2 of 20	



# DFS MEASUREMENT REPORT

## FCC Part 15.407

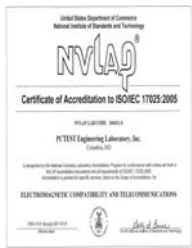
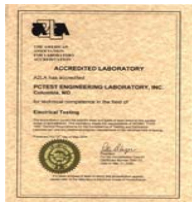


### § 2.1033 General Information



**APPLICANT:** LG Electronics MobileComm U.S.A  
**APPLICANT ADDRESS:** 1000 Sylvan Avenue  
 Englewood Cliffs, NJ 07632, United States  
**TEST SITE:** PCTEST ENGINEERING LABORATORY, INC.  
**TEST SITE ADDRESS:** 7185 Oakland Mills Road, Columbia, MD 21046 USA  
**FCC RULE PART(S):** Part 15.407(h)  
**BASE MODEL:** LS-980  
**FCC ID:** ZNFLS980  
**Test Device Serial No.:** BT/WIFI (Cond)     Production     Pre-Production     Engineering  
**DEVICE CLASSIFICATION:** Client Only, No Radar Detection  
**DATE(S) OF TEST:** 8/6/2013  
**TEST REPORT S/N:** 0Y1307031180.ZNF

### Test Facility / Accreditations

Measurements were performed at PCTEST Engineering Lab located in Columbia, MD 21045, U.S.A.



- PCTEST facility is an FCC registered (PCTEST Reg. No. 159966) test facility with the site description report on file and has met all the requirements specified in Section 2.948 of the FCC Rules and Industry Canada (2451B-1).
- PCTEST Lab is accredited to ISO 17025 by U.S. National Institute of Standards and Technology (NIST) under the National Voluntary Laboratory Accreditation Program (NVLAP Lab code: 100431-0) in EMC, FCC and Telecommunications.
- PCTEST Lab is accredited to ISO 17025-2005 by the American Association for Laboratory Accreditation (A2LA) in Specific Absorption Rate (SAR) testing, Hearing Aid Compatibility (HAC) testing, CTIA Test Plans, and wireless testing for FCC and Industry Canada Rules.
- PCTEST Lab is a recognized U.S. Conformity Assessment Body (CAB) in EMC and R&TTE (n.b. 0982) under the U.S.-EU Mutual Recognition Agreement (MRA).
- PCTEST TCB is a Telecommunication Certification Body (TCB) accredited to ISO/IEC Guide 65 by the American National Standards Institute (ANSI) in all scopes of FCC Rules and Industry Canada Standards (RSS).
- PCTEST facility is an IC registered (2451B-1) test laboratory with the site description on file at Industry Canada.
- PCTEST is a CTIA Authorized Test Laboratory (CATL) for AMPS, CDMA, and EvDO wireless devices and for Over-the-Air (OTA) Antenna Performance testing for AMPS, CDMA, GSM, GPRS, EGPRS, UMTS (W-CDMA), CDMA 1xEVDO, and CDMA 1xRTT.

<b>FCC ID:</b> ZNFLS980		<b>FCC Pt. 15.407 DFS TEST REPORT</b> <b>(CLASS II PERMISSIVE CHANGE)</b>		<b>Reviewed by:</b> Quality Manager
<b>Test Report S/N:</b> 0Y1307031180.ZNF	<b>Test Dates:</b> 8/6/2013	<b>EUT Type:</b> Portable Handset	Page 3 of 20	

## 1.0 INTRODUCTION

### 1.1 Scope

This report has been prepared to demonstrate compliance with the requirements for Dynamic Frequency Selection (DFS) as stated in FCC 06-96. Testing was performed on the **LG Portable Handset FCC ID: ZNFLS980** in accordance with the measurement procedure described in Appendix B of FCC 06-96. As of July 20, 2007 all devices operating in the 5250 – 5350 MHz and/or the 5470 – 5725 MHz bands must comply with the DFS requirements. As the EUT does not have radar detection capability it was evaluated as a Client Only Device. All test results reported herein are applicable to the sample selected for testing. The unit used for testing was supplied by LG Electronics MobileComm U.S.A.

### 1.2 Evaluation Procedure



Conducted test methodology was used for the DFS evaluation procedure of the **LG Portable Handset FCC ID: ZNFLS980**. No deviations to the test procedure and test methods occurred during the evaluation of the EUT.

### 1.3 Summary of Test Results

The **LG Portable Handset FCC ID: ZNFLS980** was found to be compliant with the requirements for DFS as required for a Client Device per Part 15.407(h) and FCC 06-96. The following table lists the measured parameters. The actual data and plots can be found in Section 5 and 6 of this report.

	Parameter	Measured	Limit	Result
5260 – 5320 MHz UNII – II Band	Channel Move Time	No client Pulses were detected after the Radar Burst.	10 seconds	Pass
	Channel Closing Transmission Time	< 200ms + 0.00 ms (aggregate)	200ms + aggregate of 60ms over remaining 10 second period	Pass
	Non-occupancy Period	Monitored > 30 minutes (No transmission occurred)	30 minutes	Pass
5470 – 5725 MHz UNII – III Band	Channel Move Time	No client Pulses were detected after the Radar Burst.	10 seconds	Pass
	Channel Closing Transmission Time	< 200ms + 0.00 ms (aggregate)	200ms + aggregate of 60ms over remaining 10 second period	Pass
	Non-occupancy Period	Monitored > 30 minutes (No transmission occurred)	30 minutes	Pass

**Table 1-1. DFS Test Results Summary**

FCC ID: ZNFLS980		FCC Pt. 15.407 DFS TEST REPORT (CLASS II PERMISSIVE CHANGE)		Reviewed by: Quality Manager
Test Report S/N: 0Y1307031180.ZNF	Test Dates: 8/6/2013	EUT Type: Portable Handset	Page 4 of 20	

## 2.0 PRODUCT INFORMATION

### 2.1 Equipment Description

The Equipment Under Test (EUT) is the **LG Portable Handset FCC ID: ZNFLS980**.

**Mode of Operation:**

<b>Master Device</b>	<input type="checkbox"/>
<b>Client Device (No radar detection)</b>	<input checked="" type="checkbox"/>
<b>Client Device with Radar Detection</b>	<input type="checkbox"/>

Parameters of EUT:	
Frequency	5260 – 5320 MHz 5500 – 5700 MHz
Modulation:	OFDM
Channel Bandwidth:	20 MHz



### 2.2 EUT Capabilities

This device contains the following capabilities:

850/1900 CDMA/EvDO Rev0/A (BC0, BC1, BC10), 850/1900 GSM/GPRS/EDGE, 850/1900 WCDMA/HSPA, Band 25 (3,5,10MHz), 26 (1.4,3,5,10 MHz), 41 (10,15,20 MHz) LTE, 802.11a/b/g/n/ac WLAN (DTS/NII), Bluetooth (1x,EDR, LE), NFC

### 2.3 Modifications

No modifications to the EUT were required in order to comply with the DFS specifications.

FCC ID: ZNFLS980		FCC Pt. 15.407 DFS TEST REPORT (CLASS II PERMISSIVE CHANGE)		Reviewed by: Quality Manager
Test Report S/N: 0Y1307031180.ZNF	Test Dates: 8/6/2013	EUT Type: Portable Handset	Page 5 of 20	

## 3.0 DESCRIPTION OF DYNAMIC FREQUENCY SELECTION TEST

### 3.1 Applicability

The following table from FCC 06-96 lists the applicable requirements for the DFS testing. The device evaluated in this report is considered a client device without radar detection capability.

Requirement	Operational Mode		
	Master	Client Without Radar Detection	Client With Radar Detection
Non-Occupancy Period	Yes	Not required	Yes
DFS Detection Threshold	Yes	Not required	Yes
Channel Availability Check Time	Yes	Not required	Not required
Uniform Spreading	Yes	Not required	Not required
U-NII Detection Bandwidth	Yes	Not required	Yes

**Table 3-1. DFS Applicability**



Requirement	Operational Mode		
	Master	Client Without Radar Detection	Client With Radar Detection
DFS Detection Threshold	Yes	Not required	Yes
Channel Closing Transmission Time	Yes	Yes	Yes
Channel Move Time	Yes	Yes	Yes
U-NII Detection Bandwidth	Yes	Not required	Yes
Client Beacon Test	N/A	Yes	Yes

**Table 3-2. DFS Applicability During Normal Operation**

### 3.2 Requirements

Per FCC 06-96 the following are the requirements for Client Devices:

- a) A Client Device will not transmit before having received appropriate control signals from a Master Device.
- b) A Client Device will stop all its transmissions whenever instructed by a Master Device to which it is associated and will meet the Channel Move Time and Channel Closing Transmission Time requirements.

FCC ID: ZNFLS980		FCC Pt. 15.407 DFS TEST REPORT (CLASS II PERMISSIVE CHANGE)		Reviewed by: Quality Manager
Test Report S/N: 0Y1307031180.ZNF	Test Dates: 8/6/2013	EUT Type: Portable Handset	Page 6 of 20	



The Client Device will not resume any transmissions until it has again received control signals from a Master Device.

- c) If a Client Device is performing In-Service Monitoring and detects a Radar Waveform above the DFS Detection Threshold, it will inform the Master Device. This is equivalent to the Master Device detecting the Radar Waveform and d) through f) of section 5.1.1 apply.
- d) Irrespective of Client Device or Master Device detection the Channel Move Time and Channel Closing Transmission Time requirements remain the same.

Channel Move Time and Channel Closing Transmission Time requirements are listed in the following table.

Parameter	Value
Non-occupancy period	Minimum 30 minutes
Channel Availability Check Time	60 seconds
Channel Move Time	10 seconds See Note 1.
Channel Closing Transmission Time	200 milliseconds + an aggregate of 60 milliseconds over remaining 10 second period. See Notes 1 and 2.
U-NII Detection Bandwidth	Minimum 80% of the U-NII 99% transmission power bandwidth. See Note 3.
<p><b>Note 1: The instant that the Channel Move Time and the Channel Closing Transmission Time begins is as follows:</b></p> <ul style="list-style-type: none"> <li>• For the Short Pulse Radar Test Signals this instant is the end of the Burst.</li> <li>• For the Frequency Hopping radar Test Signal, this instant is the end of the last radar Burst generated.</li> <li>• For the Long Pulse Radar Test Signal this instant is the end of the 12 second period defining the Radar Waveform.</li> </ul> <p><b>Note 2: The Channel Closing Transmission Time is comprised of 200 milliseconds starting at the beginning of the Channel Move Time plus any additional intermittent control signals required to facilitate a Channel move (an aggregate of 60 milliseconds) during the remainder of the 10 second period. The aggregate duration of control signals will not count quiet periods in between transmissions.</b></p> <p><b>Note 3: During the U-NII Detection Bandwidth detection test, radar type 1 is used and for each frequency step the minimum percentage of detection is 90 percent. Measurements are performed with no data traffic.</b></p>	

**Table 3-3: DFS Response Requirements**

FCC ID: ZNFLS980		FCC Pt. 15.407 DFS TEST REPORT (CLASS II PERMISSIVE CHANGE)		Reviewed by: Quality Manager
Test Report S/N: 0Y1307031180.ZNF	Test Dates: 8/6/2013	EUT Type: Portable Handset	Page 7 of 20	

### 3.3 DFS Detection Threshold Values

The DFS detection thresholds are defined for Master devices and Client Devices with In-service monitoring. These detection thresholds are listed in the following table.

Maximum Transmit Power	Value (See Notes 1 and 2)
≥ 200 milliwatt	-64 dBm
< 200 milliwatt	-62 dBm
Note 1: This is the level at the input of the receiver assuming a 0 dBi receive antenna.  Note 2: Throughout these test procedures an additional 1 dB has been added to the amplitude of the test transmission waveforms to account for variations in measurement equipment. This will ensure that the test signal is at or above the detection threshold level to trigger a DFS response.	

**Table 3-4: Detection Thresholds for Master Devices and Client Devices with Radar Detection**

### 3.4 Parameters of DFS Test Signals



As the EUT is a Client Device with no Radar Detection only one type radar pulse is required for the testing. Radar Pulse type 1 was used in the evaluation of the Client device for the purpose of measuring the Channel Move Time and the Channel Closing Transmission Time. Table 3-5 lists the parameters for the Short Pulse Radar Waveforms. A plot of the Radar Pulse Type 1 used for testing is included in Section 5.0 of this report.

Radar Type	Pulse Width (μsec)	PRI (μsec)	Number of Pulses	Minimum Percentage of Successful Detection	Minimum Number of Trials
1	1	1428	18	60%	30
2	1-5	150-230	23-29	60%	30
3	6-10	200-500	16-18	60%	30
4	11-20	200-500	12-16	60%	30
Aggregate (Radar Types 1-4)				80%	120

**Table 3-5: Parameters for Short Pulse Radar Waveforms**

Radar Type	Pulse Width (μsec)	Chirp Width (MHz)	PRI (μsec)	Number of Pulses per Burst	Number of Bursts	Minimum Percentage of Successful Detection	Minimum Number of Trials
5	50 - 100	5 - 20	5 - 20	1 - 3	8 - 20	60%	30

**Table 3-6. Parameters for Long Pulse Radar Waveforms**

FCC ID: ZNFLS980		FCC Pt. 15.407 DFS TEST REPORT (CLASS II PERMISSIVE CHANGE)		Reviewed by: Quality Manager
Test Report S/N: 0Y1307031180.ZNF	Test Dates: 8/6/2013	EUT Type: Portable Handset	Page 8 of 20	



Radar Type	Pulse Width (μsec)	PRI (μsec)	Pulses per Hop	Hopping Rate (kHz)	Hopping Sequence Length (msec)	Minimum Percentage of Successful Detection	Minimum Number of Trials
6	1	333	9	0.333	300	70%	30

Table 3-7. Parameters for Frequency Hopping Radar Waveforms

### 3.5 Procedure

The FCC 06-96 describes a radiated test setup and a conducted test setup. The conducted test setup was used for this testing. Figure 3-1 shows the typical test setup. In Band 2, one channel selected between 5260 and 5350 MHz is chosen for the testing. In Band 3, one channel selected between 5500 and 5700 MHz was chosen for testing.

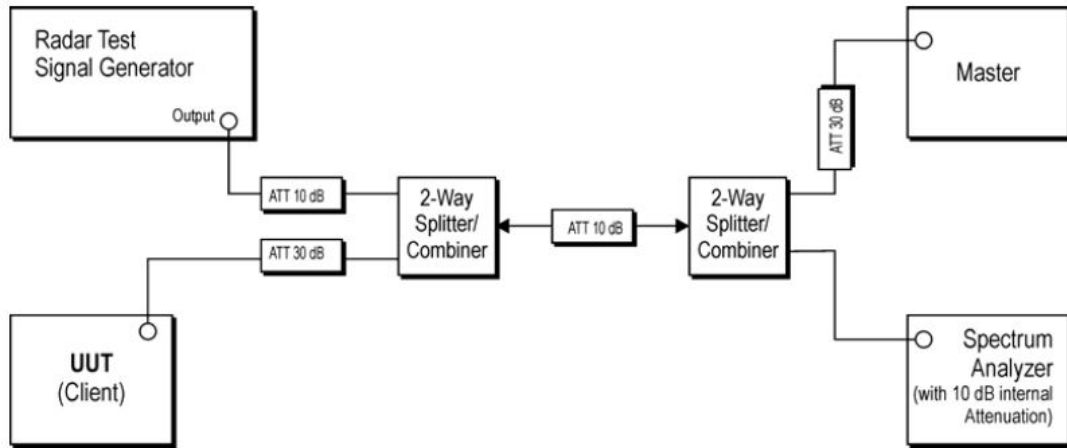




Figure 3-1. Conducted Test Setup for DFS



1. The radar pulse generator is setup to provide a pulse at the frequency that the Master and Client are operating. A Type 1 radar pulse with a 1μs pulse width and a 1428μs PRI is used for the testing.
2. The vector signal generator is adjusted to provide the radar burst (18 pulses) at a level of approximately -62dBm at the antenna of the Master device.
3. A trigger is provided from the pulse generator to the DFS monitoring system in order to capture the traffic and the occurrence of the radar pulse.
4. The Client Device (EUT) is set up per the diagram in Figure 3-1 and communications between the Master device and the Client is established.

FCC ID: ZNFLS980		FCC Pt. 15.407 DFS TEST REPORT (CLASS II PERMISSIVE CHANGE)		Reviewed by: Quality Manager
Test Report S/N: 0Y1307031180.ZNF	Test Dates: 8/6/2013	EUT Type: Portable Handset		Page 9 of 20

5. The MPEG file specified by the FCC (“6 ½ *Magic Hours*”) is streamed from the “file computer” through the Master to the Slave Device and played in full motion video using Media Player Classic Ver. 6.4.8.6 in order to properly load the network.
  
6. The real time spectrum analyzer is set to record a 12sec window to any transmissions occurring up to and after 10sec.
  
7. The system is again setup and the monitoring time is shortened in order to capture the Channel Closing Transmission Time. This time is measured to insure that the Client ceases transmission within 200ms and the aggregate of emissions occurring after 200ms up to 10 sec do not exceed 60ms.

(Note: the channel may be different since the Master and Client have changed channels due to the detection of the initial radar pulse.)

8. After the initial radar burst the channel is monitored for 30 minutes to insure no transmissions or beacons occur. A second monitoring setup is used to verify that the Master and Client have both moved to different channels.

FCC ID: ZNFLS980		FCC Pt. 15.407 DFS TEST REPORT (CLASS II PERMISSIVE CHANGE)		Reviewed by: Quality Manager
Test Report S/N: 0Y1307031180.ZNF	Test Dates: 8/6/2013	EUT Type: Portable Handset	Page 10 of 20	

## 4.0 TEST EQUIPMENT

Test Equipment Calibration is traceable to the National Institute of Standards and Technology (NIST).

Manufacturer	Model	Description	Cal Date	Cal Interval	Cal Due	Serial Number
Agilent	E4448A	PSA (3Hz-50GHz) Spectrum Analyzer	4/18/2013	Annual	4/18/2014	US42510244
Agilent	E8267C	Vector Signal Generator	10/10/2011	Biennial	10/10/2013	US42340152
Tektronix	RSA-6114A	Real Time Spectrum Analyzer	4/17/2013	Annual	4/17/2014	B010177



**Table 4-1. Annual Test Equipment Calibration Schedule**

### 4.1 Additional Equipment

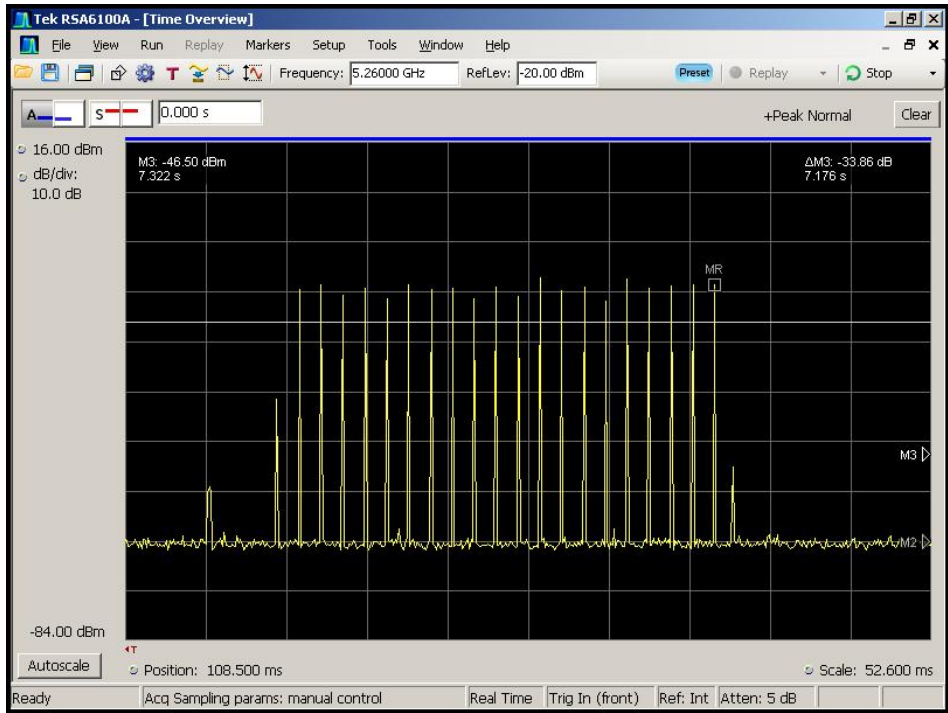
The following equipment was used in support of the DFS testing.

Device	Manufacturer	Model/Description	Description	S/N:	FCC ID:
Master	Cisco Systems	Aironet AIR-AP1242AG-A-K9	Access Point	FTX1114B151	LDK102056

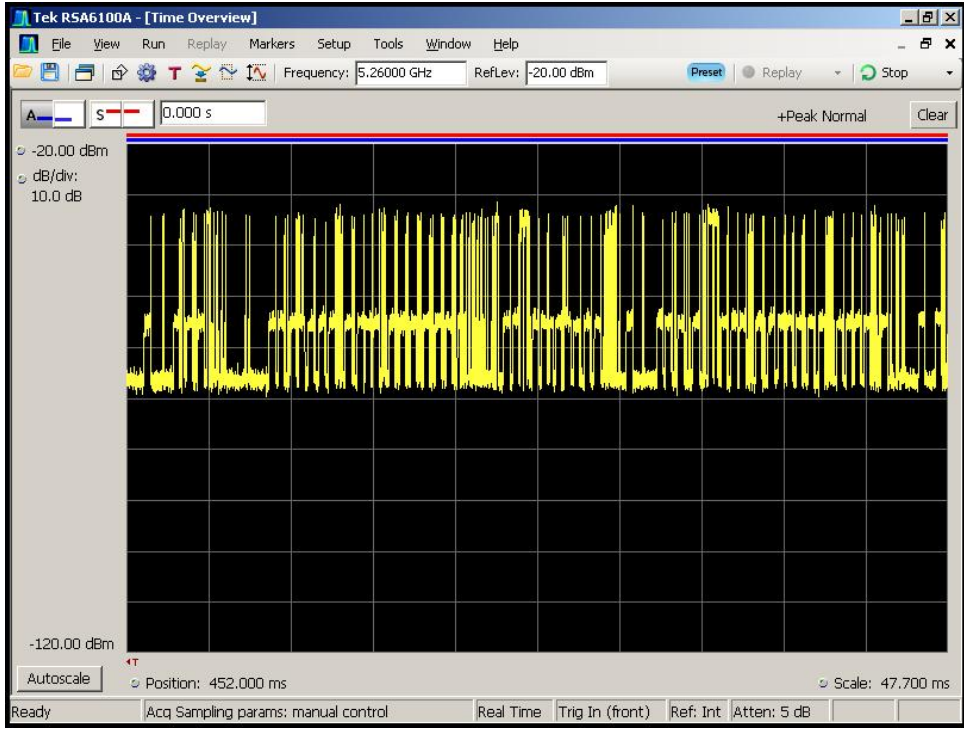
**Table 4-2. Support Equipment**

FCC ID: ZNFLS980		FCC Pt. 15.407 DFS TEST REPORT (CLASS II PERMISSIVE CHANGE)		Reviewed by: Quality Manager
Test Report S/N: 0Y1307031180.ZNF	Test Dates: 8/6/2013	EUT Type: Portable Handset	Page 11 of 20	

# 5.0 TEST PLOTS AND DATA - UNII BAND II

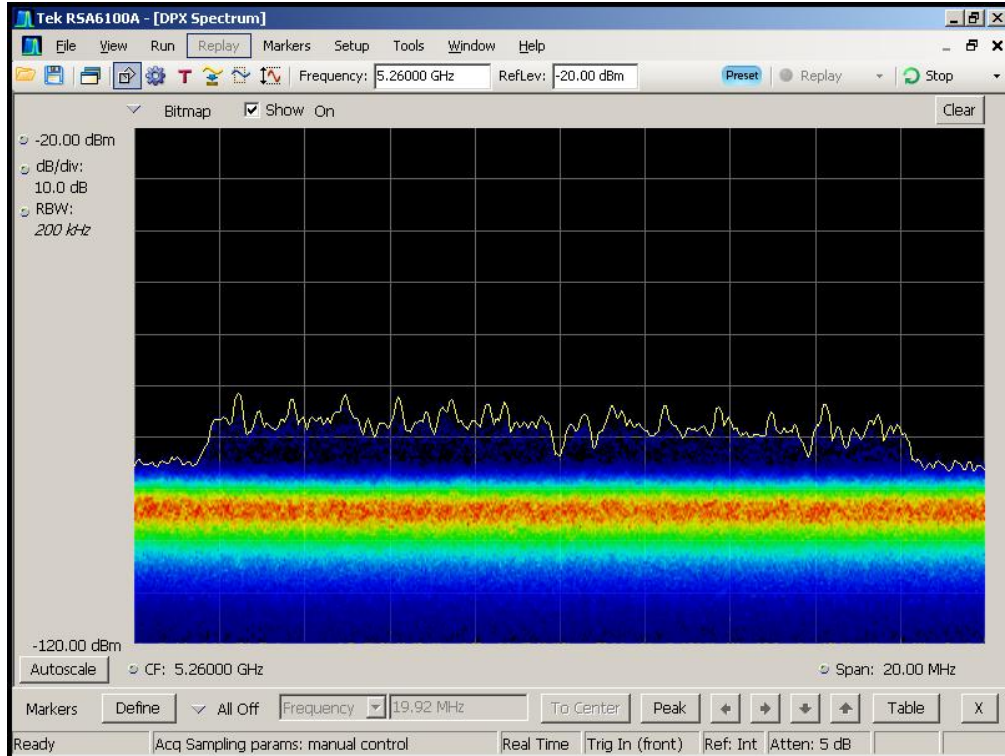


**Figure 5-1. Type 1 Radar Pulse**

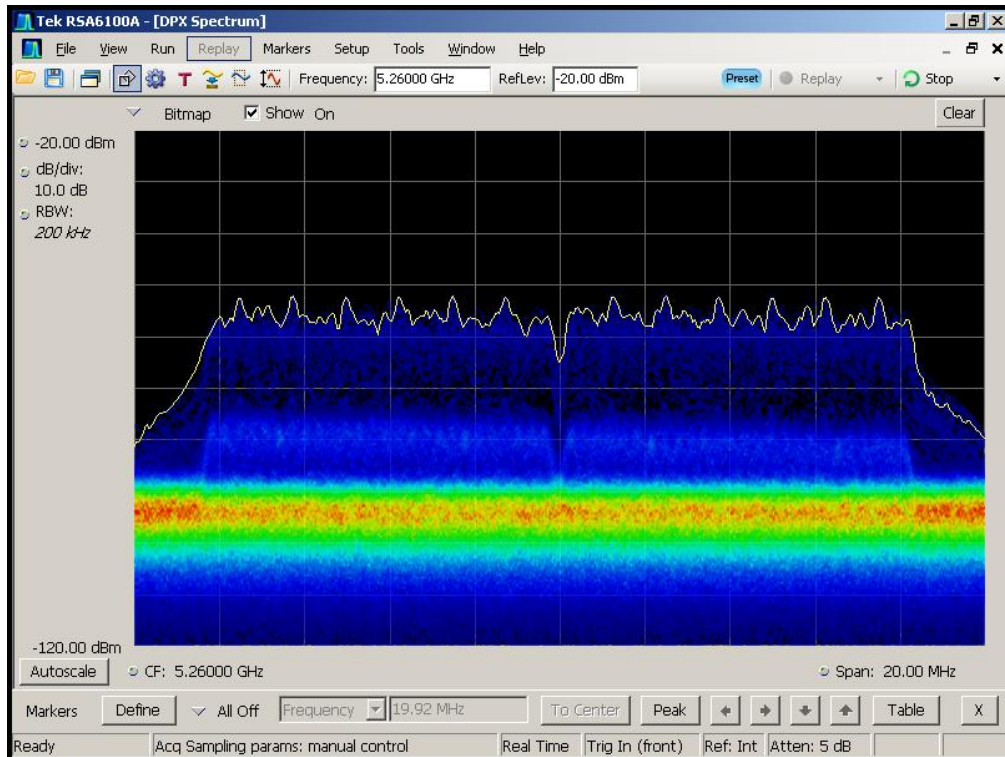


**Figure 5-2. Time Display WLAN Channel Traffic (Streaming Video)**

FCC ID: ZNFLS980		<b>FCC Pt. 15.407 DFS TEST REPORT (CLASS II PERMISSIVE CHANGE)</b>	
Test Report S/N: 0Y1307031180.ZNF	Test Dates: 8/6/2013	EUT Type: Portable Handset	Reviewed by: Quality Manager
			Page 12 of 20

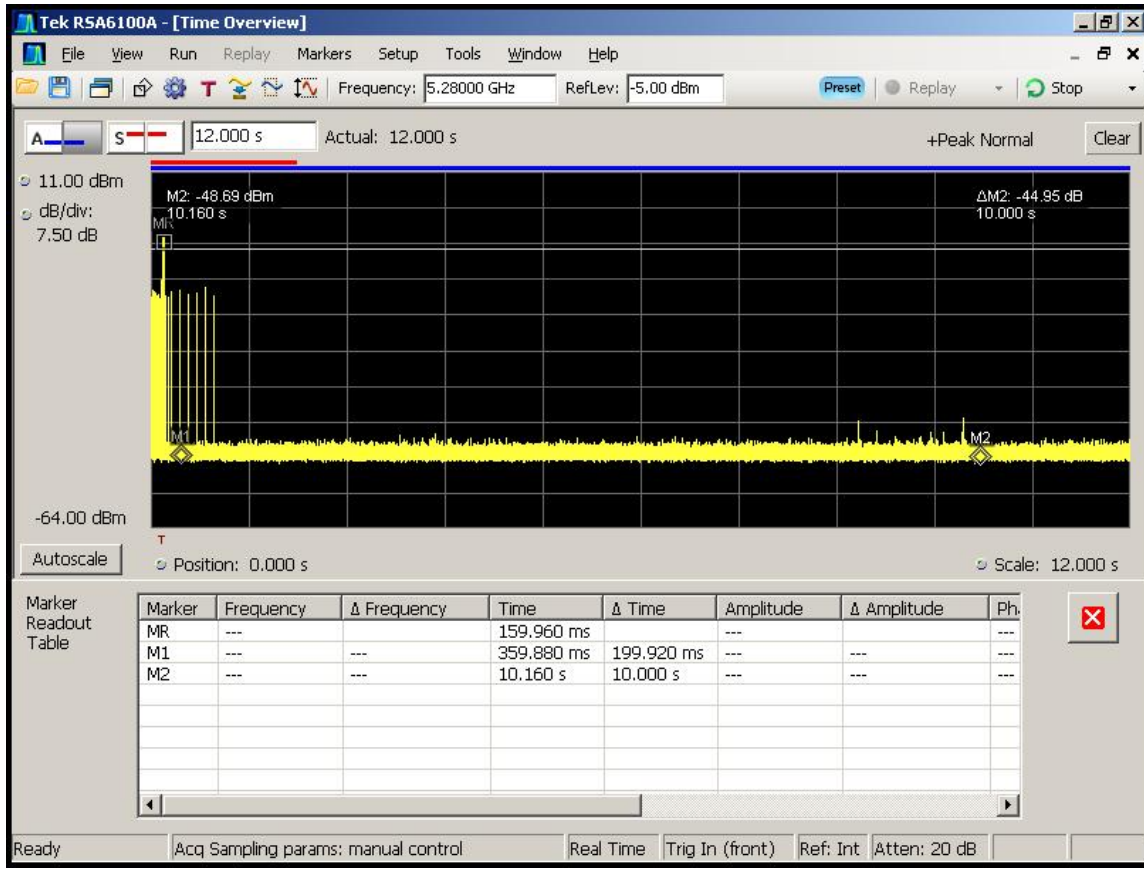


**Figure 5-3. Real-Time Spectrum Display, No WLAN Traffic**



**Figure 5-4. Real-Time Spectrum Display, WLAN Traffic (Streaming Video)**

FCC ID: ZNFLS980		FCC Pt. 15.407 DFS TEST REPORT (CLASS II PERMISSIVE CHANGE)		Reviewed by: Quality Manager
Test Report S/N: 0Y1307031180.ZNF	Test Dates: 8/6/2013	EUT Type: Portable Handset		Page 13 of 20



**Figure 5-5. Channel Move Time (< 10sec)**

**Move Time Marker Descriptions:**

MR = End of Radar Burst

M1 = 200ms from end of Radar Burst

M2 = 10sec from end of Burst

FCC ID: ZNFLS980	PCTEST ENGINEERING LABORATORY, INC.	FCC Pt. 15.407 DFS TEST REPORT (CLASS II PERMISSIVE CHANGE)	LG	Reviewed by: Quality Manager
Test Report S/N: 0Y1307031180.ZNF	Test Dates: 8/6/2013	EUT Type: Portable Handset		Page 14 of 20

### Calculation of Aggregate Time:

Only client (EUT) transmission pulses after M1 (marker1 @ 200ms) were analyzed. No client pulses were detected after M1.

Band	Number of Pulses	Aggregate Time (ms)	Limit (ms)	Pass/Fail
2	0	0.00	60	Pass

Table 5-1. Summary of Pulse Table Analysis

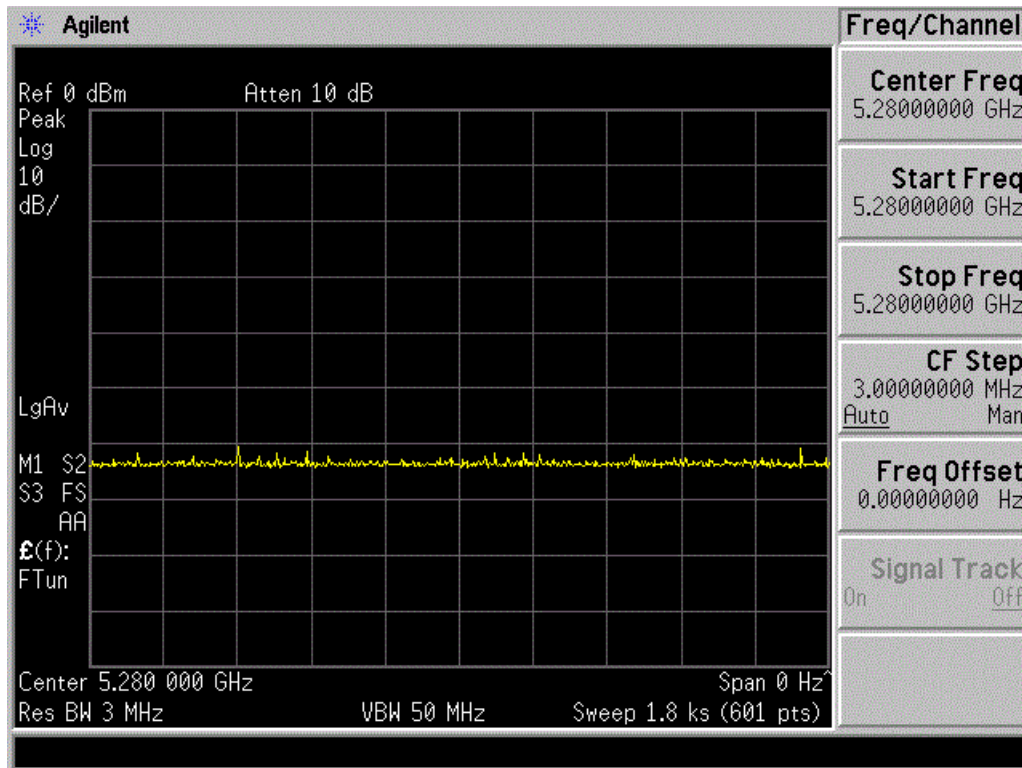
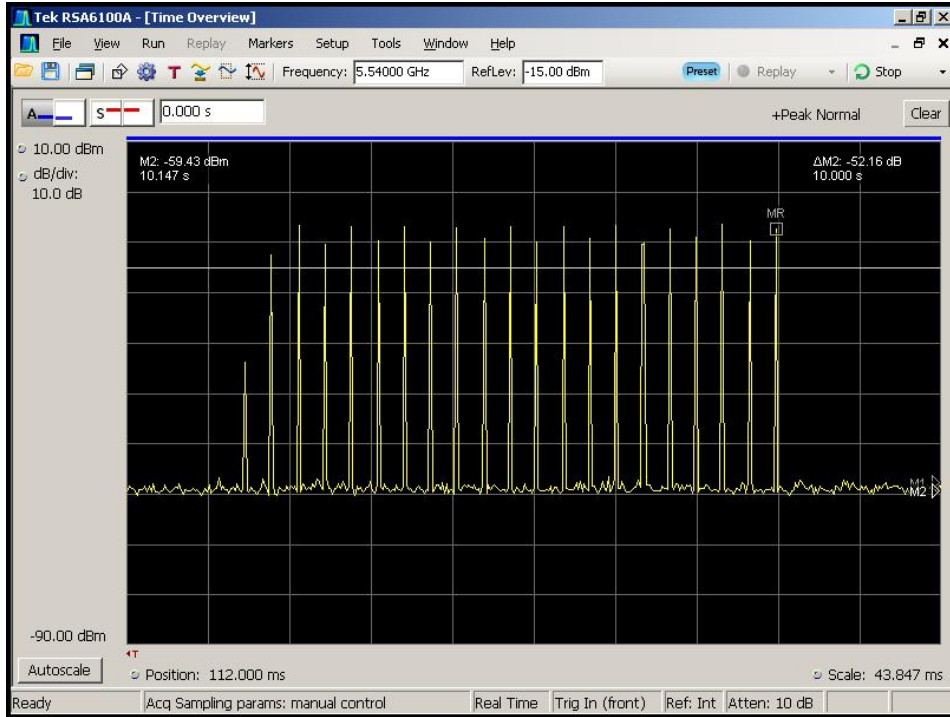


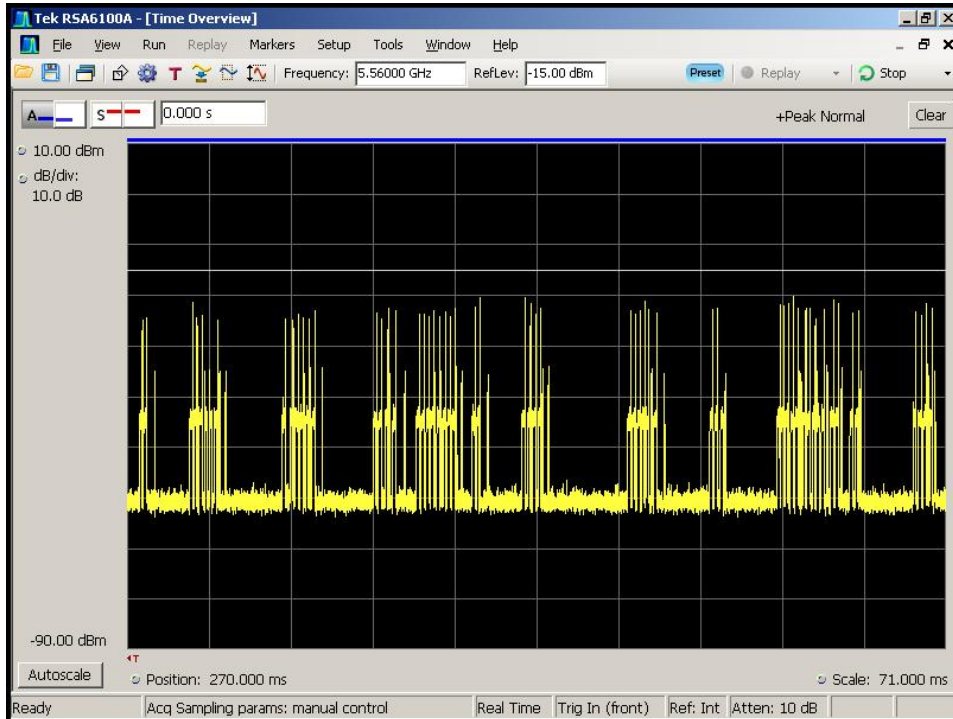
Figure 5-6 Non-occupancy Period - Monitoring live spectrum - Elapse time 30 minutes

FCC ID: ZNFLS980		FCC Pt. 15.407 DFS TEST REPORT (CLASS II PERMISSIVE CHANGE)		Reviewed by: Quality Manager
Test Report S/N: 0Y1307031180.ZNF	Test Dates: 8/6/2013	EUT Type: Portable Handset		Page 15 of 20



## 6.0 TEST PLOTS AND DATA - UNII BAND III



**Figure 6-1. Type 1 Radar Pulse**



**Figure 6-2. Time Display WLAN Channel Traffic (Streaming Video)**

FCC ID: ZNFLS980		FCC Pt. 15.407 DFS TEST REPORT (CLASS II PERMISSIVE CHANGE)		Reviewed by: Quality Manager
Test Report S/N: 0Y1307031180.ZNF	Test Dates: 8/6/2013	EUT Type: Portable Handset		Page 16 of 20



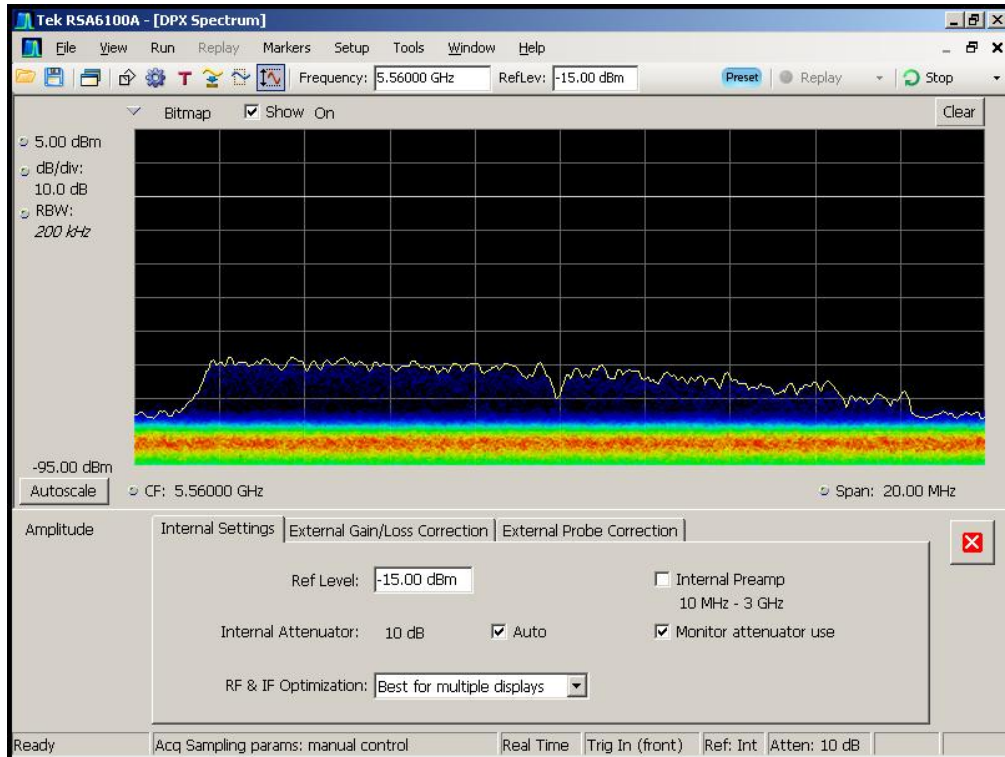


Figure 6-3. Real-Time Spectrum Display, No WLAN Traffic

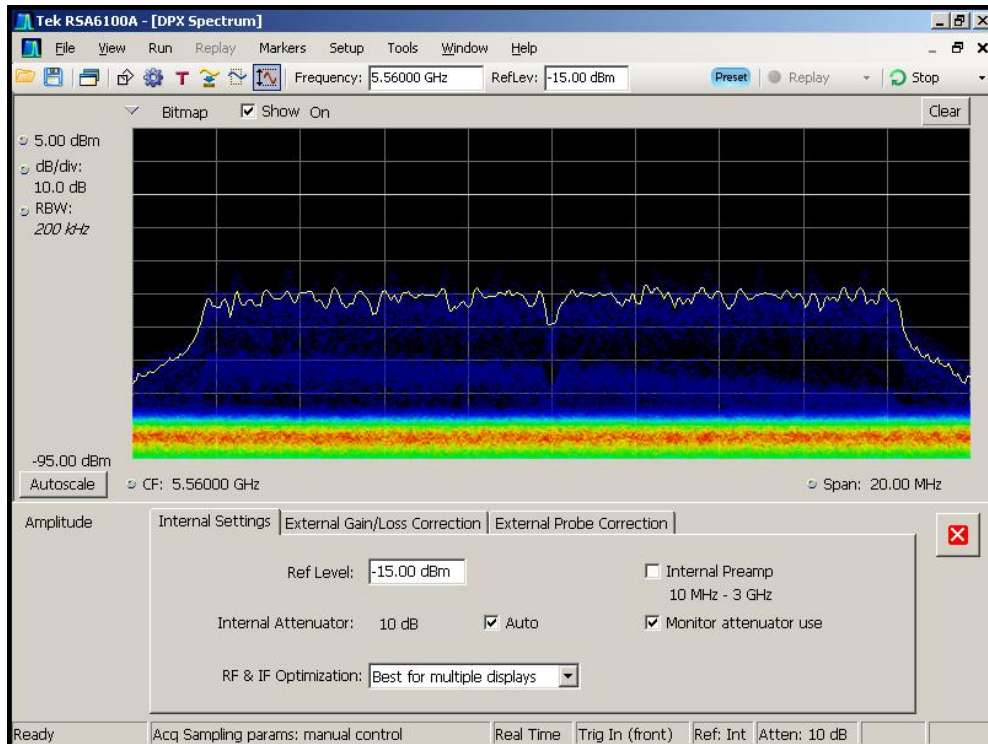
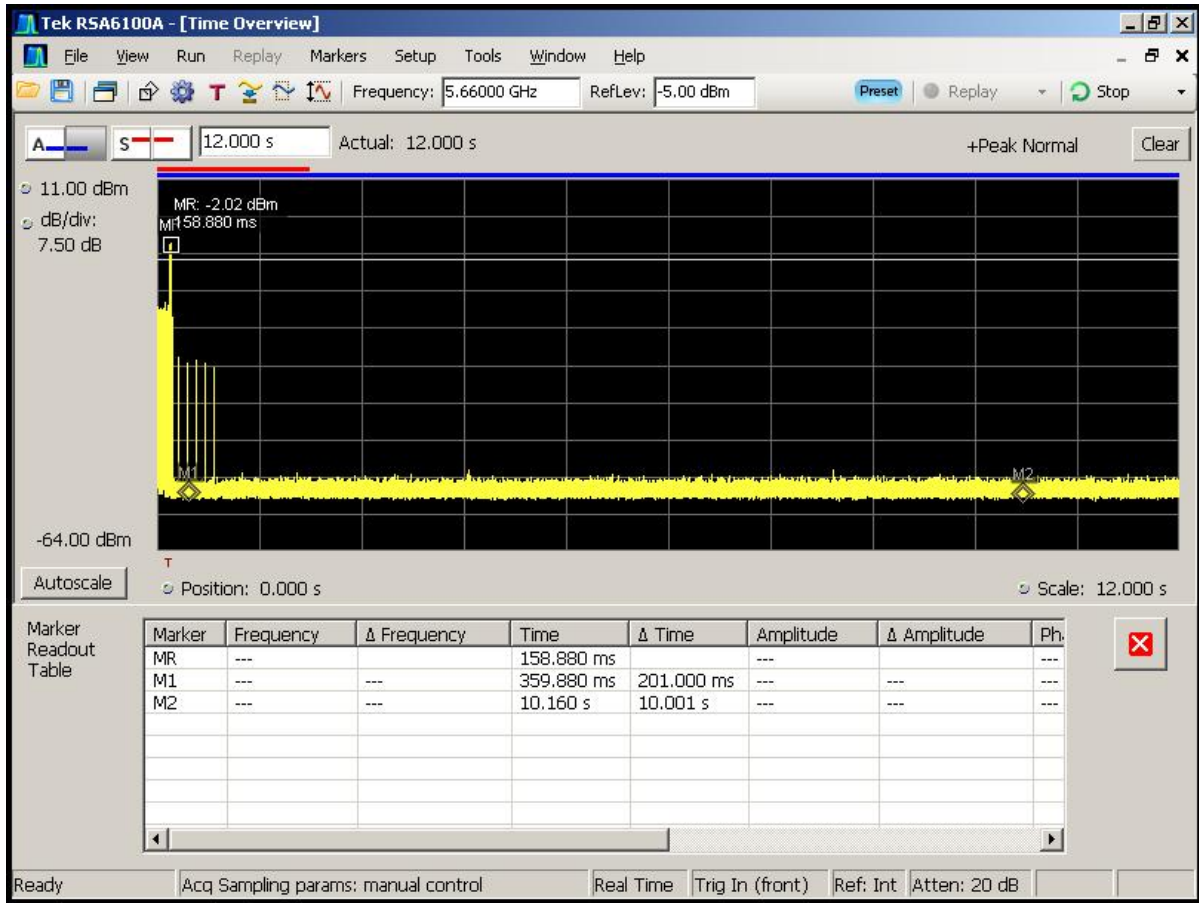


Figure 6-4. Real-Time Spectrum Display, WLAN Traffic (Streaming Video)

FCC ID: ZNFLS980		FCC Pt. 15.407 DFS TEST REPORT (CLASS II PERMISSIVE CHANGE)		Reviewed by: Quality Manager
Test Report S/N: 0Y1307031180.ZNF	Test Dates: 8/6/2013	EUT Type: Portable Handset		Page 17 of 20



**Figure 6-5. Channel Move Time (< 10sec)**

**Marker Descriptions:**

MR = End of Radar Burst

M1 = 200ms from end of Radar Burst

M2 = 10sec from end of Burst

FCC ID: ZNFLS980		FCC Pt. 15.407 DFS TEST REPORT (CLASS II PERMISSIVE CHANGE)		Reviewed by: Quality Manager
Test Report S/N: 0Y1307031180.ZNF	Test Dates: 8/6/2013	EUT Type: Portable Handset		Page 18 of 20

### Calculation of Aggregate Time:

Only client (EUT) transmission pulses after M1 (marker1 @ 200ms) were analyzed. No client pulses were detected after M1.

Figure 6-6. Aggregate Time using Pulse Table Capability

Band	Number of Pulses	Aggregate Time (ms)	Limit (ms)	Pass/Fail
3	0	0.00	60	Pass

Table 6-1. Summary of Pulse Table Analysis

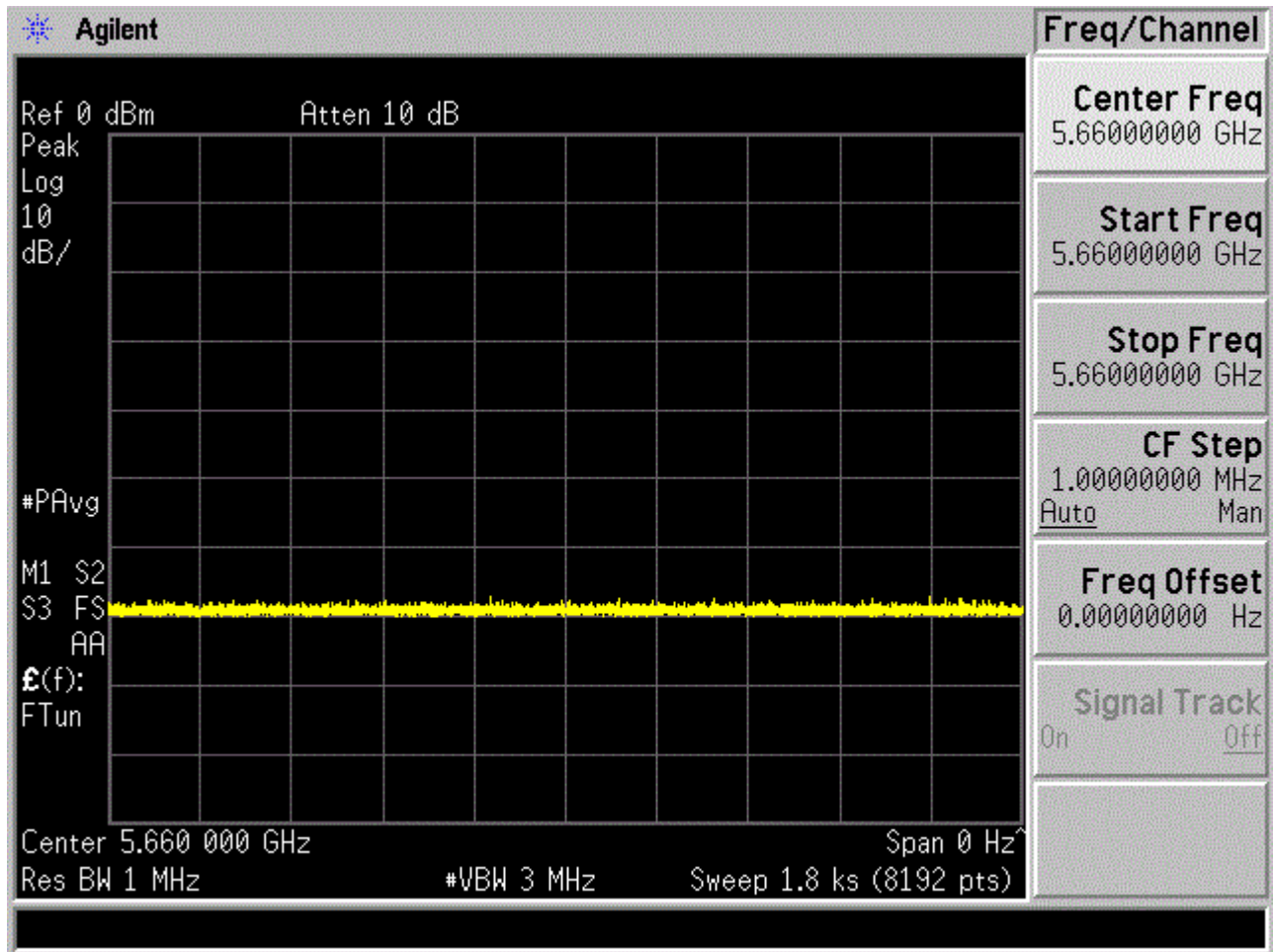




Figure 6-7. Non-occupancy Period - Monitoring live spectrum - Elapse time 30 minutes

FCC ID: ZNFLS980		FCC Pt. 15.407 DFS TEST REPORT (CLASS II PERMISSIVE CHANGE)		Reviewed by: Quality Manager
Test Report S/N: 0Y1307031180.ZNF	Test Dates: 8/6/2013	EUT Type: Portable Handset		Page 19 of 20

## 7.0 CONCLUSION

The data collected relate only to the item(s) tested and show that the LG **Portable Handset FCC ID: ZNFLS980** is in compliance with the DFS requirements for a Client Device without radar detection in accordance with Part 15.407 of the FCC Rules.

<b>FCC ID:</b> ZNFLS980		<b>FCC Pt. 15.407 DFS TEST REPORT (CLASS II PERMISSIVE CHANGE)</b>		<b>Reviewed by:</b> Quality Manager
<b>Test Report S/N:</b> 0Y1307031180.ZNF	<b>Test Dates:</b> 8/6/2013	<b>EUT Type:</b> Portable Handset		Page 20 of 20