



**FCC CFR47 PART 20.19
ANSI C63.19-2007**

HAC T-COIL SIGNAL TEST REPORT

For

Cellular/PCS BC 10 CDMA and LTE Phone with Bluetooth and WLAN

**MODEL: LS840, LGLS840 and LG-LS840
FCC ID: ZNFLS840**

**REPORT NUMBER: 11U14124-13
ISSUE DATE: November 29, 2011**

Prepared for
**LG ELECTRONICS MOBILECOMM U.S.A., INC.
10101 OLD GROVE ROAD
SAN DIEGO, CA 92131**

Prepared by
**COMPLIANCE CERTIFICATION SERVICES (UL CCS)
47173 BENICIA STREET
FREMONT, CA 94538, U.S.A.
TEL: (510) 771-1000
FAX: (510) 661-0888**



NVLAP LAB CODE 200065-0

Revision History

<u>Rev.</u>	<u>Issue Date</u>	<u>Revisions</u>	<u>Revised By</u>
--	November 29, 2011	Initial Issue	--

Table of Contents

1. Attestation of Test Results	4
2. Test Methodology	5
3. Facilities and Accreditation	5
4. Calibration and Uncertainty	6
4.1. <i>Measuring Instrument Calibration.....</i>	<i>6</i>
4.2. <i>Measurement Uncertainty.....</i>	<i>7</i>
5. Equipment Under Test	8
5.1. <i>List of Air Interfaces/Bands & Operating Modes.....</i>	<i>8</i>
6. Test Procedures.....	9
7. Establish WD Reference Level	11
8. T-coil Measurement Criteria.....	13
8.1. <i>Frequency Response</i>	<i>13</i>
8.2. <i>Signal Quality</i>	<i>14</i>
9. T-coil Test Results.....	15
9.1. <i>Test Plots (Frequency Response & SNR).....</i>	<i>16</i>
10. Appendix.....	28
11. Setup Photo	31

1. Attestation of Test Results

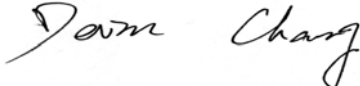
Applicant:	LG ELECTRONICS MOBILECOMM U.S.A., INC.	
EUT Description:	Cellular/PCS BC10 CDMA and LTE Band 25 Phone with Bluetooth and WLAN	
Model number:	LS840, LGLS840 and LG-LS840 IMEI: 99000074000554	
Device category:	Portable	
Exposure category:	General Population/Uncontrolled Exposure	
Date tested:	November 8, 2011	
T-Coil Signal Quality Category: T4		
Applicable Standards		Test Results
ANSI C63.19-2007		Pass
<p>Compliance Certification Services, Inc. (UL CCS) tested the above equipment in accordance with the requirements set forth in the above standards. All indications of Pass/Fail in this report are opinions expressed by UL CCS based on interpretations and/or observations of test results. Measurement Uncertainties were not taken into account and are published for informational purposes only. The test results show that the equipment tested is capable of demonstrating compliance with the requirements as documented in this report.</p> <p>Note: The results documented in this report apply only to the tested sample, under the conditions and modes of operation as described herein. This document may not be altered or revised in any way unless done so by UL CCS and all revisions are duly noted in the revisions section. Any alteration of this document not carried out by UL CCS will constitute fraud and shall nullify the document. This report must not be used by the client to claim product certification, approval, or endorsement by NVLAP, NIST, any agency of the Federal Government, or any agency of any government (NIST Handbook 150, Annex A). This report is written to support regulatory compliance of the applicable standards stated above.</p>		
Approved & Released For CCS By:	Tested By:	
		
Sunny Shih Engineering Team Leader Compliance Certification Services (UL CCS)	Devin Chang EMC Engineer Compliance Certification Services (UL CCS)	

2. Test Methodology

The tests documented in this report were performed in accordance with ANSI C63.19-2007 Methods of Measurement of Compatibility between Wireless Communications Devices and Hearing Aids and FCC KDB 285076 D01 HAC Guidance v02r01

3. Facilities and Accreditation

The test sites and measurement facilities used to collect data are located at 47173 Benicia Street, Fremont, California, USA.

UL CCS is accredited by NVLAP, Laboratory Code 200065-0. The full scope of accreditation can be viewed at <http://www.ccsemc.com>.

4. Calibration and Uncertainty

4.1. Measuring Instrument Calibration

The measuring equipment utilized to perform the tests documented in this report has been calibrated in accordance with the manufacturer's recommendations, and is traceable to recognized national standards.

Name of Equipment	Manufacturer	Type/Model	Serial Number	Cal. Due date		
				MM	DD	Year
Robot - Six Axes	Stäubli	TX90 XL	N/A	N/A		
Robot Remote Control	Stäubli	CS8C	N/A	N/A		
DASY5 Measurement Server	SPEAG	SEUMS001BA	1041	N/A		
Probe Alignment Unit	SPEAG	LB (V2)	261	N/A		
Audio Magnetic Measuring Ins.l	SPEAG	AMMI	1127	N/A		
Coordinating Systeml	SPEAG	AMCC	N/A	N/A		
ABM Probe	SPEAG	AM1DV3	3092	4	13	2012
Data Acquisition Electronics	SPEAG	DAE4	1257	10	25	2012
Radio Communication Tester	R &S	CMU 200	54-1008661	2	16	2012

4.2. Measurement Uncertainty

Measurement Uncertainty for Audio Band Magnetic Measurement

Error Description	Uncertainty values (%)	Probe Dist.	Div.	c AMB1	c AMB2	Std. Unc.	
						AMB1 (%)	AMB2 (%)
Probe Sensitivity							
Reference level	3.0	N	1	1.00	1.00	3.00	3.00
AMCC geometry	0.4	R	1.73	1.00	1.00	0.23	0.23
AMCC current	0.6	R	1.73	1.00	1.00	0.35	0.35
Probe positioning during calibration	0.1	R	1.73	1.00	1.00	0.06	0.06
Noise contribution	0.7	R	1.73	0.01	1.00	0.01	0.40
Frequency slope	5.9	R	1.73	0.10	1.00	0.34	3.41
Probe System							
Repeatability / drift	1.0	R	1.73	1.00	1.00	0.58	0.58
Linearity / Dynamic range	0.6	R	1.73	1.00	1.00	0.35	0.35
Acoustic noise	1.0	R	1.73	0.10	1.00	0.06	0.58
Probe angle	2.3	R	1.73	1.00	1.00	1.33	1.33
Spectral processing	0.9	R	1.73	1.00	1.00	0.52	0.52
Integration time	0.6	N	1.00	1.00	5.00	0.60	3.00
Field disturbance	0.2	R	1.73	1.00	1.00	0.12	0.12
Test Signal							
Reference signal spectral response	0.6	R	1.73	0.00	1.00	0.00	0.35
Positioning							
Probe positioning	1.9	R	1.73	1.00	1.00	1.10	1.10
Phantom positioning	0.9	R	1.73	1.00	1.00	0.52	0.52
EUT positioning	1.9	R	1.73	1.00	1.00	1.10	1.10
External Contributions							
RF interference	0.0	R	1.73	1.00	1.00	0.00	0.00
Test signal variation	2.0	R	1.73	1.00	1.00	1.15	1.15
Combined Std. Uncertainty (ABM field)						4.02	6.08
Expanded Std. Uncertainty (%)						8.04	12.15
Notes for table							
1. N - Nomal							
2. R - Rectangular							
3. Div. - Divisor used to obtain standard uncertainty							

5. Equipment Under Test

Cellular/PCS BC10 CDMA and LTE Band 25 Phone with Bluetooth and WLAN
 MODEL: LS840, LGLS840 and LG-LS840

5.1. List of Air Interfaces/Bands & Operating Modes

Air-Interface	Bands (MHz)	Type	C63.19/ Tested	Simultaneous Transmissions Note: Not to be tested	Concurrent single transmission	Reduced power 20.19 (c) (1)	Voice Over Digital Transport (Data)
CDMA	800 (BC0/BC10)	VO	Yes	Yes LTE, EV-DO, WiFi and Bluetooth	Yes: EV-DO, LTE, WiFi and Bluetooth	N/A	N/A
	1900		Yes				
	EV-DO	DT	N/A	N/A	Yes: * see note	Yes: **SVDO mode only	Yes
LTE	Band 25	DT	N/A	Yes EV-DO, WiFi and Bluetooth	Yes: * see note	Yes: **SVLTE mode only	Yes
WiFi	2450	DT	N/A	Yes CDMA,GSM,UMTE, LTE, EV-DO and Bluetooth	N/A	N/A	Yes
Bluetooth	2400	DT	N/A	Yes CDMA,GSM,UMTE, LTE, EV-DO and WiFi	N/A	N/A	N/A
VO Voice CMRS/PTSN Service Only V/D Voice CMRS/PSTN and Data Service DT Digital Transport				Note(s): * HAC Rating was not base on concurrent voice and data modes, Noncurrent mode was found to represent worst case rating. For M rating ** SVDO: CDMA voice and EVDO Simultaneously transmission SVLTE: CDMA voice and LTE Simultaneously transmission			

6. Test Procedures

ANSI C63.19-2007, Section 6

This document describes the procedures used to measure the ABM (T-Coil) performance of the WD. In addition to measuring the absolute signal levels, the A-weighted magnitude of the unintended signal shall also be determined. In order to assure that the required signal quality is measured, the measurement of the intended signal and the measurement of the unintended signal must be made at the same location for all measurement positions. In addition, the RF field strength at each measurement location must be at or below that required for the assigned category.

Measurements shall not include undesired properties from the WD's RF field; therefore, use of a coaxial connection to a base station simulator or non-radiating load may be necessary. However, even then with a coaxial connection to a base station simulator or non-radiating load there may still be RF leakage from the WD, which may interfere with the desired measurement. Pre-measurement checks should be made to avoid this possibility. All measurements shall be done with the WD operating on battery power with an appropriate normal speech audio signal input level given in Table 6.1. If the device display can be turned off during a phone call then that may be done during the measurement as well.

Measurements shall be performed at all three locations, with the correct probe orientation for a particular location, in a multi-stage sequence by first measuring the field intensity of the desired T-Coil signal (ABM1) that is useful to a hearing aid T-Coil. The undesired magnetic components (ABM2) shall be examined for each probe orientation to determine possible effects from the WD display and battery current paths that may disrupt the desired T-Coil signal. The undesired magnetic signal (ABM2) must be measured at the same location as the measurement of the desired ABM or T-Coil signal (ABM1) and the ratio of desired to undesired ABM signals calculated. For the axial field location only the ABM1 frequency response shall be determined in a third measurement stage. The flowchart in Figure 6.3 illustrates this three-stage, three-orientation process.

The following steps summarize the basic test flow for determining ABM1¹ and ABM2². These steps assume that a sine wave or narrowband 1/3 octave signal can be used for the measurement of ABM1.

- 1) A reference check of the test setup and instrumentation may be performed using a TMFS. Position the TMFS into the test setup at the position to be occupied by the WD. Measure the emissions from the TMFS and confirm that they are within tolerance of the expected values.
- 2) Position the WD in the test setup and connect the WD RF connector to a base station simulator or a non-radiating load as shown in Figure 6.1 or Figure 6.2. Confirm that equipment that requires calibration has been calibrated, and that the noise level meets the requirements given in 6.2.1.
- 3) The drive level to the WD is set such that the reference input level defined in 6.3.2.1, Table 6.1 is input to the base station simulator (or manufacturer's test mode equivalent) in the 1 kHz, 1/3 octave band. This drive level shall be used for the T-Coil signal test (ABM1) at $f = 1$ kHz. Either a sine wave at 1025 Hz or a voice-like signal, band-limited to the 1 kHz 1/3 octave, as defined in 6.3.2, shall be used for the reference audio signal. If interference is found at 1025 Hz an alternate nearby reference audio signal frequency may be used.⁴⁶ The same drive level will be used for the ABM1 frequency response measurements at each 1/3 octave band center frequency. The WD volume control may be set at any level up to maximum, provided that a signal at any frequency at maximum modulation would not result in clipping or signal overload.
- 4) Determine the magnetic measurement locations for the WD device (see A.3), if not already specified by the manufacturer, as described in 6.3.4.1.1 and 6.3.4.4.

¹ **Audio Band Magnetic signal - desired (ABM1):** Measured quantity of the desired magnetic signal

² **audio band magnetic signal - undesired (ABM2):** Measured quantity of the undesired magnetic signal, such as interference from battery current and similar non-signal elements.

- 5) At each measurement location, measure and record the desired T-Coil magnetic signals (ABM1 at f_i) as described in 6.3.4.2 in each individual ISO 266-1975 R10 standard 1/3 octave band. The desired audio band input frequency (f_i) shall be centered in each 1/3 octave band maintaining the same drive level as determined in Step 2) and the reading taken for that band.

Equivalent methods of determining the frequency response may also be employed, such as fast Fourier transform (FFT) analysis using noise excitation or input–output comparison using simulated speech. The full-band integrated or half-band integrated probe output, as described in D.18, may be used, as long as the appropriate calibration curve is applied to the measured result, so as to yield an accurate measurement of the field magnitude. (The resulting measurement shall be an accurate measurement in dB A/m.)

All measurements of the desired signal shall be shown to be of the desired signal and not of an undesired signal. This may be shown by turning the desired signal on and off with the probe measuring the same location. If the scanning method is used the scans shall show that all measurement points selected for the ABM1 measurement meet the ambient and test system noise criterion in 6.2.1.

- 6) At each measurement location measure and record the undesired broadband audio magnetic signal (ABM2) as described in 6.3.4.3 with no audio signal applied (or digital zero applied, if appropriate) using A-weighting, and the half-band integrator. Calculate the ratio of the desired to undesired signal strength (i.e., signal quality).
- 7) Change the probe orientation to one of the two remaining orientations. At both measurement orientations, measure and record ABM1 using either a sine wave at 1025 Hz or a voice-like signal as defined in 9) for the reference audio input signal.
- 8) Obtain the data from the postprocessor, SEMCAD, and determine the category that properly classifies the signal quality based on Table 7.7.

Test Setup Diagram

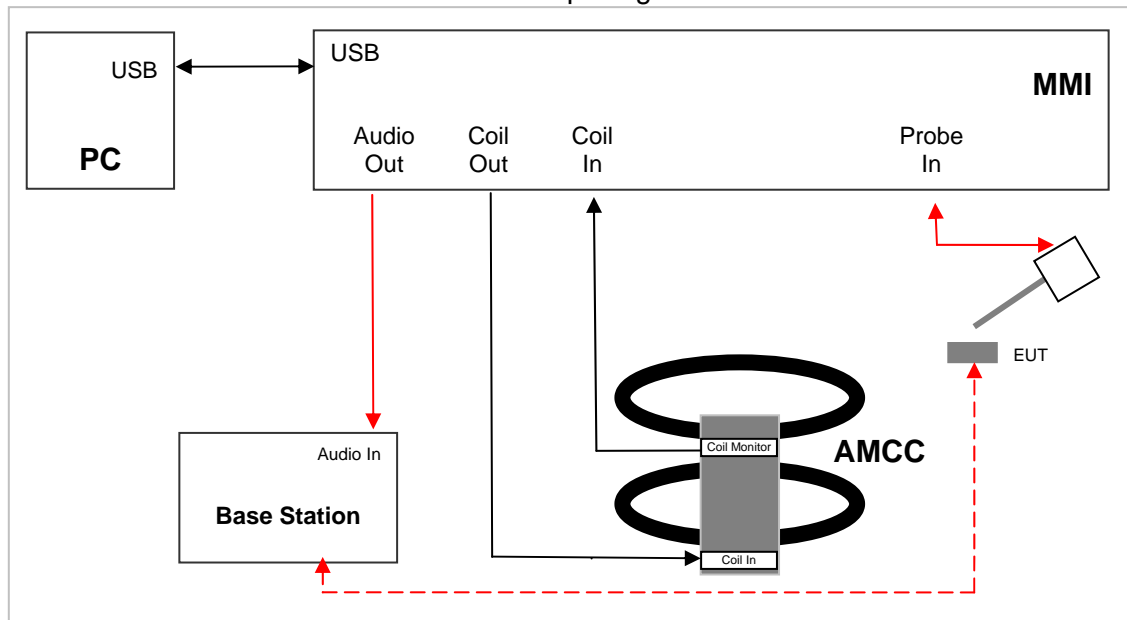

7. Establish WD Reference Level

First step is to find the Uref, which is 1 kHz signal output of the CMU200. The following figures show the setup for the measurements. The first step is to measure Uref and the following step is to measure U, which is the signal from AMMI to the CMU200 during testing.

The setup shown below is used to measure Uref. To measure the reference input level, first connect the Coil In of the AMMI to the Audio Out of the CMU200 (as indicated by the figure below). Then establish a conducted link between the EUT and the CMU200. Once the link is established, select the network tab of the CMU200 and change the bitstream setting to decoder cal in order for the CMU to produce the necessary calibration 1 kHz signal. Record the value from the Dasy4 file and use this value as Uref.

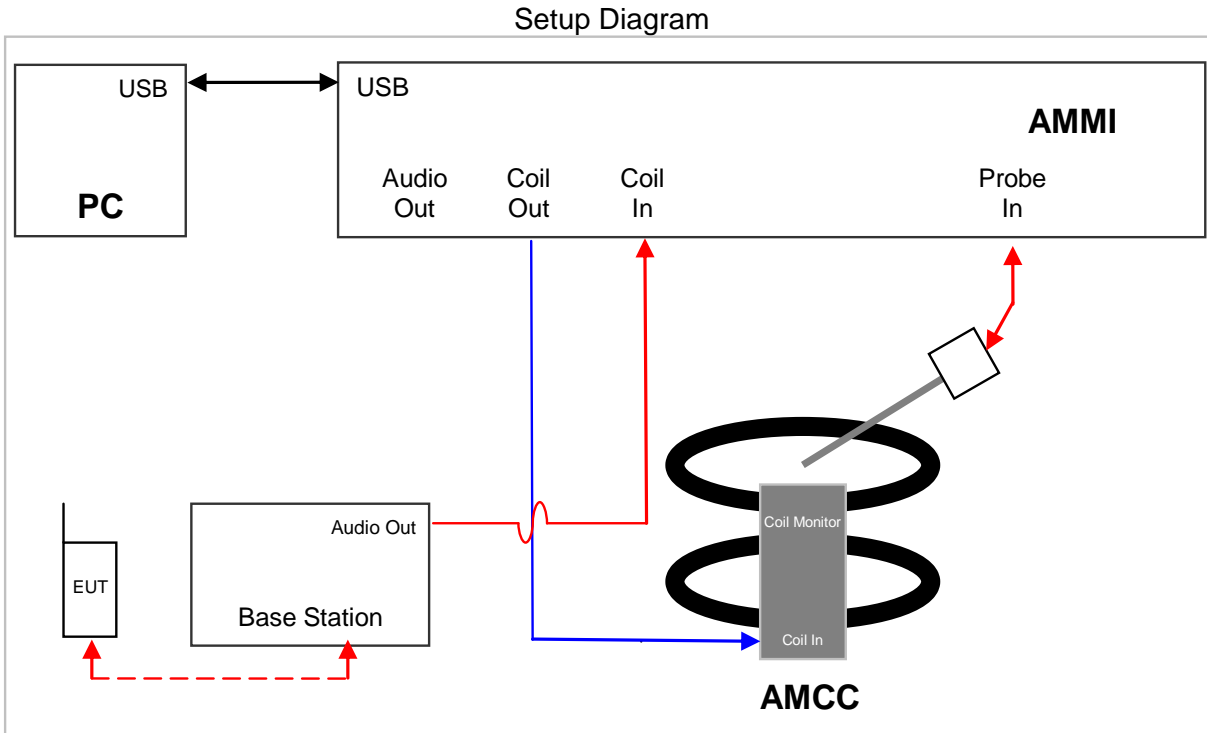

Next step is to measure U, which is the signal from AMMI to the CMU200 during testing. The following setup is used to measure U for narrow band (Voice1.025 kHz) and broad band (300 Hz – 300 kHz) signals:

To determine the DASY gain setting necessary to achieve the proper EUT signal level, connect the Coil In of AMMI to the Audio Out of AMMI. Run the narrow band job (Voice 1.025kHz signal setting) from DASY4 and record the RMS coil signal. Adjust the gain of the signal by changing the gain value within the particular DASY job until the coil signal reading is that of the desired output signal level. Repeat this step for the broad band job (Voice 300 – 3kHz signal).

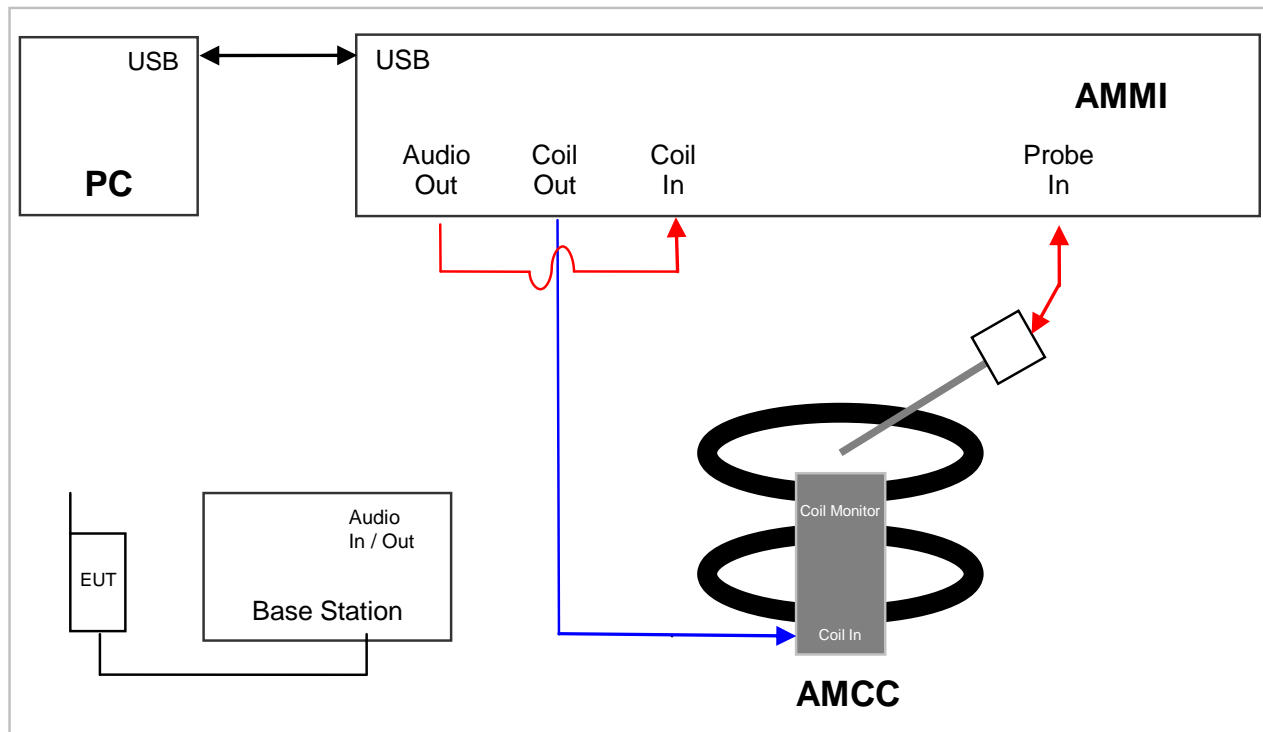

Measured Input Level is calculated: $Measured_Input_Level = 20 * \log\left(\frac{U}{U_{ref}}\right)$

RESULTS

CDMA2000

1 kHz Signal

Applied Signal	RMS V	Result Input Level (dBm0)	Reference Input Level (dBm0)
U	0.097	-18.0	CDMA -18.0
U _{ref}	0.767		GSM -16.0

Adjusted Gain Setting	RMS dB V
27.98	-20.266
N/A	-2.300

300 Hz-3 kHz Signal

Applied Signal	RMS V	Measured Input Level (dBm0)	Reference Input Level (dBm0)
U	0.097	-18.0	CDMA -18.0
U _{ref}	0.765		GSM -16.0

Gain Setting	RMS dB V
55.22	-20.280
N/A	-2.330

8. T-coil Measurement Criteria

8.1. Frequency Response

The frequency response of the axial component of the magnetic field, measured in 1/3 octave bands, shall follow the response curve, over the frequency range 300 Hz to 3000 Hz.

Figure 7.1 and Figure 7.2 provide the boundaries for the specified frequency. These response curves are for true field strength measurements of the T-Coil signal. Thus the 6 dB/octave probe response has been corrected from the raw readings.

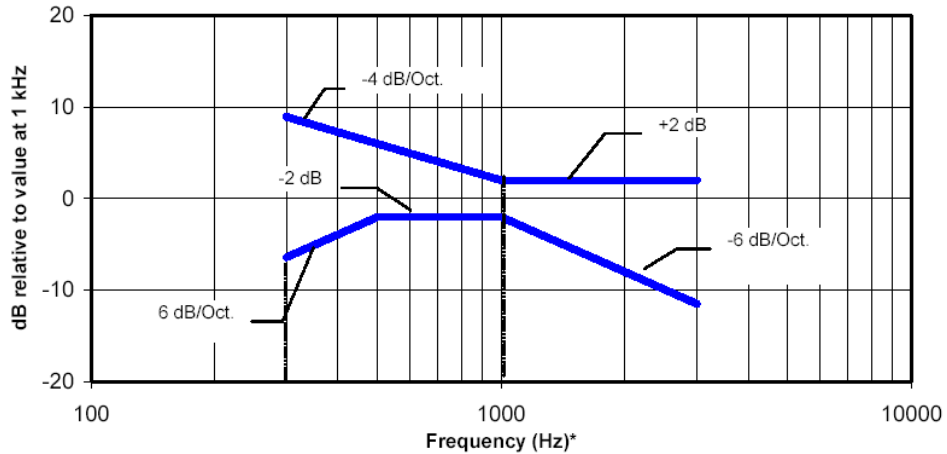

NOTE—Frequency response is between 300 Hz and 3000 Hz.

Figure 7.1—Magnetic field frequency response for WDs with a field ≤ -15 dB (A/m) at 1 kHz

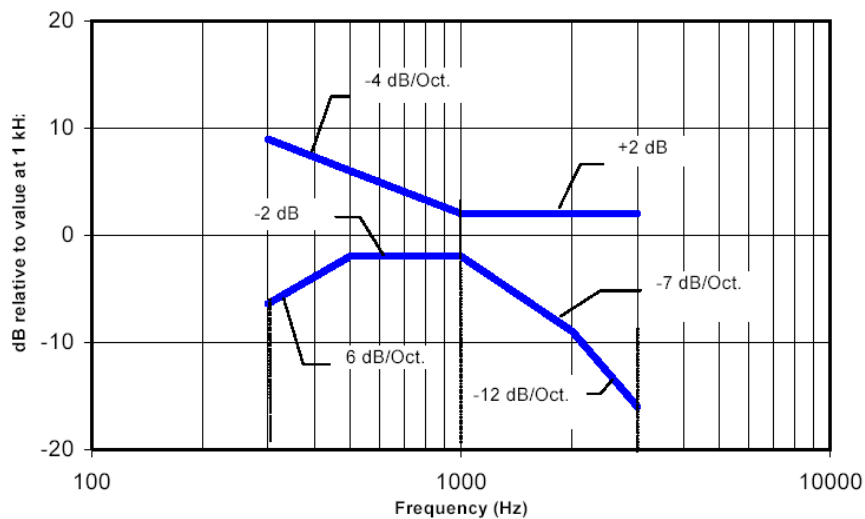

NOTE—Frequency response is between 300 Hz and 3000 Hz.

Figure 7.2—Magnetic field frequency response for WDs with a field that exceeds -15 dB(A/m) at 1 kHz

8.2. Signal Quality

This provides the signal quality requirement for the intended T-Coil signal from a WD. Only the RF immunity of the hearing aid is measured in T-Coil mode. It is assumed that a hearing aid can have no immunity to an interference signal in the audio band, which is the intended reception band for this mode. So, the only criteria that can be measured is the RF immunity in T-Coil mode. This is measured using the same procedure as for the audio coupling mode and at the same levels.

The worst signal quality of the three T-Coil signal measurements, as determined in Clause 6, shall be used to determine the T-Coil mode category per Table 7.7.

Table 7.7—T-Coil signal quality categories

Category	Telephone parameters WD signal quality [(signal + noise)-to-noise ratio in decibels]
Category T1	0 dB to 10 dB
Category T2	10 dB to 20 dB
Category T3	20 dB to 30 dB
Category T4	> 30 dB

9. T-coil Test Results

Test Mode	Ch. No/Freq.	Probe orientation	ABM1 ≥ -16 dB (A/m)	BWC Factor (dB)	ABM SNR (dB)	T-Rating
CDMA200 BC0 RC1/SO3 Voice Coder: 8k Enhanced (Low)	384/ 836.52 MHz	z (Axial):	10.14	0.16	43.12	T4
		x (longitudinal):	1.17	0.16	49.78	T4
		y (transversal):	1.89	0.16	49.70	T4
CDMA200 BC10 RC1/SO3 Voice Coder: 8k Enhanced (Low)	580/ 820.5 MHz	z (Axial):	9.5	0.16	41.91	T4
		x (longitudinal):	2.22	0.16	50.48	T4
		y (transversal):	2.74	0.16	51.95	T4
CDMA2000 BC1 RC1/SO3 Voice Coder: 8k Enhanced (Low)	600/ 1880 MHz	z (Axial):	11.06	0.16	44.14	T4
		x (longitudinal):	1.74	0.16	51.87	T4
		y (transversal):	2.74	0.16	52.85	T4

9.1. Test Plots (Frequency Response & SNR)

Test Plots for CDMA2000 BC0

Freq. Resp.

Date: 11/8/2011

Test Laboratory: UL CCS SAR Lab C

HAC T-Coil

Communication System: CDMA2000; Frequency: 1880 MHz; Duty Cycle: 1:1

CDMA2000 PCS/General Scans/z (axial) wideband at best S/N/ABM [HAC-2007] Freq Resp(x,y,z,f) (1x1x1):

Measurement grid: dx=10mm, dy=10mm
 Signal Type: Audio File (.wav) 48k_voice_300-3000_2s.wav
 Output Gain: 55.22
 Measure Window Start: 300ms
 Measure Window Length: 2000ms
 BWC applied: 10.80 dB
 Device Reference Point: 0, 0, -6.3 mm

Category	Telephone parameters WD signal quality [(signal+noise)-to-noise ratio in decibels]
Category T1	0 dB to 10 dB
Category T2	10 dB to 20 dB
Category T3	20 dB to 30 dB
Category T4	> 30 dB

Cursor:

Diff = 0.86 dB
 BWC Factor = 10.80 dB
 Location: 4.6, 0, 3.7 mm

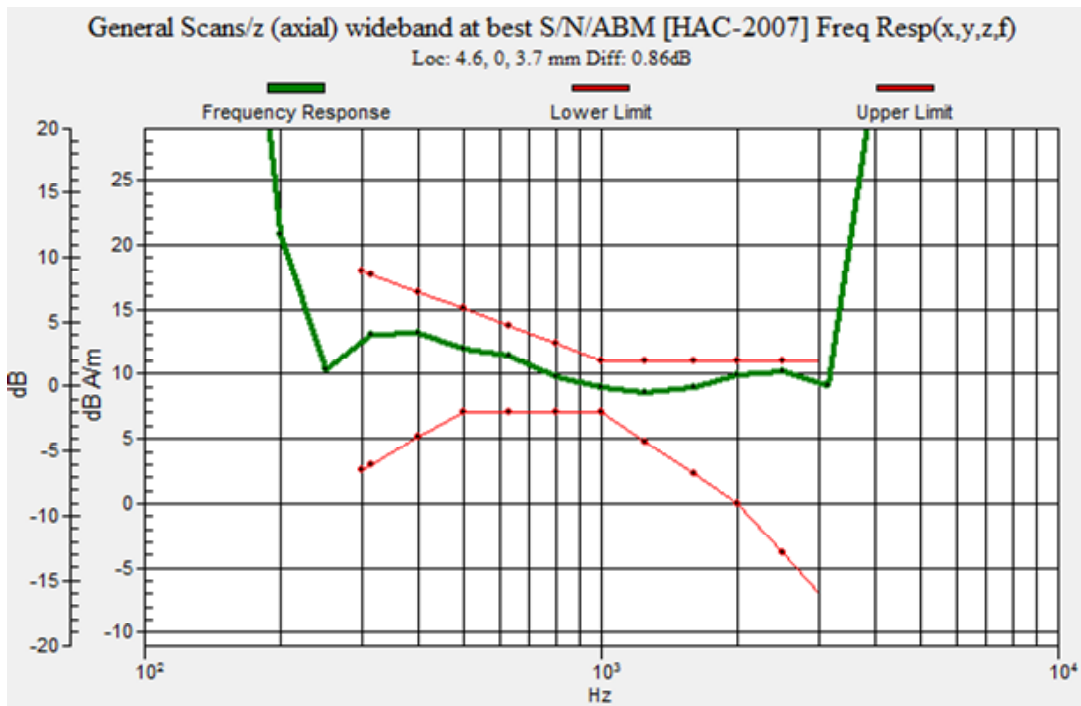

Z (Axial)

Date: 11/8/2011

Test Laboratory: UL CCS SAR Lab C

HAC T-Coil

Communication System: CDMA2000; Frequency: 1880 MHz;Duty Cycle: 1:1
Phantom section: TCoil Section
DASY4 Configuration:
- Probe: AM1DV3 - 3092; ; Calibrated: 4/13/2011
- Sensor-Surface: 0mm (Fix Surface)
- Electronics: DAE4 Sn1257; Calibrated: 10/25/2011
- Phantom: HAC Test Arch with AMCC; Type: SD HAC P01 BB
- Measurement SW: DASY52, Version 52.6 (2);SEMCAD X Version 14.4.5 (3634)

CDMA2000 PCS/General Scans/z (axial) 4.2mm 50 x 50/ABM [HAC-2007] Interpolated SNR(x,y,z) (121x121x1):

Measurement grid: dx=10mm, dy=10mm
Signal Type: Audio File (.wav) 48k_voice_1kHz_1s.wav
Output Gain: 27.98
Measure Window Start: 300ms
Measure Window Length: 1000ms
BWC applied: 0.16 dB
Device Reference Point: 0, 0, -6.3 mm

Cursor:

ABM1/ABM2 = 43.12 dB
ABM1 comp = 10.14 dB A/m
BWC Factor = 0.16 dB
Location: 4.2, 0, 3.7 mm

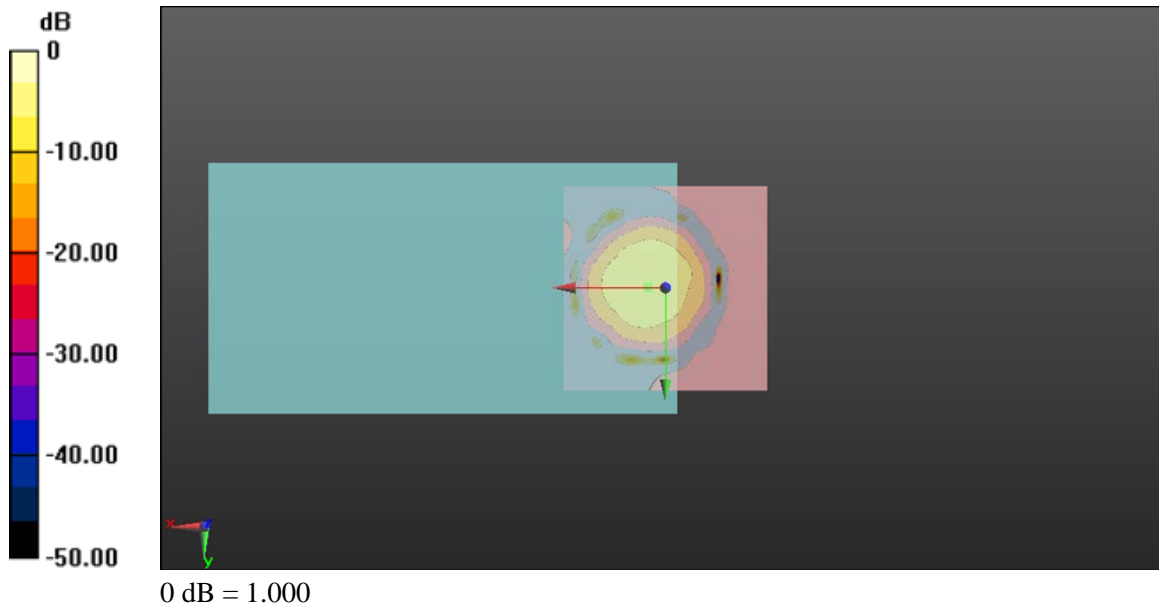

X (Longitudinal)

Date: 11/8/2011

Test Laboratory: UL CCS SAR Lab C

HAC T-Coil

Communication System: CDMA2000; Frequency: 1880 MHz;Duty Cycle: 1:1
Phantom section: TCoil Section
DASY4 Configuration:
- Probe: AM1DV3 - 3092; ; Calibrated: 4/13/2011
- Sensor-Surface: 0mm (Fix Surface)
- Electronics: DAE4 Sn1257; Calibrated: 10/25/2011
- Phantom: HAC Test Arch with AMCC; Type: SD HAC P01 BB
- Measurement SW: DASY52, Version 52.6 (2);SEMCAD X Version 14.4.5 (3634)

CDMA2000 PCS/General Scans/x (longitudinal) 4.2mm 50 x 50/ABM [HAC-2007] Interpolated SNR(x,y,z) (121x121x1):

Measurement grid: dx=10mm, dy=10mm
Signal Type: Audio File (.wav) 48k_voice_1kHz_1s.wav
Output Gain: 27.98
Measure Window Start: 300ms
Measure Window Length: 1000ms
BWC applied: 0.16 dB
Device Reference Point: 0, 0, -6.3 mm

Cursor:

ABM1/ABM2 = 49.78 dB
ABM1 comp = 1.17 dB A/m
BWC Factor = 0.16 dB
Location: -5, 0, 3.7 mm

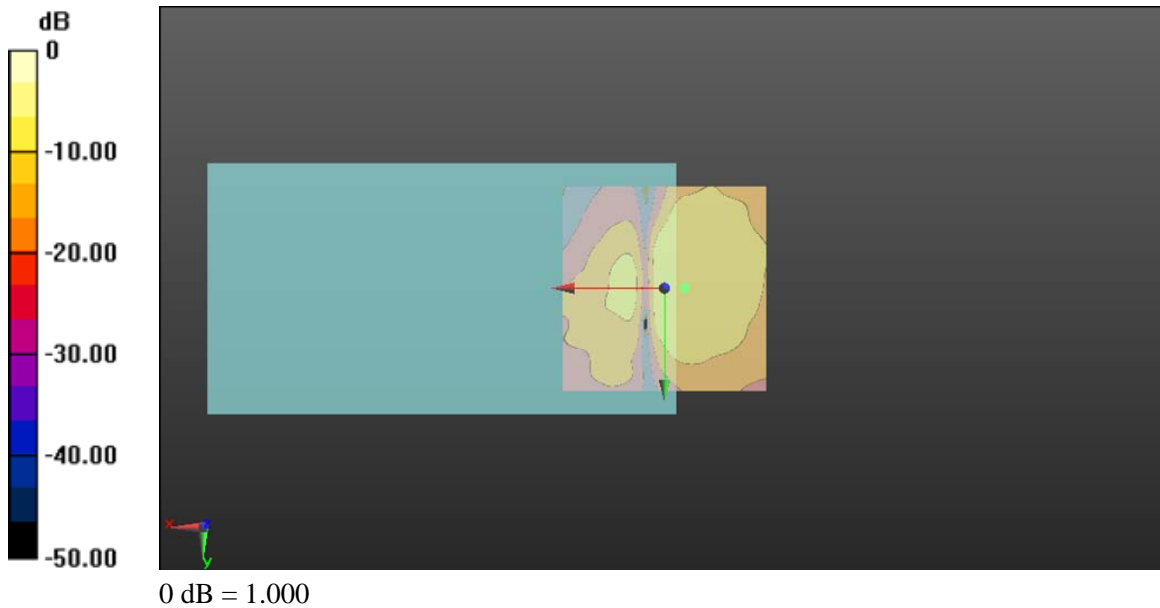

Y (Transversal)

Date: 11/8/2011

Test Laboratory: UL CCS SAR Lab C

HAC T-Coil

Communication System: CDMA2000; Frequency: 1880 MHz;Duty Cycle: 1:1
Phantom section: TCoil Section
DASY4 Configuration:
- Probe: AM1DV3 - 3092; ; Calibrated: 4/13/2011
- Sensor-Surface: 0mm (Fix Surface)
- Electronics: DAE4 Sn1257; Calibrated: 10/25/2011
- Phantom: HAC Test Arch with AMCC; Type: SD HAC P01 BB
- Measurement SW: DASY52, Version 52.6 (2);SEMCAD X Version 14.4.5 (3634)

**CDMA2000 PCS/General Scans/y (transversal) 4.2mm 50 x 50/ABM [HAC-2007]
Interpolated SNR(x,y,z) (121x121x1):**

Measurement grid: dx=10mm, dy=10mm
Signal Type: Audio File (.wav) 48k_voice_1kHz_1s.wav
Output Gain: 27.98
Measure Window Start: 300ms
Measure Window Length: 1000ms
BWC applied: 0.16 dB
Device Reference Point: 0, 0, -6.3 mm

Cursor:

ABM1/ABM2 = 49.70 dB
ABM1 comp = 1.89 dB A/m
BWC Factor = 0.16 dB
Location: 5, -9.2, 3.7 mm

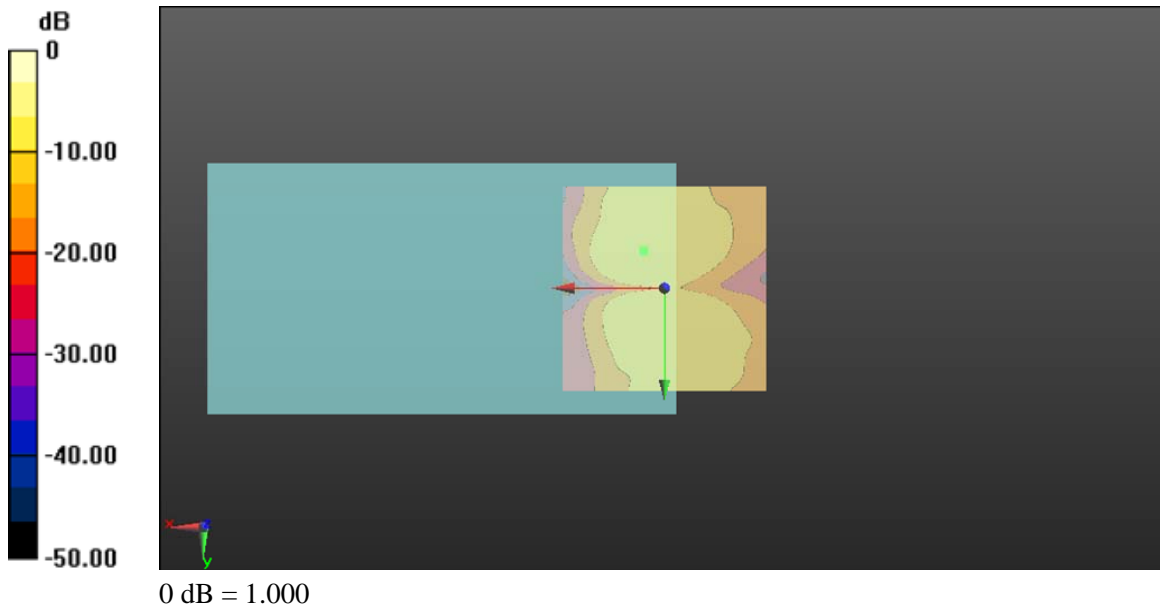

Test Plots for CDMA2000 BC10

Freq. Resp.

Date: 11/8/2011

Test Laboratory: UL CCS SAR Lab C

HAC T-Coil

Communication System: CDMA2000; Frequency: 820.5 MHz; Duty Cycle: 1:1

CDMA2000 BC10/General Scans/z (axial) wideband at best S/N/ABM [HAC-2007] Freq Resp(x,y,z,f) (1x1x1):

Measurement grid: dx=10mm, dy=10mm
 Signal Type: Audio File (.wav) 48k_voice_300-3000_2s.wav
 Output Gain: 55.22
 Measure Window Start: 300ms
 Measure Window Length: 2000ms
 BWC applied: 10.80 dB
 Device Reference Point: 0, 0, -6.3 mm

Category	Telephone parameters WD signal quality [(signal+noise)-to-noise ratio in decibels]
Category T1	0 dB to 10 dB
Category T2	10 dB to 20 dB
Category T3	20 dB to 30 dB
Category T4	> 30 dB

Cursor:

Diff = 2.00 dB
 BWC Factor = 10.80 dB
 Location: 4.2, -2.5, 3.7 mm

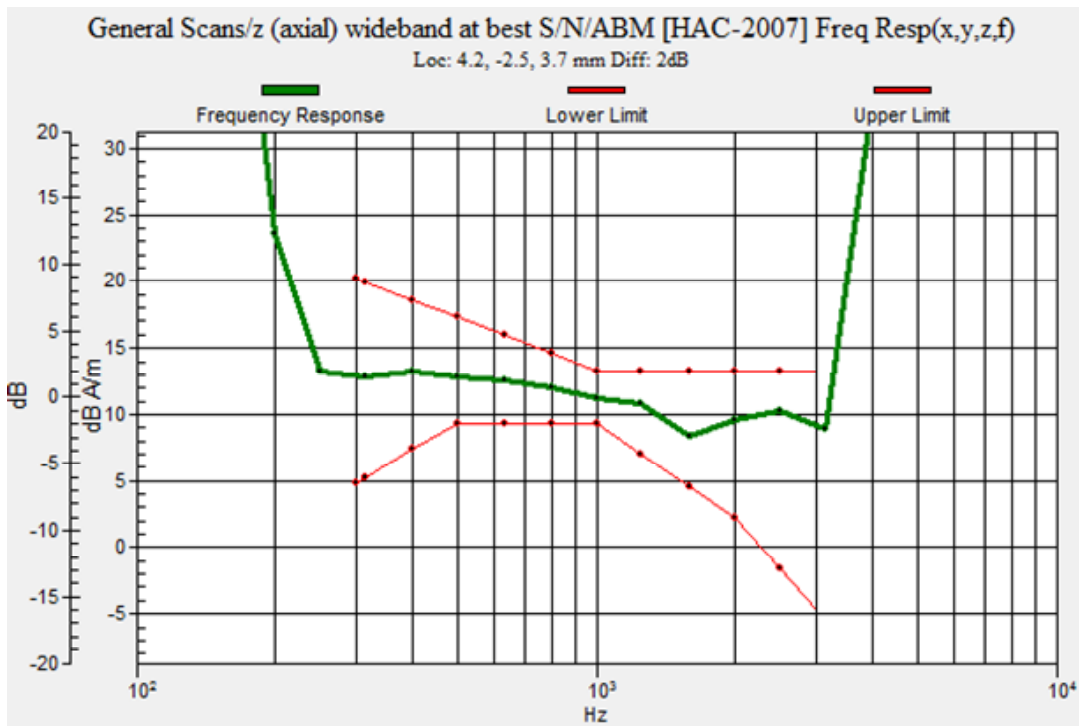

Z (Axial)

Date: 11/8/2011

Test Laboratory: UL CCS SAR Lab C

HAC T-Coil

Communication System: CDMA2000; Frequency: 820.5 MHz;Duty Cycle: 1:1
Phantom section: TCoil Section
DASY4 Configuration:
- Probe: AM1DV3 - 3092; ; Calibrated: 4/13/2011
- Sensor-Surface: 0mm (Fix Surface)
- Electronics: DAE4 Sn1257; Calibrated: 10/25/2011
- Phantom: HAC Test Arch with AMCC; Type: SD HAC P01 BB
- Measurement SW: DASY52, Version 52.6 (2);SEMCAD X Version 14.4.5 (3634)

CDMA2000 BC10/General Scans/z (axial) 4.2mm 50 x 50/ABM [HAC-2007] Interpolated SNR(x,y,z) (121x121x1):

Measurement grid: dx=10mm, dy=10mm
Signal Type: Audio File (.wav) 48k_voice_1kHz_1s.wav
Output Gain: 27.98
Measure Window Start: 300ms
Measure Window Length: 1000ms
BWC applied: 0.16 dB
Device Reference Point: 0, 0, -6.3 mm

Cursor:

ABM1/ABM2 = 41.91 dB
ABM1 comp = 9.50 dB A/m
BWC Factor = 0.16 dB
Location: 1.7, -0.4, 3.7 mm

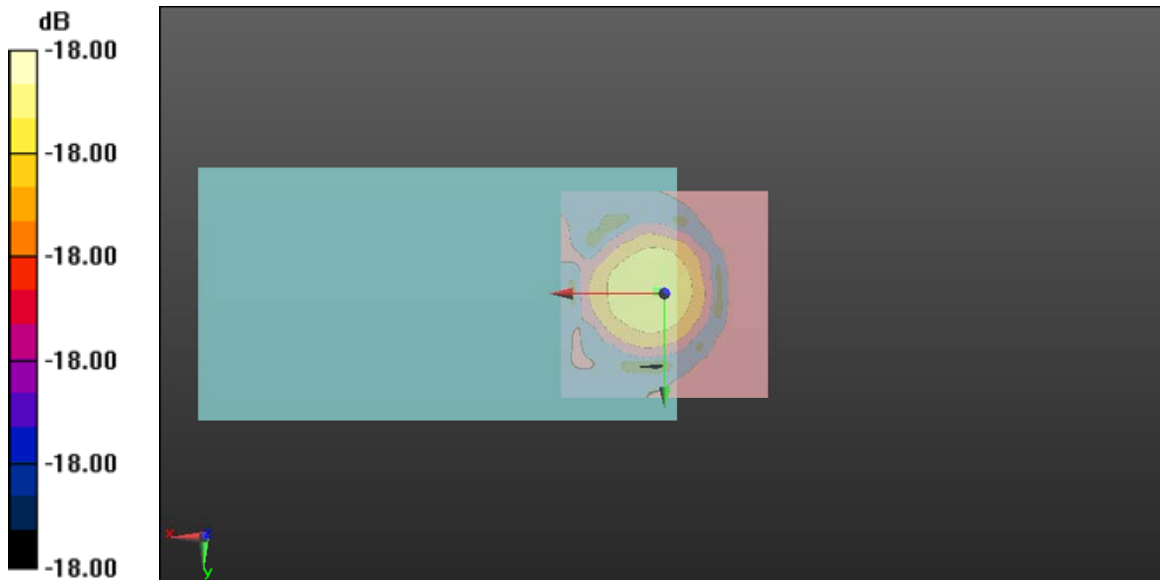

0 dB = 1.000

X (Longitudinal)

Date: 11/8/2011

Test Laboratory: UL CCS SAR Lab C

HAC T-Coil

Communication System: CDMA2000; Frequency: 820.5 MHz; Duty Cycle: 1:1
Phantom section: TCoil Section
DASY4 Configuration:
- Probe: AM1DV3 - 3092; ; Calibrated: 4/13/2011
- Sensor-Surface: 0mm (Fix Surface)
- Electronics: DAE4 Sn1257; Calibrated: 10/25/2011
- Phantom: HAC Test Arch with AMCC; Type: SD HAC P01 BB
- Measurement SW: DASY52, Version 52.6 (2); SEMCAD X Version 14.4.5 (3634)

CDMA2000 BC10/General Scans/x (longitudinal) 4.2mm 50 x 50/ABM [HAC-2007] Interpolated SNR(x,y,z) (121x121x1):

Measurement grid: dx=10mm, dy=10mm
Signal Type: Audio File (.wav) 48k_voice_1kHz_1s.wav
Output Gain: 27.98
Measure Window Start: 300ms
Measure Window Length: 1000ms
BWC applied: 0.16 dB
Device Reference Point: 0, 0, -6.3 mm

Cursor:

ABM1/ABM2 = 50.48 dB
ABM1 comp = 2.22 dB A/m
BWC Factor = 0.16 dB
Location: -5.4, -1.3, 3.7 mm

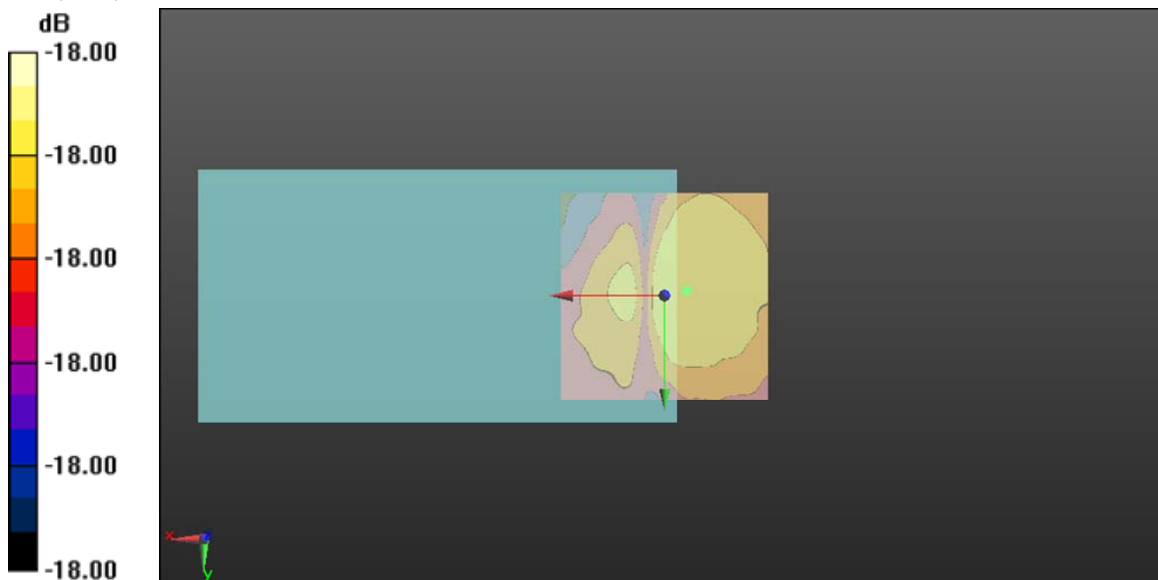

0 dB = 1.000

Y (Transversal)

Date: 11/8/2011

Test Laboratory: UL CCS SAR Lab C

HAC T-Coil

Communication System: CDMA2000; Frequency: 820.5 MHz;Duty Cycle: 1:1
Phantom section: TCoil Section
DASY4 Configuration:
- Probe: AM1DV3 - 3092; ; Calibrated: 4/13/2011
- Sensor-Surface: 0mm (Fix Surface)
- Electronics: DAE4 Sn1257; Calibrated: 10/25/2011
- Phantom: HAC Test Arch with AMCC; Type: SD HAC P01 BB
- Measurement SW: DASY52, Version 52.6 (2);SEMCAD X Version 14.4.5 (3634)

**CDMA2000 BC10/General Scans/y (transversal) 4.2mm 50 x 50/ABM [HAC-2007]
Interpolated SNR(x,y,z) (121x121x1):**

Measurement grid: dx=10mm, dy=10mm
Signal Type: Audio File (.wav) 48k_voice_1kHz_1s.wav
Output Gain: 27.98
Measure Window Start: 300ms
Measure Window Length: 1000ms
BWC applied: 0.16 dB
Device Reference Point: 0, 0, -6.3 mm

Cursor:

ABM1/ABM2 = 51.95 dB
ABM1 comp = 2.74 dB A/m
BWC Factor = 0.16 dB
Location: 4.2, -8.8, 3.7 mm

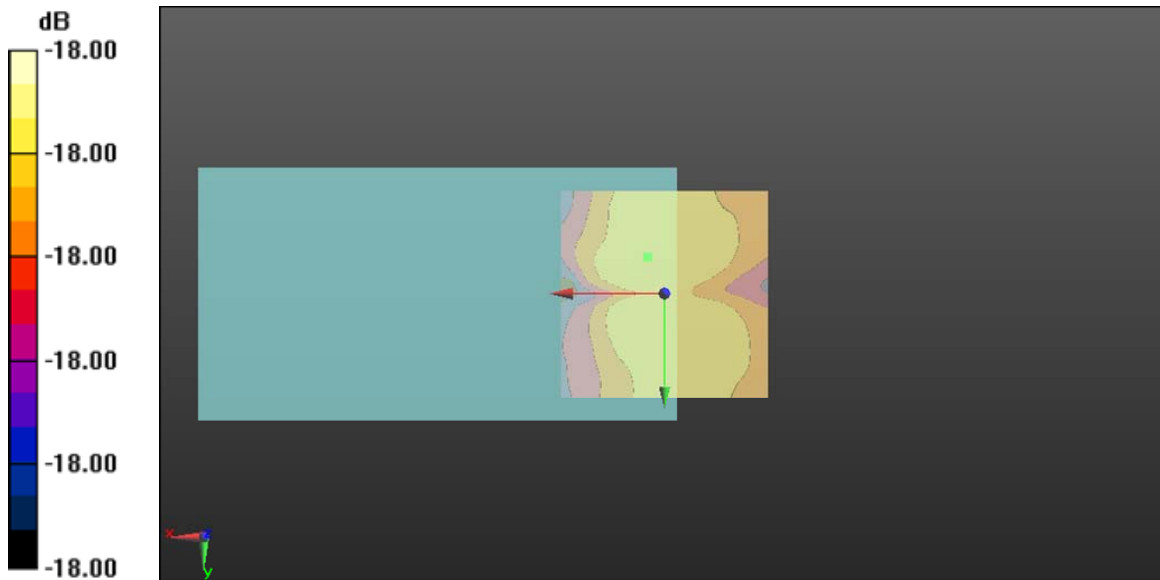

0 dB = 1.000

Test Plots for CDMA2000 BC1

Freq. Resp.

Date: 11/8/2011

Test Laboratory: UL CCS SAR Lab C

HAC T-Coil

Communication System: CDMA2000; Frequency: 1880 MHz;Duty Cycle: 1:1

CDMA2000 PCS/General Scans/z (axial) wideband at best S/N/ABM [HAC-2007] Freq Resp(x,y,z,f) (1x1x1):

Measurement grid: dx=10mm, dy=10mm
 Signal Type: Audio File (.wav) 48k_voice_300-3000_2s.wav
 Output Gain: 55.22
 Measure Window Start: 300ms
 Measure Window Length: 2000ms
 BWC applied: 10.80 dB
 Device Reference Point: 0, 0, -6.3 mm

Category	Telephone parameters WD signal quality [(signal+noise)-to-noise ratio in decibels]
Category T1	0 dB to 10 dB
Category T2	10 dB to 20 dB
Category T3	20 dB to 30 dB
Category T4	> 30 dB

Cursor:

Diff = 0.66 dB
 BWC Factor = 10.80 dB
 Location: 4.6, -0.8, 3.7 mm

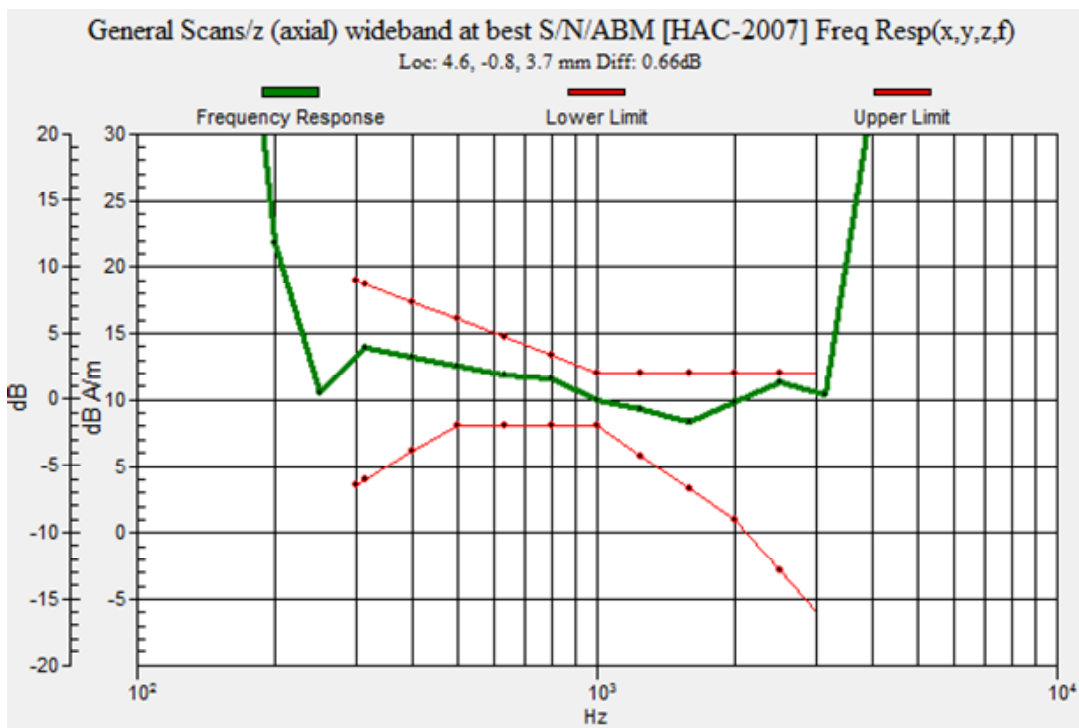

Z (Axial)

Date: 11/8/2011

Test Laboratory: UL CCS SAR Lab C

HAC T-Coil

Communication System: CDMA2000; Frequency: 1880 MHz;Duty Cycle: 1:1
Phantom section: TCoil Section
DASY4 Configuration:
- Probe: AM1DV3 - 3092; ; Calibrated: 4/13/2011
- Sensor-Surface: 0mm (Fix Surface)
- Electronics: DAE4 Sn1257; Calibrated: 10/25/2011
- Phantom: HAC Test Arch with AMCC; Type: SD HAC P01 BB
- Measurement SW: DASY52, Version 52.6 (2);SEMCAD X Version 14.4.5 (3634)

CDMA2000 PCS/General Scans/z (axial) 4.2mm 50 x 50/ABM [HAC-2007] Interpolated SNR(x,y,z) (121x121x1):

Measurement grid: dx=10mm, dy=10mm
Signal Type: Audio File (.wav) 48k_voice_1kHz_1s.wav
Output Gain: 27.98
Measure Window Start: 300ms
Measure Window Length: 1000ms
BWC applied: 0.16 dB
Device Reference Point: 0, 0, -6.3 mm

Cursor:

ABM1/ABM2 = 44.14 dB
ABM1 comp = 11.06 dB A/m
BWC Factor = 0.16 dB
Location: 4.2, -0.4, 3.7 mm

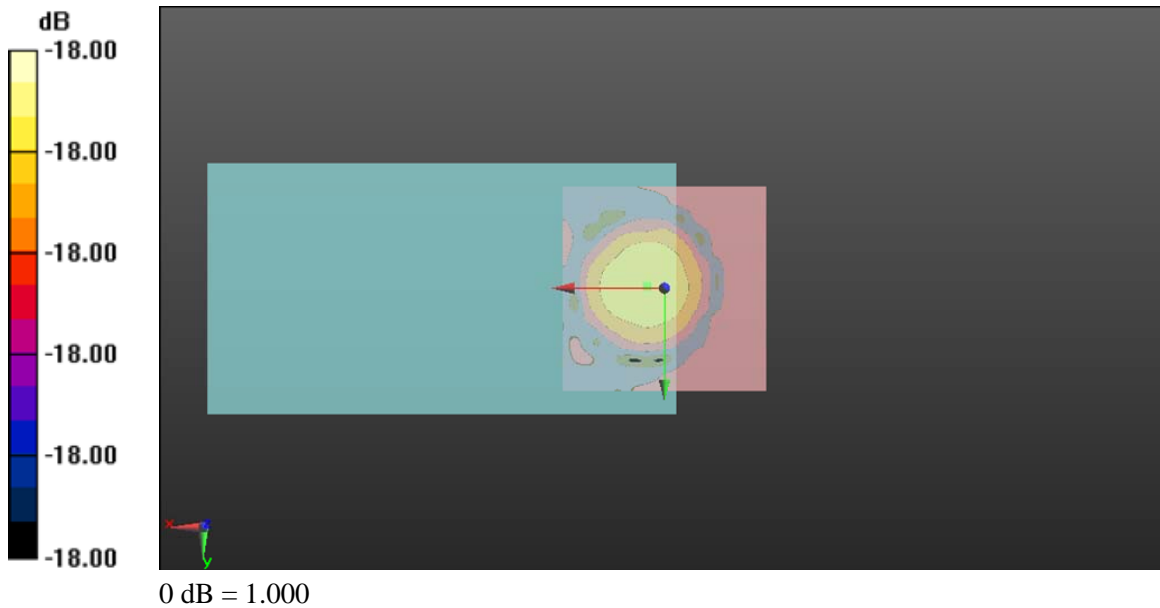

X (Longitudinal)

Date: 11/8/2011

Test Laboratory: UL CCS SAR Lab C

HAC T-Coil

Communication System: CDMA2000; Frequency: 1880 MHz;Duty Cycle: 1:1
Phantom section: TCoil Section
DASY4 Configuration:
- Probe: AM1DV3 - 3092; ; Calibrated: 4/13/2011
- Sensor-Surface: 0mm (Fix Surface)
- Electronics: DAE4 Sn1257; Calibrated: 10/25/2011
- Phantom: HAC Test Arch with AMCC; Type: SD HAC P01 BB
- Measurement SW: DASY52, Version 52.6 (2);SEMCAD X Version 14.4.5 (3634)

CDMA2000 PCS/General Scans/x (longitudinal) 4.2mm 50 x 50/ABM [HAC-2007] Interpolated SNR(x,y,z) (121x121x1):

Measurement grid: dx=10mm, dy=10mm
Signal Type: Audio File (.wav) 48k_voice_1kHz_1s.wav
Output Gain: 27.98
Measure Window Start: 300ms
Measure Window Length: 1000ms
BWC applied: 0.16 dB
Device Reference Point: 0, 0, -6.3 mm

Cursor:

ABM1/ABM2 = 51.87 dB
ABM1 comp = 1.74 dB A/m
BWC Factor = 0.16 dB
Location: -4.6, -0.8, 3.7 mm

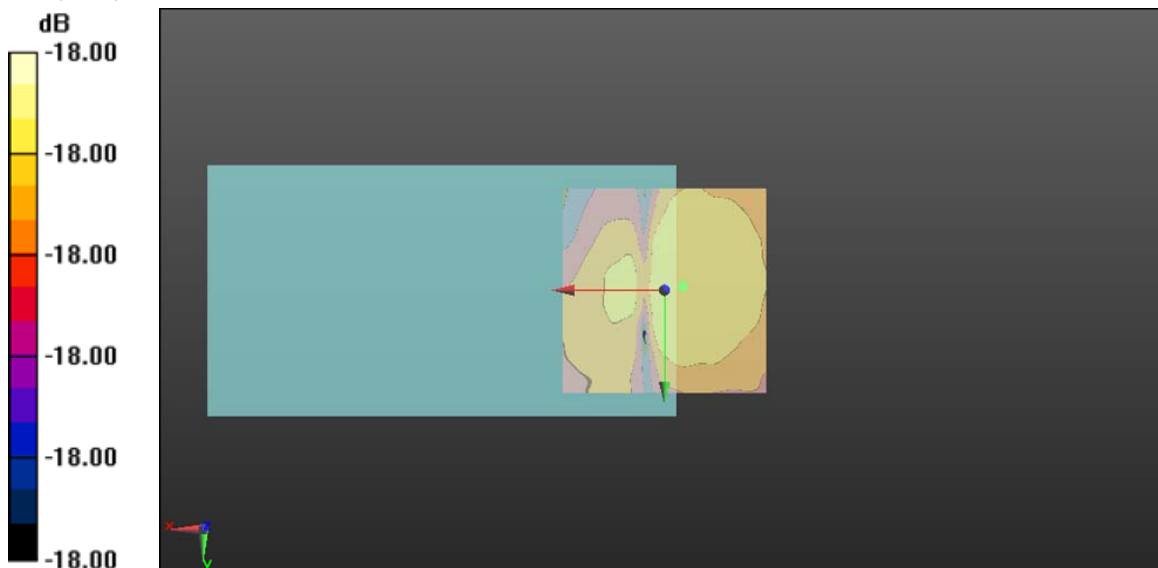

0 dB = 1.000

Y (Transversal)

Date: 11/8/2011

Test Laboratory: UL CCS SAR Lab C

HAC T-Coil

Communication System: CDMA2000; Frequency: 1880 MHz;Duty Cycle: 1:1
Phantom section: TCoil Section
DASY4 Configuration:
- Probe: AM1DV3 - 3092; ; Calibrated: 4/13/2011
- Sensor-Surface: 0mm (Fix Surface)
- Electronics: DAE4 Sn1257; Calibrated: 10/25/2011
- Phantom: HAC Test Arch with AMCC; Type: SD HAC P01 BB
- Measurement SW: DASY52, Version 52.6 (2);SEMCAD X Version 14.4.5 (3634)

CDMA2000 PCS/General Scans/y (transversal) 4.2mm 50 x 50/ABM [HAC-2007] Interpolated SNR(x,y,z) (121x121x1):

Measurement grid: dx=10mm, dy=10mm
Signal Type: Audio File (.wav) 48k_voice_1kHz_1s.wav
Output Gain: 27.98
Measure Window Start: 300ms
Measure Window Length: 1000ms
BWC applied: 0.16 dB
Device Reference Point: 0, 0, -6.3 mm

Cursor:

ABM1/ABM2 = 52.85 dB
ABM1 comp = 2.74 dB A/m
BWC Factor = 0.16 dB
Location: 4.6, -8.8, 3.7 mm

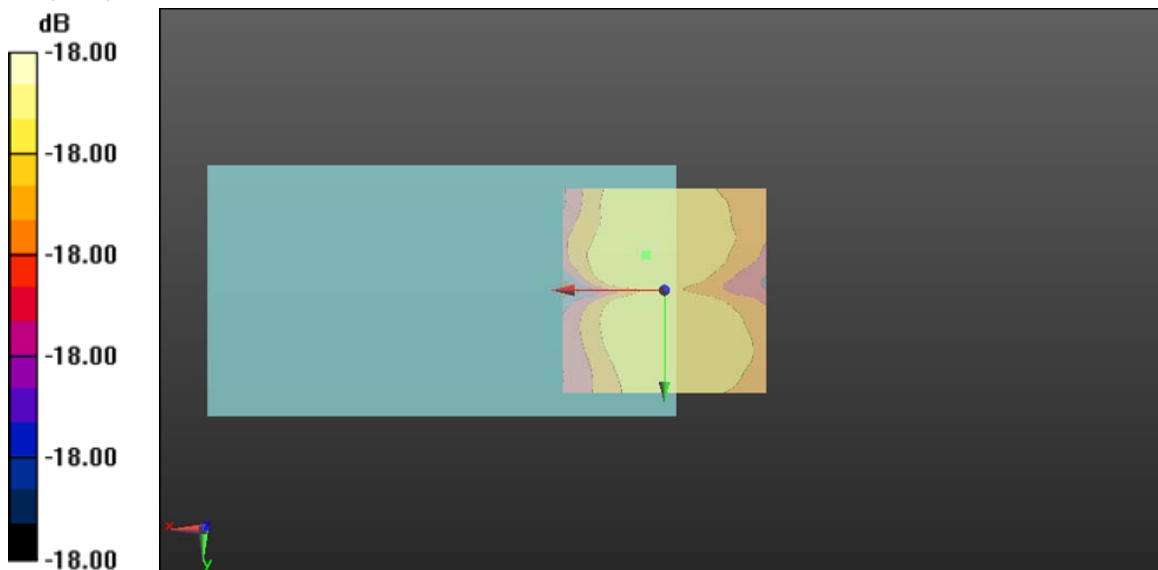

0 dB = 1.000

10. Appendix

Appendix A: Calibration Certificate - Magnetic Field Probe AM1DV3 - SN 3092

**Calibration Laboratory of
 Schmid & Partner
 Engineering AG**
 Zeughausstrasse 43, 8004 Zurich, Switzerland



S Schweizerischer Kalibrierdienst
S Service suisse d'étalonnage
C Servizio svizzero di taratura
S Swiss Calibration Service

Accredited by the Swiss Accreditation Service (SAS)
 The Swiss Accreditation Service is one of the signatories to the EA
 Multilateral Agreement for the recognition of calibration certificates

Accreditation No.: **SCS 108**

Client **CCS USA**

Certificate No: **AM1DV3-3092_Apr11**

CALIBRATION CERTIFICATE

Object: **AM1DV3 - SN: 3092**

Calibration procedure(s): **QA CAL-24.v2
 Calibration procedure for AM1D magnetic field probes and TMFS in the
 audio range**

Calibration date: **April 13, 2011**

This calibration certificate documents the traceability to national standards, which realize the physical units of measurements (SI).
 The measurements and the uncertainties with confidence probability are given on the following pages and are part of the certificate.

All calibrations have been conducted in the closed laboratory facility: environment temperature (22 ± 3)°C and humidity < 70%.

Calibration Equipment used (M&TE critical for calibration)

Primary Standards	ID #	Cal Date (Certificate No.)	Scheduled Calibration
Keithley Multimeter Type 2001	SN: 0810278	28-Sep-10 (No:10376)	Sep-11
Reference Probe AM1DV3	SN: 3000	6-Sep-10 (No. AM1D-3000_Sep10)	Sep-11
DAE4	SN: 781	20-Oct-10 (No. DAE4-781_Oct10)	Oct-11
Secondary Standards	ID #	Check Date (in house)	Scheduled Check
AMCC	1050	15-Oct-09 (in house check Oct-09)	Oct-11

Calibrated by:	Name Mike Meili	Function Laboratory Technician	Signature <i>[Signature]</i>
Approved by:	Name Fin Bomholt	Function R&D Director	Signature <i>[Signature]</i>

Issued: April 13, 2011

This calibration certificate shall not be reproduced except in full without written approval of the laboratory.

References

- [1] ANSI C63.19-2007
American National Standard for Methods of Measurement of Compatibility between Wireless Communications Devices and Hearing Aids.
- [2] DASY4 manual, Chapter: Hearing Aid Compatibility (HAC) T-Coil Extension

Description of the AM1D probe

The AM1D Audio Magnetic Field Probe is a fully shielded magnetic field probe for the frequency range from 100 Hz to 20 kHz. The pickup coil is compliant with the dimensional requirements of [1]. The probe includes a symmetric low noise amplifier for the signal available at the shielded 3 pin connector at the side. Power is supplied via the same connector (phantom power supply) and monitored via the LED near the connector. The 7 pin connector at the end of the probe does not carry any signals, but determines the angle of the sensor when mounted on the DAE. The probe supports mechanical detection of the surface.

The single sensor in the probe is arranged in a tilt angle allowing measurement of 3 orthogonal field components when rotating the probe by 120° around its axis. It is aligned with the perpendicular component of the field, if the probe axis is tilted nominally 35.3° above the measurement plane, using the connector rotation and sensor angle stated below.

The probe is fully RF shielded when operated with the matching signal cable (shielded) and allows measurement of audio magnetic fields in the close vicinity of RF emitting wireless devices according to [1] without additional shielding.

Handling of the item

The probe is manufactured from stainless steel. In order to maintain the performance and calibration of the probe, it must not be opened. The probe is designed for operation in air and shall not be exposed to humidity or liquids. For proper operation of the surface detection and emergency stop functions in a DASY system, the probe must be operated with the special probe cup provided (larger diameter).

Methods Applied and Interpretation of Parameters

- *Coordinate System:* The AM1D probe is mounted in the DASY system for operation with a HAC Test Arch phantom with AMCC Helmholtz calibration coil according to [2], with the tip pointing to "southwest" orientation.
- *Functional Test:* The functional test preceding calibration includes test of Noise level
RF immunity (1kHz AM modulated signal). The shield of the probe cable must be well connected.
Frequency response verification from 100 Hz to 10 kHz.
- *Connector Rotation:* The connector at the end of the probe does not carry any signals and is used for fixation to the DAE only. The probe is operated in the center of the AMCC Helmholtz coil using a 1 kHz magnetic field signal. Its angle is determined from the two minima at nominally +120° and -120° rotation, so the sensor in the tip of the probe is aligned to the vertical plane in z-direction, corresponding to the field maximum in the AMCC Helmholtz calibration coil.
- *Sensor Angle:* The sensor tilting in the vertical plane from the ideal vertical direction is determined from the two minima at nominally +120° and -120°. DASY system uses this angle to align the sensor for radial measurements to the x and y axis in the horizontal plane.
- *Sensitivity:* With the probe sensor aligned to the z-field in the AMCC, the output of the probe is compared to the magnetic field in the AMCC at 1 kHz. The field in the AMCC Helmholtz coil is given by the geometry and the current through the coil, which is monitored on the precision shunt resistor of the coil.

AM1D probe identification and configuration data

Item	AM1DV3 Audio Magnetic 1D Field Probe
Type No	SP AM1 001 BA
Serial No	3092

Overall length	296 mm
Tip diameter	6.0 mm (at the tip)
Sensor offset	3.0 mm (centre of sensor from tip)
Internal Amplifier	20 dB

Manufacturer / Origin	Schmid & Partner Engineering AG, Zürich, Switzerland
Manufacturing date	Mar-2011
Last calibration date	n/a

Calibration data

Connector rotation angle	(in DASY system)	278.7 °	+/- 3.6 ° (k=2)
Sensor angle	(in DASY system)	0.72 °	+/- 0.5 ° (k=2)
Sensitivity at 1 kHz	(in DASY system)	0.00733 V / (A/m)	+/- 2.2 % (k=2)