

# TEST REPORT

of

FCC Part 15 Subpart E §15.407

FCC ID : ZNFLGL25

Equipment Under Test : Cellular/PCS GSM/GPRS/EDGE/WCDMA/HSDPA/HSUPA Smart Phone  
Model Name : LGL25  
Applicant : LG Electronics MobileComm U.S.A., Inc.  
Manufacturer : LG Electronics MobileComm U.S.A., Inc.  
Date of Test(s) : 2014.09.19 ~ 2014.10.25  
Date of Issue : 2014.11.10

In the configuration tested, the EUT complied with the standards specified above.

Tested By:



Youngmin Park

Date:

2014.11.10

Approved By:



Hyunchoe You

Date:

2014.11.10

*The results shown in this test report refer only to the sample(s) tested unless otherwise stated. This test report cannot be reproduced, except in full, without prior written permission of the Company.*

## Table of contents

1. General information -----	3
2. DFS (Dynamic Frequency Selection)-----	6

---

*The results shown in this test report refer only to the sample(s) tested unless otherwise stated. This test report cannot be reproduced, except in full, without prior written permission of the Company.*

## 1. General information

### 1.1 Testing laboratory

SGS Korea Co., Ltd. (Gunpo Laboratory)

-Wireless Div. 2FL, 10-2, LS-ro 182beon-gil, Gunpo-si, Gyeonggi-do, Korea, 435-837

All SGS services are rendered in accordance with the applicable SGS conditions of service available on request and accessible at <http://www.sgs.com/en/Terms-and-Conditions.aspx>.

Phone No. : + 82 31 688 0901

Fax No. : + 82 31 688 0921

### 1.2. Details of Applicant

Applicant : LG Electronics MobileComm U.S.A., Inc.

Address : 10101 Old Grove Road, San Diego, CA 92131

Contact Person : An, Hee-Ju

Phone No. : +82 2 2033 1103

### 1.3. Description of EUT

<b>Kind of Product</b>	Cellular/PCS GSM/GPRS/EDGE/WCDMA/HSDPA/HSUPA Smart Phone
<b>Model Name</b>	LGL25
<b>Power Supply</b>	DC 3.8 V
<b>Frequency Range</b>	5 180 MHz ~ 5 240 MHz (Band 1 : 11a/n_HT20), 5 190 MHz ~ 5 230 MHz (Band 1 : 11n_HT40), 5 260 MHz ~ 5 320 MHz (Band 2A : 11a/n_HT20), 5 270 MHz ~ 5 310 MHz (Band 2A : 11n_HT40), 5 500 MHz ~ 5 700 MHz (Band 2C : 11a/n_HT20)_except for TDWR(5.6-5.65 GHz) band, 5 510 MHz ~ 5 670 MHz (Band 2C : 11n_HT40) _except for TDWR(5.6-5.65 GHz) band, 5 745 MHz ~ 5 825 MHz (Band 3 : 11a/n_HT20), 5 755 MHz ~ 5 795 MHz (Band 3 : 11n_HT40)
<b>Modulation Technique</b>	DSSS, OFDM
<b>Number of Channels</b>	4 channels (Band 1 : 11a/n_HT20), 2 channels (Band 1 : 11n_HT40), 4 channels (Band 2A : 11a/n_HT20), 2 channels (Band 2A : 11n_HT40), 8 channels (Band 2C : 11a/n_HT20), 3 channels (Band 2C : 11n_HT40), 5 channels (Band 3 : 11a/n_HT20), 2 channels (Band 3 : 11n_HT40)
<b>Antenna Type</b>	Internal type (SISO)
<b>Antenna Gain</b>	5 180 MHz ~ 5 320 MHz : 1.31 dB i, 5 500 MHz ~ 5 700 MHz : 0.65 dB i, 5 745 MHz ~ 5 805 MHz : 1.67 dB i

*The results shown in this test report refer only to the sample(s) tested unless otherwise stated. This test report cannot be reproduced, except in full, without prior written permission of the Company.*

**SGS Korea Co., Ltd. (Gunpo Laboratory)** 4, LS-ro 182beon-gil, Gunpo-si, Gyeonggi-do, Korea, 435-040 <http://www.sgsgroup.kr>

#### 1.4. Declaration by the manufacturer

- EUT is SLAVE without Radar Detection and TPC.
- EUT is not supported TDWR(5.6-5.65 GHz) band. There is a detailed information for channel plans in the operational description.

#### 1.5. Test equipment list

Equipment	Manufacturer	Model	S/N	Cal Date	Cal Interval	Cal Due.
Spectrum Analyzer	R&S	FSV30	100768	Mar. 27, 2014	Annual	Mar. 27, 2015
Signal Generator	R&S	SMBV100A	259067	Jun. 25, 2014	Annual	Jun. 25, 2015
Attenuator	AEROFLEX / INMET	18N-20 dB	2	Mar. 18, 2014	Annual	Mar. 18, 2015
Power Splitter	Mini-Circuits	ZFSC-2-10G	001	Jun. 10, 2014	Annual	Jun. 10, 2015
Power Splitter	Mini-Circuits	ZFSC-2-10G	002	Jun. 10, 2014	Annual	Jun. 10, 2015
DC power Supply	Agilent	U8002A	MY49030063	Dec. 12, 2013	Annual	Dec. 12, 2014

#### ► Support equipment

Description	Manufacturer	Model	Serial Number / FCC ID
Access Point( master)	Cisco	AIR-AP1262N-A-K9	FGL1632S72B FCC ID:LDK102073
Notebook	IBM	T43	2669CC8

The results shown in this test report refer only to the sample(s) tested unless otherwise stated. This test report cannot be reproduced, except in full, without prior written permission of the Company.

## 1.7. Summary of test result

The EUT has been tested according to the following specifications:

APPLIED STANDARD:FCC Part15 subpart E		
Section in FCC 15	Test Item	Result
15.407(h)	DFS(Dynamic Frequency Selection) -Channel closing transmission time -Channel move time -Non occupied period	Complied

## 1.8. Test report revision

Revision	Report number	Date of Issue	Description
0	F690501/RF-RTL008131	2014.10.31	Initial
1	F690501/RF-RTL008131-1	2014.11.05	Added the new requirements under the new UNII rules and the latest KDBs. Added a comment about Support Availability for TDWR(5.6-5.65 GHz) band.
2	F690501/RF-RTL008131-2	2014.11.10	Added the declaration by the manufacturer

*The results shown in this test report refer only to the sample(s) tested unless otherwise stated. This test report cannot be reproduced, except in full, without prior written permission of the Company.*

## 2. DFS (Dynamic Frequency Selection)

### 2.1. System overview

#### 2.1.1. Set up of EUT

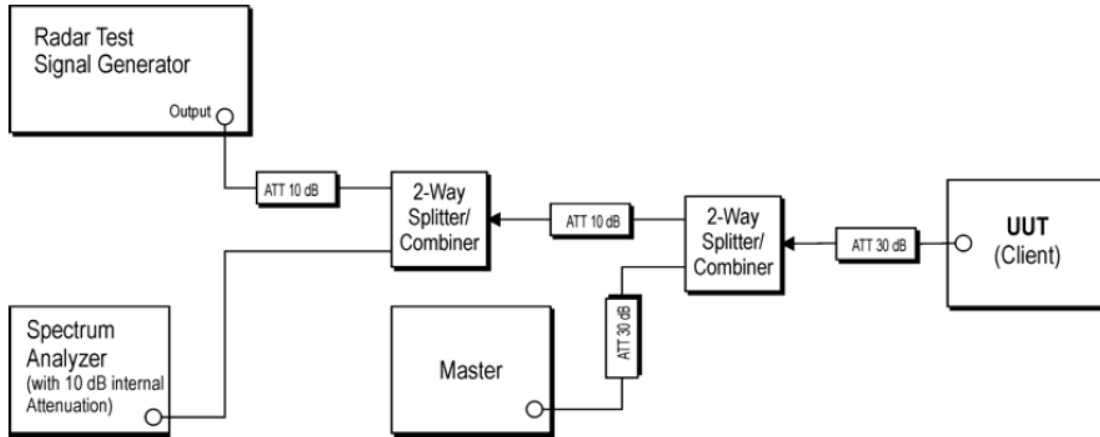

The radar signal generation equipment consists of a vector signal generator

The signal monitoring equipment consists of a spectrum analyzer set to display 8 001 bins on the horizontal axis. The time domain resolution is 2 msec/bin with a 16 second sweep time, meeting the 10 second short pulse reporting criteria. The aggregate ON time is calculated by multiplying the number of bins above a threshold during a particular observation period by the dwell time per bin, with the analyzer set to peak detection and max hold.

The Slave is tested separately for compliance with the Channel Shutdown requirements, for the situation when the Slave device vacates the channel in response to detection of a radar by the Master.

All tests were performed at a channel center frequency of 5 310 MHz and 5 510 MHz. Measurements were performed using conducted test methods.

Stream the MPEG test file from the Master Device to the Client Device on the test Channel for the entire period of the test.

The designated MPEG test file and instructions are located at: <http://ntiacsd.ntia.doc.gov/dfs/>

The test file name is 'TestFile.mpg.'

Note: Detailed Set up of EUT is provided in the test setup photos.

*The results shown in this test report refer only to the sample(s) tested unless otherwise stated. This test report cannot be reproduced, except in full, without prior written permission of the Company.*

## 2.2 Limit

§15.407 (h) and FCC 06-96 APPENDIX “COMPLIANCE MEASUREMENT PROCEDURES FOR UNLICENSED-NATIONAL INFORMATION INFRASTRUCTURE DEVCIES OPERATING IN THE 5 250 - 5 350 MHz AND 5 470 - 5 725 MHz BANDS INCORPORATING DYNAMIC FREQUENCY SELECTION

**Table 1: Applicability of DFS Requirements Prior to Use of a Channel**

Requirement	Operational Mode		
	Master	Client Without Radar Detection	Client With Radar Detection
Non-Occupancy Period	Yes	Not required	Yes
DFS Detection Threshold	Yes	Not required	Yes
Channel Availability Check Time	Yes	Not required	Not required
U-NII Detection Bandwidth	Yes	Not required	Yes

**Table 2: Applicability of DFS requirements during normal operation**

Requirement	Operational Mode	
	Master Device or Client with Radar Detection	Client Without Rader Detection
DFS Detection Threshold	Yes	Not required
Channel Closing Transmission Time	Yes	Yes
Channel Move Time	Yes	Yes
U-NII Detection Bandwidth	Yes	Not required

Additional requirement for devices with multiple bandwidth modes	Master Device or Client with Radar Detection	Client Without Rader Detection
U-NII Detection Bandwidth and Statistical Performance Check	All BT modes must be tested	Not required
Channel Move Time and Channel Closing Transmission Time	Test using widest BT mode available	Test using the widest BW mode available for the link
All other tests	Any single BW mode	Not required

**Note:** Frequencies selected for statistical performance check (Section 7.8.4) should include several frequencies within the radar detection bandwidth and frequencies near the edge of the radar detection bandwidth. For 802.11 devices it is suggested to select frequencies in each of the bonded 20 MHz channels and the channel center frequency.

The results shown in this test report refer only to the sample(s) tested unless otherwise stated. This test report cannot be reproduced, except in full, without prior written permission of the Company.

**Table 3: DFS Detection Thresholds for Master Devices and Client Devices With Radar Detection**

Maximum Transmit Power	Value (See Note 1, 2, and 3)
EIRP $\geq$ 200 milliwatt	-64 dB m
EIRP < 200 milliwatt and power spectral density < 10 dB m/MH	-62 dB m
EIRP < 200 milliwatt that do not meet the power spectral density requirement	-64 dB m

**Note 1:** This is the level at the input of the receiver assuming a 0 dB i receive antenna.  
**Note 2:** Throughout these test procedures an additional 1 dB has been added to the amplitude of the test transmission waveforms to account for variations in measurement equipment. This will ensure that the test signal is at or above the detection threshold level to trigger a DFS response.  
**Note3:** EIRP is based on the highest antenna gain. For MIMO devices refer to KDB Publication 662911 D01.

**KDB 905462 D03 Client Without DFS New Rules v01r01 : UNII client devices without radar detection**

- The guidance provided in Section 8 (DFS Test Report Guidelines) in KDB Publication 905462 D02
- Test results demonstrating an associated client link is established with the master on a test frequency; if a client device operates in a “listen only” mode to a master without formally “associating” with it the test report must include tests for such modes.
- The devices must be tested with a master device operating in the same band and operation modes.
- If two client devices can communicate directly with each other while maintaining an association with a master or if the client operates on a frequency band while “listening” to a master, such modes must be tested with the master device active.
- The client and DFS-certified master device are associated, and a movie can be streamed as specified in the DFS Order for a non-occupancy period test.
- The test frequency has been monitored to ensure no transmission of any type has occurred for 30 minutes. Note: If the client moves with the master, the device is considered compliant if nothing appears in the client non-occupancy period test. For devices that shut down (rather than moving channels), no beacons should appear.
- An analyzer plot that contains a single 30-minute sweep on the original channel.

*The results shown in this test report refer only to the sample(s) tested unless otherwise stated. This test report cannot be reproduced, except in full, without prior written permission of the Company.*



**Table 4: DFS Response Requirement Values**

Parameter	Value
Non-occupancy period	Minimum 30 minutes
Channel Availability Check Time	60 seconds
Channel Move Time	10 seconds See Note 1.
Channel Closing Transmission Time	200 milliseconds + an aggregate of 60 milliseconds over remaining 10 second period. See Notes 1 and 2.
U-NII Detection Bandwidth	Minimum 100% of the U-NII 99% transmission power bandwidth. See Note 3.

**Note 1:** Channel Move Time and the Channel Closing Transmission Time should be performed with Radar Type 0. The measurement timing begins at the end of the Radar Type 0 burst.

**Note 2:** The Channel Closing Transmission Time is comprised of 200 milliseconds starting at the beginning of the Channel Move Time plus any additional intermittent control signals required to facilitate a Channel move (an aggregate of 60 milliseconds) during the remainder of the 10 second period. The aggregate duration of control signals will not count quiet periods in between transmissions.

**Note 3:** During the U-NII Detection Bandwidth detection test, radar type 0 should be used. For each frequency step the minimum percentage of detection is 90 percent. Measurements are performed with no data traffic.

**Table 5 – Short Pulse Radar Test Waveforms**

Radar Type	Pulse Width (μsec)	PRI (μsec)	Number of Pulses	Minimum Percentage of Successful Detection	Minimum Number of Trials
0	1	1428	18	See Note 1	See Note 1
1	1	Test A: 15 unique PRI values randomly selected from the list of 23 PRI values in Table 5a	Roundup $\left\{ \left( \frac{1}{360} \right) \cdot \left( \frac{19 \cdot 10^6}{\text{PRI}_{\mu\text{sec}}} \right) \right\}$	60 %	30
		Test B: 15 unique PRI values randomly selected within the range of 518-3066 μsec, with a minimum increment of 1 μsec, excluding PRI values			

The results shown in this test report refer only to the sample(s) tested unless otherwise stated. This test report cannot be reproduced, except in full, without prior written permission of the Company.

		selected in Test A			
2	1-5	150-230	23-29	60 %	30
3	6-10	200-500	16-18	60 %	30
4	11-20	200-500	12-16	60 %	30
Aggregate (Radar Types 1-4)				80 %	120

**Note 1:** Short Pulse Radar Type 0 should be used for the detection bandwidth test, channel move time, and channel closing time tests.

**Table 6 – Long Pulse Radar Test Waveform**

Radar Type	Pulse Width (μsec)	Chirp Width (MHz)	PRI (μsec)	Number of Pulses per Burst	Number of Bursts	Minimum Percentage of Successful Detection	Minimum Number of Trials
5	50-100	5-20	1 000-2 000	1-3	10 002 000	80 %	30

**Table 7 – Frequency Hopping Radar Test Waveform**

Radar Type	Pulse Width (μsec)	PRI (μsec)	Pulses per Hop	Hopping Rate (kHz)	Hopping Sequence Length (msec)	Minimum Percentage of Successful Detection	Minimum Number of Trials
6	1	333	9	0.333	300	70 %	30

### 2.3. Description of EUT

The EUT operates over the band 2A “5 260 MHz ~ 5 320 MHz (11a/n\_HT20), 5 270 MHz ~ 5 310 MHz (11n\_HT40)” and also supports the band 2C “5 500 MHz ~ 5 700 MHz (11a/n\_HT20), 5 510 MHz ~ 5 670 MHz (11n\_HT40)” range.

The gain antenna assembly utilized with the master has a gain of 3.5 dB i.

The rated output power of the master unit is < 200 milliwatt. Therefore the required interference threshold level is -62 dB m. After correction for antenna gain and procedure adjustments the required conducted threshold at the antenna port is -62 + 3.5 = -58.50 dB m

The calibrated conducted DFS Detection Threshold level is is -60 dB m

*The results shown in this test report refer only to the sample(s) tested unless otherwise stated. This test report cannot be reproduced, except in full, without prior written permission of the Company.*

## PLOTS OF RADAR WAVEFORMS AND WLAN TRAFFIC

### Plot of radar waveform type 1

5 310 MHz

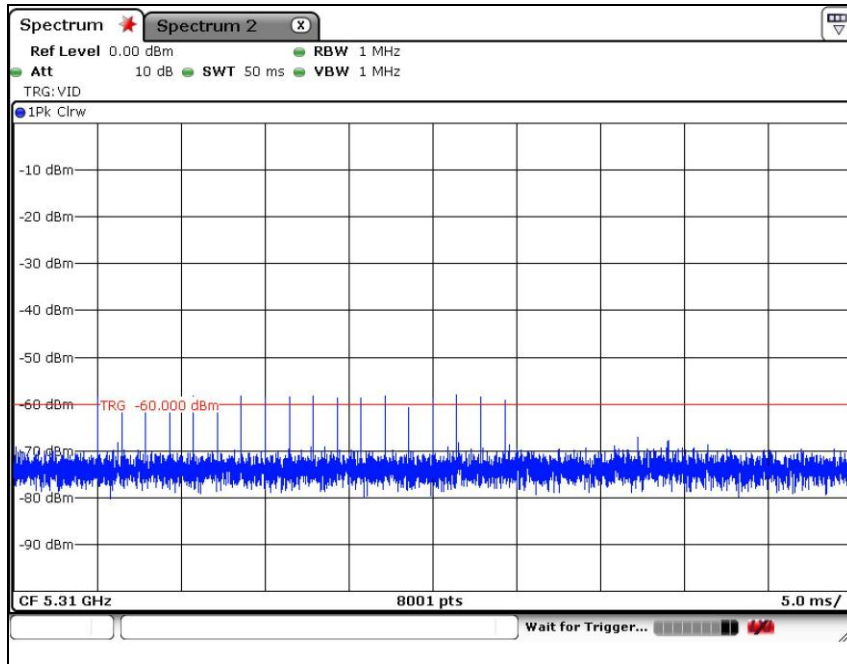

5 510 MHz

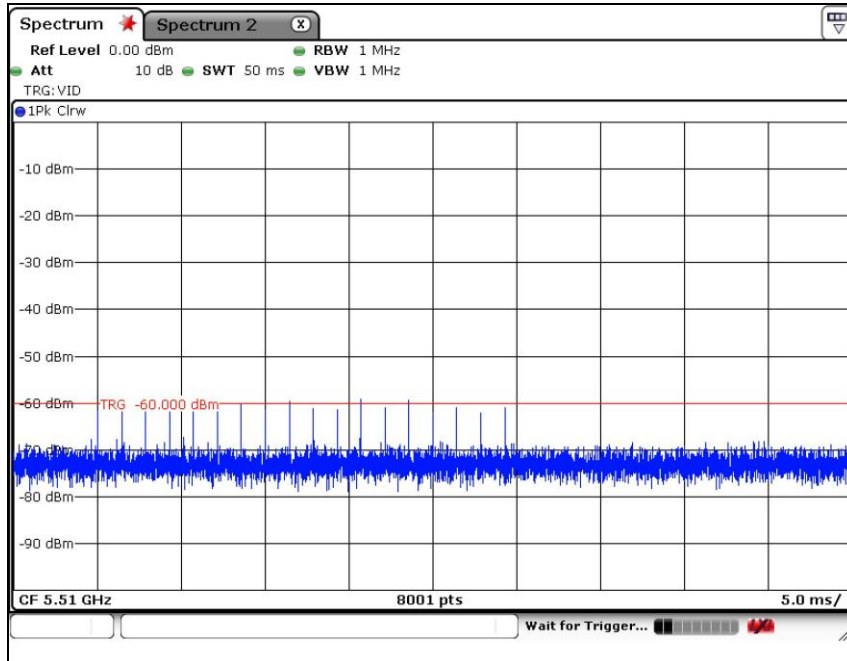

The results shown in this test report refer only to the sample(s) tested unless otherwise stated. This test report cannot be reproduced, except in full, without prior written permission of the Company.

**Plot of LAN traffic**

5 310 MHz

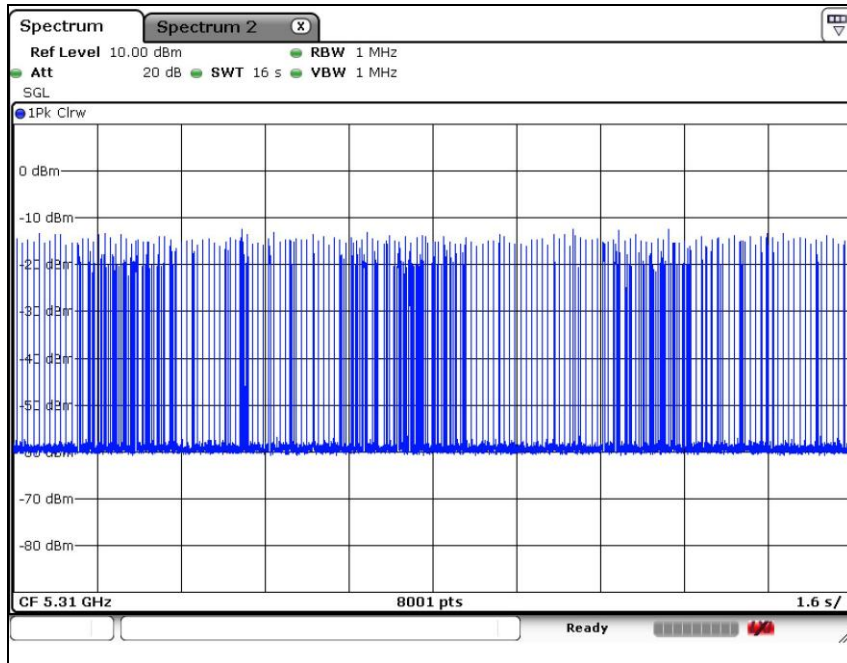

5 510 MHz

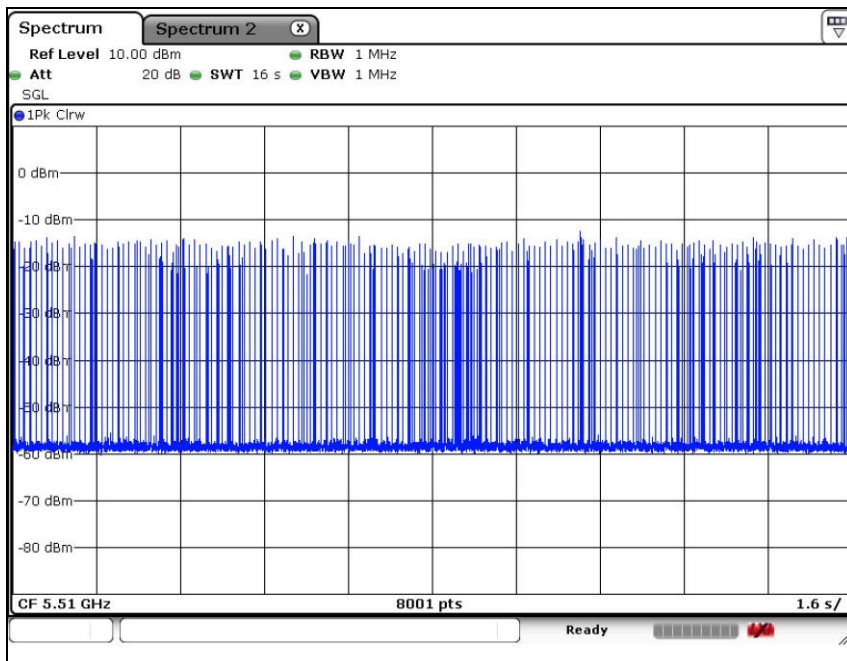

The results shown in this test report refer only to the sample(s) tested unless otherwise stated. This test report cannot be reproduced, except in full, without prior written permission of the Company.

The reference maker is set after 200 ms from the end of Last radar pulse.

The delta is set at the end of the last WLAN transmission following the radar pulse. This delta is the channel move time within the 10 sec.

The aggregate channel closing transmission time is calculated as follows:

Aggregate Transmission Time= (Number of analyzer bins showing transmission)\*(dwell time per bin)

The observation period over which the aggregated time is calculated begins at (Reference Maker) and ends no earlier than (Reference Maker +10 sec)

### 2.3. Test result

Frequency (MHz)	Channel Move Time (sec)	Limit
5 310	0.410	Not exceed 10 sec
5 510	0.360	
Frequency (MHz)	Aggregate channel closing transmission time (msec)	Limit
5 310	8	Not exceed 60 msec
5 510	4	

Aggregate channel closing transmission time

[16s (sweep time) / 8 001 (sweep point)] × The number of channel bin from 200 ms at the end of radar pulse.

5 310 MHz: (16 / 8 001) × 4 = 8 ms

5 510 MHz: (16 / 8 001) × 2 = 4 ms

Frequency (MHz)	Non-occupancy period (min)	Limit
5 310	Above 30	Not be less than 30 minute
5 510	Above 30	

The results shown in this test report refer only to the sample(s) tested unless otherwise stated. This test report cannot be reproduced, except in full, without prior written permission of the Company.

**Plot of channel move time & aggregate channel closing transmission time**

5 310 MHz

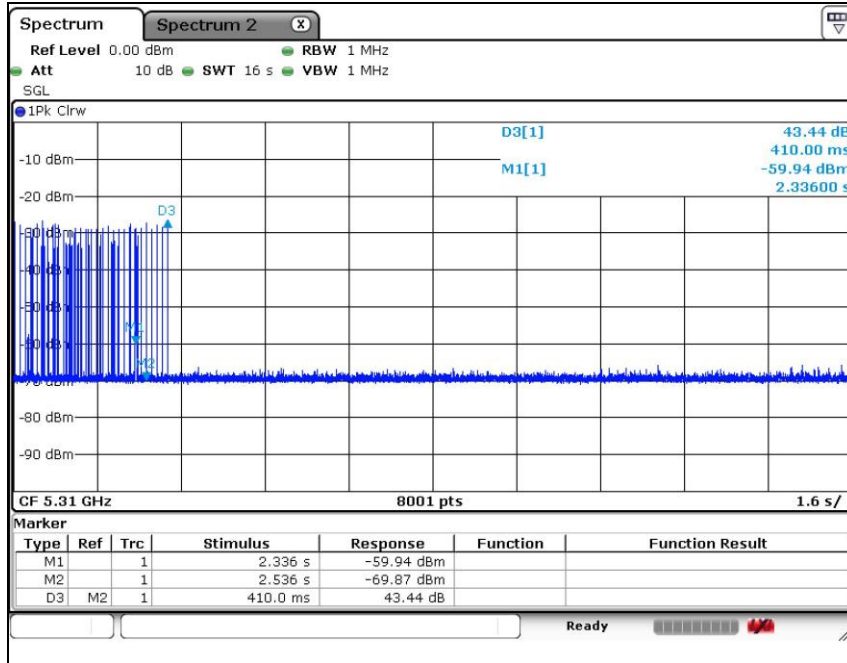

5 510 MHz

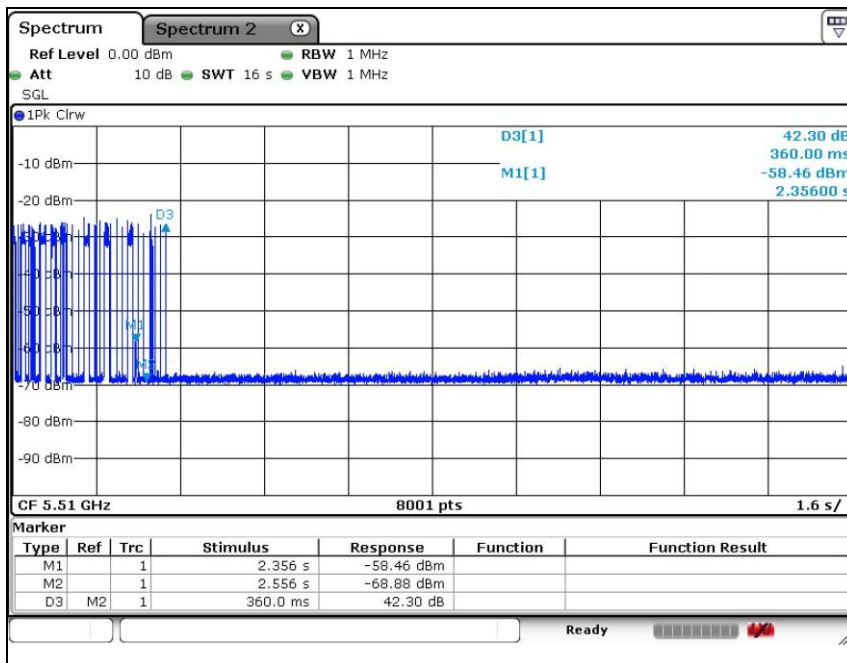

The results shown in this test report refer only to the sample(s) tested unless otherwise stated. This test report cannot be reproduced, except in full, without prior written permission of the Company.

**Plot of Non-occupancy period**

5 310 MHz

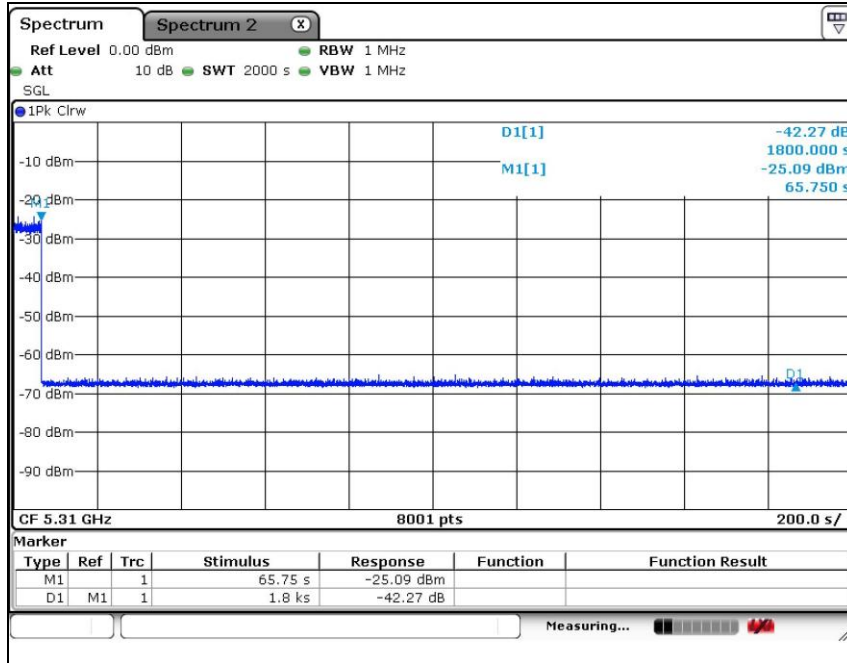

5 510 MHz

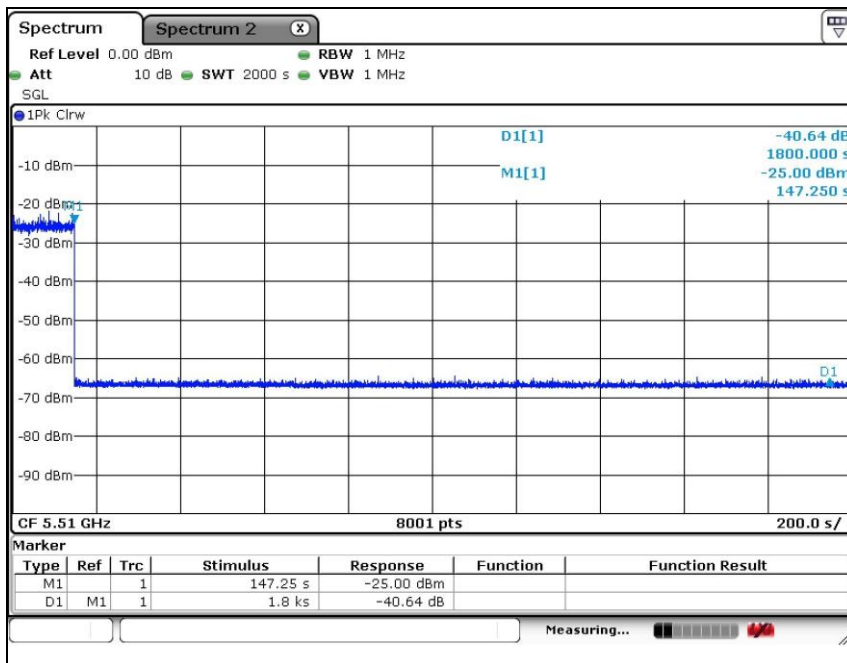

The results shown in this test report refer only to the sample(s) tested unless otherwise stated. This test report cannot be reproduced, except in full, without prior written permission of the Company.