



# HCT CO., LTD.

## CERTIFICATE OF COMPLIANCE FCC Certification(DFS)

<b>Applicant Name:</b> LG Electronics MobileComm U.S.A., Inc.	<b>Date of Issue:</b> September 16, 2013
<b>Address:</b> 1000 Sylvan Avenue, Englewood Cliffs NJ 07632	<b>Test Site/Location:</b> HCT CO., LTD., 105-1, Jangam-ri, Majang-Myeon, Icheon-si, Kyunggi-Do, Korea
	<b>Report No.:</b> HCTR1309FR14
	<b>HCT FRN:</b> 0005866421

<b>FCC ID</b>	<b>: ZNFLGL22</b>
<b>APPLICANT</b>	<b>: LG Electronics MobileComm U.S.A., Inc.</b>

**FCC Model(s):** KS1204

**EUT Type:** Cellular/PCS GSM/GPRS/EDGE Cellular WCDMA/HSDPA/HSUPA Phone with Bluetooth/WLAN/NFC

**Max. RF Output Power:** 802.11a\_UNII2 Band(12.00 dBm), 802.11n\_20 MHz BW\_UNII2 Band(11.03 dBm)/  
802.11n\_40 MHz BW\_UNII2 Band(11.27 dBm), 802.11ac\_20 MHz BW\_UNII2 Band(10.27 dBm)/  
802.11ac\_40 MHz BW\_UNII2 Band(10.53 dBm)/802.11ac\_80 MHz\_UNII2 Band(9.43 dBm)

802.11a\_UNII2e Band(11.90 dBm), 802.11n\_20 MHz BW\_UNII2e Band(10.89 dBm) /  
802.11n\_40 MHz BW\_UNII2e Band(10.88 dBm), 802.11ac\_20MHz BW\_UNII2e Band(10.18 dBm)/  
802.11ac\_40 MHz BW\_UNII2e Band(10.04 dBm), 802.11ac\_80 MHz BW\_UNII2e Band(9.77 dBm)

**Frequency Range:** 5260 MHz - 5320 MHz (UNII2 Band)  
5500 MHz - 5700 MHz (UNII2e Band)  
5500 MHz - 5720 MHz (UNII2e Band\_802.11ac)

**Modulation type** OFDM

**FCC Classification:** Unlicensed National Information Infrastructure (UNII)

**FCC Rule Part(s):** Part 15.407(DFS)

**Engineering Statement:**

The measurements shown in this report were made in accordance with the procedures indicated, and the emissions from this equipment were found to be within the limits applicable. I assume full responsibility for the accuracy and completeness of these measurements, and for the qualifications of all persons taking them.

**HCT CO., LTD.** Certifies that no party to this application has subject to a denial of Federal benefits that includes FCC benefits pursuant to section 5301 of the Anti-Drug Abuse Act of 1998,21 U.S. C.853(a)

**Report prepared by**  
**: Jong Seok Lee**  
**Test engineer of RF Team**

**Approved by**  
**: Chang Seok Choi**  
**Manager of RF Team**

This report only responds to the tested sample and may not be reproduced, except in full, without written approval of the HCT Co., Ltd.

FCC PT.15.247 TEST REPORT	FCC CERTIFICATION REPORT		<a href="http://www.hct.co.kr">www.hct.co.kr</a>
Test Report No. HCTR1309FR14	Date of Issue: September 16, 2013	EUT Type: Cellular/PCS GSM/GPRS/EDGE Cellular WCDMA/HSDPA/HSUPA Phone with Bluetooth/WLAN/NFC	FCC ID: ZNFLGL22



# Version

TEST REPORT NO.	DATE	DESCRIPTION
HCTR1309FR14	September 16, 2013	- First Approval Report

<b>FCC PT.15.247 TEST REPORT</b>	<b>FCC CERTIFICATION REPORT</b>		<a href="http://www.hct.co.kr">www.hct.co.kr</a>
<b>Test Report No.</b> HCTR1309FR14	<b>Date of Issue:</b> September 16, 2013	<b>EUT Type:</b> Cellular/PCS GSM/GPRS/EDGE Cellular WCDMA/HSDPA/HSUPA Phone with Bluetooth/WLAN/NFC	<b>FCC ID:</b> ZNFLGL22

# Table of Contents

1. GENERAL INFORMATION .....	4
2. EUT DESCRIPTION .....	4
3. SCOPE .....	5
4. INSTRUMENT CALIBRATION.....	5
5. FACILITIES AND ACCREDITATIONS .....	5
5.1 FACILITIES .....	5
5.2 EQUIPMENT .....	5
6. SUMMARY OF TEST RESULTS .....	6
7. DESCRIPTION OF DYNAMIC FREQUENCY SELECTION TEST.....	7
7.1 APPLICABILITY .....	7
7.2 REQUIREMENTS.....	7
7.3 DFS DETECTION THRESHOLD VALUES .....	9
7.4 PARAMETERS OF DFS TEST SIGNALS.....	9
7.5 TEST AND MEASUREMENT SYSTEM .....	1 1
7.6 DESCRIPTION OF EUT.....	1 3
7.7 UNII 2 TEST RESULT .....	1 4
7.8 UNII 2e TEST RESULT.....	2 0
8. LIST OF TEST EQUIPMENT .....	2 4

FCC PT.15.247 TEST REPORT	FCC CERTIFICATION REPORT		<a href="http://www.hct.co.kr">www.hct.co.kr</a>
Test Report No. HCTR1309FR14	Date of Issue: September 16, 2013	EUT Type: Cellular/PCS GSM/GPRS/EDGE Cellular WCDMA/HSDPA/HSUPA Phone with Bluetooth/WLAN/NFC	FCC ID: ZNFLGL22



## 1. GENERAL INFORMATION

**Applicant:** LG Electronics MobileComm U.S.A., Inc.  
**Address:** 1000 Sylvan Avenue, Englewood Cliffs NJ 07632  
**FCC ID:** ZNFLGL22  
**EUT Type:** Cellular/PCS GSM/GPRS/EDGE Cellular WCDMA/HSDPA/HSUPA Phone with Bluetooth/WLAN/NFC  
**Model Name:** KS1204  
**Date(s) of Tests:** August 30, 2013 ~ September 05, 2013  
**Place of Tests:** HCT Co., Ltd.  
 105-1, Jangam-ri , Majang-Myeon, Icheon-si, Kyunggi-Do, 467-811, KOREA.  
 (IC Recognition No. : 5944A-3)

## 2. EUT DESCRIPTION

<b>EUT Type</b>	Cellular/PCS GSM/GPRS/EDGE Cellular WCDMA/HSDPA/HSUPA Phone with Bluetooth/WLAN/NFC
<b>Model Name</b>	KS1204
<b>Power Supply</b>	DC 3.8 V
<b>Battery type</b>	Li-ion Battery(Standard)
<b>Frequency Range</b>	5260 MHz - 5320 MHz (UNII2 Band)_20 MHz BW 5500 MHz - 5700 MHz (UNII2e Band)_20 MHz BW where)Not supported 5600 MHz - 5650 MHz 5500 MHz - 5720 MHz (UNII2e Band)_802.11ac where)Not supported 5600 MHz - 5650 MHz
<b>Max. RF Output Power:</b>	802.11a_UNII2 Band(12.00 dBm), 802.11n_20 MHz BW_UNII2 Band(11.03 dBm)/ 802.11n_40 MHz BW_UNII2 Band(11.27 dBm)/ 802.11ac_20 MHz BW_UNII2 Band(10.27 dBm)/ 802.11ac_40 MHz BW_UNII2 Band(10.53 dBm)/802.11ac_80 MHz_UNII2 Band(9.43 dBm)/ 802.11a_UNII2e Band(11.90 dBm), 802.11n_20 MHz BW_UNII2e Band(10.89 dBm)/ 802.11n_40 MHz BW_UNII2e Band(10.88 dBm)/ 802.11ac_20MHz BW_UNII2e Band(10.18 dBm)/ 802.11ac_40 MHz BW_UNII2e Band(10.04 dBm)/ 802.11ac_80 MHz BW_UNII2e Band(9.77 dBm)
<b>Modulation Type</b>	OFDM
<b>Antenna Specification</b>	Manufacturer: Ace Technology Antenna type: PIFA Antenna Peak Gain : -1.21 dBi (5260 MHz – 5320 MHz) -1.28 dBi (5500 MHz – 5700 MHz)

FCC PT.15.247 TEST REPORT	FCC CERTIFICATION REPORT		<a href="http://www.hct.co.kr">www.hct.co.kr</a>
Test Report No. HCTR1309FR14	Date of Issue: September 16, 2013	EUT Type: Cellular/PCS GSM/GPRS/EDGE Cellular WCDMA/HSDPA/HSUPA Phone with Bluetooth/WLAN/NFC	FCC ID: ZNFLGL22



### 3. SCOPE

This report has been prepared to demonstrate compliance with the requirements for Dynamic Frequency Selection(DFS) as stated in FCC 06-96. Testing was performed KS1204 in accordance with the measurement procedure described in Appendix B of FCC 06-96. As of July 20, 2007 all devices operating in the UNII 2 Band and /or the UNII 2e Bands must comply with the DFS requirements. As the EUT does not have radar detection capability it was evaluated as a Client Only Device.

### 4. INSTRUMENT CALIBRATION

The measuring equipment, which was utilized in performing the tests documented herein, has been calibrated in accordance with the manufacturer's recommendations for utilizing calibration equipments, which is traceable to recognized national standards.

### 5. FACILITIES AND ACCREDITATIONS

#### 5.1 FACILITIES

The SAC(Semi-Anechoic Chamber) and conducted measurement facility used to collect the radiated data are located at the 105-1, Jangam-ri, Majang-Myeon, Icheon-si, Kyunggi-Do, 467-811, Korea. The site is constructed in conformance with the requirements of ANSI C63.4. (Version :2003) and CISPR Publication 22. Detailed description of test facility was submitted to the Commission and accepted dated March 02, 2011 (Registration Number: 90661)

#### 5.2 EQUIPMENT

Radiated emissions are measured with one or more of the following types of Linearly polarized antennas: tuned dipole, bi-conical, log periodic, bi-log, and/or ridged waveguide, horn. Spectrum analyzers with pre-selectors and quasi-peak detectors are used to perform radiated measurements. Conducted emissions are measured with Line Impedance Stabilization Networks and EMI Test Receivers. Calibrated wideband preamplifiers, coaxial cables, and coaxial attenuators are also used for making measurements.

All receiving equipment conforms to CISPR Publication 16-1, "Radio Interference Measuring Apparatus and Measurement Methods."

FCC PT.15.247 TEST REPORT		FCC CERTIFICATION REPORT		<a href="http://www.hct.co.kr">www.hct.co.kr</a>
Test Report No. HCTR1309FR14	Date of Issue: September 16, 2013	EUT Type: Cellular/PCS GSM/GPRS/EDGE Cellular WCDMA/HSDPA/HSUPA Phone with Bluetooth/WLAN/NFC		FCC ID: ZNFLGL22

## 6. SUMMARY OF TEST RESULTS

Band	Parameter	Measured	Limit	Result
UNII2	Channel Move Time	554.828 ms	10 seconds	PASS
	Channel Closing Transmission Time	< 200 ms + 866.56 $\mu$ s (aggregate)	200 ms + aggregate of 60 ms over remaining 10 second period	PASS
	Non-occupancy Period	Monitored > 30 minutes (No transmission occurred)	30 minutes	PASS
UNII2e	Channel Move Time	585.115 ms	10 seconds	PASS
	Channel Closing Transmission Time	< 200 ms + 891.36 $\mu$ s (aggregate)	200 ms + aggregate of 60 ms over remaining 10 second period	PASS
	Non-occupancy Period	Monitored > 30 minutes (No transmission occurred)	30 minutes	PASS

## 7. DESCRIPTION OF DYNAMIC FREQUENCY SELECTION TEST

### 7.1 APPLICABILITY

The following table from FCC 06-96 lists the applicable requirements for the DFS testing. The device evaluated in this report is considered a client device without radar detection capability.

Requirement	Operation Mode		
	Master	Client Without Radar Detection	Client With Radar Detection
Non-Occupancy Period	Yes	Not required	Yes
DFS Detection Threshold	Yes	Not required	Yes
Channel Availability Check Time	Yes	Not required	Not required
Uniform Spreading	Yes	Not required	Not required
U-NII Detection Bandwidth	Yes	Not required	Yes

Table 1-1. DFS Applicability

Requirement	Operation Mode		
	Master	Client Without Radar Detection	Client With Radar Detection
DFS Detection Threshold	Yes	Not required	Yes
Channel Closing Transmission Time	Yes	Yes	Yes
Channel Move Time	Yes	Yes	Yes
U-NII Detection Bandwidth	Yes	Not required	Yes

Table 1-2. DFS Applicability During Normal Operation

### 7.2 REQUIREMENTS

Per FCC 06-96 the following are the requirements for Client Devices:

- a) A Client Device will not transmit before having received appropriate control signals from a Master Device.
- b) A Client Device will stop all its transmissions whenever instructed by a Master Device to which it is associated and will meet the Channel Move Time and Channel Closing Transmission Time requirements.

The Client Device will not resume any transmissions until it has again received control signals from a Master Device.

- c) If a Client Device is performing In-Service Monitoring and detects a Radar Waveform

FCC PT.15.247 TEST REPORT		FCC CERTIFICATION REPORT		<a href="http://www.hct.co.kr">www.hct.co.kr</a>
Test Report No. HCTR1309FR14	Date of Issue: September 16, 2013	EUT Type: Cellular/PCS GSM/GPRS/EDGE Cellular WCDMA/HSDPA/HSUPA Phone with Bluetooth/WLAN/NFC		FCC ID: ZNFLGL22



above the DFS Detection Threshold, it will inform the Master Device. This is equivalent to the Master Device detecting the Radar Waveform and d) through f) of section 5.1.1 apply.

d) Irrespective of Client Device or Master Device detection the Channel Move Time and Channel Closing Transmission Time requirements remain the same.

Channel Move Time and Channel Closing Transmission Time requirements are listed following table.

Parameter	Value
Non-occupancy period	Minimum 30 minutes
Channel Availability Check Time	60 seconds
Channel Move Time	10 seconds See Note 1.
Channel Closing Transmission Time	200 milliseconds + an Aggregate of 60 milliseconds over Remaining 10 second period. See Notes 1 and 2.
U-NII Detection Bandwidth	Minimum 80 % of the U-NII 99 % transmission Power bandwidth. See Note 3.
<p><b>Note 1: The instant that the Channel Move Time and the Channel Closing Transmission Time begins is</b> as follows:</p> <ul style="list-style-type: none"> <li>• For the Short Pulse Radar Test Signals this instant is the end of the Burst.</li> <li>• For the Frequency Hopping radar Test Signal, this instant is the end of the last radar Burst generated.</li> <li>• For the Long Pulse Radar Test Signal this instant is the end of the 12 second period defining the Radar Waveform.</li> </ul> <p><b>Note 2: The Channel Closing Transmission Time is comprised of 200 milliseconds starting at</b> the beginning of the Channel Move Time plus any additional intermittent control signals required to facilitate a Channel move (an aggregate of 60 milliseconds) during the remainder of the 10 second period. The aggregate duration of control signals will not count quiet periods in between transmissions.</p> <p><b>Note 3: During the U-NII Detection Bandwidth detection test, Radar type 1 is used and for each</b> frequency step the minimum percentage of detection is 90 percent. Measurements are performed with no data traffic.</p>	

Table 1-3: DFS Response requirements



### 7.3 DFS DETECTION THRESHOLD VALUES

The DFS detection thresholds are defined for Master devices and Client Devices with In-service monitoring. These detection thresholds are listed in the following table.

Maximum Transmit Power	Value (See Notes 1 and 2)
≥ 200 milliwatt	-64 dBm
< 200 milliwatt	-62 dBm
<p>Note 1: This is the level at the input of the receiver assuming a 0 dBi receive antenna.</p> <p>Note 2: Throughout these test procedures an additional 1 dB has been added to the amplitude of the test transmission waveforms to account for variations in measurement equipment. This will ensure that the test signal is at or above the detection threshold level to trigger a DFS response.</p>	

Table 1-4: Detection Thresholds for Master Devices and Client Devices with Radar Detection

### 7.4 PARAMETERS OF DFS TEST SIGNALS

As the EUT is a Client Device with no Radar Detection only one type radar pulse is required for the testing. Radar Pulse type 1 was used in the evaluation of the Client device for the purpose of measuring the Channel Move Time and the Channel Closing Transmission Time. Table 3-5 lists the parameters for the Short Pulse Radar Waveforms. A plot of the Radar pulse Type 1 used for testing is included in Section 5.0 of this report.

Radar Type	Pulse Width (µsec)	PRI (µsec)	Number Of Pulses	Minimum Percentage of Successful Detection	Minimum Number of Trials
1	1	1428	18	60 %	30
2	1-5	150-230	23-29	60 %	30
3	6-10	200-500	16-18	60 %	30
4	11-20	200-500	12-16	60 %	30
Aggregate (Radar Types 1-4)				80 %	120

Table 1-5: Parameters for Short Pulse Radar Waveforms

Radar Type	Pulse Width (μsec)	Chirp Width (MHz)	PRI (μsec)	Number Of Pulses Per Burst	Number Of Burst	Minimum Percentage of Successful Detection	Minimum Number of Trials
5	50 - 100	5 - 20	5 - 20	1 - 3	8 - 20	60 %	30
Table 1-6. Parameters for Long Pulse Radar Waveforms							

Radar Type	Pulse Width (μsec)	PRI (μsec)	Pulse Per Hop	Hopping Rate (kHz)	Hopping Sequence Length (msec)	Minimum Percentage of Successful Detection	Minimum Number of Trials
6	1	333	9	0.333	300	70 %	30
Table 1-7. Parameters for Long Pulse Radar Waveforms							

## 7.5 TEST AND MEASUREMENT SYSTEM

### General Test Setup Procedure:

1. Connect FCC approved Master AP to a network, via wired Ethernet, that allows connection to an FTP server.
2. Associate the EUT with the Master AP.
3. Launch the FTP application on the EUT.
4. Connect to the FTP server application to the FTP server hosting the file
5. Initiate an FTP download of the file from the host.
6. Monitor the channel loading during transfer.
7. Reduce the maximum allowed data rate for the Master AP, using the AP's GUI interface.
8. Repeat steps 5-7 until the channel loading is as close to 20 % as possible.
9. Record the data rate setting on the Master AP and the channel loading.
10. While the system is performing an FTP transfer using the settings from item 9 above, perform the Channel Closing Transmission Time and Channel Move Time Measurements as required by FCC 06-96 using a conducted test.

### PROCEDURE

The FCC 06-96 describes a radiated test setup and a conducted test setup. A radiated test setup was used for this testing. Figure 3-1 shows the typical test setup. Each one channel selected between 5260 and 5320 MHz, 5500 and 5700 is chosen for the testing.

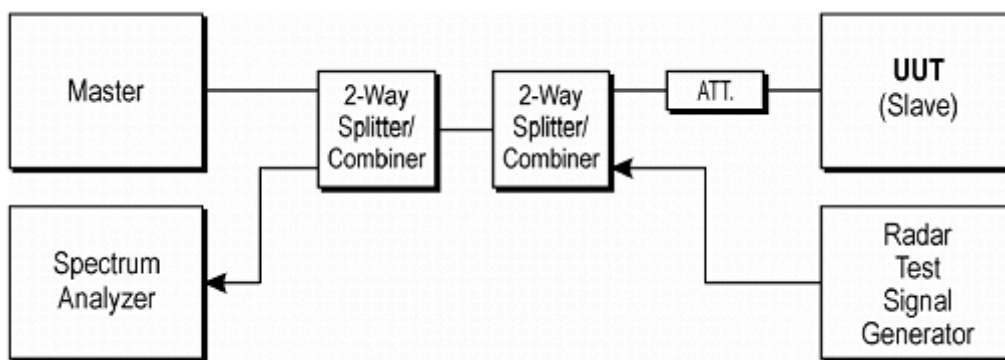

**Figure 3-1. Conducted Test Setup for DFS**

1. The radar pulse generator is setup to provide a pulse at the frequency that the Master and Client are operating. A Type 1 radar pulse with a 1  $\mu$ s pulse width and a 1428  $\mu$ s PRI is used for the testing.
2. The vector signal generator is adjusted to provide the radar burst (18 pulses) at a level of approximately -62 dBm at the antenna of the Master device.

FCC PT.15.247 TEST REPORT		FCC CERTIFICATION REPORT		<a href="http://www.hct.co.kr">www.hct.co.kr</a>
Test Report No. HCTR1309FR14	Date of Issue: September 16, 2013	EUT Type: Cellular/PCS GSM/GPRS/EDGE Cellular WCDMA/HSDPA/HSUPA Phone with Bluetooth/WLAN/NFC		FCC ID: ZNFLGL22



3. The Client Device (EUT) is set up per the diagram in Figure 3-1 and communications between the Master device and the Client is established.
4. The MPEG file specified by the FCC ("*6½ Magic Hours*") is streamed from the "file computer" through the Master to the Slave Device and played in full motion video using Media Player Classic Ver.6.4.8.6 in order to properly load the network.
5. The real time spectrum analyzer is set to record about 15 sec window to any transmissions occurring up to and after 10 sec.
6. The system is again setup and the monitoring time is shortened in order to capture the Channel Closing Transmission Time. This time is measured to insure that the Client ceases transmission within 200 ms and the aggregate of emissions occurring after 200 ms up to 10 sec do not exceed 60 ms.

(Note: the channel may be different since the Master and Client have changed channels due to the detection of the initial radar pulse.)

7. After the initial radar burst the channel is monitored for 30 minutes to insure no transmissions or beacons occur. A second monitoring setup is used to verify that the Master and Client have both moved to different channels.

### **SYSTEM CALIBRATION**

**A-50-ohm load is connected in place of the spectrum analyzer, and the spectrum analyzer is connected to a coaxial cable. The signal generator is set to CW mode. The amplitude of the signal generator is adjusted to yield a level of - 62 dBm as measured on the spectrum analyzer.**

**Without changing any of the instrument settings, the spectrum analyzer is reconnected to the common port of the spectrum analyzer combiner or divider.**

**The spectrum analyzer displays the level of the signal generator higher than the client TX level. Because we can not search the signal generator in the spectrum analyzer when the signal generator level is - 62 dBm. The spectrum analyzer will still indicate the level higher than the client TX level.**

<b>FCC PT.15.247 TEST REPORT</b>		<b>FCC CERTIFICATION REPORT</b>		<a href="http://www.hct.co.kr">www.hct.co.kr</a>
<b>Test Report No.</b> HCTR1309FR14	<b>Date of Issue:</b> September 16, 2013	<b>EUT Type:</b> Cellular/PCS GSM/GPRS/EDGE Cellular WCDMA/HSDPA/HSUPA Phone with Bluetooth/WLAN/NFC		<b>FCC ID:</b> ZNFLGL22



## 7.6 DESCRIPTION OF EUT

The EUT operates over the 5260 MHz - 5320 MHz and 5500 MHz - 5700 MHz ranges.

The EUT is a slave device without radar detection.

The EUT antenna has a gain of -1.21 dBi in the 5260 MHz - 5320 MHz band and -1.28 dBi in the 5500 MHz- 5700 MHz band.

The highest power level within these bands is 10.79 dBm EIRP in the 5260 MHz - 5320 MHz band and 10.62 dBm EIRP in the 5500 MHz – 5700 MHz band.

The EUT one transmitter/receiver chain connected to a coaxial cable to perform conducted tests.

TPC is not required since the maximum EIRP is less than 500 mW.

The EUT utilizes the 802.11a/n/ac architecture. Three nominal channel bandwidth is implemented: 20 MHz, 40 MHz and 80 MHz

<b>FCC PT.15.247 TEST REPORT</b>	<b>FCC CERTIFICATION REPORT</b>		<a href="http://www.hct.co.kr">www.hct.co.kr</a>
<b>Test Report No.</b> HCTR1309FR14	<b>Date of Issue:</b> September 16, 2013	<b>EUT Type:</b> Cellular/PCS GSM/GPRS/EDGE Cellular WCDMA/HSDPA/HSUPA Phone with Bluetooth/WLAN/NFC	<b>FCC ID:</b> ZNFLGL22

## 7.7 UNII 2 TEST RESULT

### RESULT PLOTS\_(UNII 2 Band)

Type1 Radar Pulse Number

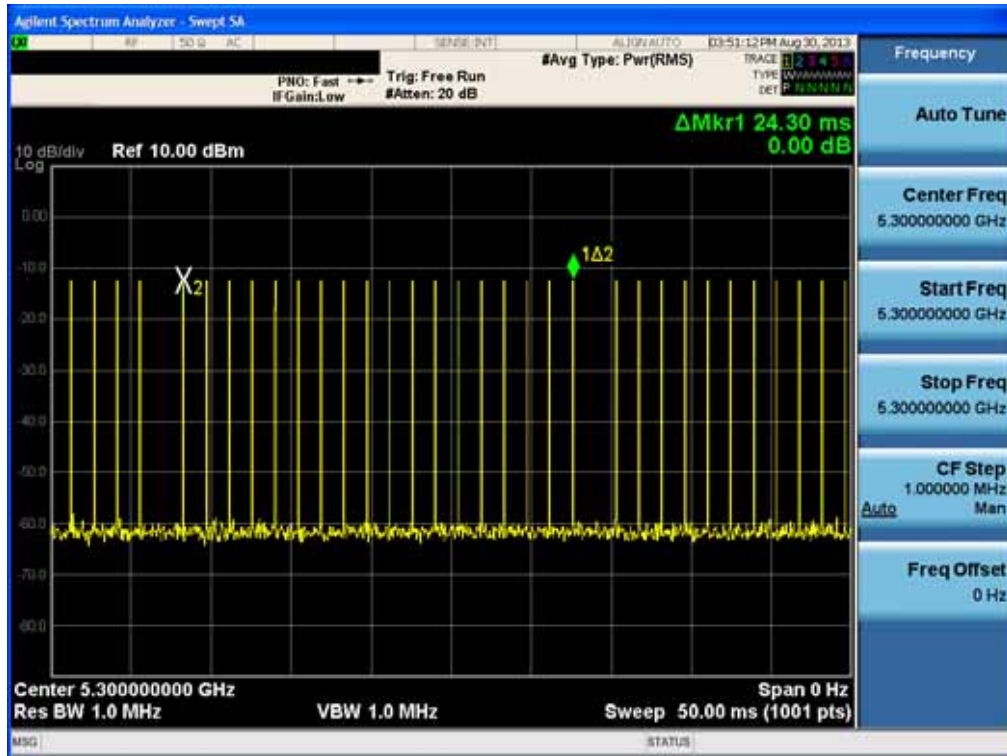

**Marker Descriptions:**

Number of Pulse Form M1R to M1 : 18

FCC PT.15.247 TEST REPORT	FCC CERTIFICATION REPORT		<a href="http://www.hct.co.kr">www.hct.co.kr</a>
Test Report No. HCTR1309FR14	Date of Issue: September 16, 2013	EUT Type: Cellular/PCS GSM/GPRS/EDGE Cellular WCDMA/HSDPA/HSUPA Phone with Bluetooth/WLAN/NFC	FCC ID: ZNFLGL22

Type1 PRI

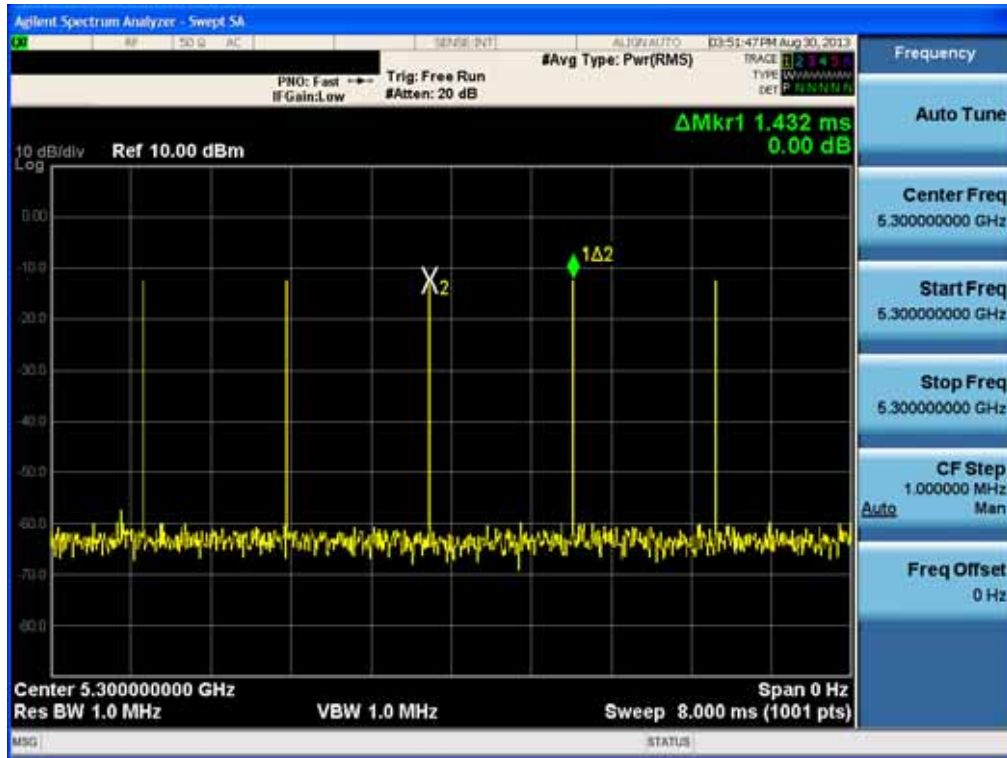

Time Display, Non WLAN Channel Traffic

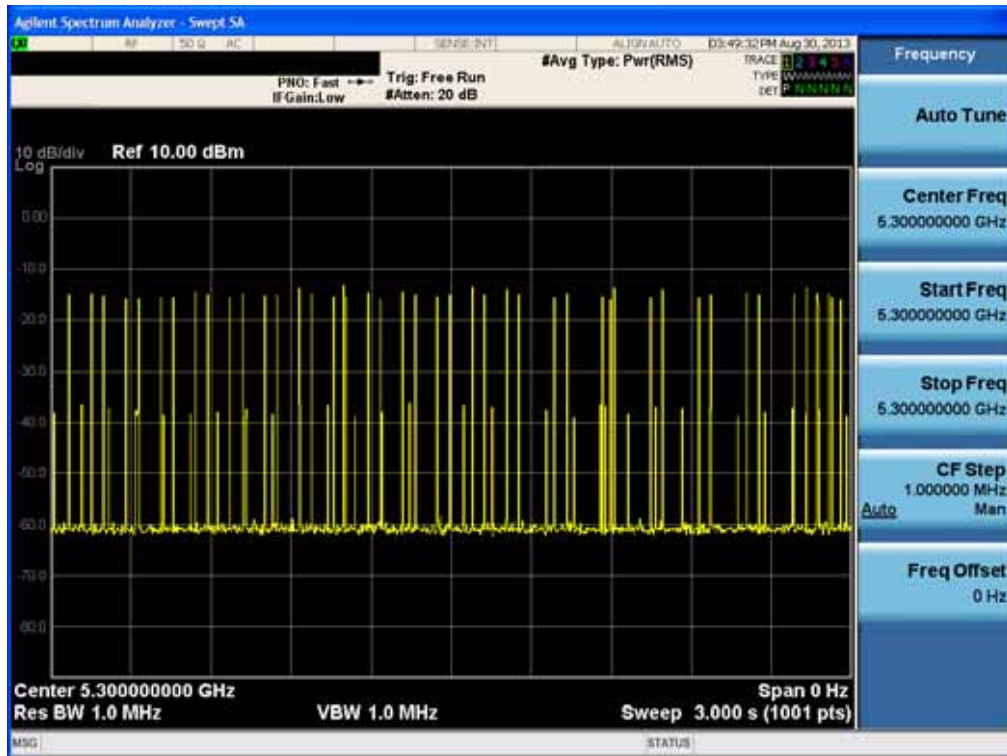

FCC PT.15.247 TEST REPORT	FCC CERTIFICATION REPORT		<a href="http://www.hct.co.kr">www.hct.co.kr</a>
Test Report No. HCTR1309FR14	Date of Issue: September 16, 2013	EUT Type: Cellular/PCS GSM/GPRS/EDGE Cellular WCDMA/HSDPA/HSUPA Phone with Bluetooth/WLAN/NFC	FCC ID: ZNFLGL22

Time Display, WLAN Channel Traffic (Streaming Video)

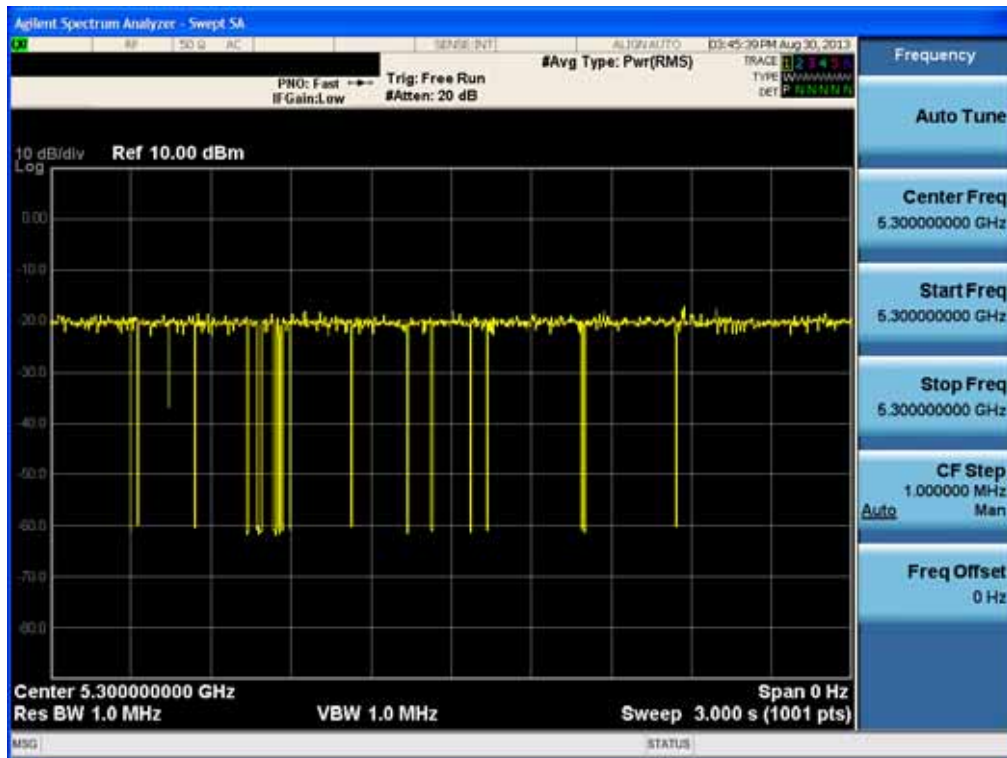

FCC PT.15.247 TEST REPORT	FCC CERTIFICATION REPORT		<a href="http://www.hct.co.kr">www.hct.co.kr</a>
Test Report No. HCTR1309FR14	Date of Issue: September 16, 2013	EUT Type: Cellular/PCS GSM/GPRS/EDGE Cellular WCDMA/HSDPA/HSUPA Phone with Bluetooth/WLAN/NFC	FCC ID: ZNFLGL22



Channel Move Time (< 10 sec)

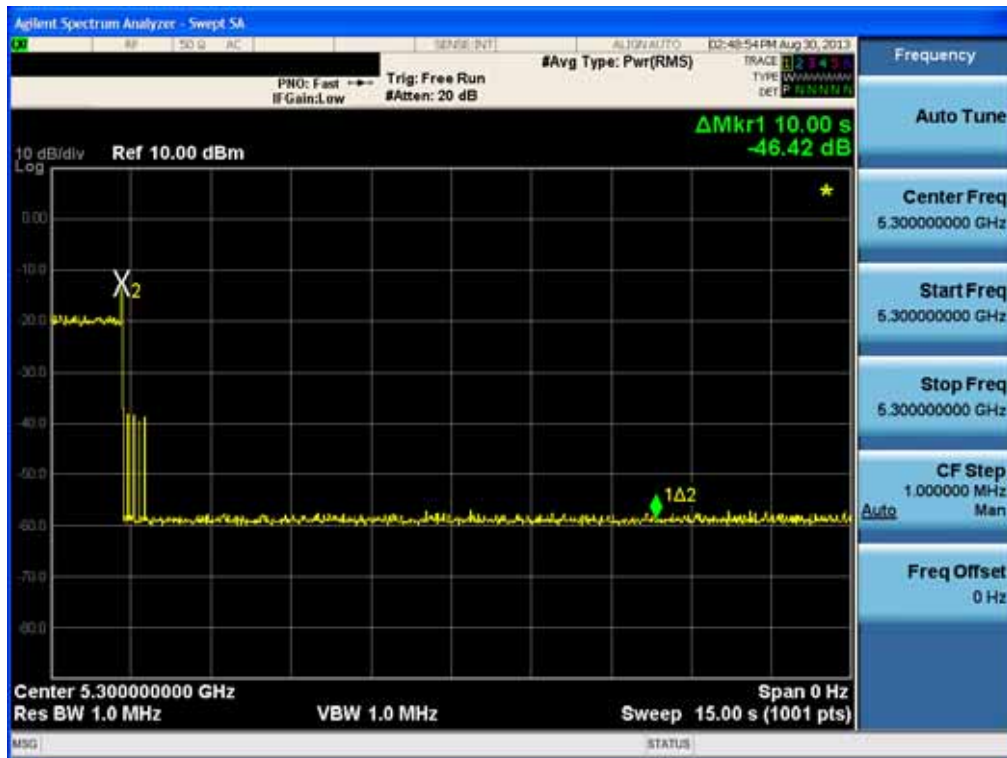

**Marker Descriptions:**

Time from M1R to M1 : 10 s

FCC PT.15.247 TEST REPORT	FCC CERTIFICATION REPORT		<a href="http://www.hct.co.kr">www.hct.co.kr</a>
Test Report No. HCTR1309FR14	Date of Issue: September 16, 2013	EUT Type: Cellular/PCS GSM/GPRS/EDGE Cellular WCDMA/HSDPA/HSUPA Phone with Bluetooth/WLAN/NFC	FCC ID: ZNFLGL22

Channel Closing Transmission Time, Aggregate Time After 200 ms



**Calculation of Aggregate Time:**

Pulse width = 18.0 ms (Delta Marker1)

Number of pulses occurring after 200 ms from end of burst = 3 ( Number from M3 to M4)

Aggregate time from 200 ms to 10 sec after burst = 3 x 18.0 ms = 54 ms

**Aggregate Time: 54 ms**

**Limit: 60 ms**

FCC PT.15.247 TEST REPORT	FCC CERTIFICATION REPORT		<a href="http://www.hct.co.kr">www.hct.co.kr</a>
Test Report No. HCTR1309FR14	Date of Issue: September 16, 2013	EUT Type: Cellular/PCS GSM/GPRS/EDGE Cellular WCDMA/HSDPA/HSUPA Phone with Bluetooth/WLAN/NFC	FCC ID: ZNFLGL22

Non-occupancy Period – Monitoring live real time spectrum – Elapse time 30 minutes

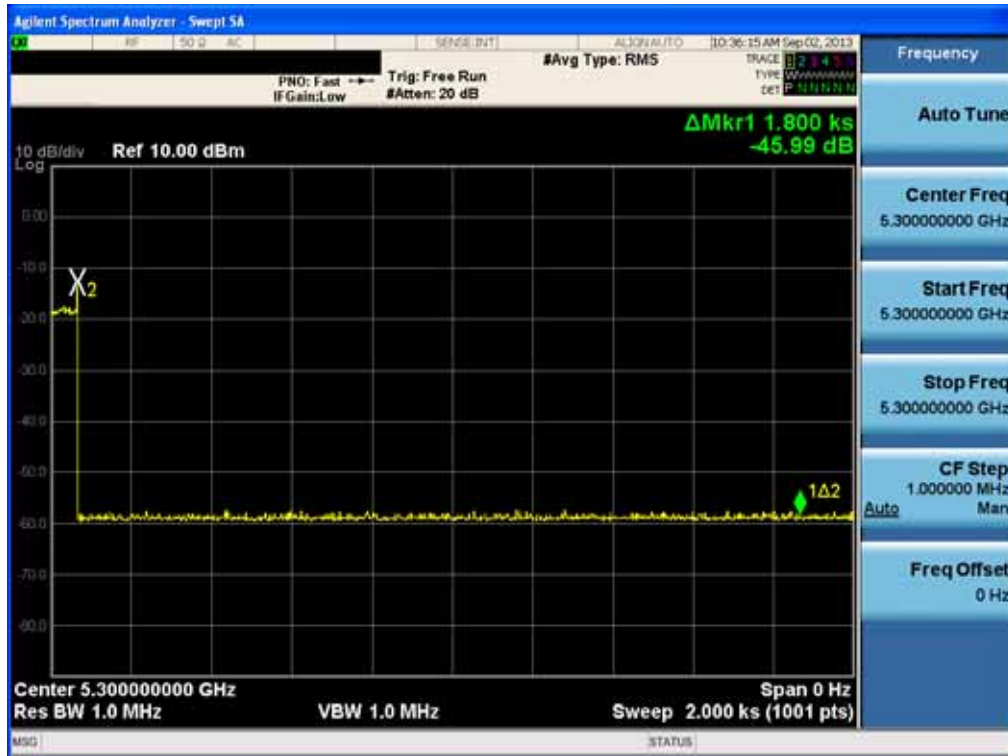

FCC PT.15.247 TEST REPORT	FCC CERTIFICATION REPORT		<a href="http://www.hct.co.kr">www.hct.co.kr</a>
Test Report No. HCTR1309FR14	Date of Issue: September 16, 2013	EUT Type: Cellular/PCS GSM/GPRS/EDGE Cellular WCDMA/HSDPA/HSUPA Phone with Bluetooth/WLAN/NFC	FCC ID: ZNFLGL22

## 7.8 UNII 2e TEST RESULT

### RESULT PLOTS\_(UNII 2e Band)

Time Display, Non WLAN Channel Traffic

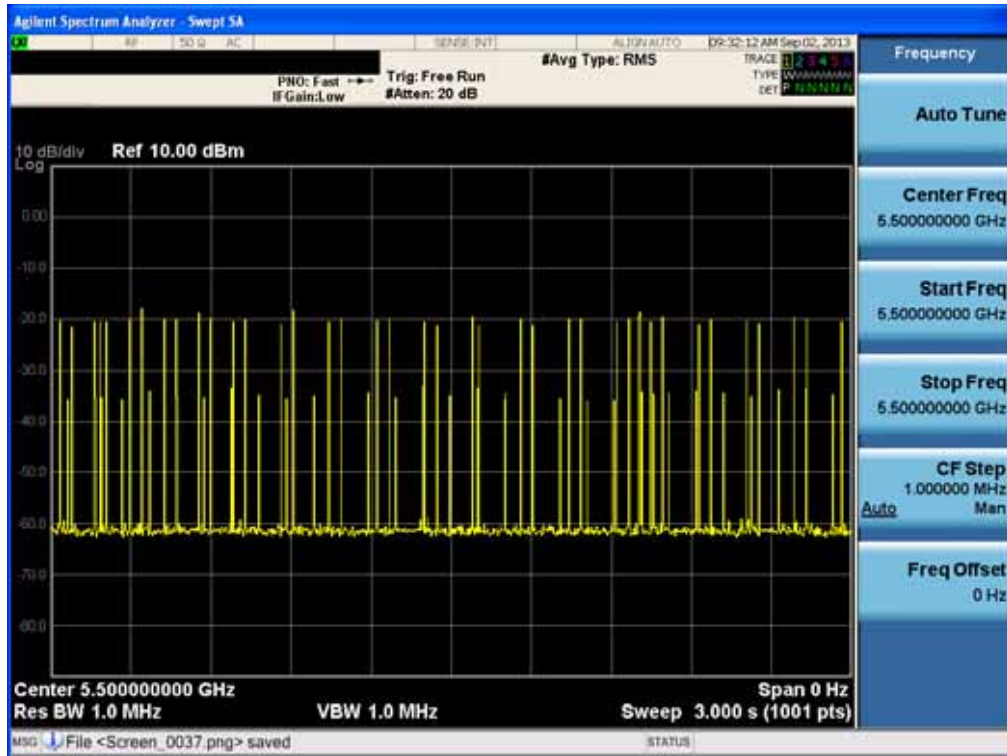

Time Display, WLAN Channel Traffic (Streaming Video)

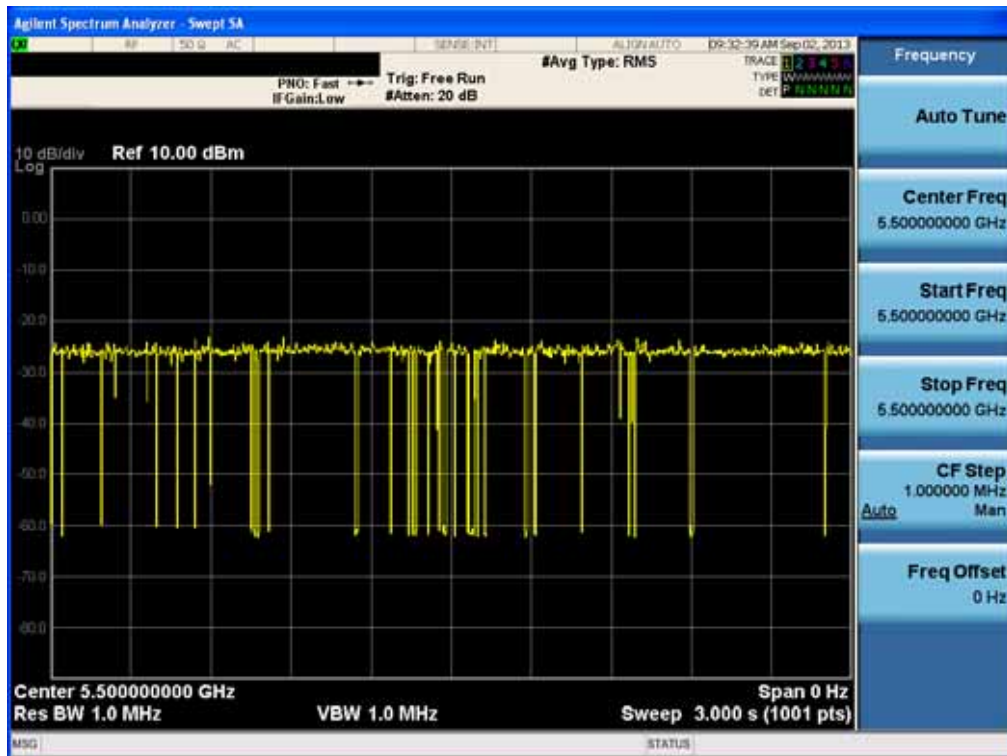

FCC PT.15.247 TEST REPORT	FCC CERTIFICATION REPORT		<a href="http://www.hct.co.kr">www.hct.co.kr</a>
Test Report No. HCTR1309FR14	Date of Issue: September 16, 2013	EUT Type: Cellular/PCS GSM/GPRS/EDGE Cellular WCDMA/HSDPA/HSUPA Phone with Bluetooth/WLAN/NFC	FCC ID: ZNFGL22

Channel Move Time (< 10 sec)

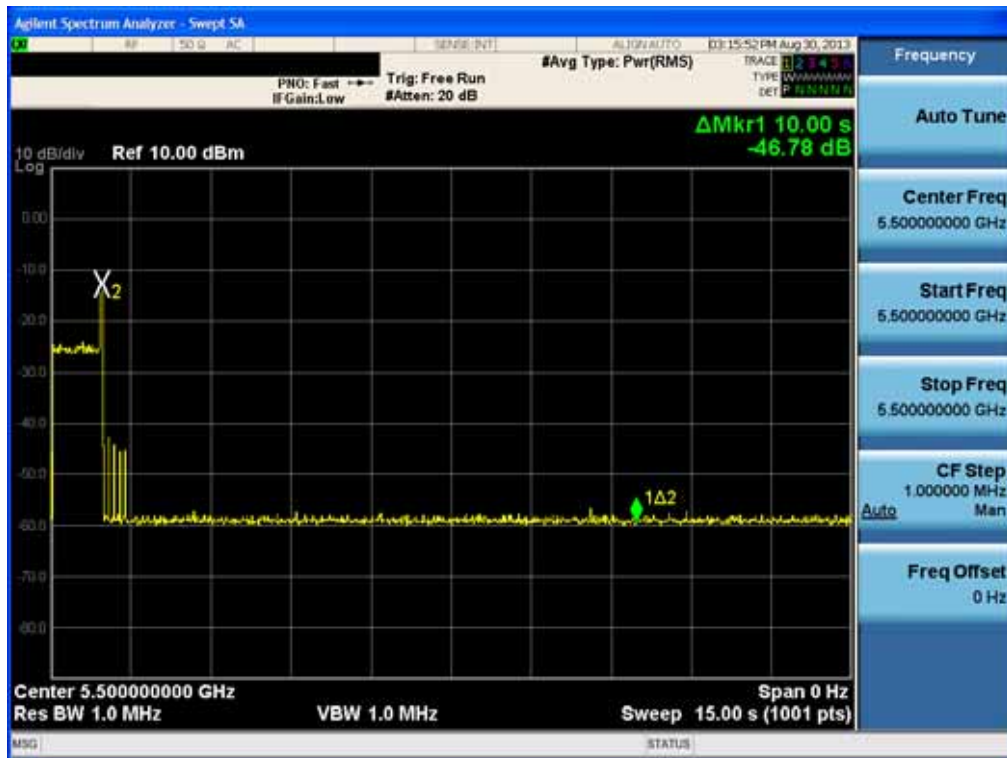

**Marker Descriptions:**

Time from M1R to M1 : 10 s

FCC PT.15.247 TEST REPORT		FCC CERTIFICATION REPORT		<a href="http://www.hct.co.kr">www.hct.co.kr</a>
Test Report No. HCTR1309FR14	Date of Issue: September 16, 2013	EUT Type: Cellular/PCS GSM/GPRS/EDGE Cellular WCDMA/HSDPA/HSUPA Phone with Bluetooth/WLAN/NFC		FCC ID: ZNFLGL22

Channel Closing Transmission Time, Aggregate Time After 200 ms



**Calculation of Aggregate Time:**

Pulse width = 18.0 ms (Delta Marker5)

Number of pulses occurring after 200 ms from end of burst = 3 ( Number from M3 to M4)

Aggregate time from 200 ms to 10 sec after burst = 3 x 18.0 ms = 54 ms

**Aggregate Time: 54 ms**

**Limit: 60 ms**

FCC PT.15.247 TEST REPORT	FCC CERTIFICATION REPORT		<a href="http://www.hct.co.kr">www.hct.co.kr</a>
Test Report No. HCTR1309FR14	Date of Issue: September 16, 2013	EUT Type: Cellular/PCS GSM/GPRS/EDGE Cellular WCDMA/HSDPA/HSUPA Phone with Bluetooth/WLAN/NFC	FCC ID: ZNFLGL22

Non-occupancy Period – Monitoring live real time spectrum – Elapse time 30 minutes

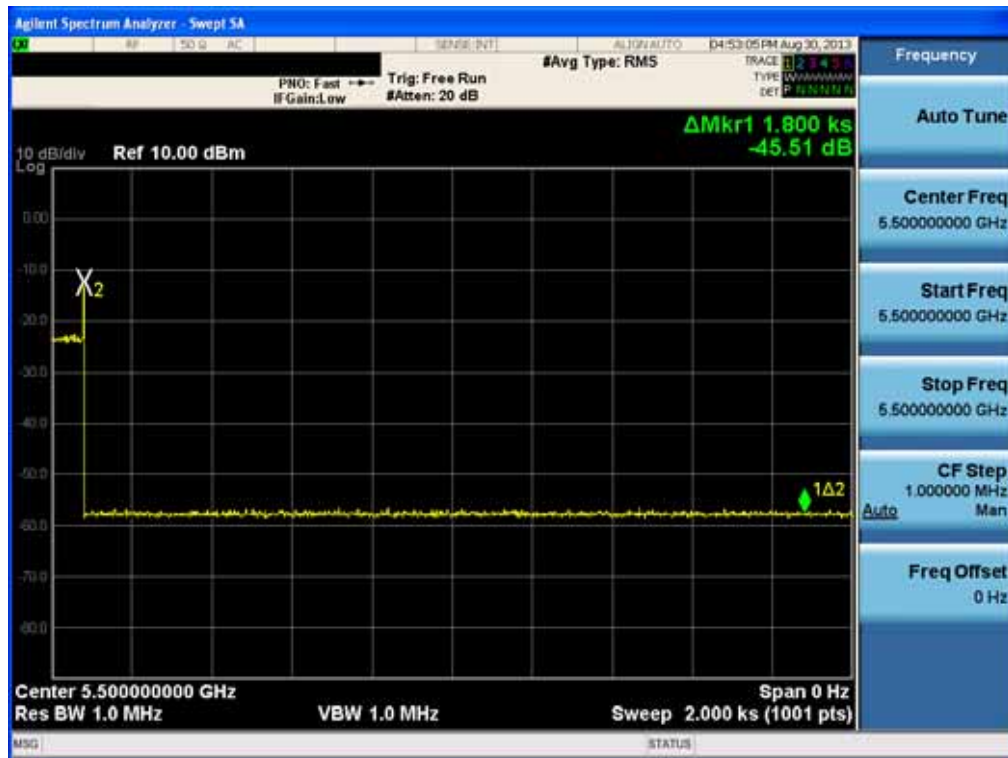

FCC PT.15.247 TEST REPORT	FCC CERTIFICATION REPORT		<a href="http://www.hct.co.kr">www.hct.co.kr</a>
Test Report No. HCTR1309FR14	Date of Issue: September 16, 2013	EUT Type: Cellular/PCS GSM/GPRS/EDGE Cellular WCDMA/HSDPA/HSUPA Phone with Bluetooth/WLAN/NFC	FCC ID: ZNFLGL22

## 8. LIST OF TEST EQUIPMENT

Manufacturer	Model / Equipment	Calibration Interval	Calibration Due	Serial No.
Cisco System	AIR-AP1242AG-K-K9 / Wireless AP (Master Device)	N/A	N/A	FCW1323U01K FCC ID: LDK102056
HP	MRLBB/1002 / Wireless AP (Master Device)	N/A	N/A	CN17DLM0JB FCC ID: RTP- MRLBB1003S
Rohde & Schwarz	SMBV 100A/ Signal Generator	Annual	11/07/2013	255727
Rohde & Schwarz	ENV216/ LISN	Annual	02/06/2014	100073
Schwarzbeck	VULB 9160/ TRILOG Antenna	Biennial	12/17/2014	3150
Rohde & Schwarz	ESI 40 / EMI TEST RECEIVER	Annual	04/16/2014	831564103
Agilent	E4440A/ Spectrum Analyzer	Annual	04/25/2014	US45303008
Agilent	N9020A/ SIGNAL ANALYZER	Annual	05/14/2014	MY51110063
HD	MA240/ Antenna Position Tower	N/A	N/A	556
EMCO	1050/ Turn Table	N/A	N/A	114
HD GmbH	HD 100/ Controller	N/A	N/A	13
HD GmbH	KMS 560/ SlideBar	N/A	N/A	12
Schwarzbeck	BBHA 9120D/ Horn Antenna	Biennial	10/17/2013	937
Schwarzbeck	BBHA9170 / Horn Antenna(15 GHz ~ 40 GHz)	Biennial	10/30/2014	BBHA9170124
Rohde & Schwarz	FSP / Spectrum Analyzer	Annual	02/08/2014	839117/011
Agilent	N1911A/Power Meter	Annual	01/22/2014	MY45100523
Agilent	N1921A /POWER SENSOR	Annual	07/11/2014	MY45241059
Hewlett Packard	11636B/Power Divider	Annual	11/07/2013	11377
Agilent	87300B/Directional Coupler	Annual	12/24/2013	3116A03621
Hewlett Packard	11667B / Power Splitter	Annual	05/29/2014	05001
DIGITAL	EP-3010 /DC POWER SUPPLY	Annual	11/07/2013	3110117
ITECH	IT6720 / DC POWER SUPPLY	Annual	11/07/2013	010002156287001199
Agilent	8493C / Attenuator(10 dB)	Annual	07/24/2014	76649