

TEST REPORT



DT&C Co., Ltd.

42, Yurim-ro, 154Beon-gil, Cheoin-gu, Yongin-si, Gyeonggi-do, Korea, 17042
Tel : 031-321-2664, Fax : 031-321-1664

1. Report No : DRTFCC1710-0218
2. Customer
 - Name : LG Electronics MobileComm USA, Inc.
 - Address : 1000 Sylvan Ave., Englewood Cliffs, New Jersey, United States, 07632
3. Use of Report : FCC Original Grant
4. Product Name / Model Name : Mobile Phone / L-01K
FCC ID : ZNFL01K
5. Test Method Used : KDB971168 D01v02r02, ANSI/TIA-603-E-2016
Test Specification : §2, §22(H), §24(E)
6. Date of Test : 2017.09.08 ~ 2017.10.12
7. Testing Environment : Refer to appended test report.
8. Test Result : Refer to attached test result.

Affirmation	Tested by	Technical Manager
	Name : JaeJin Lee  (Signature)	Name : GeunKi Son  (Signature)

The test results presented in this test report are limited only to the sample supplied by applicant and the use of this test report is inhibited other than its purpose. This test report shall not be reproduced except in full, without the written approval of DT&C Co., Ltd.

2017 . 10 . 18 .

DT&C Co., Ltd.

If this report is required to confirmation of authenticity, please contact to report@dtnc.net

Test Report Version

Test Report No.	Date	Description
DRTFCC1710-0218	Oct. 18, 2017	Initial issue

Table of Contents

1. GENERAL INFORMATION	4
2. INTRODUCTION	5
2.1. EUT DESCRIPTION	5
2.2. EUT CAPABILITIES.....	5
2.3. TESTING ENVIRONMENT	5
2.4. MEASURING INSTRUMENT CALIBRATION	5
2.5. MEASUREMENT UNCERTAINTY	5
2.6. TEST FACILITY	5
3. DESCRIPTION OF TESTS.....	6
3.1 ERP & EIRP (Effective Radiated Power & Equivalent Isotropic Radiated Power)	6
3.2 PEAK TO AVERAGE RATIO	8
3.3 OCCUPIED BANDWIDTH.	10
3.4 BAND EDGE EMISSIONS AT ANTENNA TERMINAL.	11
3.5 SPURIOUS AND HARMONIC EMISSIONS AT ANTENNA TERMINAL.....	12
3.6 RADIATED SPURIOUS EMISSIONS	13
3.7 FREQUENCY STABILITY / VARIATION OF AMBIENT TEMPERATURE.....	14
4. LIST OF TEST EQUIPMENT	15
5. SUMMARY OF TEST RESULTS.....	16
6. EMISSION DESIGNATOR AND SAMPLE CALCULATION	17
7. TEST DATA	19
7.1 PEAK TO AVERAGE RATIO	19
7.2 OCCUPIED BANDWIDTH	19
7.3 SPURIOUS AND HARMONIC EMISSIONS AT ANTENNA TERMINAL.....	19
7.4 BAND EDGE	19
7.5 EFFECTIVE RADIATED POWER.....	20
7.6 EQUIVALENT ISOTROPIC RADIATED POWER.....	21
7.7 RADIATED SPURIOUS EMISSIONS	22
7.8 FREQUENCY STABILITY / VARIATION OF AMBIENT TEMPERATURE.....	26
7.8.1 FREQUENCY STABILITY (GSM850)	26
7.8.2 FREQUENCY STABILITY (WCDMA850)	27
7.8.3 FREQUENCY STABILITY (GSM1900)	28
8. TEST PLOTS	29
8.1 Peak to Average Ratio	29
8.2 Occupied Bandwidth (99 % Bandwidth).....	30
8.3 Spurious Emissions at Antenna Terminal.....	38
8.4 Band Edge	47

1. GENERAL INFORMATION

Applicant Name : LG Electronics MobileComm USA, Inc.
Address : 1000 Sylvan Ave., Englewood Cliffs, New Jersey, United States, 07632
FCC ID : ZNFL01K
FCC Classification : PCS Licensed Transmitter Held to Ear (PCE)
EUT : Mobile Phone
Model Name : L-01K
Add Model Name : NA
Supplying power : DC 3.8 V
Antenna Type : Built-in type(PIFA Antenna)

Mode	Tx Frequency (MHz)	Emission Designator	ERP (Max. Power)		EIRP (Max. Power)	
			dBm	W	dBm	W
GSM850	824.2 ~ 848.8	246KGXW	30.15	1.035	-	-
WCDMA850	826.4 ~ 846.6	4M14F9W	21.88	0.154	-	-
HSUPA850	826.4 ~ 846.6	4M14F9W	21.05	0.127	-	-
GSM1900	1850.2 ~ 1909.8	246KGXW	-	-	27.77	0.598

2. INTRODUCTION

2.1. EUT DESCRIPTION

The Equipment Under Test (EUT) supports GSM/WCDMA/LTE Phone with Bluetooth, WLAN and NFC.

2.2. EUT CAPABILITIES

This ETU contains the following capabilities:

850/1900 GSM/GPRS, 850 WCDMA/HSUPA, Multi-band LTE, 802.11b/g/n/ac WLAN(2.4GHz), 802.11a/n/ac WLAN(5GHz), Bluetooth(BDR, EDR, LE), NFC

2.3. TESTING ENVIRONMENT

Ambient Condition	
▪ Temperature	+20 °C ~ +24 °C
▪ Relative Humidity	39 % ~ 45 %

2.4. MEASURING INSTRUMENT CALIBRATION

The measuring equipment, which was utilized in performing the tests documented herein, has been calibrated in accordance with the manufacturer's recommendations for utilizing calibration equipment, which is traceable to recognized national standards.

2.5. MEASUREMENT UNCERTAINTY

The measurement uncertainties shown below were calculated in accordance with requirements of ANSI C 63.4-2014. All measurement uncertainty values are shown with a coverage factor of $k = 2$ to indicate a 95 % level of confidence.

Parameter	Measurement uncertainty
<i>Radiated Disturbance (Below 1 GHz)</i>	± 5.1 dB (The confidence level is about 95 %, $k = 2$)
<i>Radiated Disturbance (1 GHz ~ 18 GHz)</i>	± 5.4 dB (The confidence level is about 95 %, $k = 2$)
<i>Radiated Disturbance (Above 18 GHz)</i>	± 5.3 dB (The confidence level is about 95 %, $k = 2$)

2.6. TEST FACILITY

DT&C Co., Ltd.	
The 3 m test site and conducted measurement facility used to collect the radiated data are located at the 42, Yurim-ro, 154beon-gil, Cheoin-gu, Yongin-si, Gyeonggi-do, Korea 17042. The site is constructed in conformance with the requirements. - FCC MRA Accredited Test Firm No. : KR0034	
www.dtnet.net	
Telephone	: + 82-31-321-2664
FAX	: + 82-31-321-1664

3. DESCRIPTION OF TESTS

3.1 ERP & EIRP (Effective Radiated Power & Equivalent Isotropic Radiated Power)

Test Set-up

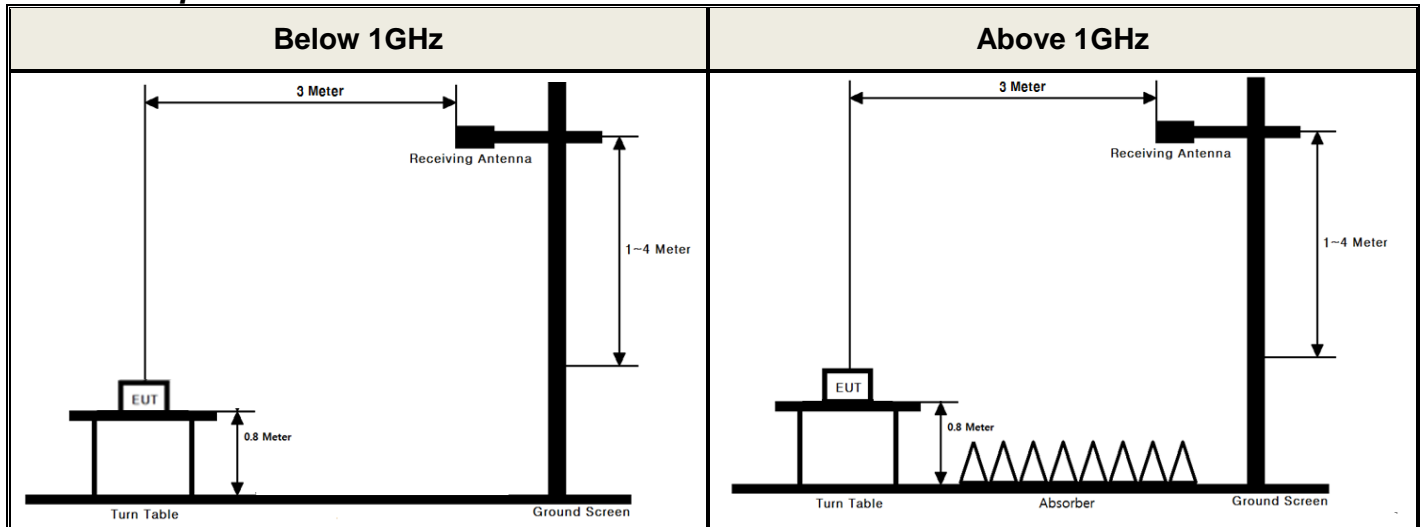

These measurements were performed at 3 m test site. The equipment under test is placed on a non-conductive table 0.8 meters above a turntable which is flush with the ground plane and 3 meters from the receive antenna. For measurements above 1GHz absorbers are placed on the floor between the turn table and the antenna mast in such a way so as to maximize the reduction of reflections. For measurements below 1 GHz, the absorbers are removed.

Test Procedure

- ANSI/TIA-603-E-2016 - Section 2.2.17
- KDB971168 D01v02r02 - Section 5.2.1

Test setting

1. Set span to at least 1.5 times the OBW.
 2. Set RBW = 1-5 % of the OBW, not to exceed 1 MHz.
 3. Set VBW $\geq 3 \times$ RBW.
 4. Set number of points in sweep $\geq 2 \times$ span / RBW.
 5. Sweep time = auto couple.
 6. Detector = RMS (power averaging).
 7. If the EUT can be configured to transmit continuously (i.e., burst duty cycle ≥ 98 %), then set the trigger to free run.
 8. If the EUT cannot be configured to transmit continuously (i.e., burst duty cycle < 98 %), then use a sweep trigger with the level set to enable triggering only on full power bursts and configure the EUT to transmit at full power for the entire duration of each sweep.
- Ensure that the sweep time is less than or equal to the transmission burst duration.
9. Trace average at least 100 traces in power averaging (i.e., RMS) mode.
 10. Compute the power by integrating the spectrum across the OBW of the signal using the instrument's band power measurement function, with the band limits set equal to the OBW band edges. If the instrument does not have a band power function, then sum the spectrum levels (in linear power units) at intervals equal to the RBW extending across the entire OBW of the spectrum.

The receive antenna height and turntable rotations were adjusted for the highest reading on the receive spectrum analyzer.

A half-wave dipole was substituted in place of the EUT. This dipole antenna was driven by a signal generator and the level of the signal generator was adjusted to obtain the same receive spectrum analyzer reading. The conducted power at the terminal of the substitute antenna is measured.

The ERP/EIRP is calculated using the following formula:

ERP/EIRP = The conducted power at the substitute antenna's terminal [dBm] + Substitute Antenna gain [dBd for ERP , dBi for EIRP]

For measurements above 1 GHz, the above procedure is repeated using horn antennas and the difference between the gain of the horn antenna and an isotropic antenna are taken into consideration.

3.2 PEAK TO AVERAGE RATIO

Test set-up

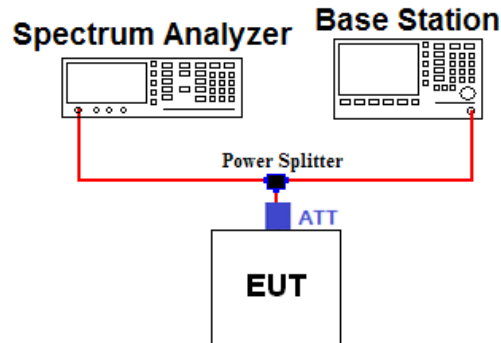

Test Procedure

- KDB971168 D01v02r02 - Section 5.7.1

A peak to average ratio measurement is performed at the conducted port of the EUT. The spectrum analyzer's Complementary Cumulative Distribution Function (CCDF) measurement profile is used to determine the largest deviation between the average and the peak power of the EUT in a given bandwidth. The CCDF curve shows how much time the peak waveform spends at or above a given average power level. The present of time the signal spends at or above the level defines the probability for that particular power level.

Test setting

The spectrum Analyzer's CCDF measurement function is enabled.

1. Set resolution/measurement bandwidth \geq signal's occupied bandwidth.
2. Set the number of counts to a value that stabilizes the measured CCDF curve
3. Set the measurement interval as follows:
 - 1) For continuous transmissions, set to 1 ms.
 - 2) For burst transmissions, employ an external trigger that is synchronized with the EUT burst timing sequence, or use the internal burst trigger with a trigger level that allows the burst to stabilize and set the measurement interval to a time that is less than or equal to the burst duration.
4. Record the maximum PAPR level associated with a probability of 0.1 %

■ Alternate Procedure

- KDB971168 D01v02r02 - Section 5.7.2

Use one of the measurement procedures of the peak power and record as P_{Pk} .

Use one of the measurement procedures of the average power and record as P_{Avg} .

Both the peak and average power levels must be expressed in the same logarithmic units (e.g., dBm). Determine the PAPR from:

$$\text{PAPR (dB)} = P_{Pk} \text{ (dBm)} - P_{Avg} \text{ (dBm)}.$$

- Peak Power Measurement

1. Set the RBW \geq OBW
2. Set VBW $\geq 3 \times$ RBW
3. Set span $\geq 2 \times$ RBW
4. Sweep time = auto couple
5. Detector = peak
6. Ensure that the number of measurement points \geq span/RBW.
7. Trace mode = max hold
8. Allow trace to fully stabilize.
9. Use the peak marker function to determine the peak amplitude level.

- Average Power Measurement

1. Set span to at least 1.5 times the OBW.
2. Set RBW = 1-5% of the OBW, not to exceed 1 MHz.
3. Set VBW $\geq 3 \times$ RBW.
4. Set number of points in sweep $\geq 2 \times$ span / RBW.
5. Sweep time = auto-couple.
6. Detector = RMS (power averaging).
7. If the EUT can be configured to transmit continuously (i.e., burst duty cycle $\geq 98\%$), then set the trigger to free run.
8. If the EUT cannot be configured to transmit continuously (i.e., burst duty cycle $< 98\%$), then use a sweep trigger with the level set to enable triggering only on full power bursts and configure the EUT to transmit at full power for the entire duration of each sweep.
Ensure that the sweep time is less than or equal to the transmission burst duration.
9. Trace average at least 100 traces in power averaging (i.e., RMS) mode.
10. Compute the power by integrating the spectrum across the OBW of the signal using the instrument's band power measurement function, with the band limits set equal to the OBW band edges. If the instrument does not have a band power function, then sum the spectrum levels (in linear power units) at intervals equal to the RBW extending across the entire OBW of the spectrum.

3.3 OCCUPIED BANDWIDTH.

Test set-up

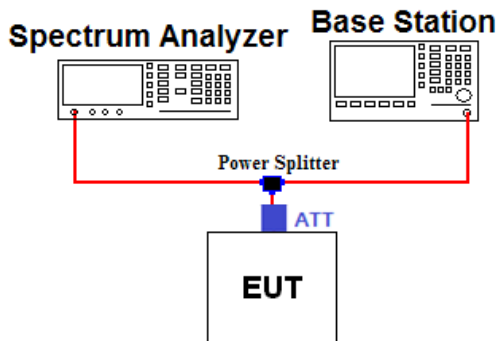

Offset value information

Frequency (MHz)	Offset Value (dB)	Frequency (MHz)	Offset Value (dB)
824.2	19.42	1850.2	19.69
826.4	19.41	1880.0	19.73
836.6	19.44	1909.8	19.76
846.6	19.46	-	-
848.8	19.46	-	-
-	-	-	-

Note. 1: The offset values from EUT to Spectrum analyzer were measured and used for test.

Test Procedure

- KDB971168 D01v02r02 - Section 4.2

The occupied bandwidth, that is the frequency bandwidth such that, below its lower and above its upper frequency limits, the mean powers radiated are each equal to 0.5 percent of the total mean power of a given emission.

Test setting

1. The signal analyzer's automatic bandwidth measurement capability was used to perform the 99 % occupied bandwidth and the 26 dB bandwidth. The bandwidth measurement was not influenced by any intermediate power nulls in the fundamental emission.
2. $RBW = 1 \sim 5 \%$ of the expected OBW & $VBW \geq 3 \times RBW$
3. Detector = Peak
4. Trance mode = Max hold
5. Sweep = Auto couple
6. The trace was allowed to stabilize
7. If necessary, step 2 ~ 6 were repeated after changing the RBW such that it would be within 1 ~ 5 % of the 99 % occupied bandwidth observed in step 6.

3.4 BAND EDGE EMISSIONS AT ANTENNA TERMINAL.

Test set-up

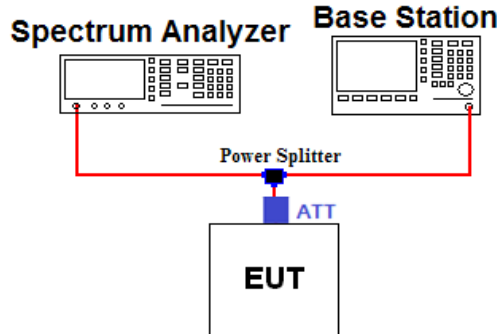

Offset value information

Frequency (MHz)	Offset Value (dB)	Frequency (MHz)	Offset Value (dB)
823.0	19.42	1849.0	19.69
824.0	19.42	1850.0	19.69
849.0	19.46	1910.0	19.76
850.0	19.46	1911.0	19.76
-	-	-	-

Note. 1: The offset value from EUT to Spectrum analyzer was measured and used for test.

Test Procedure

- KDB971168 D01v02r02 - Section 6

All out of band emissions are measured by means of a calibrated spectrum analyzer. The EUT was setup to maximum output power at its lowest and highest channel with all modulations.

The power of any spurious emission shall be attenuated below the transmitter power (P) by at least $43 + 10 \log(P)$ dB, where P is the transmitter power in Watts.

Test setting

1. Start and stop frequency were set such that the band edge would be placed in the center of the plot
2. Span was set large enough so as to capture all out of band emissions near the band edge
3. RBW $\geq 1\%$ of the emission
4. VBW $\geq 3 \times$ RBW
5. Detector = RMS & Trace mode = Max hold
6. Sweep time = Auto couple or 1 s for band edge
7. Number of sweep point $\geq 2 \times$ span / RBW
8. The trace was allowed to stabilize

Note 1: In the 1 MHz bands immediately outside and adjacent to the frequency block a resolution bandwidth of **at least one percent** of the emission bandwidth of the fundamental emission of the transmitter may be employed to demonstrate compliance with the out-of-band emissions limit.

The emission bandwidth is defined as the width of the signal between two points, one below the carrier center frequency and one above the carrier center frequency, outside of which all emission are attenuated at least 26 dB below the transmitter power.

3.5 SPURIOUS AND HARMONIC EMISSIONS AT ANTENNA TERMINAL.

Test set-up

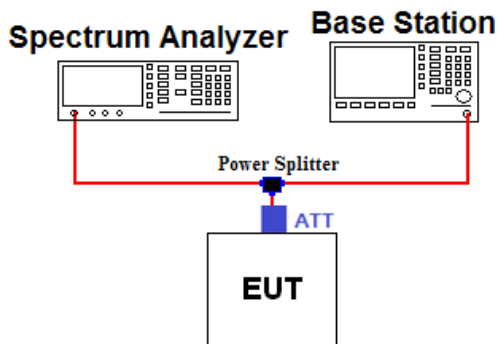

Offset value information

Frequency (MHz)	Offset Value (dB)	Frequency (MHz)	Offset Value (dB)
10000.0	20.97	20000.0	22.64
-	-	-	-

Note. 1: The offset value from EUT to Spectrum analyzer was measured and used for test.

Test Procedure

- KDB971168 D01v02r02 - Section 6

The level of the carrier and the various conducted spurious and harmonic frequencies is measured by means of a calibrated spectrum analyzer. The EUT was setup to maximum output power at its low, middle, high channel with all bandwidths. The spectrum is scanned from 9 kHz up to a frequency including its 10th harmonic.

The power of any spurious emission shall be attenuated below the transmitter power (P) by at least $43 + 10 \log(P)$ dB , where P is the transmitter power in Watts.

Test setting

1. RBW = 100 kHz(Below 1 GHz) or 1 MHz(Above 1 GHz) & VBW ≥ 3 X RBW (Refer to Note 1)
2. Detector = RMS & Trace mode = Max hold
3. Sweep time = Auto couple
4. Number of sweep point ≥ 2 X span / RBW
5. The trace was allowed to stabilize

Note 1: Compliance with these provisions is based on the use of measurement instrumentation employing a resolution bandwidth of 100 kHz or greater for Part 22 and 1 MHz or greater for Part 24, 27

3.6 RADIATED SPURIOUS EMISSIONS

Test Set-up

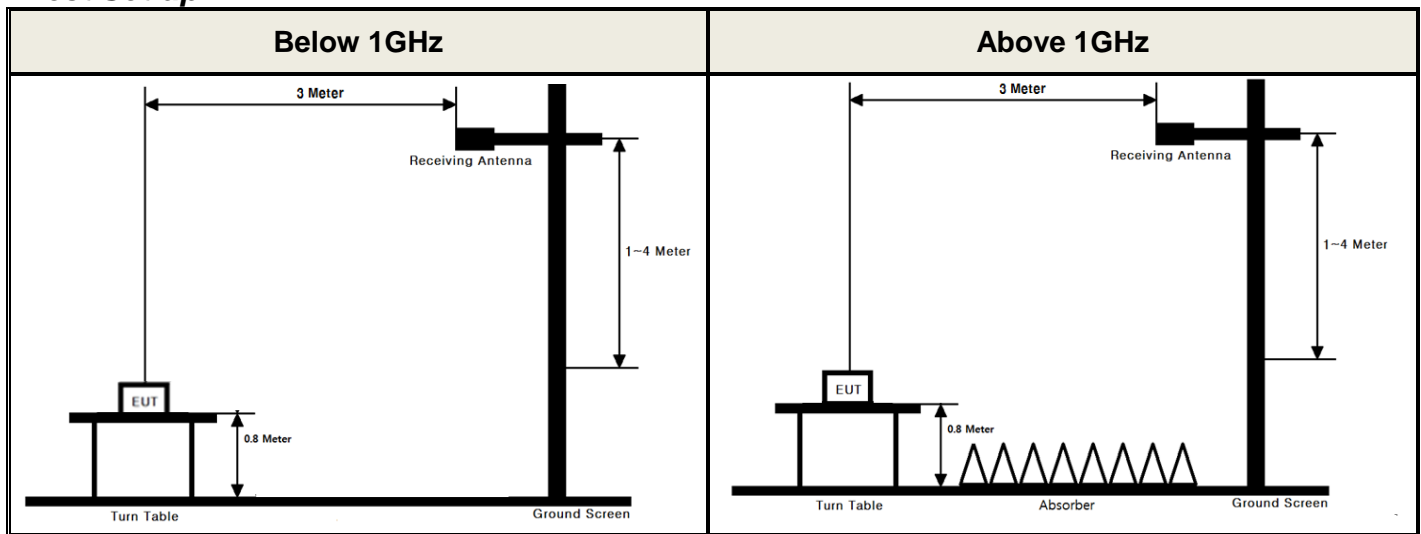

These measurements were performed at 3 m test site. The equipment under test is placed on a non-conductive table 0.8-meters above a turntable which is flush with the ground plane and 3 meters from the receive antenna. For measurements above 1GHz absorbers are placed on the floor between the turn table and the antenna mast in such a way so as to maximize the reduction of reflections. For measurements below 1 GHz, the absorbers are removed.

Test Procedure

- ANSI/TIA-603-E-2016 - Section 2.2.12
- KDB971168 D01v02r02 - Section 5.8

Test setting

1. RBW = 100 kHz for below 1 GHz and 1 MHz for above 1 GHz / VBW \geq 3 X RBW
2. Detector = RMS & Trace mode = Max hold
3. Sweep time = Auto couple
4. Number of sweep point \geq 2 X span / RBW
5. The trace was allowed to stabilize

The receive antenna height and turntable rotations were adjusted for the highest reading on the receive spectrum analyzer.

For radiated spurious emission measurements below 1 GHz, a half-wave dipole was substituted in place of the EUT. This dipole antenna was driven by a signal generator and the level of the signal generator was adjusted to obtain the same spectrum analyzer reading.

For radiated spurious emission measurements above 1 GHz, a Horn antenna was substituted in place of the EUT. This Horn antenna was driven by a signal generator and the level of the signal generator was adjusted to obtain the same spectrum analyzer reading. The difference between the gain of the horn and an isotropic antenna are taken into consideration.

This measurement was performed with the EUT oriented in 3 orthogonal axis.

3.7 FREQUENCY STABILITY / VARIATION OF AMBIENT TEMPERATURE

Test Set-up

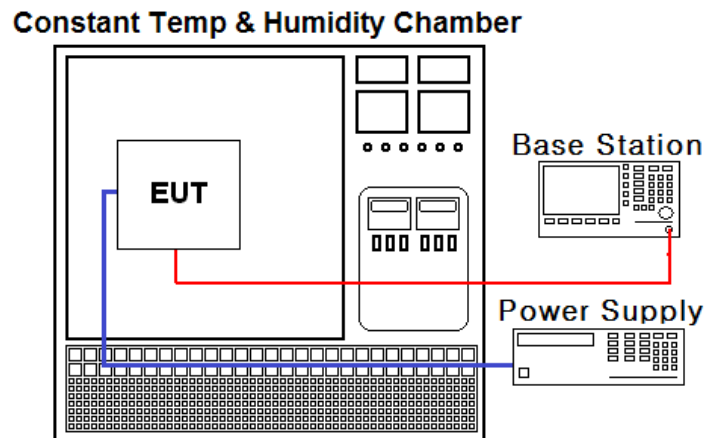

Test Procedure

- ANSI/TIA-603-E-2016
- KDB971168 D01v02r02 - Section 9

The frequency stability of the transmitter is measured by:

- a.) **Temperature:**
The temperature is varied from - 30 °C to + 50 °C in 10 °C increments using an environmental chamber.
- b.) **Primary Supply Voltage:**
The primary supply voltage is varied from 85 % to 115 % of the nominal value for non hand-carried battery and AC powered equipment. For hand-carried, battery-powered equipment, primary supply voltage is reduced to the battery operating end point which shall be specified by the manufacturer.

Specification:

The frequency stability shall be sufficient to ensure that the fundamental emission stays within the authorized frequency block for Part 24,27. The frequency stability of the transmitter shall be maintained within $\pm 0.00025\%$ (± 2.5 ppm) of the center frequency for Part 22.

Time Period and Procedure:

1. The carrier frequency of the transmitter is measured at room temperature.
(20 °C to provide a reference)
2. The equipment is turned on in a "standby" condition for one minute before applying power to the transmitter. Measurement of the carrier frequency of the transmitter is made within one minute after applying power to the transmitter.
3. Frequency measurements are made at 10 °C intervals ranging from -30 °C to +50 °C.
A period of at least one half-hour is provided to allow stabilization of the equipment at each temperature level.

4. LIST OF TEST EQUIPMENT

Type	Manufacturer	Model	Cal.Date (yy/mm/dd)	Next.Cal. Date (yy/mm/dd)	S/N
Spectrum Analyzer	Agilent Technologies	N9020A	17/09/05	18/09/05	MY46471251
Spectrum Analyzer	Agilent Technologies	N9020A	17/09/06	18/09/06	MY48011075
Attenuator(10dB)	SMAJK	SMAJK-50-10	17/09/06	18/09/06	15081901
Attenuator(3dB)	SMAJK	SMAJK-2-3	17/09/06	18/09/06	2
DC Power Supply	Agilent Technologies	66332A	17/09/05	18/09/05	MY43000394
Multimeter	FLUKE	17B	17/04/12	18/04/12	26030065WS
Power Splitter	Anritsu	K241B	17/01/11	18/01/11	016681
Temp & Humi Test Chamber	SJ Science	SJ-TH-S50	17/01/25	18/01/25	SJ-TH-S50-140205
Thermohyrometer	BODYCOM	BJ5478	17/04/11	18/04/11	120612-1
Radio Communication Analyzer	Agilent Technologies	E5515C	17/09/05	18/09/05	GB41321164
Signal Generator	R&S	SMBV100A	17/01/04	18/01/04	255571
Signal Generator	R&S	SMF100A	17/04/21	18/04/21	102341
Loop Antenna	Schwarzbeck	FMZB1513	16/04/22	18/04/22	1513-128
Bilog Antenna	Schwarzbeck	VULB9160	16/11/11	18/11/11	3151
Dipole Antenna	Schwarzbeck	VHA9103	17/03/14	19/03/14	2116
Dipole Antenna	Schwarzbeck	VHA9103	16/04/15	18/04/15	2117
Dipole Antenna	Schwarzbeck	UHA9105	17/03/14	19/03/14	2261
Dipole Antenna	Schwarzbeck	UHA9105	16/04/15	18/04/15	2262
HORN ANT	ETS-LINDGREN	3117	16/02/26	18/02/26	00152145
HORN ANT	ETS-LINDGREN	3117	16/05/03	18/05/03	00140394
HORN ANT	A.H.Systems	SAS-574	17/04/25	19/04/25	154
HORN ANT	A.H.Systems	SAS-574	17/07/17	19/07/17	155
Amplifier	EMPOWER	BBS3Q7ELU	17/09/06	18/09/06	1020
PreAmplifier	tsj	MLA-010K01-B01-27	17/03/06	18/03/06	1844539
Amplifier	Agilent	8449B	17/09/05	18/09/05	3008A02108
High-pass filter	Wainwright	WHKX12-935-1000-15000-40SS	17/09/05	18/09/05	7
High-pass filter	Wainwright	WHKX12-2580-3000-18000-80SS	17/09/05	18/09/05	3
High-pass Filter	Wainwright Instruments	WHNX6-6320-8000-26500-40CC	17/09/05	18/09/05	1

5. SUMMARY OF TEST RESULTS

FCC Part Section(s)	Parameter	Status Note 1
2.1046	Conducted Output Power	C ^{Note2}
22.913(a) 24.232(c)	Effective Radiated Power Equivalent Isotropic Radiated Power	C ^{Note3}
2.1049	Occupied Bandwidth	C
2.1051 22.917(a) 24.238(a)	Band Edge Spurious and Harmonic Emissions at Antenna Terminal	C
24.232(d)	Peak to Average Ratio	C
2.1053 22.917(a) 24.238(a)	Radiated Spurious and Harmonic Emissions	C ^{Note3}
2.1055 22.355 24.235	Frequency Stability	C
<p>Note 1: C=Comply NC=Not Comply NT=Not Tested NA=Not Applicable</p> <p>Note 2: Refer to RF exposure report.</p> <p>Note 3: This device supports wireless charging capability. So per KDB648474 D03v01r04, the radiated test items were performed both normal and charging conditions. For wireless charging condition, the handset is placed on the representative charging pad under normal conditions and in a simulated call configuration. And the worst case data was reported.</p>		

6. EMISSION DESIGNATOR AND SAMPLE CALCULATION

A. Emission Designator

GSM850 Emission Designator

Emission Designator = **246KGXW**

GSM OBW = 246.37 kHz

(Measured at the 99.75 % power bandwidth)

G = Phase Modulation

X = Cases not otherwise covered

W = Combination (Audio/Data)

GSM1900 Emission Designator

Emission Designator = **246KGXW**

GSM OBW = 245.73 kHz

(Measured at the 99.75 % power bandwidth)

G = Phase Modulation

X = Cases not otherwise covered

W = Combination (Audio/Data)

WCDMA850 Emission Designator

Emission Designator = **4M14F9W**

WCDMA OBW = 4.1442MHz

(Measured at the 99.75 % power bandwidth)

F = Frequency Modulation

9 = Composite Digital Information

W = Combination (Audio/Data)

HSUPA850 Emission Designator

Emission Designator = **4M14F9W**

HSUPA OBW = 4.1364 MHz

(Measured at the 99.75 % power bandwidth)

F = Frequency Modulation

9 = Composite Digital Information

W = Combination (Audio/Data)

B. For substitution method

MODE	Channel	Freq.(MHz)	Spectrum Reading Value (dBm)	EUT Axis	Ant Pol (H/V)	Level (dBm) @ Ant Terminal	TX Ant Gain (dBd)	Result	
								(dBm)	(W)
GSM	128	824.2	-5.86	X	H	28.92	1.23	30.15	1.035

ERP or EIRP = Level @ Ant Terminal LEVEL(dBm) + Tx Ant. Gain

- 1) The EUT mounted on a non-conductive turntable is 0.8 meter above test site ground level.
- 2) During the test, the turn table is rotated until the maximum signal is found.
- 3) Record the field strength meter's level.
- 4) Replace the EUT with dipole/Horn antenna that is connected to a calibrated signal generator.
- 5) Increase the signal generator output till the field strength meter's level is equal to the item (3).
- 6) The signal generator output level with substituted antenna gain is the rating of ERP, EIRP or Radiated spurious emission.

7. TEST DATA

7.1 PEAK TO AVERAGE RATIO

- Plots of the EUT's Peak- to- Average Ratio are shown in Clause 8.1

7.2 OCCUPIED BANDWIDTH

Mode	Channel	Frequency(MHz)	Test Result (kHz)
GSM850	128	824.20	244.11
	190	836.60	246.37
	251	848.80	244.48
GSM1900	512	1850.20	245.73
	661	1880.00	245.64
	810	1909.80	242.56
WCDMA850	4132	826.40	4144.20
	4183	836.60	4142.80
	4233	846.60	4141.90
HSUPA850	4132	826.4	4136.40
	4183	836.6	4135.40
	4233	846.6	4126.80

- Plots of the EUT's Occupied Bandwidth are shown in Clause 8.2

7.3 SPURIOUS AND HARMONIC EMISSIONS AT ANTENNA TERMINAL

- Plots of the EUT's Conducted Spurious Emissions are shown in Clause 8.3

7.4 BAND EDGE

- Plots of the EUT's Band Edge are shown in Clause 8.4

7.5 EFFECTIVE RADIATED POWER

- GSM850 data

Mode	CH	Frequency (MHz)	Ant. Pol. (H/V)	LEVEL@ TX ANTENNA TERMINAL (dBm)	Antenna Gain (dBd)	ERP (dBm)	ERP (W)	Note.
GSM850	128	824.2	H	28.92	1.23	30.15	1.035	-
GSM850	190	836.4	H	27.66	1.22	28.88	0.773	-
GSM850	251	848.8	H	27.94	1.21	29.15	0.822	-
GSM850	128	824.2	H	28.36	1.23	29.59	0.910	With WCP

- WCDMA850 data

Mode	CH	Frequency (MHz)	Ant. Pol. (H/V)	LEVEL@ TX ANTENNA TERMINAL (dBm)	Antenna Gain (dBd)	ERP (dBm)	ERP (W)	Note.
WCDMA850	4132	826.4	V	20.58	1.23	21.81	0.152	-
WCDMA850	4183	836.6	V	20.66	1.22	21.88	0.154	-
WCDMA850	4233	846.6	V	20.44	1.21	21.65	0.146	-
WCDMA850	4183	836.6	H	20.12	1.22	21.34	0.136	With WCP

- HSUPA850 data

Mode	CH	Frequency (MHz)	Ant. Pol. (H/V)	LEVEL@ TX ANTENNA TERMINAL (dBm)	Antenna Gain (dBd)	ERP (dBm)	ERP (W)	Note.
HSUPA850	4132	826.4	V	19.47	1.23	20.70	0.117	-
HSUPA850	4183	836.6	V	19.70	1.22	20.92	0.124	-
HSUPA850	4233	846.6	V	19.84	1.21	21.05	0.127	-
HSUPA850	4233	846.6	H	19.26	1.21	20.47	0.111	With WCP

NOTES:

This EUT was tested under all configurations and the highest power is reported in GSM mode and WCDMA mode with HSDPA inactive at 12.2 kbps RMC and TPC bits set to "1" and in GSM mode using a Power Control Level of "0" in PCS Band and "5" in the Cellular Band. This EUT was tested with the fully charged battery. Also, we have done x, y, z planes in EUT and horizontal and vertical polarization of detecting antenna.

The worst case data is reported.

7.6 EQUIVALENT ISOTROPIC RADIATED POWER

- GSM1900 data

Mode	CH	Frequency (MHz)	Ant. Pol. (H/V)	LEVEL @ TX ANTENNA TERMINAL (dBm)	Antenna Gain (dBi)	EIRP (dBm)	EIRP (W)	Note.
GSM1900	512	1850.2	H	22.70	5.07	27.77	0.598	-
GSM1900	661	1880.0	H	21.77	4.92	26.69	0.467	-
GSM1900	810	1909.8	H	22.17	4.76	26.93	0.493	-
GSM1900	512	1850.2	H	22.38	5.07	27.45	0.556	With WCP

NOTES:

This EUT was tested under all configurations and the highest power is reported in GSM mode and WCDMA mode with HSDPA inactive at 12.2 kbps RMC and TPC bits set to "1" and in GSM mode using a Power Control Level of "0" in PCS Band and "5" in the Cellular Band. This EUT was tested with the fully charged battery. Also, we have done x, y, z planes in EUT and horizontal and vertical polarization of detecting antenna.

The worst case data is reported.

7.7 RADIATED SPURIOUS EMISSIONS

- GSM850 data

Channel (ERP)	Tx Freq. (MHz)	Freq. (MHz)	POL (H/V)	LEVEL@ ANTENNA TERMINAL (dBm)	Substitute Antenna Gain (dBd)	Correct Generator Level (dBm)	Result (dBc)	Limit (dBc)
128 (1.035 W)	824.2	1648.57	V	-53.59	3.77	-49.82	79.97	43.15
		2472.76	H	-44.38	4.05	-40.33	70.48	
		-	-	-	-	-	-	
190 (0.773 W)	836.6	1673.03	V	-47.73	3.78	-43.95	72.83	41.88
		2509.64	H	-42.55	4.04	-38.51	67.39	
		-	-	-	-	-	-	
251 (0.822 W)	848.8	1697.37	V	-48.70	3.79	-44.91	74.06	42.15
		2546.39	H	-43.02	4.06	-38.96	68.11	
		-	-	-	-	-	-	

- Limit Calculation= $43 + 10 \log_{10}(\text{ERP [W]})$ [dBc]

- No other spurious and harmonic emissions were reported greater than listed emissions above table.

- GSM850 data (With WCP)

Channel (ERP)	Tx Freq. (MHz)	Freq. (MHz)	POL (H/V)	LEVEL@ ANTENNA TERMINAL (dBm)	Substitute Antenna Gain (dBd)	Correct Generator Level (dBm)	Result (dBc)	Limit (dBc)
128 (0.910 W)	824.2	1648.20	H	-53.50	3.77	-49.73	79.32	42.59
		2472.49	H	-46.92	4.05	-42.87	72.46	

- Limit Calculation= $43 + 10 \log_{10}(\text{ERP [W]})$ [dBc]

- No other spurious and harmonic emissions were reported greater than listed emissions above table.

NOTES:

This EUT was tested under all configurations and the highest power is reported in GSM mode and WCDMA mode with HSDPA inactive at 12.2 kbps RMC and TPC bits set to "1" and in GSM mode using a Power Control Level of "0" in PCS Band and "5" in the Cellular Band. This EUT was tested with the fully charged battery. Also, we have done x, y, z planes in EUT and horizontal and vertical polarization of detecting antenna.

The worst case data is reported.

- WCDMA850 data

Channel (ERP)	Tx Freq. (MHz)	Freq. (MHz)	POL (H/V)	LEVEL@ ANTENNA TERMINAL (dBm)	Substitute Antenna Gain (dBd)	Correct Generator Level (dBm)	Result (dBc)	Limit (dBc)
4132 (0.152 W)	826.4	1652.05	V	-58.96	3.78	-55.18	76.99	34.81
		-	-	-	-	-	-	
		-	-	-	-	-	-	
4183 (0.154 W)	836.6	1672.16	V	-59.03	3.78	-55.25	77.13	34.88
		-	-	-	-	-	-	
		-	-	-	-	-	-	
4233 (0.146 W)	846.6	1693.92	V	-59.97	3.79	-56.18	77.83	34.65
		-	-	-	-	-	-	
		-	-	-	-	-	-	

- Limit Calculation= $43 + 10 \log_{10}(ERP [W])$ [dBc]

- No other spurious and harmonic emissions were reported greater than listed emissions above table.

- WCDMA850 data (With WCP)

Channel (ERP)	Tx Freq. (MHz)	Freq. (MHz)	POL (H/V)	LEVEL@ ANTENNA TERMINAL (dBm)	Substitute Antenna Gain (dBd)	Correct Generator Level (dBm)	Result (dBc)	Limit (dBc)
4183 (0.136 W)	836.6	1672.20	V	-59.30	3.78	-55.52	76.86	34.34
		-	-	-	-	-	-	
		-	-	-	-	-	-	

- Limit Calculation= $43 + 10 \log_{10}(ERP [W])$ [dBc]

- No other spurious and harmonic emissions were reported greater than listed emissions above table.

NOTES:

This EUT was tested under all configurations and the highest power is reported in GSM mode and WCDMA mode with HSDPA inactive at 12.2 kbps RMC and TPC bits set to "1" and in GSM mode using a Power Control Level of "0" in PCS Band and "5" in the Cellular Band. This EUT was tested with the fully charged battery. Also, we have done x, y, z planes in EUT and horizontal and vertical polarization of detecting antenna.

The worst case data is reported.

- HSUPA850 data

Channel (ERP)	Tx Freq. (MHz)	Freq. (MHz)	POL (H/V)	LEVEL@ ANTENNA TERMINAL (dBm)	Substitute Antenna Gain (dBd)	Correct Generator Level (dBm)	Result (dBc)	Limit (dBc)
4132 (0.117 W)	826.4	1652.11	V	-58.74	3.78	-54.96	75.66	33.70
		-	-	-	-	-	-	
		-	-	-	-	-	-	
4183 (0.124 W)	836.6	1674.65	V	-59.47	3.78	-55.69	76.61	33.92
		-	-	-	-	-	-	
		-	-	-	-	-	-	
4233 (0.127 W)	846.6	1691.98	V	-59.49	3.79	-55.70	76.75	34.05
		-	-	-	-	-	-	
		-	-	-	-	-	-	

- Limit Calculation= $43 + 10 \log_{10}(\text{ERP [W]})$ [dBc]

- No other spurious and harmonic emissions were reported greater than listed emissions above table.

- HSUPA850 data (With WCP)

Channel (ERP)	Tx Freq. (MHz)	Freq. (MHz)	POL (H/V)	LEVEL@ ANTENNA TERMINAL (dBm)	Substitute Antenna Gain (dBd)	Correct Generator Level (dBm)	Result (dBc)	Limit (dBc)
4233 (0.111 W)	846.6	1692.43	V	-59.58	3.79	-55.79	76.26	33.47
		-	-	-	-	-	-	
		-	-	-	-	-	-	

- Limit Calculation= $43 + 10 \log_{10}(\text{ERP [W]})$ [dBc]

- No other spurious and harmonic emissions were reported greater than listed emissions above table.

NOTES:

This EUT was tested under all configurations and the highest power is reported in GSM mode and WCDMA mode with HSDPA inactive at 12.2 kbps RMC and TPC bits set to "1" and in GSM mode using a Power Control Level of "0" in PCS Band and "5" in the Cellular Band. This EUT was tested with the fully charged battery. Also, we have done x, y, z planes in EUT and horizontal and vertical polarization of detecting antenna.

The worst case data is reported.

- GSM1900 data

Channel (EIRP)	Tx Freq. (MHz)	Freq. (MHz)	POL (H/V)	LEVEL@ ANTENNA TERMINAL (dBm)	Substitute Antenna Gain (dBi)	Correct Generator Level (dBm)	Result (dBc)	Limit (dBc)
512 (0.598 W)	1850.2	3700.24	H	-56.37	8.49	-47.88	75.65	40.77
		5550.26	H	-55.39	10.67	-44.72	72.49	
		-	-	-	-	-	-	
661 (0.467 W)	1880.0	3760.19	H	-57.78	8.51	-49.27	75.96	39.69
		5640.20	H	-56.00	10.75	-45.25	71.94	
		-	-	-	-	-	-	
810 (0.493 W)	1909.8	3819.54	H	-57.26	8.55	-48.71	75.64	39.93
		5729.68	H	-56.02	10.89	-45.13	72.06	
		-	-	-	-	-	-	

- Limit Calculation= $43 + 10 \log_{10}(\text{EIRP [W]})$ [dBc]

- No other spurious and harmonic emissions were reported greater than listed emissions above table.

- GSM1900 data (With WCP)

Channel (EIRP)	Tx Freq. (MHz)	Freq. (MHz)	POL (H/V)	LEVEL@ ANTENNA TERMINAL (dBm)	Substitute Antenna Gain (dBi)	Correct Generator Level (dBm)	Result (dBc)	Limit (dBc)
512 (0.556 W)	1850.2	3700.30	H	-56.89	8.49	-48.40	75.85	40.45
		5550.17	H	-54.76	10.67	-44.09	71.54	
		-	-	-	-	-	-	

- Limit Calculation= $43 + 10 \log_{10}(\text{EIRP [W]})$ [dBc]

- No other spurious and harmonic emissions were reported greater than listed emissions above table.

NOTES:

This EUT was tested under all configurations and the highest power is reported in GSM mode and WCDMA mode with HSDPA inactive at 12.2 kbps RMC and TPC bits set to "1" and in GSM mode using a Power Control Level of "0" in PCS Band and "5" in the Cellular Band. This EUT was tested with the fully charged battery. Also, we have done x, y, z planes in EUT and horizontal and vertical polarization of detecting antenna. The worst case data is reported.

7.8 FREQUENCY STABILITY / VARIATION OF AMBIENT TEMPERATURE

7.8.1 FREQUENCY STABILITY (GSM850)

OPERATING FREQUENCY : 836,600,000 Hz
 CHANNEL : 190(Mid)
 REFERENCE VOLTAGE : 3.80 V DC
 DEVIATION LIMIT : $\pm 0.00025\%$ or 2.5 ppm

VOLTAGE (%)	POWER (V DC)	TEMP (°C)	FREQ (Hz)	Deviation	
				(ppm)	(%)
100%	3.80	+20(Ref)	836,599,995	-0.006	-0.00000060
100%		-30	836,600,003	0.004	0.00000036
100%		-20	836,599,996	-0.005	-0.00000048
100%		-10	836,599,992	-0.010	-0.00000096
100%		0	836,599,990	-0.012	-0.00000120
100%		+10	836,599,992	-0.010	-0.00000096
100%		+20	836,599,995	-0.006	-0.00000060
100%		+30	836,599,993	-0.008	-0.00000084
100%		+40	836,599,994	-0.007	-0.00000072
100%		+50	836,599,996	-0.005	-0.00000048
115%	4.37	+20	836,600,002	0.002	0.00000024
BATT.ENDPOINT	3.20	+20	836,599,991	-0.011	-0.00000108

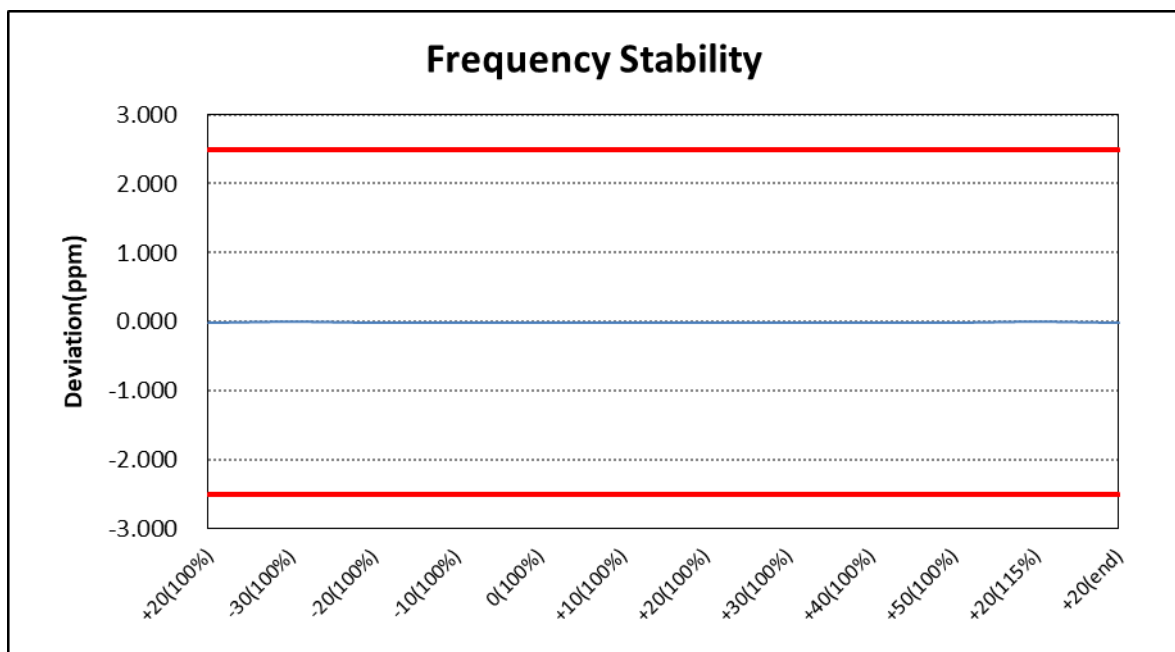

7.8.2 FREQUENCY STABILITY (WCDMA850)

OPERATING FREQUENCY : 836,600,000 Hz
 CHANNEL : 4183(Mid)
 REFERENCE VOLTAGE : 3.80 V DC
 DEVIATION LIMIT : $\pm 0.00025\%$ or ± 2.5 ppm

VOLTAGE (%)	POWER (V DC)	TEMP (°C)	FREQ (Hz)	Deviation	
				(ppm)	(%)
100%	3.80	+20(Ref)	836,600,003	0.004	0.00000036
100%		-30	836,600,003	0.004	0.00000036
100%		-20	836,600,006	0.007	0.00000072
100%		-10	836,600,004	0.005	0.00000048
100%		0	836,599,993	-0.008	-0.00000084
100%		+10	836,600,002	0.002	0.00000024
100%		+20	836,600,003	0.004	0.00000036
100%		+30	836,599,995	-0.006	-0.00000060
100%		+40	836,600,008	0.010	0.00000096
100%		+50	836,600,002	0.002	0.00000024
115%		4.37	+20	836,600,006	0.007
BATT.ENDPOINT	3.20	+20	836,600,007	0.008	0.00000084

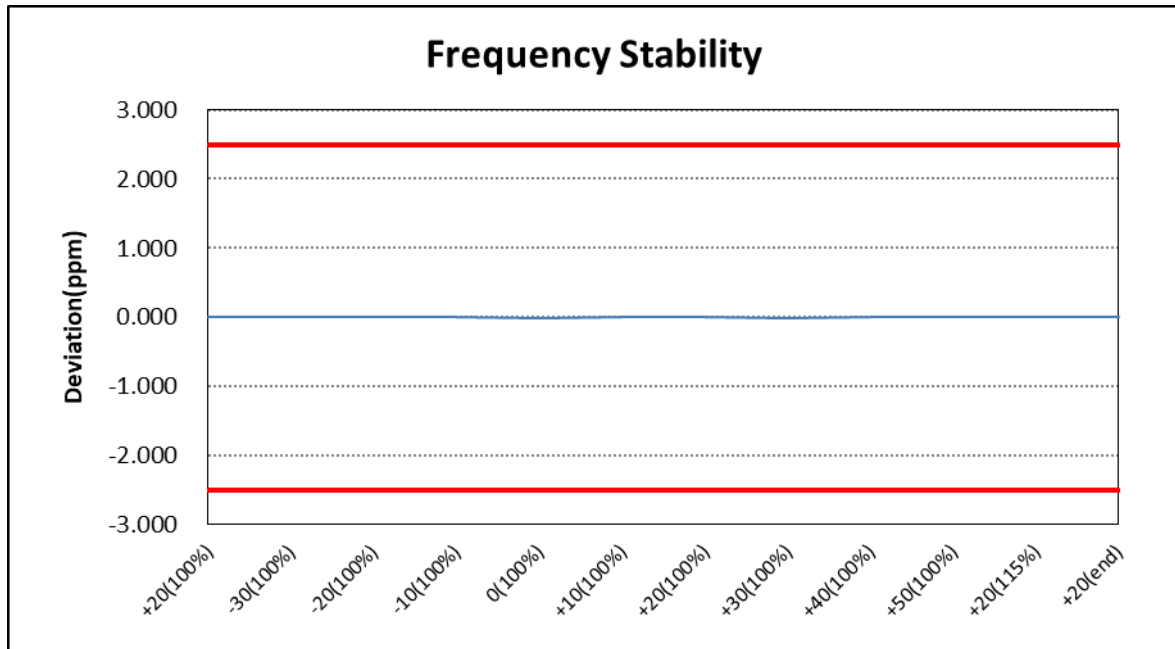

7.8.3 FREQUENCY STABILITY (GSM1900)

OPERATING FREQUENCY : 1,880,000,000 Hz
 CHANNEL : 661(Mid)
 REFERENCE VOLTAGE : 3.80 V DC
 LIMIT : The frequency stability shall be sufficient to ensure that the fundamental emission stays within the authorized frequency block.

VOLTAGE (%)	POWER (V DC)	TEMP (°C)	FREQ (Hz)	Deviation	
				(ppm)	(%)
100%	3.80	+20(Ref)	1,880,000,013	0.007	0.00000069
100%		-30	1,879,999,992	-0.004	-0.00000043
100%		-20	1,880,000,011	0.006	0.00000059
100%		-10	1,879,999,997	-0.002	-0.00000016
100%		0	1,880,000,006	0.003	0.00000032
100%		+10	1,880,000,014	0.007	0.00000074
100%		+20	1,880,000,013	0.007	0.00000069
100%		+30	1,880,000,008	0.004	0.00000043
100%		+40	1,880,000,007	0.004	0.00000037
100%		+50	1,880,000,006	0.003	0.00000032
115%	4.37	+20	1,879,999,995	-0.003	-0.00000027
BATT.ENDPOINT	3.20	+20	1,880,000,011	0.006	0.00000059

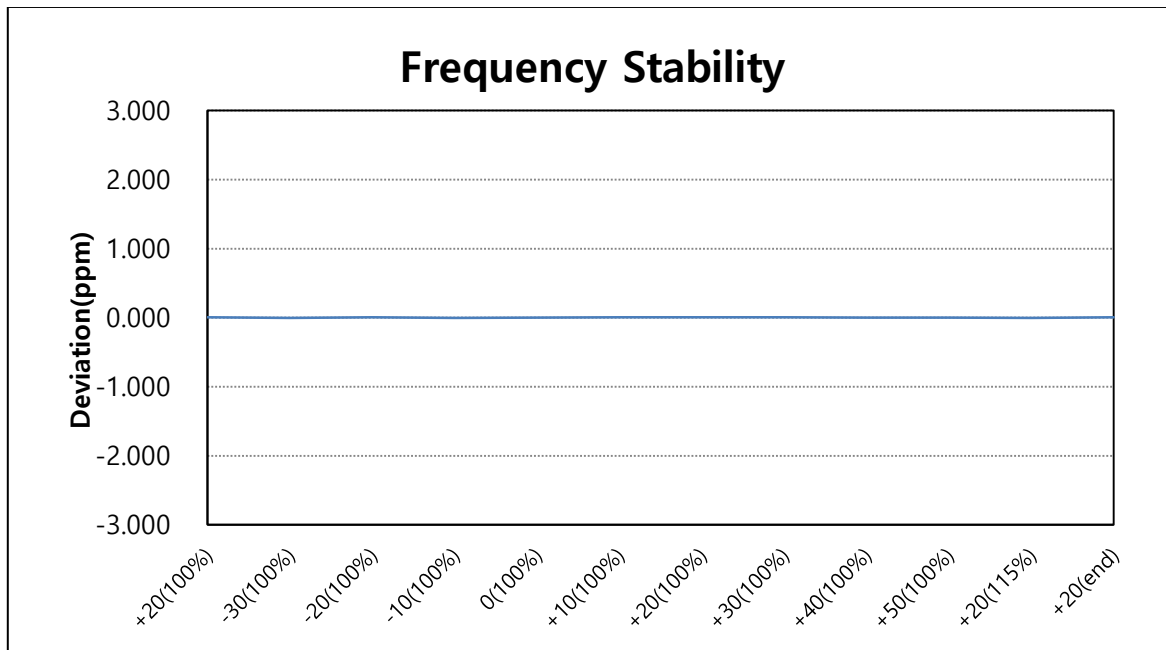

Note. Based on the results of the frequency stability test at the center channel the frequency deviation results measured are very small. as such it is determined that the channels at the band edge would remain inband when the maximum measured frequency deviation noted during the frequency stability tests is applied. therefore the device is determined to remain operating in band over the temperature and voltage range as tested.

8. TEST PLOTS

8.1 Peak to Average Ratio

-P_{Pk} (dBm) GSM1900 & Channel: 661

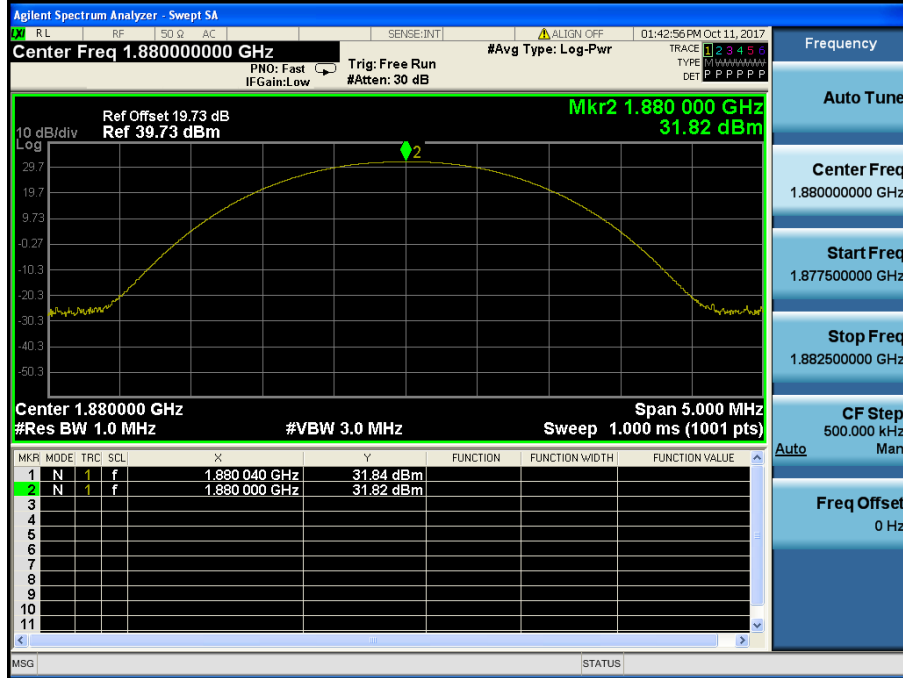

-P_{Avg} (dBm) GSM1900 & Channel: 661

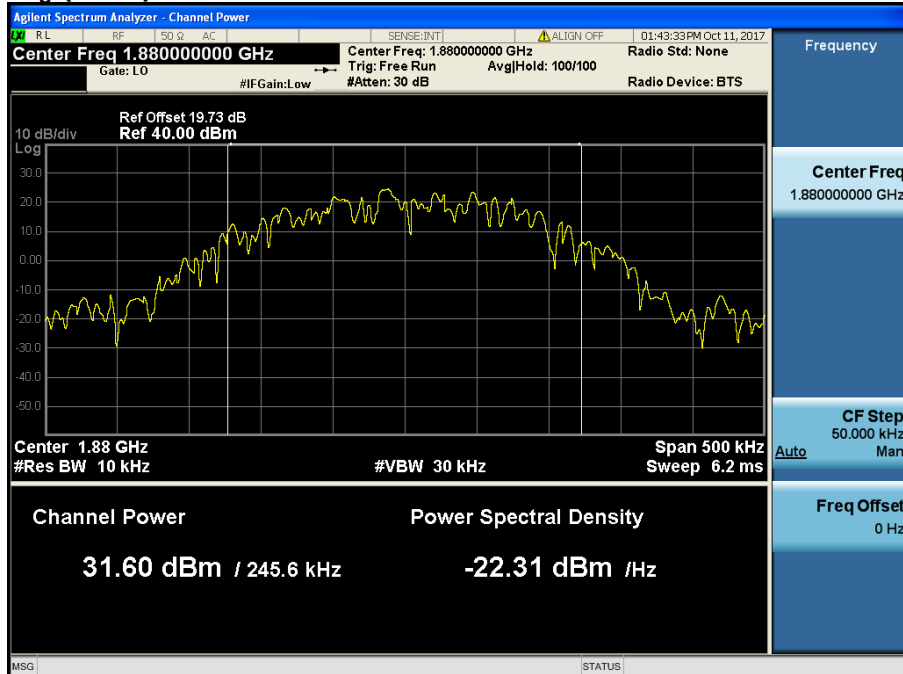

$$\text{PAPR (dB)} = P_{Pk} \text{ (dBm)} - P_{Avg} \text{ (dBm)} = 31.82 \text{ dBm} - 31.60 \text{ dBm} = 0.22 \text{ dB}$$

8.2 Occupied Bandwidth (99 % Bandwidth)

GSM850 & Channel: 128

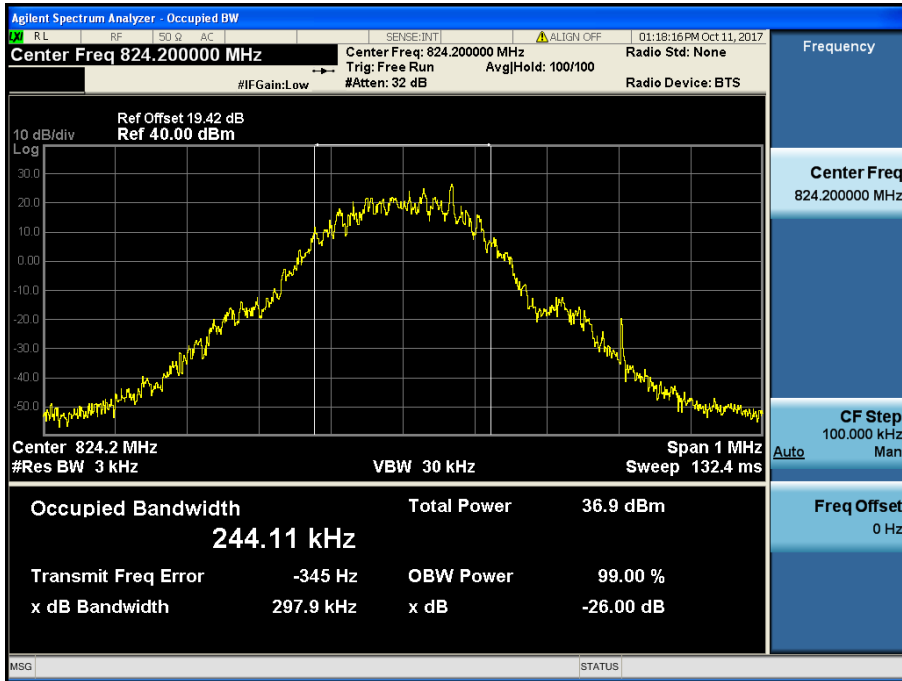

GSM850 & Channel: 190

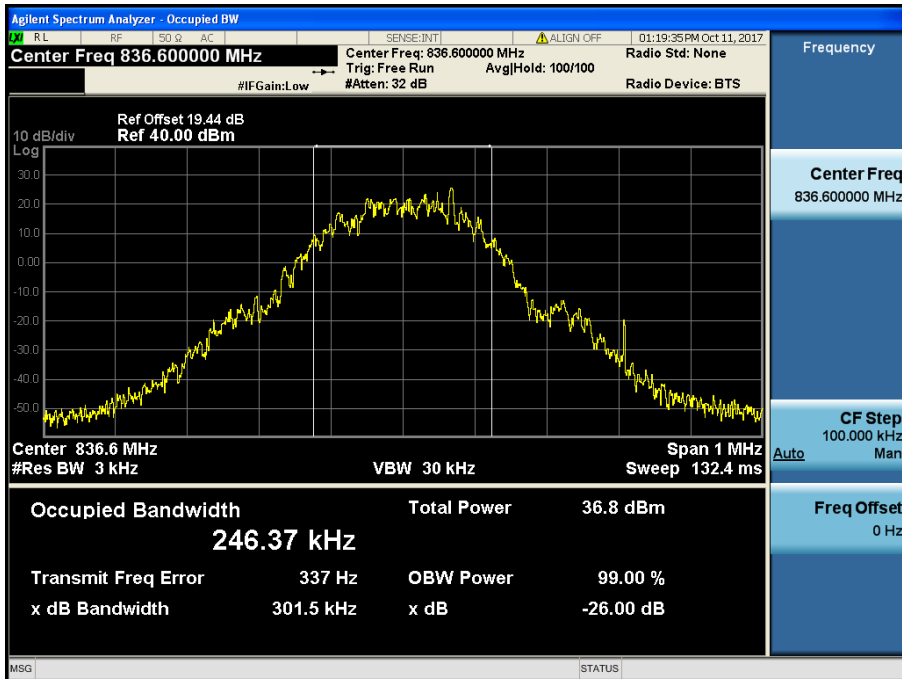

GSM850 & Channel: 251

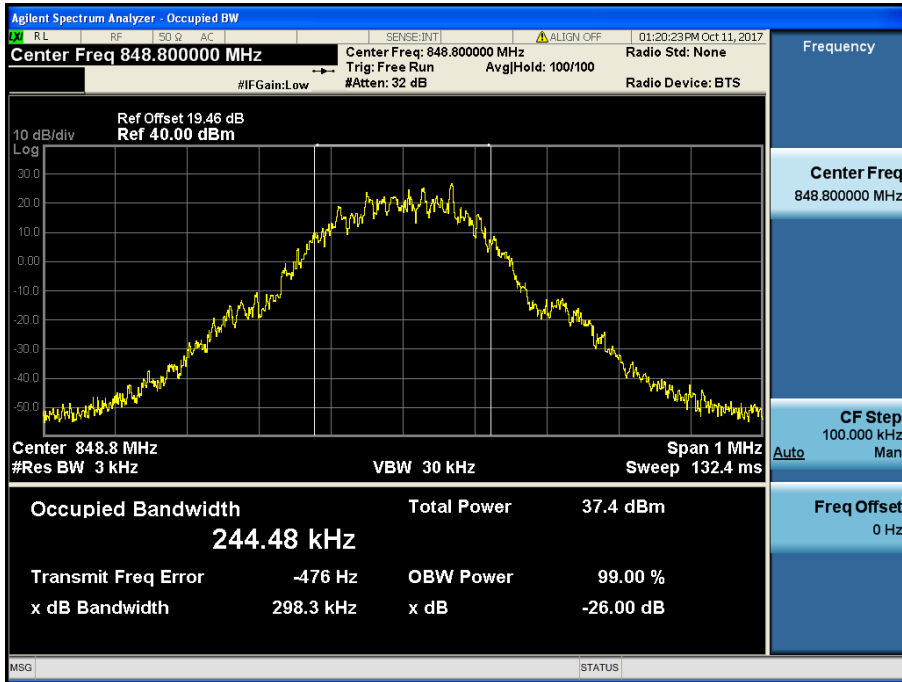

GSM1900 & Channel: 512

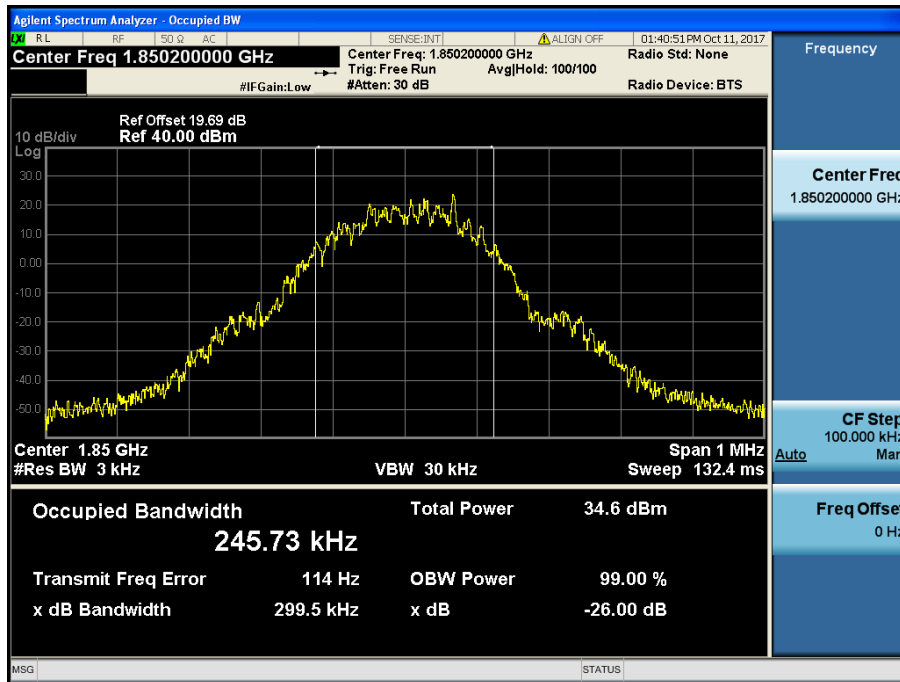

GSM1900 & Channel: 661

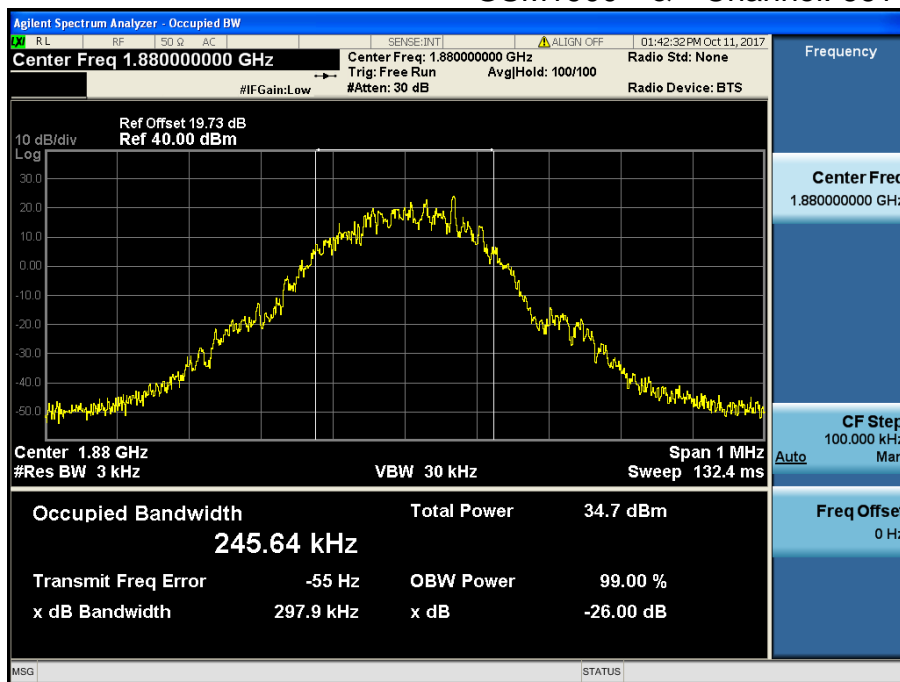

GSM1900 & Channel: 810

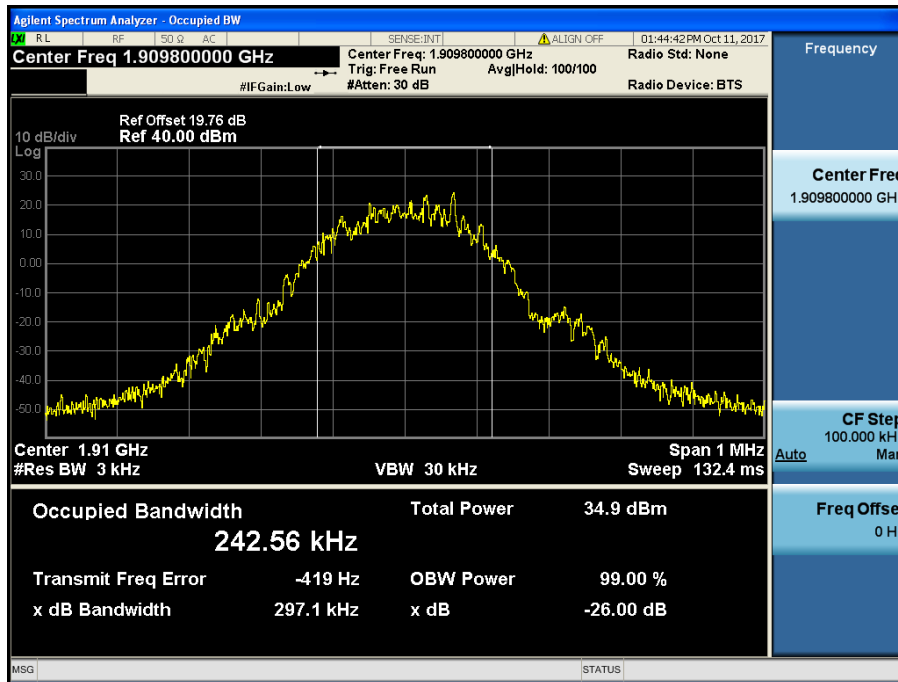

WCDMA850 & Channel: 4132

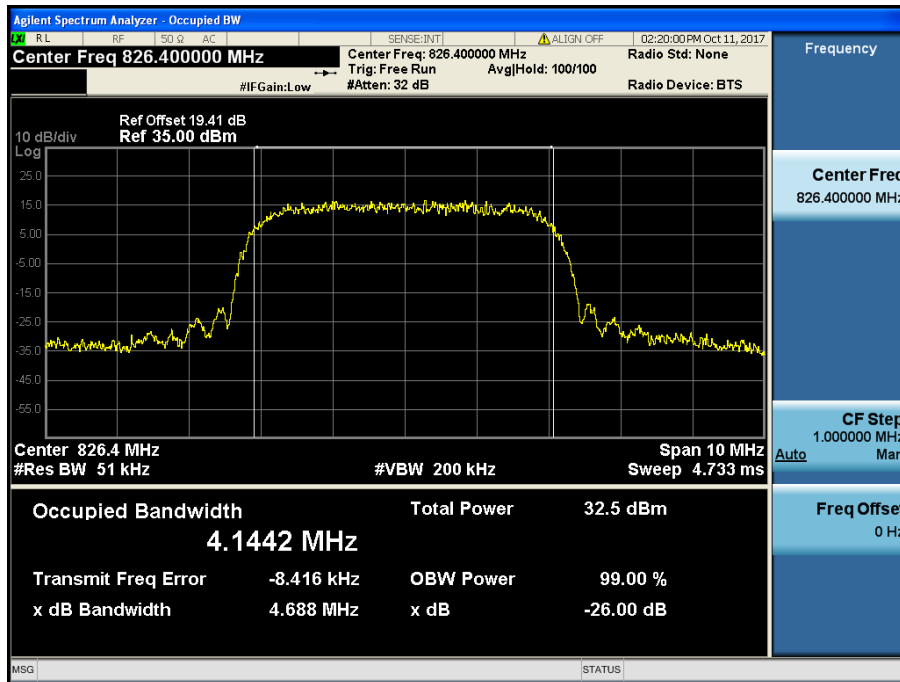

WCDMA850 & Channel: 4183

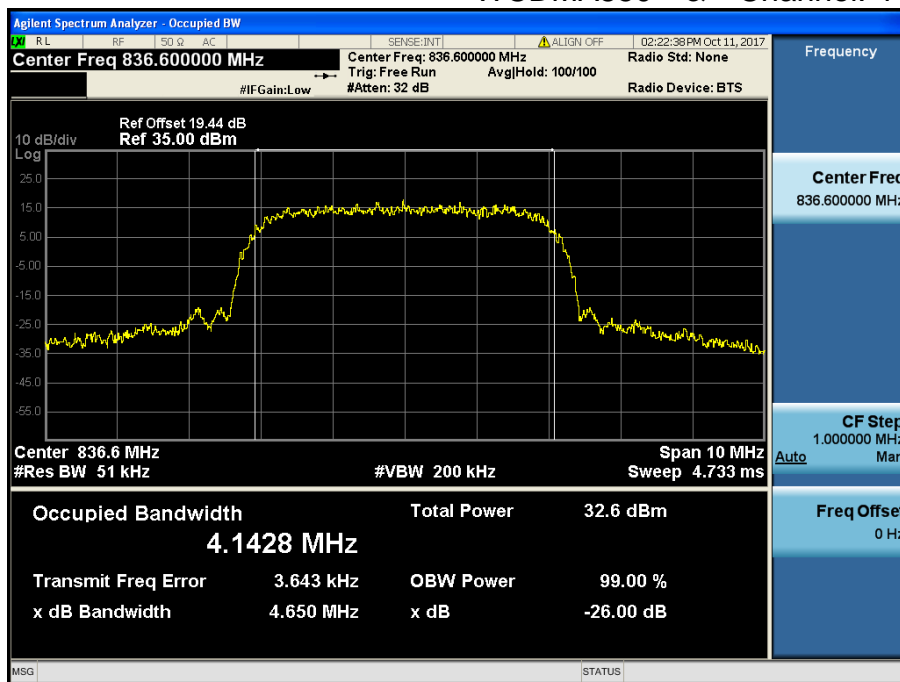

WCDMA850 & Channel: 4233

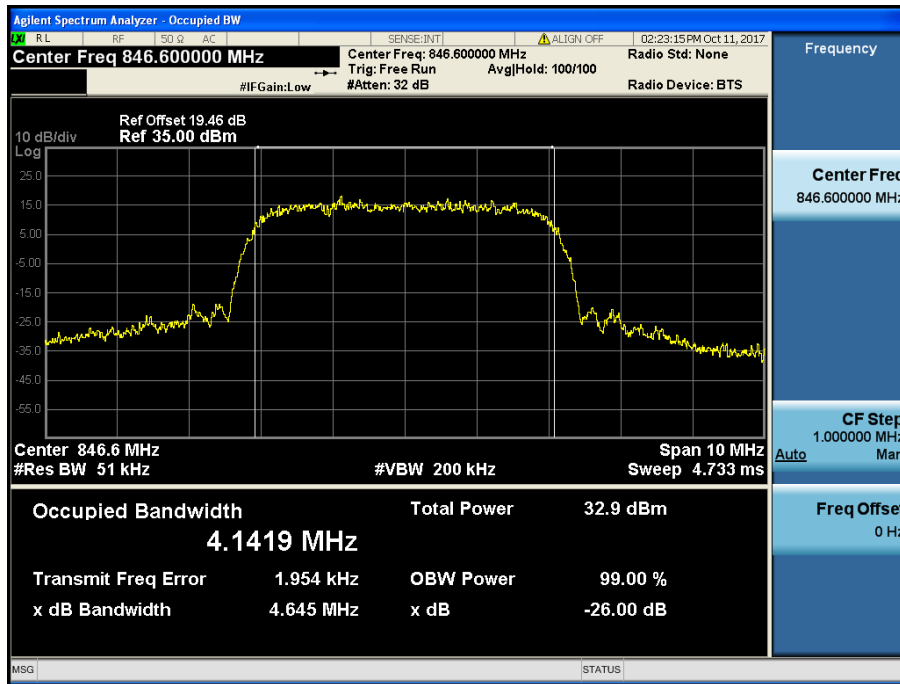

HSUPA850 & Channel: 4132

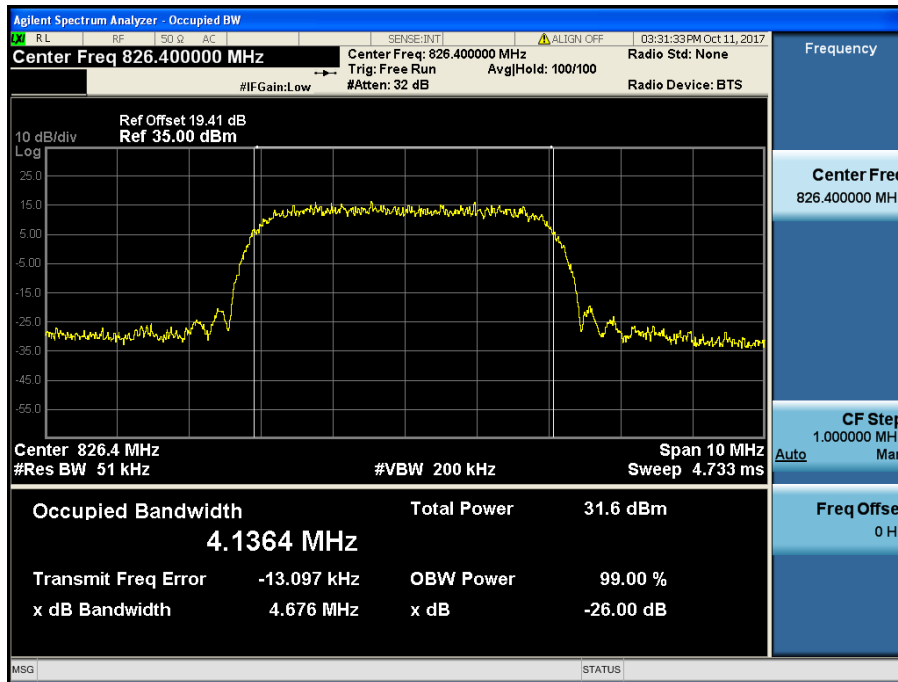

HSUPA850 & Channel: 4183

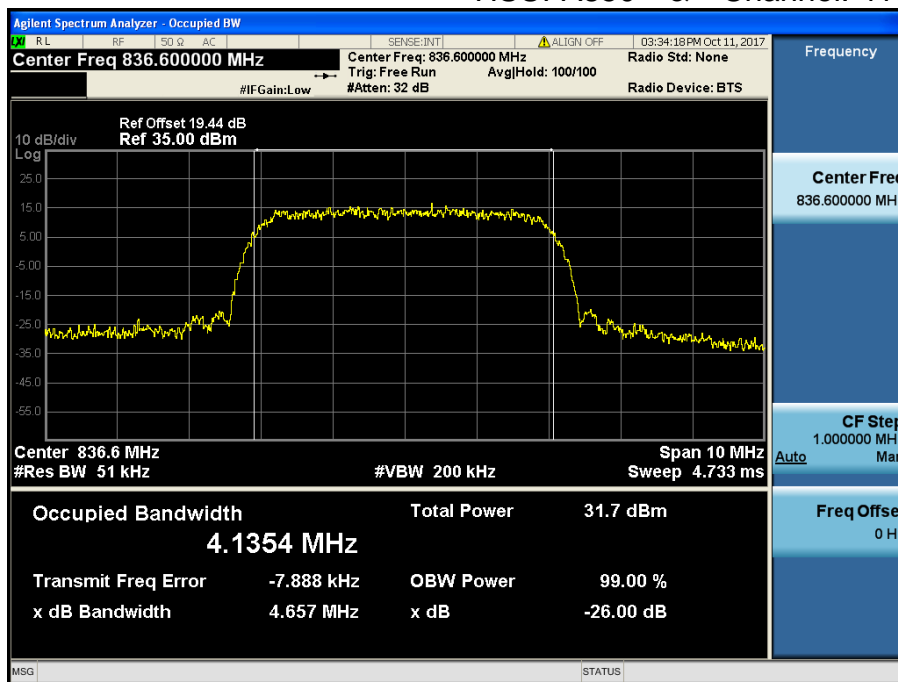

HSUPA850 & Channel: 4233

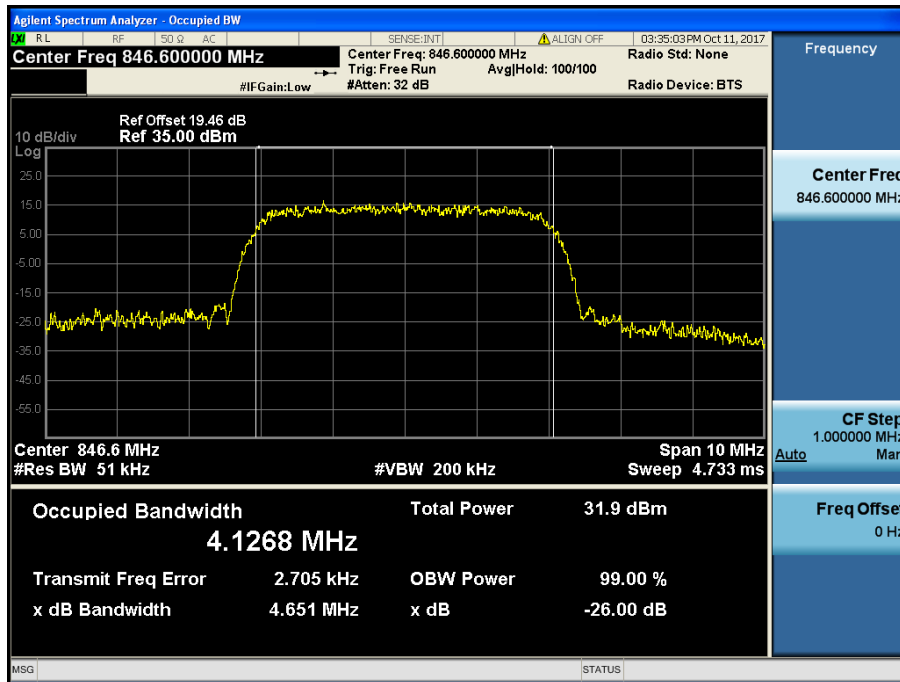

8.3 Spurious Emissions at Antenna Terminal

GSM850 & Channel: 128

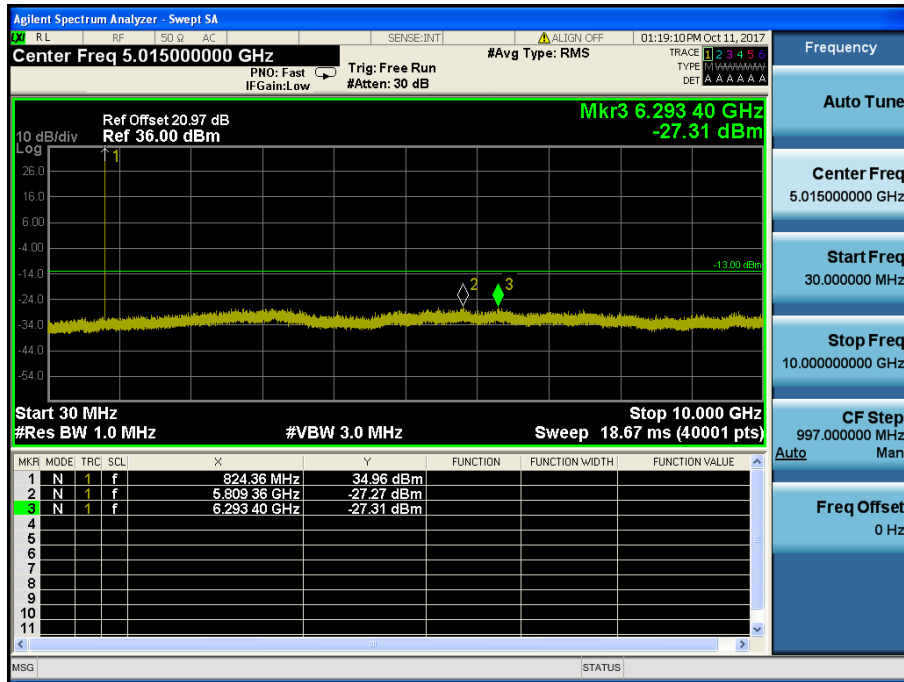

GSM850 & Channel: 190

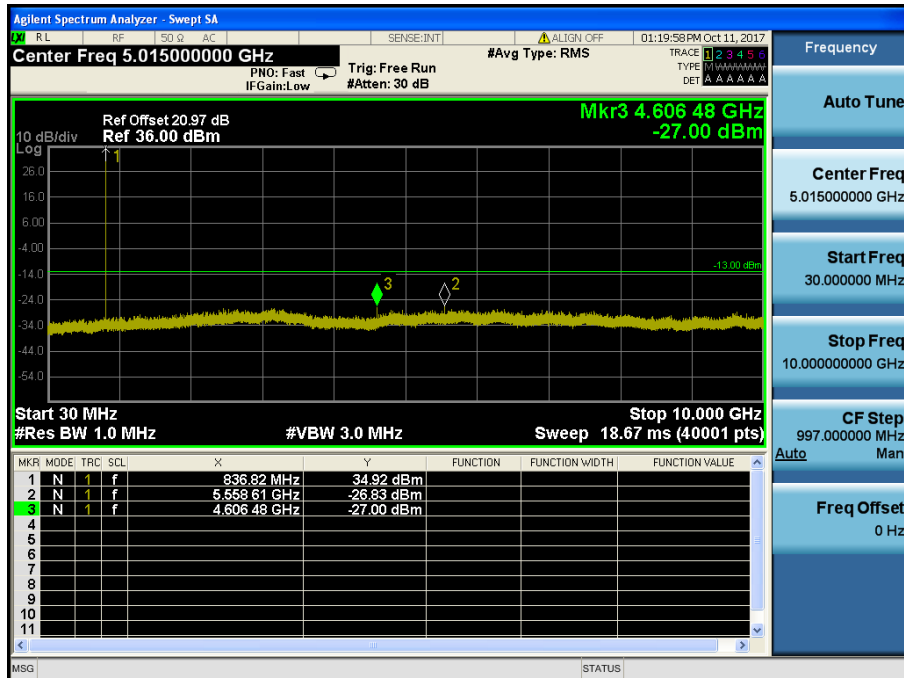

GSM850 & Channel: 251

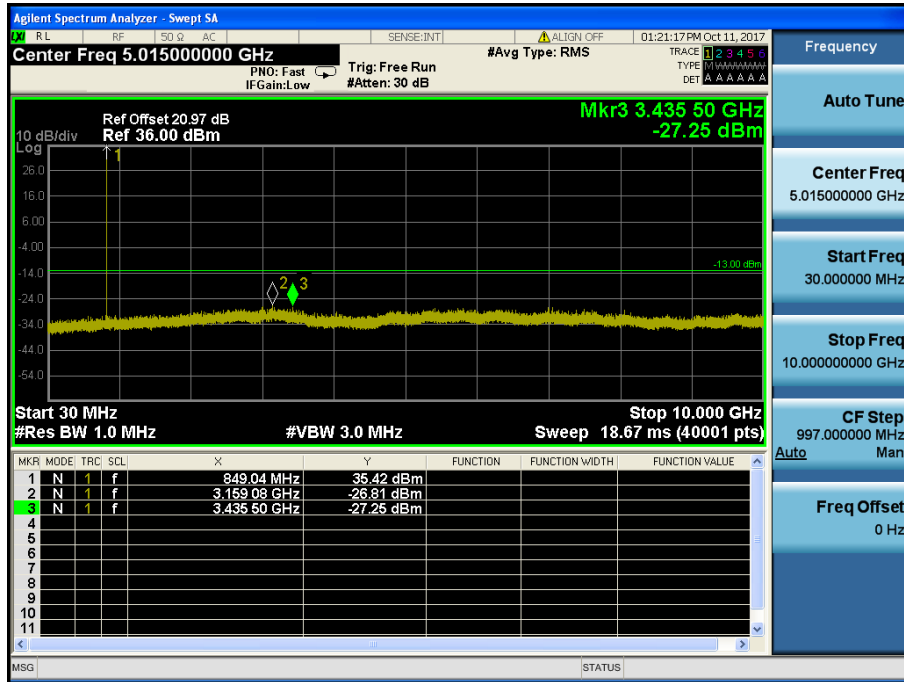

GSM1900 & Channel: 512

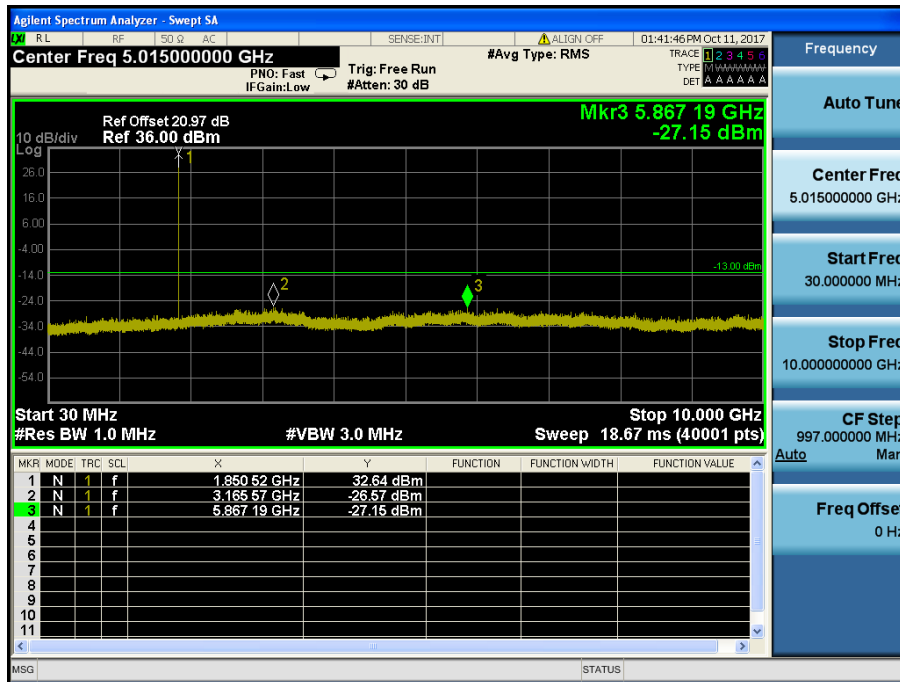

GSM1900 & Channel: 512

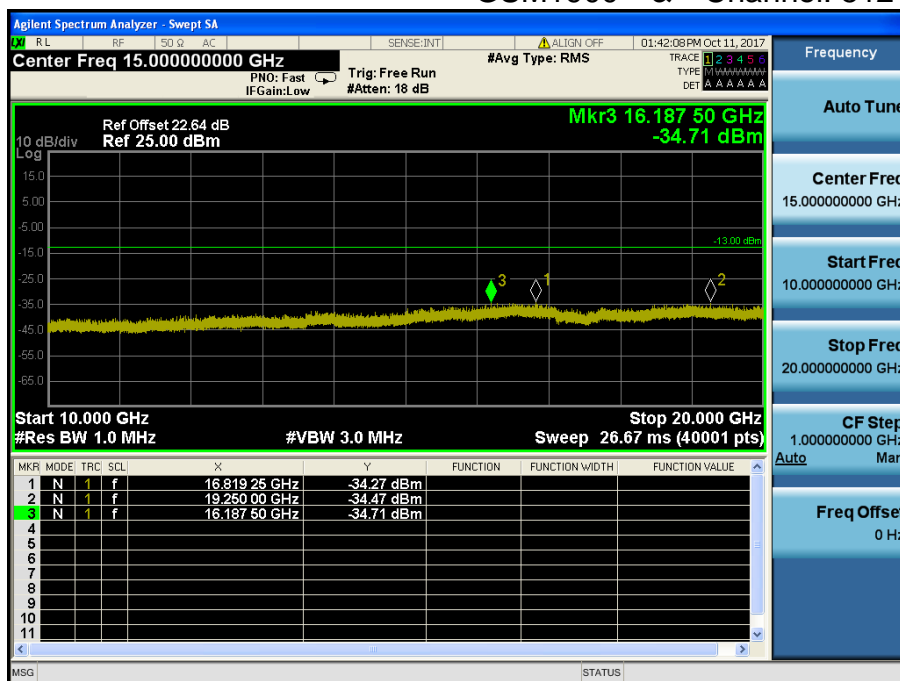

GSM1900 & Channel: 661

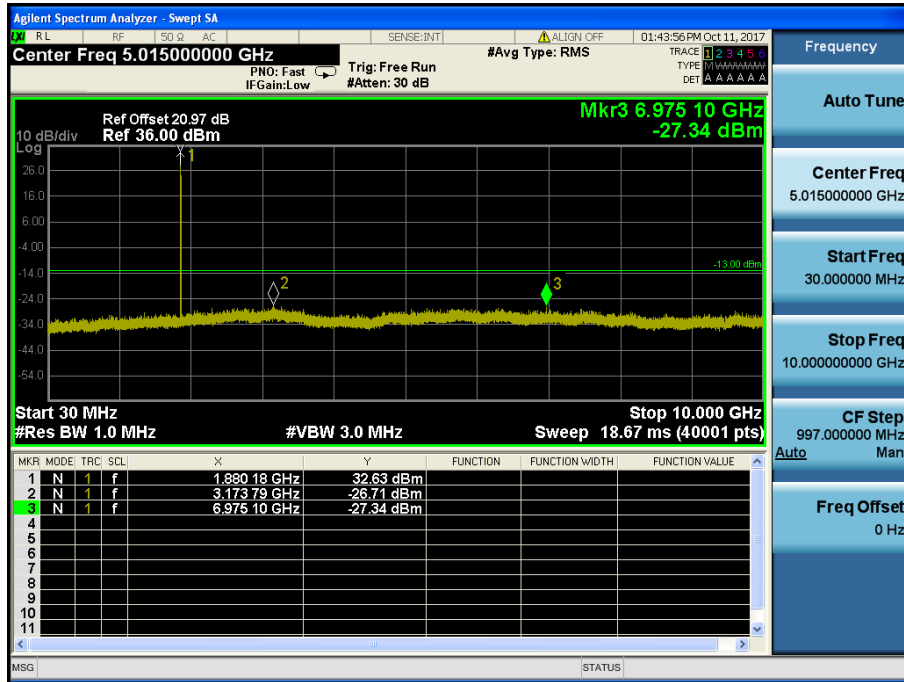

GSM1900 & Channel: 661

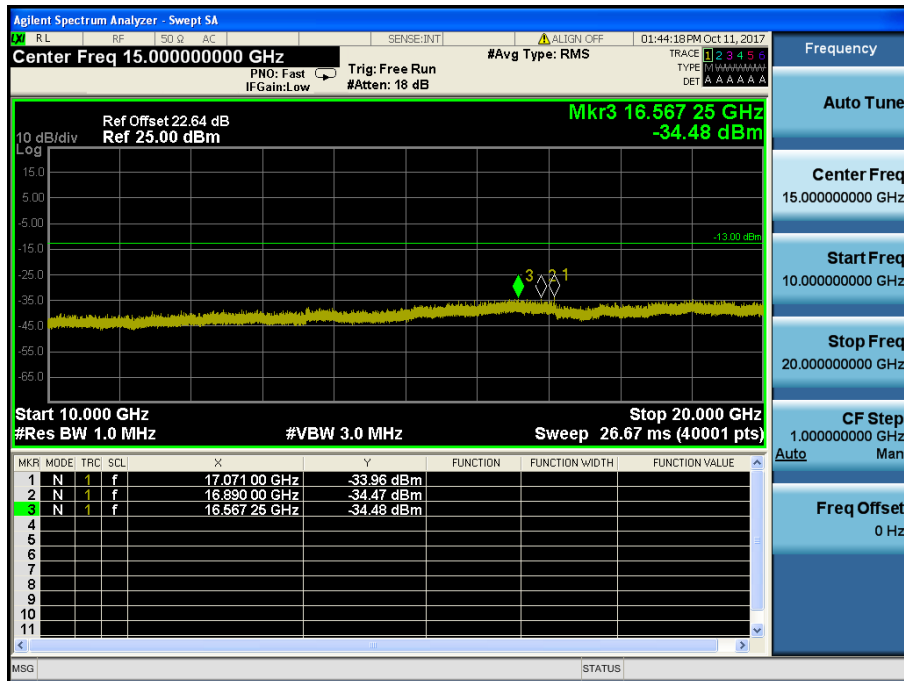

GSM1900 & Channel: 810

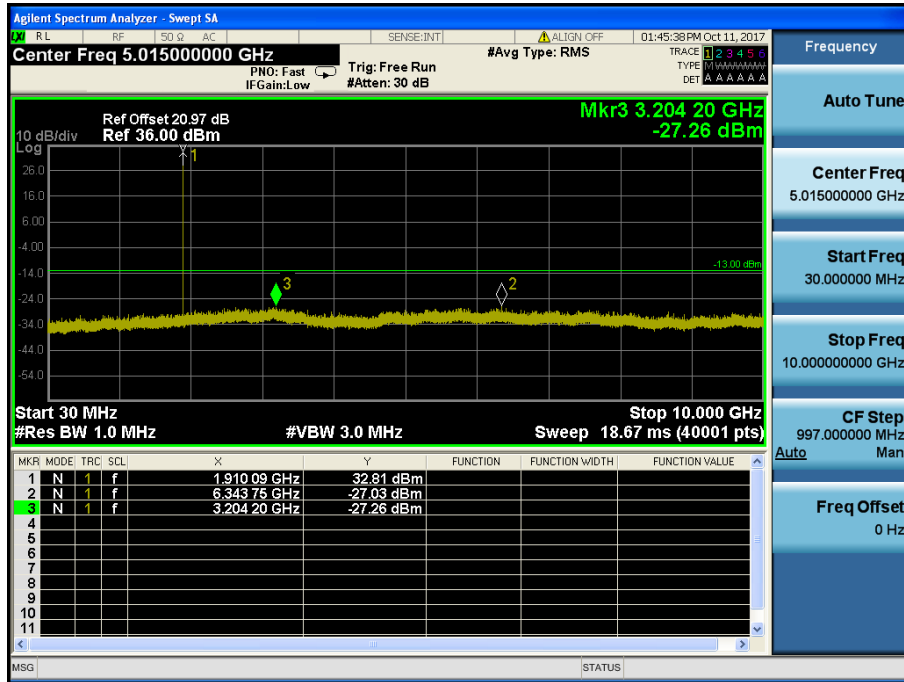

GSM1900 & Channel: 810

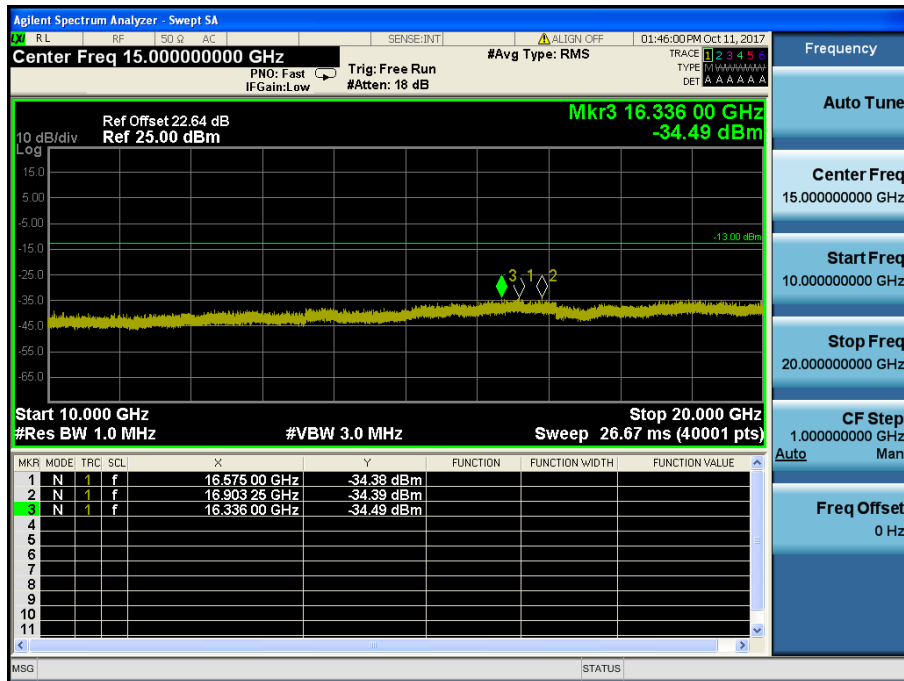

WCDMA850 & Channel: 4132

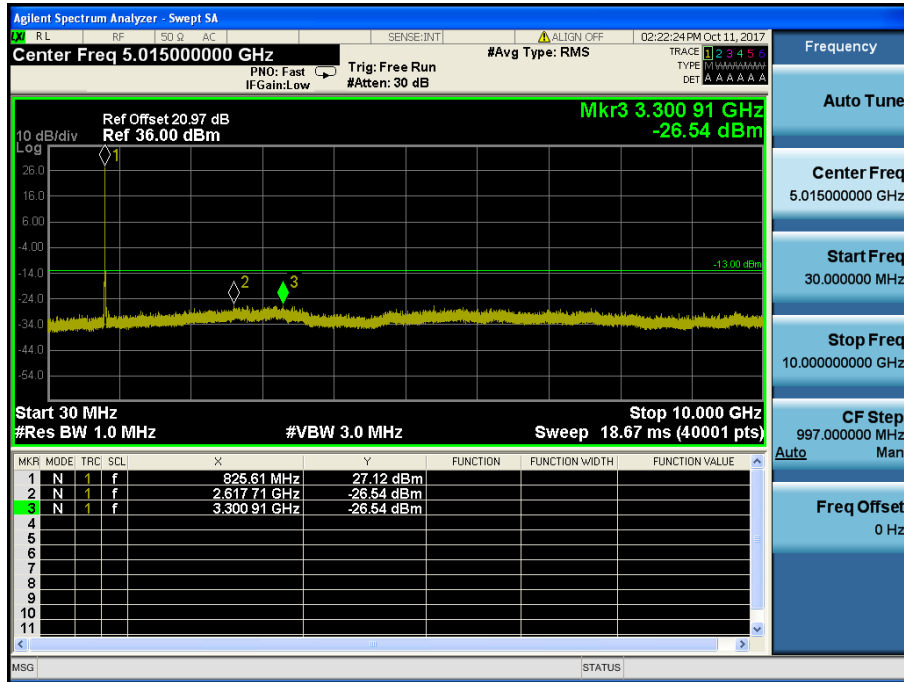

WCDMA850 & Channel: 4183

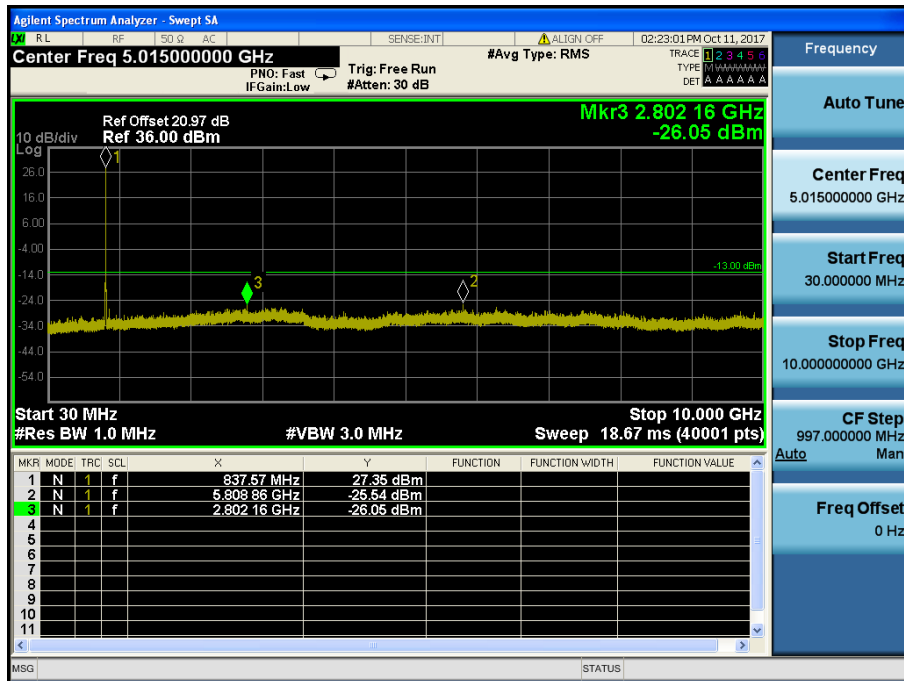

WCDMA850 & Channel: 4233

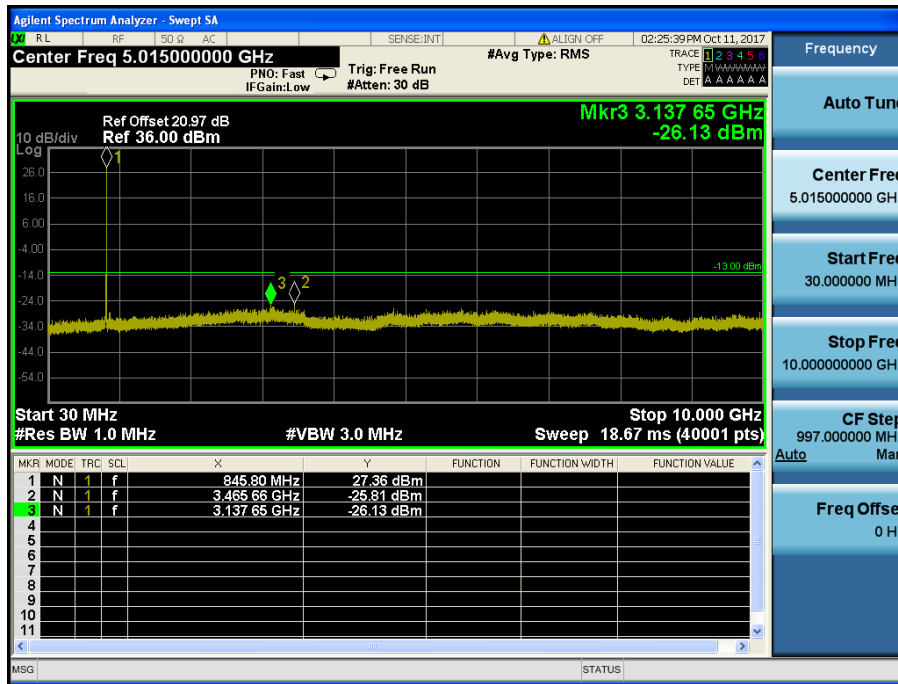

HSUPA850 & Channel: 4132

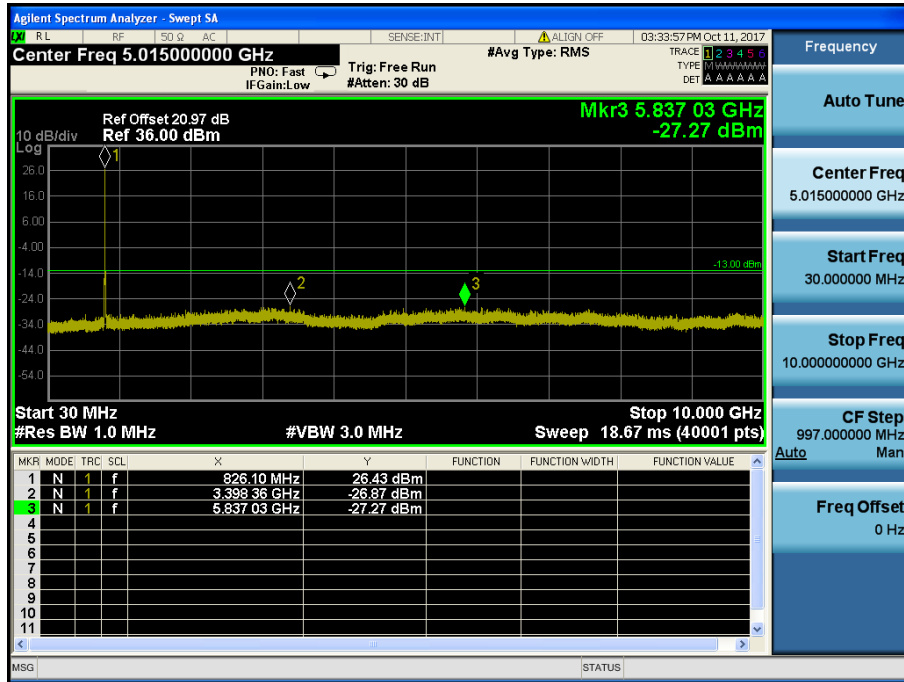

HSUPA850 & Channel: 4183

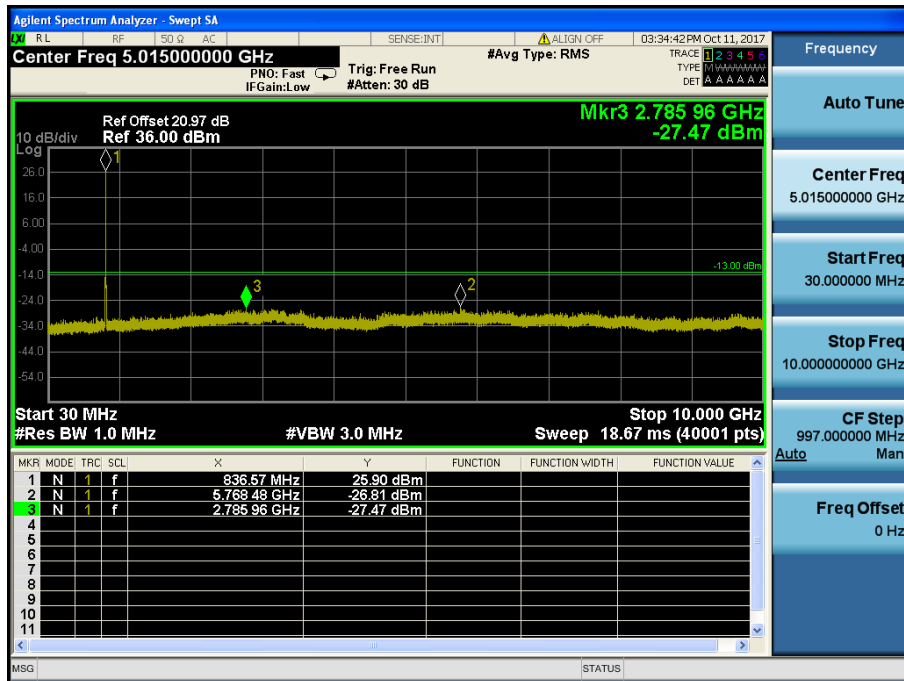

HSUPA850 & Channel: 4233

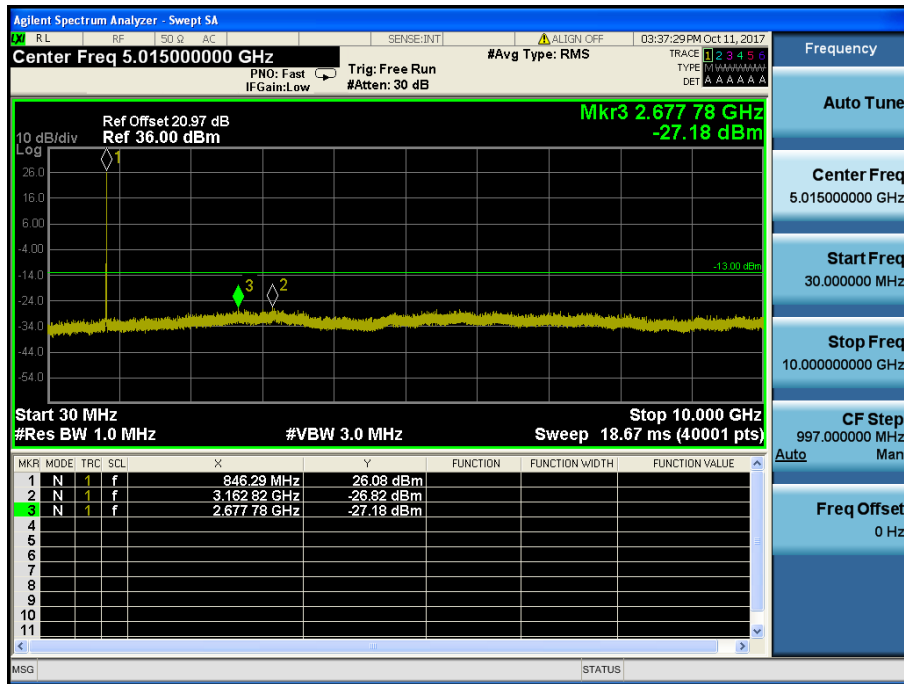

8.4 Band Edge

GSM850 & Channel: 128

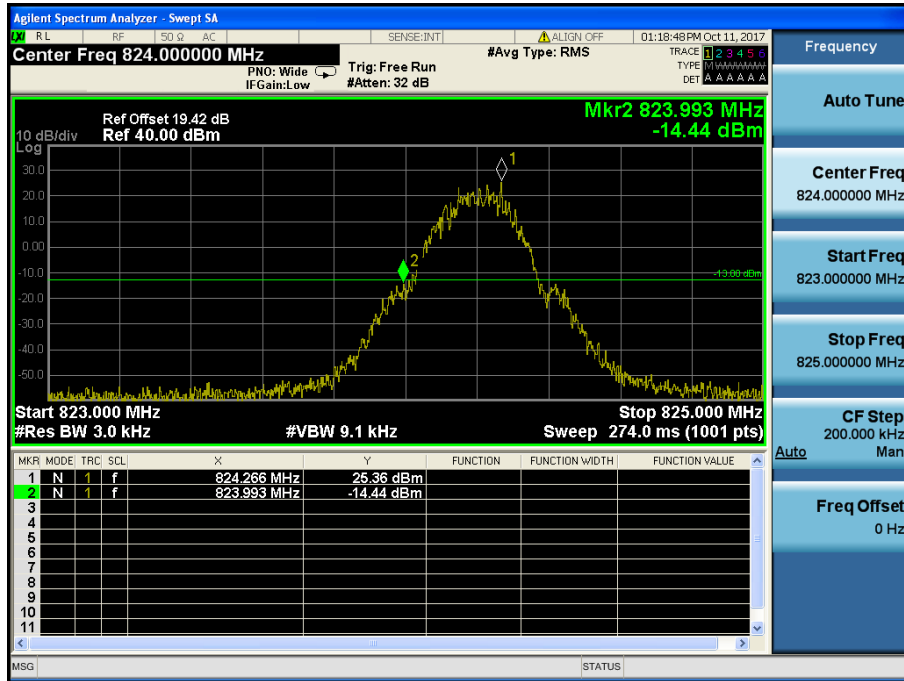

GSM850 & Channel: 128

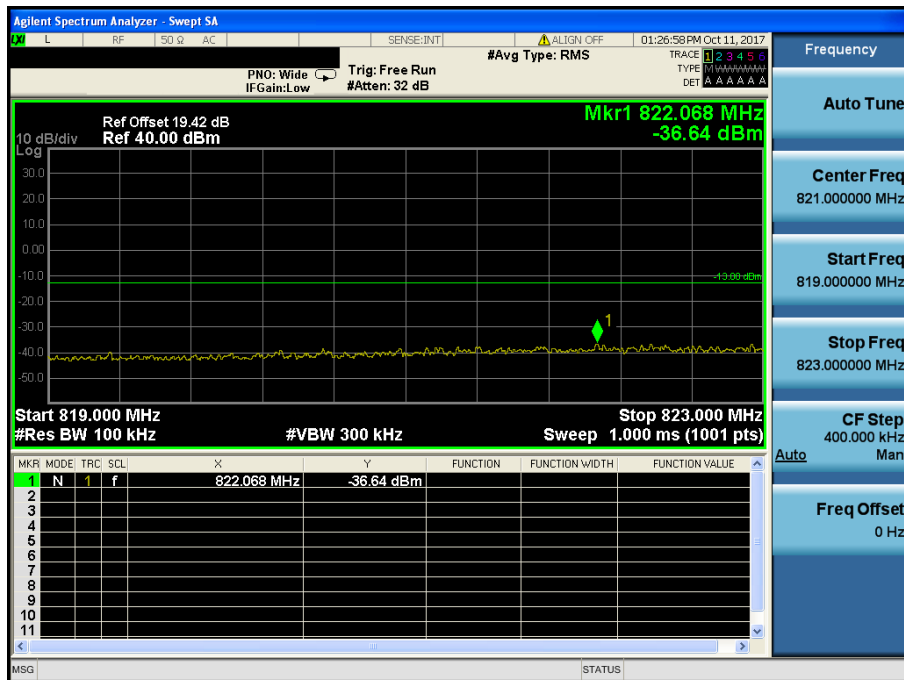

GSM850 & Channel: 251

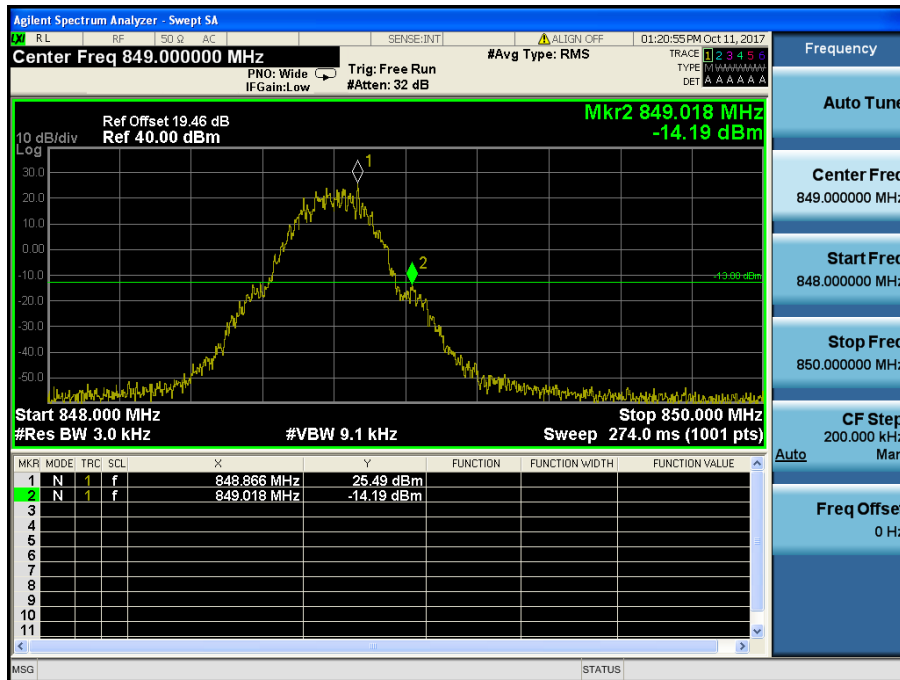

GSM850 & Channel: 251

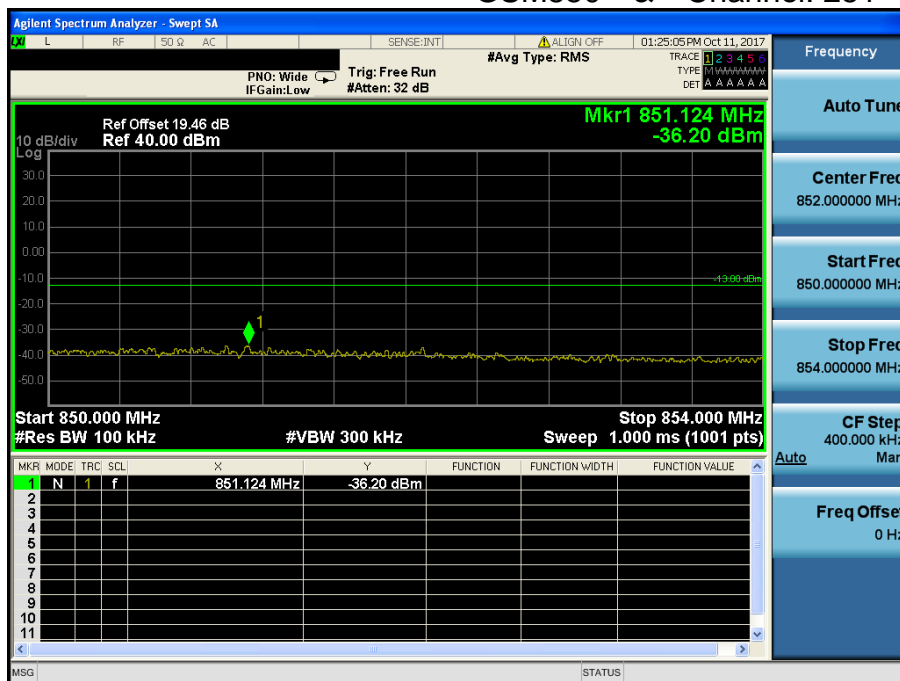

GSM1900 & Channel: 512

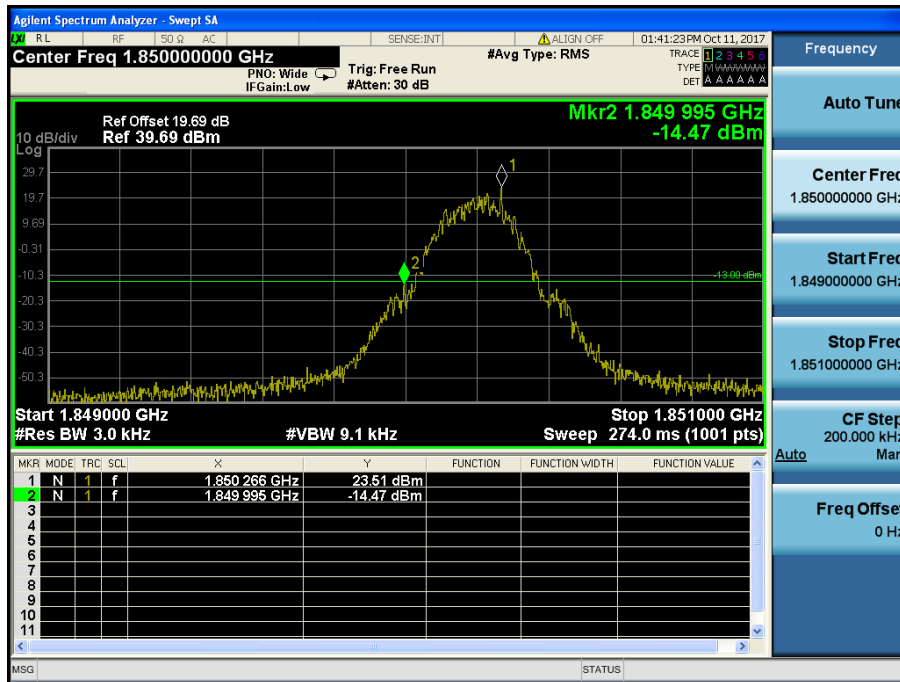

GSM1900 & Channel: 512

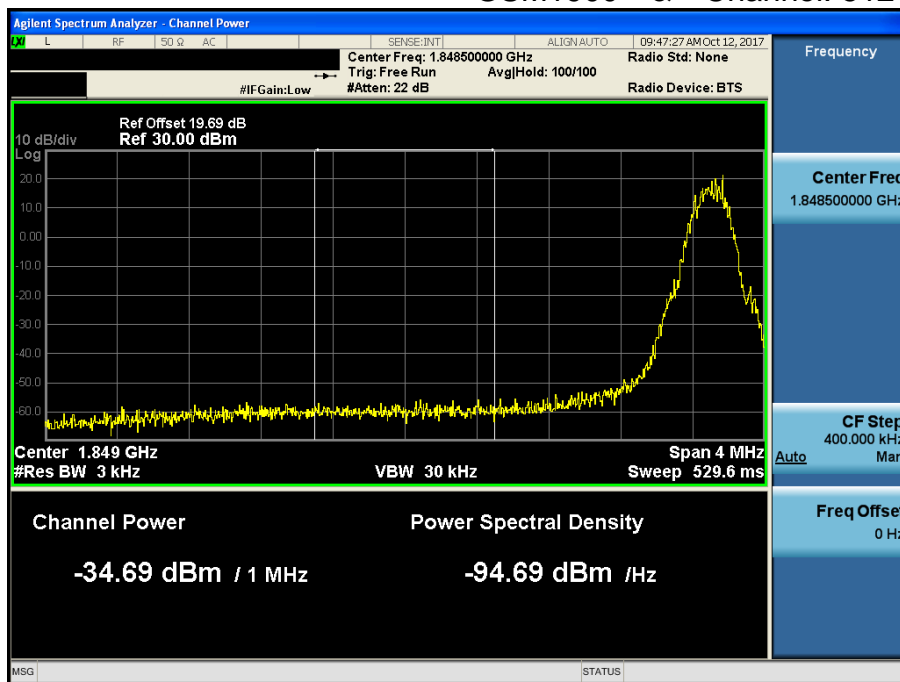

GSM1900 & Channel: 810

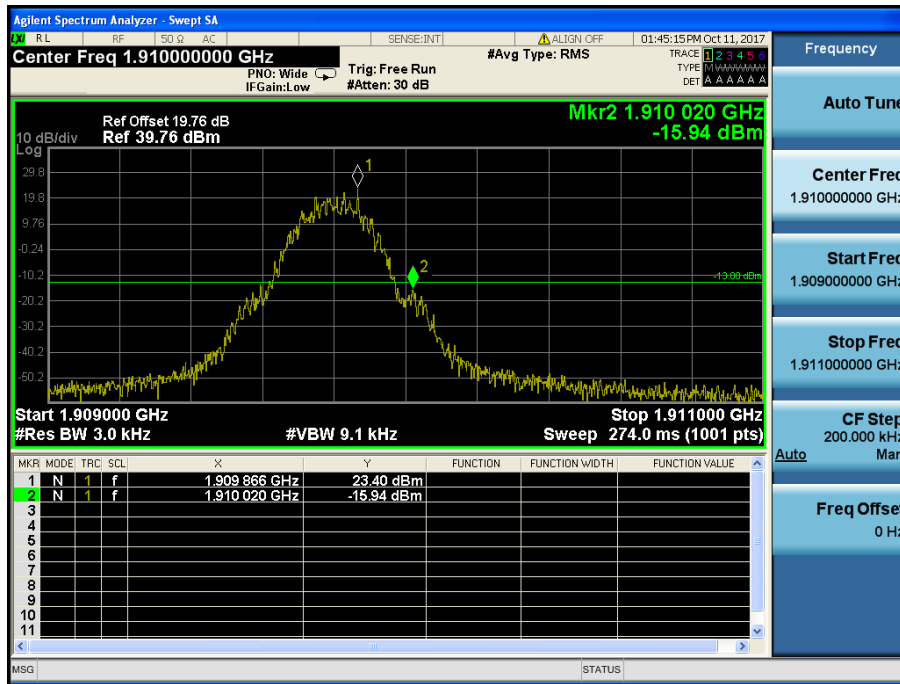

GSM1900 & Channel: 810

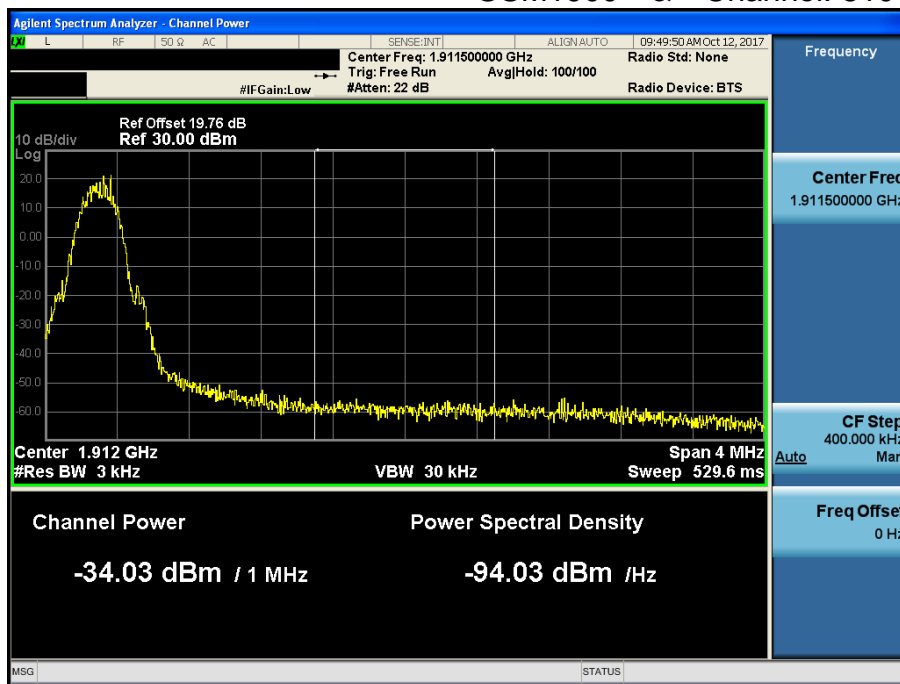

WCDMA850 & Channel: 4132

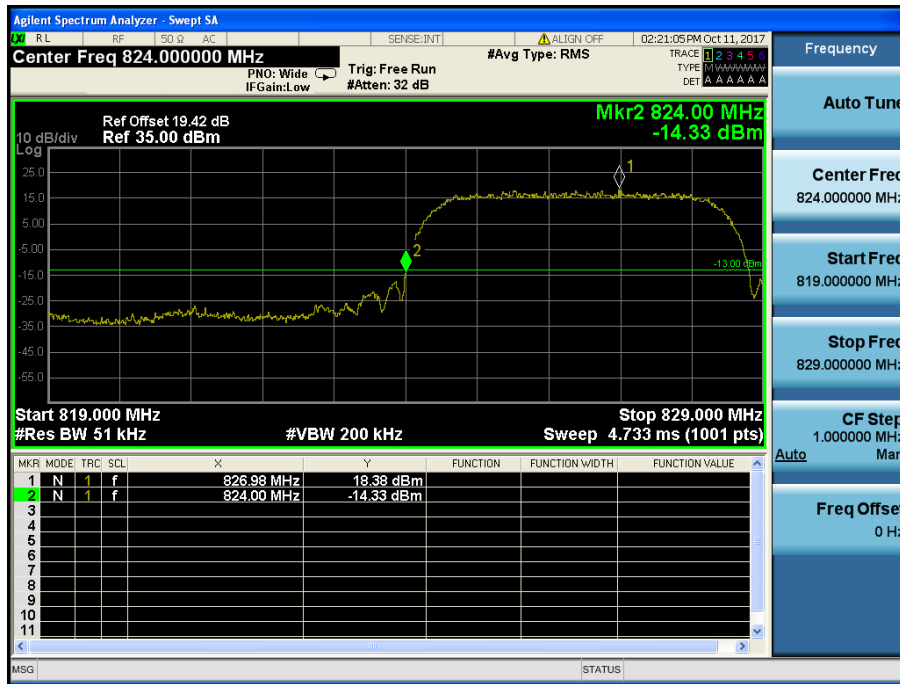

WCDMA850 & Channel: 4132

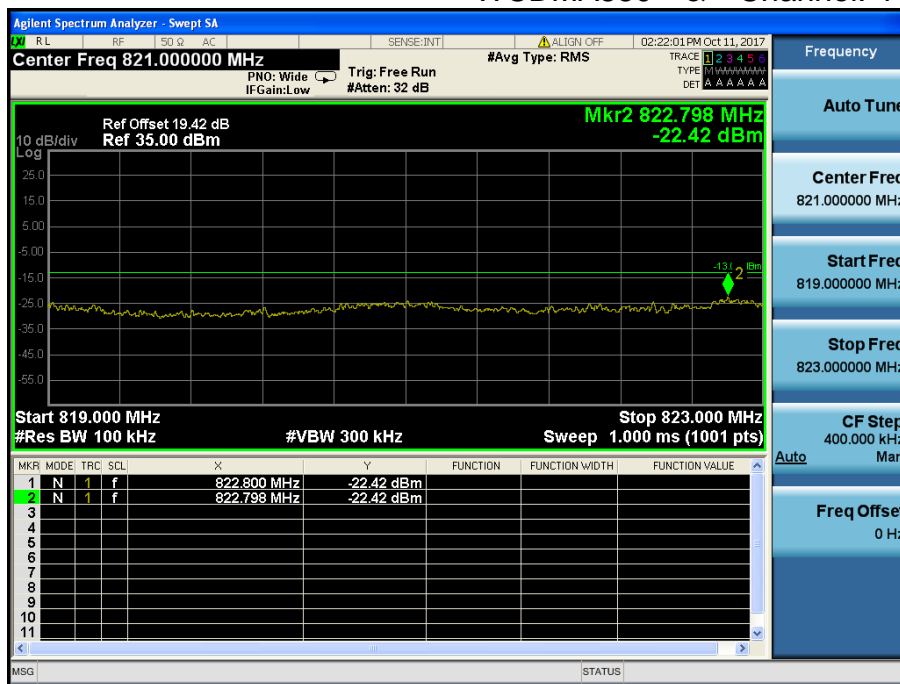

WCDMA850 & Channel: 4233



WCDMA850 & Channel: 4233



HSUPA850& Channel: 4132

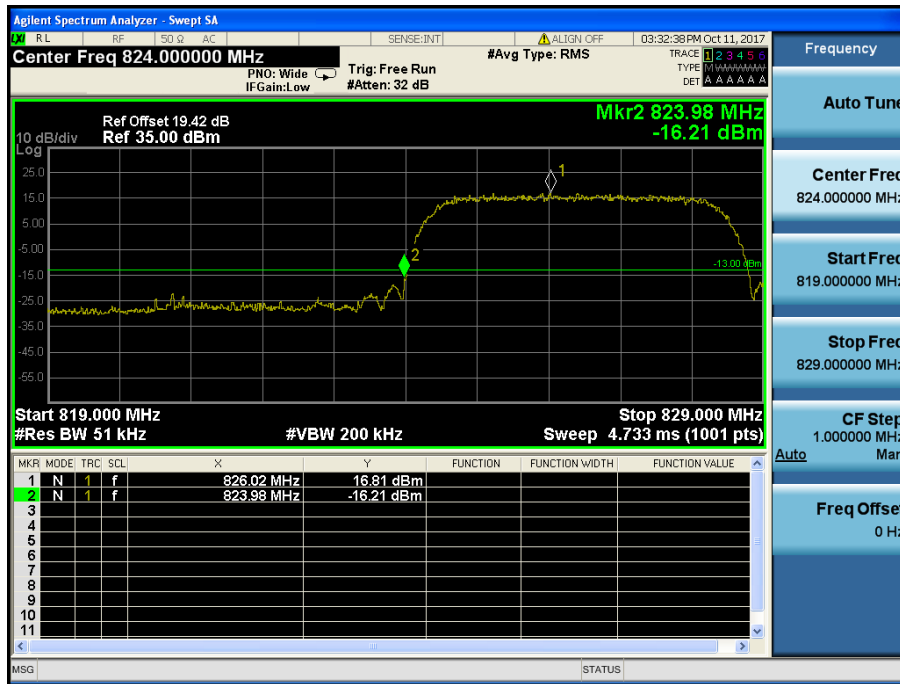

HSUPA850 & Channel: 4132

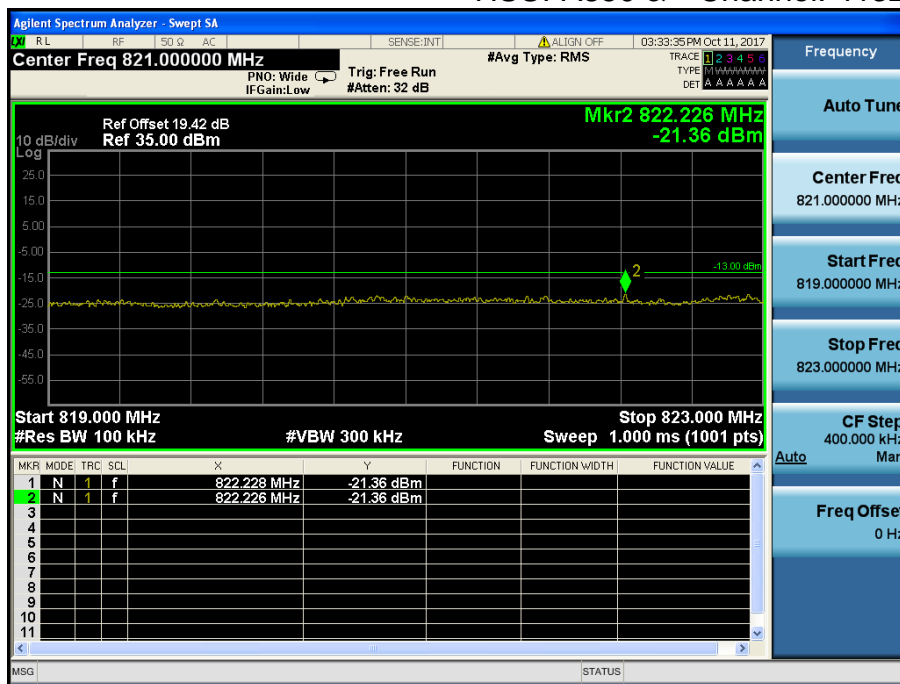

HSUPA850 & Channel: 4233



HSUPA850 & Channel: 4233

