

FCC LTE REPORT

FCC Certification

Applicant Name:
 LG Electronics MobileComm U.S.A., Inc.

Date of Issue:
 November 24, 2016

Address:
 1000 Sylvan Avenue, Englewood Cliffs NJ 07632

Location:
 HCT CO., LTD.,
 74, Seoicheon-ro 578beon-gil, Majang-myeon,
 Icheon-si, Gyeonggi-do, 17383, Rep. of KOREA

Report No.: HCT-R-1611-F024-1
HCT FRN: 0005866421

FCC ID: ZNFL01J

APPLICANT: LG Electronics MobileComm U.S.A., Inc.

FCC Model(s): L-01J
EUT Type: GSM/WCDMA/LTE Phone with WLAN, Bluetooth and NFC
FCC Classification: Licensed Portable Transmitter Held to Ear (PCE)
FCC Rule Part(s): §22, §2

Mode (MHz)	Tx Frequency (MHz)	Emission Designator	Modulation	ERP	
				Max. Power (W)	Max. Power (dBm)
LTE – Band5 (1.4)	824.7 – 848.3	1M09G7D	QPSK	0.061	17.84
		1M09W7D	16QAM	0.051	17.06
LTE – Band5 (3)	825.5 – 847.5	2M70G7D	QPSK	0.058	17.65
		2M69W7D	16QAM	0.047	16.73
LTE – Band5 (5)	826.5 – 846.5	4M50G7D	QPSK	0.059	17.69
		4M50W7D	16QAM	0.046	16.61
LTE – Band5 (10)	829.0 – 844.0	8M96G7D	QPSK	0.060	17.80
		8M94W7D	16QAM	0.048	16.81

The measurements shown in this report were made in accordance with the procedures specified in CFR47 section §2.947. I assume full responsibility for the accuracy and completeness of these measurements, and for the qualifications of all persons taking them.

HCT CO., LTD. Certifies that no party to this application has subject to a denial of Federal benefits that includes FCC benefits pursuant to section 5301 of the Anti-Drug Abuse Act of 1998, 21 U.S.C. 853(a)



Report prepared by
: Jeong Ho Kim
Test engineer of RF Team



Approved by
: Yong Hyun Lee
Manager of RF Team

This report only responds to the tested sample and may not be reproduced, except in full, without written approval of the HCT Co., Ltd.

Version

TEST REPORT NO.	DATE	DESCRIPTION
HCT-R-1611-F024	November 18, 2016	- First Approval Report
HCT-R-1611-F024-1	November 24, 2016	- Revised list of test equipment & Test date

Table of Contents

1. GENERAL INFORMATION	4
2. INTRODUCTION	5
2.1. EUT DESCRIPTION.....	5
2.2. MEASURING INSTRUMENT CALIBRATION.....	5
2.3. TEST FACILITY	5
3. DESCRIPTION OF TESTS	6
3.1 ERP RADIATED POWER AND RADIATED SPURIOUS EMISSIONS	6
3.2 FREQUENCY RANGE	6
3.3 OCCUPIED BANDWIDTH.	8
3.4 SPURIOUS AND HARMONIC EMISSIONS AT ANTENNA TERMINAL.....	9
3.5 FREQUENCY STABILITY / VARIATION OF AMBIENT TEMPERATURE	10
4. LIST OF TEST EQUIPMENT	11
5. MEASUREMENT UNCERTAINTY	12
6. SUMMARY OF TEST RESULTS	13
7. SAMPLE CALCULATION.....	14
8. TEST DATA	15
8.1 EFFECTIVE RADIATED POWER (Band 5).....	15
8.2 RADIATED SPURIOUS EMISSIONS.....	17
8.2.1 RADIATED SPURIOUS EMISSIONS (1.4 MHz Band 5 LTE).....	17
8.2.2 RADIATED SPURIOUS EMISSIONS (3 MHz Band 5 LTE).....	18
8.2.3 RADIATED SPURIOUS EMISSIONS (5 MHz Band 5 LTE).....	19
8.2.4 RADIATED SPURIOUS EMISSIONS (10 MHz Band 5 LTE).....	20
8.3 OCCUPIED BANDWIDTH	21
8.4 CONDUCTED SPURIOUS EMISSIONS	22
8.4.1 BAND EDGE.....	22
8.5 FREQUENCY STABILITY / VARIATION OF AMBIENT TEMPERATURE	23
8.5.1 FREQUENCY STABILITY (1.4 MHz Band 5 LTE)	23
8.5.2 FREQUENCY STABILITY (3 MHz Band 5 LTE)	24
8.5.3 FREQUENCY STABILITY (5 MHz Band 5 LTE)	25
8.5.4 FREQUENCY STABILITY (10 MHz Band 5 LTE)	26
9. TEST PLOTS.....	27

MEASUREMENT REPORT

1. GENERAL INFORMATION

Applicant Name: LG Electronics MobileComm U.S.A., Inc.

Address: 1000 Sylvan Avenue, Englewood Cliffs NJ 07632

FCC ID: ZNFL01J

Application Type: Certification

FCC Classification: Licensed Portable Transmitter Held to Ear (PCE)

FCC Rule Part(s): §22, §2

EUT Type: GSM/WCDMA/LTE Phone with WLAN, Bluetooth and NFC

FCC Model(s): L-01J

Tx Frequency: 824.7 MHz – 848.3 MHz (LTE – Band 5 (1.4 MHz))
825.5 MHz – 847.5 MHz (LTE – Band 5 (3 MHz))
826.5 MHz – 846.5 MHz (LTE – Band 5 (5 MHz))
829.0 MHz – 844.0 MHz (LTE – Band 5 (10 MHz))

Max. RF Output Power:

Band 5 (1.4 MHz) :	0.061 W (QPSK) (17.84 dBm)
	0.051 W (16-QAM) (17.06 dBm)
Band 5 (3 MHz) :	0.058 W (QPSK) (17.65 dBm)
	0.047 W (16-QAM) (16.73 dBm)
Band 5 (5 MHz) :	0.059 W (QPSK) (17.69 dBm)
	0.046 W (16-QAM) (16.61 dBm)
Band 5 (10 MHz) :	0.060 W (QPSK) (17.80 dBm)
	0.048 W (16-QAM) (16.81 dBm)

Emission Designator(s):

Band 5 (1.4 MHz) :	1M09G7D (QPSK) / 1M09W7D (16-QAM)
Band 5 (3 MHz) :	2M70G7D (QPSK) / 2M69W7D (16-QAM)
Band 5 (5 MHz) :	4M50G7D (QPSK) / 4M50W7D (16-QAM)
Band 5 (10 MHz) :	8M96G7D (QPSK) / 8M94W7D (16-QAM)

Date(s) of Tests: October 20, 2016 ~ November 17, 2016

Antenna Specification

Manufacturer:	AT&C Co.LTD.
Antenna type:	PIFA Antenna (Planar Inverted F)
Peak Gain:	Band 5 : -6.26 dBi

2. INTRODUCTION

2.1. EUT DESCRIPTION

The LG Electronics MobileComm U.S.A., Inc. L-01J GSM/WCDMA/LTE Phone with WLAN, Bluetooth and NFC consists of LTE 5.

2.2. MEASURING INSTRUMENT CALIBRATION

The measuring equipment, which was utilized in performing the tests documented herein, has been calibrated in accordance with the manufacturer's recommendations for utilizing calibration equipment, which is traceable to recognized national standards.

2.3. TEST FACILITY

The Fully-anechoic chamber and conducted measurement facility used to collect the radiated data are located at the **74, Seoicheon-ro 578beon-gil, Majang-myeon, Icheon-si, Gyeonggi-do, 17383, Rep. of KOREA.**

3. DESCRIPTION OF TESTS

3.1 ERP RADIATED POWER AND RADIATED SPURIOUS EMISSIONS

Note: ERP(Effective Radiated Power)

Test Procedure

Radiated emission measurements are performed in the Fully-anechoic chamber. The equipment under test is placed on a non-conductive table 3-meters away from the receive antenna in accordance with ANSI/TIA-603-D-2010 Clause 2.2.17. The turntable is rotated through 360 degrees, and the receiving antenna scans in order to determine the level of the maximized emission. The level and position of the maximized emission is recorded with the spectrum analyzer using a RMS detector.

A half wave dipole is then substituted in place of the EUT. For emissions above 1GHz, a horn antenna is substituted in place of the EUT. The substitute antenna is driven by a signal generator and the previously recorded signal was duplicated.

The power is calculated by the following formula;

$$P_{d(dBm)} = P_{g(dBm)} - \text{cable loss (dB)} + \text{antenna gain (dB)}$$

Where: P_d is the dipole equivalent power and P_g is the generator output power into the substitution antenna.

Radiated spurious emissions

: Frequency Range : 9 kHz ~ 10th Harmonics of highest channel fundamental frequency.

3.2 FREQUENCY RANGE

§22.917(a): Cellular – Mobile Frequency Blocks

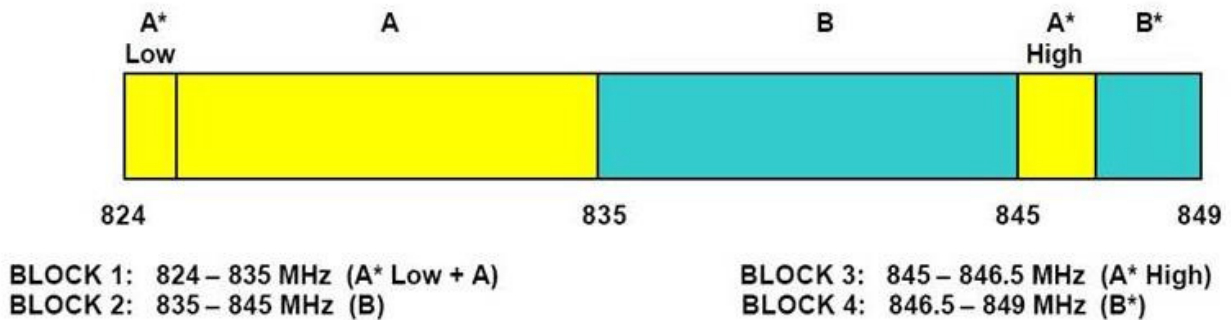

5.1.1 Peak power measurements with a spectrum/signal analyzer or EMI receiver

The following procedure can be used to determine the total peak output power.

- a) Set the RBW \geq OBW.
- b) Set VBW $\geq 3 \times$ RBW.
- c) Set span $\geq 2 \times$ RBW
- d) Sweep time = auto couple.
- e) Detector = peak.
- f) Ensure that the number of measurement points \geq span/RBW.
- g) Trace mode = max hold.
- h) Allow trace to fully stabilize.
- i) Use the peak marker function to determine the peak amplitude level.

5.2.2 Procedures for use with a spectrum/signal analyzer when EUT cannot be configured to transmit continuously and sweep triggering/signal gating cannot be properly implemented

If the EUT cannot be configured to transmit continuously (burst duty cycle $< 98\%$), then one of the following procedures can be used. The selection of the applicable procedure will depend on the characteristics of the measured burst duty cycle.

Measure the burst duty cycle with a spectrum/signal analyzer or EMC receiver can be used in zero-span mode if the response time and spacing between bins on the sweep are sufficient to permit accurate measurement of the burst on/off time of the transmitted signal.

5.2.2.2 Constant burst duty cycle

If the measured burst duty cycle is constant (i.e., duty cycle variations are less than ± 2 percent), then:

- a) Set span to at least 1.5 times the OBW.
- b) Set RBW = 1-5% of the OBW, not to exceed 1 MHz.
- c) Set VBW $\geq 3 \times$ RBW.
- d) Number of points in sweep $\geq 2 \times$ span / RBW. (This gives bin-to-bin spacing \leq RBW/2, so that narrowband signals are not lost between frequency bins.)
- e) Sweep time = auto.
- f) Detector = RMS (power averaging).
- g) Set sweep trigger to "free run".
- h) Trace average at least 100 traces in power averaging (i.e., RMS) mode.
- i) Compute power by integrating the spectrum across the OBW of the signal using the instrument's band power measurement function with band limits set equal to the OBW band edges. If the instrument does not have a band power function, sum the spectrum levels (in power units) at intervals equal to the RBW extending across the entire OBW of the spectrum.
- j) Add $10 \log (1/x)$, where x is the duty cycle, to the measured power in order to compute the average power during the actual transmission times (because the measurement represents an average over both the on and off times of the transmission).

For example, add $10 \log (1/0.25) = 6$ dB if the duty cycle is a constant 25%.

3.3 OCCUPIED BANDWIDTH.

Test set-up

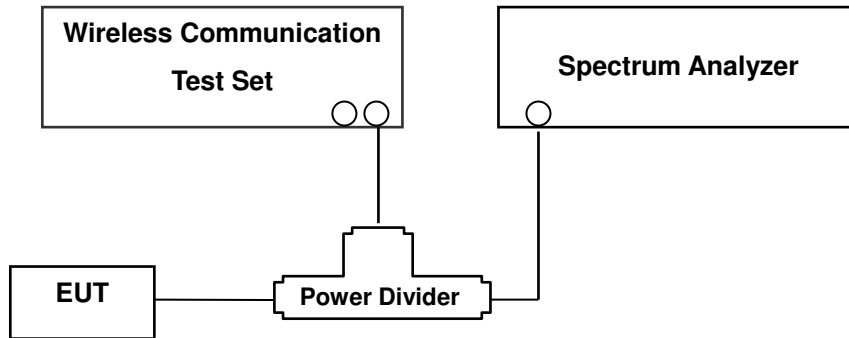

(Configuration of conducted Emission measurement)

The width of a frequency band such that, below the lower and above the upper frequency limits, the mean powers emitted are each equal to a specified percentage 0.5 % of the total mean power of a given emission.

Test Procedure

OBW is tested in accordance with KDB971168 D01 Power Meas License Digital Systems v02r02, October 17, 2014, Section 4.2.

The EUT makes a call to the communication simulator. The power was measured with R&S Spectrum Analyzer. All measurements were done at 3 channels(low, middle and high operational range.)

The conducted occupied bandwidth used the power splitter via EUT RF power connector between simulation base station and spectrum analyzer.

The communication simulator station system controlled a EUT to export maximum output power under transmission mode and specific channel frequency. Use OBW measurement function of Spectrum analyzer to measure 99 % occupied bandwidth

3.4 SPURIOUS AND HARMONIC EMISSIONS AT ANTENNA TERMINAL.

Test Procedure

Spurious and harmonic emissions at antenna terminal is tested in accordance with KDB971168 D01 Power Meas License Digital Systems v02r02, October 17, 2014, Section 6.0.

The level of the carrier and the various conducted spurious and harmonic frequencies is measured by means of a calibrated spectrum analyzer.

The EUT was setup to maximum output power at its lowest channel. The Resolution BW of the analyzer is set to 1 % of the emission bandwidth to show compliance with the -13 dBm limit, in the 1 MHz bands immediately outside and adjacent to the edge of the frequency block. The 1 MHz RBW was used to scan from 30 MHz to 10th Harmonics. A display line was placed at -13 dBm to show compliance. The high, lowest and a middle channel were tested for out of band measurements.

- Band Edge Requirement : In the 1MHz bands immediately outside and adjacent to the frequency block, a resolution bandwidth of at least 1 percent of the emission bandwidth of the fundamental emission of the transmitter may be employed to measure the out of band Emissions. Limit, -13dBm.

NOTES: The analyzer plot offsets were determined by below conditions.

- For LTE Band 5, total offset 26.7 dB = 20 dB attenuator + 6 dB Divider + 0.7 dB RF cables.

3.5 FREQUENCY STABILITY / VARIATION OF AMBIENT TEMPERATURE

Test Set-up

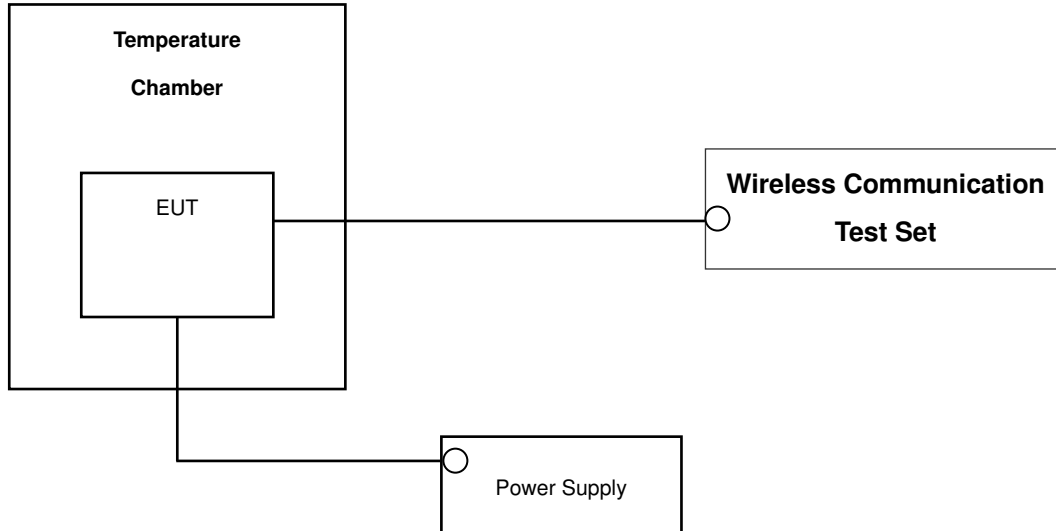

* Nominal Operating Voltage

Test Procedure

Frequency stability is tested in accordance with ANSI/TIA-603-D-2010 section 2.2.2

The frequency stability of the transmitter is measured by:

- a.) **Temperature:** The temperature is varied from - 30 °C to + 50 °C using an environmental chamber.
- b.) **Primary Supply Voltage:** The primary supply voltage is varied from the end point to 100 % of the voltage normally at the input to the device or at the power supply terminals if cables are not normally supplied.

Specification — the frequency stability of the transmitter shall be maintained within $\pm 0.00025\%$ (± 2.5 ppm) of the center frequency.

Time Period and Procedure:

The carrier frequency of the transmitter is measured at room temperature (20°C to provide a reference).

1. The equipment is turned on in a “standby” condition for one minute before applying power to the transmitter. Measurement of the carrier frequency of the transmitter is made within one minute after applying power to the transmitter.
2. Frequency measurements are made at 10°C intervals ranging from -30°C to +50°C. A period of at least one half-hour is provided to allow stabilization of the equipment at each temperature level.

NOTE: The EUT is tested down to the battery endpoint.

4. LIST OF TEST EQUIPMENT

Manufacture	Model/ Equipment	Serial Number	Calibration Date	Calibration Interval	Calibration Due
REOHDE & SCHWARZ	SCU 18 / AMPLIFIER	10094	09/07/2016	Annual	09/07/2017
Wainwright	WHK1.2/15G-10EF/H.P.F	4	04/11/2016	Annual	04/11/2017
Wainwright	WHK3.3/18G-10EF/H.P.F	2	04/11/2016	Annual	04/11/2017
Hewlett Packard	11667B / Power Splitter	10545	02/15/2016	Annual	02/15/2017
Hewlett Packard	11667B / Power Splitter	11275	04/29/2016	Annual	04/29/2017
Agilent	E3632A/DC Power Supply	KR75303243	07/12/2016	Annual	07/12/2017
Schwarzbeck	UHAP/ Dipole Antenna	557	03/23/2015	Biennial	03/23/2017
Schwarzbeck	UHAP/ Dipole Antenna	558	03/23/2015	Biennial	03/23/2017
EXP	EX-TH400/ Chamber	None	05/31/2016	Annual	05/31/2017
Schwarzbeck	BBHA 9120D/ Horn Antenna	147	09/09/2016	Biennial	09/09/2018
Schwarzbeck	BBHA 9120D/ Horn Antenna	1299	05/15/2015	Biennial	05/15/2017
Schwarzbeck	BBHA 9170/ Horn Antenna(15~40GHz)	BBHA9170342	04/30/2015	Biennial	04/30/2017
Schwarzbeck	BBHA 9170/ Horn Antenna(15~35GHz)	BBHA9170124	04/30/2015	Biennial	04/30/2017
Agilent	N9020A/Signal Analyzer	MY52090906	05/13/2016	Annual	05/13/2017
Hewlett Packard	8493C/ATTENUATOR	17280	06/22/2016	Annual	06/22/2017
REOHDE & SCHWARZ	FSV40/Spectrum Analyzer	1307.9002K40-100931-NK	06/15/2016	Annual	06/15/2017
Agilent	8960 (E5515C)/ Base Station	MY48360800	10/19/2016	Annual	10/19/2017
Schwarzbeck	FMZB1513/ Loop Antenna(9 kHz~ 30MHz)	1513-175	02/23/2016	Biennial	02/23/2018
Schwarzbeck	VULB9160/ Bilog Antenna	3150	09/30/2016	Biennial	09/30/2018
Schwarzbeck	VULB9160/ Bilog Antenna	3368	10/14/2016	Biennial	10/14/2018
Anritsu Corp.	MT8820C/Wideband Radio Communication Tester	6200863156	02/26/2016	Annual	02/26/2017
Anritsu Corp.	MT8820C/Wideband Radio Communication Tester	6201026545	02/16/2016	Annual	02/16/2017

5. MEASUREMENT UNCERTAINTY

The measurement uncertainties shown below were calculated in accordance with the requirements of ANSI C63.4:2014.

All measurement uncertainty values are shown with a coverage factor of $k = 2$ to indicate a 95 % level of confidence. The measurement data shown herein meets or exceeds the U_{CISPR} measurement uncertainty values specified in CISPR 16-4-2 and, thus, can be compared directly to specified limits to determine compliance.

Parameter	Expanded Uncertainty (\pm dB)
Conducted Disturbance (150 kHz ~ 30 MHz)	1.82
Radiated Disturbance (9 kHz ~ 30 MHz)	3.40
Radiated Disturbance (30 MHz ~ 1 GHz)	4.80
Radiated Disturbance (1 GHz ~ 18 GHz)	6.07

6. SUMMARY OF TEST RESULTS

FCC Part Section(s)	Test Description	Test Limit	Test Condition	Test Result
2.1049	Occupied Bandwidth	N/A	CONDUCTED	PASS
2.1051, 22.917(a)	Band Edge / Spurious and Harmonic Emissions at Antenna Terminal.	$< 43 + 10\log_{10}(P[\text{Watts}])$ at Band Edge and for all out-of-band emissions		PASS
2.1046	* Conducted Output Power	N/A		PASS
2.1055, 22.355	Frequency stability / variation of ambient temperature	< 2.5 ppm		PASS
22.913(a)(2)	Effective Radiated Power (Band 5)	< 7 Watts max. ERP	RADIATED	PASS
2.1053, 22.917(a)	Radiated Spurious and Harmonic Emissions	$< 43 + 10\log_{10}(P[\text{Watts}])$ for all out-of band emissions		PASS

*: See SAR Report

7. SAMPLE CALCULATION

A. ERP Sample Calculation

Mode	Ch./ Freq.		Measured Level(dBm)	Substitute LEVEL(dBm)	Ant. Gain (dBd)	C.L	Pol.	Limit W	ERP	
	channel	Freq.(MHz)							W	dBm
LTE Band5	20525	836.50	-6.73	40.89	-10.54	0.96	V	< 7.00	0.869	29.39

ERP = Substitute LEVEL(dBm) + Ant. Gain – CL(Cable Loss)

- 1) The EUT mounted on a wooden tripod is 2.5 meter above test site ground level.
- 2) During the test , the turn table is rotated and the antenna height is found.
- 3) Record the field strength meter's level.
- 4) Replace the EUT with dipole/Horn antenna that is connected to a calibrated signal generator.
- 5) Increase the signal generator output till the field strength meter's level is equal to the item (3).
- 6) The signal generator output level with Ant. Gain and cable loss are the rating of effective radiated power (**ERP**).

B. Emission Designator

QPSK Modulation

5MHz Bandwidth

Emission Designator = 4M48G7D

LTE BW = 4.48 MHz

G = Phase Modulation

7 = Quantized/Digital Info

D = Data transmission; telemetry; telecommand

10MHz Bandwidth

Emission Designator = 8M95G7D

LTE BW = 8.95 MHz

G = Phase Modulation

7 = Quantized/Digital Info

D = Data transmission; telemetry; telecommand

16QAM Modulation

5MHz Bandwidth

Emission Designator = 4M48W7D

LTE BW = 4.48 MHz

W = main carrier modulated in a combination of two or more of the following modes;
amplitude, angle, pulse

7 = Quantized/Digital Info

D = Data transmission; telemetry; telecommand

10MHz Bandwidth

Emission Designator = 8M95W7D

LTE BW = 8.95 MHz

W = main carrier modulated in a combination of two or more of the following modes;
amplitude, angle, pulse

7 = Quantized/Digital Info

D = Data transmission; telemetry; telecommand

8. TEST DATA

8.1 EFFECTIVE RADIATED POWER (Band 5)

Freq (MHz)	Bandwidth	Modulation	Measured Level (dBm)	Substitute Level (dBm)	Ant. Gain(dBd)	C.L	Pol	Limit	ERP	
								W	W	dBm
824.7	1.4 MHz	QPSK	-33.58	29.04	-10.59	1.67	V	< 7.00	0.048	16.78
		16-QAM	-34.42	28.20	-10.59	1.67	V		0.039	15.94
836.5		QPSK	-33.66	29.90	-10.54	1.68	V		0.059	17.68
		16-QAM	-34.44	29.12	-10.54	1.68	V		0.049	16.90
848.3		QPSK	-33.07	30.02	-10.49	1.69	V		0.061	17.84
		16-QAM	-33.85	29.24	-10.49	1.69	V		0.051	17.06

Effective Radiated Power Data (1.4 MHz Band 5 LTE)

Note: All of RB size has been tested for emissions and ERP, with the 1RB configuration observed as the worst case

Freq (MHz)	Bandwidth	Modulation	Measured Level (dBm)	Substitute Level (dBm)	Ant. Gain(dBd)	C.L	Pol	Limit	ERP	
								W	W	dBm
825.5	3 MHz	QPSK	-33.25	29.45	-10.59	1.67	V	< 7.00	0.052	17.19
		16-QAM	-34.25	28.45	-10.59	1.67	V		0.042	16.19
836.5		QPSK	-33.91	29.65	-10.54	1.68	V		0.055	17.43
		16-QAM	-34.73	28.83	-10.54	1.68	V		0.046	16.61
847.5		QPSK	-33.26	29.83	-10.49	1.69	V		0.058	17.65
		16-QAM	-34.18	28.91	-10.49	1.69	V		0.047	16.73

Effective Radiated Power Data (3 MHz Band 5 LTE)

Note: All of RB size has been tested for emissions and ERP, with the 1RB configuration observed as the worst case

Freq (MHz)	Bandwidth	Modulation	Measured Level (dBm)	Substitute Level (dBm)	Ant. Gain(dBd)	C.L	Pol	Limit	ERP	
								W	W	dBm
826.5	5 MHz	QPSK	-33.74	29.08	-10.58	1.67	V	< 7.00	0.048	16.83
		16-QAM	-34.71	28.11	-10.58	1.67	V		0.039	15.86
836.5		QPSK	-33.89	29.67	-10.54	1.68	V		0.056	17.45
		16-QAM	-34.73	28.83	-10.54	1.68	V		0.046	16.61
846.5		QPSK	-33.29	29.88	-10.50	1.69	V		0.059	17.69
		16-QAM	-34.38	28.79	-10.50	1.69	V		0.046	16.60

Effective Radiated Power Data (5 MHz Band 5 LTE)

Note: All of RB size has been tested for emissions and ERP, with the 1RB configuration observed as the worst case

Freq (MHz)	Bandwidth	Modulation	Measured Level (dBm)	Substitute Level (dBm)	Ant. Gain(dBd)	C.L	Pol	Limit	ERP	
								W	W	dBm
829.0	10 MHz	QPSK	-33.45	29.65	-10.57	1.67	V	< 7.00	0.055	17.41
		16-QAM	-34.41	28.69	-10.57	1.67	V		0.044	16.45
836.5		QPSK	-33.54	30.02	-10.54	1.68	V		0.060	17.80
		16-QAM	-34.53	29.03	-10.54	1.68	V		0.048	16.81
844.0		QPSK	-33.55	29.81	-10.51	1.69	V		0.058	17.61
		16-QAM	-34.35	29.01	-10.51	1.69	V		0.048	16.81

Effective Radiated Power Data (10 MHz Band 5 LTE)

Note: All of RB size has been tested for emissions and ERP, with the 1RB configuration observed as the worst case

NOTES:

Effective Radiated Power Output Measurements by Substitution Method

according to ANSI/TIA/EIA-603-D-2010 June 24, 2010:

The EUT was placed on a non-conductive styrofoam resin table 3-meters from the receive antenna. The receive antenna height and turntable rotation was adjusted for the highest reading on the receive spectrum analyzer. For LTE signals, RBW = 1-5% of the OBW, not to exceed 1MHz, VBW ≥ 3 x RBW, Detector = RMS.

A half-wave dipole was substituted in place of the EUT. This dipole antenna was driven by a signal generator and the level of the signal generator was adjusted to obtain the same receive spectrum analyzer reading. The conducted power at the terminals of the dipole is measured. The ERP is recorded.

Also, we have done x, y, z planes in EUT and horizontal and vertical polarization in detecting antenna. The worst case of the EUT is y plane in LTE mode. Also worst case of detecting Antenna is vertical polarization in LTE mode.

8.2 RADIATED SPURIOUS EMISSIONS

8.2.1 RADIATED SPURIOUS EMISSIONS (1.4 MHz Band 5 LTE)

- ▣ OPERATING FREQUENCY: 848.30 MHz
- ▣ MEASURED OUTPUT POWER: 17.84 dBm = 0.061 W
- ▣ MODULATION SIGNAL: 1.4 MHz QPSK
- ▣ DISTANCE: 3 meters
- ▣ LIMIT: $43 + 10 \log_{10}(W) =$ 30.84 dBc

Ch	Freq (MHz)	Measured Level (dBm)	Ant. Gain (dBd)	Substitute Level (dBm)	C.L	Pol	ERP (dBm)	dBc
20407 (824.7)	1,649.40	-49.13	9.16	-59.84	1.17	H	-51.85	69.69
	2,474.10	-55.95	10.93	-63.38	1.18	H	-53.64	71.48
	3,298.80	-56.31	11.94	-63.83	1.41	H	-53.30	71.14
20525 (836.5)	1,673.00	-43.04	9.23	-53.72	1.17	H	-45.66	63.50
	2,509.50	-55.01	10.96	-62.64	1.24	H	-52.92	70.76
	3,346.00	-55.93	12.04	-63.69	1.46	H	-53.11	70.95
20643 (848.3)	1,696.60	-42.33	9.32	-53.05	1.16	H	-44.89	62.73
	2,544.90	-53.90	10.99	-61.36	1.21	H	-51.59	69.43
	3,393.20	-55.97	12.14	-63.59	1.49	H	-52.94	70.78

- NOTES:**
1. Radiated Spurious Emission Measurements at 3 meters by Substitution Method according to ANSI/TIA/EIA-603-D-2010 June 24, 2010:
 2. We are performed all frequency to 10th harmonics from 9 kHz. Measurements above show only up to 3 maximum emissions noted, or would be lesser if no specific emissions from the EUT are recorded (ie: margin > 20 dB from the applicable limit) and considered that's already beyond the background noise floor.
 3. we have done x, y, z planes in EUT and horizontal and vertical polarization in detecting antenna.
 4. All of RB size has been tested for emissions and ERP, with the 1RB configuration observed as the worst case
 5. We are performed 16QAM and QPSK modulations. The worst case data are reported in the table above.

8.2.2 RADIATED SPURIOUS EMISSIONS (3 MHz Band 5 LTE)

- ▣ OPERATING FREQUENCY: 847.50 MHz
- ▣ MEASURED OUTPUT POWER: 17.65 dBm = 0.058 W
- ▣ MODULATION SIGNAL: 3 MHz QPSK
- ▣ DISTANCE: 3 meters
- ▣ LIMIT: $43 + 10 \log_{10}(W) =$ 30.65 dBc

Ch	Freq (MHz)	Measured Level (dBm)	Ant. Gain (dBd)	Substitute Level (dBm)	C.L	Pol	ERP (dBm)	dBc
20415 (825.5)	1,651.00	-49.83	9.16	-60.54	1.17	H	-52.55	70.20
	2,476.50	-55.32	10.93	-62.75	1.18	H	-53.01	70.66
	3,302.00	-55.28	11.94	-62.80	1.41	H	-52.27	69.92
20525 (836.5)	1,673.00	-43.99	9.23	-54.67	1.17	H	-46.61	64.26
	2,509.50	-55.08	10.96	-62.71	1.24	H	-52.99	70.64
	3,346.00	-55.89	10.03	-61.65	1.46	H	-53.07	70.72
20635 (847.5)	1,695.00	-43.65	9.32	-54.37	1.16	H	-46.21	63.86
	2,542.50	-55.70	10.98	-62.94	1.21	H	-53.17	70.82
	3,390.00	-55.16	12.13	-62.89	1.48	H	-52.24	69.89

- NOTES:**
1. Radiated Spurious Emission Measurements at 3 meters by Substitution Method according to ANSI/TIA/EIA-603-D-2010 June 24, 2010:
 2. We are performed all frequency to 10th harmonics from 9 kHz. Measurements above show only up to 3 maximum emissions noted, or would be lesser if no specific emissions from the EUT are recorded (ie: margin > 20 dB from the applicable limit) and considered that's already beyond the background noise floor.
 3. we have done x, y, z planes in EUT and horizontal and vertical polarization in detecting antenna.
 4. All of RB size has been tested for emissions and ERP, with the 1RB configuration observed as the worst case
 5. We are performed 16QAM and QPSK modulations. The worst case data are reported in the table above.

8.2.3 RADIATED SPURIOUS EMISSIONS (5 MHz Band 5 LTE)

- ▣ OPERATING FREQUENCY: 846.50 MHz
- ▣ MEASURED OUTPUT POWER: 17.69 dBm = 0.059 W
- ▣ MODULATION SIGNAL: 5 MHz QPSK
- ▣ DISTANCE: 3 meters
- ▣ LIMIT: $43 + 10 \log_{10}(W) =$ 30.69 dBc

Ch	Freq (MHz)	Measured Level (dBm)	Ant. Gain (dBd)	Substitute Level (dBm)	C.L	Pol	ERP (dBm)	dBc
20425 (826.5)	1,653.00	-49.55	9.18	-60.32	1.17	H	-52.31	70.00
	2,479.50	-56.74	10.93	-64.36	1.18	H	-54.61	72.30
	3,306.00	-55.53	11.95	-63.05	1.42	H	-52.51	70.20
20525 (836.5)	1,673.00	-44.60	9.23	-55.28	1.17	H	-47.22	64.91
	2,509.50	-56.20	10.96	-63.83	1.24	H	-54.11	71.80
	3,346.00	-55.66	10.03	-61.42	1.46	H	-52.84	70.53
20625 (846.5)	1,693.00	-44.13	9.32	-54.85	1.16	H	-46.69	64.38
	2,539.50	-56.77	10.98	-64.01	1.21	H	-54.24	71.93
	3,386.00	-55.86	12.22	-63.72	1.48	H	-52.97	70.66

- NOTES:**
1. Radiated Spurious Emission Measurements at 3 meters by Substitution Method according to ANSI/TIA/EIA-603-D-2010 June 24, 2010:
 2. We are performed all frequency to 10th harmonics from 9 kHz. Measurements above show only up to 3 maximum emissions noted, or would be lesser if no specific emissions from the EUT are recorded (ie: margin > 20 dB from the applicable limit) and considered that's already beyond the background noise floor.
 3. we have done x, y, z planes in EUT and horizontal and vertical polarization in detecting antenna.
 4. All of RB size has been tested for emissions and ERP, with the 1RB configuration observed as the worst case
 5. We are performed 16QAM and QPSK modulations. The worst case data are reported in the table above.

8.2.4 RADIATED SPURIOUS EMISSIONS (10 MHz Band 5 LTE)

- ▣ OPERATING FREQUENCY: 836.50 MHz
- ▣ MEASURED OUTPUT POWER: 17.80 dBm = 0.060 W
- ▣ MODULATION SIGNAL: 10 MHz QPSK
- ▣ DISTANCE: 3 meters
- ▣ LIMIT: $43 + 10 \log_{10}(W) =$ 30.80 dBc

Ch	Freq (MHz)	Measured Level (dBm)	Ant. Gain (dBd)	Substitute Level (dBm)	C.L	Pol	ERP (dBm)	dBc
20450 (829.0)	1,658.00	-48.87	9.20	-59.70	1.17	H	-51.67	69.47
	2,487.00	-54.44	10.94	-61.77	1.20	H	-52.03	69.83
	3,316.00	-56.09	11.97	-63.70	1.43	H	-53.15	70.95
20525 (836.5)	1,673.00	-46.28	9.23	-56.96	1.17	H	-48.90	66.70
	2,509.50	-55.61	10.96	-63.24	1.24	V	-53.52	71.32
	3,346.00	-55.34	10.03	-61.10	1.46	V	-52.52	70.32
20600 (844.0)	1,688.00	-43.02	9.30	-53.72	1.16	H	-45.58	63.38
	2,532.00	-54.03	10.98	-61.75	1.20	V	-51.97	69.76
	3,376.00	-55.24	12.10	-63.05	1.47	H	-52.42	70.22

- NOTES:**
1. Radiated Spurious Emission Measurements at 3 meters by Substitution Method according to ANSI/TIA/EIA-603-D-2010 June 24, 2010:
 2. We are performed all frequency to 10th harmonics from 9 kHz. Measurements above show only up to 3 maximum emissions noted, or would be lesser if no specific emissions from the EUT are recorded (ie: margin > 20 dB from the applicable limit) and considered that's already beyond the background noise floor.
 3. we have done x, y, z planes in EUT and horizontal and vertical polarization in detecting antenna.
 4. All of RB size has been tested for emissions and ERP, with the 1RB configuration observed as the worst case
 5. We are performed 16QAM and QPSK modulations. The worst case data are reported in the table above.

8.3 OCCUPIED BANDWIDTH

Band	Band Width	Frequency (MHz)	Modulation	Resource Block Size	Resource Block Offset	Data (MHz)
5	1.4 MHz	836.5	QPSK	6	0	1.0933
			16-QAM	6	0	1.0925
	3 MHz		QPSK	15	0	2.7043
			16-QAM	15	0	2.6936
	5 MHz		QPSK	25	0	4.4998
			16-QAM	25	0	4.4962
	10 MHz		QPSK	50	0	8.9592
			16-QAM	50	0	8.9405

- Plots of the EUT's Occupied Bandwidth are shown Page 28 ~ 31.

8.4 CONDUCTED SPURIOUS EMISSIONS

■ FACTORS FOR FREQUENCY

Frequency Range (GHz)	Factor [dB]
0.03 – 1	27.145
1 – 5	26.960
5 – 10	27.542
10 – 15	28.439
15 – 20	29.144
Above 20	30.148

NOTES:

Factor(dB) = Cable Loss + Attenuator + Power Splitter

Band	Band Width (MHz)	Frequency (MHz)	Frequency of Maximum Harmonic (GHz)	Factor (dB)	Measurement Maximum Data (dBm)	Result (dBm)	Limit (dBm)
5	1.4	824.7	3.17477	26.960	-58.11	-31.150	-13.00
		836.5	3.69065	26.960	-58.16	-31.204	
		848.3	3.69885	26.960	-58.77	-31.805	
	3	825.5	3.67400	26.960	-59.12	-32.160	
		836.5	6.20025	27.542	-58.85	-31.308	
		847.5	5.03450	27.542	-58.56	-31.018	
	5	826.5	2.75281	26.960	-58.25	-31.290	
		836.5	3.69885	26.960	-58.38	-31.423	
		846.5	2.70784	26.960	-59.37	-32.412	
	10	829.0	3.24708	26.960	-57.91	-30.954	
		836.5	5.94475	27.542	-59.02	-31.482	
		844.0	3.01349	26.960	-58.55	-31.590	

NOTES:

1. Conducted Spurious Emissions was Tested QPSK Modulation, Resource Block Size 1 and Resource Block Offset 0
2. Result (dBm) = Measurement Maximum Data (dBm) + Factor (dB)

- Plots of the EUT's Conducted Spurious Emissions are shown Page 44 ~ 55.

8.4.1 BAND EDGE

- Plots of the EUT's Band Edge are shown Page 32 ~ 13.

8.5 FREQUENCY STABILITY / VARIATION OF AMBIENT TEMPERATURE

8.5.1 FREQUENCY STABILITY (1.4 MHz Band 5 LTE)

- ▣ OPERATING FREQUENCY: 836,500,000 Hz
- ▣ CHANNEL: 20525 (1.4 MHz)
- ▣ REFERENCE VOLTAGE: 3.85 VDC
- ▣ DEVIATION LIMIT: ± 0.000 25 % or 2.5 ppm

Voltage (%)	Power (VDC)	Temp. (°C)	Frequency (Hz)	Frequency Error (Hz)	Deviation (%)	ppm
100%	3.85	+20(Ref)	836 499 996	0.0	0.000 000	0.000
100%		-30	836 499 990	-6.0	-0.000 001	-0.007
100%		-20	836 499 999	2.9	0.000 000	0.003
100%		-10	836 499 993	-3.0	0.000 000	-0.004
100%		0	836 499 991	-5.2	-0.000 001	-0.006
100%		+10	836 499 993	-2.7	0.000 000	-0.003
100%		+30	836 499 994	-2.1	0.000 000	-0.003
100%		+40	836 499 993	-3.4	0.000 000	-0.004
100%		+50	836 499 991	-5.3	-0.000 001	-0.006
Batt. Endpoint		3.60	+20	836 499 994	-2.4	0.000 000

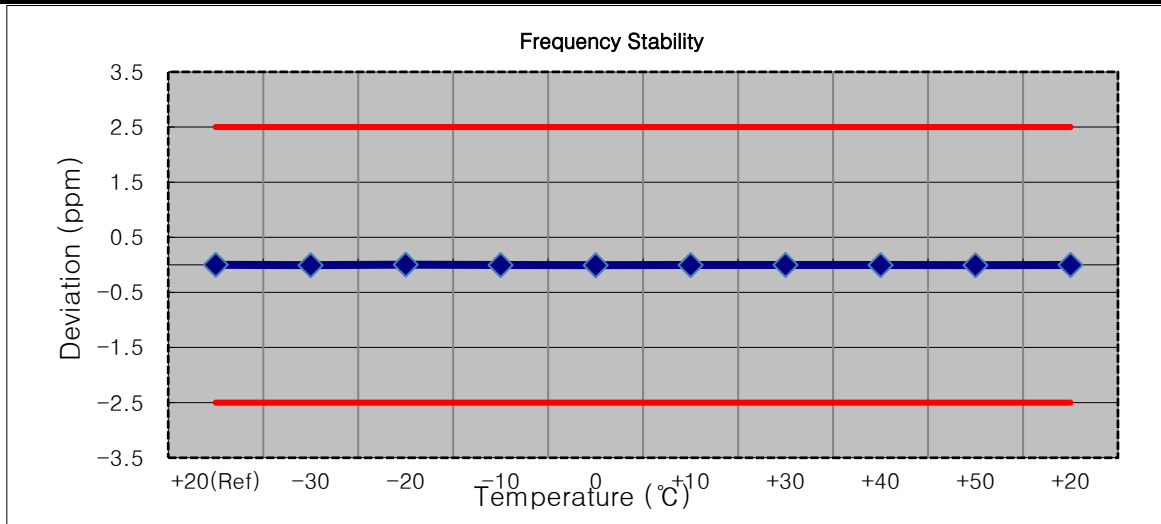

8.5.2 FREQUENCY STABILITY (3 MHz Band 5 LTE)

- ▣ OPERATING FREQUENCY: 836,500,000 Hz
- ▣ CHANNEL: 20525 (3 MHz)
- ▣ REFERENCE VOLTAGE: 3.85 VDC
- ▣ DEVIATION LIMIT: ± 0.000 25 % or 2.5 ppm

Voltage (%)	Power (VDC)	Temp. (°C)	Frequency (Hz)	Frequency Error (Hz)	Deviation (%)	ppm
100%	3.85	+20(Ref)	836 499 996	0.0	0.000 000	0.000
100%		-30	836 499 993	-3.3	0.000 000	-0.004
100%		-20	836 499 992	-4.1	0.000 000	-0.005
100%		-10	836 499 998	1.6	0.000 000	0.002
100%		0	836 499 991	-5.2	-0.000 001	-0.006
100%		+10	836 499 994	-2.2	0.000 000	-0.003
100%		+30	836 499 991	-4.8	-0.000 001	-0.006
100%		+40	836 500 001	4.3	0.000 001	0.005
100%		+50	836 499 993	-3.6	0.000 000	-0.004
Batt. Endpoint		3.60	+20	836 499 992	-4.4	-0.000 001

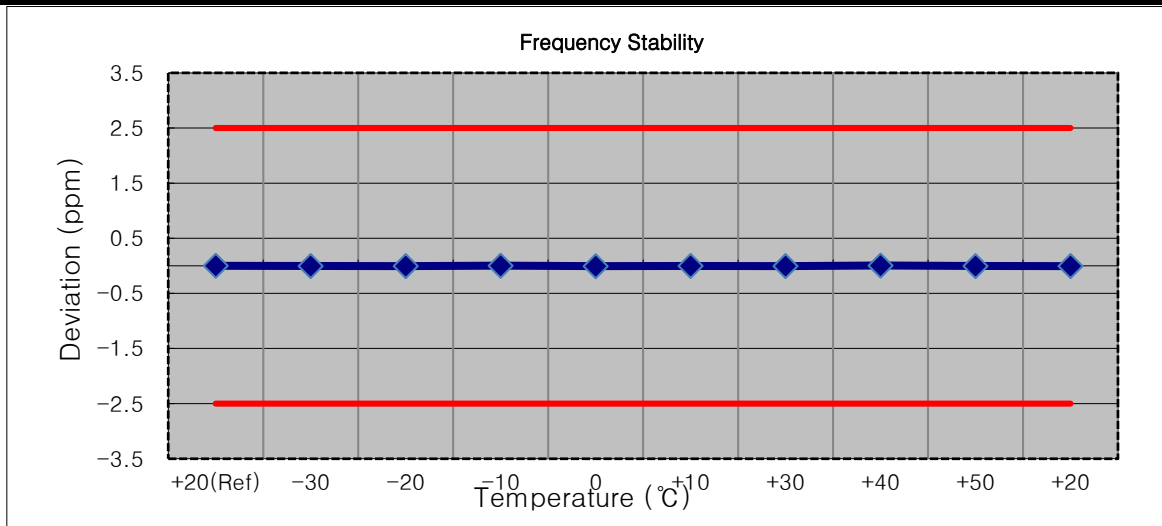

8.5.3 FREQUENCY STABILITY (5 MHz Band 5 LTE)

- ▣ OPERATING FREQUENCY: 836,500,000 Hz
- ▣ CHANNEL: 20525 (5 MHz)
- ▣ REFERENCE VOLTAGE: 3.85 VDC
- ▣ DEVIATION LIMIT: ± 0.000 25 % or 2.5 ppm

Voltage (%)	Power (VDC)	Temp. (°C)	Frequency (Hz)	Frequency Error (Hz)	Deviation (%)	ppm
100%	3.85	+20(Ref)	836 499 997	0.0	0.000 000	0.000
100%		-30	836 499 993	-4.2	-0.000 001	-0.005
100%		-20	836 499 995	-1.9	0.000 000	-0.002
100%		-10	836 499 994	-2.6	0.000 000	-0.003
100%		0	836 499 994	-2.7	0.000 000	-0.003
100%		+10	836 499 998	1.6	0.000 000	0.002
100%		+30	836 499 999	1.9	0.000 000	0.002
100%		+40	836 499 993	-3.5	0.000 000	-0.004
100%		+50	836 499 999	2.3	0.000 000	0.003
Batt. Endpoint		3.60	+20	836 499 993	-3.6	0.000 000

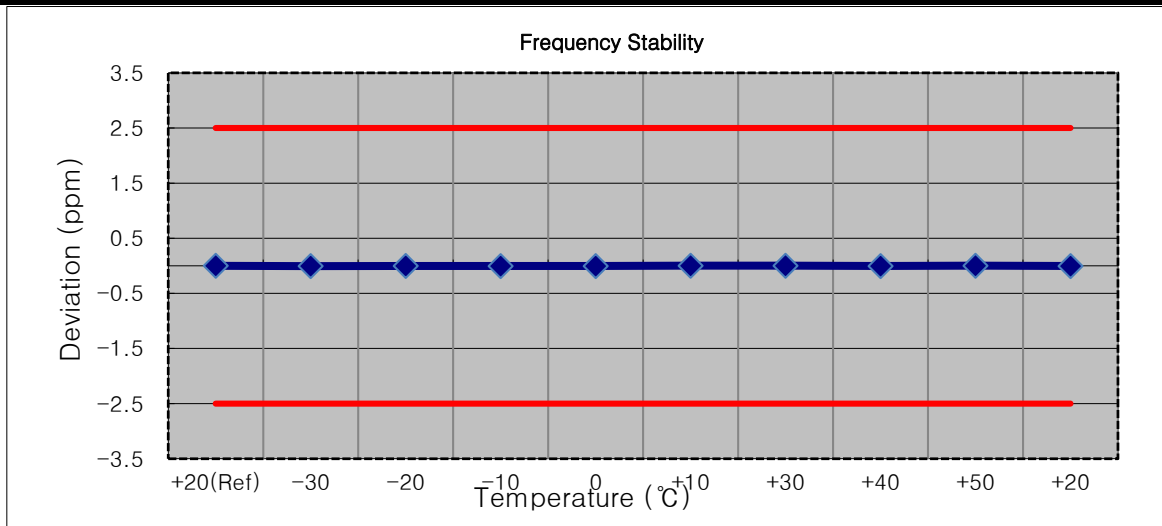

8.5.4 FREQUENCY STABILITY (10 MHz Band 5 LTE)

- ▣ OPERATING FREQUENCY: 836,500,000 Hz
- ▣ CHANNEL: 20525 (10 MHz)
- ▣ REFERENCE VOLTAGE: 3.85 VDC
- ▣ DEVIATION LIMIT: ± 0.000 25 % or 2.5 ppm

Voltage (%)	Power (VDC)	Temp. (°C)	Frequency (Hz)	Frequency Error (Hz)	Deviation (%)	ppm
100%	3.8	+20(Ref)	836 499 995	0.0	0.000 000	0.000
100%		-30	836 499 998	2.9	0.000 000	0.003
100%		-20	836 499 992	-3.2	0.000 000	-0.004
100%		-10	836 499 999	3.3	0.000 000	0.004
100%		0	836 499 992	-3.0	0.000 000	-0.004
100%		+10	836 499 991	-4.1	0.000 000	-0.005
100%		+30	836 499 992	-3.4	0.000 000	-0.004
100%		+40	836 499 991	-3.9	0.000 000	-0.005
100%		+50	836 499 993	-2.5	0.000 000	-0.003
Batt. Endpoint		3.60	+20	836 499 993	-2.2	0.000 000

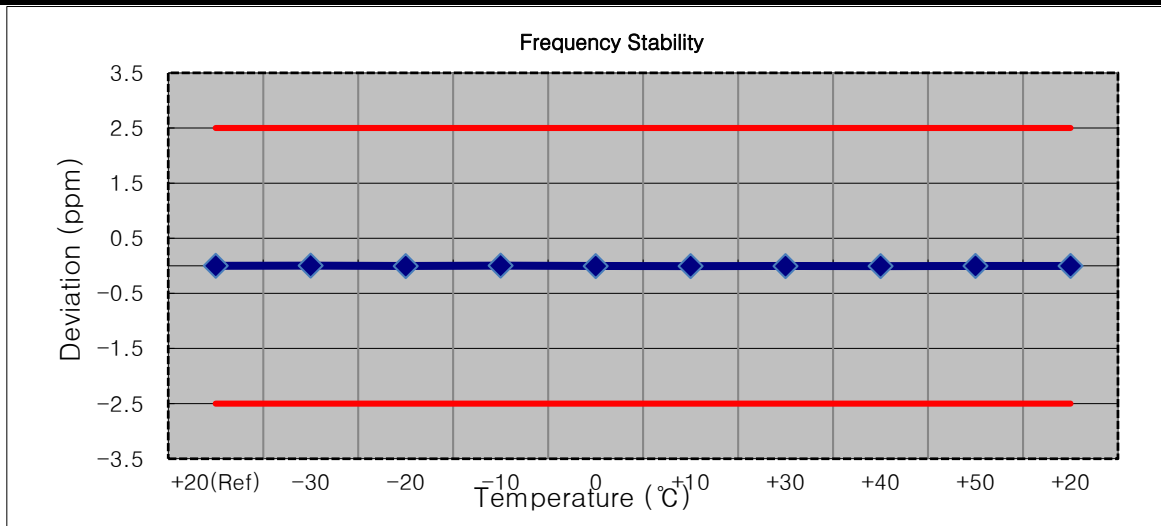

9. TEST PLOTS

BAND 5. Occupied Bandwidth Plot (1.4M BW Ch.20525 QPSK_RB6_0)

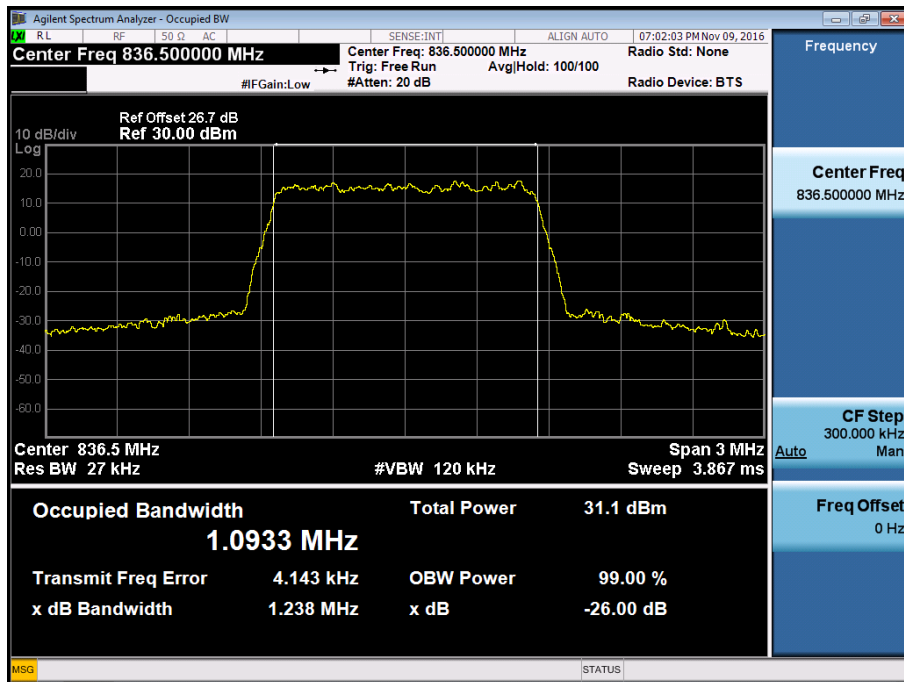

BAND 5. Occupied Bandwidth Plot (1.4M BW Ch.20525 16QAM_RB6_0)

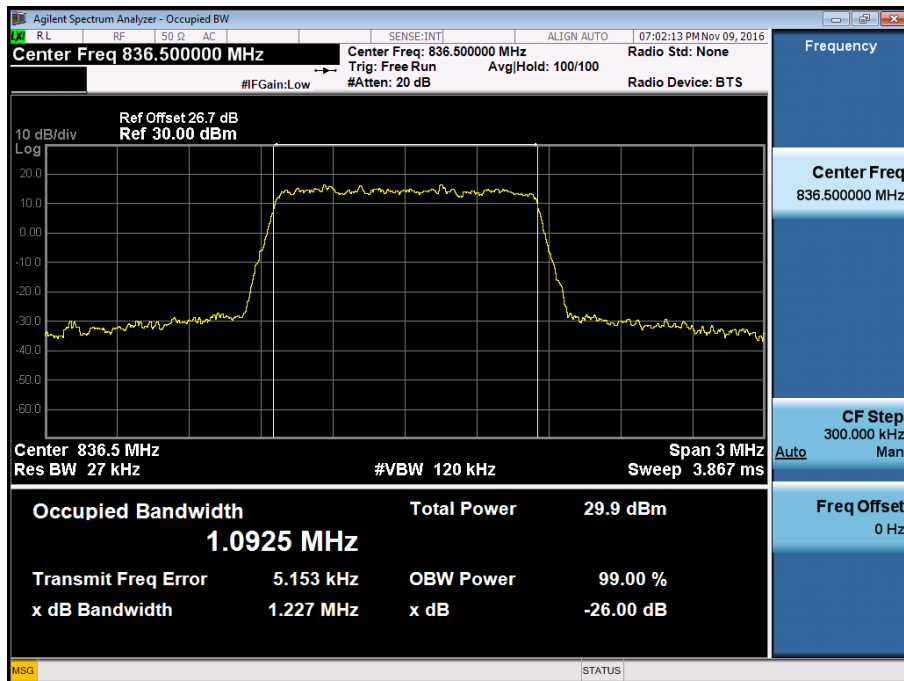

BAND 5. Occupied Bandwidth Plot (3M BW Ch.20525 QPSK_RB15_0)

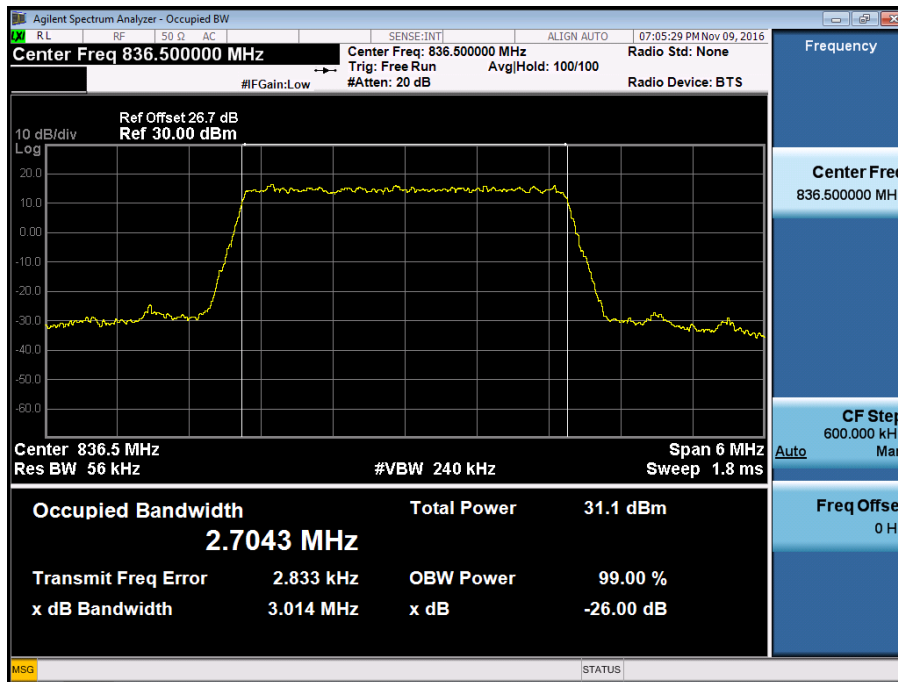

BAND 5. Occupied Bandwidth Plot (3M BW Ch.20525 16QAM_RB15_0)

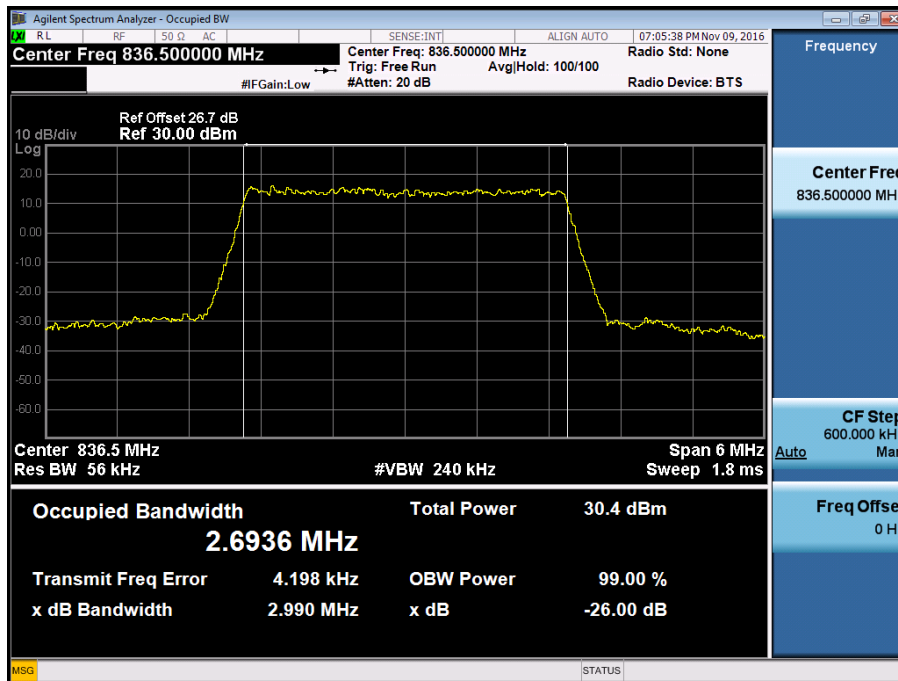

BAND 5. Occupied Bandwidth Plot (5M BW Ch.20525 QPSK_RB25_0)

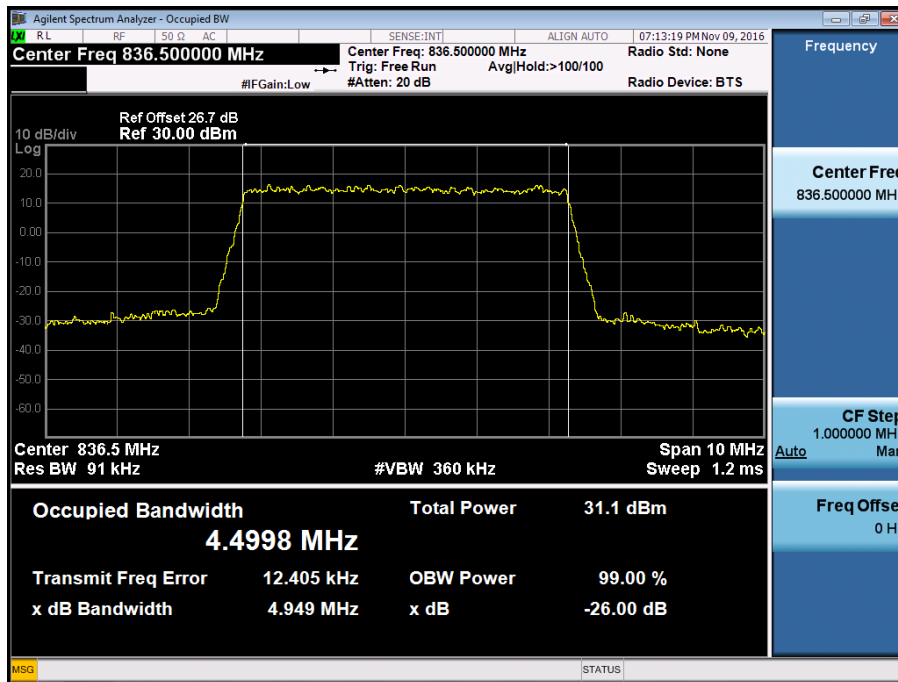

BAND 5. Occupied Bandwidth Plot (5M BW Ch.20525 16QAM_RB25_0)

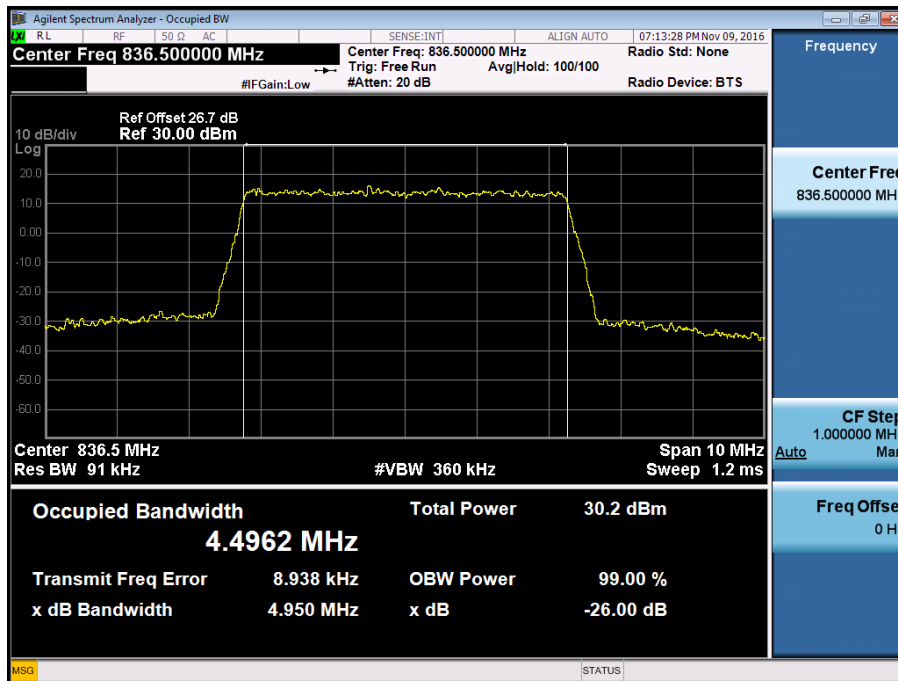

BAND 5. Occupied Bandwidth Plot (10M BW Ch.20525 QPSK_RB50_0)

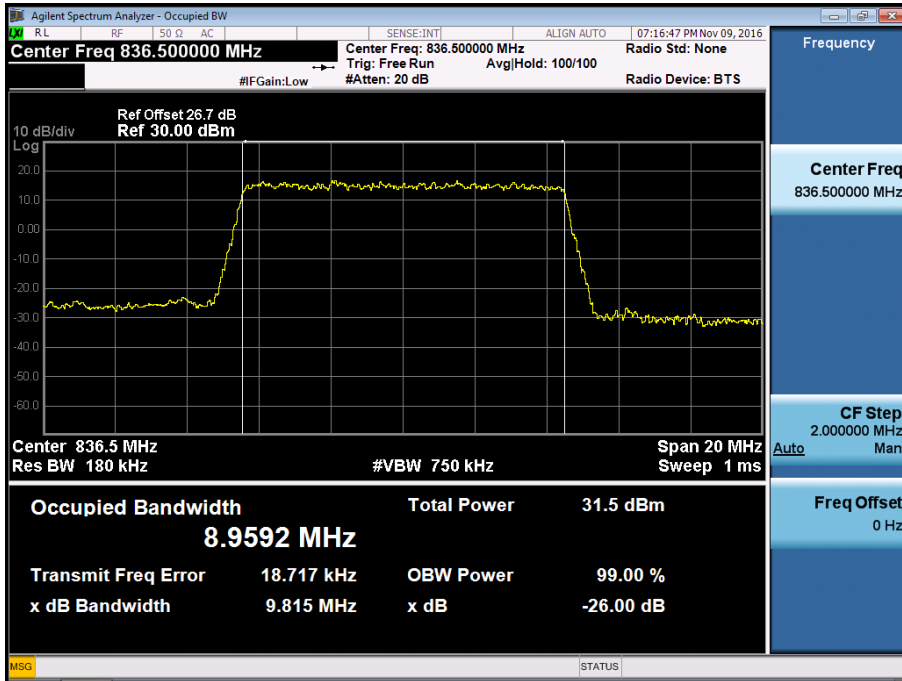

BAND 5. Occupied Bandwidth Plot (10M BW Ch.20525 16QAM_RB50_0)

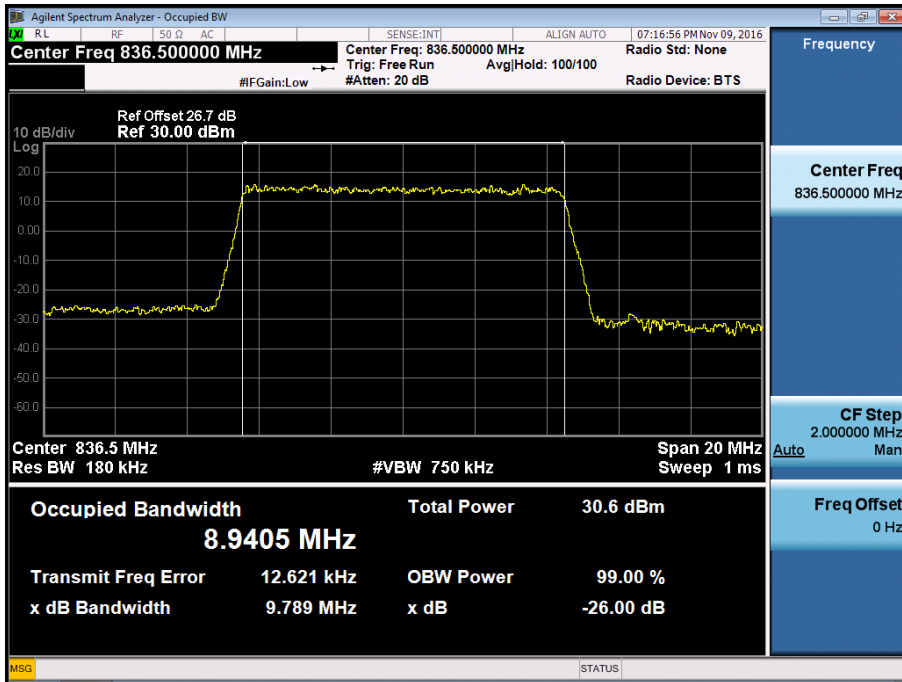

BAND 5. Lower Band Edge Plot (1.4M BW Ch.20407 QPSK_RB1_Offset 0)

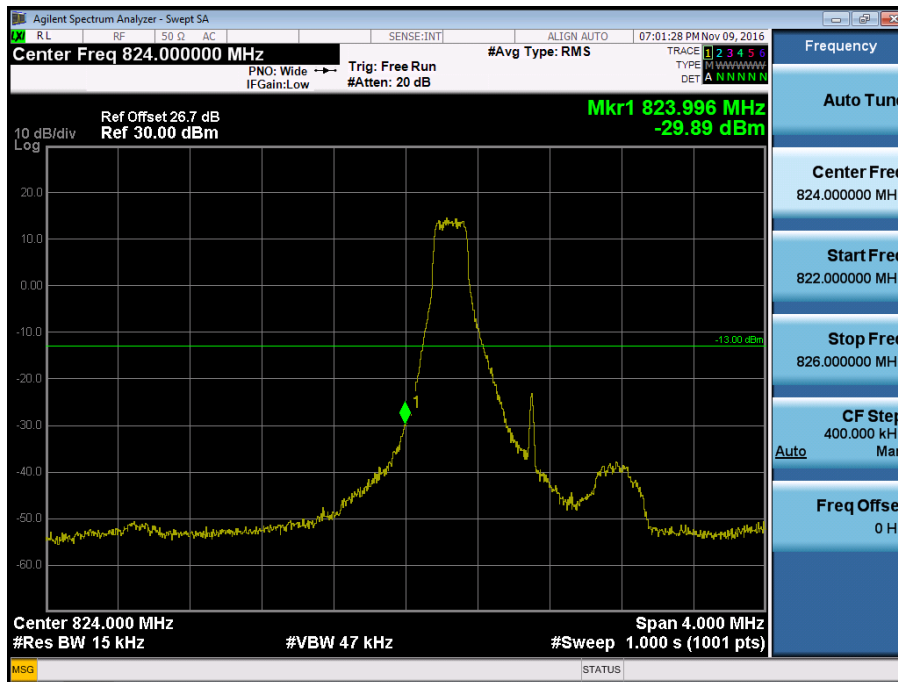

BAND 5. Lower Band Edge Plot (1.4M BW Ch.20407 QPSK_RB6_Offset 0)

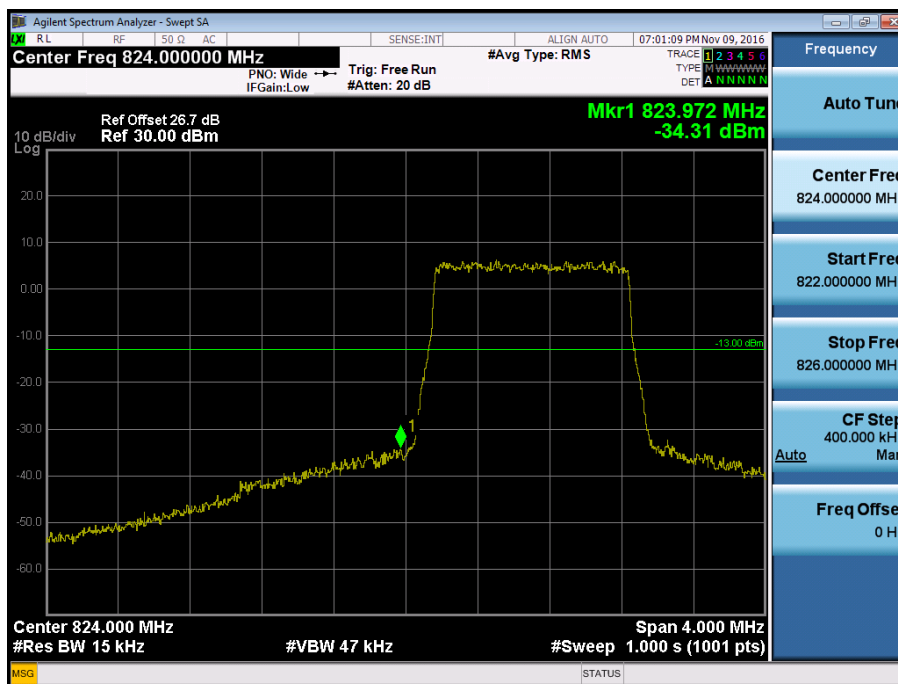

BAND 5. Lower Extended Band Edge Plot (1.4M BW Ch.20407 QPSK_RB6_0)

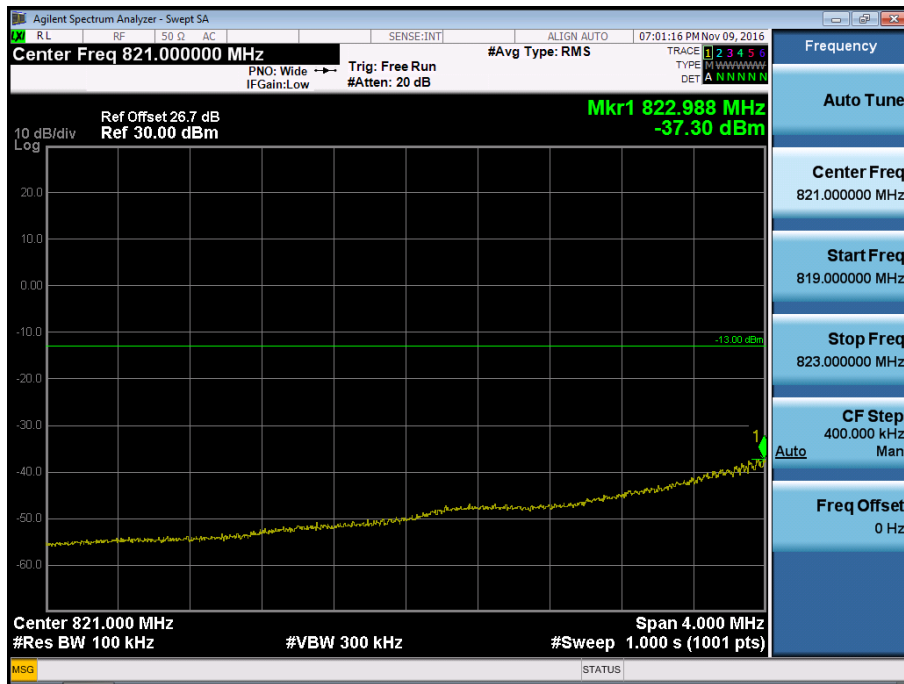

BAND 5. Lower Band Edge Plot (3M BW Ch.20415 QPSK_RB1_Offset 0)

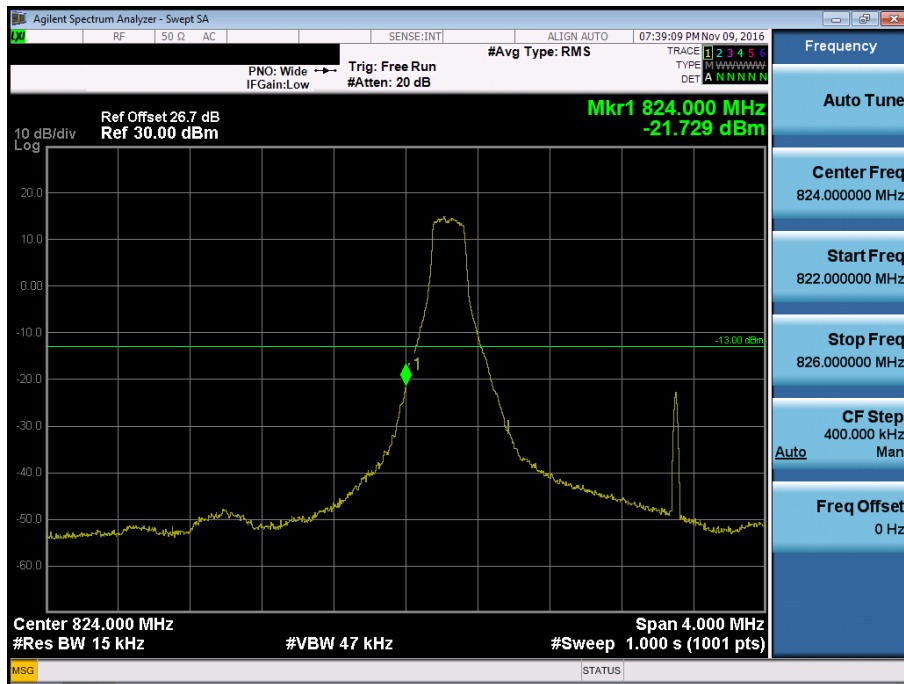

BAND 5. Lower Band Edge Plot (3M BW Ch.20415 QPSK_RB15_Offset 0)



BAND 5. Lower Extended Band Edge Plot (3M BW Ch.20415 QPSK_RB15_0)



BAND 5. Lower Band Edge Plot (5M BW Ch.20425 QPSK_RB1_Offset 0)

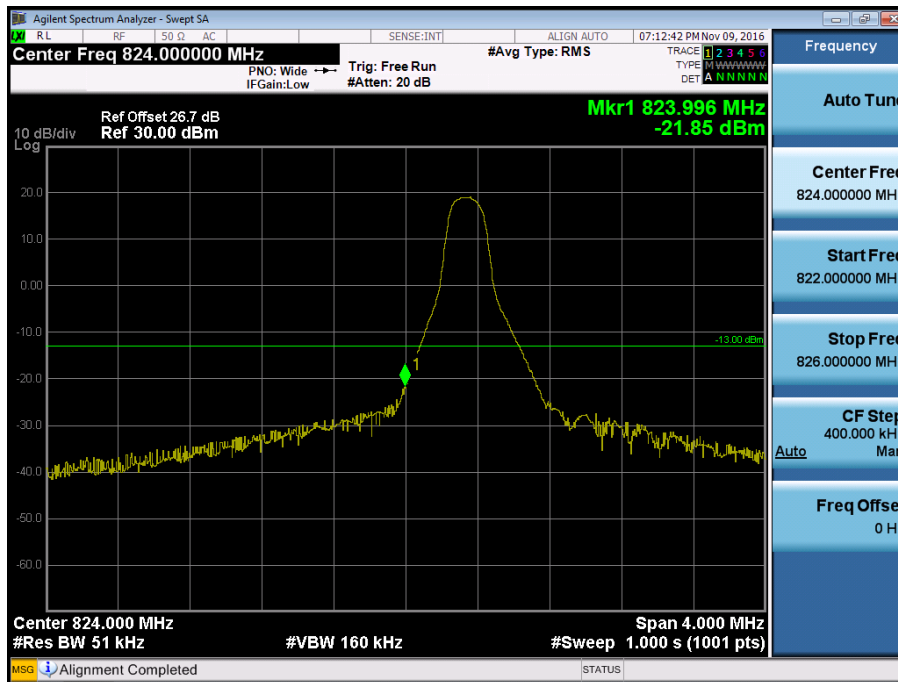

BAND 5. Lower Band Edge Plot (5M BW Ch.20425 QPSK_RB25_Offset 0)

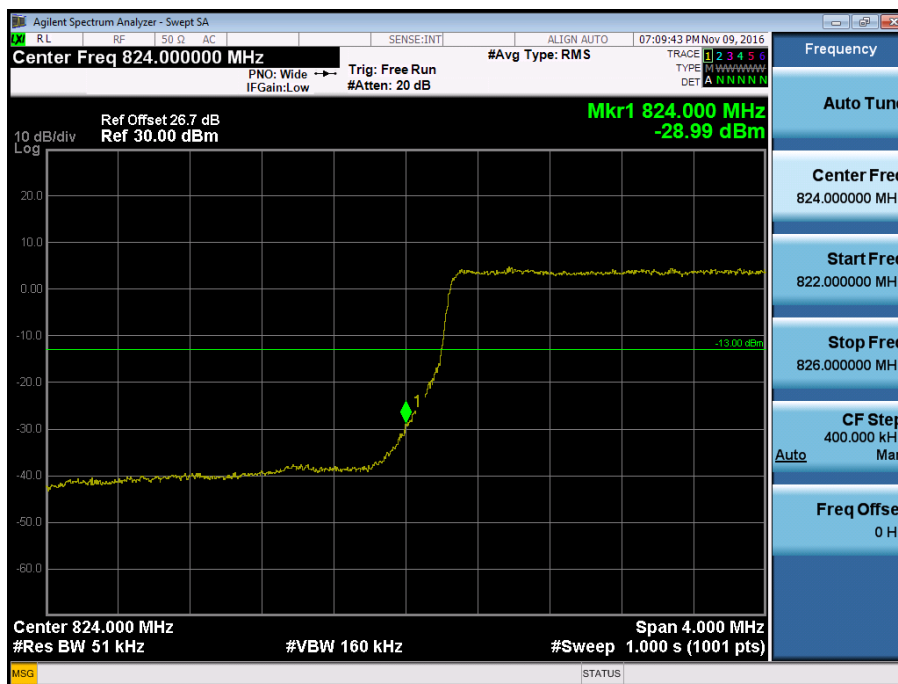

BAND 5. Lower Extended Band Edge Plot (5M BW Ch.20425 QPSK_RB25_0)

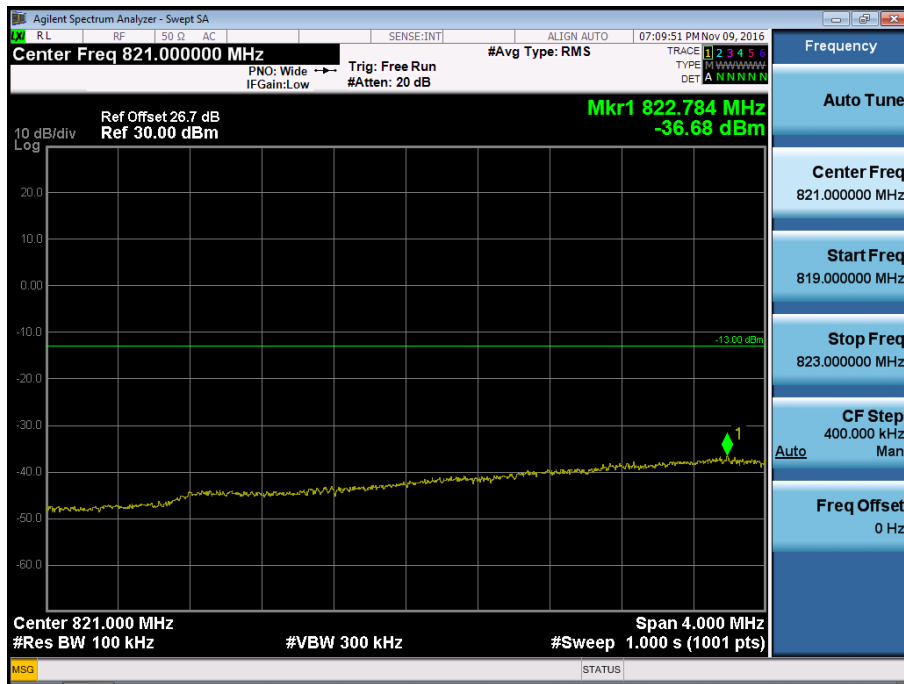

BAND 5. Lower Band Edge Plot (10M BW Ch.20450 QPSK_RB1_Offset 0)

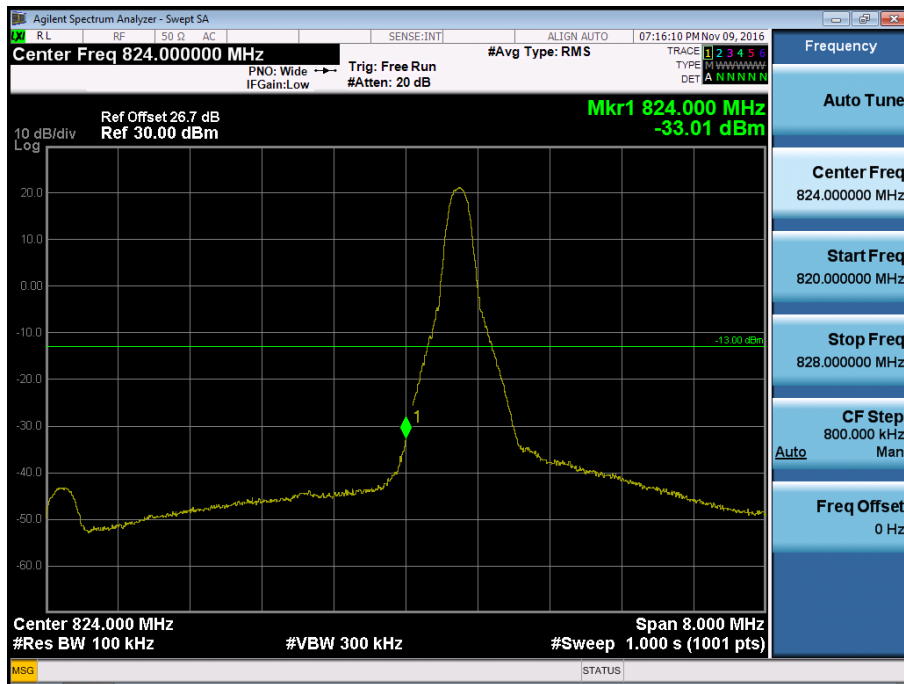

BAND 5. Lower Band Edge Plot (10M BW Ch.20450 QPSK_RB50_Offset 0)

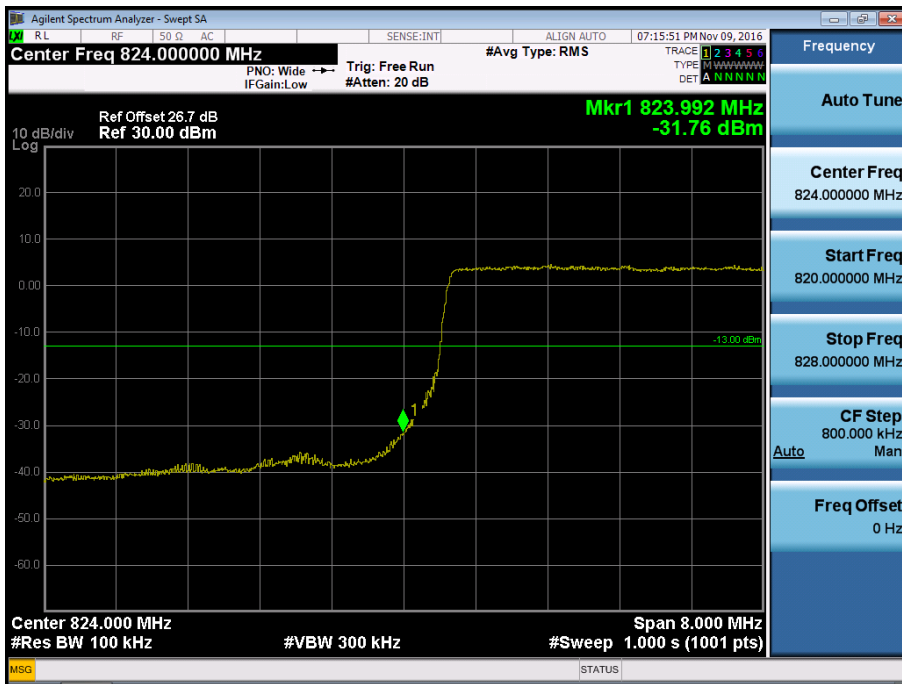

BAND 5. Lower Extended Band Edge Plot (10M BW Ch.20450 QPSK_RB50_0)



BAND 5. Upper Band Edge Plot (1.4M BW Ch.20643 QPSK_RB1_Offset 5)

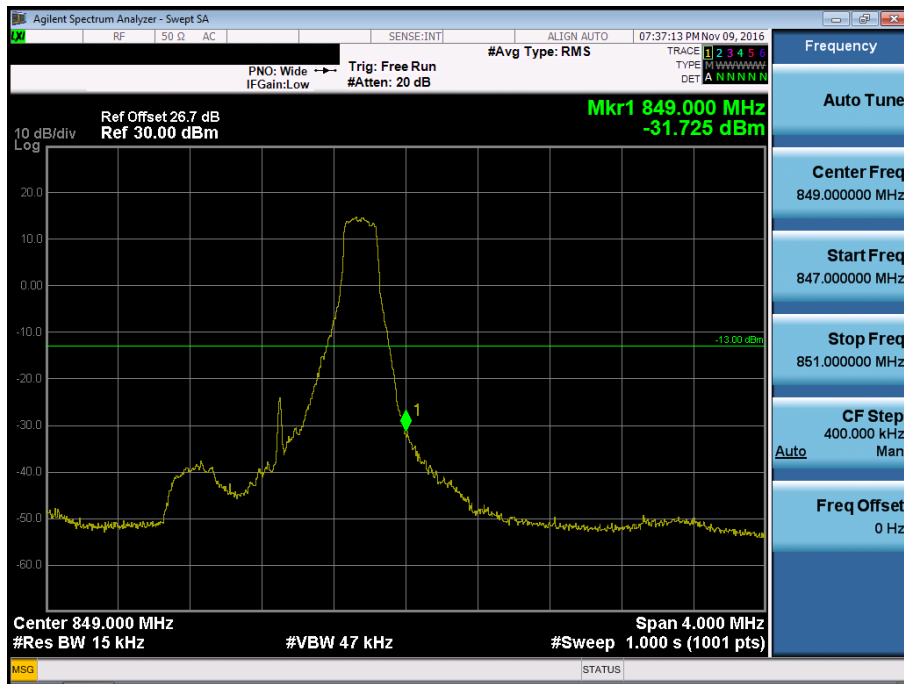

BAND 5. Upper Band Edge Plot (1.4M BW Ch.20643 QPSK_RB6_Offset 0)



BAND 5. Upper Extended Band Edge Plot (1.4M BW Ch.20643 QPSK_RB6_0)

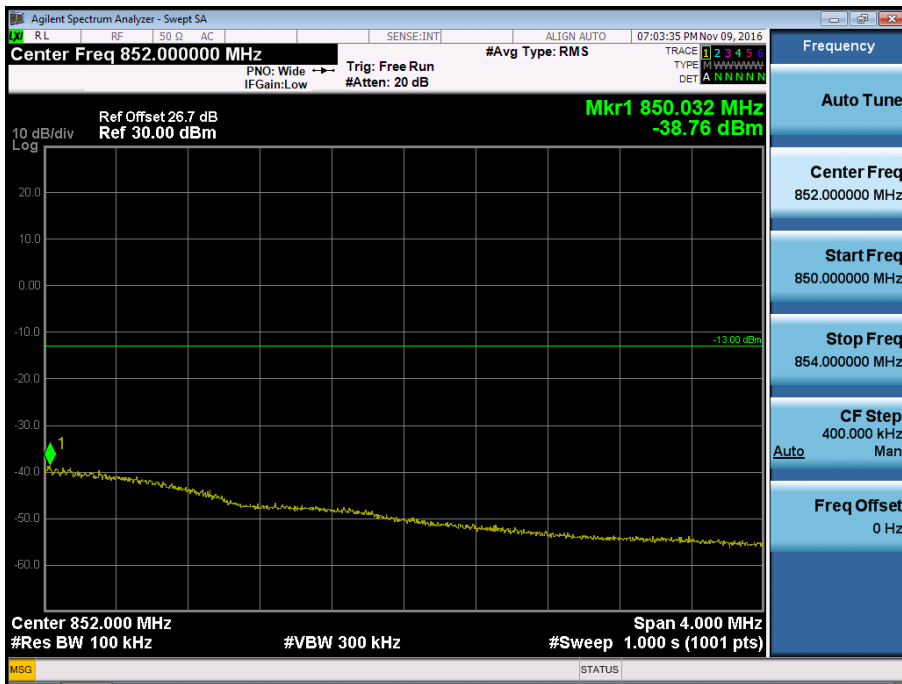

BAND 5. Upper Band Edge Plot (3M BW Ch.20635 QPSK_RB1_Offset 14)

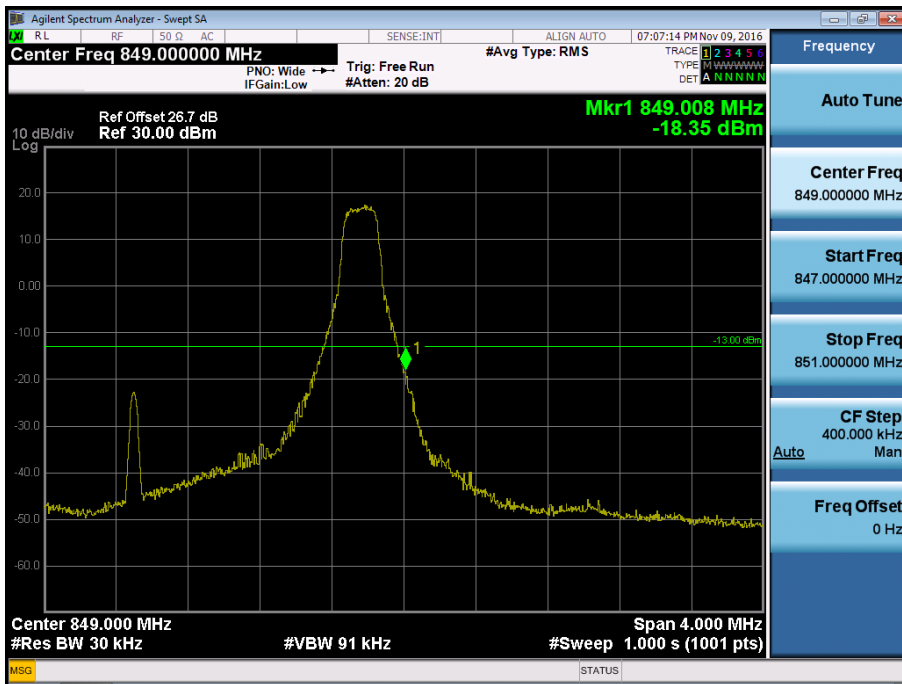

BAND 5. Upper Band Edge Plot (3M BW Ch.20635 QPSK_RB15_Offset 0)



BAND 5. Upper Extended Band Edge Plot (3M BW Ch.20635 QPSK_RB15_0)



BAND 5. Upper Band Edge Plot (5M BW Ch.20625 QPSK_RB1_Offset 24)

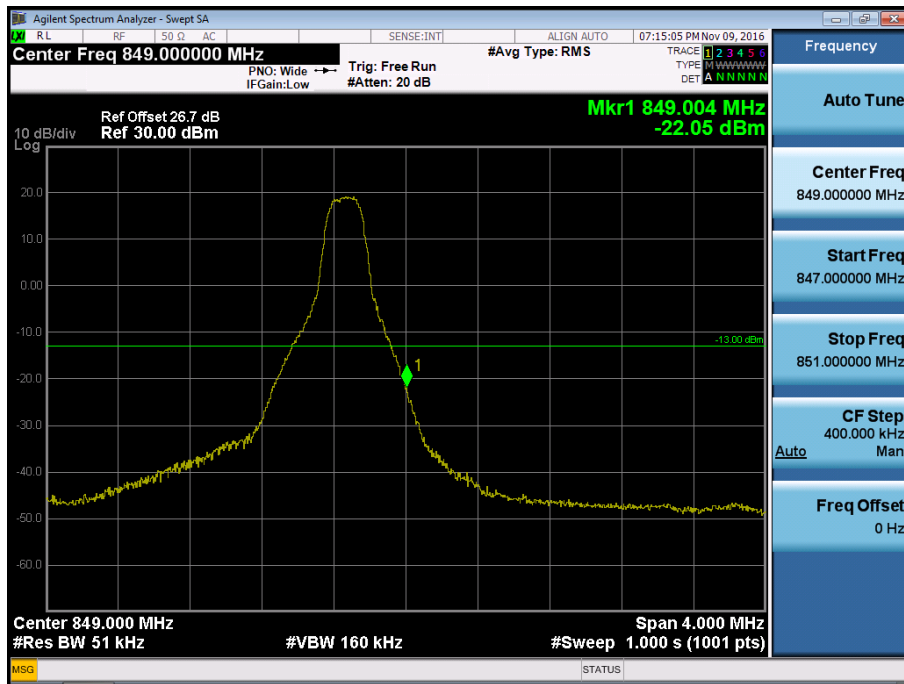

BAND 5. Upper Band Edge Plot (5M BW Ch.20625 QPSK_RB25_Offset 0)



BAND 5. Upper Extended Band Edge Plot (5M BW Ch.20625 QPSK_RB25_0)



BAND 5. Upper Band Edge Plot (10M BW Ch.20600 QPSK_RB1_Offset 49)

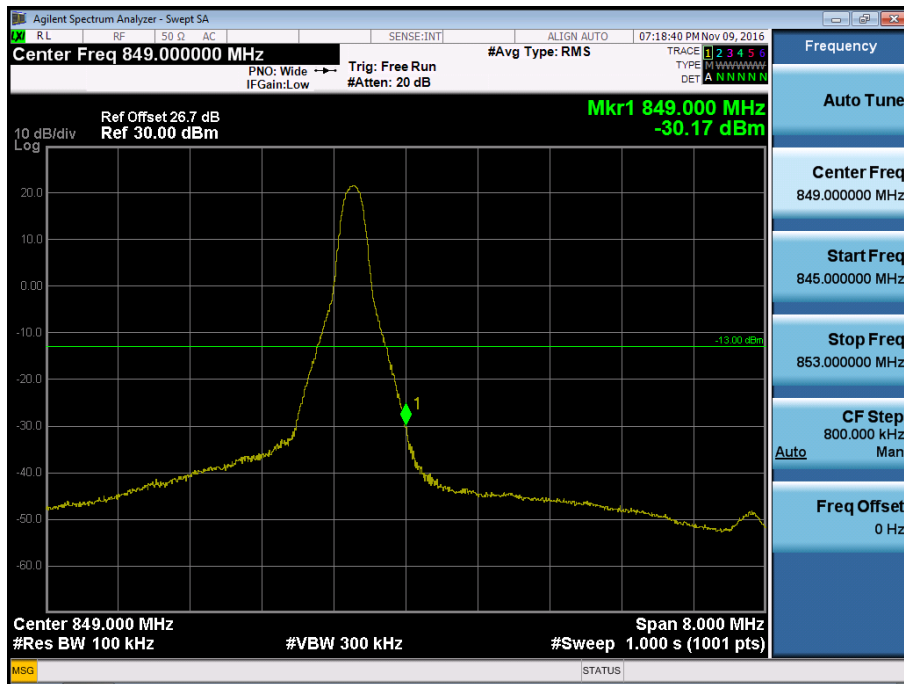

BAND 5. Upper Band Edge Plot (10M BW Ch.20600 QPSK_RB50_Offset 0)



BAND 5. Upper Extended Band Edge Plot (10M BW Ch.20600 QPSK_RB50_0)



BAND 5. Conducted Spurious Plot _1 (20525ch_1.4MHz_QPSK_RB 1_0)

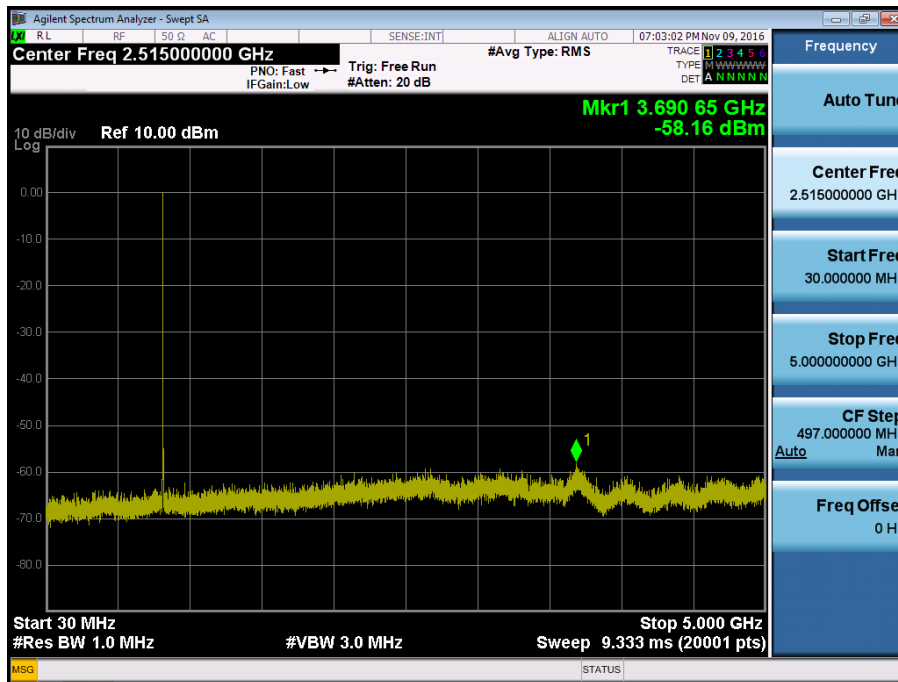

BAND 5. Conducted Spurious Plot _2 (20525ch_1.4MHz_QPSK_RB 1_0)

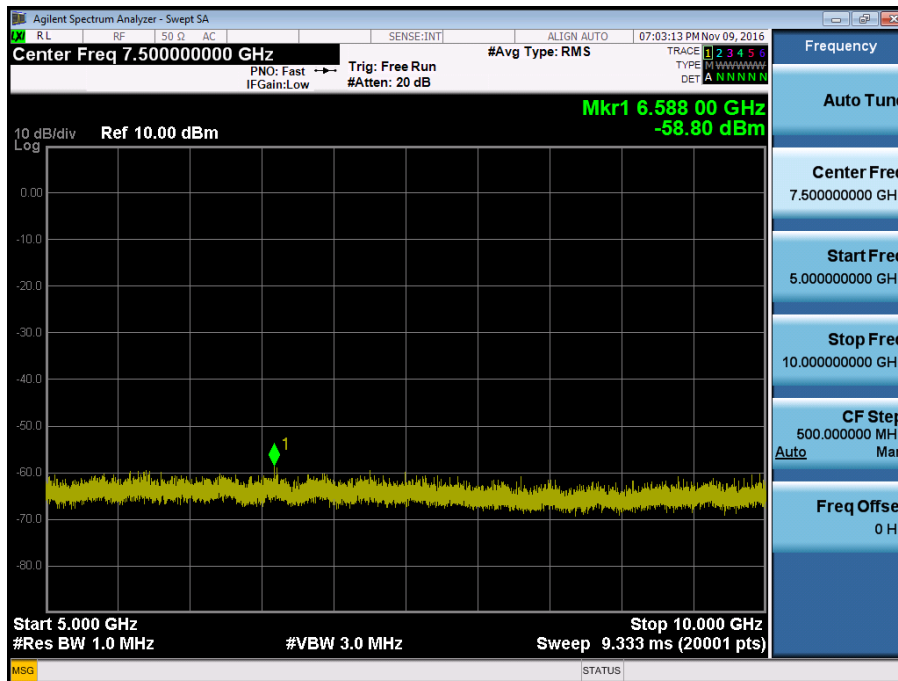

BAND 5. Conducted Spurious Plot _1 (20643ch_1.4MHz_QPSK_RB 1_0)

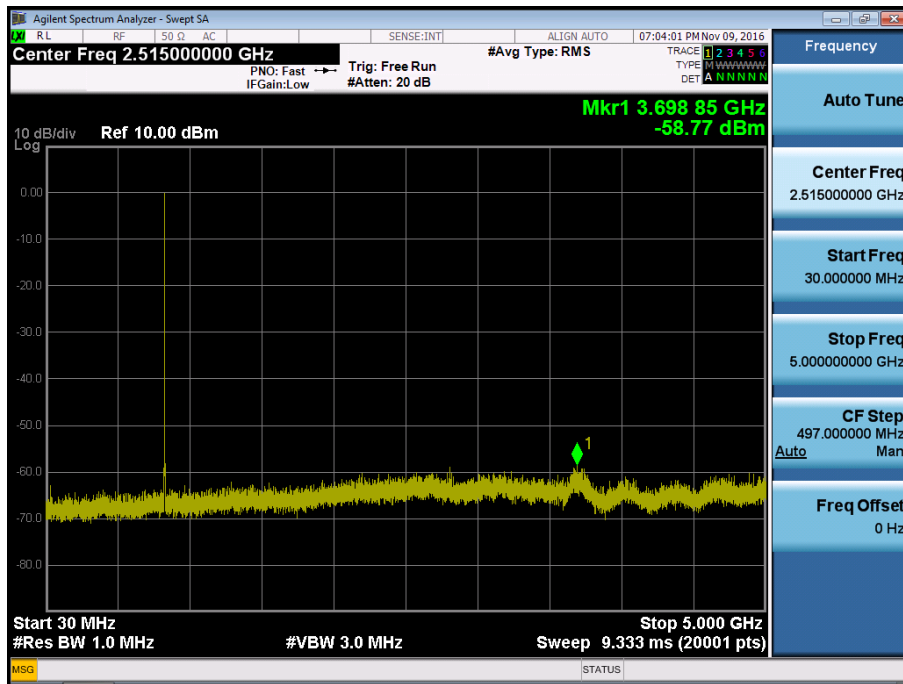

BAND 5. Conducted Spurious Plot _2 (20643ch_1.4MHz_QPSK_RB 1_0)

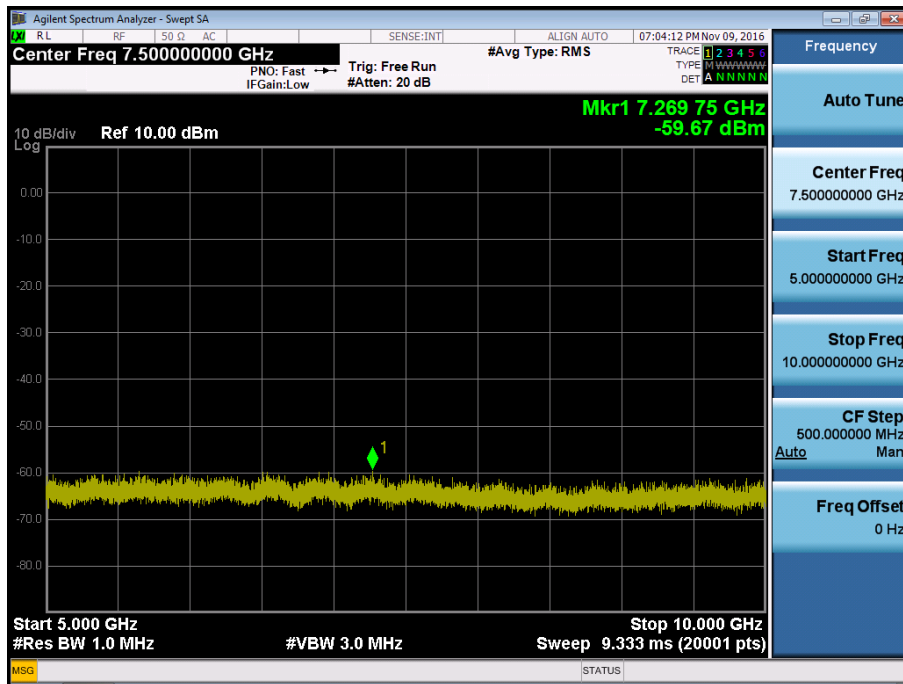

BAND 5. Conducted Spurious Plot _1 (20415ch_3MHz_QPSK_RB 1_0)

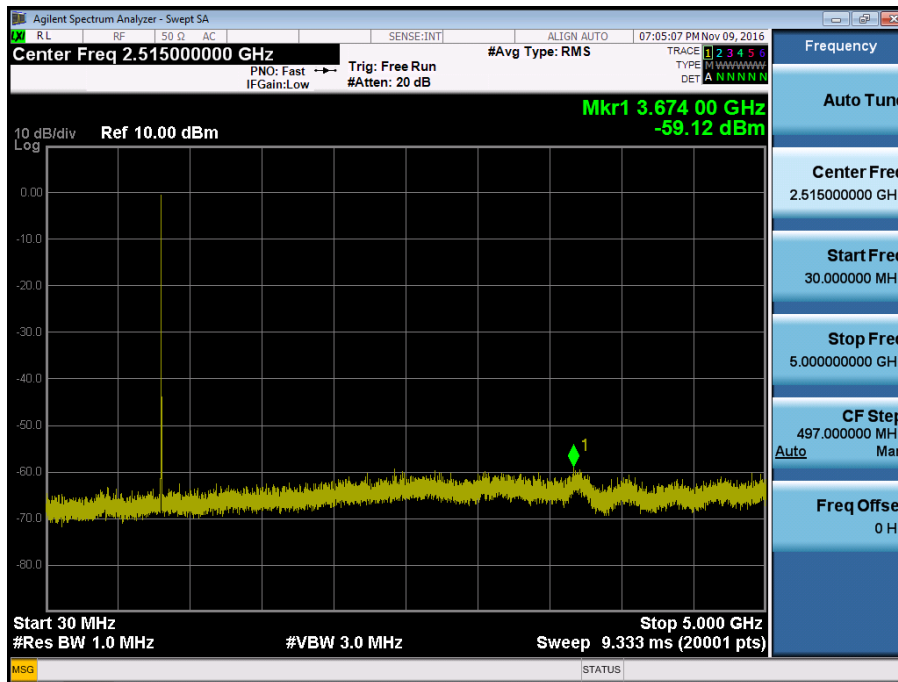

BAND 5. Conducted Spurious Plot _2 (20415ch_3MHz_QPSK_RB 1_0)

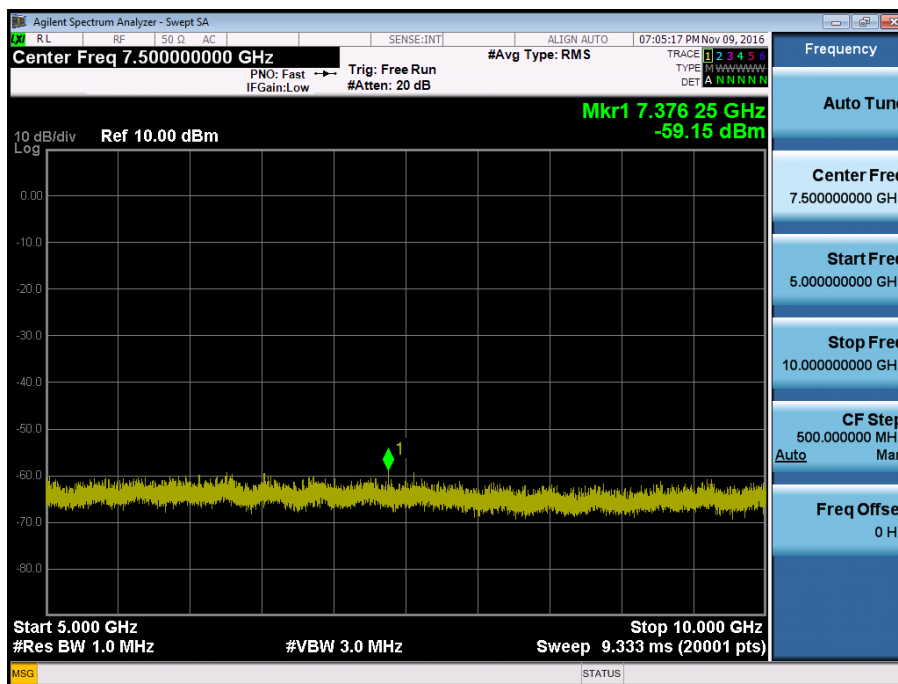

BAND 5. Conducted Spurious Plot _1 (20525ch_3MHz_QPSK_RB 1_0)

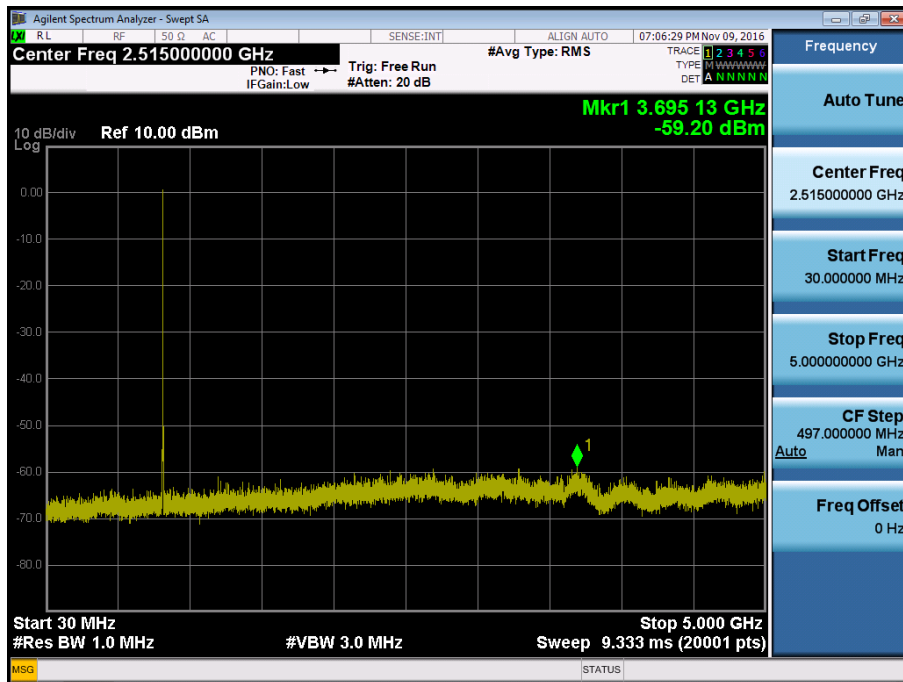

BAND 5. Conducted Spurious Plot _2 (20525ch_3MHz_QPSK_RB 1_0)

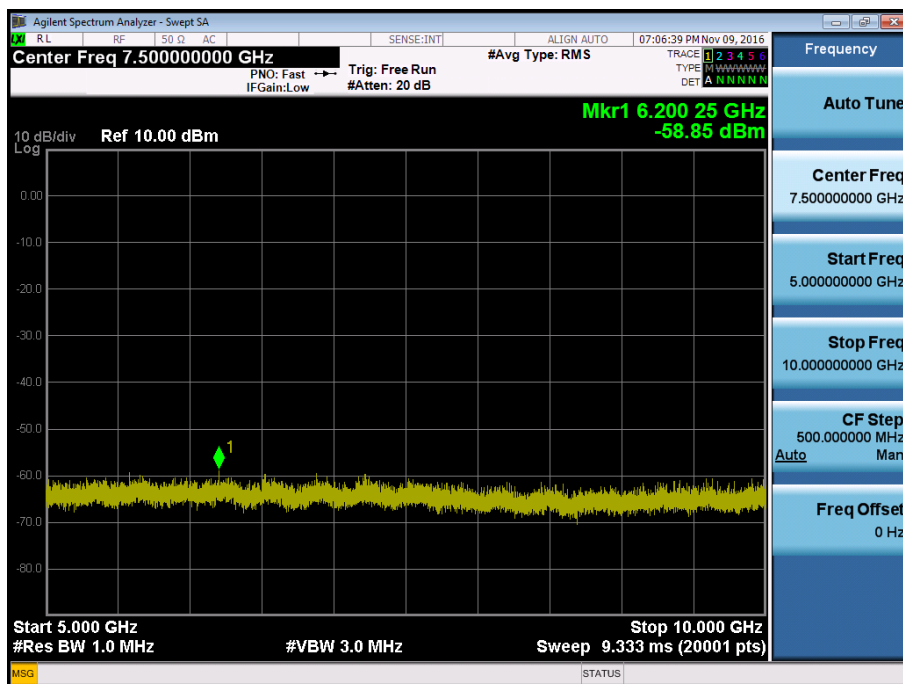

BAND 5. Conducted Spurious Plot _1 (20635ch_3MHz_QPSK_RB 1_0)

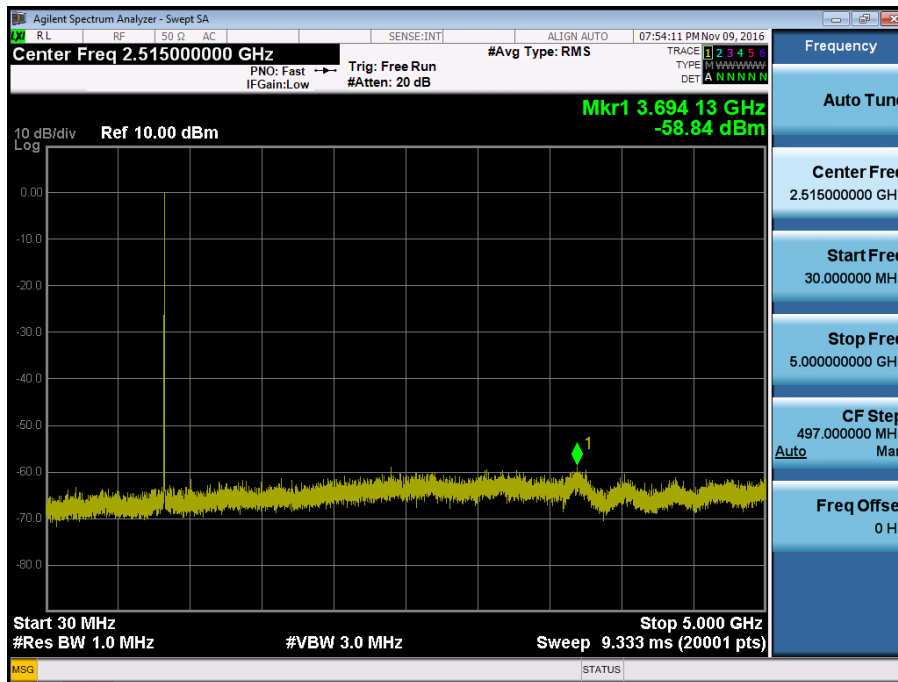

BAND 5. Conducted Spurious Plot _2 (20635ch_3MHz_QPSK_RB 1_0)

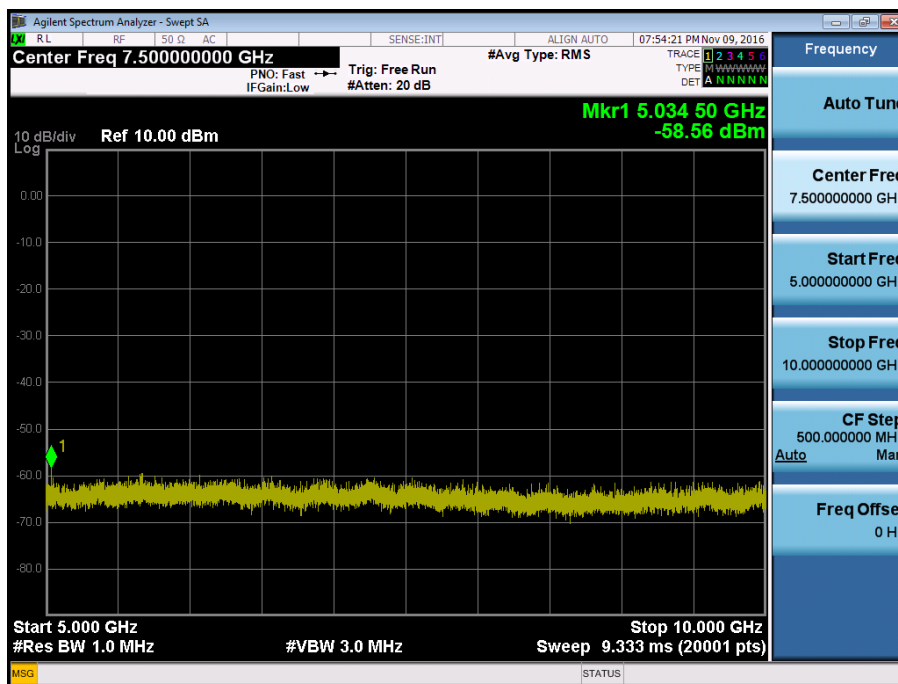

BAND 5. Conducted Spurious Plot _1 (20425ch_5MHz_QPSK_RB 1_0)

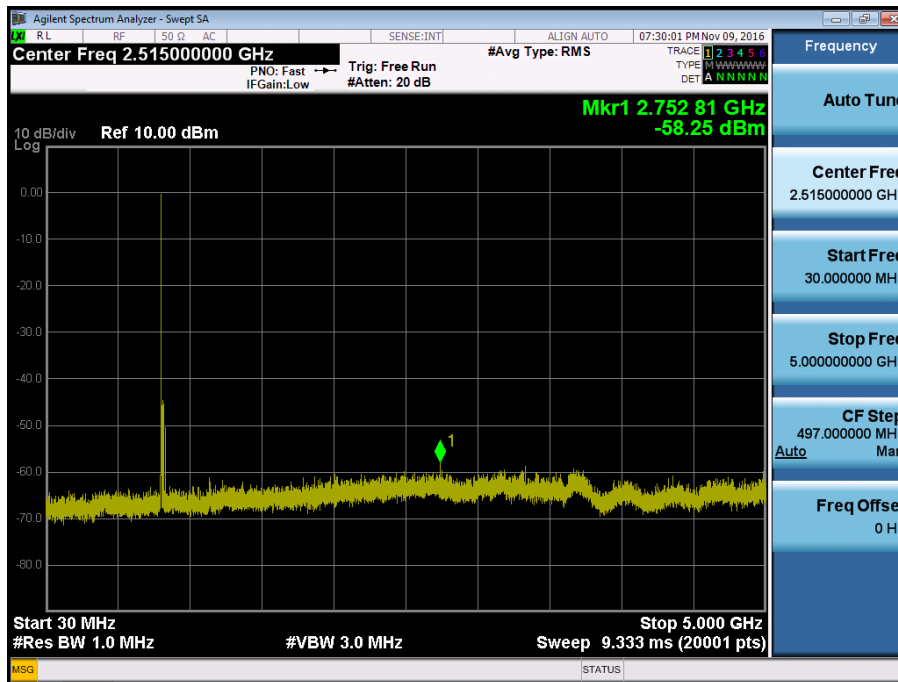

BAND 5. Conducted Spurious Plot _2 (20425ch_5MHz_QPSK_RB 1_0)

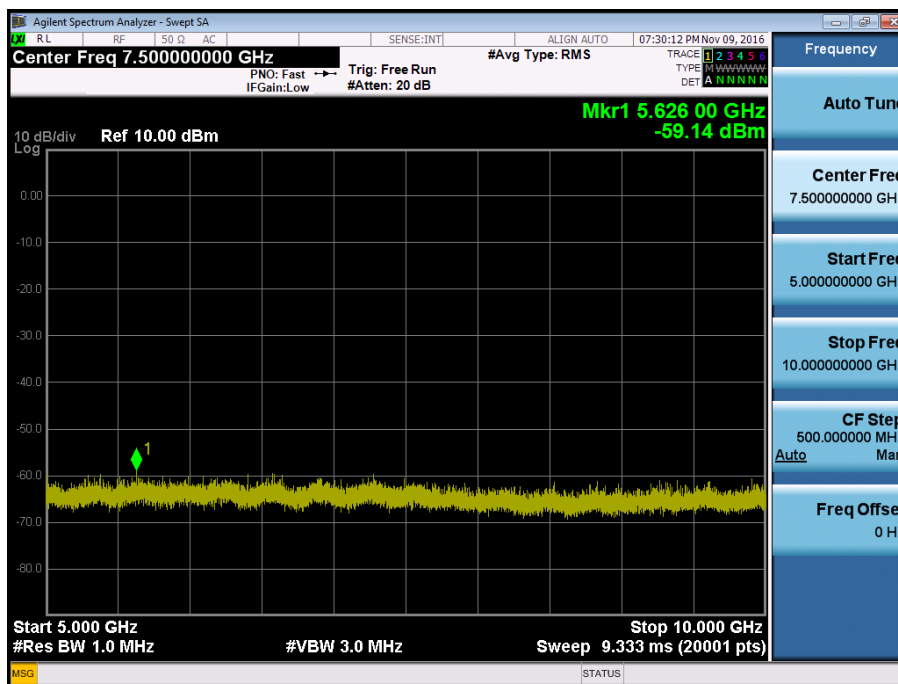

BAND 5. Conducted Spurious Plot _1 (20525ch_5MHz_QPSK_RB 1_0)

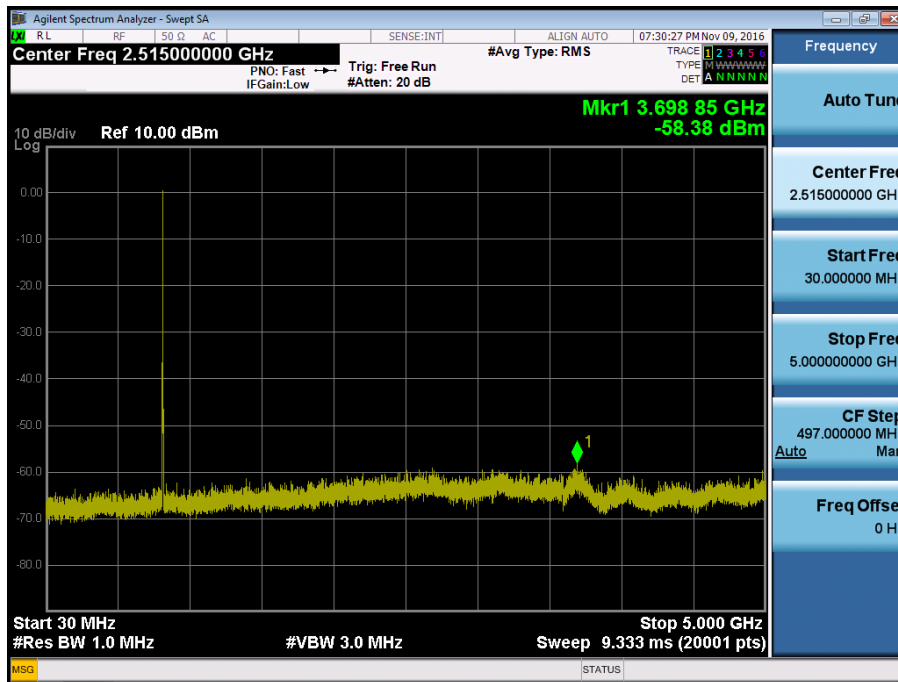

BAND 5. Conducted Spurious Plot _2 (20525ch_5MHz_QPSK_RB 1_0)

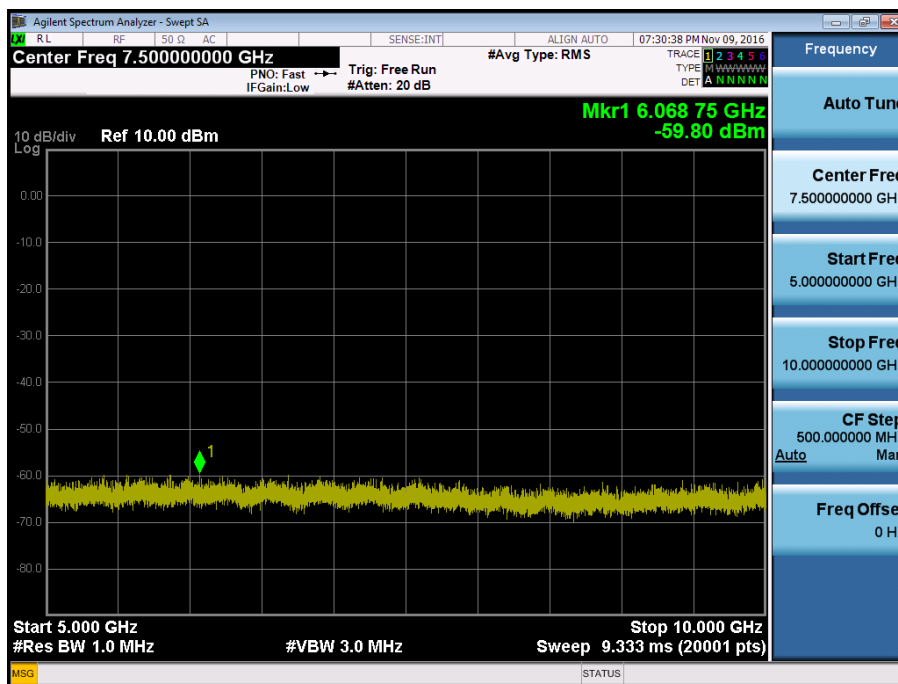

BAND 5. Conducted Spurious Plot _1 (20625ch_5MHz_QPSK_RB 1_0)

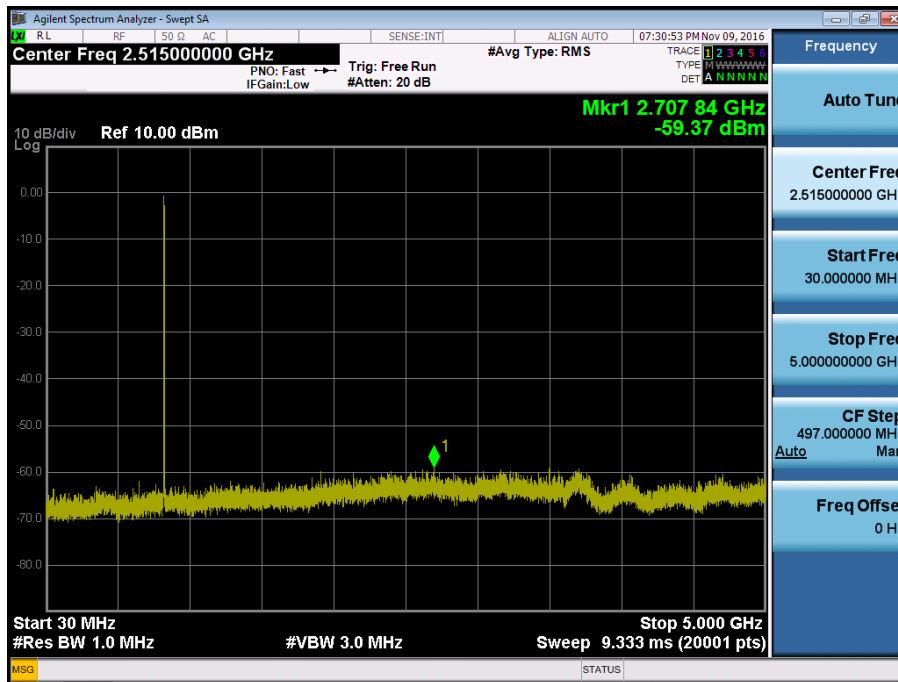

BAND 5. Conducted Spurious Plot _2 (20625ch_5MHz_QPSK_RB 1_0)

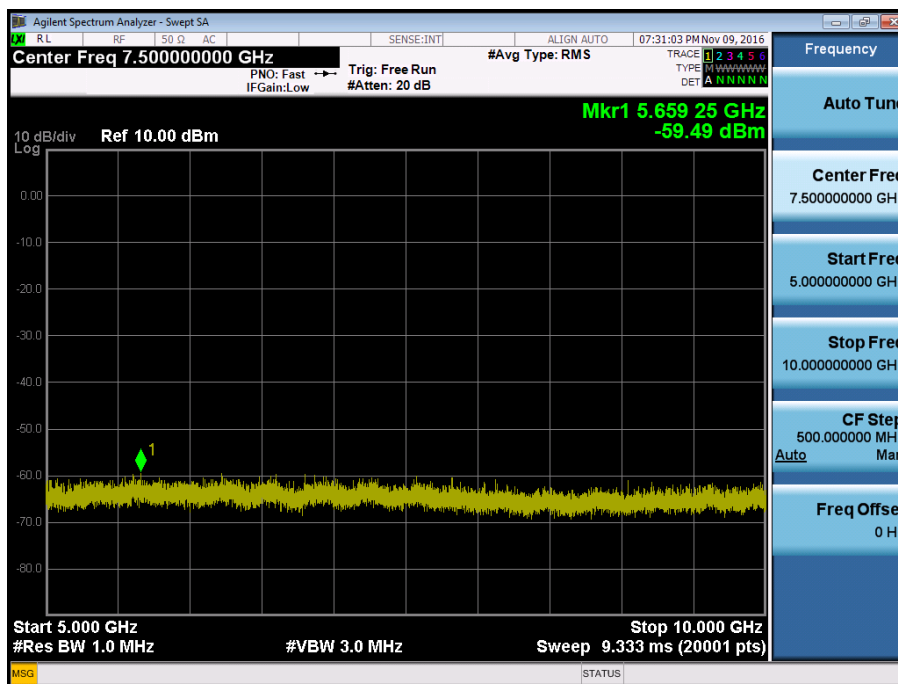

BAND 5. Conducted Spurious Plot _1 (20450ch_10MHz_QPSK_RB 1_0)

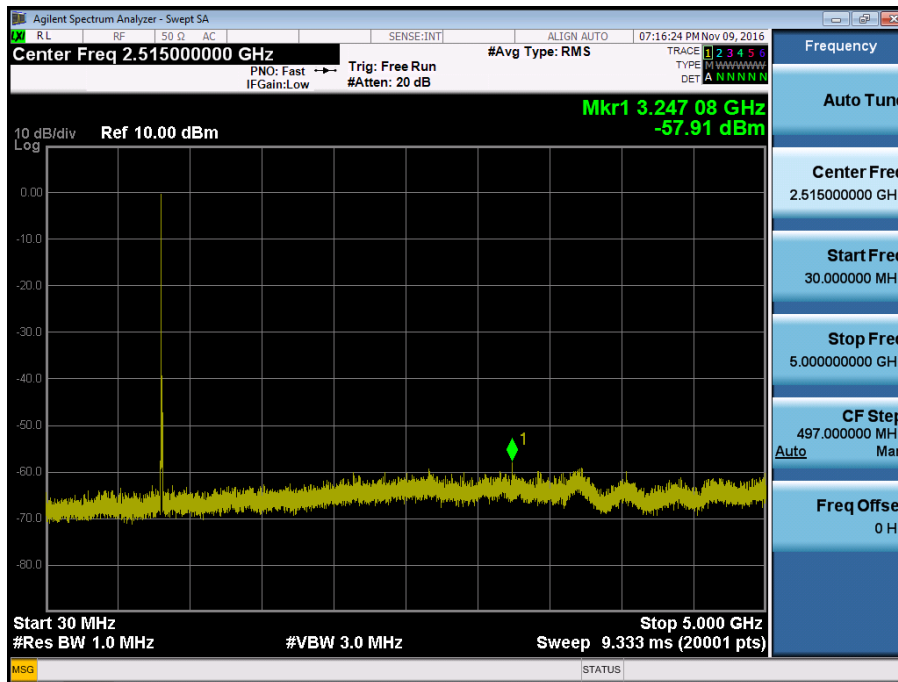

BAND 5. Conducted Spurious Plot _2 (20450ch_10MHz_QPSK_RB 1_0)

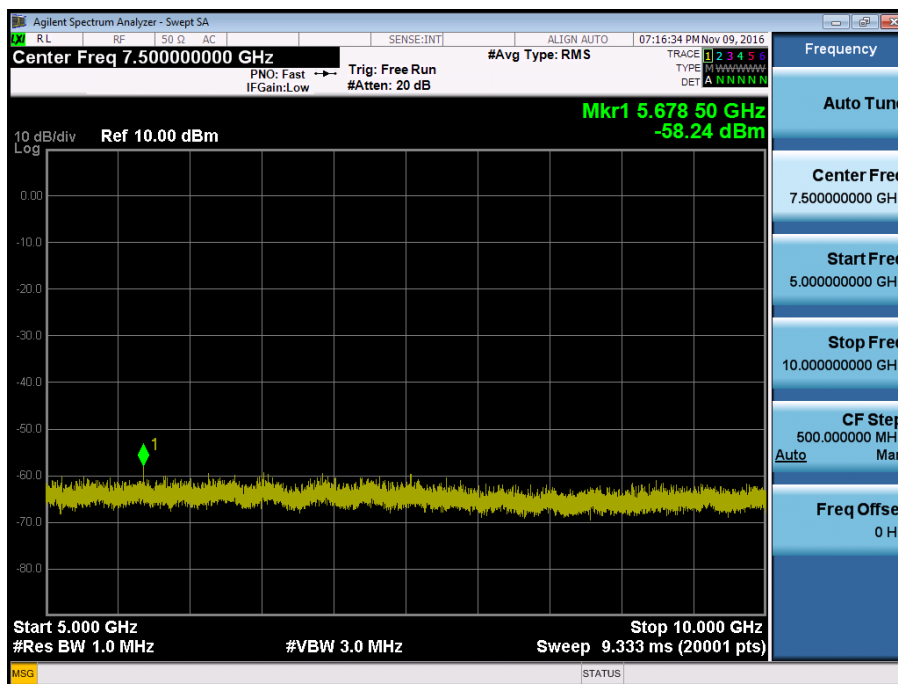

BAND 5. Conducted Spurious Plot _1 (20525ch_10MHz_QPSK_RB 1_0)

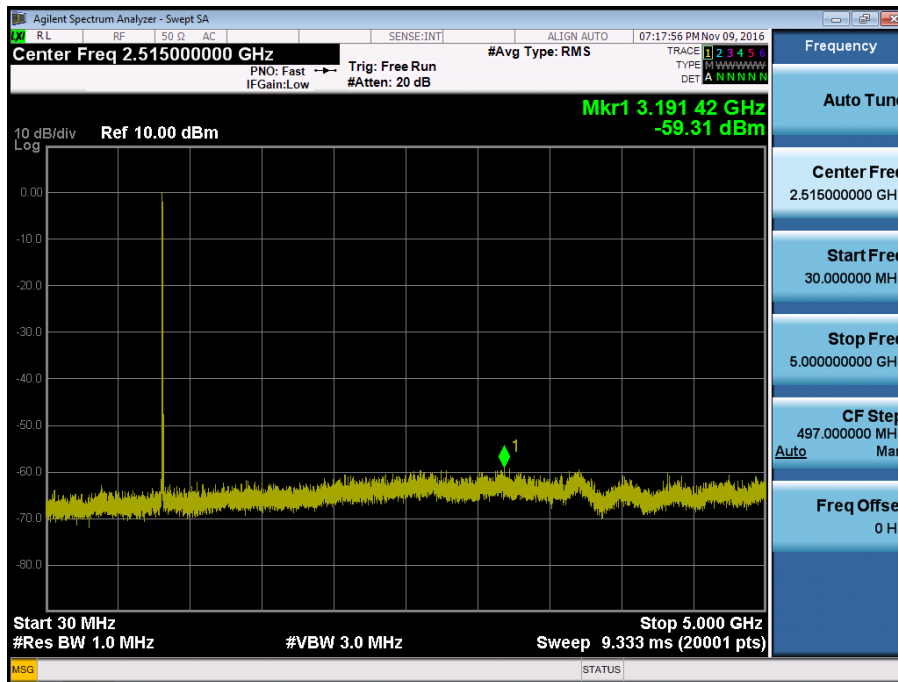

BAND 5. Conducted Spurious Plot _2 (20525ch_10MHz_QPSK_RB 1_0)

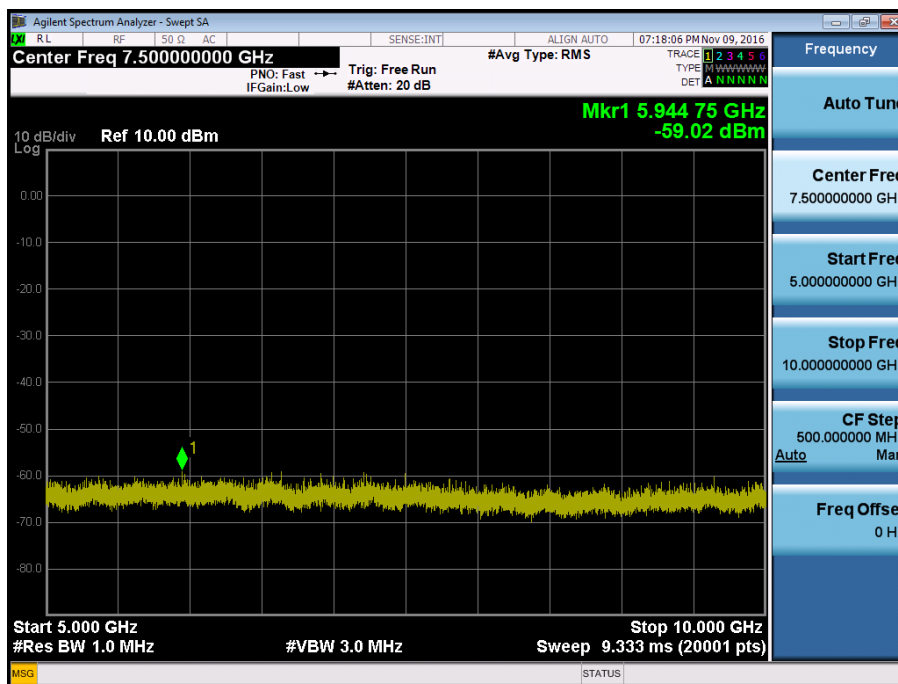

BAND 5. Conducted Spurious Plot _1 (20600ch_10MHz_QPSK_RB 1_0)

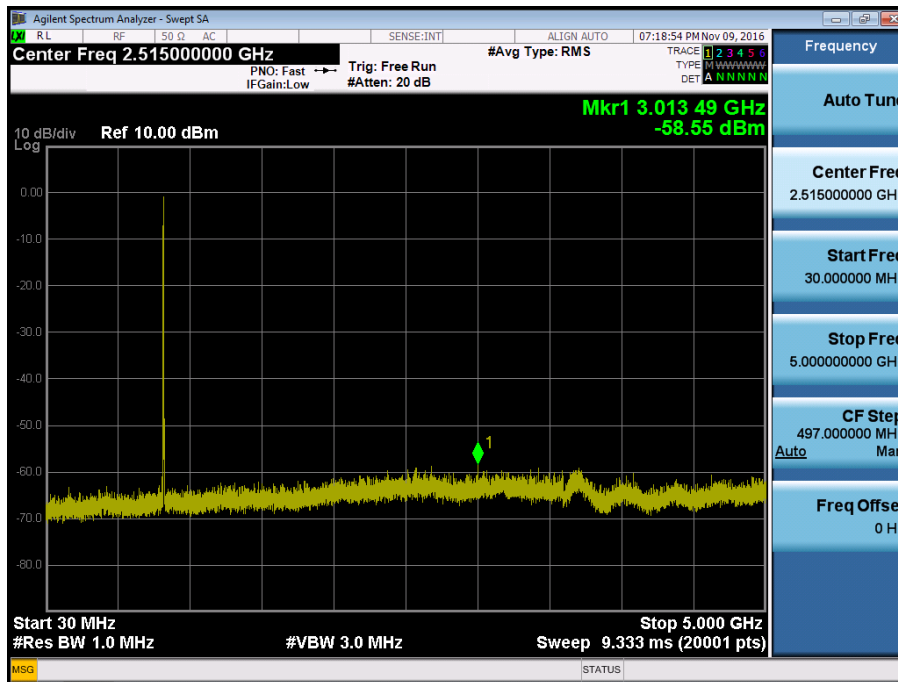

BAND 5. Conducted Spurious Plot _2 (20600ch_10MHz_QPSK_RB 1_0)

