

# **KX1801**

INSTRUCTION  
MANUAL

'18.X

# Introduction

Thank you for purchasing KX1801

Before or while using, read this manual thoroughly to ensure you use correctly.

## References to the Operation

Download the latest information of this manual from Website. Also you can check the latest information from this cell phone.

■ **"クイックスタートガイド (Quick Start Guide)" (Accessories, in Japanese only)**

Parts names and functions are explained.

■ **"Instruction Manual" (An application installed in this cell phone, in Japanese only)**

Details about functions and operations are explained.

From the Home screen, tap "Apps" ► "Instruction Manual".

\* For installing "Instruction Manual" application if you uninstalled it, from the Home screen, search "KX1801 取扱説明書 (Instruction Manual)" in "Play Store" and download "Instruction Manual" application.

■ **"INSTRUCTION MANUAL" (PDF file)**

Details about functions and operations are explained.







Download from Website.



## How to Use This Manual

- Unauthorized copying of parts of or this entire manual is prohibited.
- This manual is subject to change without prior notice.
- Please note that "this cell phone" indicates "KX1801" in this manual. Please be forewarned.

### Explanation of operations

The following table describes how to select the icons and items displayed on the touch screen.

Description	Operation description
From the Home screen, tap "Apps"	Tap  displayed on the Home screen. <ul style="list-style-type: none"><li>• The icons on the Home screen are explained below.<ul style="list-style-type: none"><li> : "Apps"</li><li> : "Phone"</li><li> : "mail"</li><li> : "Camera"</li><li> : "Gallery"</li></ul></li></ul>

Description	Operation description
From the Home screen, tap "Apps" ▶ "Settings" ▶ "Display"	Tap  displayed on the Home screen, and tap "Settings", "Display".
Touch and hold 	Touch and hold  displayed on the screen (for 1 to 2 seconds).

### Note

- In this manual, the operations are described when the Home Selector is set to "Home" and when the Home screen is set to the default settings. If the contents of the Home screen are changed, the operation description such as how to open an application may differ.
- Images used in this manual may differ from the real ones displayed on this cell phone.

## Supplied Accessories

- KX1801  
(with warranty)

- クイックスタートガイド (Quick Start Guide) (In Japanese only) / ご利用にあたっての注意事項 (Safety Precautions) (In Japanese only)



- Welcome Card

- TV Antenna Cable L01
- SIM Eject Tool (Sample)

- Disney Original Cover L01

For optional accessories compatible with the cell phone (optional), refer to website.

# Contents

How to Use This Manual .....	1	Receiving a Call .....	89
Supplied Accessories .....	2	Operations during a Call .....	91
Before Using This Cell Phone .....	5	Call Logs .....	94
Safety Precautions (ALWAYS FOLLOW THESE PRECAUTIONS) .....	7	Answering Memo .....	95
Handling and Care .....	24	Call Settings .....	96
Waterproofness/Dustproofness .....	33	Phonebook .....	100
<b>Confirmation and Settings before Using .....</b>	<b>40</b>	<b>Mail/Web Browser .....</b>	<b>105</b>
Part Names and Functions .....	40	mail .....	105
nano UIM card .....	42	SMS .....	106
Charging .....	45	Email .....	109
Power On/Off .....	48	Gmail .....	114
Disney Original Cover .....	50	Early Warning "Area Mail" .....	115
Basic Operations .....	51	Browser .....	117
Character Entry .....	57	<b>Apps .....</b>	<b>120</b>
Initial Settings .....	64	Disney Market .....	120
Notification LED .....	65	Play Store .....	121
Screen Display/Icons .....	66	OsaiFu-Keitai .....	124
Home Screen .....	72	ToruCa .....	128
Apps Screen .....	75	TV (1 Seg) .....	129
Task Manager .....	83	Camera .....	139
Switching Home Application .....	83	Gallery .....	144
<b>Calling .....</b>	<b>84</b>	GPS/Navigation .....	145
Making a Call .....	84	Clock .....	149
		Calendar .....	151
		QMemo+ .....	153

Calculator .....	154	Warranty and After-Sales Service .....	234
<b>Settings .....</b>	<b>155</b>	Software Update .....	237
Settings Menu .....	155	App Updates .....	241
WIRELESS NETWORKS .....	155	Main Specifications .....	242
DEVICE.....	170	Radio Frequency (RF) Signals .....	247
PERSONAL.....	180	Regulatory information (FCC ID number, etc.) .....	248
SYSTEM .....	189	FCC Statement for the USA .....	249
<b>File management.....</b>	<b>195</b>	Important Safety Information .....	250
Storage Structure .....	195	Export Administration Regulations .....	252
File Operations .....	198	Intellectual Property Right .....	252
<b>Data Communication.....</b>	<b>200</b>	Unlocking SIM .....	256
Bluetooth® Communication .....	200	Index .....	257
NFC Communication .....	204		
<b>External Device Connection .....</b>	<b>206</b>		
Connecting with a PC .....	206		
Connecting with Printer .....	208		
Connecting with Other Devices .....	209		
<b>Using Overseas .....</b>	<b>211</b>		
Outline of International Roaming (WORLD WING) .....	211		
Available Service Overseas.....	212		
Before Using Overseas.....	212		
How to Make and Receive Calls at Your Location .....	215		
Setting International Roaming .....	217		
After Returning to Japan .....	220		
<b>Appendix/Index .....</b>	<b>221</b>		
Troubleshooting (FAQs) .....	221		

## Before Using This Cell Phone

- This cell phone supports LTE, GSM/GPRS, and Wireless LAN Systems.
- Since this cell phone uses wireless signal, it may not be able to use in a location with no signal reception such as a tunnel, underground, a building, an outdoor location with weak or poor signal reception, or a location outside of the LTE service areas. Also this cell phone may not be able to use on upper floors of high-rise apartments or buildings, even if you can see no obstructions around you. Please note that on occasion, data communication may become disconnected even when you are in a strong-signal area with 4 signal bars displayed while you are not moving.
- Since this cell phone uses wireless signal, there are possibilities that a third party may intercept your telephone call. However, LTE and GSM/GPRS systems support the privacy function covering all telephone calls automatically. Therefore, even a third party intercepts your telephone call, the third party can hear nothing but the noise.
- Because this cell phone conducts wireless communication by transforming sound into digital signal, the received sound may differ from the actual one if the transmitted digital signal cannot properly be restored according to conditions such as moving into a poor signal area.
- Regularly take a memo of the information you registered in this cell phone or store it in the external memories such as microSD card or PC. Mobile operator assumes no responsibility for any loss of your data caused by malfunction, repair, change to a new model or any other reasons.
- Even though the display on this cell phone applies advanced technique, part of the dots may not light up as well as those always-on light. Please note that this is a feature of the display. It is not a malfunction.
- When free space is not enough in microSD card or in this cell phone, the performance of the activated applications may become improper. In that case, delete the saved data.
- Mobile operator does not guarantee any performances of the optional accessories you purchase at stores.



- The same as a PC, when you install an application, this cell phone's performance may become unstable, or your location information and personal information registered on this cell phone might be sent to outside via Internet and therefore cause fraudulent use. To avoid this, make sure to confirm the source and the operating conditions of the application before installation.
- This cell phone uses only nano UIM card. Bring your nano UIM card, or miniUIM card to a Shop to exchange it.
- This cell phone automatically performs communication for some functions, for example, to synchronize data, check the latest software or maintain connection with the server. Additionally, when you download applications or watch video etc, a large amount of packet communication charges are executed. Therefore, it is highly recommended to use packet pack or packet flat-rate service.
- Depending on the applications or service you use, packet communication charge may be applied even in Wi-Fi® communication.
- This cell phone does not support public mode (drive mode).
- In this cell phone, sounds other than ringtone and notification sounds (video playback sound, music playback sound, shutter sound, etc.) cannot be muted even when it is set to Manner Mode (Vibrate only, Silent).
- You can confirm your own phone number as follows.  
From the Home screen, tap "Apps" ▶ "Settings" ▶ "About phone" ▶ "Status".
- You can confirm the software version of this cell phone as follows.  
From the Home screen, tap "Apps" ▶ "Settings" ▶ "About phone" ▶ "Software info".
- You can update to the latest software for this cell phone. For details, refer to "Software Update" (P237).
- In this cell phone, functions may be added or operation steps may be changed due to upgrading Operating System (OS). For latest information of additional function or operation steps, refer to website.
- When OS is upgraded, some applications used for former OS may not work or unintended failure may occur.
- The applications and services are subject to change without prior notice.



- Please read the terms of service of Google Inc. regarding Google services. Also, read each term of services for other web services.
- When terms of use appear, follow the on-screen instructions.
- In case of loss of the cell phone, set the screen to ensure the security of the cell phone. For details, refer to "Lock Screen" (P173).
- If you lose your cell phone, change password of online service accounts from PC so that Google Services such as Gmail, Google Play, and service such as SNS, etc. should not be used by others.
- This cell phone does not support service providers other than sp-mode, mopera U or Business mopera Internet.
- When using tethering, subscribing to a packet pack or packet flat-rate service is highly recommended.
- For details such as usage charge, refer to website.



## Safety Precautions (ALWAYS FOLLOW THESE PRECAUTIONS)



- Before using this cell phone, read these "Safety Precautions" carefully so that you can use it properly.
- These precautions are intended to protect you and others around you. Read and follow them carefully to avoid injury, damage to the product or damage to property.
- The signs below indicate the levels of danger or damage that may occur if the particular precautions are not observed.

 DANGER	This sign indicates that incorrect handling has a high possibility of causing death or serious injury* <sup>1</sup> .
 WARNING	This sign indicates that incorrect handling poses a risk of causing death or serious injury* <sup>1</sup> .
 CAUTION	This sign indicates that incorrect handling poses a risk of causing slight injury* <sup>2</sup> or damage* <sup>3</sup> to the product or property.

- \*1 Serious injury: This refers to loss of sight, injury, burns (high- and low-temperature), electric shock, broken bones, injuries with residual aftereffects from poisoning, etc., and injuries requiring hospital admission for treatment or long term hospital attendance as an outpatient.
- \*2 Minor injury: This refers to injuries, burns (high- and low-temperature), electric shock, etc. that do not require hospital admission for treatment or long-term hospital attendance as an outpatient.
- \*3 Physical damage: This refers to extended damage to buildings, furniture, livestock, pets, etc.

■ The following symbols indicate special warnings regarding product usage.

 No wet hands	Denotes things not to do (prohibition).
 Not disassembly	Denotes not to disassemble.
 Not liquids	Denotes not to use where it could get wet.

 No wet hands	Denotes not to use with wet hands.
 Do	Denotes mandatory instructions (matters that must be complied with).
 Unplug	Denotes that the equipment should be unplugged.

■ "Safety Precautions" are explained in the following sections.

Handling the Cell Phone, Adapter, TV Antenna Cable, Disney Original Cover, and Nano UIM card (Common) .....	P9
Precautions for This cell phone .....	P12
Precautions for Adapter .....	P18
Precautions for Disney Original Cover ..	P21
Precautions for Nano UIM card .....	P21
Precautions for Using near Electronic Medical Equipment .....	P21
Material List .....	P22
Precautions for Sample (SIM Eject Tool) .....	P23

## Handling the Cell Phone, Adapter, TV Antenna Cable, Disney Original Cover, and nano UIM card (Common)

### DANGER



Don't

Do not use, store or leave this cell phone in hot places (e.g. by the fire, near a heater, under a kotatsu or futon, in direct sunlight, in a car in the hot sun).

May cause fire, burns, injuries, or electric shock.

---



Don't

Do not put this cell phone into or near a heating cooking device such as a microwave oven or IH cooker, or high-pressure container such as a pressure cooker.

May cause fire, burns, injuries, or electric shock.

---



Don't

Do not put sand, dirt, or mud on this cell phone or put it on them directly. Do not touch this cell phone with hands to which sand or others adhere. May cause fire, burns, injuries, or electric shock.

For the waterproof and dustproof functions, refer to the following.  
→P33 "Waterproof / Dustproof Function"

---



Don't

Do not charge when this cell phone is wet with water (drinking water, perspiration, seawater, urine of pet animals, etc.).

May cause fire, burns, injuries, or electric shock.  
For the waterproof function, refer to the following.  
→P33 "Waterproof / Dustproof Function"

---



Not disassembly

Do not disassemble or remodel the equipment.

May cause fire, burns, injuries, or electric shock.

---



Not liquids

**Do not let this cell phone get wet with water (drinking water, perspiration, seawater, urine of pet animals, etc.).**

May cause fire, burns, injuries, or electric shock.

For the waterproof function, refer to the following. → P33 "Waterproof / Dustproof Function"

---



Not liquids

**Do not put water (drinking water, perspiration, seawater, urine of pet animals, etc.) into the charging terminal or external connection terminal.**

May cause fire, burns, injuries, or electric shock.

For the waterproof function, refer to the following. → P33 "Waterproof / Dustproof Function"

---



Do

**Use the optional products specified by mobile operator for your cellphone.**

May cause fire, burns, injuries, or electric shock.



## WARNING



Don't

**Do not drop, trample, or throw this cell phone or give a strong force or vibration to it.**

May cause fire, burns, injuries, or electric shock.

---



Don't

**Keep conductive materials (metal pieces, pencil lead, etc.) from coming in contact with the charging terminal or external connection terminal and prevent dust from getting inside.**

May cause fire, burns, injuries, or electric shock.

---



Don't

**Do not cover or wrap this cell phone with a blanket, etc. while using or charging.**

May cause fire or burns.

---



Do

**If charging is not complete after the specified charging time has passed, stop charging.**

Not doing so may cause fire, burns, or injuries due to overcharge.

---



**Do** Make sure to turn off this cell phone or stop charging before you get close to places like a gas station where a flammable gas or dust can be generated.

Not doing so may cause the gas to ignite or fire.

When using Osaifu-Keitai at a gas station, be sure to turn off the power in advance. (If NFC/Osaifu-Keitai lock has been set, cancel the lock before turning off the power.)

---



**Do** If the equipment gives off a strange smell, noise, smoke, or overheats or becomes discolored or deformed during use, charge, or storage, perform the following operations.

- Remove the power plug from the outlet or cigarette lighter socket.
- Turn this cell phone OFF.

Not doing so may cause fire, burns, injuries or electric shock.



## CAUTION



**Don't**

**Do not use the damaged cell phone.**  
May cause fire, burns, or injuries.

---



**Don't**

**Do not leave this cell phone on unstable or sloping surfaces. Be careful especially while the vibrator is set.**

This cell phone may fall and cause injuries.

---



**Don't**

**Do not store the equipment in extremely humid, dusty or hot areas.**

May cause fire, burns, or electric shock.

For the waterproof and dustproof functions, refer to the following.

→P33 "Waterproof / Dustproof Function"

---



**Don't**

**When children use this cell phone, do not let them use incorrectly without instruction by an adult for proper use.**

May cause injuries.

---



Don't

Do not store this cell phone within the reach of small children.

May cause small children to accidentally swallow the equipment or cause injuries and electric shock.

---



Do

Be careful when using this cell phone continuously for a long time or charging as it gets hot. Also, avoid touching this cell phone for a long time by falling asleep unintentionally.

While using this cell phone for a long time such as using application, calling, using data communication, watching videos, etc. or charging, this cell phone or the adapter may get hot. Directly touching a hot part for a long time, you may have redness, itching or rash on your skin, or it may result in low-temperature burns depending on your constitution and/or health condition.

## Precautions for This Cell Phone



### DANGER



Don't

Do not throw this cell phone into fire or apply heat.

May cause fire, burns, or injury due to battery ignition, rupture, overheat, or leak.

---



Don't

Do not apply excessive force such as sticking a nail into this cell phone, hitting it with a hammer, or stepping on it.

May cause fire, burns, or injury due to battery to ignite, rupture, overheat, or leak.

---



Do

If materials inside the internal battery enters your eyes, do not rub your eyes and immediately flush them with clean water and see a doctor right away.

May cause loss of sight due to the influence of the fluid, etc. inside the internal battery.

---



**Do**

If materials inside the display enters your eyes or mouth, immediately flush your eyes or mouth with clean water and see a doctor right away.

Not doing so may cause loss of sight or poor physical condition due to the influence of the fluid, etc. inside the display.



## WARNING



**Don't**

Do not lighten or flash the lighting part of the light close to person's eye. Keep enough distance especially from small children.

May cause vision disturbance. Also, you may get dazzled or surprised causing an accident.



**Don't**

Do not lighten or flash the light to drivers of cars, etc.

May disturb driving and cause an accident, etc.



**Don't**

Do not watch the display that blinks repeatedly for a long time.

May cause spasm, loss of consciousness, etc.



**Don't**

Do not put foreign objects such as liquid like water (drinking water, perspiration, seawater, urine of pet animals, etc.), metal pieces or burnable things into the Nano UIM card/microSD card slot. Insert the Nano UIM card or the microSD memory card in the correct place and in correct direction.

May cause fire, burns, injuries, or electric shock.



**Don't**

Do not expose the camera lens to direct sunlight for an extended period.

May cause fire, burns, injuries, etc. by the light-collecting mechanism of the lens.



Do

When on board an airplane, turn the power of this cell phone off or put it in Airplane mode.

Follow the instructions of each airline, because there are different restrictions for using this cell phone on an airplane. Not doing so may cause electronic equipment of airplanes to fail or malfunction.

If you do a prohibited act such as using this cell phone in an airplane, you will be punished according to law.

---



Do

When using this cell phone in a medical facility, be sure to observe the regulations of the facility.

Turn this cell phone off where its use is prohibited.

Not doing so may cause electronic equipment or electronic medical equipment to fail or malfunction.

---



Do

When using the handsfree call, ringtone is ringing, or in the standby mode, be sure to keep this cell phone off of the ears.

Also, when playing games, video, or music with an earphone microphone connected to this cell phone, adjust the volume to the proper level.

Setting too loud a volume or using the earphone continuously for a long period of time might adversely affect your ears. Surrounding sounds may not be heard clearly causing an accident.

---



Do

Be careful when setting vibrator (vibration) or ringtone if your heart is weak.

Not doing so may cause harmful effect on heart.

---





Do

If you wear an electronic medical device, check with the equipment manufacturer or sales outlet to determine how the device is affected by radio waves before using this cell phone.

Not doing so may cause harmful effect on the electronic medical device, etc.

---



Do

Turn this cell phone OFF near high-precision electronic control equipment or electronic equipment using low-power signals.

Not doing so may cause the equipment to fail or malfunction.

\* Examples of electronic equipment to avoid

Hearing aids, implanted pacemakers or defibrillators, other electronic medical equipment, and other automatic control equipment. Users wearing implanted pacemakers or defibrillators, or other electronic medical equipment should check with the manufacturer or sales outlet about the effect of radio frequencies on the equipment.

---



Do

When the display or camera lens is accidentally broken, be careful of broken glass or exposed internal parts of this cell phone.

If you mistakenly touch broken or exposed parts, you may be injured.

---



Do

If the internal battery leaks or gives off a strange smell, immediately stop using and remove it from the vicinity of open flames.

Not doing so may cause leaking fluid to ignite or explode.

---



Do

Be careful not to let your pet bite this cell phone.

May cause internal battery to ignite, burst, heat, or leak, and may cause fire, burns, or injuries.



## CAUTION



**Do not swing this cell phone by the strap, etc.**

**Don't**

May cause an accident such as injury to yourself or others, or damage to surrounding objects by hitting.

---



**When using the motion sensor, stay alert to your surroundings, hold this cell phone firmly, and do not swing it excessively.**

**Don't**

May cause accident such as injuries.

---



**If the display breaks and the fluid etc. leaks out from inside, do not let the fluid contact with the skin on your face or hands or clothes.**

**Don't**

May cause loss of sight or skin problems.

If the fluid etc. enters your eyes or mouth, or contacts skin or clothes, immediately flush the contacted area with clean water.

If the fluid etc. enters your eyes or mouth, immediately see a doctor after flushing.

---



**Don't**

**Do not discard this cell phone together with other garbage.**

May cause ignition resulting in fire, burns, or injuries. Also, may cause environmental destruction. Bring them to a sales outlet such as Shop. If your local municipality has a battery recycling program, dispose of them as provided for.

---



**Don't**

**If fluid etc. leaks out from the internal battery, do not let the fluid contact with the skin on your face or hands.**

May cause loss of sight or skin problems.

If the fluid etc. enters your eyes or mouth, or contacts skin or clothes, immediately flush the contacted area with clean water.

If the fluid etc. enters your eyes or mouth, immediately see a doctor after flushing.

---



Do

When removing the Nano UIM card, be careful of the SIM eject tool or the edge of a paper clip to avoid injury to a part of your body such as your finger.

Touching the edge of the SIM eject tool or the paper clip may cause injury.

---



Do

To use this cell phone in car, check with automobile manufacturer or dealer to determine how vehicle devices are affected by radio waves before using.

In rare cases, using this cell phone in some vehicle models can cause the vehicle's electronic equipment to malfunction. In that case, stop using this cell phone immediately.

---



Do

If you develop skin problems, stop using this cell phone immediately, and see a doctor. The use of this cell phone may cause itching, rashes, eczema, or other symptoms depending on the user's physical condition.

For materials of parts, refer to the following.

→ P22 "Material List"

---



Do

Make sure that there is no adhered metal pieces (cutter blade, staples, etc.) as the speaker part of this cell phone, earpiece (receiver)/sub microphone, and vibrator area (volume key area) generate magnetism.

Not doing so may cause injuries, etc. due to adhered objects.

---



Do

When watching the display screen, keep a certain distance from the display in a fully bright place.

Not doing so may reduce visual acuity.

## Precautions for Adapter



### WARNING



Do not use the adapter cable if it is damaged.

Don't

May cause fire, burns, or electric shock.

---



Do not use the adapter in a bathroom or other highly humid area.

Don't

May cause fire, burns, or electric shock.

---



Always use the DC adapter with a negative-ground vehicle. Do not plug it into a positive-ground vehicle.

Don't

May cause fire, burns, or electric shock.

---



If it starts to thunder, do not touch the adapter.

Don't

May cause electric shock, etc.

---



Don't

Do not short the charging terminal while it is connected to an outlet or the cigarette lighter socket. Do not touch the charging terminal with a part of your body such as your hand or finger.

May cause fire, burns, or electric shock.

---



Don't

Do not place heavy objects on the adapter cord, or do not pull the cord with excessive force.

May cause fire, burns, or electric shock.

---



Don't

When connecting/disconnecting the AC adapter to/from an outlet, do not contact a metal strap or other metal objects with it.

May cause fire, burns, or electric shock.

---



Don't

Do not use an electric transformer for overseas (travel converter) with the AC adapter.

May cause ignition, heating, or electric shock.

---



Don't

**Do not apply force on the connected parts when the adapter is connected to this cell phone.**

May cause fire, burns, injuries, or electric shock.

---



No wet hands

**Do not touch the adapter cord, charging terminal, or power plug with wet hands.**

May cause fire, burns, or electric shock.

---



Do

**Only use with the specified power source and voltage.**

**When charging this cell phone overseas, use an AC adapter for global use.**

If incorrect power supply or voltage is used, it may cause fire, burns, or electric shock.

AC adapter : 100 V AC (Connect to an AC outlet for internal household use)  
AC adapter for global use : Between 100 V AC and 240 V AC (Connect to an AC outlet for internal household use)

DC adapter : 12 or 24 V DC (specific for negative-ground vehicles)

---



Do

**When replacing the DC adapter's fuse, replace it only with a specified fuse.**

Replacing with a different type of fuse might cause fire, burns, electric shock, etc. For the specified fuse, see the provided instruction manual.

---



Do

**Wipe off any dust that attached to the power plug.**

Not doing so may cause fire, burns, or electric shock.

---



Do

**When you connect the adapter to an outlet or a cigarette lighter socket, firmly connect it to the outlet.**

Not doing so may cause fire, burns, electric shock.

---



Do

**When you disconnect the power plug from an outlet or a cigarette lighter socket, do not pull the adapter cord with excessive force. Instead, hold the adapter to disconnect.**

Not doing so may cause fire, burns, electric shock.

---



Do

When connecting/disconnecting the adapter to/from this cell phone, do not use force and connect/disconnect straight without bending.

May cause fire, burns, injuries, or electric shock.

---



Do

Immediately stop using this cell phone if the external connection terminal is deformed. Do not use it by restoring the deformation.

May cause fire, burns, injuries, or electric shock due to short circuit of the charging terminal.

---



Unplug

Always remove the power plug of the adapter from an outlet or a cigarette lighter socket when not using the adapter.

Not doing so may cause fire, burns, injuries, or electric shock.

---



Unplug

Immediately remove the power plug from an outlet or a cigarette lighter socket if water (drinking water, perspiration, seawater, urine of pet animals, etc.) gets into the adapter.

Not doing so may cause fire, burns, or electric shock.

---



Unplug

Always remove the power plug from an outlet or a cigarette lighter socket when cleaning the equipment.

Not doing so may cause fire, burns, electric shock.

---



## CAUTION



Don't

Do not touch the adapters for a long time while they are connected to an outlet or cigarette lighter socket.

May cause burns, etc.

## Precautions for Disney Original Cover

### CAUTION



**Do not** pinch your fingers when attaching the Disney original cover. May cause accident such as injuries.

## Precautions for Nano UIM card

### CAUTION



**Do** Be careful of the cut surface when handling a Nano UIM card as it may damage a part of your body such as fingers, etc.  
Not doing so may cause injuries.

## Precautions for Using near Electronic Medical Equipment

### WARNING



**Do** Wearers of medical equipment such as implanted pacemakers or defibrillators must carry and use this cell phone at least 15 cm away from the implanted device.

This cell phone's signals may affect the performance of electronic medical equipment.

---



**Do** When electronic medical equipment other than implanted pacemakers or defibrillators are in use outside of medical facilities (such as in home care settings), check with the device manufacturer to determine how the device is affected by electrical signals.

This cell phone's signals may affect the performance of electronic medical equipment.

---



Do

Make sure that this cell phone will not emit any signals (turn off power, put it in Airplane mode, etc.) if within 15 cm of those around you, such as where crowded and you cannot move freely. Wearers of implanted pacemakers or defibrillators may be nearby. This cell phone's signals may affect the performance of electronic medical equipment.



Do

Obey rules inside medical facilities regarding use of this cell phone in such facilities.

Not doing so may affect the performance of electronic medical equipment.

## Material List

### ■ Main Unit

Part	Material	Surface Treatment
Display	Tempered glass	AF coating
Exterior case (side)	PC+GF20%	UV coating
Slot cap, Power key, Volume key	PC	UV coating
Exterior case (rear)	PC+GF10%	IML
Tray	PC+GF5%	None
Camera	Tempered glass	AF coating
Camera lens	AL	Anodizing
Flash panel	Transparent PC	None
Speaker, Earpiece (receiver)/Sub microphone	SUS	Baking coating



### ■ TV Antenna Cable LO1

Part	Material	Surface Treatment
Earphone/microphone jack (top)	Copper	Nickel plating
Earphone/microphone jack (outer cover)	TPE_JS400-78A	Non PVC
Cable	TPE_JS400-78A	Non PVC
Connection plug (top)	Copper	Gold coating
Connection plug (outer cover)	TPE_JS400-78A	Non PVC

### ■ Disney Original Cover LO1

Part	Material	Surface Treatment
Flip section (outside)	Transparent polycarbonate	UV coating after evaporated
Flip section (inside)	Transparent polycarbonate	Blast

Part	Material	Surface Treatment
Back cover section	Transparent polycarbonate	Pearl UV coating
Spine section	PU Leather	None
Sensor magnet	PC sheet	Printing

### ■ SIM Eject Tool

Part	Material	Surface Treatment
Main unit	Stainless steel	None

## Precautions for Sample (SIM Eject Tool)

### WARNING



Don't

The edge of the SIM eject tool is sharp. Do not use it pointing at yourself or others.

May cause injuries or loss of sight to yourself or others by hitting.

## Handling and Care

### General Usage Guidelines

- **KX1801 is waterproof/dustproof; however, do not allow water (drinking water, perspiration, seawater, urine of pet animals, etc.) or dust to enter this cell phone or come in contact with accessories or optional devices.**

The adapter, TV antenna cable, and Nano UIM card do not have waterproofness/dustproofness function. Do not use them in places with high humidity such as a bath or where rain may get it wet. If you carry this cell phone close to your body, moisture from sweat may corrode the internal parts causing a malfunction. Note that malfunctions deemed to be caused by water are not covered by the warranty or impossible to repair. Since these malfunctions are not under warranty, even when repair is possible, it will be done at the user's expense.

- **Clean this cell phone with a dry soft cloth (such as a cloth for eyeglasses).**
  - Rubbing it roughly with a dry cloth may scratch the display.
  - Drops of water or dirt left on the display may cause stains.
  - If this cell phone is wiped with alcohol, paint thinner, benzine or detergent, the printing may disappear or color may fade.
- **Keep the connector contacts clean with a dry cotton swab.**

Clean the connector contacts with a dry cotton swab to prevent contacts from getting dirty which can result in intermittent connections.

Be careful when cleaning the connector contacts.
- **Do not place this cell phone near air conditioner outlets.**

The rapid change in temperature may cause condensation, causing internal corrosion and malfunction.

- **Do not apply excessive force to this cell phone.**  
Putting this cell phone into a tightly packed bag or sitting on this cell phone in your pocket might damage the display or internal circuit board resulting in a malfunction. Also, keeping an external device connected to the external connection terminal might damage the connector resulting in a malfunction.
- **Do not rub or scrape the display with a metal piece etc.**  
The display may get scratched and it may cause malfunction or damage.
- **Read the instruction manual supplied with optional devices.**
- **Do not drop this cell phone or subject it to shock.**  
May cause malfunction or damage.

## Notes about This Cell Phone

- **Do not apply excessive force to the touch screen, or operate it with sharp objects such as fingernails, ballpoint pens, and pins.**  
May cause damage of touch screen.
- **Do not use this cell phone in extremely hot or cold places.**  
Use within an ambient temperature range of 5°C to 35°C and humidity range of 45% to 85%.
- **Use as far away as possible from land-line phones, TVs, and radios. Use nearby might affect them.**
- **Be sure to back up the data you saved in this cell phone on an external memory card, a PC, or cloud service, or keep a separate note.**  
Mobile operator assumes no responsibility for the loss of any of your data.
- **Do not plug external devices into the external connection terminal at a slant, or do not pull it forcibly while it is plugged.**  
May cause malfunction or damage.
- **It is normal for this cell phone to become warm during use or charging. Continue to use it.**

■ **Do not leave this cell phone with the camera in areas under strong direct sunlight.**

May cause discoloring or burn-in of elements.

■ **Use this cell phone with the slot cap closed.**

Not doing so may cause malfunction due to entering foreign objects such as liquid like water (drinking water, perspiration, seawater, urine of pet animals, etc.) or dust to this cell phone.

■ **While microSD card is being used, do not take the card out or do not turn off this cell phone.**

May cause data loss or malfunction.

■ **Do not bring magnetic cards, etc. near to this cell phone.**

Magnetic data in cash cards, credit cards, telephone cards, or floppy disks, etc. may be erased.

■ **Do not bring magnetized objects near to this cell phone.**

Putting a strong magnetism close to this cell phone might cause false operation.

■ **The internal battery is a consumable item.**

Battery life varies depending on usage conditions, etc., but it is time to change internal battery when the usage time has become extremely short even though the internal battery has been fully charged. For replacement of the internal battery, contact "Technical Inquiries & Repairs" on the back cover of this manual or mobile operator specified repair office.

■ **Charge the battery in an area within the proper ambient temperature range (5°C to 35°C).**

■ **The operation time provided by the internal battery varies by the operating environment and internal battery's deterioration.**

■ **The internal battery may swell out as it comes to near the end of its lifetime depending on the usage conditions. Note that malfunctions deemed to be caused by battery swell are not covered by the warranty or impossible to repair. Since these malfunctions are not under warranty, even when repair is possible, it will be done at the user's expense.**

- **Be careful especially about the following points when storing this cell phone.**
  - Keeping under the state of the full charge (right after charging ends)
  - The battery has run out (this cell phone cannot power on)

They may cause the internal battery performance to be degraded or its lifetime to be shortened.

It is recommended that you store the battery with the remaining battery level of about 40% as a guide.

- **This cell phone has the following type of internal battery.**

Display	Battery type
Li-ion00	Lithium-ion battery

## Notes about Adapter

- **Charge the battery in an area within the proper ambient temperature range (5°C to 35°C).**
- **Do not charge in the following places.**
  - Places that are very humid, dusty or exposed to strong vibrations.
  - Near land-line phones or TV/radio

- **It is normal for the adapter to become hot while charging. Continue to use it.**
- **When using the DC adapter for charging, keep the vehicle engine running.**  
The vehicle's battery could become flat.
- **When using an outlet with a mechanism preventing unplugging, follow the handling instructions of the outlet.**
- **Do not give strong shock. Also, do not deform the charging terminal.**  
May cause malfunction.

## Notes about Disney Original Cover

- **When the Disney original cover gets wet by water or sweat, wipe it with a soft cloth and dry it up.**
- **Depending on how much you use it, the color may fade.**
- **Do not put or close any magnetic cards to the Disney original cover.**  
The magnetic data in cash cards, credit cards, telephone cards, or floppy disks, etc. may be erased.

## Notes about Nano UIM card

- Do not put excessive force on the Nano UIM card when inserting into or removing from this cell phone.
- Note that mobile operator assumes no responsibility for malfunctions occurring as the result of inserting and using a Nano UIM card with other IC card reader/writer.
- Always keep the IC portion clean.
- Clean it with a dry, soft cloth (lens cleaning cloth), etc.
- Be sure to keep a separate note of the information registered on the Nano UIM card.  
Mobile operator assumes no responsibility for the loss of any of your data.
- Take an expended Nano UIM card to a sales outlet such as a Shop for proper disposal in order to protect the environment.

- Do not scratch, touch carelessly or short circuit the IC portion.  
May cause data loss or malfunction.
- Do not drop or give force to the Nano UIM card.  
May cause malfunction.
- Do not bend a Nano UIM card or place a heavy object on it.  
May cause malfunction.
- Do not install Nano UIM card into this cell phone with a label or sticker put on.  
May cause malfunction.

## Notes about Bluetooth<sup>®</sup> Function

- This cell phone is equipped with the security features, that are compliant with Bluetooth<sup>®</sup> standards for communication via Bluetooth<sup>®</sup>. However, depending on the settings, there may not be enough security. Be aware of security risks when using Bluetooth<sup>®</sup>.
- Note that mobile operator is not responsible for data or information leakage when making data communications using Bluetooth<sup>®</sup> function.

## ■ Frequency bands

Frequency bands used by this cell phone Bluetooth®/wireless LAN function are written as follows.

2.4FH1/DS4/OF4/XX8

- 2.4 : This radio equipment uses the 2400 MHz band.
- FH/DS/OF/XX : The modulation scheme is FH-SS, DS-SS, OFDM, or other scheme.
- 1 : The expected interference distance is 10 m or shorter.
- 4 : The expected interference distance is 40m or shorter.
- 8 : The expected interference distance is 80 m or shorter.
- ■ ■ : All bandwidths between 2400 MHz and 2483.5 MHz are used, and the bandwidth used by mobile object identification devices can be avoided.

Available channels vary depending on the country.

To use in airplanes, confirm with the airline company in advance.

## ■ Cautions on using Bluetooth® devices

In the bandwidth used by this cell phone, in addition to home electric appliances such as a microwave oven and industrial/scientific/medical devices, in-plant radio stations used to identify mobile objects used in production lines of a factory that require a license, specified low power radio stations, or amateur radio stations that do not require a license (hereafter "other radio stations") can be in operation.

1. Before using this cell phone, confirm that "another station" is not being operated nearby.
2. In the event of this cell phone causing harmful radio wave interference with "another station", promptly change the location or stop radio wave emission by turning off the power, etc.
3. If you have further questions, contact "General Inquiries" provided on the back cover of this manual.

## Points to Note about the Wireless LAN (WLAN)

- **Wireless LAN (WLAN)** has the advantage that it can be freely connected anywhere within the radio wave range, as it uses radio waves for exchanging information. At the same time, there is a risk that a malicious third party may obtain unauthorized access if security settings have not been configured. You are recommended to configure security settings before using wireless LAN at your decision and responsibility. It is recommended to make necessary security settings on your judgment and responsibility.

### ■ **Wireless LAN**

Do not use this cell phone in places where electromagnetic waves are generated or near electric products, AV and OA equipment, or other magnetized devices.

- Subjecting this cell phone to magnetic or electrical noise might increase noise and prevent it from performing communications. (this cell phone is particularly susceptible to noise when it used near a microwave oven.)

- Using this cell phone near a TV, radio or similar appliance might cause reception interference and disrupt TV images.
- The searching might not be successful if there are multiple wireless LAN access points near to this cell phone or the same channel is being used.
- For using WLAN overseas, point of use etc. may be restricted depending on country. In that case, confirm conditions such as available frequency or regulations of the country to use it.

### ■ **Cautions on using 2.4 GHz devices**

The operating frequency band of the WLAN device is used by industrial, scientific, consumer and medical equipment including home electric appliances such as microwave ovens, premises radio stations for identifying mobile units used in the manufacturing lines of plants (radio stations requiring a license), specified low power radio stations (radio stations requiring no license) and amateur radio stations (radio stations requiring a license).



1. Before using the device, confirm that premises radio stations for identifying mobile units, specified low power radio stations and amateur radio stations are not being operated nearby.
2. If the device causes harmful radio interference to premises radio stations for identifying mobile units, immediately change the frequency band or stop use, and contact "General Inquiries" on the back cover of this manual for crosstalk avoidance, etc. (e.g. partition setup).
3. If the device causes radio interference to specified low power radio stations or amateur radio stations, contact "General Inquiries" on the back cover of this manual.

#### ■ Cautions on using 5GHz devices

The cell phone can use 3 frequency bands of 5.2 GHz band (W52), 5.3 GHz band (W53), 5.6 GHz band (W56).

- W52 (5.2 GHz band / 36, 40, 44, 48 ch)
- W53 (5.3 GHz band / 52, 56, 60, 64 ch)
- W56 (5.6 GHz band / 100, 104, 108, 112, 116, 120, 124, 128, 132, 136, 140 ch)

Use of 5.2/5.3 GHz bands (W52/W53) outside is prohibited by the Radio Law. However, this does not apply to

communication with the base stations or land mobile relay stations of high-output data communications systems operating in the 5.2 GHz band (W52).

## Notes about FeliCa and NFC Reader/Writer

- The FeliCa and NFC reader/writer, P2P function for this cell phone handle delicate signals that require no radio station license.
- The 13.56 MHz frequency band is used. If there is another reader/writer, P2P function near this cell phone, keep enough distance between this cell phone and the reader/writer.  
Also, make sure that there is no radio station using the same frequency band nearby.
- For use in an aircraft, contact the airline company beforehand. In some countries, use may be restricted. Confirm regulations etc. for the country/area before using.

## Notes about Sample (SIM Eject Tool)

- **Do not apply excessive force to the SIM eject tool.**  
May cause malfunction or damage.
- **When discarding, segregate it according to the local rules.**
- **Do not use the SIM eject tool for other mobile phones.**  
May cause malfunction or damage of this cell phone.

## Caution

- **Never use modified terminals. Use of a modified device violates the Radio Law and Telecommunications Business Law.**  
This cell phone has acquired the certification of conformity with technical regulations for the specified radio station based on the Radio Law, and to such regulations as technical conformity based on the Telecommunications Business Law. And the "Technical Conformity Mark" is checkable on this cell phone as a certificate. Check the nameplate, operate the following steps.  
From the Home screen, tap "Apps" ▶ "Settings" ▶ "System" ▶ "About phone" ▶ "Regulatory labels"  
If you remodel this cell phone by removing its screws, your certification of technical standard conformance becomes invalid.  
Never use this cell phone without the valid certification. Doing so violates the Radio Law and Telecommunications Business Law.

- **Be careful when you use this cell phone while driving a car etc.**

Using this cell phone while driving will result in a penalty.

However, absolutely necessary cases such as rescue of a sick person or maintaining public safety are exempted.

- **The FeliCa reader/writer function for this cell phone is compliant with the radio standards for Japan.**

Before you start using this cell phone overseas, check the relevant laws and regulations of the country/region you visit.

- **Do not alter the basic software.**

Repairs may be refused as a modification of software.

## Waterproofness/ Dustproofness

KX1801 has a waterproof property equivalent to IPX5<sup>\*1</sup> and IPX7<sup>\*2</sup>, as well as a dustproof property equivalent to IP6X<sup>\*3</sup> on the condition that the slot cap is securely attached.

- \*1 IPX5 equivalent means that this cell phone will maintain its operability as a phone even if it is sprayed with water from a 6.3 mm diameter nozzle at a distance of about 3 meters for more than 3 minutes at a rate of about 12.5 liters per minute from any direction.
- \*2 IPX7 equivalent means that KX1801 will maintain its operability as a phone with no water getting inside the main unit even if it is gently submerged in a tank of still tap water at room temperature to a depth of 1 meter for about 30 minutes.
- \*3 IP6X equivalent means that this cell phone will securely maintain its function of no grit and dust getting inside the main unit even after it has been placed in an apparatus with grit and dust of diameters of 75  $\mu$  m or less and shaken for 8 hours (ingress of grit and dust cannot be prevented completely).

## What You Can Do with Waterproofness of KX1801

- You can talk without an umbrella in the rain (for rainfall of 20 mm or less per hour).
- You can wash this cell phone shaking gently in fresh and room-temperature tap-water (5°C to 35°C) in wash-basin.
  - With holding the slot cap not to open, wash this cell phone with tap water without rubbing hard.
  - Do not use brush, sponge, soap, detergent, etc. for washing.
  - After washing away, wipe the surface of this cell phone with a dry cloth and then remove remaining water. → P37
- You can use it at a poolside. However, do not pour the pool water over this cell phone or soak it in the pool water.

## Before Using

To maintain the waterproofness/dustproofness, be sure to observe the following points.

- Make sure to firmly close the slot cap. Even a fine obstacle (one hair, one grain of sand, tiny fiber, etc.) which is put between contact surfaces may allow water or dust to enter.
- Do not poke the earpiece (receiver)/sub microphone or mouthpiece (microphone), vent hole, speaker, earphone/microphone jack, external connection terminal, or slot cap with a sharp object.
- Do not let this cell phone fall. It may scratch this cell phone, causing its waterproof/dustproof performance to degrade.
- Rubber seal in the slot cap plays an important part in waterproof/dustproof property. Do not damage or remove the rubber seals. Also, prevent dust from adhering to them.

### ■ Open/Close the slot cap

When attaching or removing a Nano UIM card or microSD card, put your fingertip in the groove and pull open the slot cap in the directions indicated by the arrows (❶). After use, press the slot cap in the direction indicated by the arrows (❷) and trace them with your fingers along the directions indicated by the arrows (❸) to close securely.

Ensure that there are no gaps between the slot cap and the body.

It is recommended to replace the parts for maintaining waterproof/dustproof property once every two years regardless of whether any abnormality is present. Mobile operator takes this cell phone to replace the parts as a chargeable service. Bring this cell phone to a sales outlet such as a mobile operator-specified repair office.

## Precautions

Do not pour or put in liquid etc. other than water at room temperature shown in the illustrations below.

<Example>



Soap/Detergent/  
Bath powder



Seawater



Pool water



Hot spring water



Sand/Clay

Follow the following precautions to use correctly.

### ■ This cell phone

- Do not put this cell phone in hot water, use it in a sauna or apply hot air from a hair dryer etc. to it.
- Do not leave water drop on this cell phone. The external connection terminal may short out. In cold area, this cell phone freezes up and may cause malfunction.

- When you bring this cell phone from a cold place to a warm place, wait until this cell phone becomes room temperature to avoid dew condensation.
- Do not use this cell phone under water.
- Never try to charge the battery when this cell phone is wet.
- Do not wash with washing machine etc.
- This cell phone does not float on water.
- Do not place this cell phone directly on sand beach etc.
  - If sand etc. gets into the earpiece (receiver)/sub microphone or mouthpiece (microphone), vent hole, speaker, earphone/microphone jack, etc., sound volume may become lower.
  - If sand etc. gets into the hole of external connection terminal or earphone/microphone jack, waterproof function may not work.
  - If you use this cell phone with water drop, sand, etc. attached, sound may be distorted.
- Do not leave water drop on the earpiece (receiver)/sub microphone or mouthpiece (microphone), vent hole, speaker or earphone/microphone jack. Such water may interfere with phone calls.

- Do not leave water drop on the external connection terminal or earphone/microphone jack. This cell phone may short out.

#### ■ Others

- The supplied accessories and optional accessories have no waterproofness/dustproofness.
- Operation in all situation is not guaranteed for actual use. Note that malfunctions deemed to be caused by user's fault are not covered by the warranty.

## Draining Water

**When this cell phone gets wet, make sure to drain the water in the following steps.**

- Using this cell phone with water drop, the volume of speaker etc. becomes low and the quality may change.

**1 Wipe off moisture on the surface with a dry cloth**

**2** Shake this cell phone approximately 20 times for each side, firmly holding it, until there is no more water splattering

- Visually confirm if no water drops are on this cell phone.

**3** Gently press this cell phone to a dry and clean cloth to wipe off water remaining in the gap between earpiece (receiver)/sub microphone or mouthpiece (microphone), vent hole, speaker, earphone/microphone jack, external connection terminal, key, slot cap,etc.

- Do not wipe off the remaining moisture in the gaps directly with a cotton swab etc.



#### **4 Wipe off water drained from the cell phone with a dry, clean cloth etc., and dry naturally**

- Water, if any, remaining in this cell phone may ooze up after wiping off.

### **Charging**

The supplied accessories and optional accessories have no waterproofness/dustproofness function. Check the following before and after charging.

- Check if this cell phone is not wet. Never try to charge the battery when this cell phone is wet.
- Do not touch the AC adapter with wet hands. May cause electric shock.
- Do not use the AC adapter in a bathroom, shower room, kitchen, lavatory or other highly humid area. May cause fire or electric shock.

# Confirmation and Settings before Using

## Part Names and Functions

- 1 Notification LED
- 2 Front camera
- 3 Proximity sensor<sup>\*1</sup>/Illuminance sensor<sup>\*2</sup> (all-in-one)
- 4 Earpiece (receiver)/Sub microphone
- 5 Display (touch screen)
- 6 Hall-IC sensor<sup>\*3</sup>
- 7 Mouthpiece (microphone)
- 8 Volume key
- 9 Slot cap
  - When you open the slot cap, there is the nano UIM card/microSD card slot (tray).
- 10 Power key
- 11 Strap holder

- 12 Bluetooth®/Wi-Fi® antenna area\*4
- 13 Sub antenna area\*4
- 14 GPS/Sub antenna area\*4
- 15 Flash

- 16  mark
- 17 **Back side illumination**
  - When receiving an incoming call or a mail, illumination lights up to notify you.
- 18 **Speaker**
- 19 **LTE antenna area\*4**
- 20 **Main camera**
- 21 **Vent hole**
  - Adjust the internal and external pressures of the cell phone.
- 22 **Earphone/microphone jack**
- 23 **External connection terminal**

- \*1 Set touch screen to on or off to prevent unwanted operations from happening when your face touches the screen during calling.
- \*2 Sense the surrounding brightness and adjust the screen brightness automatically.
- \*3 The sensor is used to recognize if the Disney original cover is open or close.
- \*4 Antennas are built in this cell phone. If you cover the antenna area with your hand, its quality may be affected.

#### Note

- Do not put stickers on any sensor area.

## nano UIM card

The nano UIM card is an IC card that stores information such as your telephone number.

- This cell phone uses only nano UIM card. Bring your mini UIM card, or UIM card to a Shop to exchange it.
- If the nano UIM card is not inserted, the functions such as making/receiving calls, sending/receiving SMS, and packet communication are not available.
- In Japan, if the nano UIM card is not inserted, the emergency calls (110, 119, 118) cannot be made.
- For details about nano UIM card, refer to the instruction manual for nano UIM card.

## nano UIM card Security Codes

You can set the security code named PIN in nano UIM card. "0000" is set at the time of subscription. Customers can change PIN afterwards. For details about PIN of nano UIM card, refer to "PIN code" (P184).

## Inserting/Removing nano UIM card

- Turn off this cell phone before inserting/removing the nano UIM card. Make sure to remove the AC adapter from this cell phone in time of charging.
- To remove the tray, use the supplied SIM eject tool (sample).

■ Inserting

- 1 Open the slot cap (P35)
- 2 Insert the SIM eject tool into the tray eject hole horizontally

- 3 Put your fingertip on the tab of the tray, put it straight out, then remove the tray from this cell phone

- 4 With the IC side facing down, place the nano UIM card on the tray
  - Check the orientation of corner cut.

**5** Push the tray straight into this cell phone

**6** Press firmly the slot cap of this cell phone to close (P35)

■ Removing

- 1** Open the slot cap (P35)
- 2** Insert the SIM eject tool into the tray eject hole horizontally (P43)
- 3** Remove the tray from this cell phone (P43)
- 4** Remove the nano UIM card from the tray
- 5** Push the tray straight into this cell phone

## 6 Press firmly the slot cap of this cell phone to close (P35)

### Note

- When handling nano UIM card, take care not to touch or scratch the IC.
- Note that if you use excessive force to install or remove the nano UIM card, the nano UIM card may be damaged.
- Be careful not to lose the removed nano UIM card.
- If you lost the SIM eject tool, a paper clip can be used as a substitute for it.



Example of a paper clip

## Charging

### Battery Charge

- For detailed information, refer to instruction manuals for AC Adapter O5 (optional) and DC Adapter O4 (optional).
- AC adapter O5 can be used from AC 100 V to 240 V.
- The shape of AC adapter plug is for AC 100 V (Japanese specification). A conversion plug adapter for the destination country is required when using an AC adapter compatible from AC 100 V to 240 V. Also do not use a transformer for overseas travel to charge.
- When this cell phone is turned ON, you can operate this cell phone even while charging. However, in that case, charging takes longer time because of reducing charging volume.
- Do not apply excessive force when inserting or pulling out the connector. Insert or pull it out slowly.
- When charging with an entirely empty internal battery, it may take a while to power on this cell phone.
- Make sure to remove the power plug of AC adapter from the outlet after finishing charging.

- When charging with unstable rated voltage, battery may not get charged or charging may fail.

### Do not charge for a long time (for several days)

- If this cell phone is left for a long time after being fully charged, the internal battery starts feeding this cell phone when the charging is complete. For that reason, the actual battery time may shorten and the battery may be used up. If this happens, please charge it again correctly. Before recharging, remove this cell phone from AC adapter and reset.

## Internal Battery Life

- Internal battery is a consumable supply. The usage time decreases gradually each time the battery is charged.
- Watching 1Seg, etc. for a long time while charging may affect internal battery life.
- When the usage time becomes about half of a new battery, life of the internal battery is assumed to be over. We recommend you to replace the internal battery ahead of time. For replacement of the internal battery, contact "Technical Inquiries & Repairs" on the back cover of this manual or mobile operator specified repair office.

## Charging Time (Estimate)

For details about charging time, refer to "Main Specifications" (P242).

## Usage Time (Estimate)

For details about usage time, refer to "Main Specifications" (P242).



## Charging with AC Adapter

It describes how to charge this cell phone with AC Adapter 05 (optional).

- 1 Insert the microUSB plug of AC adapter into the external connection terminal of this cell phone horizontally with the side of B mark facing up
- 2 Raise the AC adapter power plug and insert it into power outlet
  - The Notification LED lights red while charging.
  - After charging, the notification LED of this cell phone turns off and then  appears on the notification icon area of the status bar (P66).

- 3 When charging is completed, remove the AC adapter power plug from the outlet
- 4 Remove the microUSB plug of the AC adapter horizontally from this cell phone

### ■ DC Adapter 04

The DC adapter supplies power to charge this cell phone through a cigar lighter socket (12 V/24 V) in a vehicle.

## Charging with PC

You can connect this cell phone to a PC using the micro USB Cable 01 (optional) to charge.

- 1** Insert the microUSB plug of micro USB Cable 01 into the external connection jack of this cell phone
  - Insert the microUSB plug horizontally with the side of B mark facing up.
- 2** Connect the USB plug of micro USB Cable 01 to the USB port on PC
  - The USB connection screen appears. Select "Charging only" if necessary, tap "JUST ONCE"/"ALWAYS".
- 3** When the charging is complete, remove the USB plug of micro USB Cable 01 from the USB port on PC
- 4** Remove the microUSB plug of microUSB Cable 01 from this cell phone

### Note

- Depending on the PC conditions, it may take a while to finish charging, or it may not be able to charge.

## Power On/Off

### Power On

- 1** Press and hold the power key for 2 seconds or more
  - This cell phone vibrates and the lock screen is displayed after a while.
  - After purchasing this cell phone, when it is turned on for the first time, follow the on-screen instructions to perform the initial settings (P64).

### Power Off

- 1** Press and hold the power key for 2 seconds or more
- 2** "Power off"
- 3** "OK"

## Turning on Backlight

To prevent unwanted operations and to save power, the backlight turns off after a certain time duration you set up and the screen is locked after then.

### 1 Press the power key

- Backlight lights on and the lock screen is displayed.
- Press power key again to black out the backlight and lock the screen.

### ■ Knock ON/Knock OFF

Quickly tap the blacked-out screen twice to light the backlight. Quickly tap the area with no icon on the Home screen\* or lock screen, or tap the status bar twice to turn off the backlight.

\* Only operates when the home application is "Home".

### Note

- Set screen time-out duration and time duration till screen is locked. For detailed information, refer to "Screen timeout" (P172) in "Display" and "Lock timer" (P175) in "Lock screen".

## Unlocking Screen

When turning on the power or when displaying the display, the touch screen stays being locked.

### 1 Swipe the screen up, down, left, or right

- You can change the method of unlocking the screen (P173).

### Note

- When the screen lock is set to "Touch" or "Swipe", drag or swipe the status bar downwards with the screen locked to open the notification panel.

## Lock Screen

- 1 **Date & time**
- 2 **Notification information display area**  
Displays the details of two latest notifications and the number of unread notifications.

## Disney Original Cover

When the Disney original cover L01 is attached and the flip is closed, the clock or animation is displayed on the display. When receiving an incoming call or a mail/message or while Disney kisekae alarm is ringing, the animation notifies you about it.

- When receiving an incoming call, you can select to answer/reject with the flip section closed.
- When receiving a mail, the mail title and sender is displayed and when receiving a message, the sender and the text is displayed.

### ■ Installing

- 1 **Check the direction of the cell phone, align the convex part of the Disney original cover while pressing it to the direction 1 and push it to the direction 2**

## ■ Removing

- 1 Hook your finger on the convex part (1 or 2) of the Disney original cover to detach

## Basic Operations

This cell phone adopts touch screen which allows you to operate by touching the display.

## Using Touch Screen

### Precautions on using touch screen

The touch screen is designed for finger touching lightly. Do not press it hard with your finger or with sharp objects (fingernail, ballpoint pen, pin etc.).

The following actions may cause the touch screen not working properly. Note that it may cause wrong operations.

- Operating the screen with gloved hands
- Operating the screen with tip of a fingernail
- Operating the screen with an object on it
- Operating the screen with a protective sheet or seal on it
- Operating when the screen is wet
- Operating when fingers get wet due to sweat or water

## Touch screen operations

The following operations are available on the touch screen.

- **Tap** : Touch the screen lightly
- **Double-tap** : Touch the screen lightly twice in a row
- **Touch and hold** : Touch the screen for over one second
- **Swipe** : Flick the screen lightly
  - Swipe to scroll the screen.



- **Drag** : Touch and hold down to flick the screen, and then release your finger
  - Icons and widgets can be moved.

- **Flick** : Touch the screen and quickly sweep your finger
  - Flick to scroll the screen at high speed. While scrolling, touch the screen to stop scrolling.

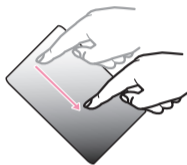

- **Pinch-out** : Touch the screen with two fingers and then move them apart
  - Pinch out to enlarge the screen.

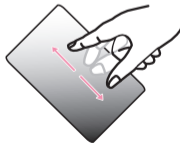

- **Pinch-in** : Touch the screen with two fingers apart and then move them together, as if pinching
- Pinch in to reduce the screen.



## Home Touch Buttons

You can change the layout and the color of the home touch buttons.

- Up to five home touch buttons can be assigned.

**1** From the Home screen, tap "Apps" ► "Settings" ► "Display" ► "Home touch buttons"

**2** Tap "Button combination" or "Color"  
• Follow the on-screen instructions.







### Back key

Tap to go to the previous screen. Close a dialog box, an option menu, the notification panel or the software keyboard.



### Home key

- Tap to display the Home screen.
- Touch and hold to start Google application.

	<p><b>History key</b></p> <ul style="list-style-type: none"> <li>• Tap to display the most recently used applications.</li> <li>• Touch and hold to display the option menu for the current screen or an application.</li> </ul>
	<p><b>Notification key</b></p> <p>Tap to displays/hide the notification panel.</p>
	<p><b>Capture key</b></p> <p>Tap to start Capture+ application.</p>
	<p><b>QSlide key</b></p> <p>Tap to display QSlide application selection screen at the bottom of the screen.</p>

## Auto Rotating Screen

This cell phone screen automatically rotates to landscape or portrait views, depending on the direction in which it is turned.

- Depending on the display screen, the screen orientation may not change on this cell phone.
- Even if this cell phone is oriented close to being level in relation to the ground, the landscape/portrait view does not change.

- 1 From the Home screen, tap "Apps" ► "Settings" ► "Display"
- 2 Place a check mark in "Auto-rotate screen"

## Capturing Screen Shot

You can capture the display and save it as an image.

- 1 Press and hold down the power key and volume key (down) for over 1 second
  - You can see the captured screen shots in "Screenshots" of "Gallery".
  - The image may not be able to save depending on the screen, such as 1 Seg.



## QSlide Apps

While doing other operations, video, messaging, calendar, and email can be used via popup.

- Up to two QSlide apps popup windows can be displayed on the same screen.

### Using QSlide apps

- 1 Open the notification panel (P69)
- 2 "QSlide"
  - The QSlide application field is displayed on the notification panel.
- 3 Select QSlide apps

- 1 Go to full screen display.
- 2 Adjust background transparency.  
If this is dragged to the left, even if the QSlide apps screen is touched, it will no longer respond, but other functions can be used.
- 3 Close the QSlide application.
- 4 Adjust the display size.

### Editing QSlide apps

- 1 Open the notification panel (P69)
- 2 Tap "Edit" in the QSlide apps field
  - You can sort the QSlide apps or select the apps to show/hide in the notification panel.

## Emergency Mode

Enable this mode to restrict the cell phone settings and functions to save the battery power.

### Enabling emergency mode

- 1 Press and hold the power key for over two seconds
- 2 Tap "Emergency mode" ► "OK" ► confirm the screen contents ► "OK"
  - Restart this cell phone and enable the emergency mode.

#### Note

- Alternatively, from the Home screen, tap "Apps" ► "Disaster kit" ► "SAVE" ► "OK" for setting Emergency mode.
- Even when the emergency mode has been enabled, Wi-Fi® and Bluetooth® function can also be turned on.

### Disabling emergency mode

- 1 Press and hold the power key for over two seconds
- 2 Tap "Emergency mode" ► "OK" ► "OK"
  - Alternatively, from the Home screen of the emergency mode, tap "Stop saving" ► "OK" to disable the emergency mode.
  - Restart this cell phone and disable the emergency mode.

## Setting Application Authentication

When applications or functions to access the function or information of the cell phone is activated for the first time, the confirmation screen that sets whether to permit the access authentication appears. When the access authentication is permitted, some functions or information in the appropriate applications or functions will be available.

- The confirmation screen varies depending on the application or function. Confirm the displayed contents carefully before operating.

<Example> Activating "Memo" application for the first time

**1** From the Home screen, tap "Apps"

▶ "Memo"

The permission screen for using functions appears.

**2** Tap "OK" ▶ "DENY"/"ALLOW"

Follow the on-screen instructions.

**Note**

- If the access authentication is not used, application or functions may not be available or may limit the functions.
- To change the authentication setting, from the Home screen, tap "Apps" ▶ "Settings" ▶ "Apps" ▶ select an application ▶ "ALLOW" ▶ select ON/OFF for the authentication to be changed.

## Character Entry

This cell phone has software keyboards displayed in the touch screen for character entry.

## Character Entry via Software Keyboard

If you tap a text box on the screen, the software keyboard appears in the touch screen. This cell phone provides three types of software keyboards: an on-screen 10key keyboard, an on-screen QWERTY keyboard and handwriting converting keyboard.

Tap  to switch the entry operation such as character mode change.

## 1Okey keyboard/QWERTY keyboard











### ● 1Okey keyboard

It is a keyboard similar to a general mobile phone keyboard (for multi-tap method). Tap a key assigned character you want to enter several times until the target character is entered.

### ● QWERTY keyboard

The array is the same as the PC's keyboard. Enter Japanese in Roman character.

### ① Voice input/Keyboard type key/Handwriting input key/Clipboard key/Setting key/Reverse order key

- Switch to Voice input mode.
- Touch and hold down to display keyboard function button panel.
  - Tap  to switch to voice input mode. It is not displayed when setting not to use voice input.
  - Tap  (QWERTY keyboard) /  (1Okey keyboard) to switch "1Okey keyboard" / "QWERTY keyboard".
  - Tap  to display the handwriting input keyboard.
  - Tap  to display the clipboard.
  - Tap  to enable Input Extension plug-in.
  - Tap  to display "LG Japanese keyboard" menu. The voice typing key can be hidden in the "Keyboard Settings".  /  is displayed when setting to hide.
    - \* For detailed operations, refer to "Help" in "Keyboard Settings".
- If using the 1Okey keyboard,  is displayed when a character is entered. Tap  to display (reversed order) the previous character.



## 2 Left cursor key/Arrow key

- The cursor moves to the left.
- It can also narrow the conversion range to convert.
- Touch and hold down to change arrow key mode.

## 3 Symbol key/Alphanumeric and Kana key

- Display number keys. Tap again to display pictograph/symbol/emoticon/pictogram-D list. For 10key keyboard, right click to display pictograph/symbol/emoticon/pictogram-D list.
- Display alphanumeric characters and kana when "英数力ナ (Alphanumeric and Kana key)" is displayed.

## 4 Switch character mode

- Switch the character mode.
- Touch and hold down to select "Input language" and "Keyboard style".
  - Tap  (portrait display) /  (landscape display) to switch "One-handed operaiton" / "Split keyboard".
  - Tap  to return to standard keyboard.

## 5 Delete key

- Deletes the character on the left of the cursor.
- Touch and hold down to delete the characters continuously.

## 6 Right cursor key

- The cursor moves to the right.
- Touch and hold down to move it continuously.
- It can also widen the conversion range.



## 7 Space key/Convert key

- Enter a space.
- "変換 (convert)" is displayed during Hiragana input and a list of conversion candidates is displayed.

## 8 Confirm key/Execute key/Link feed key/Search key/Next key/Finish key

- Confirm the entered characters or converted characters.
- If the entered characters or converted characters have already been confirmed, this executes the function (execute, line feed, search, next, finish) of the text box in which the characters were entered.

## 9 Bracket/Shift key

- Enter brackets.
- When entering letters, tap to switch to capital letters.
  - : Small letters
  - : Only capital letter with the first letter
  - : All capital letters

## 10 Punctuation mark key





- Input punctuation marks.
- Touch and hold down to display symbol list.

## On-screen 10key keyboard (arrow key mode selected)



- 1 Arrow (up, down, right or left) key**  
Move the cursor to up, down, right or left.
- 2 Close**  
Switch to the software keyboard that has been displayed before the arrow key mode is displayed.
- 3 Quick cursor key**  
Move the cursor to the beginning or the end of sentence.
- 4 Select all**  
Select all the characters.
- 5 Copy key**  
Copy the selected text.
- 6 Paste key**  
Paste the copied/cut text.

- 7 Delete key**
  - Delete the character on the left of the cursor.
  - Touch and hold down to delete the characters continuously.
- 8 Select/Deselect key**
  - Select a target.
  - You can change the area with arrow key.
  - With deselect key, you can deselect the selected area.
- 9 Space key**  
Enter a space.
- 10 Execute key/Line feed key/Search key/Next key/Finish key**  
Execute the functions (execute, line feed, search, next, finish) of the input text box.
- 11 Cut key**  
Cut the selected characters.

### 1 Handwriting area

-  is displayed under the characters when writing characters. Tap  to display a list of recognition candidates and you can modify the character.
-  is displayed on the right side of the handwriting area when writing characters. Tap  to continuously input the characters by handwriting.

### 2 Menu key

- Select Input mode (character type) and execute mode (handwriting methods).
- Touch and hold down to set the advanced settings of handwriting input.
- Set execute mode to   to display two input fields of handwriting. Enter one character after the other alternately.

### 3 Symbol key

Display a list of pictographs, symbols, emoticons and pictogram-D list.

### 4 Keyboard type key/Clipboard key/Setting key

- Switch to the software keyboard that was displayed prior to the display of the handwriting input screen.
- Touch and hold down to display clipboard key and setting key.

### 5 Space key

Enter a half space.

### 6 Left cursor/Right cursor key

- Move cursor position.
- Touch and hold down left cursor key to switch to arrow key mode.

### 7 Confirm/Line feed key

- Confirm the entered characters or converted characters.
- If the entered characters or converted characters have already been confirmed, this executes the function (line feed) of the text box in which the characters were entered.

### 8 Delete key



- Delete the character on the left of cursor.
- Touch and hold down this to delete the characters continuously.

- Touch and hold down this to select the method of deleting when you are writing characters in handwriting input field.
  - ☒ : Delete all the characters
  - ☑ : Delete one character
  - ☒ : Delete a line within the field

### Note

- The key display varies depending on the entry screen or character mode.
- When you no longer need the keyboard, you can close it by tapping . To display it again, tap the text box on the screen.

## Changing Character Entry Settings

Touch and hold down  on a character entry screen and tap  to display "LG Japanese keyboard" menu. Tap "Keyboard Settings" to change the character entry settings.

COMMON SETTINGS	
Input language and keyboard type	Set the input language, screen orientation and the keyboard type of each input mode.
10key keyboard	Set flick input and auto cursor movement.
Candidate	Set the learning of input phrases, the correction of inputting mistakes, and word prediction.
Auto capitalization	Place a check mark to capitalize the first letter automatically when inputting English letters in applications supported input function.



<b>Auto punctuation</b>	When alphabetical characters are input, double tap the space key to enter a period.
<b>Touch feedback</b>	When inputting characters, set key popup, sound and vibration, etc.
<b>Voice input</b>	Set if enable voice input or not.
<b>Handwriting</b>	Set handwriting settings.
<b>Fullscreen mode</b>	Set to display the dedicated input screen or not in landscape view. Some applications may not perform properly due to the restrictions.
<b>ADVANCED SETTINGS</b>	
<b>Split keyboard</b>	Set to display keyboard in two separate fields or not in landscape view.
<b>One-handed operation</b>	Set if the keyboard is moved to right or left in portrait view.
<b>EXTERNAL APPLICATION</b>	

<b>Input Extension plug-in</b>	Set to use Input Extension plug-in or not. <ul style="list-style-type: none"> <li>To use Input Extension plug-in, download "WnnDictionary" (search in dictionary) / "WnnBrowser" (connect to URL) / "WnnSearch" (search inside Website). For details about download, refer to "Downloads" (P241).</li> </ul>
<b>DICTIONARY</b>	
<b>User dictionary</b>	Edit words in personal dictionary.
<b>Clear learning dictionary</b>	Delete all learning dictionaries.
<b>RESET DEFAULT</b>	
<b>Reset to default</b>	Reset settings changed in the keyboard settings.
<b>ABOUT IME</b>	

<b>Help</b>	Display Help of LG Japanese keyboard. In Help, you can confirm descriptions of function key usage, Split keyboard and One-handed operation mode.
<b>Keyboard version</b>	Detailed information on LG Japanese keyboard is displayed.

## Initial Settings

### First-time Settings When the Power is Turned On

After purchasing this cell phone, when it is turned on for the first time, follow the on-screen instructions to select a language, set the Google account or perform the mobile operator service initial settings.

- Procedures differ depending on the connection with network and setting skips.

#### 1 Tap "Next" on "Welcome" screen

- Tap "日本語 (日本) (Japanese (Japan))" to change language.
- Follow the on-screen instructions to set up the items below, and tap "Next".
  - Wi-Fi®
  - Google account
  - Mail
  - Protect your phone
  - EULA (End-User License Agreement)
  - Whether to permit LG to collect the log information

#### 2 On the "Software Update" screen, tap "OK"

### 3 On the "Welcome to mobile operator service!" screen, confirm precautions and terms of service and mark "Agree to all" ► tap "Start settings"

- Follow the on-screen instructions to set up the items below, and tap "Next".
  - d ACCOUNT
  - Mobile operator cloud
  - Remote Initialization Service\*
  - Installing applications collectively
- \* Does not displayed when mobile operator apps password has not been set up.

### 4 Tap "Start using"

#### Note

- You can change the settings later.
- Before setting online service, make sure that the data can be connected (LTE/3G/GPRS), or make sure that the Wi-Fi® network is being connected.
- Even when the Google account has not been set up, you can still use this cell phone except for the usage of Google service such as Gmail or Google Play.

## Notification LED

This cell phone notifies you of its status via the lighting up or blinking Notification LED light. Operations of Notification LED light is shown below.

- Blinking red color: Missed call/Area Mail notification
- Lighting up red color: Charging/Incoming call

#### Note















- The lighting up while charging or finishing charging operates regardless of whether this cell phone is powered on or off.
- When receiving a notification while charging or finishing charging, notification blinking is prior.













## Screen Display/Icons

### Status Bar













The status bar is displayed at the top of the screen. The status and notifications of this cell phone are displayed on the status bar. On status bar, notification icons are displayed on the left side, and status icons are displayed on the right side.















### Main status icons















	Signal strength
	No service
 (gray)	Bluetooth® function is on
 (white)	Connecting to Bluetooth® device
	During international roaming
 / 	3G available/communicating (arrow is gray in standby, arrow is white in sending/receiving)
 / 	LTE available/communicating (arrow is gray in standby, arrow is white in sending/receiving)
 / 	HIGH-SPEED/HSDPA available/communicating (arrow is gray in standby, arrow is white in sending/receiving)
 / 	Connecting Wi-Fi®/ communicating
	Remaining battery level
	Battery needs to be charged

	Charging
	Airplane mode activated
	nano UIM card locked or nano UIM card not inserted
	Manner Mode (Vibrate only)
	Manner Mode (Silent)
	Alarm is set
	Reader/Writer, P2P function is on
	Calling via hands-free
	Answering memo is set
	GPS is positioning
	NFC/Osaifu-Keitai lock is set on both this cell phone and nano UIM card
	NFC/Osaifu-Keitai lock is set on this cell phone or nano UIM card
	Connecting to VPN



## Main notification icons

	New Gmail
	New Email
	New message (SMS)
	New Area Mail
	Problem with message (SMS) delivery
	New Hangouts message
	Incoming call, making a call, answering a call
	Receiving/Making a video call or talking on the phone
	Missed call
	New answering memo
	New voicemail message
	New alarm notification
	Upcoming calendar event

	Playing music via music application
	Playing music via Media Player
	Detected an Open Network (Wi-Fi®)
	Connecting to the Wi-Fi® of unavailable Internet
	Connecting with USB
	Charging completed
	Low free space of memory on this cell phone
	Data upload completed
	Data download completed
	Problem with login
	Available to update
	Application installation finished
	Watching 1 Seg
	Recording 1 Seg

	Recording 1 Seg is finished
	More notifications
	Wi-Fi® tethering available
	USB tethering is available
	Bluetooth® tethering available
	Connecting Wi-Fi Direct®
	The application provided by LG Electronics Inc. needs to update
	Battery saver is on
	Omakase Lock is on
	Notification from mobile operator
	Start of d ACCOUNT settings interlinking
	Authorization failure of d ACCOUNT settings
	backup application notification
	Mobile operator application location information ON

## Note

-  is displayed when the internal storage runs out of space.
-  is displayed, you may not be able to install an application even after downloading it. Make enough free space and install the application again.

## Notification Panel

You can confirm the notification icons, start an application or turn on/off a function in the notification panel.

### Viewing notification panel

- 1 Drag or swipe the status bar downward

### 1 Date & time

Display date and time.

### 2 Capture+

Activate an application that can edit by directly writing characters or drawing illustrations on captured images and save them in "QMemo+" or "Gallery".

### 3 QSlide App field

Tap and activate QSlide app (video, messaging, calendar, email, file manager, calculator).

- Tap "QSlide" in the quick setting icon field to display "QSlide".

### 4 Screen brightness adjustment field

Adjust the screen brightness via slide bar.

- If turn on "Auto" (icon turns to pink color), the screen brightness is automatically adjusted.

### 5 Incoming call volume adjustment field

- Adjust volume of an incoming call.
- Tap  to open volume setting window.
- This is displayed by placing check marks from "Edit" to "Volume" of the quick setting icon field.

### 6 Notification information

Display details of notification information.

### 7 Telecommunications carrier name

### 8 Setting button

The "Settings" screen is displayed.

### 9 Quick setting icon field

Switch each function on/off.

- ON is displayed in pink color, OFF is displayed in gray color.
- Scroll to right and left to display the hidden icons.
- Touch and hold down to display the setting menu screen of each function.
- Touch "Edit" to customize or sort icons.

### 10 Delete notification

Delete notification information and icons. Some notifications cannot be deleted.

## Viewing notification details

### 1 Tap the notification information on the notification panel

- The notification details are displayed in an appropriate application.



## Closing notification panel

- 1 Drag or swipe the notification panel upward

### Note

- Tap  to close notification panel.

## Sorting quick setting icons

- 1 Tap "Edit" in the quick setting icon field
- 2 Drag the items  you want to sort to the destination

## Customizing quick setting icons

- 1 Tap "Edit" in the quick setting icon field
- 2 Place a check mark in the desired item to display

## Customizing Icons

You can change the icon design such as shortcut to use on the Home screen.

### Note

- From the Home screen, tap "Apps" ► "Settings" ► "Home screen" ► "Select Home" ► usable only "Home" is selected.

## Changing home application icon

- 1 From the Home screen, touch and hold down a shortcut icon
  -  is displayed at the upper right of the icon.
- 2 Tap the shortcut icon again
  - Icon change screen is displayed.
- 3 Tap your favorite icon ► "OK"

## Changing to photo icon

You can use a photo from camera and gallery as the icon for the Home screen.

- 1 From the Home screen, touch and hold down a shortcut icon**
  -  is displayed at the upper right of the icon.
- 2 Tap the shortcut icon again**
  - Icon change screen is displayed.
- 3 Tap "Add new" ► drag the pink color frame and set icon size ► "OK"**
  - Gallery is activated.
- 4 From Gallery, select a picture you want to set up ► adjust its size ► "OK"**

## Home Screen

### Viewing Home Screen

- 1 Widget**
- 2 Apps**
- 3 Current location of the Home screen**

Indicates the page number of the Home screen and which screen you are in. Flick to right/left to switch the display.

#### 4 Dock

Applications, etc. are displayed. Always displayed even when the Home screen is changed.

-  Apps: Displays the application screen.

#### 5 Machi-chara

#### 6 Folder

Multiple applications are stored.

### Note

- Pinch out the Home screen to enlarge the wallpaper till it becomes full screen. Pinch in the wallpaper enlarged till it becomes full screen to return to the Home screen.

## Home Screen Management

### Adding Home screen

#### 1 Pinch in on the Home screen

- Home screen list is displayed.

#### 2 "+"

- Up to seven screens can be added.

### Note

- Touch and hold the Home screen you want to delete ► drag it to the "Remove" on the top of the screen and delete the Home screen.

### Adding an application or widget

#### 1 From the Home screen, touch and hold down an area with no application icon or widget

#### 2 Tap "Apps" or "Widgets"

#### 3 Tap a desired application icon or widget to add

## Moving an application or widget

- 1 From the Home screen, touch and hold down a desired application icon or widget to move
- 2 Drag the item to the destination

### Note

- You can drag the icon rightward or leftward till the edge of the screen to move it to the next Home screen.

## Deleting from the Home screen of an application or widget

- 1 From the Home screen, touch and hold down a desired application icon or widget to delete
- 2 Drag the item to "Remove" on the top of the screen
  - A caution screen appears.
- 3 "OK"
  - The caution screen will not appear if you place a check mark on "Don't show this again" and tap.

## Changing wallpaper

- 1 From the Home screen, touch and hold down an area with no application icon or widget
- 2 Tap "Wallpapers" ► "Gallery"/"Live wallpapers"/"Multi-photo"/"Photos" or select a wallpaper from Disney wallpaper list
  - When "Gallery"/"Live wallpapers"/"Multi-photo" is selected, edit or set the image range if necessary.

## Apps Screen





### Viewing Application Screen





1 From the Home screen, tap "Apps"







- 1 "Apps" tab
- 2 "Widgets" tab
- 3 "Search" button
- 4 "Menu" button
- 5 Application icon list
- 6 Machi-chara



## Apps List



Some applications require a separate subscription (charge).

Applications not included in the folder		
	Music	Sort music files by album or artist.
	Osaifu-Keitai	It allows you to pay money only by holding the cell phone over an IC card reader in stores etc. (P124).
	おすすめアプリ (Osusume Apps)	An application to check/install applications recommended by mobile operator according to your application usage.
	Camera	Shoot still images (photos) and videos (P139).





	<b>Calendar</b>	Four arithmetic operations are available. View calendar and manage schedule (P151).
	<b>Gallery</b>	View or sort still images (photos) and videos (P144).
	<b>Disaster kit</b>	An application for using Disaster Message Board, Disaster Voice Messaging Service and Early Warning "Area Mail" (P115).
	<b>Schedule</b>	An application for creating/managing events and the data is shared with Memo application. It supports i-concier.
	<b>Settings</b>	Set various settings (P155).

	<b>Downloads</b>	Confirm, display or play the downloaded data.
	<b>Tasks</b>	An application for managing your schedule etc.
	<b>データ保管BOX (Data Storage Box)</b>	An application for using データ保管BOX (Data Storage Box). Data Storage Box is a service which allows you to upload files to easily manage them in the cloud.
	<b>TV</b>	Watch 1Seg (P129).
	<b>Calculator</b>	Four arithmetic operations are available (P154).
	<b>Phone</b>	Make a call or set up call function (P84).





	<b>Tokyo Disney Resort<sup>®</sup> Machijikannabi</b>	An app to check your present location on the map of Tokyo Disneyland <sup>®</sup> /Tokyo DisneySea <sup>®</sup> and get various information such as waiting time for attraction.
	<b>Clock</b>	Set settings of alarm, timer, world clock and use stopwatch (P149).
	<b>mail</b>	Send and receive emails through a mobile operator email address. Additionally, with d ACCOUNT, you can send, receive and read mail on multiple devices such as a tablet and PC browser using the same mail address (P105).



	<b>phonebook</b>	A phonebook application supplied by mobile operator. The phonebook data of "account" can be managed in the cloud (P100).
	<b>Instruction Manual</b>	Instruction manual for this cell phone. Available to activate a desired function directly from the description.
	<b>ToruCa</b>	An application for collecting saving coupons/convenient information from your favorite shops (P128).
	<b>Hanashite Hon'yaku</b>	An application for translating spoken words into the listener's language. This allows you to enjoy talking with people who speak languages other than your own.





	<b>File Manager</b>	Search, edit, or delete the data inside internal storage or SD card (P198).
	<b>フォトコレクション (Photo collection)</b>	A service with which you can back up photos or videos to cloud up to 5 GB for free and access them from smartphone, tablet, PC, etc.
	<b>Voice Recorder</b>	You can record voice, etc.
	<b>My Magazine</b>	My Magazine is a search service for displaying articles for categories you selected.
	<b>マネレコ (MANERECO)</b>	A household account application that enables you to check the balance of bank account or credit card bills at one time.



	<b>Messaging</b>	Available to send and receive SMS (P106).
	<b>Memo</b>	Creating/managing memos and the data is shared with Schedule application. It supports i-concier.
	<b>Character Changer</b>	A photo application that enables you to virtually become a Disney character in an image.
	<b>Disney きせかえアラーム (Disney Kisekai Alarm)</b>	A simple and user-intuitive alarm whose design theme and ringtone can be customized.
	<b>Disney Cinema</b>	Lines up the best video contents from popular live action movies to animation works provided by Disney! This is the premium video service only for you.















	<b>Disney天気予報 (Disney Weather Forecast)</b>	An application where characters change the forms depending on the weather or time. A convenient widget function is supplied.
	<b>Disneyマーケット (Disney Market)</b>	In Disney Market is a convenient portable application where you can obtain various "Disney apps" and the recommended information (P120).
	<b>Disney Music Player</b>	An original music player that can play/ manage music of Disney's and other.
	<b>Disney Welcome</b>	Special welcome movies only for users! Also enjoy messages changing in accordance with seasons and events.

	<b>Dlife</b>	Best-selected programs are delivered from "Dlife", a BS channel. Enjoy dramas, movies and variety shows which are popular worldwide anytime and anywhere!
	<b>Email</b>	Set up mail accounts to send/receive mails (P109).
	<b>Fantasmic!</b>	"Fantasmic!" is an animated wallpaper of the colossal night entertainment in which Mickey who turns into sorcerer's apprentice battles on the stage in the Mediterranean harbor.

	<b>"Happiness is Here" Live Wallpaper</b>	Provides children of all generations with music, dream and friendship... Let's share superb "Happiness". This app gives you live wallpapers of "Happiness is Here", the day parade of Tokyo Disney Resort®.
	<b>IC Tag/Barcode Reader</b>	An application for reading information written in IC tags and barcodes.
	<b>iDアプリ (iD appli)</b>	To use the electronic money of "iD" provided by mobile operator. Hold the Osaiфу-Keitai with the "iD" already been set against a scanner in a shop to do shopping easily.
	<b>Play Store</b>	Download the application from Google Play (P121).

	<b>QMemo+</b>	Create and manage memo (P153).
	<b>Twitter</b>	Official Twitter client application. Publish short message on the site to communicate with others.

Google		
	<b>Sheets</b>	Create and edit a Sheets. You can also edit with other users.
	<b>Slides</b>	Create and edit a presentation. You can also edit with other users.
	<b>Docs</b>	Create and edit a document. You can also edit with other users.
	<b>Drive</b>	Save images or videos to Google Drive or share them.
	<b>Hangouts</b>	Chat using Google Hangouts.
	<b>Photos</b>	View pictures and movies. You can also sync with Google Photos to backup images and share them with others.

	<b>Maps</b>	Check current location or search a destination with Google Maps (P148).
	<b>Chrome</b>	Google web browser application.
	<b>Gmail</b>	Use email provided by Google or other general providers.
	<b>Google</b>	Search various information by the quick search box.
	<b>Play Movies &amp; TV</b>	Purchase videos from Google Play.
	<b>Play Music</b>	Play music.
	<b>YouTube</b>	Play or post videos.

### Note



- This application list is preinstalled in this cell phone at the time of purchase. Some preinstalled applications can be uninstalled. Those uninstalled applications can be downloaded again from the "Play Store" (P121).
- If the software is updated, application contents and icon positions may change.
- Some of the applications may not show its name fully below the icon.

## Managing Applications

### Adding an application to Home screen

- 1 From the Home screen, tap "Apps"
- 2 Touch and hold down the application icon to add it to the Home screen
- 3 Drag it to the desired position and release your finger
  - The application is added to the Home screen.

### Uninstalling an application

- 1 From the Home screen, tap "Apps"
- 2 Tap  ► "Edit/Uninstall apps"
  - For applications that can be uninstalled,  is displayed at the upper right of the icon.
- 3 Tap the application to be uninstalled ► "UNINSTALL" ► "YES"

## Task Manager

Check/terminate running applications.

### 1 Tap

- Tap a thumbnail of application to start the application.
- Scroll/flick the thumbnail to right or left to delete it from the list.
- Tap "x" on the thumbnail end that application.
- Tap "Clear all" to end all the activated applications.

## Switching Home Application

- 1 From the Home screen, tap "Apps" ► "Settings" ► "Home screen"
- 2 Tap "Select Home" ► "Mobile operator home" / "Home"

# Calling

## Making a Call

- 1 From the Home screen, tap "Phone"  
▶ "Dial" tab

- 1 **"Phonebook" button**  
Activate "phonebook" application.
- 2 **Tab**  
"Dial" tab: The dial screen is displayed.  
"Recent calls" tab: Recent calls screen is displayed (P94).  
"Favorites" tab: Contacts list added to the Favorites is displayed.
- 3 **Phone number entry field**  
Display an input phone number.
- 4 **Dialpad**
- 5 **Call button**
- 6 **Menu**  
Display menu.
- 7 **Delete button**  
Delete a number at the far right. To delete all numbers entered, touch and hold the key.
- 8 **"Register" button**  
Register the entered phone number to phonebook.

## 2 Enter a phone number ►

### ■ When making video call

Tap **:** ► "Video call".

## 3 Tap "END CALL" to end a call

### Note

- You can make voice calls and video calls in high quality with VoLTE. To use VoLTE, you and the other party both need to meet the following conditions.
  - The device supports VoLTE.
  - It is within the VoLTE area.
  - The Mobile networks setting<sup>\*1</sup> is set to LTE/3G/GMS (Auto) and the call mode<sup>\*2</sup> is set to VoLTE ON.
- \*1 From the Home screen, tap "Apps" ► "Settings" ► "More..." ► "Mobile networks" ► "Preferred network type".
- \*2 From the Home screen, "Phone" ► **:** ► "Call settings" ► "Call mode setting".
- You can see each other's images while talking with video call. You can also switch to voice call.
  - When making video calls, there is a call charge and packet communication charge. In addition, there is also a packet communication charge for incoming video calls.



- Since it is a best effort communication (the optimum communication speed changes depending on the network traffic), the image quality differs depending on the network environment.
- When you could not switch to video call from voice call, a notification will be shown on the display indicating that the switching to video call failed, and voice call will continue.
- As the display processing is different for each phone model, your image displayed on the cell phone for the video call may differ to what is displayed on the other party's device.

## Entering a Pause

Use "Add 2-sec pause" or "Add wait" to dial phone number and additional code in a row when sending an additional code during a call is required for bank balance inquiries, ticket reservation services, etc.



### Adding a two seconds pause ","

Automatically dial a service number two-second pause later after calling.

- 1 From the Home screen, tap "Phone" ► "Dial" tab
- 2 Enter a phone number ►  ► "Add 2-sec pause"
  - A comma "," is displayed behind the phone number.
- 3 Enter a menu number of a desired service ► 
  - After two seconds, the push signal (number) will be sent automatically.

### Adding a standby ";"

After calling, a message is displayed to confirm the number you dialed of a desired service.

- 1 From the Home screen, tap "Phone" ► "Dial" tab
- 2 Enter a phone number ►  ► "Add wait"
  - A semicolon ";" is displayed behind the phone number.
- 3 Enter a menu number of a desired service ► 
- 4 When a confirmation message is displayed, tap "YES".
  - The push signal (number) will be sent automatically.



## Emergency Call

Emergency call	Phone number
Police	110
Fire department or ambulance service	119
Japan Coast Guard	118

### Note

- This cell phone supports "Location notification of emergency call". When dialing an emergency number such as 110, 119, or 118, information of the place where you called (location information) is automatically notified to the agency that you called (e.g. a police station). Depending on the location and the signal reception when you called, the agency may not be able to confirm your exact location. When your location information is notified, the agency name that you called is displayed on the screen of this cell phone. If you dial by adding "184" in front of your number to hide your caller ID, your location information and

phone number are not notified. However, if the agency you called considers your location information and phone number necessary for important purposes such as life saving, the agency can retrieve your accurate location information using GPS measurement and phone number regardless of your mobile settings. In addition, the introduction area and introduction timing of "Location notification of emergency call" vary depending on the readiness of the agency you called.

- When you are making an emergency call (110, 119, or 118) from this cell phone, be sure to notify that you are calling from a mobile phone and give both your mobile phone number and present location clearly as the police or fire department may call you back for confirmation. Stay where you are to ensure that your call will not be cut off during reporting. After making an emergency call, do not turn off your mobile phone immediately. Keep it powered on for about 10 minutes so that it can receive an incoming call.

- Depending on the area where you make an emergency call, it may not be connected to the jurisdictional fire department or police station.
- In Japan, when nano UIM card is not inserted in the cell phone, the emergency numbers of 110, 119, or 118 are not available on the PIN code entry screen or during PIN code lock/PUK lock.
- If you make an emergency call 110, 119, or 118 with call rejection setting enabled, call rejection setting/Blocking mode will be disabled.
- You may not be able to make an emergency call on some networks.
- You can not make emergency calls with video calls.

## Making an International Call (WORLD CALL)

**WORLD CALL** is a service enables you to make an international call in Japan via mobile operator terminals.

- Contact "General Inquiries" on the back cover of this manual for detailed information about WORLD CALL.
- "Using Overseas" → P211

### Calling a fixed-line telephone

- 1 From the Home screen, tap "Phone" ► "Dial" tab
- 2 Input "010" ► country code ► area code ► recipient's phone number, and tap 
- 3 Tap "END CALL" to end a call

### Calling a mobile phone

- 1 From the Home screen, tap "Phone" ► "Dial" tab
- 2 Input "010" ► country code ► recipient's mobile phone number, and tap 

### 3 Tap "END CALL" to end a call

#### Note

- If the mobile phone number or an area code of the other party begins with "0", remove the first "0". However, the first "0" is required when calling to some countries or regions such as Italy.
- "+" (touch and hold down "0" to input "+") and the former "009130010" can also be used to dial instead of "010".
- On "Dial" tab, enter a phone number ▶ 
  - ▶ "International call" ▶ select a country
  - ▶ "WORLD CALL" to add "009130010" + country code.

## Receiving a Call

### For Voice Calls

- Incoming call while activating an application → P90

#### 1 When there is an incoming call

The incoming call screen (full-screen) appears.

- Answering memo recording: Tap  ▶ "Play reply message"
- Stop ring tone, vibration: Press power key, or volume (up)/volume (down)

#### 2 Tap ▶ "ACCEPT"

- Declining a call: "REJECT"
- Rejecting a call: "Reject call with SMS" ▶ tap a message to send



#### 3 Tap "END CALL" to end a call

## For Video Calls

- Incoming call while activating an application → P90

### 1 When there is an incoming call

The incoming call screen (full-screen) appears.

- Rejecting a call: Tap  ► "Reject call with SMS"
- Answering memo recording: Tap  ► "Play reply message"
- Self image is not being sent to the other party: Tap  ► "Camera OFF response"
- Stop ring tone, vibration: Press power key, or volume (up)/volume (down)

### 2 Tap ► "ACCEPT REJECT"

- Answer by voice: Tap  ► "Accept voice"
- Rejecting a call: "REJECT"

### 3 Tap "END CALL" to end a call

#### Note

- From the Home screen, tap "Phone" ►  ► "Call settings" ► "Rejection SMS" to edit a reject SMS.

## Incoming Call While Activating an Application

If there is an incoming call while activating an application, the popup screen will be displayed on the top screen. Tap "ACCEPT"/"ACCEPT VIDEO" to start the call.

- When the popup incoming screen is displayed, if the caller's name or the phone number area is tapped, the incoming call screen (full screen) can be displayed.

#### ■ Incoming voice call

#### ■ Incoming video call

## Calling/Sending an SMS to a Missed Call

When you have a missed call, you can check the notification from status bar.

**1** If  appears in the status bar, drag or swipe the status bar downward

- Missed call notification appears on the notification panel.

**2** Tap "Missed call"/"CALL"/"SEND SMS"

- "Missed call": Recent calls are displayed.
- "CALL": Make a call.
- "SEND SMS": Message input screen is displayed. Compose a message and tap "Send" to send the message.

## Operations during a Call

The following operations are available while talking on the phone.

- Press the volume key (up)/volume key (down) during a call to adjust the volume.

## For Voice Calls

- 1 Name and phone number**
- 2 End**  
End a call.
- 3 Dialpad**  
Display dialpad and send push signal (DTMF tone).
- 4 Hold\*<sup>1</sup>**  
Put a call on hold.
- 5 Display submenu**  
Switch ON/OFF for Mute or add another call by using Catch Phone\*<sup>2</sup>.
- 6 Call duration**
- 7 High-quality sound indication**  
Appears when using a call with high quality sound of VoLTE.
- 8 Speaker\*<sup>1</sup>**  
You can hear the other party's voice through speaker to talk hands-freely.
- 9 Switch to video**  
Switch to video call.

\*1 Tap again to return to the previous state.

\*2 Subscription is required for "Call waiting".

## For Video Calls

- 1 The other party's image**  
Depending on the other party's setting, a substitute image may be displayed.
  - When the other party's image cannot be received,  appears.
- 2 Your own image**
- 3 Switching cameras**  
Switch the cameras for the image to send to the other party from the front camera/main camera.

#### 4 End





End a call.

#### 5 High-quality sound indication

Appears when using a call with high quality sound of VoLTE.

#### 6 Menu

Display the menu for calling screen.

- Tap  ► "Switch to voice call" to switch to voice call.
- Tap  ► "Dialpad" to turn off the camera and display the dial screen.
- Tap  ► "Switch audio output destination" to switch audio output ports.
- Tap  ► "Camera OFF" to stop sending video to the other party.
- Tap  ► "Switch video area" to switch "Your own image" display area and "The other party's image" display area.

#### 7 Call duration

#### 8 Mute

Your voice cannot be heard by the other party.

### Note

- While talking on a video call, tap the video screen to switch between display video full screen and cancel full screen.
- While talking on a video call, if the application is switched from "Phone", the video will not be sent to the other party any more.
- While talking on a voice call, if the other party switches it to the video call, a popup screen will appear to confirm that it has been switched to video call. Tap "ALLOW" so that it becomes video call screen.

## Call Logs

On the Recent calls screen, you can check logs of dialed calls, received calls, missed calls in the list.

- Up to 500 items can be displayed.

- 1 From the Home screen, tap "Phone"  
▶ "Recent calls" tab

- 1 **Phonebook**

Activate "phonebook" application.

- 2 **Tab**

"Dial" tab: The dial screen is displayed (P84).

"Recent calls" tab: Recent calls screen is displayed.

"Favorites" tab: Contacts list added to the Favorites is displayed.

- 3 **Switch logs**

- Switch display between Incoming and Outgoing.
- Tap "All" to display all incoming/outgoing call logs.

- 4 **Name, Phone number, Call date and time**

- Tap to open the Recent calls screen. Tap an item on the Outgoing screen to make a call, send an SMS, make a video call, save in the phonebook, show profile screen, etc.
- Touch and hold an item to set "Edit number before call", "Delete from call log", "Register as blocked number", "Register to Favorites", "Search location", etc.

- 5 **Menu**

Display menu.

- 6 **Outgoing, incoming, missed calls**

The difference between voice and video calls are not shown.



## 7 Voice call key

Make a voice call to the number in the call log.

## Deleting History





- 1 From the Home screen, tap "Phone"  
▶ "Recent calls" tab
- 2 Tap ⋮ ▶ "Delete log"
- 3 Place a check mark in the history to be deleted or in "Select all" ▶ "Delete" ▶ "Delete"
  - The history is deleted and it goes back to "Recent calls" tab screen.

## Answering Memo

When you cannot answer a call, playback reply message and record an answering memo.

- 1 From the Home screen, tap "Phone"  
▶ ⋮ ▶ "Call settings"
- 2 "Answering memo"
- 3 Place a check mark in "Answering memo"
  - "Answer time": Available to set from 0 to 120 seconds.
  - "Reply message": Set a reply message during an incoming call.

## Note

- You can record a piece of answering memo up to 60 seconds with total 20 pieces of answering memos. However, if there are answering memos which have been played, when saving the next answering memo, those which have been played are deleted from the oldest one so that the new one can be saved.
- If you answer a video call by answering memo, the call automatically switches to a voice call and the message is recorded.
- To check the answering memo you recorded, drag or swipe the status bar downward with  displayed on the status bar ▶ "New answering memo", or from the Home screen tap "Phone" ▶  ▶ "Call settings" ▶ "Answering memo". ▶ "Play answering memo". Tap a answering memo to playback and tap again to stop playback.
- To delete the recorded answering memo, from the Home screen, tap "Phone" ▶  ▶ "Call settings" ▶ "Answering memo" ▶ "Play answering memo" ▶  ▶ "Select all" or place a check mark in a answering memo you want to delete ▶ "DELETE" ▶ "YES".

## Call Settings

Set call settings.

- 1 From the Home screen, tap "Phone" ▶  ▶ "Call settings"

Network service	Vicemail service*	Set to activate/deactivate this service.
	Call forwarding service*	Set to activate/deactivate this service, or change forwarding number.
	Call waiting*	Set to activate/deactivate this service, or confirm settings.
	Caller ID notification	Set caller ID notification or confirm settings.

<b>Network service</b>	<b>Nuisance call blocking service</b>	Register, delete or confirm number of registrations.
	<b>Caller ID display request service</b>	Playback a guidance to inform the caller to show his/her phone number, then end the call automatically.
	<b>Second call settings*</b>	Set to activate/deactivate this service, or confirm settings.
	<b>Call notification</b>	A missed call is notified by SMS when the power is off, when you are out of service or when it is unavailable to receive a call.

<b>Network service</b>	<b>English guidance</b>	Guidance such as voice guidance or Network service guidance is played back in English.
	<b>Remote operation settings</b>	Set remote operation settings to operate remotely from a mobile phone, or a fixed line telephone.

<b>Network service</b>	<b>Public mode (power OFF) settings</b>	While the cell phone is OFF or in Airplane mode, a guidance message indicating that the receiver is in a place where power should be turned off is heard on the caller's terminal and then the call ends.
<b>Roaming settings</b>		(P217)
<b>SOUND &amp; VIBRATION SETTINGS</b>		
<b>Phone ringtone</b>	Set phone ringtone.	
<b>Vibrate on ring</b>	Set to vibrate or not with an incoming call.	

<b>Dialpad touch tones</b>	Set to turn on the dialpad touch tone or not when tapping dial pad.
<b>INCOMING CALL SETTINGS</b>	
<b>Answering memo</b>	(P95)
<b>Reject call setting</b>	Set to ON to set incoming call rejection from non-registered numbers, anonymous numbers, pay phones, or numbers that cannot be informed.
<b>Reject SMS</b>	Reject an incoming call and edit reject SMS message.

OUTGOING CALL SETTINGS	
<b>Sub address settings</b>	Set delimiter when calling with a sub address. ** is a separator for sub address.
<b>Prefix settings</b>	Edit, add or delete a prefix. Register an international number or area number to add before calling.
OTHER SETTINGS	
<b>Call mode setting</b>	Set whether to use VoLTE when VoLTE calling is available.

<b>Call time</b>	Display or reset the cumulated call time. Set whether to reset the cumulated call time on the first day of each month.
<b>Gestures</b>	Set whether to mute the ringtone by turning the cell phone upside down.
<b>Contact mobile operator</b>	Inquire mobile operator about malfunctions, loss/theft while overseas. Also you can call General Inquiries to mobile operator.
<b>Open source licenses</b>	Open source license is displayed.

\* Not available for video call.

## Phonebook

Manage various contact information such as names, phone numbers or mail addresses using "phonebook" application provided by mobile operator.

- For using the cloud service on phonebook, phonebook application is required.
- When you activate "phonebook" for the first time (including after resetting the application), "Use of Cloud" screen appears and set to use Cloud.

## Registering to Phonebook

Register a new contact.

- 1 From the Home screen, tap "Apps"  
▶ "phonebook" ▶ "Contacts" tab
- 2 "Register"

### 1 Account

A saving account appears.

- Tap "Set" to select an account.

### 2 Image field

Tap "Set" to register an image.

To take a photo, tap "Take photo". To select a saved image, tap "Select picture".

### 3 Last name, first name

### 4 Label key

Select a content label (item).

Tap "Custom" to make a new label.

### 5 Input field

Input phone number, mail address, address, etc.

### 6 Group

Tap "Set" to select a group.

### 7 Ring tone setting button

### 8 Add other items

Input the address, nickname, memo, etc.

- \* Displayed only when a group is registered.

## 3 "Save"

## Confirming/Using Contacts

### 1 From the Home screen, tap "Apps"

#### ▶ "phonebook"

- A contact list screen appears.

### 1 "Contacts" tab

Display the contact list screen.

### 2 Name registered in the phonebook

### 3 Photo set in the phonebook

- 4 **Register (P100)**  
Add new contacts.
- 5 **Start/Stop synchronize cloud**
- 6 **Menu**  
Display menu.
- 7 **"My profile" tab (P104)**  
Profile screen appears. You can check the phone number, edit/manage your own profile information.
- 8 **"Group" tab (P103)**  
Tap to select a group and display the contacts in groups.
- 9 **Index character display area**  
Tap "Index" to display index characters by which you can search a name in the order of the Japanese syllabary, alphabet, etc.
- 10 **Index**  
Display the index character display area.
- 11 **Search**  
Search contacts.

- 2 **Tap a contact to confirm or use**
  - Profile screen is displayed.
  - Tap "Edit" to edit contacts.
  - Tap  in phone number field to make a call. Or tap the phone number to create SMS or make video call.
  - To create a mail, tap a mail address and select an application.

## Changing Displayed Account on Phonebook

- 1 From the Home screen, tap "Apps"  
▶ "phonebook" ▶ "Contacts" tab
- 2 Tap  ▶ "Settings" ▶ "Accounts to display"
- 3 Set an account to display ▶ "OK"



## Deleting Contact

- 1 From the Home screen, tap "Apps" ► "phonebook" ► "Contacts" tab
- 2 Tap a contact
- 3 Tap  ► "Delete" ► "OK"

### Note

- On "Contacts" tab, tap  ► "Delete contact" ► "Select all" or place a check mark in the contact you want to delete ► "OK" ► "OK".

## Adding/Editing a Group

- 1 From the Home screen, tap "Apps" ► "phonebook" ► "Group" tab
- 2 "Add group"
  - To edit a saved group  
Tap a group you want to edit ► "Edit" ► Edit ► and then tap "OK".
  - To delete groups  
Tap  ► "Delete group" ► place check marks in the groups you want to delete ► "OK" ► "OK".

- To change display order of groups  
Tap "Sort" ► Tap a group ► Drag the group to a desired place ► "OK".

- 3 Select an account ► Enter a group name ► Select an icon and color
- 4 "OK"

### Note

- You can set color or icon to a created group or change order in the group list only for the groups saved in account.

## Adding contacts to group

- 1 From the Home screen, tap "Apps" ► "phonebook" ► "Group" tab
- 2 Tap a group ► "Add member" ► Place check marks in the contacts to add ► "OK" ► "OK"

### Note

- Only contacts saved in account or Google account can be added to the group.

## Deleting contact from group

- 1 From the Home screen, tap "Apps" ► "phonebook" ► "Group" tab
- 2 Tap a group ► "Delete member" ► Place check marks in the contacts to delete ► "OK" ► "OK"

## Registering My Profile

You can confirm your phone number, and add, edit or delete your profile information.

- 1 From the Home screen, tap "Apps" ► "phonebook" ► "My profile" tab
- 2 Tap "Edit" ► Enter the required items ► "Save"

## Importing/Exporting Contacts

Import contacts or send the contacts as the contact data (vCard) between nano UIM card and this cell phone.

- 1 From the Home screen, tap "Apps" ► "phonebook" ► "Contacts" tab

- 2 Tap : ► "SD card/SIM card/common"

- 3 Select an item

**Restore from SIM card:** Type of phone numbers and mail addresses are imported as "Others".

**Activate backup app:** Use backup application to back up and restore phonebook data and other data all at once.

**Send all data (common):** Activate the application such as Bluetooth® communication, mails, etc. and send all the contact data.

\*It is not supported for some applications.

# Mail/Web Browser

## mail

You can send and receive emails using a mobile operator mail address.

Since sent/received mails are stored to mail server, your mails can be transferred easily in case the cell phone is lost or you change the model. Additionally, with

d ACCOUNT, you can send, receive and read mail on multiple devices such as a tablet and PC browser using the same mail address. For details of mail, refer to mobile operator Website.

### 1 From the Home screen, tap "mail"

- After that, follow the on-screen instructions.

### Note



- Follow the procedures below to change the mail screen theme to "Disney Electrical" theme.  
From the Home screen, tap "mail" ▶ "More" ▶ "Mail settings" ▶ "Display settings" ▶ "Theme" ▶ "Disney Electrical" ▶ "OK" ▶ "OK".

## SMS

You can send/receive text message to/from mobile phone number as a recipient.

- \* For details of available number of characters, etc, refer to "Short Message Service (SMS)" on mobile operator Website.

### Sending SMS

- 1** From the Home screen, tap "Apps"  
▶ "Messaging"
  - The "Messaging" screen is displayed.
- 2** 
- 3** Tap "To" box to enter a recipient's phone number
  - Tap  to display phonebook and select a recipient.
- 4** Enter a message in "Enter message" box
- 5** "Send"
  - The message is sent.

### Note

- Default message application can be changed to Hangouts. → P179
- While entering a message, tap  ▶ "Insert smiley" to inset a smiley.
- You can also send/receive text messages to/from customers using overseas network operators. For available countries/overseas network operators, see mobile operator Website.
- To send SMS to users of overseas network operators, enter "+" ▶ "Country code" ▶ "Recipient's mobile phone number". If the mobile phone number begins with "0", enter the number excluding the first "0". You can also send an SMS by entering "010", "Country code" and "the recipient mobile phone number".

### Receiving/Viewing SMS

- 1** From the Home screen, tap "Apps"  
▶ "Messaging"
  - The thread (recipient who send or receive messages) list is displayed on the "Messaging" screen.
- 2** Tap a thread
  - A message appears.

## Changing SMS Settings

- 1 From the Home screen, tap "Apps"  
▶ "Messaging"
  - "Messaging" screen is displayed.
- 2 Tap  ▶ "Settings"
- 3 Change the settings if necessary

NOTIFICATIONS		
Notifi cation settings	Notifi cations	Set to display the notification of new messages or not.
	New message pop-up <sup>*1</sup>	When sending/ receiving a message, set to display a new message as a popup or not. On the popup screen, you can reply, display the sender and message contents, and clear the popup screen.

Notifi cation settings	Preview <sup>*1</sup>	Set to display the message text or not when receiving a message.
	Notifi cation sound <sup>*1</sup>	Set ring tone when receiving a message.
	Vibrate <sup>*1</sup>	When receiving a message, set to notify by vibration or not.
	Repeat alert <sup>*1</sup>	Set to notify repeatedly or not.
MESSAGES		
Text messages		Set to request a delivered confirmation report for all messages that are sent or not, and set the message center etc.

GENERAL		
General settings	Conversation theme	Set thread wallpaper and bubble style. <ul style="list-style-type: none"> <li>Tap "Gallery"/"Camera" in "Wallpaper" tab to set a still image saved on this cell phone or taken by the camera as the thread wallpaper.</li> </ul>
	Connect to URL	Set to open a web page by tapping a URL in a message or not.
	Quick message	Add/edit a phrase.
	Send message with Enter key	Set to send a message via Enter key or not.

General settings	Delete old messages	Set whether to delete messages from the old one when sending/receiving a new message and the number of messages reaches its maximum.
	Text message limit <sup>*2</sup>	Set the maximum number of text messages.

- \*1 This can be set only when a check mark is placed on "Notifications".
- \*2 This can be set only when a check mark is placed on "Delete old messages".

## Email

You can set a POP3- or IMAP-compatible Email account provided by a general service provider to send/receive email.

### Setting Email Account

Get the necessary information for settings beforehand from your service provider.

#### 1 From the Home screen, tap "Apps"

##### ▶ "Email"

- The "Select email provider" screen is displayed.

#### 2 Select a provider

#### 3 Input an Email address and its password, etc.

#### 4 Tap "MANUAL SETUP" / "NEXT"

- Follow the on-screen instructions.
- Select account type when tapping "MANUAL SETUP". Follow the on-screen instructions to make the settings. For information about the settings, contact your service provider.

#### Note

- You can change the settings later. For details, refer to "Setting Account" (P112).

### Displaying Received Email

#### 1 From the Home screen, tap "Apps"

##### ▶ "Email"

- New emails are received automatically.





#### 2 On "Inbox" screen, tap an email

- The message is displayed on email screen.

#### Note

- If a check mark is not placed on "Auto-sync email", a new mail is not received automatically (P112).
- If you have registered more than one account, on "Inbox" screen,  tap a registered account and change it.

## Creating and Sending Mail

- 1 From the Home screen, tap "Apps"**
  - ▶ "Email"
  - The "Inbox" screen is displayed.
- 2** 
- 3 Tap "To" box to enter a recipient's email address**
  - A list of contacts beginning with the entered number or name is displayed.
  - Tap  to display phonebook and select a recipient.
- 4 Enter a subject in the "Subject" box**
  - Tap  ▶ "Priority" ▶ "High"/"Normal"/"Low" to set the priority for mails and display the icon in the subject box. The icons indicate the following:  
! : High   None: Normal   ↓ : Low
- 5 Enter a message in the message box**
  - When attaching a file, select  ▶ file.
- 6** 
  - The email is sent.

### Note

-  appears on the right side of "To" box if an invalid email address is entered. Check the email address and correct it.

## Adding an Account

You can add more than one account on "Email" application.

- 1 From the Home screen, tap "Apps"**
  - ▶ "Email"
  - The "Inbox" screen is displayed.
- 2 Tap  ▶ "Settings"**
- 3 "Add account"**
- 4 Select an email provider**
- 5 Enter an email address and password**
- 6 Tap "MANUAL SETUP" / "NEXT"**
  - Follow the on-screen instructions.
  - Select account type when tapping "MANUAL SETUP". Follow the on-screen instructions to make the settings. For information about the settings, contact your service provider.



## Changing Email Settings

### Basic settings

- 1 From the Home screen, tap "Apps"  
▶ "Email"
  - The "Inbox" screen is displayed.
- 2 Tap  ▶ "Settings" ▶ "General settings"
- 3 Change the settings if necessary

DISPLAY	
Email preview	Set the number of lines to show an email preview.
Conversation view	Set to display the sent/received mails of the same subject on one thread or not.
Split view	Set to split view or not when displaying by landscape screen.
DETAIL SETTINGS	
Set default account	Set the default account settings.

VIP settings	Even when the Email notification is set to OFF, the received mails are notified from the senders that have been registered on the VIP list.
Save to	Set the destination to the internal storage or microSD card.
Ask before deleting	Set to display the confirmation screen or not when deleting an email.
Auto-advance	Select a screen to display after deleting/moving an Email.
Load images	Set whether to display images by downloading automatically.

## Setting account

- 1 From the Home screen, tap "Apps"  
▶ "Email"
  - The "Inbox" screen is displayed.
- 2 Tap **⋮** ▶ "Settings" ▶ tap an email account
- 3 Change the settings if necessary

DISPLAY NAMES	
Account name	Set account name.
Your name	Set user name.
Signature	Set to use signature or not.
Edit signature	Edit signature contents.

NOTIFICATION SETTINGS	
Notifications	Set to show the notification or not with an incoming email.
Notification sound	Set notification sound.
Vibrate	Set to vibrate or not with an incoming email.
SYNC SETTINGS	
Auto-sync email	Set the auto-sync for emails.
Sync schedule	Set the sync on peak time, peak day, peak time period, etc.

<b>Email sync period<sup>*1</sup></b>		Set the interval of period to synchronize the Emails.
<b>Message size limit</b>		Set message size.
<b>ADVANCED SETTINGS</b>		
<b>Advanced settings</b>	<b>Number of email to show<sup>*2</sup></b>	Set the number of emails to display.
	<b>Auto-download attachments<sup>*1</sup></b>	Set whether to download the attached file automatically when receiving an email during Wi-Fi® connection.
	<b>Always Cc/ Bcc me</b>	Set to always add yourself to Cc/Bcc or not.
	<b>Auto-resend times</b>	Set the number of times for auto sending.

<b>Advanced settings</b>	<b>Delete from server<sup>*2</sup></b>	Set the timing to delete from server.
	<b>Security settings</b>	To protect Emails, set a digital signature or encryption.
	<b>SERVER SETTINGS</b>	
	<b>Incoming server settings</b>	Change the incoming server settings.
	<b>Outgoing server settings</b>	Change the outgoing server settings.

\*1 Not displayed with POP3.

\*2 Displayed only with POP3 account.

## Gmail



Gmail is an online email service of Google. You can send and receive emails by using Gmail pre-installed in this cell phone.

- To use Gmail, you need to set up the mail address. When the mail address setting screen is displayed, follow the on-screen instructions to set up before implement the Gmail.
- For details on Gmail, from Gmail screen, tap  ► "Help & feedback" to refer.

## Opening Gmail

- 1 From the Home screen, tap "Google" ► "Gmail"**
  - When a screen which shows new functions of Gmail is displayed, follow the on-screen instructions to operate it.
- 2 Tap an email you want to read**
  - Content of the selected email appears.

## Creating and Sending Gmail

- 1 From the Home screen, tap "Google" ► "Gmail"**
- 2 **
- 3 Enter email address in the "To" box**
- 4 Enter a subject in the "Subject" box**
- 5 Enter a message in the "Compose email" box**
  - When attaching a file, select  ► file.
- 6 **
  - The email is sent.

## Early Warning "Area Mail"

Area Mail is a service with which you can receive emergency earthquake flash reports delivered by the Meteorological Agency etc.

- Area Mail is a free service that does not require application.
- You can save up to 50 mails.
- Area Mails cannot be received when the power OFF, in Airplane mode, during International roaming, while displaying the PIN code entry screen, etc. Also if the cell phone is low on memory, receiving Area Mail may fail.
- Unreceived Area Mail cannot be received later.

Area Mail (Tsunami Warning/Disaster/Evacuation information) is resent, so you can receive the unreceived ones.

## Receiving Early Warning "Area Mail"

When Area Mail is received, the Area Mail buzzer or ringtone sounds, a notification icon appears on the status bar, and receiving screen opens.

- The Area Mail buzzer or ringtone sounds in maximum volume. The setting cannot be changed.
- The Area Mail buzzer or ringtone sounds even in manner mode (Vibrate only, Silent) at the time of purchase. Setting not to sound in manner mode is available (P116).

## Viewing Area Mail

- 1 From the Home screen, tap "Apps" ► "Disaster kit" ► "Early Warning 'Area Mail'"
- 2 Tap an Area Mail

## Deleting Area Mail

- 1 From the Home screen, tap "Apps" ▶ "Disaster kit" ▶ "Early Warning 'Area Mail'"
- 2 Place a check mark in the desired area mail to delete ▶ "Delete" ▶ "OK"
  - To select all, tap "Select all".

## Setting Early Warning "Area Mail"

You can set whether to receive Area Mail or behavior when Area Mail is received.

- 1 From the Home screen, tap "Apps" ▶ "Disaster kit" ▶ "Early Warning 'Area Mail'"
- 2 Tap  ▶ "Settings"
- 3 Change the settings if necessary

Receive setting	Set whether to receive Area Mail.
-----------------	-----------------------------------

Beep tone	Set the buzzer sound, ring time of beep tone and the performance of manner mode (Vibrate only, Silent).
Check screen image and beep tone	Check receiving screen and buzzer or ringtone for Earthquake Early Warning, Tsunami Warning and Disaster/Evacuation information.
やさしい日本語表示 (Simple Japanese display)	Set whether to display Earthquake Early Warning and Tsunami Warning in simple Japanese.

## Browser

Browser allows you to view web pages in the same way that you do on a PC.

On the cell phone, web browser can be used via a packet communication or Wi-Fi® connection.

### Opening Browser

#### 1 From the Home screen, tap "Chrome"

- A web page is displayed.

#### 1 Search box



Tap to display the search box. Enter the text or URL to search, and a list of web pages or search candidates that match the entered characters are displayed.

Tap one from the list to display the web page.

#### 2 Home

Tap to display the web page that is set as homepage.

#### 3 Switch windows

- Tap  to open a new browser.
- Tap  to display the menu.
- Tap "X" to close the window.

#### 4 Menu icon

Display browser menu (P118).

### Note

- When search box and icon are not displayed on the top of the screen, scroll the browser screen downward to show them.
- Pinch out or pinch in a web page to zoom in or zoom out the display.
- Even the web page is made for a PC, you can also zoom in, zoom out or scroll the display. For detailed information, refer to "Touch screen operations" (P52).
- Depending on the format and content of a web page, the operations can be different.

- Touch and hold down the text of a web page to select. The following menus are displayed when the text is selected.
  - "SELECT ALL": Select the entire text inside a web page.
  - "COPY": Copy text.
  - "SHARE": Send text through application or service.
  - "WEB SEARCH": Search the text in websites. If icons are not displayed, tap .
- For details about file formats available to display and play back on this cell phone, refer to "File format" (P246).

### Opening incognito tab

You can browse web pages without leaving any browsing history or searching history.

**1** From the Home screen, tap "Chrome" ►  ► "New incognito tab"

- A new tab opens and the description of secret mode is displayed.

**2** Input the search words or URL in the search box and display the web pages

### Note

-  is displayed in Search box.
- It does not leave any history with the web page opened in secret tab. Cookie record is deleted when closing the tab. The downloaded files and the web pages added to bookmark can be saved.

## Using Browser Menu

**1** From the Home screen, tap "Chrome" ► 

New tab	A new window opens and the most frequently used websites are displayed.
New incognito tab	Open a new secret tab (P118).
Bookmarks	The bookmark screen is displayed.
Recent tabs	Display the recently-used tab.
History	Display the history screen.





Share...	Use an application or service to share web page.
Print...	Print out a web page, or save it as a PDF file (P208).
Find in page	Enter a keyword to search strings inside the web page.
Add to Home screen	Add to Home screen.
Request desktop site	Display a website for PC.
Settings	Display the basic settings or detailed settings of the browser.
Help & feedback	Display the help for Chrome.

## Using Bookmark and History

Add a web page to bookmarks to quickly access to the web page. You can display browsing history to view web pages your visited previously.

### Adding bookmark

- 1 From the Home screen, tap "Chrome" ► display the web pages to be added to the bookmark
- 2  ► 

### Opening a web page added to bookmarks

- 1 From the Home screen, tap "Chrome" ►  ► "Bookmarks"
- 2 Tap a bookmark to display

# Apps

## Disney Market

With Disney Market, you can download various contents for free such as Disney apps or Deco-mails®, or view recommended Disney information.

- 1 From the Home screen, tap "Disneyマーケット (Disney market)"
- 2 Follow the on-screen instructions to operate

### Note

- Contents provided in Disney Market are service provided by The Walt Disney Company (Japan) Ltd.
- Subscription to sp-mode is required to use Disney Market.
- Packet communication charges are incurred separately.

- If you subscribe charged mobile services on a monthly basis such as Disney official mobile website or smartphone contents provided by Disney, you are charged separately unless you cancel the subscription by yourself.  
To cancel, from the Home screen, tap "Disneyマーケット (Disney Market)" ▶ ≡ ▶ "マイページ (My page)" ▶ "マイメニュー (My menu)" ▶ "退会 (Cancel)" and follow the on-screen instructions to operate.
- Charges may be incurred for using part of options for games in some apps.
- Subscription to the membership for Disney Market is required to use apps provided by Disney (including pre-installed apps).

### ■ Signing up for Disney Market and inquiring about Disney apps or content

- Disney Internet Service Customer Center: 0000-00-0000
- Business hours: 10:00 to 17:00 (Monday through Friday excluding national holidays, new years holidays)

- \* Contact 000-000-0000 from a PHS/part of IP phones/outside of Japan or refer to (<http://disney.jp/dmd/faq/>) (in Japanese only).

## Play Store

Google Play enables you to access applications and games you like and download them to install into this cell phone.

- To use Google Play, Google account is required (P186).

## Installing an Application

- 1 From the Home screen, tap "Play Store"
- 2 Search application ► Tap the application that you want to install
- 3 Tap "INSTALL" (for free applications), or Amount field (for paid applications)
  - The displayed content differs depending on the application.
  - If the application needs to access data and functions on this cell phone, the functions used by the application are displayed.

## 4 "ACCEPT"

- For paid applications, if you have not registered a payment method with your account, additional screen for payment method is displayed. Tap it and follow the on-screen instructions.
- You are taking responsibility when using applications on this cell phone starting from installing and purchasing the applications. Pay special attention to application that is accessing multiple functions or large amount of data.
- If installation is finished normally, the notification icon will be displayed in the status bar. Display the notification panel and tap the application name. The installed application opens.

## Purchasing an application

- Payment for application is only once. After downloading, you do not need to pay every time when you uninstall and download again.
- If you have another Android device that is using the same Google account, you can install for free on that device once you purchased the application.
- After purchasing application, you can request a refund within a specified time. The application is deleted, and it will not be charged. Requesting a refund is available only once for the first time of purchasing each applications. After requesting a refund to a purchased application, and purchasing the same application again, you cannot request a refund.
- If you need more information about Google Play, tap ☰ ► "Help & Feedback" when Google Play screen is open.

## Note

- Be sure to check the security of application, and then install it at your own risk. This cell phone may be infected with a virus and the data may be damaged.
- Mobile operator is not liable for malfunctions, if any, caused by the application you installed. In that case, you need to pay for repair even when it is within guarantee period.
- Mobile operator is not liable for any disadvantage brought to you or any third party due to an application you installed.
- Some applications automatically perform packet communications. Packet communication is kept active unless you disconnect or it is timed out.
- If you need more information about Google Play, tap ≡ ► "Help & Feedback" when Google Play screen is open.

## Uninstalling an Application

- 1 From the Home screen, tap "Play Store"
- 2 Tap ≡ ► "My apps" ► Tap the application that you want to uninstall
- 3 "UNINSTALL"
- 4 "OK"
  - When the "REFUND" is not displayed on paid application, the trial period is expired.

## Osaifu-Keitai

You can use "Osaifu-Keitai compatible service" for payment or coupon by just holding this cell phone and against a store reader, or "かざしてリンク対応サービス (Kazashite-Link services)" for accessing information by holding it against home electrical appliances, smart poster, etc. Electronic money and point values can be stored on IC cards, or on nano UIM card. Additionally, you can check credit, balance or points of your electronic money, as well as lock Osaifu-Keitai to prevent any loss. For details about Osaifu-Keitai, refer to mobile operator Website.

- To use Osaifu-Keitai compatible services, it is necessary to make settings through sites or applications.
- If this cell phone has a problem, data<sup>\*1</sup> in the IC card and data<sup>\*2</sup> in the nano UIM card may be lost or changed (if this cell phone needs repair, terminals with data cannot be accepted, so principally the user needs to delete the data). For more information about reissuing and restoring data, and support for saving and transferring data, contact the Osaifu-Keitai compatible service provider. Please use Osaifu-Keitai compatible services that provide backup services to save your

important data.

- If you use a nano UIM card of the previous model, to use Osaifu-Keitai compatible services, install and set the application of Osaifu-Keitai compatible service providers.
- We are not responsible for damages such as lost or changed data in the IC card and in the nano UIM card, or other damages related to Osaifu-Keitai compatible services in any cases including cell phone malfunction or cell phone replacement.
- If a cell phone is stolen or lost, please immediately contact your Osaifu-Keitai compatible providers for what to do.
  - \*1 Data which is stored on the IC cards that Osaifu-Keitai compatible terminals are equipped with
  - \*2 Data which is stored on nano UIM card

## Using "Osaifu-Keitai Compatible Service"

To use Osaifu-Keitai compatible services, from the Osaifu-Keitai compatible site, download the application for Osaifu-Keitai and then configure settings. Some services do not require downloading of an Osaifu-Keitai compatible application.

### 1 From the Home screen, tap "Apps"

#### ▶ "Osaifu-Keitai"

- Obtain service information and update a service list.
- Initial settings may be required at the first startup. Follow the on-screen instructions.

### 2 Tap a service that you want to use

### 3 Set service settings

### 4 Hold mark over the reader

- Communication with the reader is performed.

### Note

- You can read/write data with reader without activating Osaifu-Keitai compatible application.
- It is available even when you turn off power of this cell phone. It may become unavailable if you have not turned on this cell phone for a long period of time or the battery level is low.
- According to the installed Osaifu-Keitai application or its setting status, during screen lock or when the screen is off, the service may not be available by holding the cell phone over the IC card reader.
- Osaifu-Keitai compatible services can be used even if the nano UIM card PIN code cannot be unlocked, or if the PIN code is locked.
- If sp-mode was not subscribed to, please note that some of the functions of Osaifu-Keitai compatible services might no longer be able to be used.



## Using "かざしてリンク対応サービス (Kazashite-Link services)"

Activate "Reader/Writer, P2P" in advance → P166

- 1 Skim a device with NFC module inside or a smart poster over the  mark on this cell phone

## Notes on Holding over Device

Notes when holding over reader, NFC Modules built-in device, etc.

- When holding over  mark, bring it close to the device slowly.
- Hold the  mark parallel to the center of reader. If it cannot be scanned even with it held in front of the center scanner, slightly lift up this cell phone, or move it backwards/forwards or to the left/right.
- When there is a metal object between the  mark and the device, reading may fail. Note that putting this cell phone into a case or cover may affect communication performance, take it out from case or cover.



## Locking Osaifu-Keitai

Use "NFC/Osaifu-Keitai lock" to lock the Osaifu-Keitai service from being used. Locking of Osaifu-Keitai is different from screen lock and SIM card lock.

**1** From the Home screen, tap "Apps" ► "Osaifu-Keitai"

**2** Tap "Lock Settings" ► Enter a password ► "OK"

- Setting password is required for the first activation. Follow the on-screen instructions to set password.



**■ To unlock**

Tap "Lock Settings" ► Enter a password ► "OK".

**■ To change password**

From the Home screen, tap "Apps" ► "Settings" ► "More..." ► "NFC/Osaifu-Keitai settings" ► "Lock password change" ► Input the current lock password ► "OK" ► Input a new lock password ► "OK" ► Input the new lock password again ► "OK".

### Note

- While configuring "NFC/Osaifu-Keitai lock",  or  are displayed on the status bar.
- This cannot be unlocked even if the power is shut off.
- If the battery runs down during the configuring of "NFC/Osaifu-Keitai lock", "NFC/Osaifu-Keitai lock" can no longer be unlocked. Be careful of the battery level. Make sure to unlock "NFC/Osaifu-Keitai lock" after charging this cell phone.
- In order to be able to use the Osaifu-Keitai menu during the configuring of "NFC/Osaifu-Keitai lock", the lock needs to be unlocked.
- The password for "NFC/Osaifu-Keitai lock" is not deleted even if this cell phone is initialized.
- Since the lock might need to be unlocked and the password might need to be changed, please write down and store the password for "NFC/Osaifu-Keitai lock".

## ToruCa

ToruCa is an application that can be used to collect coupon tickets, useful information etc. from your favorite stores. It can be obtained by many ways such as mail, website download, Bluetooth® and IC tag. Update the obtained ToruCa to the latest information simply.

For details of ToruCa, refer to mobile operator Website.

- 1 From the Home screen, tap "Apps"  
▶ "ToruCa"

### Note

- Packet communication fee may incur when acquiring, displaying or updating ToruCa.
- When obtaining ToruCa via Bluetooth®, it is required to turn on the Bluetooth® of ToruCa application.
- When obtaining ToruCa via IC tag, you need to place a check mark in "Reader/Writer, P2P" of this cell phone. → P166
- Depending on the settings of contents provider, the following functions may not be able to use.  
Update, ToruCa sharing, Viewing maps, Acquiring from readers
- ToruCa may not be acquired from readers when Osaifu-Keitai is not initialized.

## TV (1Seg)

1Seg is a digital terrestrial TV broadcasting service for mobile devices that allows you to receive data programs along with video and audio. Also, interactive service using communication function of mobile devices and receiving detailed information are available. For details on "1Seg" service, refer to the website below.

The Association for Promotion of Advanced Broadcasting Services

<http://www.apab.or.jp/en/>

## Before Using 1Seg

1Seg is a service provided by TV broadcast companies (broadcast stations). Receiving video and audio is free. For more information about NHK reception fees, contact NHK. There are two types of information displayed in the data broadcasting area: "Data broadcasts" and "Data broadcast sites".

"Data broadcasts" are displayed by broadcast wave for both video and audio, and "Data broadcast sites" are displayed by connecting to the site provided by the TV broadcasting company (broadcast station) through the data broadcast information.

To view "Data broadcast sites", etc. packet communication fees are charged. Information fees may be required to access some sites.

## Broadcast Wave

1Seg is one of broadcasting services, and receives radio waves (broadcast waves) that are different from mobile operator service. Therefore, it is not possible to receive at locations where broadcast waves do not reach or during time zones where broadcasting is off regardless of whether you are in an area with mobile operator service.

In addition, in areas with digital terrestrial TV broadcast service, reception may be poor or may not be available in the following locations.

- Locations far from the broadcasting tower where the broadcast wave is sent
- Locations where waves are blocked by landscape or buildings such as in the mountains and or near buildings
- Locations where waves are weak such as tunnels, underground, and building basements

Changing the direction of included TV Antenna Cable LO1 or moving to other location may improve signal reception.

## TV Antenna Cable LO1

When watching 1Seg, connect the TV Antenna Cable LO1 included in this package with this cell phone.

### **1** Insert the connection plug of the TV antenna cable into the earphone/microphone jack of this cell phone

- Insert the plug all the way till the end.  
You may not be able to hear the click if it is not inserted till the end.
- Remove the cable from this cell phone when it is not being used.

## Note

- When connecting a commercially available earphone, insert the plug of the earphone/microphone 3.5 mm in diameter into the earphone/microphone jack of the TV antenna cable and connect the TV antenna cable to this cell phone.
- The 1Seg sound is not output on the Bluetooth® devices that do not support SCMS-T format.
- When both of the earphone/microphone and Bluetooth® device are connected to this cell phone, the sound is output from the device that has been connected later.
- 1Seg is not compatible with the following functions due to copyright protection.
  - Video output via Miracast
  - Screenshot
  - QMemo+
  - QSlide apps

## Watching 1Seg

- 1 From the Home screen, tap "Apps"
  - ▶ "TV"
  - The 1Seg viewing screen is displayed.
  - When launching for the first time, you need to select your viewing area.

### How to use the watching screen

**1 Program title and broadcast time**

**2 Program details**

Tap it to display the program title, channel, broadcast time and the overview.

**3 Screen lock button**

Lock the 1Seg watching screen when it is full screen display. And then tap  to unlock it.

**4 Speaker ON/OFF button**

This is displayed only when the earphone is connected to this cell phone.





**5 Menu**

A menu is displayed.

**6 TV broadcast area**

- Swipe upward/downward on the right part to change the volume.
- Swipe upward/downward on the left part to change screen brightness.
- Swipe leftward/rightward to switch channels.
- Tap the watching screen (horizontal) to change to the watching screen (horizontal full screen).
- Tap the watching screen (horizontal full screen) to change to the watching screen (horizontal).

## 7 Channel area

- When watching a channel that supports multiservice, tap  to select a service.
- Tap  /  to switch channel.
- Touch and hold  /  to search the available channels.

## 8 Volume button

## 9 Data broadcast button

Tap to display the data broadcast area (P134).



## 10 Channel list/program list area

Tap the channel list/program list switch button to display the channel list/program list.

### ■ Channel list

- Tap a channel to switch it.
- Touch and hold a channel to select the its channel services.

### ■ Program list

-  is displayed on the current time.
- Tap a program to display its details. "RESERVATION" ► "Record" / "Watch" to reserve recording/watching.  /  is displayed in the program you reserved for recording/watching.

## 11 Record/Stop button

Tap to start/stop recording.

- Stop button does not function for the first five seconds after starting recording.

## 12 Channel list/program list switch button

"Using Program Schedule" → P134

## 13 Subtitles

Display caption when viewing a close-captioned program.

## Viewing the data broadcast screen

Tap data broadcast button on the 1Seg watching screen to display the data broadcast screen.

- 1 TV broadcast area**  
Tap to display the channel list/program list area.
- 2 Subtitles**  
Display caption when viewing a close-captioned program.

- 3 Scroll bar**  
Swipe or drag up to display the data broadcast in full screen mode.
- 4 Data broadcast area**  
Tapping directly on the content of the data broadcast may allow you to operate.
- 5 Data broadcast operation button**
  - Adjust the cursor with "▲" / "▼" and tap "OK" to select an item. The broadcast data of the link displays.
  - Tap  to return to the link.

## Using Program Schedule

You can view a TV guide of terrestrial TV programs, and make reservations for recording/viewing.

- 1 From the Home screen, tap "Apps"**  
▶ "TV"
- 2 Tap the button to switch channel list/program list**
  - Program list is displayed.
- 3 Tap a program**
  - Program information is displayed.
  - "RESERVATION" ▶ "Record" / "Watch" to reserve recording/watching.



## Watching Recorded Programs



Recorded programs can be watched and deleted by using the Television box.

- 1 From the Home screen, tap "Apps" ► "TV"
- 2 Tap  ► "TV box"
- 3 Tap the program being watched

### Deleting recorded programs



- 1 From the "TV box" screen, tap 
- 2 Place a check mark to the program to be deleted
- 3 Tap "DELETE" ► "YES"

### Note

- From the "TV box" screen, tap  ► Place a check mark in "Select all" ► "DELETE" ► "YES" is tapped, all recorded programs can be deleted.
- From the "TV box" screen, tap  ► "Title" / "Date" / "Size" is tapped, the recorded programs can be rearranged.
- Tap  on the "TV box" screen to check the used space and free space of the internal storage, and the estimate recording time.

## Reserving Recording/ Watching

Choose a channel and start time/end time and reserve a program to record/watch.

- 1 From the Home screen, tap "Apps"  
▶ "TV"
- 2 Tap  ▶ "Reservation list"  
• The reservation list screen is displayed.
- 3 Tap  ▶ Set the settings if necessary

Reservation type	The record and watch presets can be switched.
Channel	Select channel.
Start Time	Set the start date/time.
End Time	The ending date and time can be set.
Program name	Enter the program name.
Repeat	Set a recording/viewing reservation repeatedly at the same time period on a specific day of the week.

## 4 "SAVE"

### Note

- If the device is not ON when the preset time is achieved, recording/viewing cannot begin, nor can notifications of the beginning of programs be given.
- 1 Seg recordings can only be saved in the internal storage. Recorded images can only be watched on the device.
- Be aware that redundant presetting cannot be done.

## Confirming/editing reservation contents

- 1 From the reservation list screen, tap a viewing reservation
  - Edit reservation contents, and tap "SAVE".

## Deleting reservation contents

- 1 From the reservation list screen, tap 
- 2 Place a check mark in "Select all" or the recording/viewing reservation that you want to delete
- 3 Tap "DELETE" ▶ "YES"

## Using TV Link

Some data broadcasts may show link information (TV link) to related sites. By registering a TV link, it is possible to connect to related sites later.



- To register a TV link, tap the item that can be registered for the TV link that is displayed in the data broadcast area.

- 1 From the Home screen, tap "Apps" ▶ "TV"
- 2 Tap  ▶ "TV link"
  - The TV link list screen is displayed.
- 3 Tap a TV link
  - Connect to the registered site.

### Note

- From the TV link list screen, touch and hold down a TV link ▶ "DELETE" ▶ "YES" to delete all TV links.
- From the TV link list screen, tap  ▶ Place a check mark in "Select all" ▶ "DELETE" ▶ "YES" to delete all TV links.

## Switching Viewing Area

- 1 From the Home screen, tap "Apps"  
▶ "TV"
- 2 Tap  ▶ "Change area"
  - When adding new area, tap .
- 3 Select an area
  - The viewing area changes.

## 1 Seg Settings

- 1 From the Home screen, tap "Apps"  
▶ "TV"
- 2 

Scan	Scan the channel and obtain the data again.
G guide	The G guide program schedule screen is displayed.

TV box	Watch or manage the recorded programs.
Reservation list	Choose a channel and time and reserve a program to record/watch.
TV link	The registered TV link list is displayed.
Change area	Add or change the watching area.
Auto-off	Set the time to end TV automatically.

<b>Subtitles</b>		Set on/off for subtitles. <ul style="list-style-type: none"> <li>• Subtitle display is only available for full screen display or data broadcast screen.</li> </ul>
<b>Multiple sounds</b>		Change sound.
<b>TV settings</b>	<b>Screen size</b>	Set screen size.
	<b>Reset broadcast memory</b>	Delete data registered with the data broadcast and TV links.

## Camera

This cell phone has a built-in camera that can shoot photos and videos.

### Before Shooting

All photos and videos shot on your cell phone are saved to the internal storage.

#### Copyrights and portrait rights

Avoid copyright infringements when copying or editing photos and videos and videos that have been shot on this cell phone. You should also avoid infringing the portrait rights of other people by using or modifying their portraits without their consent. Note that the shooting or recording of stage performances, shows or exhibitions may be prohibited, even for personal use.

You may get fined according to law, regulation (nuisance prevention ordinance, etc.) if other people get disturbed or hurt by any improper behavior when using this cell phone.

Please be considerate of the privacy of individuals around you when shooting and sending photos using camera-equipped mobile phones.

## Notes for capturing images

- Though the camera is manufactured using extremely accurate technology, some dots and lines may always be displayed to be lighter or darker than you expect. Images shot under very low light intensity contain increased noise such as white lines or random dots, but it is not a malfunction. This is normal.
  - Clean the lens with a soft cloth before shooting. If the lens is stained with fingerprints or oil, the shot photo may appear out of focus or blurred.
  - Do not leave this cell phone in a warm place or under a direct sunlight for a long period of time. The quality of shot photos or video may deteriorate.
  - If you shoot under a fluorescent light, mercury lamp or sodium lamp flickering at high speed, flickering such as stripes may appear. The color tone of photos or videos may vary depending on the shooting timing.
  - Do not expose the lens to direct sunlight for a long period of time and do not point at the sun or a bright light directly. The image may become discolored or the camera may fail to operate properly.
- Do not cover the lens with your fingers or hair when shooting.
  - Shooting a fast moving object may result in an image slightly distorted from the image displayed on the screen at the time of shooting, or the image may be blurred.
  - When the battery level is low, you may not be able to save shot photos or videos. Check the battery level before using the camera.
  - Shot photos or videos may differ from the actual subjects in brightness or color tone.

## Viewing Shooting Screen



This camera can take pictures with both horizontal display and portrait display. The meaning of marks (icons, etc.) displayed on the shooting screen are shown below.

- 1 End button**  
Tap it while recording a video to stop recording or to end the camera application.
- 2 Shutter**
- 3 Recording button**
- 4 Shot data you took**
- 5 Settings**  
Set up Self-timer<sup>\*1</sup>/Disney Date Frame<sup>\*2</sup>/Voice shutter<sup>\*3</sup>/Shutter sound/Video resolution size/Dynamic tone (HDR)/Film effects/Grid display/Saving location/Normal image · Mirror image/Gesture view/Auto shot. Also you can check Help of the settings.
  - Depending on the shooting mode, there are items that may not be able to set up.
  - Displayed items vary depending on the front camera or main camera.

\*1 Set  to use the self-timer with Disney characters' voices.

\*2 Function to compose a Disney character's icon with the still image.

\*3 Function to shoot a still image by saying "Mickey", "Cheese", "Smile", or "Torimasu".
- 6 Shooting mode**  
Set shooting mode (Panorama/Auto).

- 7 Switch cameras**  
Switch between the front and main cameras.
- 8 Flash switch**  
Set flash switch.
  - Depending on the shooting mode, flash may not be able to be set.
- 9 Menu icon**  
Switch the screen mode.  
Manual mode (out camera): You can shoot with settings like a professional camera.  
Auto mode: You can shoot or record with basic settings.  
Simple mode: You can shoot by simply tapping a point you want to shoot on the screen.
- 10 Share**  
Share photos and videos via Facebook and Twitter etc..
- 11 Status display**  
In the case that the shooting location is dark etc., when the flash operates automatically,  is displayed. If you end and restart the camera while the film effect or dynamic tone is set,  or  is displayed for a certain period.

- 12 Auto focus frame**  
The frame is white when adjusting focus. It changes to green when focus is done.  
When using Simple mode, tap the screen to put the focus on the tapped place and then take the still image.
- 13 Pause button**  
Stop the recording temporarily.
- 14 Stop recording button**  
Stop recording the video.
- 15 Still image button**  
It is displayed during recording the video.  
Tap it to capture the moment as a still image.
- 16 Recording elapsed time**

## Shooting a Photo





- 1 From the Home screen, tap "Camera"**
- 2 Point the camera at the subject**
  - Pinch out/pinch in the touch screen while displaying the recording screen to zoom in/zoom out.



### 3

- The shutter clicks and a still image was taken.
- You can press volume key (up) or volume key (down) to take pictures.
- View the data you have taken from "Camera" in "Gallery".



#### Note

- Touch and hold  on the still image shooting screen, or press the volume key (up)/volume key (down) for over one second to take still images continuously.
- While shooting using the film effect or Disney Date Frame, you cannot use the continuous shooting.
- On the front camera, the indicator of beautiful skin shooting to shoot the person's skin with brightness is displayed. Drag to  (strong)/ (weak) to adjust beautiful skin shooting in eight levels.
- On the front camera, tap  to use the selfie light.

## Shooting a Video

### 1 From the Home screen, tap "Camera"

### 2 Point the camera at the subject

- The recording start sound plays and Camera starts shooting.
- When the recording starts, the recording elapsed time will be displayed on the recording screen.
- Press the volume key (up)/volume key (down) while recording to take a still image of that moment.
- You can zoom in/out by pinching out/in the touch screen during video shooting.
- Tap  while shooting a video to pause. Tap  to start shooting again.

### 4

- The recording stop sound plays and recording stops.
- You can view the videos you recorded from "Camera" in "Gallery".

## Gallery

You can display photos or play back videos stored in the cell phone that have been obtained by shooting with the camera or downloading from the Internet.

### Viewing Photos and Videos

#### 1 From the Home screen, tap "Gallery"

- The album list screen is displayed.









#### 2 Tap an album

- Both photos and videos are displayed by thumbnail.
- To view photos or videos shot by this cell phone, tap "Camera".
- In album list, tap  to activate camera, then you can take photos or record videos.

#### 3 Tap one of the thumbnails

- Display photos and play back videos.
- You can zoomed in or zoom out a photo by double-tapping or pinching out or in on the touch screen.

### Note

- The following operations are available on the photo/video screen.
  - : Edit photos using various Disney frames and Disney stamps.
  - : Select a photo or a video to share/send.
  - : Select a photo or a video to delete.
- The following operations are available on the photo display screen.
  - : Edit the displayed still image.
  - : Edit photos using various Disney frames and Disney stamps.
  - : Select the displayed photo to share/send.
  - : Delete the displayed photo.  
To cancel the delete operation, tap "UNDO".
  - : Add a tag to the displayed still image.
- The following operations are available from the photo display screen by tapping .
  - "Switch to camera": Launch camera to shoot photos or videos.
  - "SmartShare": Use SmartShare Beam to send or receive the still images.
  - "Set image as": Set a photo as a picture in the Phonebook or the wallpaper of the Home screen.

- "Move": Move a photo to another album.
- "Copy": Copy a photo to another album.
- "Copy to Clip Tray": Copy a photo to Clip board.
- "Lock": Lock a still image.
- "Slideshow": Display the saved photos by slide show.

You can composite the Disney frames with still images for the slideshow (Disney slideshow frame).

- "Rotate": Rotate the photo to the left or right.
- "Crop": Trim a photo.
- "Add location"/"Remove location": Add or remove location information to a photo.
- "Show on map": When location information is added, confirm the place when this photo is taken.
- "Rename": Edit a photo name.
- "Print": Print a photo by printer.
- "Details": Confirm detailed information of a photo.
- \* On the album list screen, tap **i** ► "Settings" ► "Set lock" ► Follow the on-screen instructions to set the contents lock beforehand.
- For operations when playing back a video, refer to "Playing Videos".

## GPS/Navigation

By using applications that supports GPS function on this cell phone, you can confirm the present location or search route to a destination.

### In Using GPS

- Mobile operator is not liable for any damage caused by failure of GPS system etc.
- It cannot be used as navigation devices for aircraft, vehicles, and people or as a high precision GPS for measurement. Please note that mobile operator shall not bear responsibility for damages which are pure economic losses which are generated by opportunities missed to confirm positioning results and missed communications due to external factors (including exhausted batteries) such as malfunctions, improper operations and power outages of this cell phone if it is used for these purposes or even if it is not used for these purposes.
- Since GPS is governed by the United States Department of Defense, the GPS signals might be controlled (degradation of accuracy, signal blackouts, etc.) according to national

security reasons of the US. Also even if positioning is done in the same locations and environments, identical results may not be obtained due to the differences in signal conditions caused by the locations of the satellites.

- Wireless communications products (mobile phone or data detector, etc.) may intercept satellite signal and signal reception may not be stable.
- Depending on the legal system of the country and area, the displayed map based on the received location information (lat/long information) may not be accurate.
- Since GPS uses signals from satellites, in the following environments there are locations where signals cannot be received or reception is poor. Thus, the range of error of location information may be over 300 m.
  - In the midst of or underneath dense tree growth, in areas lined with buildings or dense residential areas
  - Inside or underneath buildings
  - Inside of underground tunnels, underground and underwater
  - Near high-voltage lines
  - Inside of cars and trains

- In poor weather such as heavy rainfall and snow
- Inside of bags or boxes
- Hindrances (people and things) around this cell phone

## Enable Location Information

For applications requires access to location information, set if allow to use location information gained from GPS function, Wi-Fi® function and mobile network.

- 1 From the Home screen, tap "Apps" ► "Settings" ► "Location"
- 2 Turn on "Location"
- 3 "AGREE"
- 4 Tap "Mode" ► Select a location mode

<b>High accuracy (GPS and networks)</b>	Uses GPS, Wi-Fi®, and mobile networks to identify current location. Although current location can be detected more accurately, the cell phone consumes much power of battery.
<b>Battery saving (Networks only)</b>	Uses Wi-Fi® and mobile networks to identify current location.
<b>Device sensors only (GPS only)</b>	Uses GPS identify current location.

### Note

- It may take up to several minutes to determine current locations when the GPS functions are used for the first time.
- This cell phone is equipped with a GPS receiver that uses satellite signals to calculate current locations. Some GPS service functions use the Internet. Data communication fee may occur when transferring data via GPS service functions.

- To use a function which requires a GPS receiver for positioning of your current location, check for an unimpeded view of the sky. Move to another location if your current location is not determined after a few minutes.
- In order to calculate the current location faster, do not move or cover GPS/sub antenna with other objects.
- When you place a check mark on "GPS satellites", anonymous data is collected while using GPS. To transfer data, note that the packet communication fee may occur.
- Select "High accuracy (GPS and networks)" or "Battery saving (Networks only)" to allow the anonymous location data in Google location information service to be gathered. The data may be gathered even when the application is not activated.

## Using Maps

You can display present location, search another place, or search route by using Google map.

- Before getting the current location, set to "Enabling Location Information" (P146).
- To use Google map, you need to connect LTE/3G/GPRS network or Wi-Fi®, and set data communication available to use.
- Google Maps does not work for all nations or regions.

### Opening Maps

- 1** From the Home screen, tap "Google"  
▶ "Maps"
- 2** Input a place in search box

## Clock

You can use Alarm, Timer, World clock or Stopwatch.

**1** From the Home screen, tap "Apps"  
▶ "Clock"

**2** Tap a tab at top of the screen

- Tapping switches screen of each function.

## Setting Alarm

**1** From the Home screen, tap "Apps"  
▶ "Clock" ▶ "Alarms" tab

**2** ●

**3** Change the settings if necessary

- Set the hour, repeat, and snooze duration setting.

**4** "SAVE"

- The Alarm list screen is displayed and set alarm is added to the list.
- Tap ● / ☉ to set alarm ON/OFF.
- Tap list to display "Set alarm" and edit items. Tap "SAVE" to overwrite changes and return to Alarm list screen.

## Note

- The alarm functions at the time set for the alarm. Tap "Dismiss" to stop the alarm. ☉ is displayed on the status bar when tapping "Snooze". Alarm functions again based on the time duration set in "Snooze duration".
- On the "Alarm list" screen, tap [ ] ▶ "Select all" or place a check mark in the alarm to delete ▶ "DELETE" ▶ "YES" to delete alarm.  
When there is only one alarm that has been set, tap [ ] ▶ "YES".

## Setting Timer

**1** From the Home screen, tap "Apps"  
▶ "Clock" ▶ "Timer" tab

**2** Set Hour/Minute/Second

- Tap [ ] ▶ "Settings" to set the alarm sound while ringing.

**3** "Start"

- The timer starts.

### Note



- The alarm functions at the time set for the alarm. Tap "Stop" to stop the alarm.
- Tap "Stop" while timer is running to stop it. Tap "Resume" to restart. Tap "Reset" to reset timer.

## Setting World Clock

You can confirm the date and time for registered cities in a list.

- 1 From the Home screen, tap "Apps" ► "Clock" ► "World clock" tab
- 2 
- 3 Input a city name in search box ► Tap a city
  - City name, current time and date of the selected city are displayed in World clock list screen.

### Note

- Touch and hold down the added city ► "Set daylight saving" ► Tap settings to set summer time. ☀ is displayed besides the city with summer time set.
- From the World clock screen, tap  ► "Select all" or place a check mark in the city to delete ► "DELETE" ► "YES" to delete city.  
When there is only one world clock that has been set, tap  ► "YES".

## Setting Stopwatch

- 1 From the Home screen, tap "Apps" ► "Clock" ► "Stopwatch" tab
- 2 "Start"
  - The stopwatch starts. Tap "Lap" to count lap times.
  - To stop the stopwatch, tap "Stop".
  - Tap "Resume" to restart the stopwatch, and tap "Reset" to reset it.



## Calendar

This application is for managing your schedule. If you have a Google account, synchronize data with Google calendar.

### Opening Calendar

- 1 From the Home screen, tap "Apps"  
▶ "Calendar"

- 1 **Event pocket**  
Add events to your calendar easily.
- 2 **Icon of today**  
Move cursor to today's date (date of icon is changed).
- 3 **Menu**  
The menu is displayed.
- 4 **Switch calendar display**  
Change the calendar display format to Day/Week/Month/Year/Agenda or display tasks etc.
- 5 **Switch display**  
Tap "</>" in Day view/Week view/Month view/Year view to display the previous/next day, week, month or year.
- 6 **Date of today**
- 7 **Selected date**
- 8 **Icon to create new**  
Create a schedule.







## Creating a Schedule

- 1 From the Home screen, tap "Apps" ► "Calendar"
- 2 Tap date ►  ► Set each item ► "SAVE"

### Note

- When it turns to the time set in "REMINDERS" screen,  on schedule making screen is displayed on the status bar. Drag or swipe the status bar downward to open the notification panel then tap the calendar notification, the Calendar notifications screen is displayed. Tap "Dismiss" to clear notification. Set snooze duration and tap "Snooze" to notify again after it passes the set time.

## Changing/Deleting Schedule

- 1 From the Home screen, tap "Apps" ► "Calendar"
- 2 Tap  ► "Agenda"
- 3 Tap a schedule to change/delete ►  (edit) /  (delete)
  - Tap  to edit contents and then "SAVE".
  - Tap  and "YES".
  - On the Calendar screen, tap  ► "Delete" ► "Select all" or place a check mark in schedules you want to delete ► "DELETE" ► "YES" to delete.

## Changing Calendar Settings

- 1 From the Home screen, tap "Apps" ► "Calendar"
- 2 Tap  ► "Settings"
- 3 Change the settings if necessary
  - Set the calendar display, schedule notification, check the built version or set up an account.

## QMemo+

Write characters or draw illustrations directly.

**1** From the Home screen, tap "Apps"

▶ "QMemo+"

Memo list screen is displayed.







**3** Create a memo

**1** Save the created memo.

- 2** Undo/Redo
- 3** Edit font or select a color
- 4** Select a pen type and a color
- 5** Use an eraser
- 6** Cut the selected part
- 7** Display the QMemo+ menu
- 8** Tap to set the time and place to notify you of the memo
  - Tap "X" to delete the notification.
- 9** Tap to acquire and add weather information
- 10** Tap to acquire and add location information

## Calculator

- 1 From the Home screen, tap "Apps"
  - ▶ "Calculator"
    - From the Calculator screen, tap  ▶ "Scientific calculator" / "Basic calculator" to change functions. If it is landscape display, the scientific calculator is displayed.
    - Touch and hold the value or formula displayed in formula display field to cut/copy/paste it or display it on clipboard.
    - Tap  to delete input numbers or operators one by one.
    - Tap  ▶ "Calculation history" to display formula history. When history is displayed, tap  ▶ "YES" to clear all history.
    - Tap  ▶ "QSlide" to move to QSlide application mode.

# Settings

## Settings Menu

From the Home screen of this cell phone, tap "Apps" ► "Settings" to display the "Settings" screen to set different settings.

WIRELESS NETWORKS	(P155)
DEVICE	(P170)
PERSONAL	(P180)
SYSTEM	(P189)

## WIRELESS NETWORKS

Set to enable/disable networks and set the network connection settings.

Wi-Fi	(P156)
Bluetooth	(P200)
Mobile data	(P162)
Call settings	(P96)
More...	(P163)

## Wi-Fi®

This cell phone connects to the Internet via access points for Wi-Fi® networks or public wireless LAN services. To connect, you must configure the access point connection settings on this cell phone.

### ■ Reception interference caused by Bluetooth® devices

- As wireless LAN (IEEE802.11 b/g/n) and Bluetooth® device use the same frequency (2.4 GHz), reception interference may occur or the communications speed may lower when using near Bluetooth® device. Also, you may hear noise or have a connection problem. In these cases, do the following:
  - Keep the wireless LAN device over 10 m away from the Bluetooth® device.
  - When using within 10 m, turn off the Bluetooth® device.



### Note

- Packet communication can be connected, even when Wi-Fi® function is ON. However, while Wi-Fi® is available, Wi-Fi® is prioritized. When the Wi-Fi® network is disconnected, this cell phone automatically connects to the LTE/3G/GSM network. Note that if you keep connecting via the LTE/3G/GPRS network, you may incur packet communication charges.
- You can reduce battery consumption by turning OFF Wi-Fi® when you are not using it.

## Connecting to a Wi-Fi® network

- 1 From the Home screen, tap "Apps"**
  - ▶ "Settings" ▶ "Wi-Fi"
  - When "Wi-Fi tutorial" screen is displayed, tap "YES" to start a tutorial, or tap "NO" to display "Wi-Fi" screen.
- 2 Turn on "Wi-Fi"**
- 3 Tap the Wi-Fi® network that you want to connect to**
  - If you try to connect to a protected Wi-Fi® network, you will be prompted to enter the security key for that Wi-Fi® network. Tap the "Password" box, enter the network password and tap "CONNECT".
  - Usually, when you enter a password, the last character entered is displayed and as many "." as the number of characters appear instead of previously entered characters. All characters can be displayed when you place a check mark on "Show password".
  - To connect to the access point which supports WPS, on the "Wi-Fi" screen tap **i** ▶ "Advanced Wi-Fi" ▶ "Connect by WPS button" / "Connect by WPS PIN" ▶ operate on the access point side.

### Note

- Open network and protected network are two types networks that are available. On the left of Wi-Fi® network name, the network type is indicated by an icon. The icon indicates  (open network) /  (protected network). The icon also indicates the signal strength.

<b>Strong signal:</b> 	<b>Weak signal:</b> 
---	---

- To search Wi-Fi® network again, tap "SEARCH" on the "Wi-Fi" screen.
- Network name is not displayed depending on the settings for the access point even if the Wi-Fi® network is connectable. If this happens, you can still connect to the network. Refer to "Adding a Wi-Fi® network" (P158).
- When establishing a Wi-Fi® network connection, the required information is generally obtained from a DHCP server automatically. However, it is possible to specify these items separately.

- When "Switch to mobile data" has a check mark, if the mobile network icon is displayed on the status bar, it indicates that the mobile network is being used and note that the packet communication fee will occur.  
When the popup screen of switching mobile data is displayed, select "Don't show this again" and tap "OK" so that the popup screen is not displayed anymore. From then on, if the Internet is connected to an unavailable wireless LAN, it switches to the mobile network and note that the packet communication fee will occur.
- If the access point which is not being connected to the Internet is being connected,  is displayed and the mobile network may be used to communicate instead of Wi-Fi®.

## Adding a Wi-Fi® network

- 1** From the Home screen, tap "Apps" ► "Settings" ► "Wi-Fi"
- 2** Turn on "Wi-Fi"
- 3** Tap  ► "Add Wi-Fi"
- 4** Enter network SSID in the "Wi-Fi name (SSID)" box
- 5** Tap the "Security" box
  - Select the appropriate type from "None", "WEP", "WPA/WPA2 PSK", and "802.1x EAP".
  - The setting method differs depending on the security settings.
- 6** "CONNECT"

## Disconnecting a Wi-Fi® network

- 1** From the Home screen, tap "Apps" ► "Settings" ► "Wi-Fi"
- 2** Tap the name of Wi-Fi® network that you want to disconnect
- 3** "DISCONNECT"



## Setting mobile data switch

Set whether to check availability of the connected Wi-Fi® network and change to the mobile network automatically if it is unavailable.

- 1 From the Home screen, tap "Apps" ► "Settings" ► "Wi-Fi"
- 2 Turn on "Wi-Fi"
- 3 Place a check mark in "Switch to mobile data"

### Note

- When the Wi-Fi® which is connected to an access point that is not connected to the Internet, such as wireless LAN internal memory card, is disconnected with a check mark in "Switch to mobile data", remove the check mark in "Switch to mobile data".

## Using static IP address

You can set the cell phone to connect to Wi-Fi® network using the static IP address.

- 1 From the Home screen, tap "Apps" ► "Settings" ► "Wi-Fi"
- 2 Turn on "Wi-Fi"
- 3 Tap a Wi-Fi® network to connect ► Place a check mark in "Show advanced options"
- 4 Tap "IP settings" field ► "Static"
- 5 Set required items
  - To use static IP address, enter the following items.
    - IP address
    - Gateway
    - Network prefix length
    - DNS 1
    - DNS 2
- 6 "CONNECT"

## Confirming/Deleting the saved Wi-Fi® network

- 1 From the Home screen, tap "Apps" ► "Settings" ► "Wi-Fi"
- 2 Turn on "Wi-Fi"
- 3 Tap  ► "Saved Wi-Fi"
  - The Wi-Fi® network list that was connected to is displayed.
- 4 Tap a Wi-Fi® network name
  - The network security information is displayed.
- 5 "FORGET"

### Note

- On the "Wi-Fi" screen, tap a Wi-Fi® network name to delete ► "FORGET" to delete from the Wi-Fi® network list that was saved.

## Using Wi-Fi Direct®

Devices support Wi-Fi Direct® are connected without using access point.

- Asking for connecting with another Wi-Fi Direct® supported device

- 1 From the Home screen, tap "Apps" ► "Settings" ► "Wi-Fi"
  - 2 Turn on "Wi-Fi"
  - 3 Tap  ► "Advanced Wi-Fi" ► "Wi-Fi Direct"
    - Tap "SEARCH" when the Wi-Fi Direct® supported device you want to connect is not displayed.
  - 4 Tap the detected Wi-Fi Direct® supported device
    - Send a request to connect another party's Wi-Fi Direct® supported device.
- Disconnecting with another Wi-Fi Direct® supported device
- 1 Tap the connected Wi-Fi Direct® supported device ► "OK"
- Accepting request for connecting with another Wi-Fi Direct® supported device
- 1 From the "Invitation to connect" screen, tap "ACCEPT"

## Setting advanced Wi-Fi® settings

- 1 From the Home screen, tap "Apps" ► "Settings" ► "Wi-Fi"
- 2 Turn on "Wi-Fi"
- 3 Tap  ► "Advanced Wi-Fi"
- 4 Change the settings if necessary

NOTIFICATIONS	
Wi-Fi notification <sup>*1</sup>	You will be automatically notified when Wi-Fi® open network with no security protection is detected.
USEFUL SETTINGS	
Keep Wi-Fi on when screen is off	When the screen display of this cell phone is black out, set to either disconnecting Wi-Fi® or always maintaining connection during charging.
Passpoint	When Wi-Fi® is ON, set to connect to the available Passpoint supported access point or not.

CONNECTION	
Wi-Fi Direct <sup>*1</sup>	(P160)
Connect by WPS button <sup>*1</sup>	Connect to WPS (Wi-Fi® Protected Setup) supported access point.
Connect by WPS PIN <sup>*1</sup>	
PERSONAL	
Install certificates	Install the network certificate from the internal storage.
INFORMATION	
MAC address	MAC address is displayed.
IP address <sup>*2</sup>	IP address is displayed.

\*1 When "Wi-Fi" is set to ON beforehand.

\*2 When Wi-Fi® network is connected beforehand.

## Mobile Data

Items such as whether or not use mobile data communication, limit mobile data usage, data usage cycle and the services being used are displayed.

### Displaying mobile data screen

Mobile data usage (rough number) is displayed either term by term or application by application.

- 1 From the Home screen, tap "Apps" ► "Settings" ► "Mobile data"

#### Note

- When "Mobile data" is set to ON, Internet access via mobile network is enabled.
- On the graph, you can set limit mobile data usage and a warning for top usage amount. Only when you place a check mark in "Limit mobile data usage".

## Setting mobile data

- 1 From the Home screen, tap "Apps" ► "Settings" ► "Mobile data" ► 

Restrict background data	Restrict auto mobile data communication.
Show Wi-Fi usage	Set if display Wi-Fi® usage or not.
Mobile hotspots	Set to disable specialized Wi-Fi® network on background applications.
Mobile networks	(P163)

## More...

Set other network settings.

<b>Airplane mode</b>		Turn ON/OFF radio wave emitting.
<b>Tethering</b>	<b>USB tethering</b>	(P164)
	<b>Wi-Fi tethering</b>	(P165)
	<b>Bluetooth tethering</b>	(P166)
	<b>Help</b>	Display Help.
<b>Miracast</b>		Set to share screen display and sound on video equipment that supports Miracast via Wi-Fi Direct®. When available devices are not found, tap "SEARCH".
<b>SmartShare Beam</b>		(P209)

<b>Media server</b>	Use DLNA to share the peripheral device and media contents.
<b>NFC/Osaifu-Keitai settings</b>	(P166)
<b>VPN</b>	(P167)
<b>Mobile networks</b>	Set if enable data communication and if enable data roaming. Also set preferred network type, access point names, network mode and network operators.
<b>Printing</b>	Set wireless printer.

## Using Tethering

Tethering is a function which uses a mobile device such as a smart phone as a modem to connect wireless LAN devices, USB compatible devices and Bluetooth® compatible devices to Internet.

### Enabling USB tethering

Use microUSB Cable 01 (optional) to connect this cell phone and a PC to access to the Internet by using this cell phone as a modem.

- 1 Use microUSB Cable 01 to connect this cell phone and a PC (P207)
- 2 From the Home screen, tap "Apps" ► "Settings" ► "More..." ► "Tethering"
- 3 "USB tethering"

### Note

- The operating environment on PC side during USB tethering is as follows:
  - OS: Windows 10/Windows 8.1/Windows 7/Windows Vista
  - \* We do not guarantee operations conducted in environment with upgraded OS or in added/changed environment.
- A driver for USB tethering is required. For details, refer to the following website.  
<http://www.lg.com/jp/support/software-manuals> (In Japanese only)
- You can install the driver through the "Install PC programs" screen displayed when this cell phone is connected to a PC.
- USB tethering can be used together with Wi-Fi® tethering and Bluetooth® tethering.

## Enabling Wi-Fi® tethering

Up to eight wireless LAN compatible devices can access to the Internet simultaneously by using this cell phone as a Wi-Fi® access point.

- 1 From the Home screen, tap "Apps" ► "Settings" ► "More..." ► "Tethering" ► "Wi-Fi tethering"
- 2 Turn on "Wi-Fi tethering"

### Note

- Wi-Fi® tethering can be used together with USB tethering and Bluetooth® tethering.

## Setting Wi-Fi® tethering

### ■ Setting Wi-Fi® access point

- 1 From the Home screen, tap "Apps" ► "Settings" ► "More..." ► "Tethering"
- 2 Tap "Wi-Fi tethering" ► "Configure Wi-Fi hotspot"
- 3 Enter network SSID in the "Wi-Fi name (SSID)" box
- 4 Tap "Security" box
  - Select an appropriate one from "Open", "WPA PSK" and "WPA2 PSK".
  - A password is necessary when setting to "WPA PSK" or "WPA2 PSK".
- 5 "SAVE"

### Note

- At the time of purchase, network SSID is set to "KX1801", and security is set to "WPA2 PSK".

## Enabling Bluetooth® tethering

Up to four devices can access to the Internet simultaneously by using this cell phone as a modem.

- 1 From the Home screen, tap "Apps" ► "Settings" ► "More..." ► "Tethering"
- 2 "Bluetooth tethering"

### Note

- Pairing with this cell phone is required to use Bluetooth® tethering. For details, refer to "Pairing/Connecting with Other Bluetooth® Device" (P202).
- Bluetooth® tethering can be used together with USB tethering and Wi-Fi® tethering.

## Setting NFC/Osaifu-Keitai

Set and manage NFC/Osaifu-Keitai settings.

- 1 From the Home screen, tap "Apps" ► "Settings" ► "More..." ► "NFC/Osaifu-Keitai settings"

NFC/Osaifu-Keitai lock	Restrict Osaifu-Keitai functions and its usage services.
Reader/Writer, P2P	Turn ON/OFF NFC reader/writer and P2P functions.
Android Beam	When "Reader/Writer, P2P" is turned on, set to beam app contents to other NFC compatible terminals or not. For setting details, refer to "Android Beam" (P204).
NFC Type setting	Select an NFC Type to use.



LOCK PASSWORD SETTINGS	
Lock password change	Change the lock password for NFC/Osaifu-Keitai.
TAP & PAY	
Tap & pay	Enable/Disable the setting of the service available by holding the cell phone over the IC card reader, such as Osaifu-Keitai service.

## Connecting to VPN (Virtual Private Network)

VPN (Virtual Private Network) is a technology to access to the information protected in local network from other networks. VPN is generally equipped in companies, schools or other facilities. Users can access the local network and view information outside the premise. To set VPN access from this cell phone, security information from network administrator is required.

### Adding VPN

- 1 From the Home screen, tap "Apps" ► "Settings" ► "More..." ► "VPN"
- 2 "Add VPN network"
  - If a caution screen appears, tap "Settings" and follow the onscreen instructions to set screen unlock.
- 3 Follow instructions given by the network administrator and set each item ► "SAVE"

## Connecting to VPN

- 1 From the Home screen, tap "Apps" ► "Settings" ► "More..." ► "VPN"
- 2 Tap a VPN name to connect to
- 3 Enter the required authentication information ► "CONNECT"

## Editing VPN

- 1 From the Home screen, tap "Apps" ► "Settings" ► "More..." ► "VPN"
- 2 Touch and hold down a VPN name to edit
- 3 Tap "Edit" ► Add, delete or edit the information ► "SAVE"

## Deleting VPN

- 1 From the Home screen, tap "Apps" ► "Settings" ► "More..." ► "VPN"
- 2 Touch and hold down a VPN name to delete
- 3 Tap "Delete" ► "DELETE"

## Always use VPN

- 1 From the Home screen, tap "Apps" ► "Settings" ► "More..." ► "VPN"
- 2 Tap  ► "Always-on VPS"
- 3 Select a VPN profile ► "OK"

## Setting Access Point

Access point for connecting the Internet (sp-mode) is already registered. You can add or change it if necessary.

For details about sp-mode, refer to mobile operator Website.

When using mopera U or Business mopera Internet, add access point manually.

For details about mopera U, refer to mopera U website.

## Checking the access point in use

- 1 From the Home screen, tap "Apps" ► "Settings" ► "More..." ► "Mobile networks" ► "Access Point Names"

## Setting an additional access point <New APN>

- 1 From the Home screen, tap "Apps" ► "Settings" ► "More..." ► "Mobile networks" ► "Access Point Names"
- 2 Tap ⓘ ► "Add APN"
- 3 Tap "Name" ► Enter the network profile name you want to create ► "OK"
- 4 Tap "APN" ► Enter the access point name ► "OK"
- 5 Enter other items required by the network operator
- 6 Tap ⓘ ► "Save"

### Note

- Do not change MCC to any value other than 440, or change MNC to any value other than 10. It may not be displayed.
- When MCC and MNC settings are not displayed on the screen after being changed, reset it to the initial settings or set the access point manually.

## Initializing access point

When initializing an access point, it returns to the default settings.

- 1 From the Home screen, tap "Apps" ► "Settings" ► "More..." ► "Mobile networks" ► "Access Point Names"
- 2 Tap ⓘ ► "Reset to default" ► "YES"

## DEVICE

### Sound & notification

Set sound settings such as phone ringtone, volumes and vibrate.

BASIC	
<b>Manner Mode</b>	Select from "Sound & Vibrate", "Vibrate only", or "Silent".
SOUND	
<b>Volume</b>	Set the volumes for "Ringtone", "Notification sound", "Touch feedback & system", and "Music, video, games & other media".
<b>Ringtone</b>	Set a phone ringtone.
<b>Ringtone ID</b>	For an incoming call from the phone number you selected, set whether to sound a ringtone created automatically based on the phone number.

### VIBRATION

<b>Vibrate</b>	Set to notify incoming call by vibration.
----------------	---

<b>Vibration type</b>	Select a vibrate type.
-----------------------	------------------------

### NOTIFICATIONS

<b>Do not disturb</b>	Set notification settings such as the ringtone, notification sound for a new message, and vibration and also set schedule.
-----------------------	--

<b>Cover &amp; lock screen</b>	Set whether to display contents (contents of a received mail, etc.) or notifications when the screen is locked or Disney Original Cover LO1 is attached.
--------------------------------	--

<b>Apps</b>	Allow/block the notifications from each application.
-------------	--

### ADVANCED SETTINGS

<b>Notification sound</b>	Set up a notification sound.
---------------------------	------------------------------

<b>Vibrate on tap</b>	Set whether to vibrate when tapping any home touch button or dialpad (P53).
<b>Sound effects</b>	Set whether to enable "Dialpad touch sounds", "Touch sound", or "Screen unlock sound".
<b>Voice notification</b>	Set whether to read out the sender's information and the message contents of a received message (SMS) automatically. <ul style="list-style-type: none"> <li>• In "Voice notifications language", set preferred engine, speech rate, and voice pitch and listen to an example.</li> </ul>

## illumination



Set the back side illumination to turn on/off. You can also set for each function.

<b>Incoming call</b>	Set whether to turn on during an incoming call.
<b>Receiving mail</b>	Set whether to turn on when receiving a mail.
<b>Receiving message</b>	Set whether to turn on when receiving SMS.
<b>Disney kisekae alarm</b>	Set whether to turn on while Disney kisekae alarm is ringing.
<b>Disney market</b>	Set whether to turn on when receiving notification from Disney market.
<b>Camera self-timer</b>	Set whether to turn on when the self-timer starts.
<b>Unlock</b>	Set whether to turn on when the backlight turns on.

## Display

Set display settings, such as font, screen brightness, or animation.

FONT	
Font type	Set the font displayed on the screen.
Font size	Select from "Minimum", "Small", "Medium", "Large", "Very large", "Maximum".
BASIC SETTINGS	
Wallpaper	Set a wallpaper.
Brightness	Set screen brightness. <ul style="list-style-type: none"><li>• If you place a check mark in "Automatic brightness", the screen brightness changes automatically according to the environment.</li></ul>
Auto-rotate screen	Set to switch the screen to horizontal/portrait according to the orientation of this cell phone.

Screen timeout	Set time duration before screen turns off automatically.
Home touch buttons	Select a layout and a color for home touch buttons.
ADVANCED SETTINGS	
Daydream	Set Daydream. <ul style="list-style-type: none"><li>• Tap  ► "Start now" to activate Daydream.</li><li>• Tap  to set details for each screensaver.</li></ul>
Motion sensor calibration	Calibrate the accuracy of sensor (the tilt and speed of the sensor). <ul style="list-style-type: none"><li>• Operate it when Gesture does not work properly.</li></ul>

## Home screen

Set the Home screen settings.

- You cannot change items except for "Select Home" on mobile operator home.

Select Home	Switch home applications. Choose "mobile operator home" or "Home" (P83).
SCREEN	
Screen swipe effect	Select a screen effect.
Allow Home screen looping	Set to go to the initial screen or not when scrolling the Home screen.
TIPS	
Help	Read Home screen related Help.

## Lock screen

Set to lock screen or not. Set settings if necessary.

- The display and setting items vary depending on your selection from "None", "Touch", "Swipe", "Knock Code", "Pattern", "PIN", "Password" to unlock the screen.

SCREEN SECURITY		
Select screen lock	None	Disable the security of unlocking screen.
	Touch	Tap to unlock screen.
	Swipe	Swipe to unlock screen.
	Knock Code	Tap the pattern that you set when the screen is OFF to unlock it.
	Pattern	Draw pattern to unlock screen. You can set your favorite pattern.
	PIN	Enter a PIN to unlock screen. Follow the on-screen instructions to enter a 4 to 16-digit number.

<b>Select screen lock</b>	<b>Password</b>	Enter a PIN to unlock screen. Follow the on-screen instructions to enter a 4 to 16-digit password including alphabets.
<b>Smart Lock</b>		Set to unlock the touch screen automatically by a trusted cell phone, location or face that you have set up.
<b>Screen swipe effect</b>		Set the screen effects when swiping the screen to unlock.
<b>Hidden pattern</b>		When tapping lock screen, set if show pattern dots or not.
<b>Make pattern visible</b>		Set to show pattern line or not.
<b>Hidden PIN</b>		Set whether to display the PIN input area when tapping the screen.

<b>Randomize PIN entry</b>	Set whether the number layout on keyboard is random when inputting PIN.
<b>Hidden password</b>	Set whether to display the password input area when tapping the screen.
<b>CUSTOMIZE</b>	
<b>Shortcuts</b>	Customize the shortcut displayed on the lock screen.
<b>Weather animation</b>	Set if update weather information for current location and display it by animation.
<b>Contact info for lost phone</b>	Set whether to display contact information on the lock screen when this cell phone is missing.



LOCK TIME	
Lock timer	Set time duration from the screen turns off till it is locked.
Power key instantly locks	Set to lock the screen immediately or not after pressing the power key.

## Note

### <On-Screen Unlock>

- If you entered an incorrect Knock Code for five times, a message is displayed to remind you to re-input the pattern after 30 seconds. If you forgot the screen-unlock pattern, tap "Forgot knock code?" on the reentry screen and enter your backup PIN to unlock screen.
- If you entered an incorrect Pattern, PIN, or Password for five times, a message is displayed to remind you to re-input the pattern after 30 seconds. If you forgot the screen-unlock pattern, tap "Forgot pattern?" on the reentry screen and enter your backup PIN to unlock screen.

### <Lock screen notification>

- When the screen lock is set to "Knock Code" / "Pattern" / "PIN" / "Password", a screen appears so that you can select the notification displayed on the lock screen.

When "Hide sensitive only" / "Hide all notifications" is selected, note that the notification icons, caller's name, phone number, the number of missed calls/ voicemails may not be displayed on the lock screen anymore.

## Storage & USB

Display free space in internal storage and microSD card, operate mount and format (P198).

DEVICE STORAGE	
X.XXGB Total used of 16.00 GB	Total space of the internal storage is displayed.
Internal storage	Available space of the cell phone and detailed usage is displayed.
PORTABLE STORAGE	
SD card	microSD card files are displayed.

### Note

- To unmount the microSD card, tap . To mount it again, tap "SD card" ► "MOUNT".

## Battery & power saving

Confirm the remaining battery, set to restrict the usage of each function when the battery is getting less.

BATTERY INFORMATION	
Remaining battery icon	Battery levels are displayed in percentages. It displays whether the battery is being charged, the expected time to charge fully/the usable total time.
Battery usage	Confirm the details of battery consumption.
Battery percentage on status bar	Set whether to display the remaining battery on the status bar in percentage.
BATTERY SAVER	
Battery saver	(P177)
Help	Description related to battery saver is displayed.

### Note

- To reduce battery power for each application, disable applications when the cell phone is not used or the applications have not been used for several days (Battery optimization).

To change the battery optimization setting, tap "Battery usage" ► "Ignore optimizations" ► place a checkmark to applications to set.

### Turn on battery saver

When the remaining battery is less than the set value, etc. set the battery saver to restrict the battery consumption by reducing the screen brightness, etc.

- Tap "Help" on the battery saver screen to check the description about battery saver.

- 1** From the Home screen, tap "Apps" ► "Settings" ► "Battery & power saving" ► "Battery saver"

Battery saver screen is displayed.

- 2** Turn on "Battery saver"

- 3** Tap "Turn Battery saver on" ► "Immediately" / "5% battery" / "15% battery"

## Memory

Display the memory (RAM) usage, etc.

AVERAGE MEMORY USE	
Indicator	Display performance, total memory, average use, and free space of the memory.
Memory used by apps	Display memory use of applications for a specified period.

### Note

- To change periods, tap "3 hours"/"6 hours"/"12 hours"/"1 day" at the top of the screen.

## Apps

Manage or delete the installed applications.

### Confirming applications

- 1 From the Home screen, tap "Apps"  
▶ "Settings" ▶ "Apps" ▶ Tap an application you want to confirm

Force stop	Force-quit an application being activated.
Disable/ Enable/ Uninstall	Disable/enable application or uninstall application.
Storage	Display the storage usage or clear the application data or cache.
Data	Display the data usage of the application.
Permissions	Set application permissions.
Notifications	Set application notification settings.

Open by default	Set the application to launch by default.
Battery	Display the battery use condition after the previous full-charging.
Memory	Display the memory use status.

### Deleting an application

- Some preinstalled applications may not be able to be deleted (uninstalled). Part of the applications can be disabled (P179).
- It is recommended that the applications purchased from Play Store be delete (P123) from Google Play screen.

- 1 From the Home screen, tap "Apps"  
▶ "Settings" ▶ "Apps"
- 2 Tap an application to delete
- 3 Tap "Uninstall" ▶ "OK"

## Disabling an application

Disabled application stops its operation and it is not displayed on the Apps screen.

- It will not be uninstalled.
- It is available for some applications or services that cannot be uninstalled.

- 1 From the Home screen, tap "Apps"  
▶ "Settings" ▶ "Apps"
- 2 Tap an application to disable
- 3 Tap "Disable" ▶ "YES"

### Note

- When an application is disabled, the linked applications may not run properly. In such case, enable it again to run properly.

## Enable an application again

- 1 From the Home screen, tap "Apps"  
▶ "Settings" ▶ "Apps"
- 2 Tap the application you want to enable again
- 3 "Enable"

## Default message app

Select a message application which is used normally from "Messaging" and "Hangouts".

- 1 From the Home screen, tap "Apps" ▶  
"Settings" ▶ "Default message app"
- 2 "Messaging" / "Hangouts"

## PERSONAL

### Location

Set GPS settings, etc.

Mode	(P146)
<b>RECENT LOCATION REQUEST</b>	
When there are applications that request the latest location information, the list is displayed.	
<b>LOCATION SERVICES</b>	
Low power location estimation	Set whether to quickly specify the current location using Qualcomm® IZat™ hardware.
Camera	Set whether to record the location information in the photos or videos taken by the camera.

Google Location History	Display the location information history of places you visited while you were logged in to the Google account.
GPS notification	Set if play back audio and vibrate while GPS is searching for location information.

### Security

Set password settings, etc.

Content lock	Select a lock type when locking a file in Gallery.
<b>ENCRYPTION</b>	

<b>Encrypt phone</b>	Confirm the encrypted system data saved in the internal storage. <ul style="list-style-type: none"><li>• You cannot change the settings of "Encrypt phone" on the cell phone.</li></ul>
----------------------	---

<b>Encrypt SD card</b>	Encrypt all the data in microSD card. <ul style="list-style-type: none"><li>• Note that if you perform "Factory data reset" with the microSD card encrypted, you will not be able to use the data in the microSD card. Decrypt the microSD card before performing "Factory data reset".</li></ul>
<b>SIM CARD LOCK</b>	
<b>Set up SIM card lock</b>	(P185)

PASSWORDS	
Password typing visible	Set if show the last character of a hidden password or not as you type.
PHONE ADMINISTRATION	
Phone administrators	Select a device administrator to activate in this cell phone.
Unknown sources	Set if allow installation of applications from sources other than Google Play.
Verify apps	Disallow or warn before installation of applications that may cause harm.
Notification access	Set if allow notification of applications.

CREDENTIAL STORAGE		
Storage type		Show the location for credential storage backup.
Certificate management	Trusted credentials	Trusted CA credential is displayed.
	Install from storage	Install certificates from storage.
	Clear credentials	Delete credential information of all contents and VPN in credential storage. <ul style="list-style-type: none"> <li>To delete an installed certificate, you need to delete credential storage.</li> </ul>



ADVANCED SETTINGS	
Trust agents	Set whether to execute the selected operation when a trusted cell phone is connected.
Screen pin	Set whether to fix a certain application on the screen of this cell phone or not.
Usage access for apps	Set access to application usage logs.

## Security code on this cell phone

Some functions provided for convenient use of the cell phone require the security code to use them. Besides a password for screen lock of the cell phone, a network security code necessary for the network services etc. are available. Make use of the cell phone using an appropriate security code according to the purpose.

- Entered PIN/password for screen lock, network security code, PIN code and PUK code are shown as "\*".

### ■ Cautions on using security codes

- Avoid using a number that is easy to guess, such as "birth date", "part of your phone number", "street address number or room number", "1111", and "1234". Make sure to make a note of the security code you set lest you should forget it.
- Do not reveal your security codes to others. Mobile operator is not responsible for damage caused by misuse of your security codes by others.
- If you forget security codes, you should bring your official identification (such as driver's license), the cell phone, and nano UIM card with you to the nearest Shop. For details, contact "General Inquiries" on the

back cover of this manual.

- The PUK code is written on the subscription form (copy for customer) handed at the subscription in the Shop. If you have subscribed at other than Shop, you should bring your official identification (such as driver's license), the nano UIM card with you to the nearest Shop or contact "General Inquiries" on the back cover of this manual.

#### ■ PIN/Password for screen lock

The security code is used for lock function of this cell phone.

#### ■ Network security code

The network security code is a 4-digit number necessary for using the mobile operator Network Services or identification at reception of your request in Shop or at mobile operator Information Center, or when using "お客様サポート (customer support)". It can be set to any number at the subscription and also changed later by yourself.

For details on Network security code, refer to mobile operator Website.

#### ■ PIN code

The nano UIM card can set security code named PIN code. This code is set to "0000" at the time of subscription, but you can subsequently change it.

PIN is a 4- to 8-digit number (code) that must be entered for user confirmation to prevent unauthorized use of nano UIM card by a third party every time you insert the nano UIM card into the cell phone or when the cell phone is powered on. You can set entering the PIN code enables making/receiving calls and cell phone operations.

- If you use a nano UIM card that has been currently used when you buy a new cell phone, use the same PIN code that had been set on the current cell phone. The code is "0000" if the default setting has not been changed.
- If you enter incorrect PIN code three times in a row, the code will be locked. In that case, unlock with "PIN unblocking key".

### ■ PIN unblocking key (PUK)

The PIN unblocking key is an 8-digit number used to unblock the PIN code. You cannot change it by yourself.

- If you enter the PIN unblocking key incorrectly ten times in a row, the nano UIM card will be locked. If this happens, please contact the Shop.

### Setting PIN code

You can set to require the PIN code entry for using the cell phone when the power is turned on.

- 1 From the Home screen, tap "Apps"  
▶ "Settings" ▶ "Security"
- 2 "Set up SIM card lock"
- 3 "Lock SIM card"
- 4 Enter PIN and tap "OK"
  - Place a check mark in "Lock SIM card".

### Changing PIN

Enable PIN beforehand.

- 1 From the Home screen, tap "Apps"  
▶ "Settings" ▶ "Security"
- 2 "Set up SIM card lock"

- 3 "Change SIM PIN"
- 4 Enter the current PIN, and tap "OK"
- 5 Enter a new PIN and tap "OK"
- 6 Enter the same PIN that you entered in step 5 and tap "OK"

### Entering PIN

Follow the operations below if you are asked to enter the PIN when turning on this cell phone.

- 1 Enter the PIN of the nano UIM card, and tap "OK"

### Unlocking PIN

Follow the operations below to unlock PIN when you have entered PIN incorrectly for 3 times in a row.

- 1 From the PIN input screen, enter PIN code and tap "OK"
- 2 Enter a new PIN and tap "OK"
- 3 Enter the same PIN as you entered in step 2 and tap "OK"

## Accounts & sync

Add or delete an account used in this cell phone, such as Google account. Set synchronization settings.

### Setting account

- 1 From the Home screen, tap "Apps" ► "Settings" ► "Accounts & sync"
- 2 "ADD ACCOUNT"
- 3 Tap an account type you want to add
- 4 Set according to the on-screen instructions

### Note

- The application automatically synchronizes data if "Auto-sync data" is turned on. Packet communication fee may be charged when operating the above operations. Also, it consumes more battery than when "Auto-sync data" is turned off.
- When synchronizing manually, from the Home screen, tap "Apps" ► "Settings" ► "Accounts & sync" ► Select an account type ► Tap an account to synchronize ► Tap the items to synchronize or tap  ► "Sync now".

### Removing account

- 1 From the Home screen, tap "Apps" ► "Settings" ► "Accounts & sync"
- 2 Tap an account type to delete
- 3 Tap the account name to delete
- 4 Tap  ► "Remove account" ► "REMOVE ACCOUNT"

### Note

- account cannot be added or deleted.

## Language & keyboard

Set language and keyboard settings in this cell phone. You can also set voice input and output settings.

Language	Select a language you use in this cell phone.
<b>KEYBOARD &amp; INPUT METHODS</b>	
Current keyboard	Select default keyboard and input method.
LG Japanese keyboard	Set the keyboard settings (P62).
Google voice typing	Set the Google voice typing settings such as language and "Ok Google" detection.
<b>SPEECH</b>	
Text-to-speech output	Set speech settings. You can set preferred engine, speech rate, and voice pitch and listen to an example.
<b>MOUSE/TRACKPAD</b>	
Pointer speed	Set pointer speed when this cell phone is connected with mouse or trackpad.

Reverse buttons	Switch the functions of the left and right buttons of the connected mouse.
-----------------	--

## Backup & reset

Backing up and Initializing settings.

<b>GOOGLE BACKUP</b>	
Back up my data	Set to backup on the Google server or not.
Backup account	Set an account for backup. Add an account to use as a backup in "Add account".
Automatic restore	Restore backed up settings and data when installing an application again.
<b>RESET</b>	
Network settings reset	Initialize the network settings including Wi-Fi® and Bluetooth®.
Factory data reset	Delete all the data inside this cell phone.

## Initializing this cell phone

- 1 From the Home screen, tap "Apps" ► "Settings" ► "Backup & reset"
- 2 Tap "Factory data reset" ► "RESET PHONE" ► "Delete all" ► "OK"
  - When deleting the data saved in microSD card, place a check mark in "Erase SD card".

### Note

- The battery level should be more than 30% for initializing this cell phone.
- Backup your data such as images, videos and music on PC. For details about connection method, refer to "File Management" (P195) and "External Device Connection" (P206).

## Google

Check, change, or delete information or settings related to your Google account and the services.

- For details on Google settings, from the Home screen, tap "Apps" ► "Settings" ► "Google" ► ⓘ ► Tap "Help & feedback" to refer to Help.

## SYSTEM

Set shortcut keys, date and time, accessibility, and cell phone information.

### Shortcut keys

Set whether to launch Capture+ to write a note or to launch camera by pressing the volume key twice when the screen is off or on the lock screen.

### Date & time

Set settings about date and time.

BASIC	
Auto-date & time	Set the automatic retrieval of date and time information via the network.
Set date	Set date manually. <ul style="list-style-type: none"><li>• Set up the settings after turn off "Auto-date &amp; time".</li></ul>
Set time	Set time manually. <ul style="list-style-type: none"><li>• Set up the settings after turn off "Auto-date &amp; time".</li></ul>

Auto-time zone	Set the automatic retrieval of time zone information via the network.
Select time zone	Set time zone manually. <ul style="list-style-type: none"><li>• Set up the settings after turn off "Auto-time zone".</li></ul>
TIME FORMAT	
Use 24-hour format	Set to display the time in 24-hour or 12-hour format.

## Accessibility

Set application settings related to accessibility.

TYPE		
Vision	TalkBack	Enable user assistance service such as responding to user operations via audio and vibrations and reading out text. Also set settings of speech, other feedback, touch exploration, etc.

Vision	Voice notifications	Set whether to read out the sender's information and the message contents of a received message (SMS) automatically. <ul style="list-style-type: none"><li>• Set preferred engine, adjust speech rate, and voice pitch and listen to an example demonstration in "Voice notifications language".</li></ul>
	Screen shade	Set the brightness to the minimum to save battery.
	Font size	Select from "Minimum", "Small", "Medium", "Large", "Very large", "Maximum".
	Touch zoom	Zoom in or zoom out by triple-tapping the screen.
	Screen color inversion	The colors of screen and contents are inverted.



Vision	Screen color adjustment	Adjust the display color of screen and contents.
	Screen color filter	Select "Protanomaly", "Deuteranomaly", or "Tritanomaly" to change the color tone of the display.
	Power key ends call	Press the power button to end a call.
Hearing	Captions	Customize the subtitle settings for hard-of-hearing people.
	Flash alerts	Set the camera flash to blink during an incoming call or a notification.
	Audio type	Select an audio type from "Mono" / "Stereo".
	Sound balance	Adjust the volume balance by sliding to left or right.

Motor & cognition	MOTOR	
	Touch feedback time	Select a touch response sensitivity from "Short", "Medium", and "Long".
	Touch assistant	Display the touch board to access to the physical button functions or a gesture quickly.
	Screen timeout	Set time duration before screen turns off automatically.
	COGNITION	
	Touch control areas	Set the screen area where the touch operation is not allowed.

GENERAL	
Accessibility features shortcut	Set whether to activate accessibility by triple-tapping the home key. Available functions are "TalkBack" / "Screen color inversion" / "Touch assistant" / "Accessibility settings".
Auto-rotate screen	Automatically switch the screen to portrait display/landscape display when this cell phone is rotated.
SERVICES	
おすすめ使い方ヒント (Osusume hint)	Set whether to display Osusume hint, which explains how to use the cell phone in response to operations and use situations.

Switch Access	The operations when the back key, or home key, etc. is pressed set whether controlling is to be substituted by physical key combinations such as the power key, etc.
---------------	--

### Note

- You can download and set applications compatible with user assistance services from Google Play.
- If you authorize the usage of TalkBack, be careful since personal information such as credit card numbers, etc. might also be recorded in exchanges via user interfaces. If perchance, data and information which were registered happen to be leaked, please be forewarned that mobile operator shall not bear any responsibility.

- If TalkBack is allowed to use, the Touch guide function also becomes valid. The Touch guide is a function which can read aloud and display explanations of the items where your finger is positioned. After you once turn on the Touch guide functions, tap items once to select them, after they are selected, then double tapping and scrolling become a two finger operation.  
To turn off the Touch guide individually, from the Home screen, tap "Apps" ► "Settings" ► "Accessibility" ► "Vision" ► "TalkBack" ► "Settings" ► remove check mark from "Explore by touch".
- When the Home screen is set to mobile operator home, TalkBack may not function normally.

## About phone

Information related to this cell phone is displayed.

Phone name	Set phone name for Bluetooth®, Wi-Fi Direct®, etc.
------------	--

Update Center	App Updates	(P241)
	Software Update	(P237)
Network		Network, mobile network type, service state, roaming, mobile network state, and IP address are displayed.
Status		Your phone number and IMEI are displayed.
Battery		<p>The battery status and remaining power are displayed.</p> <ul style="list-style-type: none"> <li>• Place a check mark in "Alarm battery condition" to display a message when the battery is not in a good condition.</li> </ul>

<b>Hardware info</b>	Model number (model name), Hardware version, Up time, S/N, Wi-Fi® MAC address, and Bluetooth® address are displayed.
<b>Software info</b>	Android version, Android security patch level, Baseband version, Kernel version, Build number, and Software version being used in this cell phone are displayed.
<b>Legal info</b>	Legal Documents for LG Software, Open source license, Google legal are displayed.
<b>Activity logs</b>	Set whether to agree to sending information of the cell phone to LG.
<b>Regulatory &amp; Safety</b>	The name of the cell phone and credential information, etc. are displayed.

## Checking your own phone number

- From the Home screen, tap "Apps"
  - ▶ "Settings" ▶ "About phone" ▶ "Status"
  - Your phone number is displayed in "My phone number".

# File management

## Storage Structure

### This Cell Phone (Internal Storage)

Main created folders in the phone (internal storage) at the time of purchase are as follows.

- Depending on operations on the cell phone, displayed folders may differ.

Alarms	Save music data etc. for alarm sound.
Android	Save setting data or temporary files for the system or applications.
DCIM	Save still image/video data shot by the camera (when the saving location is set to the cell phone).

Download	Save data downloaded by the browser.
Movies	Save video data.
Music	Save music data.
Notifications	Saves music data etc. to be set as notification sound.
Pictures	The still image data is saved.
Podcasts	Podcast data is saved.
Preload	The data saved beforehand after purchasing is saved.
Ringtones	Save music data etc. for ringtone or alarm sound.

## microSD card (External Storage)

You can attach microSD card (including microSDHC card and microSDXC card) to the cell phone and use it.

- This cell phone supports a microSD card of up to 2 GB, a microSDHC card of up to 32 GB, and a microSDXC card of up to 200 GB (as of June 2016).
- A microSDXC card can only be used with SDXC compatible devices. Do not insert a microSDXC card into a device incompatible with SDXC since it may cause damage to the data stored in the microSDXC card.
- To use microSDXC card again with damaged data inside, you need to initialize the microSDXC card with an SDXC compatible device (all data will be deleted).
- To data copy with an SDXC incompatible device, please use a card that meets the standard of a copy destination/copy source device such as microSDHC card or microSD card.
- Consult each microSD card manufacturer for information about the compatible microSD card.

- The UHS speed class of microSD card supported by this cell phone is class 1.
- The speed class of microSD card supported by this cell phone is up to class 10.

### Inserting microSD card

- 1** Open the slot cap (P35)
- 2** Insert the SIM eject tool straight into the tray eject hole (P43)
- 3** Remove the tray from this cell phone (P43)
- 4** With the metal contacts facing down, insert the microSD card into the microSD card slot

**5** Push the tray straight into this cell phone

**6** Press firmly the slot cap of this cell phone to close (P35)

#### Removing microSD card

When removing the microSD card, make sure to unlock the SD card mount (safely remove) before removing it (P176).

**1** Open the slot cap (P35)

**2** Insert the SIM eject tool straight into the tray eject hole (P43)

**3** Remove the tray from this cell phone (P43)

**4** Remove the microSD card from the tray

**5** Push the tray straight into this cell phone

**6** Press firmly the slot cap of this cell phone to close (P35)

## Note

- If you lost the SIM eject tool, use a paper clip as an alternative.



Example of a paper clip

## Formatting microSD card

Note that formatting microSD card erases all data in the microSD card.

- 1 From the Home screen, tap "Apps" ► "Settings" ► "Storage & USB"
- 2 "SD card" ►  ► "Settings" ► "Format" ► "FORMAT" ► "DONE"

## File Operations

### File or Folder Operations

Use "File Manager" to display or manage the data, such as the still images, videos, music or documents, which were saved in this cell phone.

## Storage in this cell phone

- 1 From the Home screen, tap "Apps" ► "File Manager"
- 2 Tap "All files" / "Music" / "Image" / "Video" / "Document"
- 3 Tap a folder or file
  - When the application selection screen is displayed, select an application to use and tap "OK". The file is displayed/played.

## Creating a folder

- 1 From the Home screen, tap "Apps" ► "File Manager"
- 2 Tap "All files" ► "Internal storage" / "SD card" ► tap the folder if necessary
- 3 Tap  ► Enter a folder name ► "SAVE"

## Note

- A folder can only be created in "Internal storage" or "SD card" of "All files".



## Renaming a file or folder

- 1 From the Home screen, tap "Apps" ► "File Manager"
- 2 Tap "All files" / "Music" / "Image" / "Video" / "Document" ► Tap a folder if necessary
- 3 Touch and hold a folder/file ► "Rename" ► Enter a name ► "SAVE"

### Note

- When purchasing, some folders such as "Android" or "DCIM" which were created in this main unit (internal storage) cannot be renamed.

## Deleting a file or folder

- 1 From the Home screen, tap "Apps" ► "File Manager"
- 2 Tap "All files" / "Music" / "Image" / "Video" / "Document" ► Tap a folder if necessary
- 3 Touch and hold a folder/file ► "Delete" ► "YES"

### Note

- When purchasing, some folders such as "Android" or "DCIM" which were created in this main unit (internal storage) cannot be deleted.

## Moving/Copying a file or folder

- 1 From the Home screen, tap "Apps" ► "File Manager"
- 2 Tap "All files" ► Tap the folder if necessary
- 3 Touch and hold a folder/file ► "Move" / "Copy"
- 4 Display the moving destination/copy destination folder ► "OK"

### Note

- When purchasing, some folders such as "Android" or "DCIM" which were created in this main unit (internal storage) cannot be moved or copied.

# Data Communication

## Bluetooth® Communication

Connect this cell phone to Bluetooth® devices wirelessly, to exchange data.

- For Bluetooth® compatible version or profile, refer to "Main Specifications" (P242).
- For Bluetooth® setting and operation procedure, refer to the manual of the Bluetooth® devices being connected.
- We do not guarantee that this cell phone can be connected to all Bluetooth® devices wirelessly.

### ■ Notes on using Bluetooth® function

- The distance between this cell phone and another Bluetooth® device should be kept within approximately 10 m with no obstructions in sight. The detectable distance may be shorter when there are obstructions between this cell phone and another device, or depending on the conditions of the surroundings (such as walls or furniture) and the structure of a building. Especially when there is a wall or floor of reinforced concrete between them, they may be unable to connect with each other. Note the above mentioned distance is not guaranteed.
- Make sure to keep this cell phone 2 m or more away from another device such as home electric appliances, AV devices, OA devices, etc. Microwave oven can easily affect wireless function, so keep this cell phone 3 m or more away from the microwave oven. Otherwise, normal connection cannot be performed when nearby electric devices are powered on. TVs and radios may receive noise or video interference.

- Move the Bluetooth® device to a place where connection is available when there is a broadcast station or radio near the device or else this cell phone cannot be connected to the device. Strong radio waves may prevent from connection between this cell phone and the device.
- Wireless connection is available when Bluetooth® device is put in a bag or pocket. However, lowering of communication speed or noise may result when you are in between the Bluetooth® device and this cell phone.
- The radio wave from Bluetooth® may affect the operation of medical electronics etc. Some cases in communication may result in an accident, so turn off this cell phone and other Bluetooth® devices in the following places.
  - On trains
  - On airplanes
  - In hospitals
  - Near automatic doors or fire alarms
  - In places such as gas stations where flammable gas is generated

#### ■ Reception interference caused by wireless LAN devices

- As this cell phone's Bluetooth® function and wireless LAN devices use the same frequency (2.4 GHz), reception interference may occur or the communications speed may lower if you use this cell phone near the wireless LAN devices. Also, you may hear noise or have a connection problem. In these cases, do the following:
  - Keep the Bluetooth® device over 10 m away from this cell phone or the wireless LAN device.
  - Within 10 m, turn off the wireless LAN device.

#### ■ Pass code (PIN) of Bluetooth® function

- Pass code (PIN) of Bluetooth® function is an authentication code to enter when accessing Bluetooth® devices for the first time to recognize and permit the connection each other. Entering the same pass code (PIN) (up to 16 single byte alphanumeric characters) on each sending/receiving device is required.
- On this cell phone, pass code may sometimes be displayed as "PIN".

## Turning ON Bluetooth® Function to Make This Cell Phone Discoverable

- 1 From the Home screen, tap "Apps"  
▶ "Settings" ▶ "Bluetooth"
- 2 Turn on "Bluetooth"

### Note

- When you do not use Bluetooth® function, turn Bluetooth® function off to save the battery.
- The setting of the Bluetooth® ON/OFF is not changed even when the power is turned off.

## Changing the name of this cell phone

You can change the name of this cell phone displayed on another device when communicating via Bluetooth® communication.

- 1 From the Home screen, tap "Apps"  
▶ "Settings" ▶ "Bluetooth"
- 2 Turn on "Bluetooth"
- 3 Tap  ▶ "Edit phone name"

- 4 Enter each item ▶ "SAVE"

## Pairing/Connecting with Other Bluetooth® Device

To transfer data by Bluetooth® communication, perform pairing (pairing setting) with another device in advance, and then register it to this cell phone.

- Depending on Bluetooth® devices, there are devices with only pairing and those conduct till connection.

- 1 From the Home screen, tap "Apps"  
▶ "Settings" ▶ "Bluetooth"

- 2 Turn on "Bluetooth"

- Detected Bluetooth® devices are displayed by list.
- If no Bluetooth® devices are displayed, tap "SEARCH" to re-search.

- 3 Tap a desired device to connect with ▶ "PAIR"

- Pass key (PIN) may be required depending on the Bluetooth® device to be connected to.

## Note

- Even for devices requiring pass code (PIN) when pairing, once pairing is performed, it is not necessary to enter the pass code (PIN) to reconnect after disconnected as long as the pairing is not canceled.
- You can set pairing even if it is a device unable to connect such as an incompatible profile. However, it cannot be connected even if you tap the device.
- Devices that are not compatible with SCMS-T cannot play data such as music data despite the types of audio related data.

## When answering pairing request from another device

When a screen asking for pairing when connecting Bluetooth® communication displayed, tap "PAIR" or enter pass code (PIN) if required, then tap "OK".

## Disconnecting

- 1 Tap a desired device to disconnect from "PAIRED DEVICES" list ▶ "OK"

## Canceling pairing

- 1 Tap  beside the device that you want to unpair from the "PAIRED DEVICES" list ▶ "Unpair"

## Sending/Receiving Data via Bluetooth® Function

- Turn on Bluetooth® function beforehand to make this cell phone detectable.

## Sending data via Bluetooth® function

You can send data of phonebook (name card data in vcf format), files such as photos or videos, etc. to another Bluetooth® device (PC etc.).

- For sending, perform the operation from the menu such as "Share" / "Send" of each application.

Example: To send still images from Gallery

- 1 Pairing/connecting this cell phone with another Bluetooth® device (P202)

- 2 From the Home screen, tap "Gallery"  
▶ Select and display the photo you want to send
- 3 Tap  ▶ "Bluetooth" ▶ Select a Bluetooth® device
- 4 Receive the data by following the on-screen instructions on the device of the recipient

#### Receiving data via Bluetooth® function

- 1 Pair/connect this cell phone with another Bluetooth® device (P202)
- 2 The data is sent from the other Bluetooth® device
- 3 Tap "ACCEPT" when the file transfer request screen is displayed on this cell phone
  -  appears in the status bar, and data reception starts.
  - You can confirm data reception on the notification panel.
  - Message screen appears at the bottom screen after receiving data.

## NFC Communication

NFC is short for Near Field Communication. It is an international standard proximity wireless communication system determined by ISO (International Organization for Standardization). This cell phone enables non-contact IC card function, Reader/writer function, P2P function, etc.

Use NFC function to transfer data with other compatible devices.

- For holding over the other device, see P126.

## Android Beam

You can transmit and receive data with a device equipped with Reader/Writer, P2P functions.

- Enable the Reader/Writer, P2P function and place a check mark in "Android Beam".
- If NFC/Osaifu-Keitai is set to lock, Android beam cannot be used.
- Depending on the application, Android beam may not be used.
- We do not guarantee any communication with a cell phone equipped with Reader/Writer, P2P functions.



## Transmitting data

Transmit files of browser webpages, contacts, images and video to other NFC compatible terminals.

Example: To transmit images from Gallery

- 1 Enable the Android beam function on the receiving end terminal
- 2 Enable the Reader/Writer, P2P function on this cell phone and place a check mark in "Android Beam" (P166)
- 3 From the Home screen, tap "Gallery"  
▶ Select an image to transmit
- 4 Align the  mark on this cell phone and the receiving end terminal, and bring them close together
  - The beam share screen is displayed.
- 5 Tap beam share screen
  - The beam receiving starts on the receiving end terminal.

## Receiving data

- 1 Enable the Android beam function on the transmitting end terminal
- 2 Enable the Reader/Writer, P2P function on this cell phone and place a check mark in "Android Beam" (P166)
- 3 Align the  mark on this cell phone and the transmitting end terminal, bring them close together, and operate on the transmitting end terminal
  - The beam receiving starts.
  -  is displayed in the status bar.
  - Reception status can be confirmed via the notification panel.
  - After reception ends, a message screen is displayed at the bottom of the screen.

# External Device Connection

## Connecting with a PC

You can synchronize data, such as music, with "Windows Media Player" on your PC by connecting this cell phone with your PC via the micro USB Cable O1 (optional), and drag and drop the data to transfer it between the PC and this cell phone.

- To recognize this cell phone on your PC, a dedicated driver and Windows Media Player 11 or later are required.
  - For details about how to download and operate the dedicated driver, refer to the homepage below.  
<http://www.lg.com/jp/support/software-manuals> (In Japanese only)
  - You can download the latest Windows Media Player on Microsoft website.  
<http://windows.microsoft.com/en-us/windows/download-windows-media-player>
- Some functions such as shooting and playing a video may not work while this cell phone is being connected with a PC.

- Some data may not be available due to copyright.

### Note

- To operate a file, operating environment on PC side is shown as follows:
  - OS: Windows 10/Windows 8.1/Windows 7/Windows Vista
  - Windows Media Player: Windows Media Player 11 or later
  - \* We do not guarantee operations conducted in environment with upgraded OS or in added/changed environment.
- Use a PC to back up the client's data saved in the internal storage of this cell phone and microSD card.
- The data saved in the internal storage of this cell phone or microSD card from other devices such as PCs may not be able to display on this cell phone. Also, the data saved in the PC from this cell phone may not be able to display on other devices.



## Connecting This Cell Phone with a PC

- 1 Insert the microUSB plug of micro USB Cable 01 in the external connection terminal of this cell phone
  - Insert the microUSB plug horizontally with USB mark facing up.
  
- 2 Insert the USB plug of microUSB Cable 01 in the USB port on PC
  - This cell phone is recognized automatically on a PC.

### Note

- While reading or writing the data, do not disconnect the power.
- Do not unplug microUSB cable during reading or writing data. Loss of data may cause.

## Operating Data in the Cell Phone from a PC

Connect this cell phone and a PC with microUSB Cable 01 (optional). You can operate data in the cell phone from the PC.

- 1 Connect the cell phone to PC via microUSB Cable 01 (P207)
- 2 Select the USB connection method

Charging only	Charge the cell phone only.
File transfer	Transfer music, movies, etc. using file management software compatible with MTP.

Photo transfer	Transfer photos or movies to PC etc. which are not compatible with MTP.
Tethering	(P164)
MIDI device	Use the cell phone for MIDI input.

### 3 "JUST ONCE"/"ALWAYS"

#### Note

- To change the USB connection method, open the notification panel ► Tap the notification of USB connection and select the USB connection method.

## Connecting with Printer

You can print browser images or pictures with a Wi-Fi® supported printer.

- For operation method about Wi-Fi® supported printer, check the Wi-Fi® supported printer's instruction manual.
- This cell phone and the printer need to be connected with either the same Wi-Fi® network or the same Wi-Fi Direct®.

## Wireless Print

Example: To print out pictures from Gallery

- 1 From the Home screen, tap "Gallery"
- 2 Select a picture you want to print out
- 3 Tap  ► "Print"
- 4 Follow the on-screen instructions

## Connecting with Other Devices

### Using SmartShare Beam

Use SmartShare Beam to send or receive contents.

#### Setting SmartShare Beam

Set to publish the contents on this cell phone on other client devices.

- 1 From the Home screen, tap "Apps" ► "Settings" ► "More..." ► "SmartShare Beam"
- 2 Turn on "SmartShare Beam"

(Device name)	Change the name of this cell phone which is displayed on another device.
Storage	Set a destination to save the received data.

File transfer history	Display the list of all the files which were sent/received by SmartShare Beam.
Help	Display Help.

### Sending files via SmartShare Beam

You can send contents in this cell phone to other client devices.

Example: To send pictures from Gallery

- 1 From the Home screen, tap "Gallery"
- 2 Select a picture you want to send
- 3 Tap  ► "SmartShare Beam"
- 4 Tap a device to send the picture
  - When it is sent by Wi-Fi Direct<sup>®</sup>, turn on the SmartShare Beam on the receiving device in advance.
  - When it is sent by Bluetooth<sup>®</sup>, pair with the receiving device in advance.
  - When the device is not displayed, tap "RESCAN" to scan the device.

## Receiving files device via SmartShare Beam

You can receive contents from other devices.

- 1 When "File transfer" screen is displayed, "YES"/"ACCEPT"
  -  is displayed on the status bar. Data reception starts.
  - You can confirm the reception condition from notification panel.
  - When data is received, a message screen is displayed at the bottom of the screen.

## Displaying on Wi-Fi<sup>®</sup> Miracast Supported Device via Wi-Fi<sup>®</sup> Connection

Connect this cell phone and a Wi-Fi<sup>®</sup> Miracast supported device via Wi-Fi<sup>®</sup> connection to show videos and pictures on TV or on a display.

- Turn on Wi-Fi<sup>®</sup> function beforehand.
- 1 From the Home screen, tap "Apps" ► "Settings" ► "More..." ► "Miracast"
  - 2 Turn on "Miracast"
    - Tap "SEARCH" if the device you want to connect is not displayed.

## 3 Tap a detected Wi-Fi<sup>®</sup> Miracast supported device

### Disconnecting Wi-Fi<sup>®</sup> Miracast supported device

- 1 Tap a Wi-Fi<sup>®</sup> Miracast supported device to disconnect ► "OK"

#### Note

- Video or audio may not be output properly when connecting with a device that does not support HDCP. Depending on the contents, some may not be allowed to output from the content provider, some may be checked on due to the functional issues.
- When you have an incoming call during connection, the incoming call screen is also displayed in the connected device.
- For some applications, contents are displayed in the connected device. Operations such as playback in this cell phone are available.

# Using Overseas

## Outline of International Roaming (WORLD WING)

The international roaming service (WORLD WING) allows you to use your cell phone in the service areas of overseas operators affiliated with mobile operator, with the same phone number and email address. Calls and SMS can be used without changing settings.

### ● Available network

The cell phone is placed in Class 5. You can use it in LTE network, 3G network and GSM/GPRS network service areas. It can also be used in countries/regions supporting 3G 850MHz/GSM 850MHz networks. Please check the information about the available areas.

### ● Before using this cell phone overseas, read the following item.

- Mobile operator Website.

### Note

- For country codes/international call access codes/universal number international prefix, supported countries/ areas and network operators, refer to mobile operator Website.

## Available Service Overseas

Main communication service	3G	3G 850	GSM (GPRS)	LTE
Calls	○	○	○	○
SMS	○	○	○	○
Email*	○	○	○	○
Browser*	○	○	○	○

(○: Available ×: Unavailable)

\* To use data communication when roaming, turn ON the data roaming settings (P213).

### Note

- Some services are not available depending on the overseas network operator or network.
- Confirm the name of the network operator being connected on the notification panel (P69).

## Before Using Overseas

### Confirming before Departure

Before using this cell phone overseas, check the following information in Japan.

#### ● Contract

- Check whether you have applied for WORLD WING. For more details, contact "General Inquiries" on the back cover of this instruction manual.

#### ● Battery Charge

- About charging, see mobile operator Website.

#### ● Charges

- Fees are charged differently (call fee, packet communication fee) for overseas use from the charge in Japan. For details, see mobile operator Website.
- Auto communication may start depending on the applications you use, therefore packet communication fees may become high. Ask the supplier for operating conditions of each application.

## Pre-configuring

### ● Network service configuration

If you have subscribed Network service, voice mail service, call forwarding service, number notification service, etc. are available overseas. However, some network services are unavailable.

- Starting "Remote operation settings" service is required when using networks service overseas. You also can set "Remote operation settings" after arriving abroad.
  - From Japan (P97)
  - From overseas (P219)
- Network service may not be available to use depending on the network operator you are using abroad even if you can set or cancel the settings.

## Confirming Overseas

When you arrive at overseas, this cell phone automatically connects to an available network operator if it is powered on.

### ● About connections

Place a check mark in "Select automatically" of "Network operators" to select the optimum network automatically.

## Settings for Using Overseas

### Setting data roaming

To perform packet communication overseas, you need to turn on data roaming.

- 1 From the Home screen, tap "Apps" ▶ "Settings" ▶ "More..." ▶ "Mobile networks"
- 2 Tap "Data roaming" ▶ Confirm notes screen and tap "OK"

### Setting a network operator

While purchasing, this cell phone is set to detect the available networks automatically and switch to it. When setting up manually, set the following settings.

- 1 From the Home screen, tap "Apps" ▶ "Settings" ▶ "More..." ▶ "Mobile networks" ▶ "Network operators" ▶ "Search networks"
  - Search and display available networks.
  - When an error occurs during the network search, turn off "Data enabled" and perform it again (P163).

## 2 Select a network of network operators

- To switch networks automatically, place a check mark in "Select automatically".

### Setting network mode

- 1 From the Home screen, tap "Apps"  
▶ "Settings" ▶ "More..." ▶ "Mobile networks" ▶ "Preferred network type"
- 2 Tap "LTE/3G/GSM(Auto)" / "3G/GSM" / "GSM"

### About date & time

If you place a check mark in "Auto-date & time" and "Auto-time zone" in "Date & time", the time and time zone of this cell phone's clock will be automatically changed when information about the local time and time zone is received from the network of the overseas operator to which you are connected.

- The automatic time/time zone setting may not work properly depending on the overseas operator. In that case, set the time zone manually.

- The timing of these changes may differ depending on the overseas operators.
- "Date & time" → P189

### Inquiries

- If your cell phone or nano UIM card is lost or stolen overseas, contact mobile operator immediately from your current location and carry out the procedure to suspend usage. For contact information, refer to the back cover of this manual. Please note that you are liable for any call or communication charges incurred after the loss or theft of this cell phone.
- You will need the country's "international call access code" or "universal number international prefix" if calling from a land-line phone overseas.





## How to Make and Receive Calls at Your Location

### Making Calls to Other Countries (including Japan)

You can use the international roaming service to make calls to other countries while overseas.

- For information of available countries or network operators, see mobile operator Website.

- 1** From the Home screen, tap "Phone"  
▶ "Dial" tab
- 2** Enter "+" (touch and hold down "0")  
▶ country code ▶ area code (city code) ▶ other party's phone number in order
  - If the area code begins with "0", remove the first "0" when entering the number. However, "0" may be required in some countries and regions such as Italy.

- 3** 
  - When placing a check mark in "Automatic conversion" of "International dial assist", enter a number starts from area code the same as when you call in Japan ▶   
▶ Tap "Converted number".
  - When making video call  
Tap  ▶ "Video call".

- 4** Tap "END CALL" to end a call

### Making a Call Domestically

You can make a call to the other party's land-line phone or a mobile phone in the same way as in Japan.

- 1** From the Home screen, tap "Phone"  
▶ "Dial" tab
- 2** Enter the other party's phone number
  - To make a call to a land-line phone, enter the area code (city code) and the other party's phone number.
- 3** 
- 4** Tap "END CALL" to end a call

## Making a Call to WORLD WING Users

When the other party that you are making a call to is a WORLD WING user, make a call as if you are making an international call to Japan even if the other party is in the country in which you are staying.

- Dial "+" and "81" (country code of Japan) first and then dial the phone number omitting the "0" at the beginning as if you are making a call to Japan because the call is routed through Japan regardless of the destination.

## Receiving Calls Overseas

You can receive calls in the same way as in Japan.

### Note

- When you receive a call while using the international roaming service, the call is forwarded internationally from Japan, regardless of the country from which the call is made. The call is charged the same as the call to Japan, and the receiver is charged the incoming call charge.
- Even if the other party has made a call with notification of the Caller ID set, you may not be notified of the Caller ID depending on the overseas operator. Also, the number you are notified of may differ from the other party's Caller ID depending on the network that the other party is using.
- "Reject call setting" may not be declined during use overseas (P98).

## Making a Call from Other Parties

- **Having the other party call you overseas from Japan**  
Have the other party call you by dialing your phone number in the same way as you do when you are in Japan.
- **Having the other party call you overseas from a country outside Japan**  
You need to have the other party dial the international call access code and "81" (country code of Japan) regardless of the destination because the call is routed through Japan.

## Setting International Roaming

Setup to use the international roaming service or international phone calls.

- Depending on the overseas network operator, roaming cannot be set up in some cases.

**1** From the Home screen, tap "Phone"  
▶ ⋮ ▶ "Call settings" ▶ "Roaming settings"

**2** Change the settings if necessary

Incoming call restriction while roaming	During the international roaming, set to restrict the incoming calls or not.
Incoming call notification while roaming	During the international roaming, set to notify the incoming calls via SMS or not when in places out of service, etc.

<b>Roaming guidance</b>	During the international roaming, the notification that you are being overseas will be sent to the caller.
-------------------------	--

<b>Inter national dial assist</b>	<b>Auto matic con version</b>	Set Automatic conversion function. <ul style="list-style-type: none"> <li>When placing a check mark in "Automatic conversion", an international dial assist screen appears for calls with "+" entered at the beginning of the phone number. Tap "Converted number" to convert "+" to an international access code registered in "International prefix".</li> </ul>
	<b>Country code</b>	Add country code for international call.

<b>Inter national dial assist</b>	<b>Inter national prefix</b>	Add prefix international access code at the beginning of the phone number for international call.
<b>Network service</b>	<b>Remote operation (charges apply)</b>	Set network services such as voicemail from overseas.
	<b>Caller ID notification request service (charges apply)</b>	

<b>Network service</b>	<b>Incoming call notification while roaming (charges apply)</b>	<ul style="list-style-type: none"> <li>• Activate "Remote operation settings" beforehand.</li> <li>• For operations from overseas, international call fee to Japan in the country you use is charged.</li> <li>• Depending on the overseas network operators, you cannot make the settings.</li> </ul>
	<b>Roaming guidance (charges apply)</b>	
	<b>Voice mail service (charges apply)</b>	
	<b>Call forwarding service (charges apply)</b>	

## After Returning to Japan

When you return to Japan, this cell phone automatically connects to the mobile operator network. If it is unable to connect, change the following settings.

- Set "Preferred network type" to "LTE/3G/GSM (Auto)" (P214).
- Place a check mark in "Select automatically" of "Network operators" (P213).

# Appendix/Index

## Troubleshooting (FAQs)

### Trouble shooting

- First, check whether software update is required. If so, update the software (Software Update → P237).
- If it does not improve after confirming the check items, contact "Technical Inquiries & Repairs" (in Japanese only) on the back cover of this manual or a repair counter specified by mobile operator.

#### ■ Power supply

Symptom	Check item
Power does not turn on	<ul style="list-style-type: none"><li>• Is the battery dead? → P45</li></ul>

Symptom	Check item
The screen freezes/The cell phone cannot be turned off.	<ul style="list-style-type: none"><li>• When the screen is frozen or the power cannot be turned off, you can press and hold the power key and volume key (down) for 9 seconds or longer to force restart the cell phone.<ul style="list-style-type: none"><li>* Note that some data and settings may be erased due to force-restart operation.</li></ul></li></ul>

## ■ Charging

Symptom	Check item
Cannot charge Notification LED light does not light up or blink	<ul style="list-style-type: none"><li>• Is the adapter plug and cigar lighter plug properly inserted into power outlet or cigar lighter socket?</li><li>• Are the adapter and this cell phone set properly?</li><li>• When using the AC adapter (optional), is the AC adapter firmly connected to this cell phone?</li><li>• Any call or data communication while charging, or using other functions for a long time may result in this cell phone getting hot and cannot charge the internal battery to protect. In this case, charge again after this cell phone cools down.</li></ul>

Symptom	Check item
Cannot charge Notification LED light does not light up or blink	<ul style="list-style-type: none"><li>• When the internal battery which is completely discharged is charged, the notification LED blinks. If the battery charge is not finished by continuing charging, the internal battery needs to be replaced. For replacement of the internal battery, contact "Technical Inquiries &amp; Repairs" (in Japanese only) on the back cover of this manual or mobile operator specified repair office.</li></ul>

## ■ Cell Phone operations

Symptom	Check item
Becomes hot during operation or charging	<ul style="list-style-type: none"><li>• While operating or charging, or if you operate applications or watch 1Seg for a long time while charging, the cell phone, internal battery, or adapter may become hot. There is no operation problems and you can continue to use it.</li></ul>



Symptom	Check item
Battery life is short	<ul style="list-style-type: none"> <li>Is the cell phone left for a long time under the state of out of service area? Out of service area, a lot of power is consumed to search available radio waves.</li> <li>The operation time of the internal battery varies by the operating environment and the secular degradation of the internal battery.</li> <li>The internal battery is a consumable accessory. The usage duration of the battery per 1 charge decreases gradually each time the battery is recharged. When the operation time is too short even if the cell phone is fully charged, contact "Technical Inquiries &amp; Repairs" (in Japanese only) on the back cover of this manual or a repair counter specified by mobile operator.</li> </ul>

Symptom	Check item
No reaction when tapping the touch screen or pressing the keys	<ul style="list-style-type: none"> <li>Has the screen been locked? → P173</li> <li>Is the power off? → P48</li> </ul>
Slow reaction when tapping the touch screen or pressing the keys	<ul style="list-style-type: none"> <li>It might occur if a large amount of data is saved in cell phone or data with extremely large size are processed between this cell phone and microSD card.</li> </ul>
The nano UIM card is not recognized	<ul style="list-style-type: none"> <li>Is the nano UIM card inserted in the right direction? → P42</li> </ul>
Clock is wrong	<ul style="list-style-type: none"> <li>Clock may become wrong if the power has been turned on for a long time. Check if it is set to "Auto-date &amp; time", move to a place with better reception and power it on. → P189</li> </ul>

Symptom	Check item
Cell phone operation is unstable	<ul style="list-style-type: none"> <li>• It may be caused by applications installed to the cell phone after purchase. If problems improve when you start in Safe mode (a function to activate the cell phone in a mode similar to default), problems may be improved by uninstalling the application.               <ul style="list-style-type: none"> <li>- How to activate Safe Mode                   <ol style="list-style-type: none"> <li>1. While in the power OFF status, press and hold the power key for over two seconds.</li> <li>2. After the mobile operator logo appears, press and hold the volume key (down) until the Home screen appears.</li> </ol> </li> </ul> </li> </ul>

Symptom	Check item
Cell phone operation is unstable	<ul style="list-style-type: none"> <li>* Press the power key for over two seconds with the power turned on ► Touch and hold down "Power off" ► "OK" to activate.</li> <li>* When Safe mode starts, "Safe mode" appears on the bottom left of the screen.</li> <li>* To stop Safe mode, turn the power OFF once and restart it.</li> <li>- Before starting Safe mode, backup necessary data.</li> <li>- Widgets that you have created may be gone.</li> <li>- Safe mode is not the normal starting condition, so stop Safe mode before normal usage.</li> </ul>

Symptom	Check item
Applications does not work properly (cannot be activated or an error occurs)	<ul style="list-style-type: none"> <li>Is there a disabled application? Try again after enabling the disabled application. → P179</li> </ul>

## ■ Calls

Symptom	Check item
Cannot make a call even if  has been tapped	<ul style="list-style-type: none"> <li>Is this cell phone in Airplane mode? → P163</li> </ul>
The ringtone does not sound	<ul style="list-style-type: none"> <li>Is the ringtone volume set to minimum? → P170</li> <li>Is it set to Airplane mode or manner mode (Vibrate only, Silent)? → P163, P170</li> <li>Has the unregistered call reject been set? → P98</li> <li>Is the ring time for the Voice Mail Service or Call Forwarding Service set to "0 sec."? → P96</li> </ul>

Symptom	Check item
Calls are not connected (📶 does not disappear when you move, or calls cannot be made or received even when the radio wave is strong enough)	<ul style="list-style-type: none"> <li>• Turn the power off and on, or remove and attach the nano UIM card.</li> <li>• Due to the radio wave types, making/receiving calls may be unavailable even with state of "in the service area" and even when "radio wave is indicated as 📶". Move to the other place and call again.</li> <li>• Has the unregistered call reject been set? → P98</li> <li>• Due to the crossing of radio waves, at the crowded public places, calls/mails are crossed and the connection status may not be good. In that case, "Please wait for a while(Voice service)" appears and calling sound is played. Move to the other place or call again at other time.</li> </ul>

## ■ Screen

Symptom	Check item
The display is dim	<ul style="list-style-type: none"> <li>• Has the screen backlight timeout been set? → P172</li> <li>• Has the screen brightness been adjusted? → P172</li> <li>• Is the battery level low? → P45</li> <li>• Has power save been set? → P177</li> </ul>

## ■ Sound

Symptom	Check item
During a voice call, the other party's voice is difficult to hear or is too loud	<ul style="list-style-type: none"> <li>• Adjust the call volume with the volume key. → P91</li> </ul>

## ■ Mail

Symptom	Check item
Email is not received automatically	<ul style="list-style-type: none"><li>• Is there a check mark in "Auto-sync email"? Place a check mark in it. → P112</li><li>• Do you set "Sync schedule" to "Manual"? Set Sync schedule. → P112</li></ul>

## ■ Camera

Symptom	Check item
Photos and videos shot with the camera are blurred	<ul style="list-style-type: none"><li>• Check whether the lens are cloudy or have dirt on it.</li></ul>

## ■ TV (1Seg)

Symptom	Check item
Cannot watch 1Seg	<ul style="list-style-type: none"><li>• Are you at a location that is outside of the digital terrestrial broadcast service area, or where the broadcast wave is weak?</li><li>• Is the viewing area configured? → P138</li></ul>
Can be viewed images, but there is no audio	<ul style="list-style-type: none"><li>• For devices that do not support SCMS-T, the 1Seg sound cannot be heard.</li></ul>
Cannot obtain screenshots on 1Seg	<ul style="list-style-type: none"><li>• To protect the 1Seg copyright, the screenshot function is restricted. It is not an abnormal performance.</li></ul>

## ■ Osaifu-Keitai

Symptom	Check item
Osaifu-Keitai cannot be used	<ul style="list-style-type: none"><li>• If you activate Omakase Lock, Osaifu-Keitai function cannot be used regardless of NFC/Osaifu-Keitai lock settings.</li><li>• Is NFC/Osaifu-Keitai set to lock? → P127</li><li>• Did you swipe the  mark of this cell phone over the reader? → P126</li></ul>



## ■ Overseas use

Symptom	Check item
This cell phone is not available to use overseas	<ul style="list-style-type: none"><li>■ <b>Antenna mark appears</b><ul style="list-style-type: none"><li>• Have you applied for WORLD WING? Check whether you have applied for WORLD WING.</li></ul></li><li>■ <b>Icon which indicates out of service area appears</b><ul style="list-style-type: none"><li>• Are you at a location that is outside of the international roaming service area, or where the signal is weak? See mobile operator Website for whether it is an available service areas or overseas network operator.</li><li>• Try to change the settings of network or overseas network operator.<ul style="list-style-type: none"><li>- Set "Preferred network type" to "LTE/3G/GSM (Auto)". → P214</li><li>- Place a check mark in "Select automatically" of "Network operators". → P213</li></ul></li><li>• Turn off this cell phone and then turn it on again. → P48</li></ul></li></ul>

Symptom	Check item
Data communication is not available overseas	<ul style="list-style-type: none"> <li>Set Data roaming to ON. → P211</li> </ul>
This cell phone has become unusable suddenly while using overseas	<ul style="list-style-type: none"> <li>Has the approximate limit of usage fee been exceeded? For "International roaming service (WORLD WING)", the approximate limit of usage fee is set in advance. If the limit is exceeded, pay off the usage fee to resume services.</li> </ul>

Symptom	Check item
The other party's number is not displayed/ A different number is displayed/ The registered Phonebook or Caller ID notification does not operate properly	<ul style="list-style-type: none"> <li>Even if the other party has made a call with notification of the Caller ID set, you may not be notified of the Caller ID depending on the network or network operator. Also, the number you are notified may differ from the other party's Caller ID depending on the network or network operator you use.</li> </ul>

## ■ Data management

Symptom	Check item
Data transfer is not working	<ul style="list-style-type: none"><li>• Are you using a USB HUB? If you use a USB HUB, data transfer may not work properly.</li></ul>
Data saved on a microSD card is not displayed	<ul style="list-style-type: none"><li>• Remove and attach the microSD card. → P196</li></ul>
When trying to view an image,  appears or  appears in preview	<ul style="list-style-type: none"><li>•  may appear if image data has been destroyed.</li></ul>

## ■ Bluetooth® function

Symptom	Check item
This cell phone cannot find/be connected to a Bluetooth® compatible device	<ul style="list-style-type: none"><li>• Put the Bluetooth® compatible device (commercial) on standby and register it on this cell phone. If you want to delete a registered device and register it again as a new device, you must delete the registered device from both the Bluetooth® compatible device (commercial) and this cell phone before you register it again. → P202</li></ul>



Symptom	Check item
Cannot make calls from this cell phone when connected to an external device, such as a car navigation or hands free device	<ul style="list-style-type: none"> <li>If you attempt to call somebody several times when he or she does not answer or is out of the service area, calls to that number may be disabled. In this case, turn off this cell phone and then turn it back on again.</li> </ul>

## ■ Map and GPS function

Symptom	Check item
AUTO-GPS service information cannot be set	<ul style="list-style-type: none"> <li>Check if the AUTO-GPS function is deactivated due to low battery power.</li> <li>Check if the AUTO-GPS function is deactivated by the "Low-power operation settings", the AUTO-GPS service information cannot be set. In that case, change the "Low-power operation settings" to "Not suspend" or charge the battery to set it.</li> <li>Check if the AUTO-GPS operation setting is turned OFF.</li> </ul>

## Error Message

Error message	Description
No SIM card	The nano UIM card is not working properly. If the problem is not resolved by removing and reinserting the nano UIM card, contact "Technical Inquiries & Repairs" (in Japanese only) on the back cover of this manual.
No service	You cannot use this cell phone because it is out of the service area or it is in a place where there is no signal reception. Move to a location where you can get signal reception.
PIN1 code blocked Enter PUK	Enter your PIN unblocking key correctly. → P185

Error message	Description
<ul style="list-style-type: none"><li>• Not enough space on all storage. To free up space, delete some files.</li><li>• Storage space is running out. If you keep using, some functions and applications may not be operated. Try to free space by deleting items, such as apps or media content.</li></ul>	It is displayed when there is not enough space to save a file, application or media contents, or to operation part function or application. You can delete files or media contents or uninstall applications to ensure the enough space. → P123, P199
<ul style="list-style-type: none"><li>• Please wait for a while(Voice service)</li><li>• Please wait for a while(Data service)</li></ul>	This is displayed when audio/data services are restricted due to heavy traffic. Re-operate after the restrictions have been cancelled.

Error message	Description
Invalid recipient	The phone number or contact entered in SMS recipient is invalid. The phone number unavailable to use as a recipient or a contact has not been registered in Contacts is entered. Enter the correct phone number or contact.
Cannot enter more characters.	You cannot add more than one recipient in SMS. Only enter one recipient to send messages.
Cannot enter more letters.	The message is over the character number limit. Unavailable to input anymore. Keep it within the limit number.
Cannot send message	Cannot send SMS due to network problem. Confirm network first.

Error message	Description
Login information incorrect. Try again	When setting up Email account, an incorrect Email address or password has been input. Input the correct Email address or password.
Network unavailable	When setting up Email account, it cannot access to the server due to the abnormality of the network. Confirm the network state.

## Warranty and After-Sales Service

### Warranty

- Be sure to receive a warranty at the time of purchase of this cell phone. Read contents of the warranty and confirm information such as "販売店名・お買い上げ日" (shop name and date of purchase) and keep it in a safe place. If necessary items are not described, immediately contact the shop of purchase. The warranty for free repair is valid for one year from the date of purchase.
  - \* TV Antenna Cable LO1, Disney Original Cover LO1, and SIM eject tool (sample) are excluded in the free repair warranty.
  - \* The SIM eject tool is a sample. Refer to the inquiries about sample.
- The specifications and appearance of this cell phone, including the accessories in this package are subject to change for better without notice.

- Data saved in Phonebook, etc. may be modified or lost due to the malfunction, repair or other handling of this cell phone. You should therefore make a copy of the Phonebook data, etc. as a precautionary measure.
  - \* Phonebook data can be saved on microSD card in this cell phone.
  - \* Data such as phonebook entries can be backed up using mobile operator cloud.

### After-Sales Service

#### When this cell phone breaks down

Before repair, read "Troubleshooting" in this manual for detailed information. If the problem still persists, contact "Technical Inquiries & Repairs" (in Japanese only) on the back cover of this manual.

#### When this cell phone needs repairs

Bring your cell phone to a repair counter specified by mobile operator. Repairs are accepted during business hours of a repair counter. Also, you must bring the warranty. Note that it may take some days to repair this cell phone depending on the malfunction state.

### ■ During the warranty period

- This cell phone is repaired at no charge under the conditions of the warranty.
- Make sure to bring the warranty for repair. You will be charged even during the warranty period if the warranty is not presented or the trouble or damage is caused by your inappropriate handling (such as damage to external connection terminals, display, etc.), or when it is not repaired by a repair counter specified by mobile operator.
- You will be charged even during the warranty period if malfunction is caused by the use of devices and consumables other than those specified by mobile operator.

### ■ Repair may not be possible in the following cases

- When, as the result of inspection, corrosion is found due to exposure to water, condensation or sweat, or any of the internal boards are damaged or deformed (damage to the external connection terminals, display, or cracked body could be the case as well).
- When it is not repaired by a repair counter specified by mobile operator.
  - \* Since these conditions are outside the scope of the warranty, any repairs, if at all possible, will be charged.

### ■ After expiration of the warranty

All repairs that are requested are charged.

### ■ Replacement parts

Replacement parts (parts required to maintain functions) will in principle be kept in stock for 4 years after termination of production. However, depending on the malfunctioning part, repair may not be possible due to a lack of replacement parts. Even after the stock period has expired, the repair of some malfunctioning parts may be possible. Therefore contact "Technical Inquiries & Repairs" (in Japanese only) on the back cover of this manual.

## Precautions

- Never modify this cell phone or accessories.
  - Doing so may result in fire, injuries or malfunctions.
  - The modified cell phone may be repaired only if the owner agrees on that all the modified parts are restored to the original conditions. However, repairs may be refused depending on the modifications.  
The following cases may be considered as modifications.
    - Put sticker on display or key
    - Decorate this cell phone by adhesive agent
    - Exchange to parts such as cover other than those specified by mobile operator
  - Malfunction and damage due to modifications will be repaired at the owner's expense even during the warranty period.
- Note that the settings and other information may be cleared (reset) as a result of malfunction, repair or other handling. In this case, make the settings again.
- When the repair is executed, MAC address of Wi-Fi®/Bluetooth® address in this cell phone may be changed regardless of repaired part.

- Magnetic components are used in the parts that are described below. Do not allow cash cards or other devices that are vulnerable to magnetism to come into contact with the phone.

Place: speaker, mouthpiece (receiver)/sub microphone, vibrator (volume key area)

- Although this cell phone is waterproofed, if the inside of this cell phone has gotten wet or moist, immediately power off this cell phone, and bring it to the repair counter as soon as possible. However, note that it may not be repaired depending on the extent of the damage.

## Data you created and downloaded data

**When you change the model or repair this cell phone, data that has been imported, downloaded or created by you may be changed or lost. Mobile operator shall have no liability for any change or loss of any kind. Under some circumstances, mobile operator may replace your cell phone with its equivalent instead of repairing it. In this case, most data from the old cell phone cannot be transferred to the replacement cell phone.**

## Software Update

### About Software Update

The software update is a function which you can connect to the network and confirm if an update is required. It downloads the update file as required and installs it.

When the update is necessary, follow the instructions from  (software update) on the status bar, or visit mobile operator Website. The following contents are included in the software update. In order to use this cell phone safely and comfortably, please make sure to update to the latest version.

- Function improvement, new functions
- Easier to operate
- Quality improvement
- New security patch

#### Note

- The update can be run with the data saved in this cell phone. However, the data may not be protected depending on your cell phone conditions (malfunction, damage, getting wet, etc.). It is recommended to back up necessary data beforehand. Please note that some data cannot be backed up.

### Precautions

- Once updating your cell phone, you cannot downgrade to any former software.
- When updating, the original information about this cell phone (type, built number, etc.) will be sent to our server automatically. We do not use the sent information for purposes other than Android upgrade.
- When the packet communication is used via Xi, communication fee does not occur while downloading.
- To update via packet communication, a contracted nano UIM card is necessary. Also depending on the update contents, when packet communication is used, subscription to sp-mode is required.
- During the installation, you cannot make a phone call, receive an incoming call, use communication functions or other functions.
- All key operations are disabled during the update. The update cannot be stopped either.
- After finishing the update, it will be restarted.
- Part of the settings may be initialized after the update, set them up again.
- If a PIN has been set, the PIN entry screen appears during the restart after rewriting and you are required to enter your PIN.

- Consult a repair counter specified by mobile operator when update fails and all operations are disabled.
- SMS sent during a software update are stored at an SMS center.
- It may take time to update.
- The following situations make it unavailable to update.
  - When you are on a call
  - When out of the service area is displayed
  - When it is tethering as a main device
  - When the date or time has not been set correctly
  - Remained battery is not enough
  - Free space in this memory is not enough
  - When the basic software is being changed to an unauthorized one
- Exit all applications before updating.
- Make sure to upgrade with battery fully remained.
- Do not power off or remove the internal battery during update.
- It is recommended that this cell phone be put in a place with good reception and not be moved while downloading. The update may stop when it is put in a place with bad reception.
- When it does not need to update, "No upgrade is needed. Use it as it is." is displayed.

## Updating Software

- When this cell phone needs to update, you are required to perform the installation. Drag or swipe the status bar downward to open the notification panel ► Tap a notification ► "Install".
- When changing the auto download settings, from the Home screen, tap "Apps" ► "Settings" ► "About phone" ► "Update Center" ► "Software Update" ► "ON" / "OFF" in "Auto download".
- When "Auto download" is "OFF", operate "When the icon is not displayed on status bar" (P239).



## When the icon is not displayed on status bar

Follow the procedures below to update.

### 1 From the Home screen, tap "Apps"

- ▶ "Settings" ▶ "About phone"
- ▶ "Update Center" ▶ "Software Update" ▶ "Start Update"

- When there is a update file, the update starts.

### 2 When the message to start the installation appears, tap "OK" / "Install"

- The installation starts.
- Depending on the update contents, a confirmation screen about the update appears after tapping "Start Update".
- After the confirmation screen appears, follow the step ① and ②.

#### ① Select an update method.

- "Perform now (only via Wi-Fi)": Download the update file immediately via Wi-Fi®.
- "Perform at scheduled time (via Wi-Fi/Xi)": Download the update file at the reserved time automatically via Wi-Fi® or Xi.

- \* When it cannot be downloaded via Xi, "Perform at scheduled time(only via Wi-Fi)" appears. When the sp mode is not set, the update cannot be performed by tapping "Perform at scheduled time(only via Wi-Fi)". Update via Wi-Fi®.



#### ② Select "Download and install" or "Download".

- "Download and install": After the download is finished, the installation is implemented automatically. If you do not tap "OK", the installation starts 10 seconds after.
- "Download": Even after the update file has been downloaded, the installation is not implemented automatically. To install, you need to implement the installation yourself.

## Note

- When the software in this cell phone is the latest one, "No upgrade is needed. Use it as it is." appears.
- If the download is discontinued, the downloaded data till then will be stored for up to 14 days. To continue to download, tap  (Downloading update file stopped) on the notification panel.
- When "Perform at scheduled time" is selected, the download time is set up automatically. The start time cannot be changed. When you do not want to download at the time automatically set, tap "Software Update" ► "Back" and select "Perform now(only via Wi-Fi)" to download the update file.

## Application Update

- **After the update, check if there are any application updates. If the applications are not updated, the performance will not be stable, or the functions are improper. Please make sure to update to the latest version.**
  - Update from the notification icon  
After the update is finished, restart this cell phone and the notification icon  (Updating has been completed) will appear. Drag or swipe the status bar downward to open the notification panel ► "Updating has been completed" ► Operate according to the on-screen instructions to update the applications from the update list.
  - Update from Play Store  
From the Home screen, tap "Play Store" ►  ► "My apps" to update each application.
- **About OS version information of each application, confirm where the application is provided.**

## App Updates

Configures settings for download of applications, update notification cycles, and automatic updates provided by LG Electronics Inc. Application can be updated via LTE/3G connections or via Wi-Fi® connections.

- For precautions on application update, refer to "Precautions" (P237) of software update.
- For the latest software information, refer to LG Electronics website.  
<http://www.lg.com/jp/support/software-manuals> (In Japanese only)

## Downloads

- 1 From the Home screen, tap "Apps" ► "Settings" ► "About phone" ► "Update Center" ► "App Updates"
  - When "Legal Documents for App update" screen is displayed, "NEXT" ► Confirm "Terms of Use for LG apps" and "Privacy Policy", then place a check mark ► Tap "NEXT".
- 2 "Download"

## Setting Updates

- 1 From the Home screen, tap "Apps" ► "Settings" ► "About phone" ► "Update Center" ► "App Updates"
- 2 Tap  ► "Settings"
- 3 Change the settings if necessary

Update notification cycle	Set to automatically check whether there are updatable apps, and set the notification cycles.
Auto-update apps	Set to automatically update upgradeable apps or not.
Legal Documents for App update	Amend the acceptance status of "Privacy Policy".

## Main Specifications

### Cell phone

Model name	KX1801
Size (H×W×D)	Approx. 148 mm × Approx. 74 mm × 7.9 mm (Max. thickness: Approx. 8.3 mm)
Weight	Approx. 137 g
Memory	ROM 16 GB <sup>*1</sup> RAM 2 GB

Continuous standby time	LTE	Stationary (Automatic): Approx. 360 hours
	3G	Stationary (Automatic): Approx. 380 hours
	GSM	Stationary (Automatic): Approx. 310 hours
Continuous call time	VoLTE voice call	Approx. 940 min.
	3G	Approx. 810 min.
	GSM	Approx. 780 min.
Charging time	AC Adapter 05 (optional)	Approx. 110 min.
	DC Adapter 04 (optional)	Approx. 140 min.

1 Seg	Watch time	Approx. 490 min.
	Record time <sup>*2</sup>	Approx. 381 min.
Display	Type	TFT (Full HD IPS)
	The number of produced colors	16,777,216 colors
	Size	Approx. 5.2 inch
	Resolution	Side 1080 pixels × Line 1920 pixels (Full HD)
Image pickup device	Type	CMOS with flash on the back side
	Size	Main camera: 1/3.1 inch Front camera: 1/4.0 inch

Effective pixels	Main camera: Approx. 16.1 million pixels Front camera: Approx. 8.0 million pixels
Recorded pixels (maximum)	Main camera: Approx. 15.9 million pixels Front camera: Approx. 8.0 million pixels
Zoom (Digital)	Up to approx. 4.0x (30 levels) (main camera only)
Wireless LAN	IEEE802.11 a/b/g/n/ac standard (IEEE802.11n frequency band: 2.4 GHz/5 GHz)

Bluetooth®	Compatible version* <sup>3</sup>	Bluetooth® standard Ver.4.2
	Output	Bluetooth® standard Power Class 2
	Line-of -sight communication distance* <sup>4</sup>	Within approx. 10 meters
	Compatible file* <sup>5</sup>	HFP, HSP, OPP, SPP, HID, A2DP (aptX/SBC), AVRCP, PBAP, PAN (PAN-NAP), PAN (PANU), HDP, ANP, FMP, PXP, TIP, HOGP, ScPP
Earphone/ microphone jack	Terminal diameter	3.5 φ
	Pole number	4 poles

- \*1 Since saving Android OS and preinstalled applications requires memory space, the amount does not indicate actual available memory space.
  - \*2 The maximum recording time per video can be recorded to the internal storage.
  - \*3 We confirm that all Bluetooth® compatible devices including this cell phone are compliant with standards designated by Bluetooth® SIG and are certified. However, procedures may vary and data transfer may not be possible, depending on the characteristics and specifications of the device that you connect to.
  - \*4 This varies depending on the obstacles between the communicating devices and the reception quality.
  - \*5 These are Bluetooth® standards that provide specifications for communications between Bluetooth® compatible device.
- Continuous call time is an estimate of the battery life during a continuous call with normal signal reception.

- Continuous standby time is an estimate of the battery life during a continuous standby with normal signal reception. In certain circumstances, the standby time may drop to as low as half the time shown due to the battery charge, function settings, temperature, or radio wave reception in the area (no reception or weak).
- A use of the Internet reduces the actual call (communication)/standby time. Even if you do not perform communication or use the Internet, composing emails, activating application, using camera also reduces call (communication)/standby time.
- Stationary continuous standby time is the average battery life when you are stationary with normal signal reception.
- Charging time is an estimate for charging an empty internal battery with the cell phone power off. For charging with the cell phone power on, it takes longer.

### Internal battery

<b>Battery type</b>	Lithium-ion battery
<b>Nominal voltage</b>	3.85 V
<b>Nominal capacity</b>	2,900 mAh

### TV Antenna Cable LO1

<b>Length</b>	Approx. 140 mm
<b>Weight</b>	Approx. 8 g

### Disney Original Cover LO1

<b>Size</b>	<b>Flip section</b>	Vertical: Approx. 144 mm Horizontal: Approx. 72 mm
	<b>Back cover section</b>	Vertical: Approx. 150mm Horizontal: Approx. 76mm
<b>Weight</b>		Approx. 39g

### SIM eject tool (sample)

<b>External dimensions</b>	Vertical: Approx. 15 mm Horizontal: Approx. 22.65 mm Thickness: Approx. 0.92 mm
<b>Weight</b>	Approx. 0.65 g

### Languages compatible

#### ■ Display languages

Japanese/English/German/Spanish/French/  
Arabic/Portuguese/Russian/Chinese/Korean

#### ■ Input languages (enter a character)

Japanese/English/Korean

### File format

This cell phone supports the display or playback of the following file formats.

Type	File formats
<b>Audio</b>	mp3, mp2, wav, amr, wma, aac, mid, ogg, flac
<b>Image</b>	jpeg, png, bmp, wbmp, gif, webp, jps, mpo

<b>Video</b>	mp4, m4a, m4v, mpg, 3gp, wmv, avi, mkv, flv, asf
--------------	--

Photos and videos are saved in the following file formats.

Type	File formats
<b>Photo</b>	JPEG
<b>Video</b>	MP4

### Video recording time (estimate)

Resolution	Main unit*
<b>1920×1080 (Full HD)</b>	Max. approx. 34 minutes (per video)

\* Estimate recording time at the time of purchase.

\* The file size is restricted to 4 GB. File size restriction is an auto support function without being set by a customer.



## Radio Frequency (RF) Signals

THIS MODEL PHONE MEETS THE U.S. GOVERNMENT'S REQUIREMENTS FOR EXPOSURE TO RADIO WAVES.

Your wireless phone contains a radio transmitter and receiver.

Your phone is designed and manufactured not to exceed the emission limits for exposure to radio frequency (RF) energy set by the Federal Communications Commission of the U.S. Government. These limits are part of comprehensive guidelines and establish permitted levels of RF energy for the general population. The guidelines are based on standards that were developed by independent scientific organizations through periodic and thorough evaluation of scientific studies. The exposure standard for wireless mobile phones employs a unit of measurement known as the Specific Absorption Rate (SAR). The SAR limit set by the FCC is 1.6 W/kg.\* Tests for SAR are conducted using standard operating positions accepted by the FCC with the phone transmitting at its highest certified power level in all tested frequency bands. Although the SAR is determined at the highest certified power level, the actual SAR level of

the phone while operating can be well below the maximum value. This is because the phone is designed to operate at multiple power levels so as to use only the power required to reach the network. In general, the closer you are to a wireless base station antenna, the lower the output.

Before a phone model is available for sale to the public, it must be tested and certified to the FCC that it does not exceed the limit established by the U.S. government-adopted requirement for safe exposure. The tests are performed on position and locations (for example, at the ear and worn on the body) as required by FCC for each model. The highest SAR value for this model phone as reported to the FCC when tested for use at the ear is 0.46 W/kg, and when worn on the body is 1.10 W/kg. (Body-worn measurements differ among phone models, depending upon available accessories and FCC requirements).

While there may be differences between the SAR levels of various phones and at various positions, they all meet the U.S. government requirement.

The FCC has granted an Equipment Authorization for this model phone with all reported SAR levels evaluated as in compliance with the FCC RF exposure guidelines. SAR information on this model phone is on file with the FCC and can be found under the Display Grant section at <http://transition.fcc.gov/oet/ea/fccid/> after search on FCC ID **ZNFKX1801**. For body worn operation, this phone has been tested and meets the FCC RF exposure guidelines. Please use an accessory designated for this product or an accessory which contains no metal and which positions the handset a minimum of 1.0 cm from the body.

---

- \* In the United States, the SAR limit for wireless mobile phones used by the public is 1.6 watts/kg (W/kg) averaged over one gram of tissue. SAR values may vary depending upon national reporting requirements and the network band.

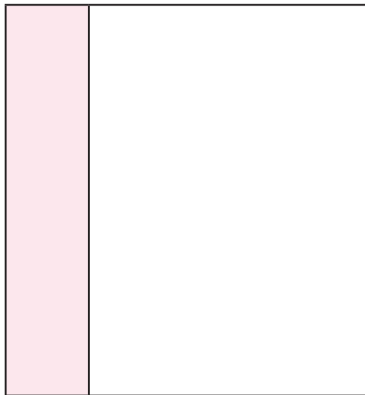

## Regulatory information (FCC ID number, etc.)

For regulatory details, operate from the Home screen. ☰ ▶ "Settings" ▶ "System" ▶ "Regulatory labels" on your phone.

## FCC Statement for the USA

### Part 15.21 statement

Change or Modifications that are not expressly approved by the manufacturer could void the user's authority to operate the equipment.

### Part 15.19 statement

This device complies with part 15 of FCC rules. Operation is subject to the following two conditions:

- (1) This device may not cause harmful interference.
- (2) This device must accept any interference received, including interference that may cause undesired operation.

### Part 15.105 statement

This equipment has been tested and found to comply with the limits for a class B digital device, pursuant to Part 15 of the FCC Rules. These limits are designed to provide reasonable protection against harmful interference in a residential installation.

This equipment generates, uses and can radiate radio frequency energy and, if not installed and used in accordance with the instructions, may cause harmful interference to radio communications. However, there is no guarantee that interference will not occur in a particular installation. If this equipment does cause harmful interference or television reception, which can be determined by turning the equipment off and on, the user is encouraged to try to correct the interference by one or more of the following measures:

- Reorient or relocate the receiving antenna.
- Increase the separation between the equipment and receiver.
- Connect the equipment into an outlet on a circuit different from that to which the receiver is connected.
- Consult the dealer or an experienced radio/TV technician for help.

## Important Safety Information

### AIRCRAFT

Switch off your wireless device when boarding an aircraft or whenever you are instructed to do so by airline staff. Consult airline staff about the use of Airplane Mode in flight.

### DRIVING

Full attention should be given to driving at all times and local laws and regulations restricting the use of wireless devices while driving must be observed.

### HOSPITALS

Mobile phones should be switched off wherever you are requested to do so in hospitals, clinics or health care facilities. These requests are designed to prevent possible interference with sensitive medical equipment.

## PETROL STATIONS

Obey all posted signs with respect to the use of wireless devices or other radio equipment in locations with flammable material and chemicals. Switch off your wireless device whenever you are instructed to do so by authorized staff.

## INTERFERENCE

Care must be taken when using the phone in close proximity to personal medical devices, such as pacemakers and hearing aids.

### Pacemakers

Pacemaker manufacturers recommend that a minimum separation of 15cm be maintained between a mobile phone and a pacemaker to avoid potential interference with the pacemaker. To achieve this use the phone on the opposite ear to your pacemaker and do not carry it in a breast pocket.

## Hearing Aids

Some digital wireless phones may interfere with some hearing aids. In the event of such interference, you may want to consult your hearing aid manufacturer to discuss alternatives.

**NOTE :** Excessive sound pressure from earphones and headphones can cause hearing loss.



To prevent possible hearing damage, do not listen at high volume levels for long periods.

### For other Medical Devices:

Please consult your physician and the device manufacturer to determine if operation of your phone may interfere with the operation of your medical device.

## CAUTION

RISK OF EXPLOSION IF BATTERY IS REPLACED BY AN INCORRECT TYPE.  
DISPOSE OF USED BATTERIES ACCORDING TO THE INSTRUCTIONS.

## Export Administration Regulations

Japan Export Control Regulations ("Foreign Exchange and Foreign Trade Law" and relevant laws and regulations) may apply to this product and its accessories. U.S. Re-export Regulations (Export Administration Regulations) applies to this product and its accessories. If you export or re-export this product or its accessories, please follow the necessary procedures at your own risk and expense. For details on the procedures, contact the Ministry of Economy, Trade and Industry or the U.S. Department of Commerce.

## Intellectual Property Right

### Copyrights and Portrait Rights

You have no right to copy, modify, or distribute contents such as text, images, music, map data, or software downloaded from websites on the Internet, or photos shot by the camera of this product without permission from the copyright holder except when the copy or quote is for personal use that is allowed under Copyright Law. Note that it may be prohibited to shoot or record live performances or exhibitions even for personal use.

Refrain from taking portraits of other people and uploading such portraits to websites using this product without their consent, as this violates portrait rights.

## Trademarks

- "Catch Phone (Call waiting service)" is a registered trademark of Nippon Telegraph and Telephone Corporation.
- The microSD Logo, microSDHC Logo, and microSDXC Logos are the trademarks of SD-3C, LLC.



- The Bluetooth® word mark and logos are owned by the Bluetooth SIG, INC. and any use of such marks by mobile operator, INC. is under license. Other trademarks and trade names are those of their respective owners.



- Wi-Fi Certified® and logos are trademarks or registered trademarks of Wi-Fi Alliance.



- Microsoft®, Windows®, Windows Vista®, and Windows Media® are trademarks or registered trademarks of Microsoft Corporation in the United States and/or other countries.
- Google and Google logo, Android, Google Play and Google Play logo, Google Map, Google Calendar, Google+ and Google+ logo, Gmail and Gmail logo, YouTube and YouTube logo are trademarks or registered trademarks of Google, Inc.
-  is a registered trademark of FeliCa Networks, Inc.
- FeliCa is a contactless IC card technology developed by Sony Corporation. FeliCa is a registered trademark of Sony Corporation.
- iWnn of OMRON SOFTWARE Co., Ltd. is used for conversion methods for Japanese language.  
iWnn © OMRON SOFTWARE Co., Ltd. 2008-2016 All Rights Reserved.

- Disney elements: © Disney  
The cell phone, accessories and the packages may contain designs, contents and other works that Walt Disney Company (Japan) Ltd., its parent or their affiliates (collectively, "Disney") own, co-own or license copyright and other intellectual property rights. Please read the applicable Terms of Use before use. Disney Mobile is the registered trademark of Disney.
- Other company names or product names described in this manual are trademarks or registered trademarks of those companies.

## Others

- The abbreviations of operating systems (Japanese versions) below are used in this manual.
  - Windows 10 stands for Microsoft® Windows® 10 (Home, Pro, Enterprise, Education).
  - Windows 8.1 stands for Microsoft® Windows® 8.1 Pro, Microsoft® Windows® 8.1 Enterprise.
  - Windows 7 stands for Microsoft® Windows® 7 (Starter, Home Basic, Home Premium, Professional, Enterprise, Ultimate).
  - Windows Vista stands for Windows Vista® (Home Basic, Home Premium, Business, Enterprise, Ultimate).
- This product is licensed complying with the MPEG-4 Patent Portfolio License. If you use it for private purpose without any profits, you are allowed to use them only when:
  - Recording videos that are compliant with the standard of MPEG-4 Visual (hereinafter referred to as MPEG-4 Video)
  - Playing MPEG-4 Videos recorded personally by consumers not engaged in profit activities
  - Playing MPEG-4 Video supplied from the



provider licensed from MPEG-LA  
For details, contact MPEG LA, LLC of the U.S.

-  T-1650068  
The Walt Disney Company (Japan) Ltd.

## Open Source Software Notice Information

To obtain the source code under GPL, LGPL, MPL and other open source licenses, that is contained in this product, please visit <http://opensource.lge.com>

In addition to the source code, all referred license terms, warranty disclaimers and copyright notices are available for download. LG Electronics will also provide open source code to you on CD-ROM for a charge covering the cost of performing such distribution such as the cost of media, shipping, and handling upon email ([opensource@lge.com](mailto:opensource@lge.com)) request. This offer is valid for three years from the date on which you purchased the product.

## Unlocking SIM

Unlocking SIM is available on this cell phone. Unlocking SIM enables a SIM card from other makers to be used.

- The service and function may be limited. Mobile operator shall not be liable for performance.
- For details on unlocking SIM lock, refer to mobile operator Website.

- 1** Install a SIM card of other manufacturers
- 2** Press the power key for 2 seconds or longer
  - "Network locked" appears on the lock screen.
- 3** When the screen is locked, set a method to unlock it
- 4** Input SIM unlock code in "SIM network unlock PIN" field ►  
"UNLOCK"
  - After "SIM Network unlock successful." appears, the Home screen will be displayed in a while.
  - After the SIM is unlocked, a SIM of other manufacturers can be used.

# Index

## Number

1 Seg ..... 129

## A

About phone ..... 193  
Accessibility ..... 190  
Access Point ..... 168  
    Checking ..... 168  
    Initializing ..... 169  
    Setting an additional ..... 169  
Accounts ..... 186  
    Removing ..... 186  
    Setting ..... 186  
Application Update ..... 241  
Apps Screen ..... 75  
    Adding an application to Home screen ..... 82  
    Apps List ..... 75  
    Uninstalling ..... 82  
    Viewing the Application Screen ..... 75  
Auto Rotating Screen ..... 54

## B

Backlight ..... 49  
Backup & reset ..... 187  
Battery  
    Life ..... 46  
Battery & power saving ..... 176  
Before Using this Terminal ..... 5  
Bluetooth® ..... 200  
Bluetooth® tethering ..... 166  
Bookmark ..... 119  
Browser ..... 117  
    Opening ..... 117  
    Opening incognito tab ..... 118  
    Using Bookmark and History ..... 119  
    Using Browser Menu ..... 118

## C

Calculator ..... 154  
Calendar ..... 151  
    Changing Calendar Settings ..... 152  
    Changing/Deleting a Schedule ..... 152  
    Creating a Schedule ..... 152  
    Opening ..... 151  
Call ..... 89

For Video Calls .....	90
For Voice Calls .....	89
Incoming Call While Activating an Application .....	90
Calling .....	84
Answering Memo .....	95
Calling/Sending an SMS to a Missed Call .....	91
Call Logs .....	94
Emergency Call .....	87
Entering a Pause .....	86
Making a Call .....	84
Making an International Call .....	88
Operations during a Call .....	91
Phonebook .....	100
Receiving a Call .....	89
Call Logs .....	94
Call Settings .....	96
Camera .....	139
Copyrights and portrait rights .....	139
Notes for capturing images .....	140
Shooting a Photo .....	142
Shooting a Video .....	143
Viewing Shooting Screen .....	141
Capture+ .....	70
Character Entry .....	57
Charging .....	45
Battery Charge .....	45
Charging Time (estimate) .....	46

Charging with AC Adapter .....	47
Charging with a PC .....	48
Usage Time (estimate) .....	46
Chrome .....	117
Clock .....	149
Setting Alarm .....	149
Setting Stopwatch .....	150
Setting Timer .....	149
Setting World Clock .....	150
Connecting with a PC .....	206
Connecting with Printer .....	208
Contacts .....	101
Copyrights and Portrait Rights .....	252
Customizing icons .....	71

## D

Data roaming .....	213
Date & time .....	189
Declaration of Conformity .....	250
DEVICE .....	170
Disney Market .....	120
Display .....	40, 172

## E

Early Warning "Area Mail" .....	115
Deleting .....	116
Receiving .....	115

Setting .....	116
Viewing .....	115
Email .....	109
Adding an Account .....	110
Changing Email Settings .....	111
Creating and Sending Email .....	110
Displaying Received Email .....	109
Setting Email Account .....	109
Emergency Call .....	87
Emergency Mode .....	56
Error Message .....	232
Export Administration Regulations .....	252
External Device Connection .....	206
Connecting with a PC .....	206
Connecting with Other Devices .....	209
Connecting with Printer .....	208

## F

FAQ .....	221
FCC Statement for the USA .....	249
File format .....	246
File Management .....	195
File or Folder Operations .....	198

## G

Gallery .....	144
Gmail .....	114

Google Play .....	121
GPS .....	145

## H

Home Screen .....	72, 173
Adding an application or widget .....	73
Adding Home screen .....	73
Changing wallpaper .....	74
Deleting from the Home screen of an application or widget .....	74
Moving an application or widget .....	74
Viewing Home Screen .....	72
Home Touch Buttons .....	53
How to Use this Manual .....	1

## I

Illumination .....	171
Important Safety Information .....	250
Initializing this terminal .....	188
Initial Settings .....	64
Intellectual Property Right .....	252
International Roaming (WORLD WING) .....	211

## L

Language & keyboard .....	187
Location .....	180

Lock screen .....	173
-------------------	-----

## M

Mail .....	105
Main Specifications .....	242
Making an International Call .....	88
Calling a fixed-line telephone .....	88
Calling a mobile phone .....	88
Maps .....	148
Opening .....	148
Material List .....	22
Messaging .....	106
microSD card .....	196
Formatting .....	198
Inserting .....	196
Mobile Data .....	162

## N

nano UIM card .....	42
Inserting .....	43
Removing .....	44
Network mode .....	214
Network security code .....	184
NFC Communication .....	204
NFC/Osaifu-Keitai .....	166
Notification icons .....	67
Notification LED Light .....	65

Notification Panel .....	69
Closing .....	71
Customizing quick setting icons .....	71
Sorting quick setting icons .....	71
Viewing notification details .....	70

## O

Operations during a Call .....	91
For Video Calls .....	92
For Voice Calls .....	91
Osaifu-Keitai .....	124

## P

Part Names and Functions .....	40
Pass code (PIN) .....	201
Pause .....	86
PERSONAL .....	180
Phonebook .....	100
Adding/Editing a Group .....	103
Changing Displayed Account on Phonebook .....	102
Confirming/Using Contacts .....	101
Deleting .....	103
Importing/Exporting Contacts .....	104
Registering .....	100
Registering My Profile .....	104
PIN code .....	184

Changing	185
Entering	185
Setting	185
PIN Lock	185
PIN unblocking key (PUK)	185
Play Store	121
Installing an Application	121
Purchasing an application	122
Uninstalling an Application	123
Power Off	48
Power On	48
Public mode (power OFF) settings	98

## Q

QMemo+	153
QSlide Apps	55

## R

Radio Frequency (RF) Signals	247
------------------------------	-----

## S

Safe mode	224
Screen Display/Icons	66
Screen Shot	54
Security	180
Security code	183

Setting application authentication	56
Settings	155
Settings Menu	155
Shortcut Key	189
SmartShare Beam	209
Receiving files	210
Sending files	209
Setting	209
SMS	106
Receiving/Viewing	106
Sending	106
Software Keyboard	57
10key keyboard	58
Arrow key	60
Changing Character Entry Settings	62
Handwriting converting keyboard	61
QWERTY keyboard	58
Software Update	237
Sound & notification	170
Specific Absorption Rate (SAR) of Mobile Phones	247
Status Bar	66
Status icons	66
Storage & USB	176
Supplied Accessories	2
Switching Home Application	83
SYSTEM	189

## T

Task Manager .....	83
Tethering.....	164
ToruCa .....	128
Touch Screen .....	51
Operations .....	52
Precautions on using .....	51
Trademarks .....	253
Troubleshooting .....	221
TV (1Seg) .....	129
How to use the watching screen.....	131
Reserving Recording/Watching .....	136
Settings .....	138
Switching Viewing Area .....	138
Using Program Schedule.....	134
Using TV Link .....	137
Viewing the data broadcast screen .....	134
Watching.....	131
Watching Recorded Programs .....	135

## U

Unlocking SIM .....	256
USB tethering .....	164
Using Overseas .....	211
After Returning to Japan.....	220
Available Service.....	212
Confirming before Departure .....	212

Confirming Overseas .....	213
International Roaming (WORLD WING) ...	211
Making a Call Domestically.....	215
Making a Call from Other Parties.....	217
Making a Call to WORLD WING Users ...	216
Making Calls to Other Countries (including Japan) .....	215
Pre-configuring.....	213
Receiving Calls Overseas .....	216
Setting a network operator.....	213
Setting data roaming .....	213
Setting International Roaming .....	217
Setting network mode .....	214

## V

VPN .....	167
Adding .....	167
Always use.....	168
Connecting to .....	168
Deleting .....	168
Editing .....	168

## W

Wallpaper .....	74
Waterproofness/Dustproofness .....	33
Before Using .....	34
Charging .....	39



Draining Water .....	37
Precautions .....	36
What You can Do with Waterproofness ...	34
Wi-Fi®.....	156
Adding .....	158
Connecting to .....	157
Disconnecting .....	158
Setting advanced .....	161
Wi-Fi Direct® .....	160
Wi-Fi® Miracast supported device .....	210
Wi-Fi® tethering .....	165
Windows Media Player .....	206
Wireless LAN.....	156
WIRELESS NETWORKS .....	155
WORLD CALL .....	88

## Using mobile phones with your manners!

Please be considerate of others around you when using this cell phone.

### Always turn OFF your cell phone in the following situations

■ **In a place where the use of mobile phones is prohibited**

Inside airplane or hospital, follow instructions of the airline company or medical facility. Power off this cell phone in places banning the use of it.

### Set your cell phone to Public mode in the following situations

■ **When driving**

Using this cell phone in your hand while driving is subject to punishment.

However, this excludes situations when the use of a mobile phone is unavoidable, such as the rescue of the sick and injured or the maintenance of public safety.

■ **When you are in a public place such as a theater, movie theater, or museum**

Using this cell phone in a public place, where you need to be quiet, annoys people around you.

### Be considerate of where you use your cell phone and keep your voice and ringtone down

■ **Keep your voice down when using this cell phone in a quiet place such as a restaurant and hotel lobby.**

■ **If you are in an outdoor public place, make sure you do not disturb others.**

### Respect privacy

■ **Please be considerate of the privacy of individuals around you when shooting and sending photos using camera-equipped mobile phones.**

### Do not use smartphone while walking

■ **Use of smartphone while walking on station platform or road makes your eyesight extremely narrow. It may cause accident.**

■ **Stop in a safe place and then use smartphone.**

## Functions for maintaining good manners in public places

This cell phone is equipped with functions that allow you not to answer an incoming call or to mute the sound.

### ■ Manner Mode (Vibrate only, Do not disturb) → P170

Manner mode mutes this cell phone's sounds, such as operation sounds and the ringtone.

\* However, shutter sound is not available to set to mute.

### ■ Public mode (power OFF) → P98

A message plays notifying callers that you are where you have to power off the phone and cannot answer, and the phone automatically hangs up.

### ■ Vibrate → P170

Notifies incoming calls by vibration.

You can also use optional services such as the Voice mail service (P96) and the Call forwarding service (P96).



モバイルリサイクルネットワーク  
携帯電話 PHSのリサイクルに関する

We collect mobile phones and related equipment that you no longer need even if it is not a mobile operator product. Please bring them to your local Shop.

\* Acceptable Products: Mobile phones, PHS terminals, battery packs, battery chargers, and desktop holders (regardless of the provider)