

Impedance & Return-Loss Measurement Plot for Head TSL

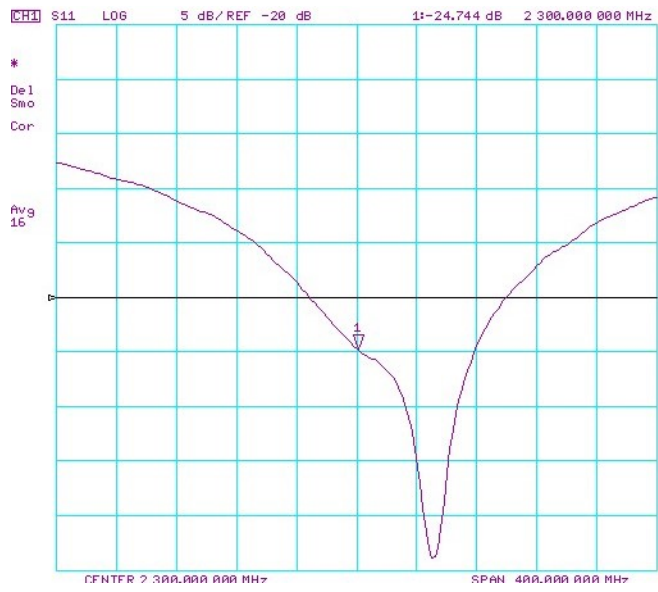

Impedance & Return-Loss Measurement Plot for Body TSL

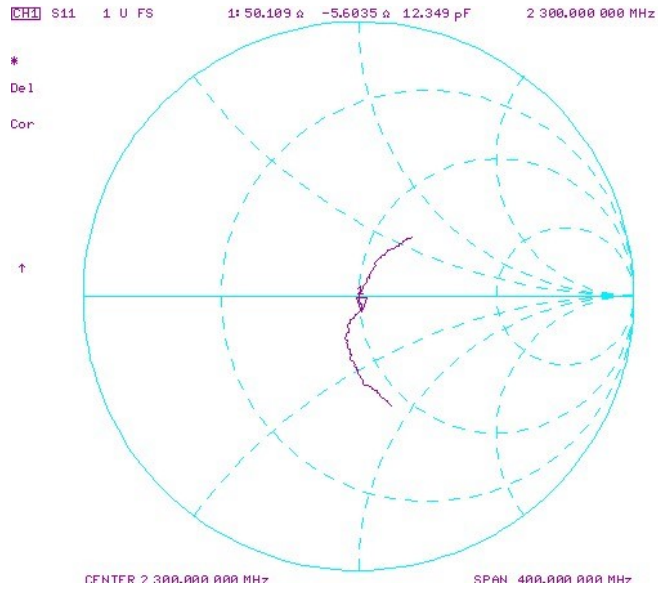

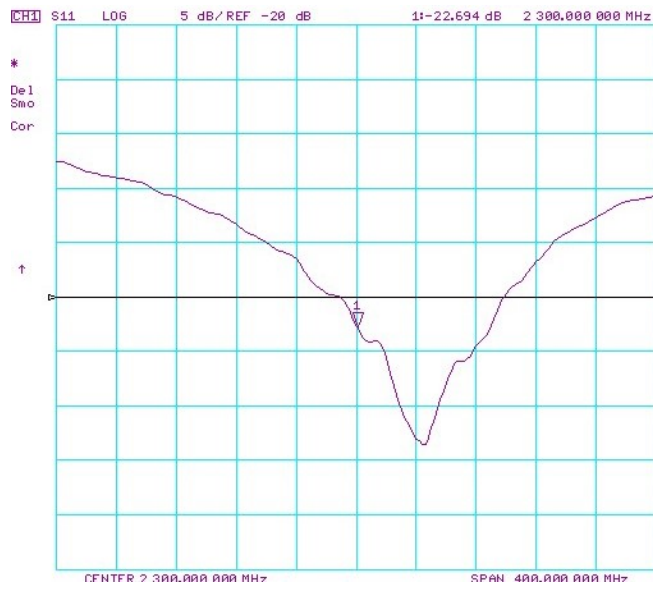
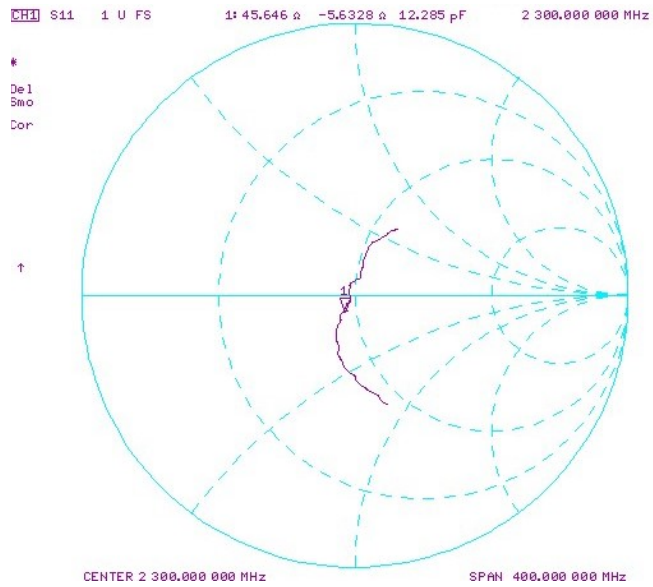

Accredited by the Swiss Accreditation Service (SAS)
The Swiss Accreditation Service is one of the signatories to the EA
Multilateral Agreement for the recognition of calibration certificates

Accreditation No.: **SCS 0108**

Client **PC Test**

Certificate No: **D2450V2-981_Aug18**

CALIBRATION CERTIFICATE

Object **D2450V2 - SN:981**

Calibration procedure(s) **QA CAL-05.v10**
Calibration procedure for dipole validation kits above 700 MHz

Calibration date: **August 16, 2018**

BNV
09-26/2018

BNV
08/10/2019

This calibration certificate documents the traceability to national standards, which realize the physical units of measurements (SI).
The measurements and the uncertainties with confidence probability are given on the following pages and are part of the certificate. *BNV 08-20-20*

All calibrations have been conducted in the closed laboratory facility: environment temperature (22 ± 3)°C and humidity < 70%.

Calibration Equipment used (M&TE critical for calibration)

Primary Standards	ID #	Cal Date (Certificate No.)	Scheduled Calibration
Power meter NRP	SN: 104778	04-Apr-18 (No. 217-02672/02673)	Apr-19
Power sensor NRP-Z91	SN: 103244	04-Apr-18 (No. 217-02672)	Apr-19
Power sensor NRP-Z91	SN: 103245	04-Apr-18 (No. 217-02673)	Apr-19
Reference 20 dB Attenuator	SN: 5058 (20k)	04-Apr-18 (No. 217-02682)	Apr-19
Type-N mismatch combination	SN: 5047.2 / 06327	04-Apr-18 (No. 217-02683)	Apr-19
Reference Probe EX3DV4	SN: 7349	30-Dec-17 (No. EX3-7349_Dec17)	Dec-18
DAE4	SN: 601	26-Oct-17 (No. DAE4-601_Oct17)	Oct-18

Secondary Standards	ID #	Check Date (in house)	Scheduled Check
Power meter EPM-442A	SN: GB37480704	07-Oct-15 (in house check Oct-16)	In house check: Oct-18
Power sensor HP 8481A	SN: US37292783	07-Oct-15 (in house check Oct-16)	In house check: Oct-18
Power sensor HP 8481A	SN: MY41092317	07-Oct-15 (in house check Oct-16)	In house check: Oct-18
RF generator R&S SMT-06	SN: 100972	15-Jun-15 (in house check Oct-16)	In house check: Oct-18
Network Analyzer Agilent E8358A	SN: US41080477	31-Mar-14 (in house check Oct-17)	In house check: Oct-18

Calibrated by: **Leif Klysner** Name: **Leif Klysner** Function: **Laboratory Technician**

Signature

Approved by: **Katja Pokovic** Name: **Katja Pokovic** Function: **Technical Manager**

Issued: August 23, 2018

This calibration certificate shall not be reproduced except in full without written approval of the laboratory.



Accredited by the Swiss Accreditation Service (SAS)
The Swiss Accreditation Service is one of the signatories to the EA
Multilateral Agreement for the recognition of calibration certificates

Accreditation No.: **SCS 0108**

Glossary:

TSL	tissue simulating liquid
ConvF	sensitivity in TSL / NORM x,y,z
N/A	not applicable or not measured

Calibration is Performed According to the Following Standards:

- IEEE Std 1528-2013, "IEEE Recommended Practice for Determining the Peak Spatial-Averaged Specific Absorption Rate (SAR) in the Human Head from Wireless Communications Devices: Measurement Techniques", June 2013
- IEC 62209-1, "Measurement procedure for the assessment of Specific Absorption Rate (SAR) from hand-held and body-mounted devices used next to the ear (frequency range of 300 MHz to 6 GHz)", July 2016
- IEC 62209-2, "Procedure to determine the Specific Absorption Rate (SAR) for wireless communication devices used in close proximity to the human body (frequency range of 30 MHz to 6 GHz)", March 2010
- KDB 865664, "SAR Measurement Requirements for 100 MHz to 6 GHz"

Additional Documentation:

- DASY4/5 System Handbook

Methods Applied and Interpretation of Parameters:

- Measurement Conditions:** Further details are available from the Validation Report at the end of the certificate. All figures stated in the certificate are valid at the frequency indicated.
- Antenna Parameters with TSL:** The dipole is mounted with the spacer to position its feed point exactly below the center marking of the flat phantom section, with the arms oriented parallel to the body axis.
- Feed Point Impedance and Return Loss:** These parameters are measured with the dipole positioned under the liquid filled phantom. The impedance stated is transformed from the measurement at the SMA connector to the feed point. The Return Loss ensures low reflected power. No uncertainty required.
- Electrical Delay:** One-way delay between the SMA connector and the antenna feed point. No uncertainty required.
- SAR measured:** SAR measured at the stated antenna input power.
- SAR normalized:** SAR as measured, normalized to an input power of 1 W at the antenna connector.
- SAR for nominal TSL parameters:** The measured TSL parameters are used to calculate the nominal SAR result.

The reported uncertainty of measurement is stated as the standard uncertainty of measurement multiplied by the coverage factor $k=2$, which for a normal distribution corresponds to a coverage probability of approximately 95%.

Measurement Conditions

DASY system configuration, as far as not given on page 1.

DASY Version	DASY5	V52.10.1
Extrapolation	Advanced Extrapolation	
Phantom	Modular Flat Phantom	
Distance Dipole Center - TSL	10 mm	with Spacer
Zoom Scan Resolution	dx, dy, dz = 5.0 mm	
Frequency	2450 MHz \pm 1 MHz	

Head TSL parameters

The following parameters and calculations were applied.

	Temperature	Permittivity	Conductivity
Nominal Head TSL parameters	22.0 °C	39.2	1.80 mho/m
Measured Head TSL parameters	(22.0 \pm 0.2) °C	37.7 \pm 6 %	1.86 mho/m \pm 6 %
Head TSL temperature change during test	< 0.5 °C	----	----

SAR result with Head TSL

SAR averaged over 1 cm ³ (1 g) of Head TSL	Condition	
SAR measured	250 mW input power	13.4 W/kg
SAR for nominal Head TSL parameters	normalized to 1W	52.3 W/kg \pm 17.0 % (k=2)

SAR averaged over 10 cm ³ (10 g) of Head TSL	condition	
SAR measured	250 mW input power	6.20 W/kg
SAR for nominal Head TSL parameters	normalized to 1W	24.4 W/kg \pm 16.5 % (k=2)

Body TSL parameters

The following parameters and calculations were applied.

	Temperature	Permittivity	Conductivity
Nominal Body TSL parameters	22.0 °C	52.7	1.95 mho/m
Measured Body TSL parameters	(22.0 \pm 0.2) °C	51.8 \pm 6 %	2.02 mho/m \pm 6 %
Body TSL temperature change during test	< 0.5 °C	----	----

SAR result with Body TSL

SAR averaged over 1 cm ³ (1 g) of Body TSL	Condition	
SAR measured	250 mW input power	13.0 W/kg
SAR for nominal Body TSL parameters	normalized to 1W	50.9 W/kg \pm 17.0 % (k=2)

SAR averaged over 10 cm ³ (10 g) of Body TSL	condition	
SAR measured	250 mW input power	6.11 W/kg
SAR for nominal Body TSL parameters	normalized to 1W	24.2 W/kg \pm 16.5 % (k=2)

Appendix (Additional assessments outside the scope of SCS 0108)

Antenna Parameters with Head TSL

Impedance, transformed to feed point	55.0 Ω + 2.3 j Ω
Return Loss	- 25.6 dB

Antenna Parameters with Body TSL

Impedance, transformed to feed point	50.2 Ω + 4.7 j Ω
Return Loss	- 26.6 dB

General Antenna Parameters and Design

Electrical Delay (one direction)	1.162 ns
----------------------------------	----------

After long term use with 100W radiated power, only a slight warming of the dipole near the feedpoint can be measured.

The dipole is made of standard semirigid coaxial cable. The center conductor of the feeding line is directly connected to the second arm of the dipole. The antenna is therefore short-circuited for DC-signals. On some of the dipoles, small end caps are added to the dipole arms in order to improve matching when loaded according to the position as explained in the "Measurement Conditions" paragraph. The SAR data are not affected by this change. The overall dipole length is still according to the Standard.

No excessive force must be applied to the dipole arms, because they might bend or the soldered connections near the feedpoint may be damaged.

Additional EUT Data

Manufactured by	SPEAG
Manufactured on	December 30, 2014

Appendix (Additional assessments outside the scope of SCS 0108)

Measurement Conditions

DASY system configuration, as far as not given on page 1 and 3.

Phantom	SAM Head Phantom	For usage with cSAR3DV2-R/L
---------	------------------	-----------------------------

SAR result with SAM Head (Top)

SAR averaged over 1 cm ³ (1 g) of Head TSL	Condition	
SAR measured	250 mW input power	13.6 W/kg
SAR for nominal Head TSL parameters	normalized to 1W	54.0 W/kg ± 17.5 % (k=2)

SAR averaged over 10 cm ³ (10 g) of Head TSL	condition	
SAR measured	250 mW input power	6.33 W/kg
SAR for nominal Head TSL parameters	normalized to 1W	25.2 W/kg ± 16.9 % (k=2)

SAR result with SAM Head (Mouth)

SAR averaged over 1 cm ³ (1 g) of Head TSL	Condition	
SAR measured	250 mW input power	13.6 W/kg
SAR for nominal Head TSL parameters	normalized to 1W	54.0 W/kg ± 17.5 % (k=2)

SAR averaged over 10 cm ³ (10 g) of Head TSL	condition	
SAR measured	250 mW input power	6.35 W/kg
SAR for nominal Head TSL parameters	normalized to 1W	25.3 W/kg ± 16.9 % (k=2)

SAR result with SAM Head (Neck)

SAR averaged over 1 cm ³ (1 g) of Head TSL	Condition	
SAR measured	250 mW input power	12.9 W/kg
SAR for nominal Head TSL parameters	normalized to 1W	51.2 W/kg ± 17.5 % (k=2)

SAR averaged over 10 cm ³ (10 g) of Head TSL	condition	
SAR measured	250 mW input power	6.11 W/kg
SAR for nominal Head TSL parameters	normalized to 1W	24.4 W/kg ± 16.9 % (k=2)

SAR result with SAM Head (Ear)

SAR averaged over 1 cm ³ (1 g) of Head TSL	Condition	
SAR measured	250 mW input power	8.74 W/kg
SAR for nominal Head TSL parameters	normalized to 1W	34.7 W/kg ± 17.5 % (k=2)

SAR averaged over 10 cm ³ (10 g) of Head TSL	condition	
SAR measured	250 mW input power	4.40 W/kg
SAR for nominal Head TSL parameters	normalized to 1W	17.5 W/kg ± 16.9 % (k=2)

DASY5 Validation Report for Head TSL

Date: 13.08.2018

Test Laboratory: SPEAG, Zurich, Switzerland

DUT: Dipole 2450 MHz; Type: D2450V2; Serial: D2450V2 - SN:981

Communication System: UID 0 - CW; Frequency: 2450 MHz

Medium parameters used: $f = 2450$ MHz; $\sigma = 1.86$ S/m; $\epsilon_r = 37.7$; $\rho = 1000$ kg/m³

Phantom section: Flat Section

Measurement Standard: DASY5 (IEEE/IEC/ANSI C63.19-2011)

DASY52 Configuration:

- Probe: EX3DV4 - SN7349; ConvF(7.88, 7.88, 7.88) @ 2450 MHz; Calibrated: 30.12.2017
- Sensor-Surface: 1.4mm (Mechanical Surface Detection)
- Electronics: DAE4 Sn601; Calibrated: 26.10.2017
- Phantom: Flat Phantom 5.0 (front); Type: QD 000 P50 AA; Serial: 1001
- DASY52 52.10.1(1476); SEMCAD X 14.6.11(7439)

Dipole Calibration for Head Tissue/Pin=250 mW, d=10mm/Zoom Scan (7x7x7)/Cube 0:

Measurement grid: dx=5mm, dy=5mm, dz=5mm

Reference Value = 116.6 V/m; Power Drift = -0.03 dB

Peak SAR (extrapolated) = 26.7 W/kg

SAR(1 g) = 13.4 W/kg; SAR(10 g) = 6.2 W/kg

Maximum value of SAR (measured) = 22.1 W/kg



Impedance Measurement Plot for Head TSL

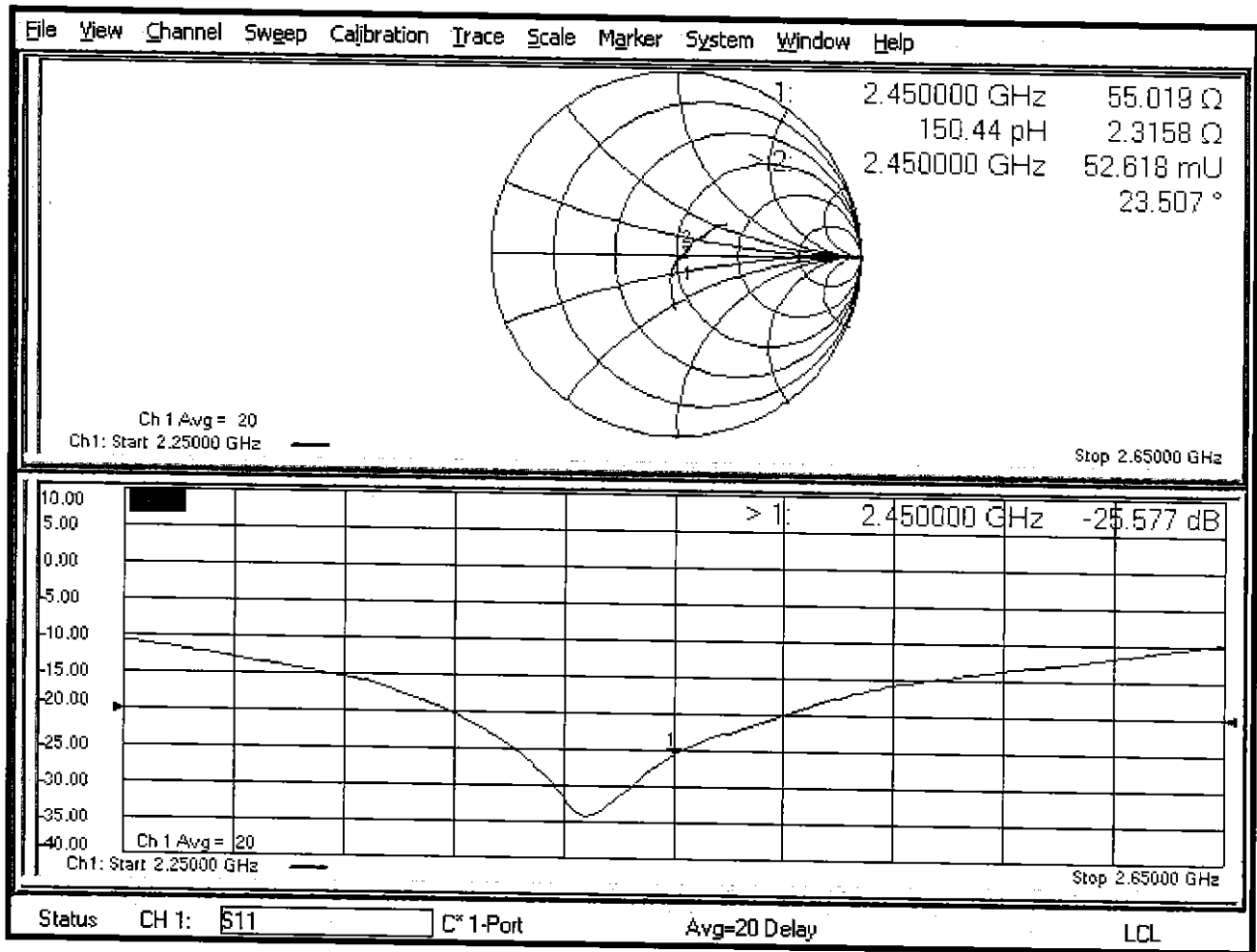

DASY5 Validation Report for Body TSL

Date: 13.08.2018

Test Laboratory: SPEAG, Zurich, Switzerland

DUT: Dipole 2450 MHz; Type: D2450V2; Serial: D2450V2 - SN:981

Communication System: UID 0 - CW; Frequency: 2450 MHz

Medium parameters used: $f = 2450$ MHz; $\sigma = 2.02$ S/m; $\epsilon_r = 51.8$; $\rho = 1000$ kg/m³

Phantom section: Flat Section

Measurement Standard: DASY5 (IEEE/IEC/ANSI C63.19-2011)

DASY52 Configuration:

- Probe: EX3DV4 - SN7349; ConvF(8.01, 8.01, 8.01) @ 2450 MHz; Calibrated: 30.12.2017
- Sensor-Surface: 1.4mm (Mechanical Surface Detection)
- Electronics: DAE4 Sn601; Calibrated: 26.10.2017
- Phantom: Flat Phantom 5.0 (back); Type: QD 000 P50 AA; Serial: 1002
- DASY52 52.10.1(1476); SEMCAD X 14.6.11(7439)

Dipole Calibration for Body Tissue/Pin=250 mW, d=10mm/Zoom Scan (7x7x7)/Cube 0:

Measurement grid: dx=5mm, dy=5mm, dz=5mm

Reference Value = 107.0 V/m; Power Drift = -0.08 dB

Peak SAR (extrapolated) = 25.3 W/kg

SAR(1 g) = 13 W/kg; SAR(10 g) = 6.11 W/kg

Maximum value of SAR (measured) = 20.7 W/kg



0 dB = 20.7 W/kg = 13.16 dBW/kg

Impedance Measurement Plot for Body TSL

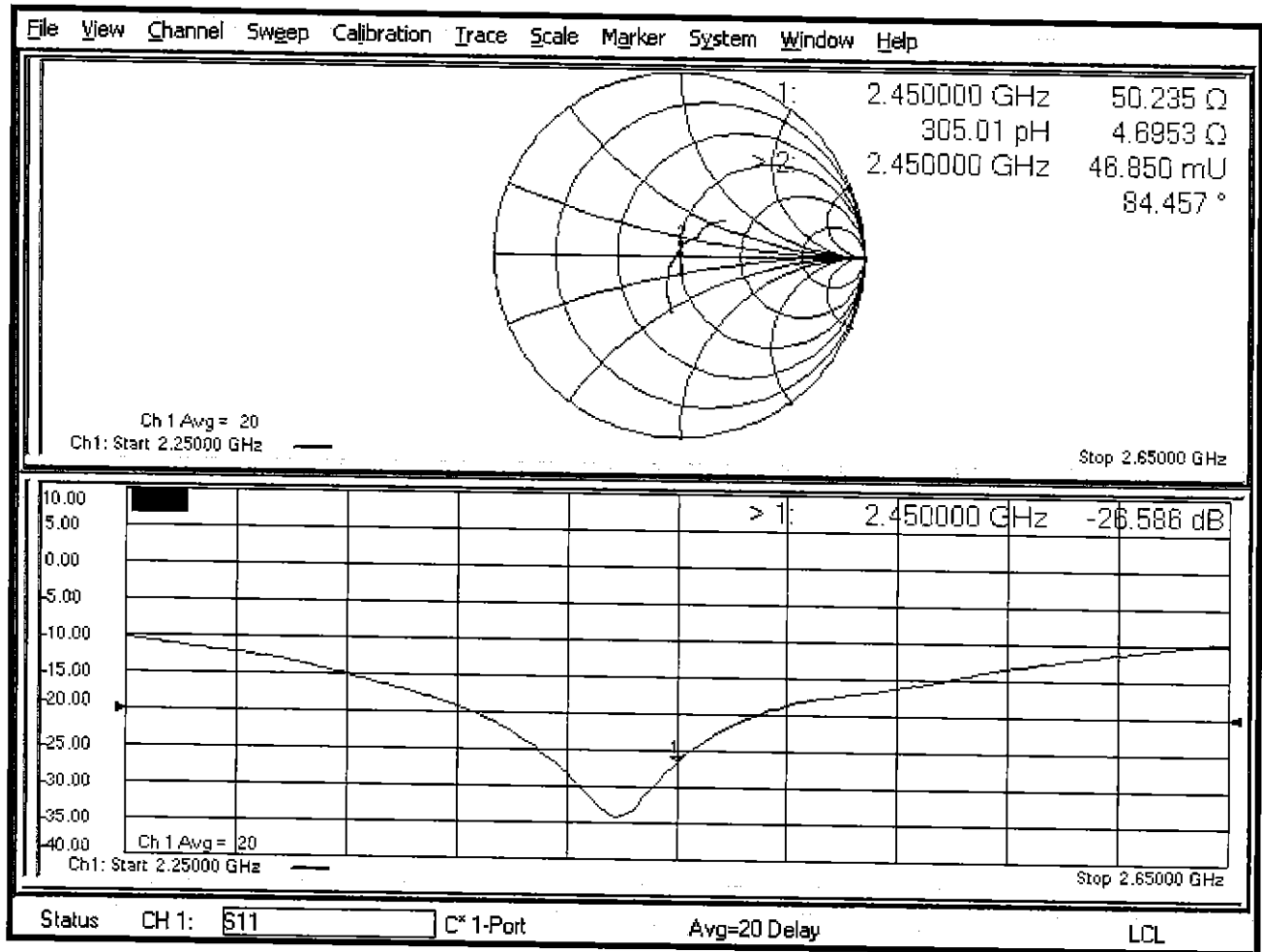

DASY5 Validation Report for SAM Head

Date: 16.08.2018

Test Laboratory: SPEAG, Zurich, Switzerland

DUT: Dipole 2450 MHz; Type: D2450V2; Serial: D2450V2 - SN:981

Communication System: UID 0 - CW ; Frequency: 2450 MHz

Medium parameters used: $f = 2450$ MHz; $\sigma = 1.85$ S/m; $\epsilon_r = 40.2$; $\rho = 1000$ kg/m³

Measurement Standard: DASY5 (IEEE/IEC/ANSI C63.19-2011)

DASY52 Configuration:

- Probe: EX3DV4 - SN7349; ConvF(7.88, 7.88, 7.88) @ 2450 MHz; Calibrated: 30.12.2017
- Sensor-Surface: 1.4mm (Mechanical Surface Detection)
- Electronics: DAE4 Sn601; Calibrated: 26.10.2017
- Phantom: SAM Head
- DASY52 52.10.1(1476); SEMCAD X 14.6.11(7439)

SAM Head Top/Zoom Scan (7x7x7)/Cube 0: Measurement grid: dx=5mm, dy=5mm, dz=5mm

Reference Value = 116.2 V/m; Power Drift = 0.00 dB

Peak SAR (extrapolated) = 26.4 W/kg

SAR(1 g) = 13.6 W/kg; SAR(10 g) = 6.33 W/kg

Maximum value of SAR (measured) = 22.0 W/kg

SAM Head Mouth/Zoom Scan (7x7x7)/Cube 0: Measurement grid: dx=5mm, dy=5mm, dz=5mm

Reference Value = 116.9 V/m; Power Drift = 0.01 dB

Peak SAR (extrapolated) = 26.3 W/kg

SAR(1 g) = 13.6 W/kg; SAR(10 g) = 6.35 W/kg

Maximum value of SAR (measured) = 21.7 W/kg

SAM Head Neck/Zoom Scan (7x7x7)/Cube 0: Measurement grid: dx=5mm, dy=5mm, dz=5mm

Reference Value = 112.0 V/m; Power Drift = 0.03 dB

Peak SAR (extrapolated) = 24.1 W/kg

SAR(1 g) = 12.9 W/kg; SAR(10 g) = 6.11 W/kg

Maximum value of SAR (measured) = 20.5 W/kg

SAM Head Ear/Zoom Scan (7x7x7)/Cube 0: Measurement grid: dx=5mm, dy=5mm, dz=5mm

Reference Value = 91.03 V/m; Power Drift = -0.01 dB

Peak SAR (extrapolated) = 15.8 W/kg

SAR(1 g) = 8.74 W/kg; SAR(10 g) = 4.4 W/kg

Maximum value of SAR (measured) = 13.5 W/kg

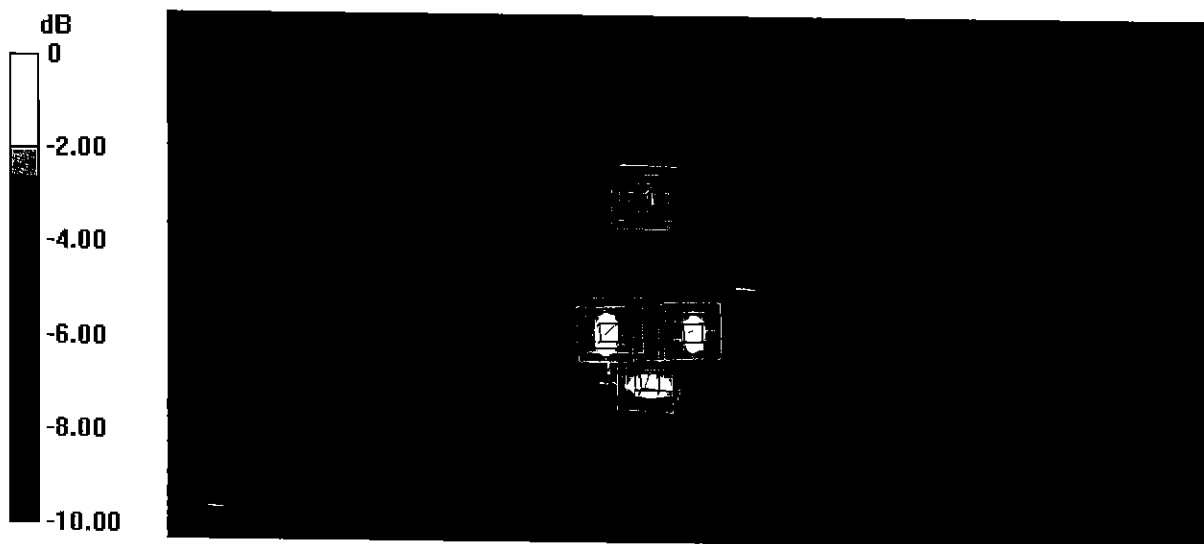

0 dB = 22.0 W/kg = 13.42 dBW/kg

Certification of Calibration

Object: D2450V2 – SN: 981

Calibration procedure(s): Procedure for Calibration Extension for SAR Dipoles.

Calibration date: 08/09/2019

Description: SAR Validation Dipole at 2450 MHz.

Calibration Equipment used:

Manufacturer	Model	Description	Cal Date	Cal Interval	Cal Due	Serial Number
Agilent	8753ES	S-Parameter Network Analyzer	10/2/2018	Annual	10/2/2019	US39170118
Agilent	N5182A	MXG Vector Signal Generator	6/27/2019	Annual	6/27/2020	US46240505
Amplifier Research	15S1G6	Amplifier	CBT	N/A	CBT	343972
Anritsu	ML2495A	Power Meter	10/21/2018	Annual	10/21/2019	941001
Anritsu	MA2411B	Pulse Power Sensor	10/30/2018	Annual	10/30/2019	1207470
Anritsu	MA2411B	Pulse Power Sensor	11/20/2018	Annual	11/20/2019	1339007
Control Company	4040	Temperature / Humidity Monitor	2/28/2018	Biennial	2/28/2020	150761911
Control Company	4352	Ultra Long Stem Thermometer	2/28/2018	Biennial	2/28/2020	170330160
Keysight	772D	Dual Directional Coupler	CBT	N/A	CBT	MY52180215
Keysight Technologies	85033E	Standard Mechanical Calibration Kit (DC to 9GHz, 3.5mm)	7/2/2019	Annual	7/2/2020	MY53401181
Mini-Circuits	BW-N20W5+	DC to 18 GHz Precision Fixed 20 dB Attenuator	CBT	N/A	CBT	N/A
Mini-Circuits	NLP-2950+	Low Pass Filter DC to 2700 MHz	CBT	N/A	CBT	N/A
Narda	4772-3	Attenuator (3dB)	CBT	N/A	CBT	9406
Pasternack	PE2209-10	Bidirectional Coupler	CBT	N/A	CBT	N/A
Pasternack	NC-100	Torque Wrench	5/23/2018	Biennial	5/23/2020	N/A
SPEAG	EX3DV4	SAR Probe	2/19/2019	Annual	2/19/2020	7417
SPEAG	DAE4	Dasy Data Acquisition Electronics	2/13/2019	Annual	2/13/2020	665
SPEAG	EX3DV4	SAR Probe	7/15/2019	Annual	7/15/2020	7547
SPEAG	DAE4	Dasy Data Acquisition Electronics	7/11/2019	Annual	7/11/2020	1323
SPEAG	DAK-3.5	Dielectric Assessment Kit	9/11/2018	Annual	9/11/2019	1091

Measurement Uncertainty = $\pm 23\%$ (k=2)

	Name	Function	Signature
Calibrated By:	Brodie Halfoster	Test Engineer	<i>BRODIE HALFOSTER</i>
Approved By:	Kaitlin O'Keefe	Senior Technical Manager	<i>KOK</i>

DIPOLE CALIBRATION EXTENSION

Per KDB 865664 D01, calibration intervals of up to three years may be considered for reference dipoles when it is demonstrated that the SAR target, impedance and return loss of a dipole have remained stable according to the following requirements:

1. The measured SAR does not deviate more than 10% from the target on the calibration certificate.
2. The return-loss does not deviate more than 20% from the previous measurement and meets the required 20dB minimum return-loss requirement.
3. The measurement of real or imaginary parts of impedance does not deviate more than 5Ω from the previous measurement.

The following dipole was checked to pass the above 3 requirements to have 2-year calibration period from the calibration date:

Calibration Date	Extension Date	Certificate Electrical Delay (ns)	Certificate SAR Target Head (1g) W/kg @ 20.0 dBm	Measured Head SAR (1g) W/kg @ 20.0 dBm	Deviation 1g (%)	Certificate SAR Target Head (10g) W/kg @ 20.0 dBm	Measured Head SAR (10g) W/kg @ 20.0 dBm	Deviation 10g (%)	Certificate Impedance Head (Ohm) Real	Measured Impedance Head (Ohm) Real	Difference (Ohm) Real	Certificate Impedance Head (Ohm) Imaginary	Measured Impedance Head (Ohm) Imaginary	Difference (Ohm) Imaginary	Certificate Return Loss Head (dB)	Measured Return Loss Head (dB)	Deviation (%)	PASS/FAIL
8/16/2018	8/9/2019	1.162	5.23	5.53	5.74%	2.44	2.56	4.92%	55	53.5	1.5	2.3	1.1	1.2	-25.6	-28.5	-11.30%	PASS
Calibration Date	Extension Date	Certificate Electrical Delay (ns)	Certificate SAR Target Body (1g) W/kg @ 20.0 dBm	Measured Body SAR (1g) W/kg @ 20.0 dBm	Deviation 1g (%)	Certificate SAR Target Body (10g) W/kg @ 20.0 dBm	Measured Body SAR (10g) W/kg @ 20.0 dBm	Deviation 10g (%)	Certificate Impedance Body (Ohm) Real	Measured Impedance Body (Ohm) Real	Difference (Ohm) Real	Certificate Impedance Body (Ohm) Imaginary	Measured Impedance Body (Ohm) Imaginary	Difference (Ohm) Imaginary	Certificate Return Loss Body (dB)	Measured Return Loss Body (dB)	Deviation (%)	PASS/FAIL
8/16/2018	8/9/2019	1.162	5.09	4.98	-2.16%	2.42	2.28	-5.79%	50.2	47.8	2.4	4.7	1.1	3.6	-26.6	-31.8	-19.60%	PASS

Impedance & Return-Loss Measurement Plot for Head TSL

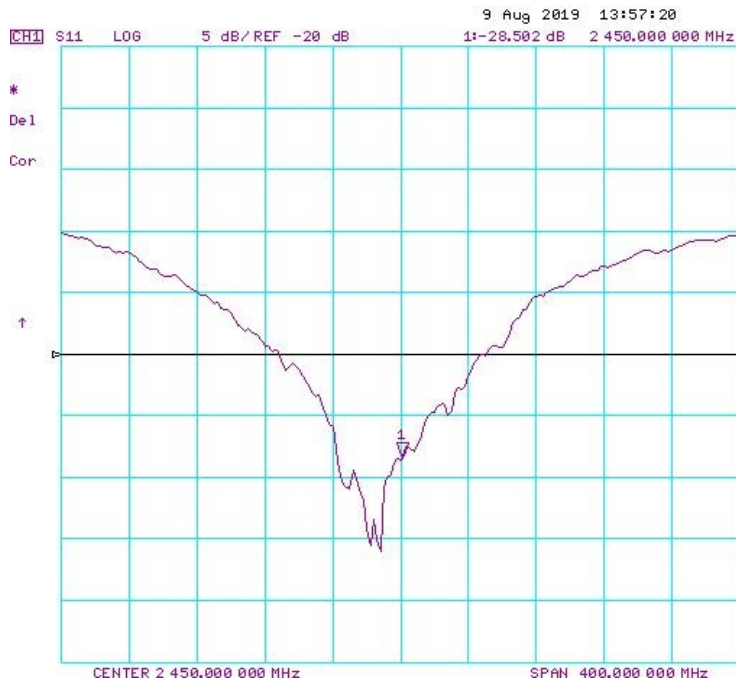
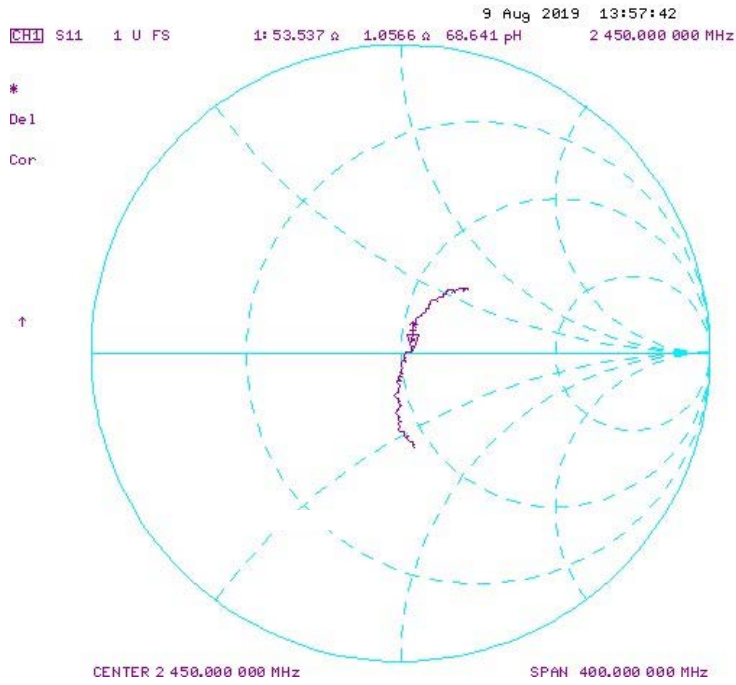

Impedance & Return-Loss Measurement Plot for Body TSL

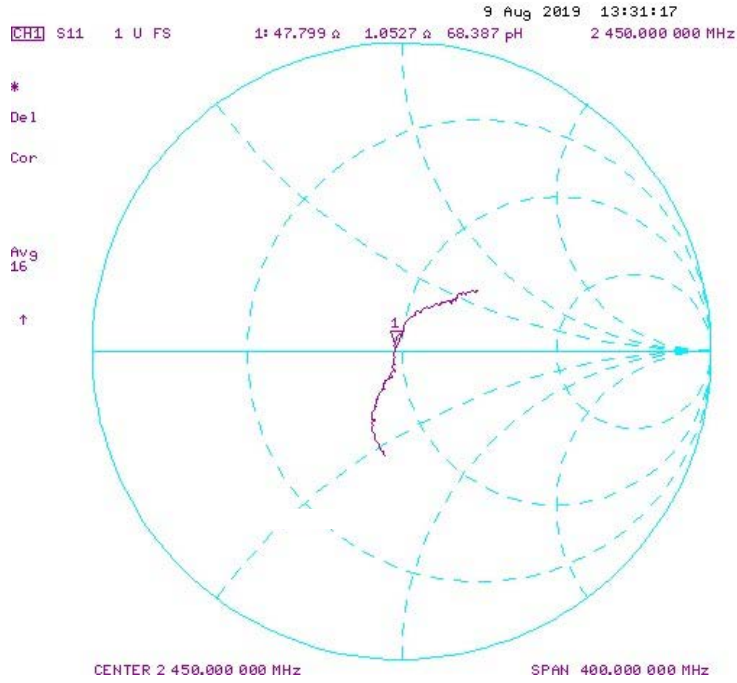

Certification of Calibration

Object: D2450V2 – SN: 981

Calibration procedure(s): Procedure for Calibration Extension for SAR Dipoles.

Extension Calibration date: 8/16/2020

Description: SAR Validation Dipole at 2450 MHz

Calibration Equipment used:

Manufacturer	Model	Description	Cal Date	Cal Interval	Cal Due	Serial Number
Control Company	4040	Therm./Clock/Humidity Monitor	6/29/2019	Biennial	6/29/2021	192291470
Control Company	4352	Ultra Long Stem Thermometer	11/29/2018	Biennial	11/29/2020	181766816
Amplifier Research	15S1G6	Amplifier	CBT	N/A	CBT	433971
Narda	4772-3	Attenuator (3dB)	CBT	N/A	CBT	9406
Agilent	85033E	3.5mm Standard Calibration Kit	6/6/2020	Annual	6/6/2021	MY53402352
Rohde & Schwarz	ZNLE6	Vector Network Analyzer	10/11/2019	Annual	10/11/2020	101307
Mini-Circuits	BW-N20W5+	DC to 18 GHz Precision Fixed 20 dB Attenuator	CBT	N/A	CBT	N/A
SPEAG	DAKS-3.5	Portable DAK	9/10/2019	Annual	9/10/2020	1045
Anritsu	MA2411B	Pulse Power Sensor	8/14/2019	Annual	8/14/2020	1315051
Anritsu	MA2411B	Pulse Power Sensor	8/27/2019	Annual	8/27/2020	1339027
Anritsu	ML2495A	Power Meter	12/17/2019	Annual	12/17/2020	941001
Agilent	N5182A	MXG Vector Signal Generator	8/19/2019	Annual	8/19/2020	MY47420837
Seekonk Inc	NC-100	Torque Wrench	8/4/2020	Biennial	8/4/2022	N/A
MiniCircuits	ZHDC-16-63-S+	Bidirectional Coupler	CBT	N/A	CBT	N/A
MiniCircuits	VLf-6000+	Low Pass Filter	CBT	N/A	CBT	N/A
SPEAG	EX3DV4	SAR Probe	1/21/2020	Annual	1/21/2021	3589
SPEAG	EX3DV4	SAR Probe	6/23/2020	Annual	6/23/2021	7409
SPEAG	DAE4	Dasy Data Acquisition Electronics	6/18/2020	Annual	6/18/2021	1334
SPEAG	DAE4	Dasy Data Acquisition Electronics	6/23/2020	Annual	1/13/2021	1558

Measurement Uncertainty = $\pm 23\%$ (k=2)

	Name	Function	Signature
Calibrated By:	Brodie Halfoster	Test Engineer	<i>BRODIE HALFOSTER</i>
Approved By:	Kaitlin O'Keefe	Senior Technical Manager	<i>KOK</i>

DIPOLE CALIBRATION EXTENSION

Per KDB 865664 D01, calibration intervals of up to three years may be considered for reference dipoles when it is demonstrated that the SAR target, impedance and return loss of a dipole have remained stable according to the following requirements:

1. The measured SAR does not deviate more than 10% from the target on the calibration certificate.
2. The return-loss does not deviate more than 20% from the previous measurement and meets the required 20dB minimum return-loss requirement.
3. The measurement of real or imaginary parts of impedance does not deviate more than 5Ω from the previous measurement.

The following dipole was checked to pass the above 3 requirements to have 3-year calibration period from the calibration date:

Calibration Date	Extension Date	Certificate Electrical Delay (ns)	Certificate SAR Target Head (1g) W/kg @ 20.0 dBm	Measured Head SAR (1g) W/kg @ 20.0 dBm	Deviation 1g (%)	Certificate SAR Target Head (10g) W/kg @ 20.0 dBm	Measured Head SAR (10g) W/kg @ 20.0 dBm	Deviation 10g (%)	Certificate Impedance Head (Ohm) Real	Measured Impedance Head (Ohm) Real	Difference (Ohm) Real	Certificate Impedance Head (Ohm) Imaginary	Measured Impedance Head (Ohm) Imaginary	Difference (Ohm) Imaginary	Certificate Return Loss Head (dB)	Measured Return Loss Head (dB)	Deviation (%)	PASS/FAIL
8/16/2018	8/16/2020	1.162	5.23	5.31	1.53%	2.44	2.4	-1.64%	55	53.4	1.6	2.3	1.1	1.2	-25.6	-28.9	-12.90%	PASS
Calibration Date	Extension Date	Certificate Electrical Delay (ns)	Certificate SAR Target Body (1g) W/kg @ 20.0 dBm	Measured Body SAR (1g) W/kg @ 20.0 dBm	Deviation 1g (%)	Certificate SAR Target Body (10g) W/kg @ 20.0 dBm	Measured Body SAR (10g) W/kg @ 20.0 dBm	Deviation 10g (%)	Certificate Impedance Body (Ohm) Real	Measured Impedance Body (Ohm) Real	Difference (Ohm) Real	Certificate Impedance Body (Ohm) Imaginary	Measured Impedance Body (Ohm) Imaginary	Difference (Ohm) Imaginary	Certificate Return Loss Body (dB)	Measured Return Loss Body (dB)	Deviation (%)	PASS/FAIL
8/16/2018	8/16/2020	1.162	5.09	5.3	4.13%	2.42	2.43	0.41%	50.2	48.5	1.7	4.7	2.4	2.3	-26.6	-30.8	-15.80%	PASS

Impedance & Return-Loss Measurement Plot for Head TSL

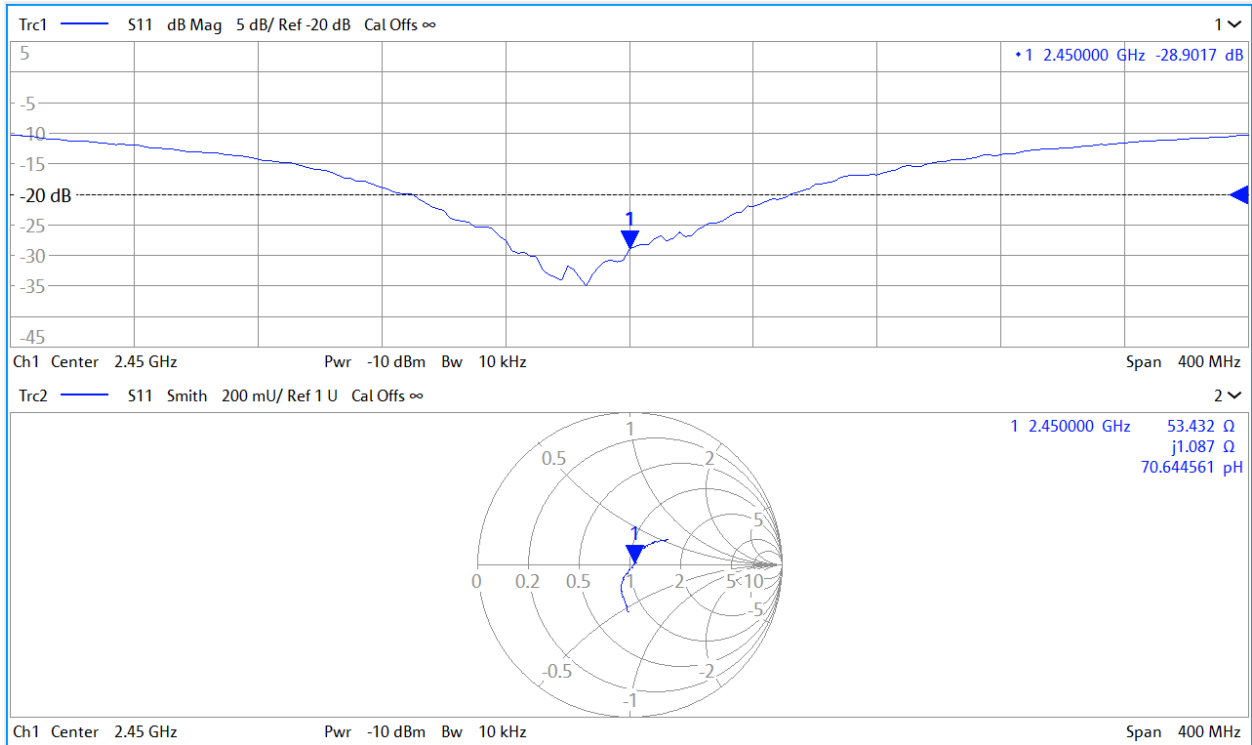

Impedance & Return-Loss Measurement Plot for Body TSL

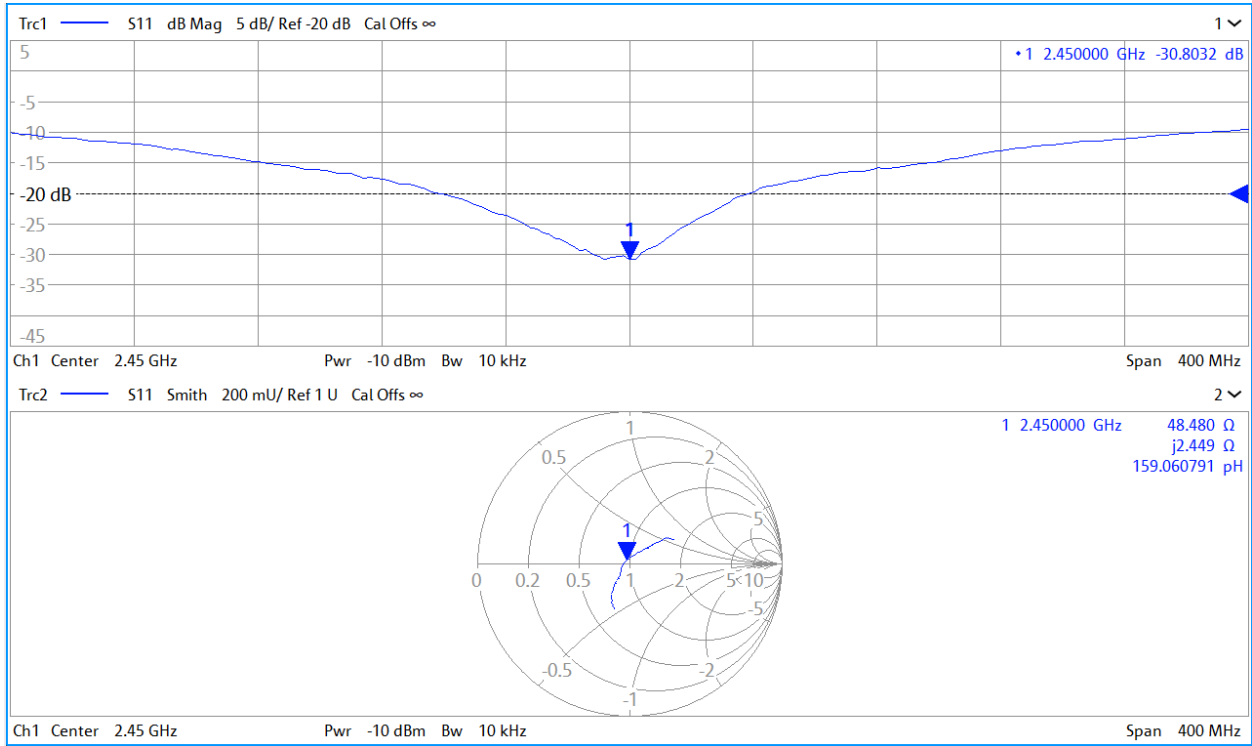

Calibration Laboratory of
Schmid & Partner
Engineering AG
Zeughausstrasse 43, 8004 Zurich, Switzerland



S Schweizerischer Kalibrierdienst
C Service suisse d'étalonnage
S Servizio svizzero di taratura
S Swiss Calibration Service

Accredited by the Swiss Accreditation Service (SAS)
The Swiss Accreditation Service is one of the signatories to the EA
Multilateral Agreement for the recognition of calibration certificates

Accreditation No.: SCS 0108

Client **PC Test**

Certificate No. **D2600V2-1009_Jun18**

CALIBRATION CERTIFICATE

Object: **D2600V2 - SN:1009**

Calibration procedure(s): **DA CAL-05-V10
Calibration procedure for dipole validation kits above 700 MHz**

Calibration date: **June 19, 2018**

SC ✓
6/28/18
BN ✓
7/01/19
AML ✓
7/6/2020

This calibration certificate documents the traceability to national standards, which realize the physical units of measurements (SI).
The measurements and the uncertainties with confidence probability are given on the following pages and are part of the certificate.

All calibrations have been conducted in the closed laboratory facility: environment temperature (22 ± 3)°C and humidity < 70%.

Calibration Equipment used (M&TE critical for calibration)

Primary Standards	ID #	Cal Date (Certificate No.)	Scheduled Calibration
Power meter NRP	SN: 104778	04-Apr-18 (No. 217-02672/02673)	Apr-19
Power sensor NRP-Z91	SN: 103244	04-Apr-18 (No. 217-02672)	Apr-19
Power sensor NRP-Z91	SN: 103245	04-Apr-18 (No. 217-02673)	Apr-19
Reference 20 dB Attenuator	SN: 5058 (20k)	04-Apr-18 (No. 217-02682)	Apr-19
Type-N mismatch combination	SN: 5047.2 / 06327	04-Apr-18 (No. 217-02683)	Apr-19
Reference Probe EX3DV4	SN: 7349	30-Dec-17 (No. EX3-7349_Dec17)	Dec-18
DAE4	SN: 601	26-Oct-17 (No. DAE4-601_Oct17)	Oct-18

Secondary Standards	ID #	Check Date (in house)	Scheduled Check
Power meter EPM-442A	SN: GB37480704	07-Oct-15 (in house check Oct-16)	In house check: Oct-18
Power sensor HP 8481A	SN: US37292783	07-Oct-15 (in house check Oct-16)	In house check: Oct-18
Power sensor HP 8481A	SN: MY41092317	07-Oct-15 (in house check Oct-16)	In house check: Oct-18
RF generator R&S SMT-06	SN: 100972	15-Jun-15 (in house check Oct-16)	In house check: Oct-18
Network Analyzer HP 8753E	SN: US37390585	18-Oct-01 (in house check Oct-17)	In house check: Oct-18

Calibrated by: **Claudio Leubler** (Name), **Laboratory Technician** (Function), *[Signature]* (Signature)

Approved by: **Ketja Pokovic** (Name), **Technical Manager** (Function), *[Signature]* (Signature)

Issued: June 21, 2018

This calibration certificate shall not be reproduced except in full without written approval of the laboratory.



Accredited by the Swiss Accreditation Service (SAS)

The Swiss Accreditation Service is one of the signatories to the EA
Multilateral Agreement for the recognition of calibration certificates

Accreditation No.: **SCS 0108**

Glossary:

TSL	tissue simulating liquid
ConvF	sensitivity in TSL / NORM x,y,z
N/A	not applicable or not measured

Calibration is Performed According to the Following Standards:

- IEEE Std 1528-2013, "IEEE Recommended Practice for Determining the Peak Spatial-Averaged Specific Absorption Rate (SAR) in the Human Head from Wireless Communications Devices: Measurement Techniques", June 2013
- IEC 62209-1, "Measurement procedure for the assessment of Specific Absorption Rate (SAR) from hand-held and body-mounted devices used next to the ear (frequency range of 300 MHz to 6 GHz)", July 2016
- IEC 62209-2, "Procedure to determine the Specific Absorption Rate (SAR) for wireless communication devices used in close proximity to the human body (frequency range of 30 MHz to 6 GHz)", March 2010
- KDB 865664, "SAR Measurement Requirements for 100 MHz to 6 GHz"

Additional Documentation:

- DASY4/5 System Handbook

Methods Applied and Interpretation of Parameters:

- Measurement Conditions:* Further details are available from the Validation Report at the end of the certificate. All figures stated in the certificate are valid at the frequency indicated.
- Antenna Parameters with TSL:* The dipole is mounted with the spacer to position its feed point exactly below the center marking of the flat phantom section, with the arms oriented parallel to the body axis.
- Feed Point Impedance and Return Loss:* These parameters are measured with the dipole positioned under the liquid filled phantom. The impedance stated is transformed from the measurement at the SMA connector to the feed point. The Return Loss ensures low reflected power. No uncertainty required.
- Electrical Delay:* One-way delay between the SMA connector and the antenna feed point. No uncertainty required.
- SAR measured:* SAR measured at the stated antenna input power.
- SAR normalized:* SAR as measured, normalized to an input power of 1 W at the antenna connector.
- SAR for nominal TSL parameters:* The measured TSL parameters are used to calculate the nominal SAR result.

The reported uncertainty of measurement is stated as the standard uncertainty of measurement multiplied by the coverage factor $k=2$, which for a normal distribution corresponds to a coverage probability of approximately 95%.

Measurement Conditions

DASY system configuration, as far as not given on page 1.

DASY Version	DASY5	V52.10.1
Extrapolation	Advanced Extrapolation	
Phantom	Modular Flat Phantom	
Distance Dipole Center - TSL	10 mm	with Spacer
Zoom Scan Resolution	dx, dy, dz = 5 mm	
Frequency	2600 MHz ± 1 MHz	

Head TSL parameters

The following parameters and calculations were applied.

	Temperature	Permittivity	Conductivity
Nominal Head TSL parameters	22.0 °C	39.0	1.96 mho/m
Measured Head TSL parameters	(22.0 ± 0.2) °C	37.4 ± 6 %	2.03 mho/m ± 6 %
Head TSL temperature change during test	< 0.5 °C	----	----

SAR result with Head TSL

SAR averaged over 1 cm³ (1 g) of Head TSL	Condition	
SAR measured	250 mW input power	14.3 W/kg
SAR for nominal Head TSL parameters	normalized to 1W	55.8 W/kg ± 17.0 % (k=2)

SAR averaged over 10 cm³ (10 g) of Head TSL	condition	
SAR measured	250 mW input power	6.38 W/kg
SAR for nominal Head TSL parameters	normalized to 1W	25.1 W/kg ± 16.5 % (k=2)

Body TSL parameters

The following parameters and calculations were applied.

	Temperature	Permittivity	Conductivity
Nominal Body TSL parameters	22.0 °C	52.5	2.16 mho/m
Measured Body TSL parameters	(22.0 ± 0.2) °C	51.8 ± 6 %	2.22 mho/m ± 6 %
Body TSL temperature change during test	< 0.5 °C	----	----

SAR result with Body TSL

SAR averaged over 1 cm³ (1 g) of Body TSL	Condition	
SAR measured	250 mW input power	14.1 W/kg
SAR for nominal Body TSL parameters	normalized to 1W	55.5 W/kg ± 17.0 % (k=2)

SAR averaged over 10 cm³ (10 g) of Body TSL	condition	
SAR measured	250 mW input power	6.31 W/kg
SAR for nominal Body TSL parameters	normalized to 1W	25.0 W/kg ± 16.5 % (k=2)

Appendix (Additional assessments outside the scope of SCS 0108)

Antenna Parameters with Head TSL

Impedance, transformed to feed point	49.8 Ω - 5.0 j Ω
Return Loss	- 26.0 dB

Antenna Parameters with Body TSL

Impedance, transformed to feed point	44.3 Ω - 4.8 j Ω
Return Loss	- 22.1 dB

General Antenna Parameters and Design

Electrical Delay (one direction)	1.153 ns
----------------------------------	----------

After long term use with 100W radiated power, only a slight warming of the dipole near the feedpoint can be measured.

The dipole is made of standard semirigid coaxial cable. The center conductor of the feeding line is directly connected to the second arm of the dipole. The antenna is therefore short-circuited for DC-signals. On some of the dipoles, small end caps are added to the dipole arms in order to improve matching when loaded according to the position as explained in the "Measurement Conditions" paragraph. The SAR data are not affected by this change. The overall dipole length is still according to the Standard.

No excessive force must be applied to the dipole arms, because they might bend or the soldered connections near the feedpoint may be damaged.

Additional EUT Data

Manufactured by	SPEAG
Manufactured on	April 12, 2007

DASY5 Validation Report for Head TSL

Date: 13.06.2018

Test Laboratory: SPEAG, Zurich, Switzerland

DUT: Dipole 2600 MHz; Type: D2600V2; Serial: D2600V2 - SN:1009

Communication System: UID 0 - CW; Frequency: 2600 MHz

Medium parameters used: $f = 2600$ MHz; $\sigma = 2.03$ S/m; $\epsilon_r = 37.4$; $\rho = 1000$ kg/m³

Phantom section: Flat Section

Measurement Standard: DASY5 (IEEE/IEC/ANSI C63.19-2011)

DASY52 Configuration:

- Probe: EX3DV4 - SN7349; ConvF(7.7, 7.7, 7.7) @ 2600 MHz; Calibrated: 30.12.2017
- Sensor-Surface: 1.4mm (Mechanical Surface Detection)
- Electronics: DAE4 Sn601; Calibrated: 26.10.2017
- Phantom: Flat Phantom 5.0 (front); Type: QD 000 P50 AA; Serial: 1001
- DASY52 52.10.1(1476); SEMCAD X 14.6.11(7439)

Dipole Calibration for Head Tissue/Pin=250 mW, d=10mm/Zoom Scan (7x7x7)/Cube 0:

Measurement grid: dx=5mm, dy=5mm, dz=5mm

Reference Value = 117.9 V/m; Power Drift = 0.03 dB

Peak SAR (extrapolated) = 28.4 W/kg

SAR(1 g) = 14.3 W/kg; SAR(10 g) = 6.38 W/kg

Maximum value of SAR (measured) = 23.7 W/kg

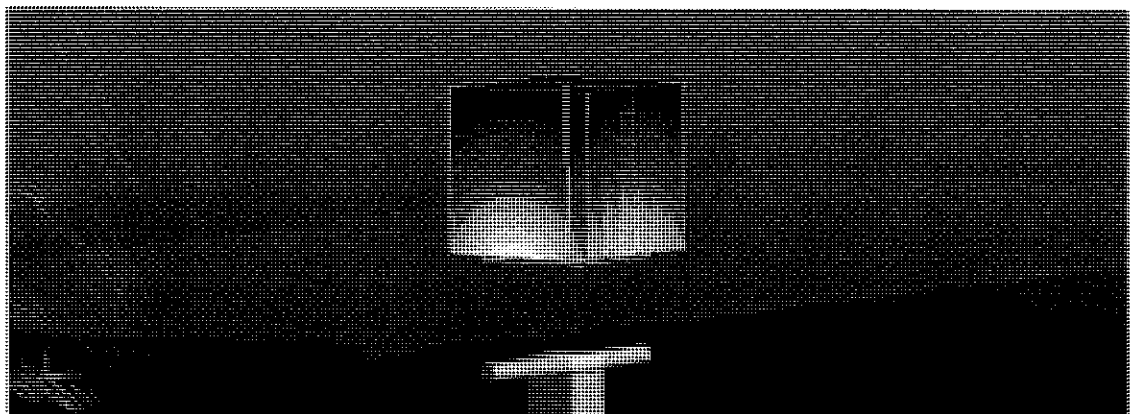
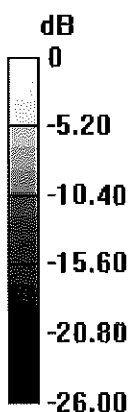

0 dB = 23.7 W/kg = 13.75 dBW/kg

Impedance Measurement Plot for Head TSL

13 Jun 2018 12:15:33

CH1 S11 1 U FS 1: 49.844 Ω -4.9863 Ω 12.276 pF 2 500.000 000 MHz

*
De1
CA
Avg
16
H1d

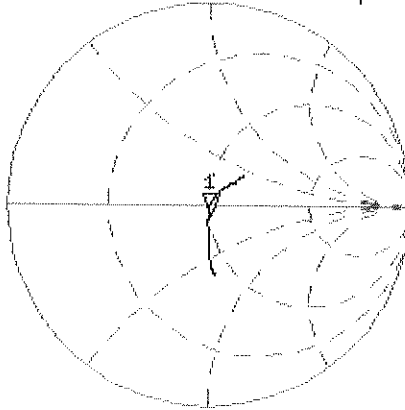

CH2 S11 LOG 5 dB/REF -20 dB 1: -26.037 dB 2 500.000 000 MHz

CA
Avg
16
H1d

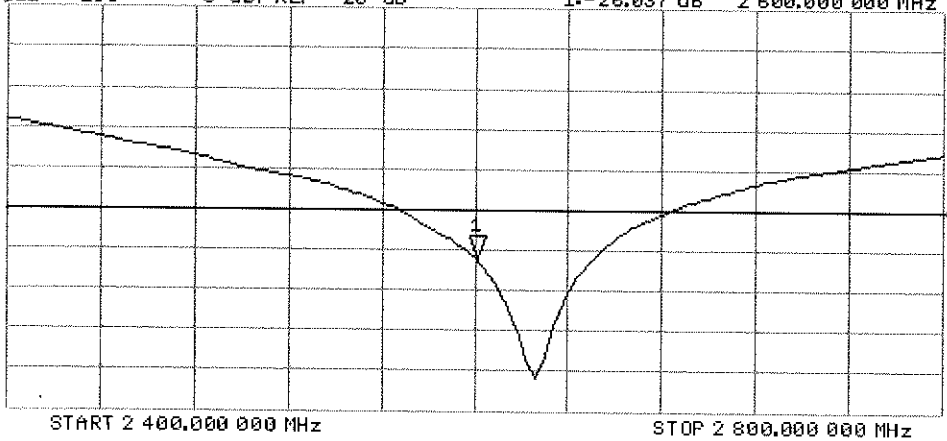

DASY5 Validation Report for Body TSL

Date: 19.06.2018

Test Laboratory: SPEAG, Zurich, Switzerland

DUT: Dipole 2600 MHz; Type: D2600V2; Serial: D2600V2 - SN:1009

Communication System: UID 0 - CW; Frequency: 2600 MHz

Medium parameters used: $f = 2600$ MHz; $\sigma = 2.22$ S/m; $\epsilon_r = 51.8$; $\rho = 1000$ kg/m³

Phantom section: Flat Section

Measurement Standard: DASY5 (IEEE/IEC/ANSI C63.19-2011)

DASY52 Configuration:

- Probe: EX3DV4 - SN7349; ConvF(7.81, 7.81, 7.81) @ 2600 MHz; Calibrated: 30.12.2017
- Sensor-Surface: 1.4mm (Mechanical Surface Detection)
- Electronics: DAE4 Sn601; Calibrated: 26.10.2017
- Phantom: Flat Phantom 5.0 (back); Type: QD 000 P50 AA; Serial: 1002
- DASY52 52.10.1(1476); SEMCAD X 14.6.11(7439)

Dipole Calibration for Body Tissue/Pin=250 mW, d=10mm/Zoom Scan (7x7x7)/Cube 0:

Measurement grid: dx=5mm, dy=5mm, dz=5mm

Reference Value = 109.4 V/m; Power Drift = -0.07 dB

Peak SAR (extrapolated) = 28.7 W/kg

SAR(1 g) = 14.1 W/kg; SAR(10 g) = 6.31 W/kg

Maximum value of SAR (measured) = 23.7 W/kg

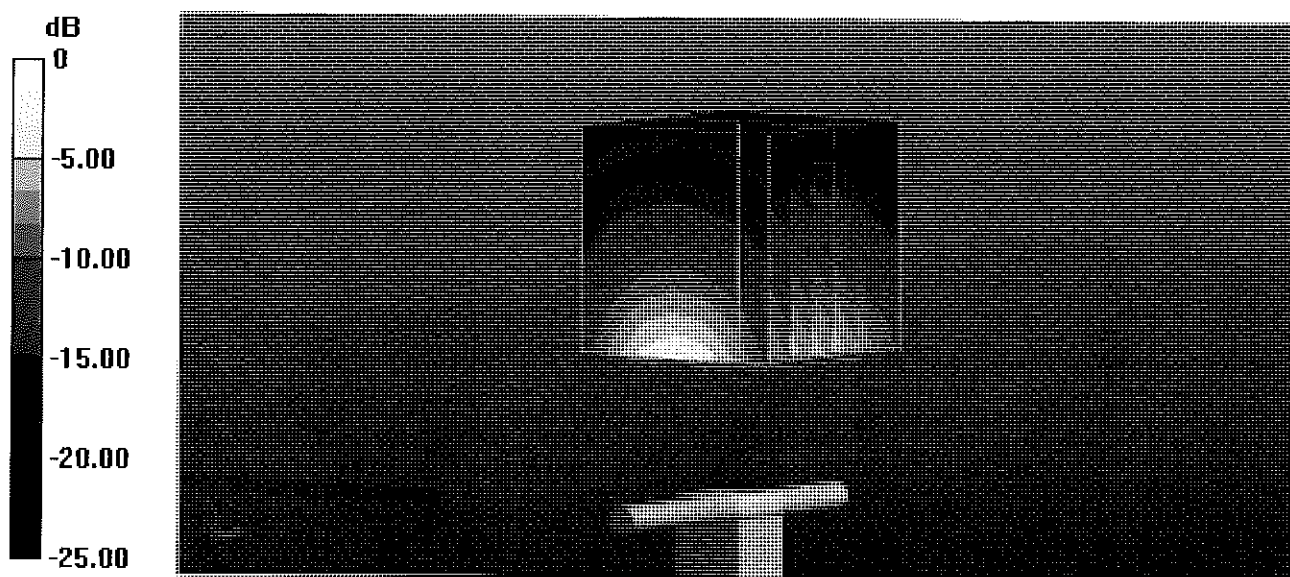

0 dB = 23.7 W/kg = 13.75 dBW/kg

Impedance Measurement Plot for Body TSL

19 Jun 2018 10:04:18

CH1 S11 1 U FS

1: 44.344 Ω -4.7832 Ω 12.798 pF

2 500.000 000 MHz

*
Del

CA

Avg
16

H1d

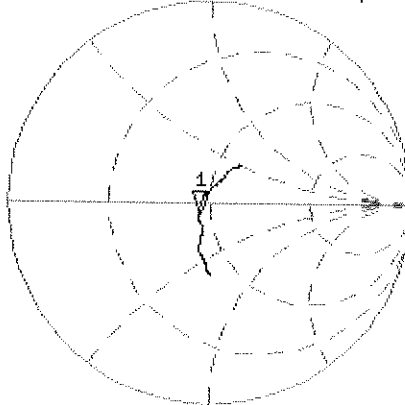

CH2 S11 LOG

5 dB/REF -20 dB

1: -22.109 dB

2 500.000 000 MHz

CA

Avg
16

H1d

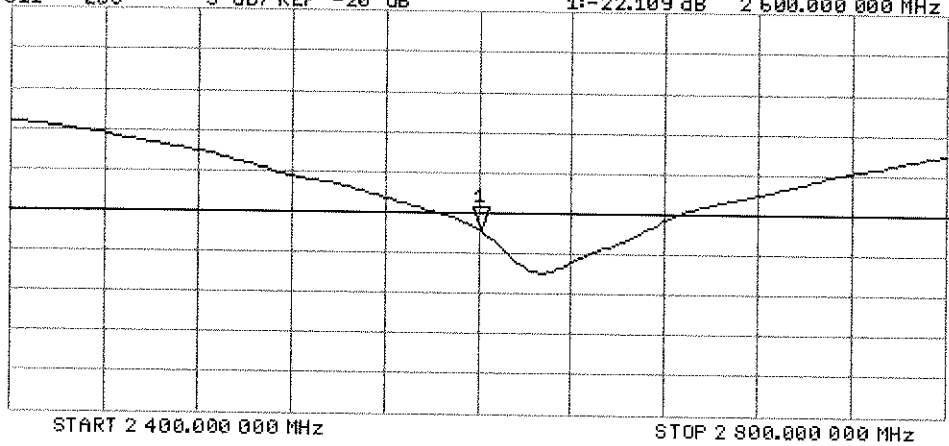

Certification of Calibration

Object D2600V2 – SN: 1009

Calibration procedure(s) Procedure for Calibration Extension for SAR Dipoles.

Extended Calibration date: June 19, 2019

Description: SAR Validation Dipole at 2600 MHz.

Calibration Equipment used:

Manufacturer	Model	Description	Cal Date	Cal Interval	Cal Due	Serial Number
Agilent	8753ES	S-Parameter Network Analyzer	10/2/2018	Annual	10/2/2019	US39170118
Agilent	E4438C	ESG Vector Signal Generator	6/26/2018	Annual	6/26/2019	MY42081752
Agilent	85033E	3.5mm Standard Calibration Kit	8/13/2018	Annual	8/13/2019	MY53402352
Amplifier Research	1551G6	Amplifier	CBT	N/A	CBT	343972
Anritsu	ML2495A	Power Meter	10/21/2018	Annual	10/21/2019	941001
Anritsu	MA2411B	Pulse Power Sensor	10/30/2018	Annual	10/30/2019	1207470
Anritsu	MA2411B	Pulse Power Sensor	11/20/2018	Annual	11/20/2019	1339007
Control Company	4040	Temperature / Humidity Monitor	2/28/2018	Biennial	2/28/2020	150761911
Control Company	4352	Ultra Long Stem Thermometer	2/28/2018	Biennial	2/28/2020	170330160
Keysight	772D	Dual Directional Coupler	CBT	N/A	CBT	MY52180215
Mini-Circuits	BW-N20W5+	DC to 18 GHz Precision Fixed 20 dB Attenuator	CBT	N/A	CBT	N/A
Mini-Circuits	NLP-2950+	Low Pass Filter DC to 2700 MHz	CBT	N/A	CBT	N/A
Narda	4772-3	Attenuator (3dB)	CBT	N/A	CBT	9406
Pasternack	PE2209-10	Bidirectional Coupler	CBT	N/A	CBT	N/A
Pasternack	PE5011-1	Torque Wrench	7/19/2017	Biennial	7/19/2019	N/A
SPEAG	DAKS-3.5	Portable DAK	9/11/2018	Annual	9/11/2019	1045
SPEAG	ES3DV3	SAR Probe	11/19/2018	Annual	11/19/2019	3318
SPEAG	EX3DV4	E-field Probes	2/19/2019	Annual	2/19/2020	7427
SPEAG	DAE4	Dasy Data Acquisition Electronics	8/14/2018	Annual	8/14/2019	1408
SPEAG	DAE4	Dasy Data Acquisition Electronics	2/13/2019	Annual	2/13/2020	1403

Measurement Uncertainty = $\pm 23\%$ (k=2)

	Name	Function	Signature
Calibrated By:	Parker Jones	Team Lead Engineer	<i>Parker Jones</i>
Approved By:	Kaitlin O'Keefe	Senior Technical Manager	<i>KOK</i>

DIPOLE CALIBRATION EXTENSION

Per KDB 865664 D01, calibration intervals of up to three years may be considered for reference dipoles when it is demonstrated that the SAR target, impedance and return loss of a dipole have remained stable according to the following requirements:

1. The measured SAR does not deviate more than 10% from the target on the calibration certificate.
2. The return-loss does not deviate more than 20% from the previous measurement and meets the required 20dB minimum return-loss requirement.
3. The measurement of real or imaginary parts of impedance does not deviate more than 5Ω from the previous measurement.

The following dipole was checked to pass the above 3 requirements to have 2-year calibration period from the calibration date:

Calibration Date	Extension Date	Certificate Electrical Delay (ns)	Certificate SAR Target Head (1g) W/kg @ 20.0 dBm	Measured Head SAR (1g) W/kg @ 20.0 dBm	Deviation 1g (%)	Certificate SAR Target Head (10g) W/kg @ 20.0 dBm	Measured Head SAR (10g) W/kg @ 20.0 dBm	Deviation 10g (%)	Certificate Impedance Head (Ohm) Real	Measured Impedance Head (Ohm) Real	Difference (Ohm) Real	Certificate Impedance Head (Ohm) Imaginary	Measured Impedance Head (Ohm) Imaginary	Difference (Ohm) Imaginary	Certificate Return Loss Head (dB)	Measured Return Loss Head (dB)	Deviation (%)	PASS/FAIL
6/19/2018	6/19/2019	1.153	5.58	5.87	5.20%	2.51	2.61	3.98%	49.8	49.3	0.5	-5	-7.9	2.9	-26	-23.2	10.70%	PASS

Calibration Date	Extension Date	Certificate Electrical Delay (ns)	Certificate SAR Target Body (1g) W/kg @ 20.0 dBm	Measured Body SAR (1g) W/kg @ 20.0 dBm	Deviation 1g (%)	Certificate SAR Target Body (10g) W/kg @ 20.0 dBm	Measured Body SAR (10g) W/kg @ 20.0 dBm	Deviation 10g (%)	Certificate Impedance Body (Ohm) Real	Measured Impedance Body (Ohm) Real	Difference (Ohm) Real	Certificate Impedance Body (Ohm) Imaginary	Measured Impedance Body (Ohm) Imaginary	Difference (Ohm) Imaginary	Certificate Return Loss Body (dB)	Measured Return Loss Body (dB)	Deviation (%)	PASS/FAIL
6/19/2018	6/19/2019	1.153	5.55	5.39	-2.88%	2.5	2.39	-4.40%	44.3	46.7	2.3	-4.8	-5.3	0.5	-22.1	-24.1	-8.90%	PASS

Impedance & Return-Loss Measurement Plot for Head TSL

CH1 S11 1 U FS 1: 49.258 Ω -7.9121 Ω 7.7367 pF 2 600.000 000 MHz

*
De1
Cor
Avg
16
↑

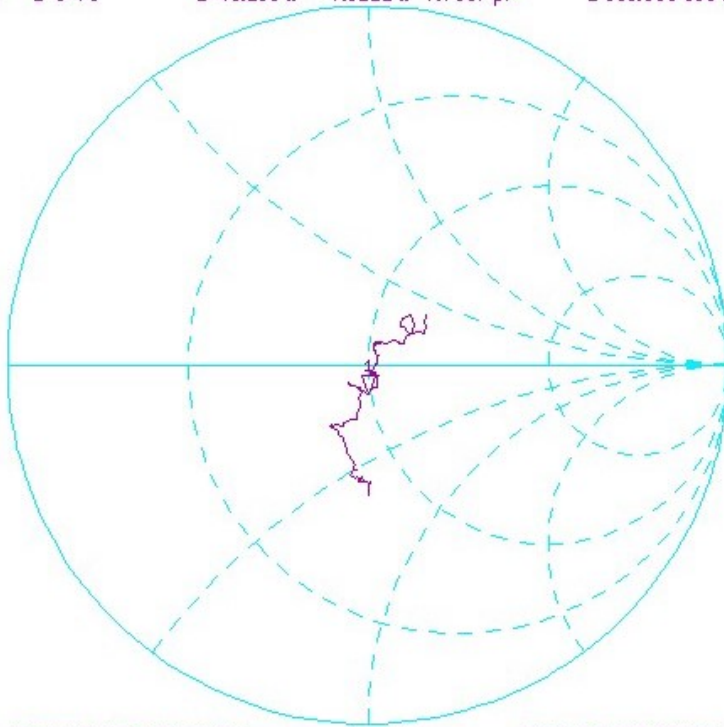

CH1 S11 LOG 5 dB/REF -20 dB 1: -23.218 dB 2 600.000 000 MHz

*
De1
Smo
Cor
Avg
12
↑

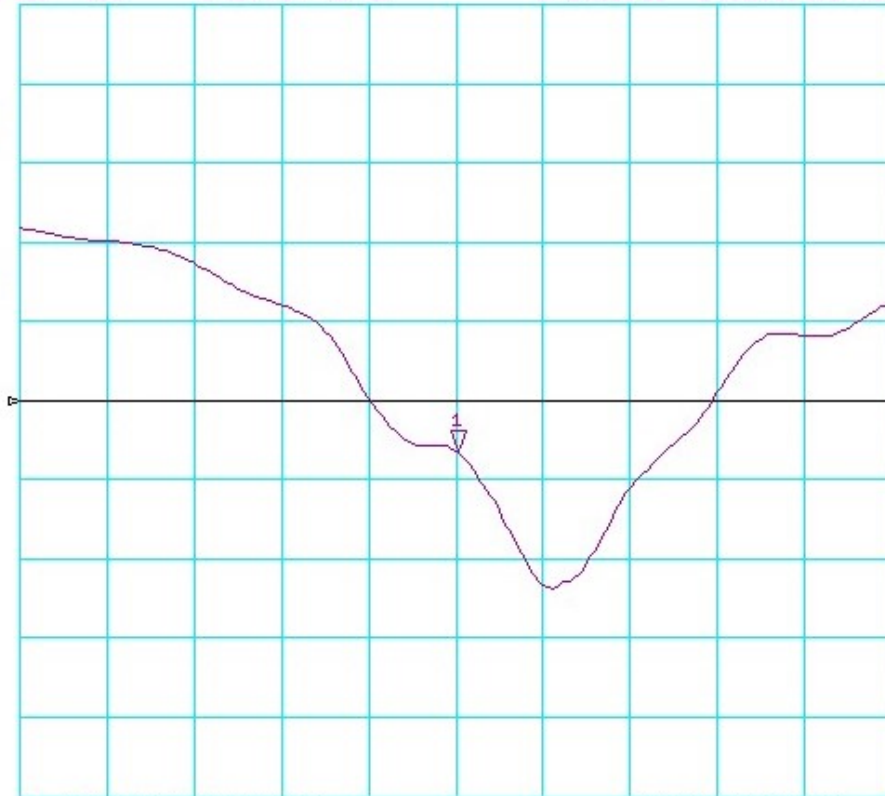

Object: D2600V2 – SN: 1009	Date Issued: 06/19/2019	Page 3 of 4
--------------------------------------	-----------------------------------	-------------

Impedance & Return-Loss Measurement Plot for Body TSL

CH1 S11 1 U FS 1: 46.656 Ω -5.3262 Ω 11.493 pF 2 600.000 000 MHz

*
De1
Smo
Cor

Avg
16

↑

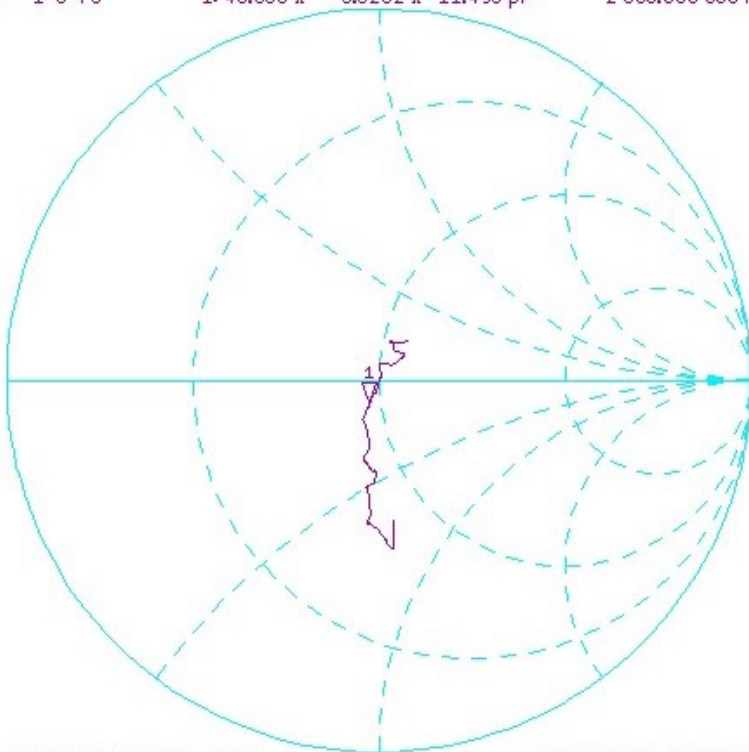

CENTER 2 600.000 000 MHz

SPAN 400.000 000 MHz

CH1 S11 LOG 5 dB/REF -20 dB 1: -24.061 dB 2 600.000 000 MHz

*
De1
Smo
Cor

Avg
16

↑

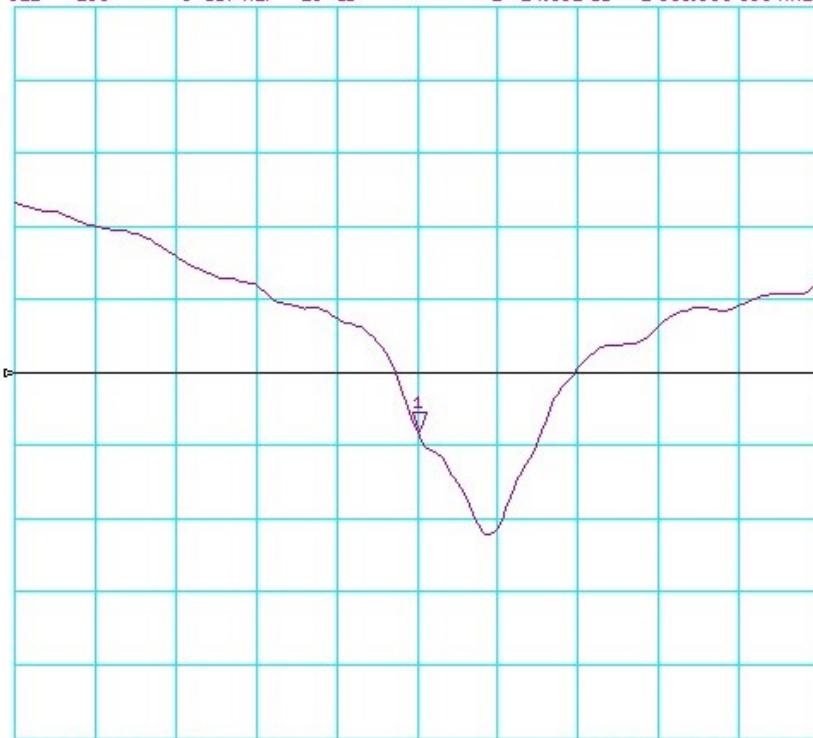

CENTER 2 600.000 000 MHz

SPAN 400.000 000 MHz

Certification of Calibration

Object: D2600V2 – SN: 1009
 Calibration procedure(s): Procedure for Calibration Extension for SAR Dipoles.
 Extended Calibration date: June 19, 2020
 Description: SAR Validation Dipole at 2600 MHz.

Calibration Equipment used:

Manufacturer	Model	Description	Cal Date	Cal Interval	Cal Due	Serial Number
Agilent	8753ES	S-Parameter Network Analyzer	1/16/2020	Annual	1/16/2021	US39170118
Agilent	N5182A	MXG Vector Signal Generator	8/19/2019	Annual	8/19/2020	MY47420837
Amplifier Research	15S1G6	Amplifier	CBT	N/A	CBT	343972
Anritsu	MA2411B	Pulse Power Sensor	1/21/2020	Annual	1/21/2021	1207470
Anritsu	MA2411B	Pulse Power Sensor	1/21/2020	Annual	1/21/2021	1339007
Anritsu	ML2495A	Power Meter	1/15/2020	Annual	1/15/2021	1328004
Control Company	62344-734	Therm./ Clock/ Humidity Monitor	3/18/2019	Biennial	3/18/2021	192038436
Control Company	4352	Ultra Long Stem Thermometer	8/2/2018	Biennial	8/2/2020	181292000
Keysight	772D	Dual Directional Coupler	CBT	N/A	CBT	MY52180215
Keysight Technologies	85033E	Standard Mechanical Calibration Kit (DC to 9GHz, 3.5mm)	7/2/2019	Annual	7/2/2020	MY53401181
MiniCircuits	VLf-6000+	Low Pass Filter	CBT	N/A	CBT	N/A
Mini-Circuits	BW-N20W5+	DC to 18 GHz Precision Fixed 20 dB Attenuator	CBT	N/A	CBT	N/A
Narda	4772-3	Attenuator (3dB)	CBT	N/A	CBT	9406
Seekonk	NC-100	Torque Wrench	7/18/2019	Annual	7/18/2020	N/A
SPEAG	DAE4	Dasy Data Acquisition Electronics	1/14/2020	Annual	1/14/2021	793
SPEAG	DAE4	Dasy Data Acquisition Electronics	7/10/2019	Annual	7/10/2020	1402
SPEAG	DAK-3.5	Dielectric Assessment Kit	5/12/2020	Annual	5/12/2021	1070
SPEAG	EX3DV4	SAR Probe	1/20/2020	Annual	1/20/2021	3837
SPEAG	EX3DV4	SAR Probe	7/16/2019	Annual	7/16/2020	7491

Measurement Uncertainty = $\pm 23\%$ (k=2)

	Name	Function	Signature
Calibrated By:	Parker Jones	Team Lead Engineer	<i>Parker Jones</i>
Approved By:	Kaitlin O'Keefe	Managing Director	<i>KOK</i>

DIPOLE CALIBRATION EXTENSION

Per KDB 865664 D01, calibration intervals of up to three years may be considered for reference dipoles when it is demonstrated that the SAR target, impedance and return loss of a dipole have remained stable according to the following requirements:

1. The measured SAR does not deviate more than 10% from the target on the calibration certificate.
2. The return-loss does not deviate more than 20% from the previous measurement and meets the required 20dB minimum return-loss requirement.
3. The measurement of real or imaginary parts of impedance does not deviate more than 5Ω from the previous measurement.

The following dipole was checked to pass the above 3 requirements to have 3-year calibration period from the calibration date:

Calibration Date	Extension Date	Certificate Electrical Delay (ns)	Certificate SAR Target Head (1g) W/kg @ 20.0 dBm	Measured Head SAR (1g) W/kg @ 20.0 dBm	Deviation 1g (%)	Certificate SAR Target Head (10g) W/kg @ 20.0 dBm	Measured Head SAR (10g) W/kg @ 20.0 dBm	Deviation 10g (%)	Certificate Impedance Head (Ohm) Real	Measured Impedance Head (Ohm) Real	Difference (Ohm) Real	Certificate Impedance Head (Ohm) Imaginary	Measured Impedance Head (Ohm) Imaginary	Difference (Ohm) Imaginary	Certificate Return Loss Head (dB)	Measured Return Loss Head (dB)	Deviation (%)	PASS/FAIL
6/19/2018	6/19/2020	1.153	5.58	5.76	3.23%	2.51	2.55	1.59%	49.8	46	-3.8	-5	-4.5	0.5	-26	-23.9	8.10%	PASS
Calibration Date	Extension Date	Certificate Electrical Delay (ns)	Certificate SAR Target Body (1g) W/kg @ 20.0 dBm	Measured Body SAR (1g) W/kg @ 20.0 dBm	Deviation 1g (%)	Certificate SAR Target Body (10g) W/kg @ 20.0 dBm	Measured Body SAR (10g) W/kg @ 20.0 dBm	Deviation 10g (%)	Certificate Impedance Body (Ohm) Real	Measured Impedance Body (Ohm) Real	Difference (Ohm) Real	Certificate Impedance Body (Ohm) Imaginary	Measured Impedance Body (Ohm) Imaginary	Difference (Ohm) Imaginary	Certificate Return Loss Body (dB)	Measured Return Loss Body (dB)	Deviation (%)	PASS/FAIL
6/19/2018	6/19/2020	1.153	5.55	5.59	0.72%	2.5	2.44	-2.40%	44.3	44.6	0.3	-4.8	-2.5	2.3	-22.1	-24	-8.60%	PASS

Impedance & Return-Loss Measurement Plot for Head TSL

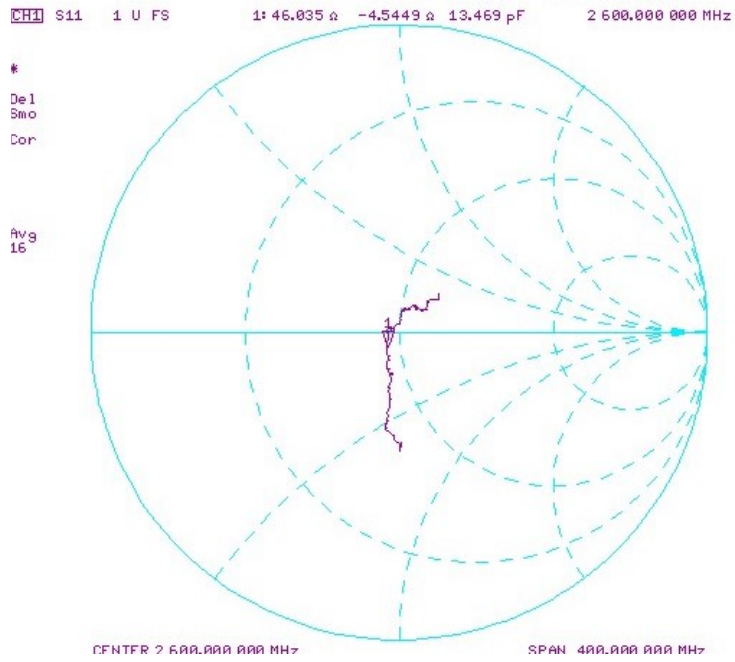

Impedance & Return-Loss Measurement Plot for Body TSL

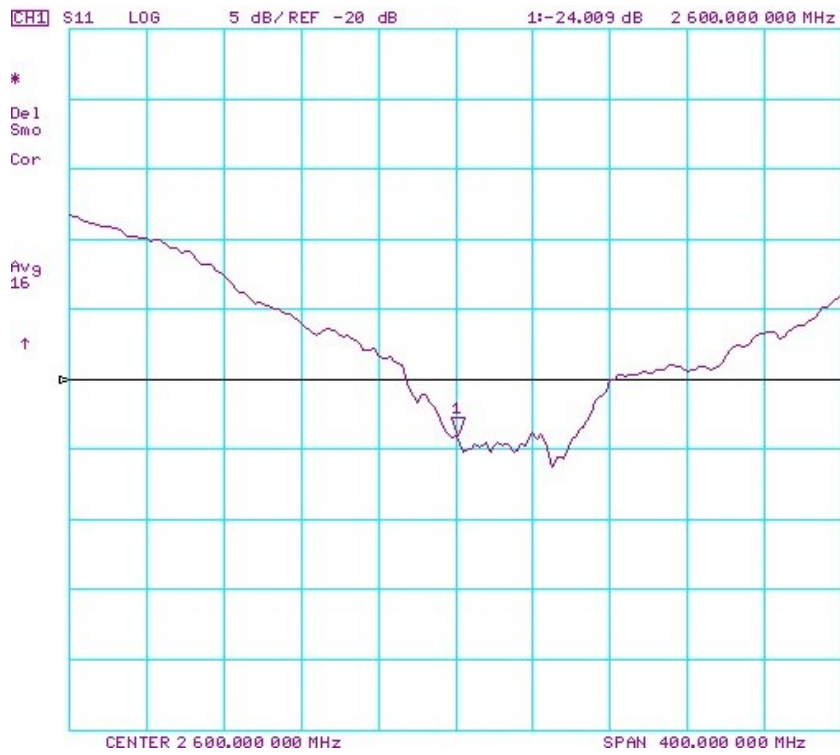
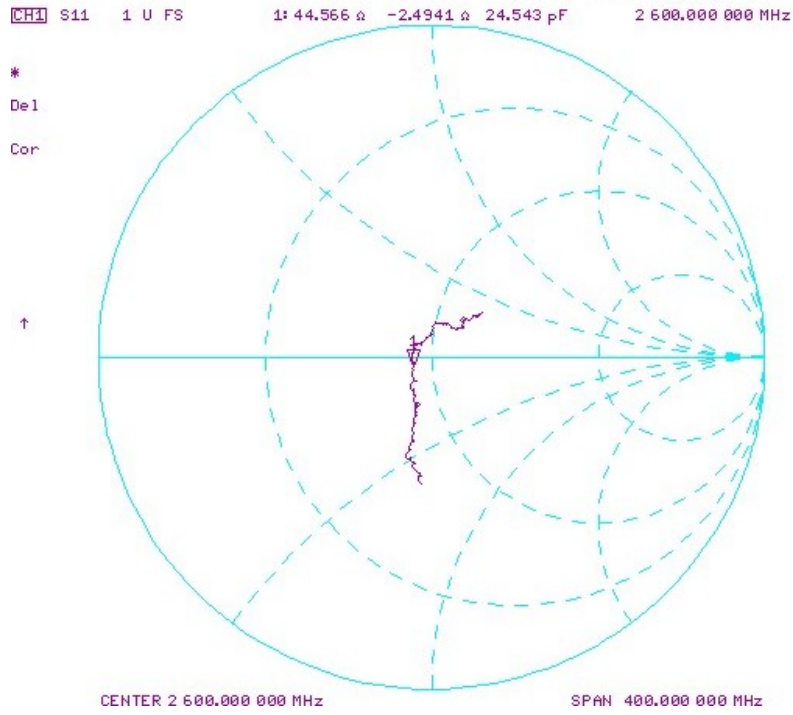

**Calibration Laboratory of
Schmid & Partner
Engineering AG**
Zeughausstrasse 43, 8004 Zurich, Switzerland



S Schweizerischer Kalibrierdienst
C Service suisse d'étalonnage
S Servizio svizzero di taratura
S Swiss Calibration Service

Accredited by the Swiss Accreditation Service (SAS)
The Swiss Accreditation Service is one of the signatories to the EA
Multilateral Agreement for the recognition of calibration certificates

Accreditation No.: **SCS 0108**

Client **PC Test**

Certificate No: **D2600V2-1042_Jun19**

CALIBRATION CERTIFICATE

Object **D2600V2 - SN:1042**

Calibration procedure(s) **QA CAL-05.v11
Calibration Procedure for SAR Validation Sources between 0.7-3 GHz**

Calibration date: **June 14, 2019**

Handwritten notes: ✓ ATM 6/23/19, ✓ ATM 7/16/2020

This calibration certificate documents the traceability to national standards, which realize the physical units of measurements (SI).
The measurements and the uncertainties with confidence probability are given on the following pages and are part of the certificate.

All calibrations have been conducted in the closed laboratory facility: environment temperature (22 ± 3)°C and humidity < 70%.

Calibration Equipment used (M&TE critical for calibration)

Primary Standards	ID #	Cal Date (Certificate No.)	Scheduled Calibration
Power meter NRP	SN: 104778	03-Apr-19 (No. 217-02892/02893)	Apr-20
Power sensor NRP-Z91	SN: 103244	03-Apr-19 (No. 217-02892)	Apr-20
Power sensor NRP-Z91	SN: 103245	03-Apr-19 (No. 217-02893)	Apr-20
Reference 20 dB Attenuator	SN: 5058 (20k)	04-Apr-19 (No. 217-02894)	Apr-20
Type-N mismatch combination	SN: 5047.2 / 06327	04-Apr-19 (No. 217-02895)	Apr-20
Reference Probe EX3DV4	SN: 7349	29-May-19 (No. EX3-7349_May19)	May-20
DAE4	SN: 601	30-Apr-19 (No. DAE4-601_Apr19)	Apr-20
Secondary Standards	ID #	Check Date (in house)	Scheduled Check
Power meter E4419B	SN: GB39512475	30-Oct-14 (in house check Feb-19)	In house check: Oct-20
Power sensor HP 8481A	SN: US37292789	07-Oct-15 (in house check Oct-18)	In house check: Oct-20
Power sensor HP 8481A	SN: MY41092317	07-Oct-15 (in house check Oct-18)	In house check: Oct-20
RF generator R&S SMT-06	SN: 100972	15-Jun-15 (in house check Oct-18)	In house check: Oct-20
Network Analyzer Agilent E8358A	SN: US41080477	31-Mar-14 (in house check Oct-18)	In house check: Oct-19

Calibrated by: **Michael Weber** (Name), **Laboratory Technician** (Function), *[Signature]* (Signature)

Approved by: **Kalja Pokovic** (Name), **Technical Manager** (Function), *[Signature]* (Signature)

Issued: June 20, 2019

This calibration certificate shall not be reproduced except in full without written approval of the laboratory.



Accredited by the Swiss Accreditation Service (SAS)

The Swiss Accreditation Service is one of the signatories to the EA Multilateral Agreement for the recognition of calibration certificates

Accreditation No.: **SCS 0108**

Glossary:

TSL	tissue simulating liquid
ConvF	sensitivity in TSL / NORM x,y,z
N/A	not applicable or not measured

Calibration is Performed According to the Following Standards:

- IEEE Std 1528-2013, "IEEE Recommended Practice for Determining the Peak Spatial-Averaged Specific Absorption Rate (SAR) in the Human Head from Wireless Communications Devices: Measurement Techniques", June 2013
- IEC 62209-1, "Measurement procedure for the assessment of Specific Absorption Rate (SAR) from hand-held and body-mounted devices used next to the ear (frequency range of 300 MHz to 6 GHz)", July 2016
- IEC 62209-2, "Procedure to determine the Specific Absorption Rate (SAR) for wireless communication devices used in close proximity to the human body (frequency range of 30 MHz to 6 GHz)", March 2010
- KDB 865664, "SAR Measurement Requirements for 100 MHz to 6 GHz"

Additional Documentation:

- DASY4/5 System Handbook

Methods Applied and Interpretation of Parameters:

- Measurement Conditions:* Further details are available from the Validation Report at the end of the certificate. All figures stated in the certificate are valid at the frequency indicated.
- Antenna Parameters with TSL:* The dipole is mounted with the spacer to position its feed point exactly below the center marking of the flat phantom section, with the arms oriented parallel to the body axis.
- Feed Point Impedance and Return Loss:* These parameters are measured with the dipole positioned under the liquid filled phantom. The impedance stated is transformed from the measurement at the SMA connector to the feed point. The Return Loss ensures low reflected power. No uncertainty required.
- Electrical Delay:* One-way delay between the SMA connector and the antenna feed point. No uncertainty required.
- SAR measured:* SAR measured at the stated antenna input power.
- SAR normalized:* SAR as measured, normalized to an input power of 1 W at the antenna connector.
- SAR for nominal TSL parameters:* The measured TSL parameters are used to calculate the nominal SAR result.

The reported uncertainty of measurement is stated as the standard uncertainty of measurement multiplied by the coverage factor $k=2$, which for a normal distribution corresponds to a coverage probability of approximately 95%.

Measurement Conditions

DASY system configuration, as far as not given on page 1.

DASY Version	DASY5	V52.10.2
Extrapolation	Advanced Extrapolation	
Phantom	Modular Flat Phantom	
Distance Dipole Center - TSL	10 mm	with Spacer
Zoom Scan Resolution	dx, dy, dz = 5 mm	
Frequency	2600 MHz ± 1 MHz	

Head TSL parameters

The following parameters and calculations were applied.

	Temperature	Permittivity	Conductivity
Nominal Head TSL parameters	22.0 °C	39.0	1.96 mho/m
Measured Head TSL parameters	(22.0 ± 0.2) °C	37.3 ± 6 %	2.03 mho/m ± 6 %
Head TSL temperature change during test	< 0.5 °C	----	----

SAR result with Head TSL

SAR averaged over 1 cm³ (1 g) of Head TSL	Condition	
SAR measured	250 mW input power	14.8 W/kg
SAR for nominal Head TSL parameters	normalized to 1W	57.7 W/kg ± 17.0 % (k=2)

SAR averaged over 10 cm³ (10 g) of Head TSL	condition	
SAR measured	250 mW input power	6.57 W/kg
SAR for nominal Head TSL parameters	normalized to 1W	25.9 W/kg ± 16.5 % (k=2)

Body TSL parameters

The following parameters and calculations were applied.

	Temperature	Permittivity	Conductivity
Nominal Body TSL parameters	22.0 °C	52.5	2.16 mho/m
Measured Body TSL parameters	(22.0 ± 0.2) °C	50.5 ± 6 %	2.22 mho/m ± 6 %
Body TSL temperature change during test	< 0.5 °C	----	----

SAR result with Body TSL

SAR averaged over 1 cm³ (1 g) of Body TSL	Condition	
SAR measured	250 mW input power	14.1 W/kg
SAR for nominal Body TSL parameters	normalized to 1W	55.2 W/kg ± 17.0 % (k=2)

SAR averaged over 10 cm³ (10 g) of Body TSL	condition	
SAR measured	250 mW input power	6.30 W/kg
SAR for nominal Body TSL parameters	normalized to 1W	24.9 W/kg ± 16.5 % (k=2)

Appendix (Additional assessments outside the scope of SCS 0108)

Antenna Parameters with Head TSL

Impedance, transformed to feed point	49.6 Ω - 8.4 j Ω
Return Loss	- 21.5 dB

Antenna Parameters with Body TSL

Impedance, transformed to feed point	45.8 Ω - 6.2 j Ω
Return Loss	- 22.2 dB

General Antenna Parameters and Design

Electrical Delay (one direction)	1.150 ns
----------------------------------	----------

After long term use with 100W radiated power, only a slight warming of the dipole near the feedpoint can be measured.

The dipole is made of standard semirigid coaxial cable. The center conductor of the feeding line is directly connected to the second arm of the dipole. The antenna is therefore short-circuited for DC-signals. On some of the dipoles, small end caps are added to the dipole arms in order to improve matching when loaded according to the position as explained in the "Measurement Conditions" paragraph. The SAR data are not affected by this change. The overall dipole length is still according to the Standard.

No excessive force must be applied to the dipole arms, because they might bend or the soldered connections near the feedpoint may be damaged.

Additional EUT Data

Manufactured by	SPEAG
-----------------	-------

DASY5 Validation Report for Head TSL

Date: 14.06.2019

Test Laboratory: SPEAG, Zurich, Switzerland

DUT: Dipole 2600 MHz; Type: D2600V2; Serial: D2600V2 - SN:1042

Communication System: UID 0 - CW; Frequency: 2600 MHz

Medium parameters used: $f = 2600$ MHz; $\sigma = 2.03$ S/m; $\epsilon_r = 37.3$; $\rho = 1000$ kg/m³

Phantom section: Flat Section

Measurement Standard: DASY5 (IEEE/IEC/ANSI C63.19-2011)

DASY52 Configuration:

- Probe: EX3DV4 - SN7349; ConvF(7.69, 7.69, 7.69) @ 2600 MHz; Calibrated: 29.05.2019
- Sensor-Surface: 1.4mm (Mechanical Surface Detection)
- Electronics: DAE4 Sn601; Calibrated: 30.04.2019
- Phantom: Flat Phantom 5.0 (front); Type: QD 000 P50 AA; Serial: 1001
- DASY52 52.10.2(1504); SEMCAD X 14.6.12(7470)

Dipole Calibration for Head Tissue/Pin=250 mW, d=10mm/Zoom Scan (7x7x7)/Cube 0:

Measurement grid: dx=5mm, dy=5mm, dz=5mm

Reference Value = 120.0 V/m; Power Drift = 0.04 dB

Peak SAR (extrapolated) = 29.9 W/kg

SAR(1 g) = 14.8 W/kg; SAR(10 g) = 6.57 W/kg

Maximum value of SAR (measured) = 24.8 W/kg

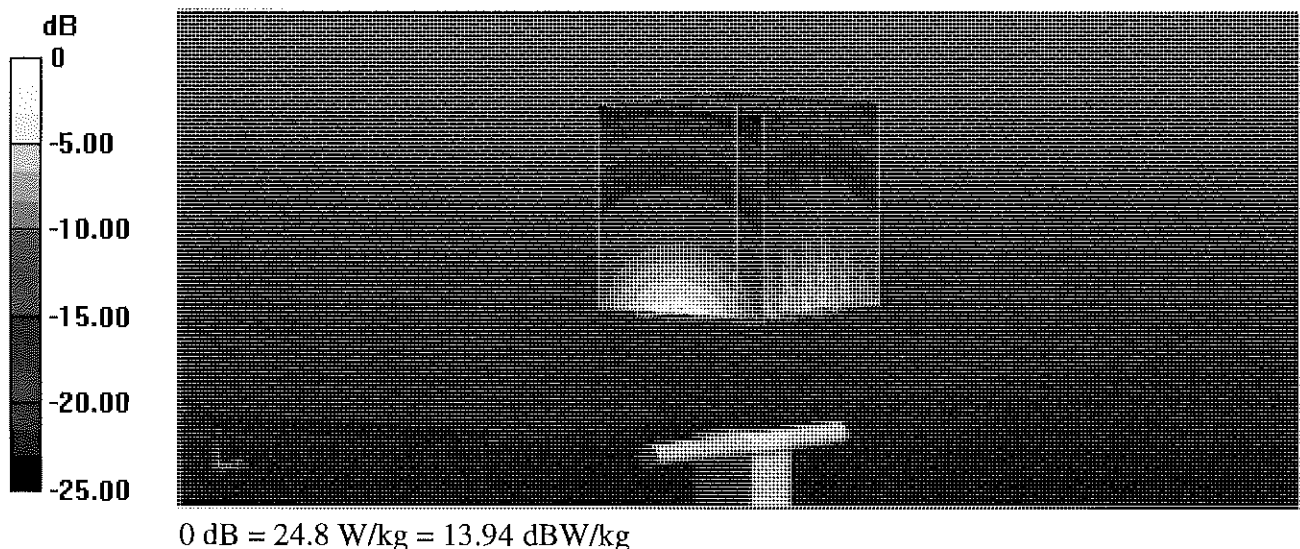

Impedance Measurement Plot for Head TSL

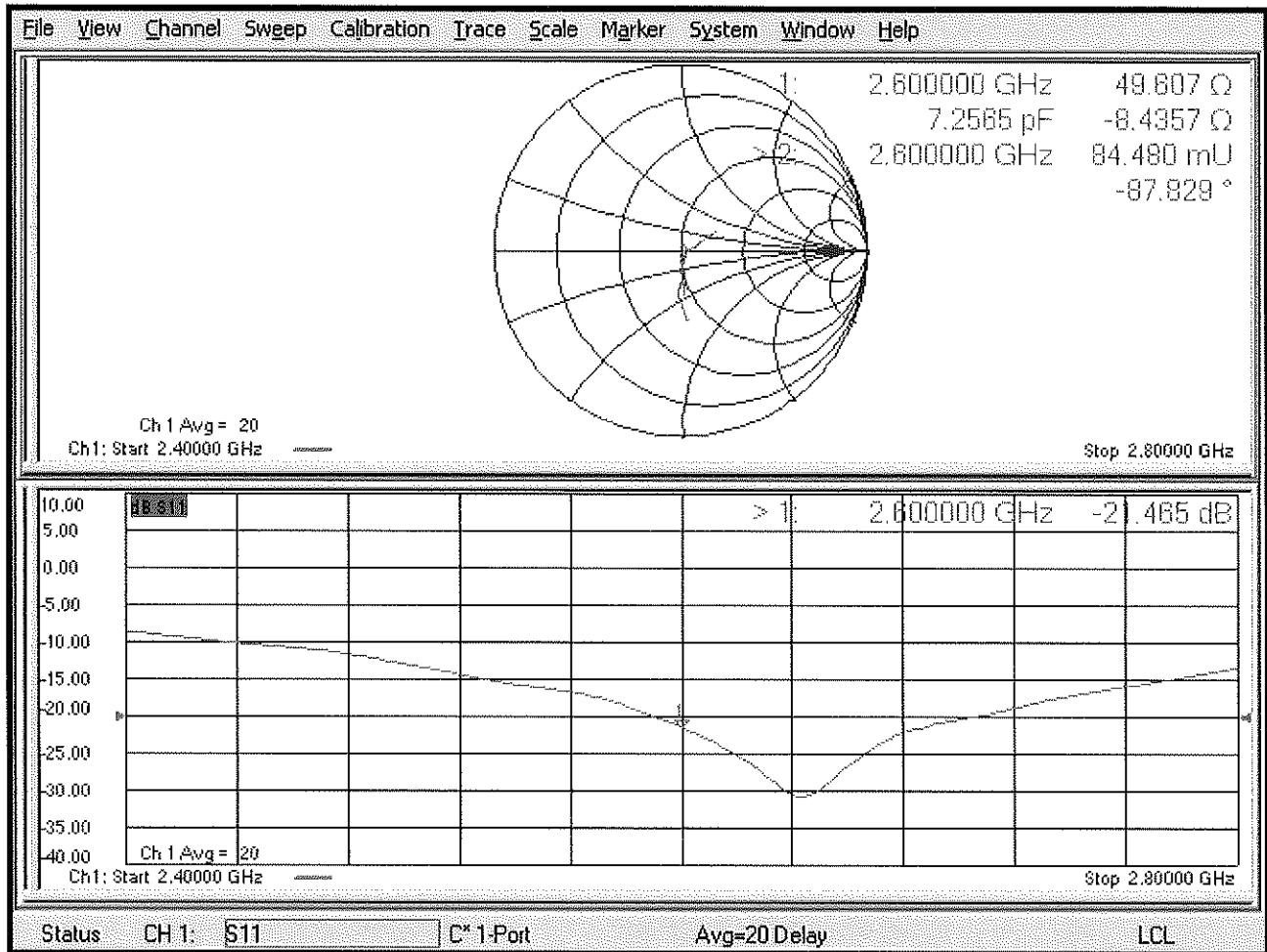

DASY5 Validation Report for Body TSL

Date: 14.06.2019

Test Laboratory: SPEAG, Zurich, Switzerland

DUT: Dipole 2600 MHz; Type: D2600V2; Serial: D2600V2 - SN:1042

Communication System: UID 0 - CW; Frequency: 2600 MHz

Medium parameters used: $f = 2600$ MHz; $\sigma = 2.22$ S/m; $\epsilon_r = 50.5$; $\rho = 1000$ kg/m³

Phantom section: Flat Section

Measurement Standard: DASY5 (IEEE/IEC/ANSI C63.19-2011)

DASY52 Configuration:

- Probe: EX3DV4 - SN7349; ConvF(7.8, 7.8, 7.8) @ 2600 MHz; Calibrated: 29.05.2019
- Sensor-Surface: 1.4mm (Mechanical Surface Detection)
- Electronics: DAE4 Sn601; Calibrated: 30.04.2019
- Phantom: Flat Phantom 5.0 (back); Type: QD 000 P50 AA; Serial: 1002
- DASY52 52.10.2(1504); SEMCAD X 14.6.12(7470)

Dipole Calibration for Body Tissue/Pin=250 mW, d=10mm/Zoom Scan (7x7x7)/Cube 0:

Measurement grid: dx=5mm, dy=5mm, dz=5mm

Reference Value = 110.3 V/m; Power Drift = -0.03 dB

Peak SAR (extrapolated) = 28.9 W/kg

SAR(1 g) = 14.1 W/kg; SAR(10 g) = 6.3 W/kg

Maximum value of SAR (measured) = 23.7 W/kg

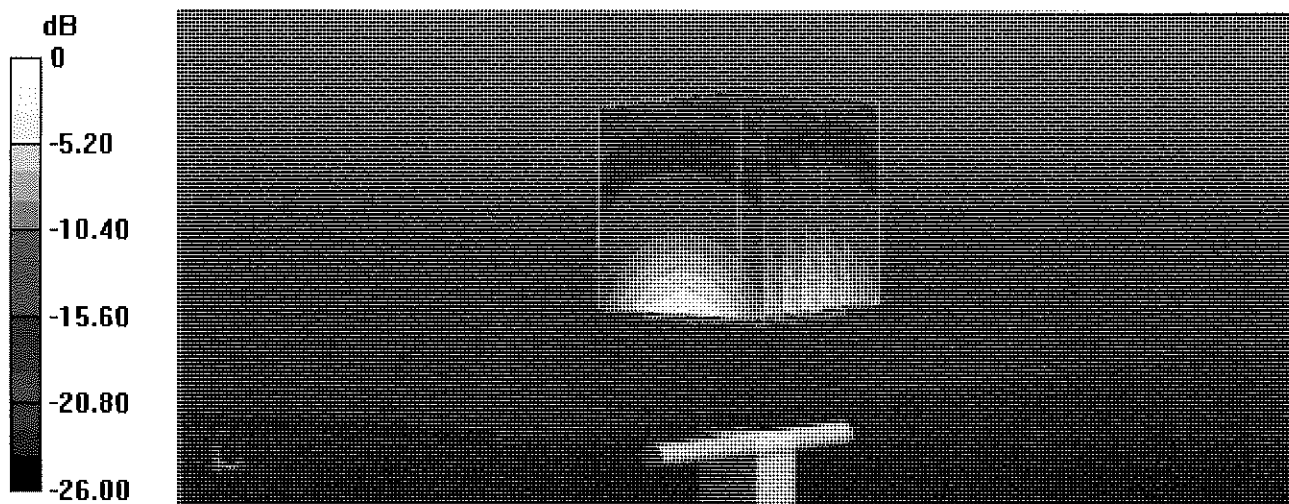

Impedance Measurement Plot for Body TSL

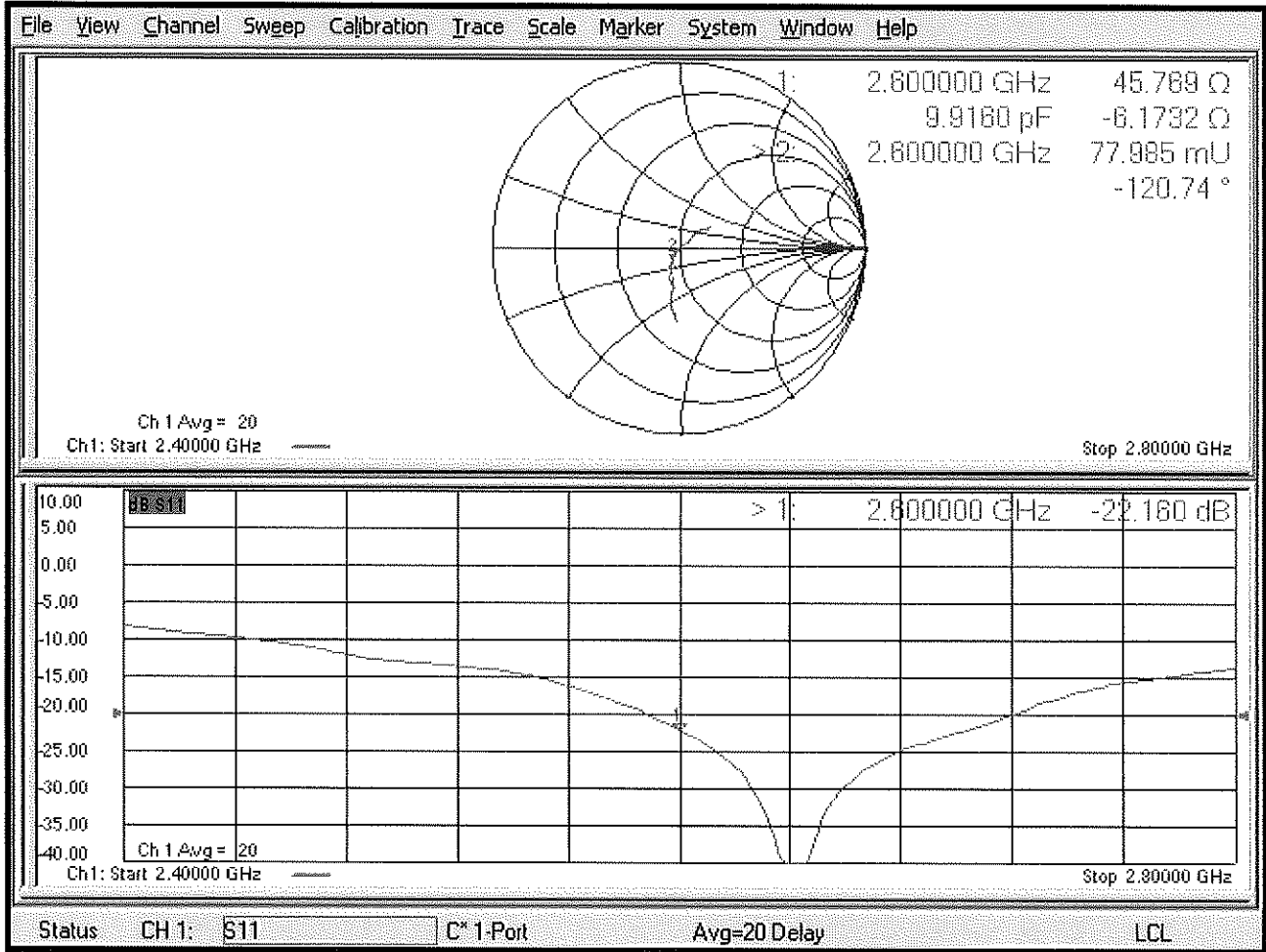

Certification of Calibration

Object: D2600V2 – SN: 1042

Calibration procedure(s): Procedure for Calibration Extension for SAR Dipoles.

Extended Calibration date: June 14, 2020

Description: SAR Validation Dipole at 2600 MHz.

Calibration Equipment used:

Manufacturer	Model	Description	Cal Date	Cal Interval	Cal Due	Serial Number
Agilent	8753ES	S-Parameter Network Analyzer	1/16/2020	Annual	1/16/2021	US39170118
Agilent	N5182A	MXG Vector Signal Generator	8/19/2019	Annual	8/19/2020	MY47420837
Amplifier Research	15S1G6	Amplifier	CBT	N/A	CBT	343972
Anritsu	MA2411B	Pulse Power Sensor	1/21/2020	Annual	1/21/2021	1207470
Anritsu	MA2411B	Pulse Power Sensor	1/21/2020	Annual	1/21/2021	1339007
Anritsu	ML2495A	Power Meter	1/15/2020	Annual	1/15/2021	1328004
Control Company	62344-734	Therm./ Clock/ Humidity Monitor	3/18/2019	Biennial	3/18/2021	192038436
Control Company	4352	Ultra Long Stem Thermometer	8/2/2018	Biennial	8/2/2020	181292000
Keysight	772D	Dual Directional Coupler	CBT	N/A	CBT	MY52180215
Keysight Technologies	85033E	Standard Mechanical Calibration Kit (DC to 9GHz, 3.5mm)	7/2/2019	Annual	7/2/2020	MY53401181
MiniCircuits	VLF-6000+	Low Pass Filter	CBT	N/A	CBT	N/A
Mini-Circuits	BW-N20W5+	DC to 18 GHz Precision Fixed 20 dB Attenuator	CBT	N/A	CBT	N/A
Narda	4772-3	Attenuator (3dB)	CBT	N/A	CBT	9406
Seekonk	NC-100	Torque Wrench	7/18/2019	Annual	7/18/2020	N/A
SPEAG	DAE4	Dasy Data Acquisition Electronics	1/14/2020	Annual	1/14/2021	793
SPEAG	DAE4	Dasy Data Acquisition Electronics	8/12/2019	Annual	8/12/2020	1408
SPEAG	DAK-3.5	Dielectric Assessment Kit	5/12/2020	Annual	5/12/2021	1070
SPEAG	EX3DV4	SAR Probe	1/20/2020	Annual	1/20/2021	3837
SPEAG	EX3DV4	SAR Probe	8/29/2019	Annual	8/29/2020	3949

Measurement Uncertainty = $\pm 23\%$ (k=2)

	Name	Function	Signature
Calibrated By:	Parker Jones	Team Lead Engineer	<i>Parker Jones</i>
Approved By:	Kaitlin O'Keefe	Managing Director	<i>KOK</i>

DIPOLE CALIBRATION EXTENSION

Per KDB 865664 D01, calibration intervals of up to three years may be considered for reference dipoles when it is demonstrated that the SAR target, impedance and return loss of a dipole have remained stable according to the following requirements:

1. The measured SAR does not deviate more than 10% from the target on the calibration certificate.
2. The return-loss does not deviate more than 20% from the previous measurement and meets the required 20dB minimum return-loss requirement.
3. The measurement of real or imaginary parts of impedance does not deviate more than 5Ω from the previous measurement.

The following dipole was checked to pass the above 3 requirements to have 2-year calibration period from the calibration date:

Calibration Date	Extension Date	Certificate Electrical Delay (ns)	Certificate SAR Target Head (1g) W/kg @ 20.0 dBm	Measured Head SAR (1g) W/kg @ 20.0 dBm	Deviation 1g (%)	Certificate SAR Target Head (10g) W/kg @ 20.0 dBm	Measured Head SAR (10g) W/kg @ 20.0 dBm	Deviation 10g (%)	Certificate Impedance Head (Ohm) Real	Measured Impedance Head (Ohm) Real	Difference (Ohm) Real	Certificate Impedance Head (Ohm) Imaginary	Measured Impedance Head (Ohm) Imaginary	Difference (Ohm) Imaginary	Certificate Return Loss Head (dB)	Measured Return Loss Head (dB)	Deviation (%)	PASS/FAIL
6/14/2019	6/14/2020	1.15	5.77	6.11	5.88%	2.59	2.75	6.18%	49.6	45.4	4.2	-8.4	-8.3	2.1	-21.5	-21.7	-0.90%	PASS
Calibration Date	Extension Date	Certificate Electrical Delay (ns)	Certificate SAR Target Body (1g) W/kg @ 20.0 dBm	Measured Body SAR (1g) W/kg @ 20.0 dBm	Deviation 1g (%)	Certificate SAR Target Body (10g) W/kg @ 20.0 dBm	Measured Body SAR (10g) W/kg @ 20.0 dBm	Deviation 10g (%)	Certificate Impedance Body (Ohm) Real	Measured Impedance Body (Ohm) Real	Difference (Ohm) Real	Certificate Impedance Body (Ohm) Imaginary	Measured Impedance Body (Ohm) Imaginary	Difference (Ohm) Imaginary	Certificate Return Loss Body (dB)	Measured Return Loss Body (dB)	Deviation (%)	PASS/FAIL
6/14/2019	6/14/2020	1.15	5.52	5.85	5.98%	2.49	2.58	3.61%	45.8	44.8	1	-8.2	-4.4	1.8	-22.2	-22.7	-2.30%	PASS

Impedance & Return-Loss Measurement Plot for Head TSL

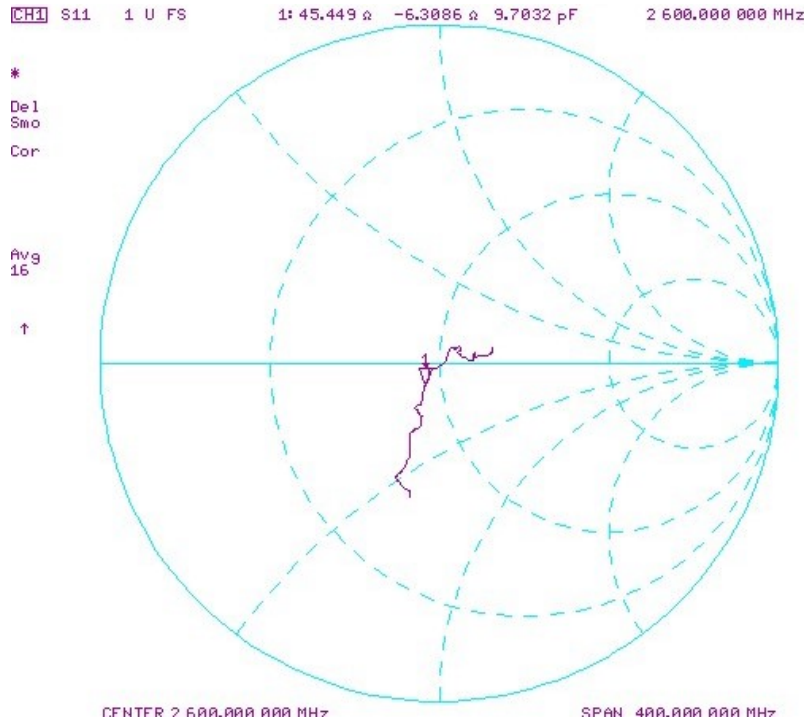

Impedance & Return-Loss Measurement Plot for Body TSL

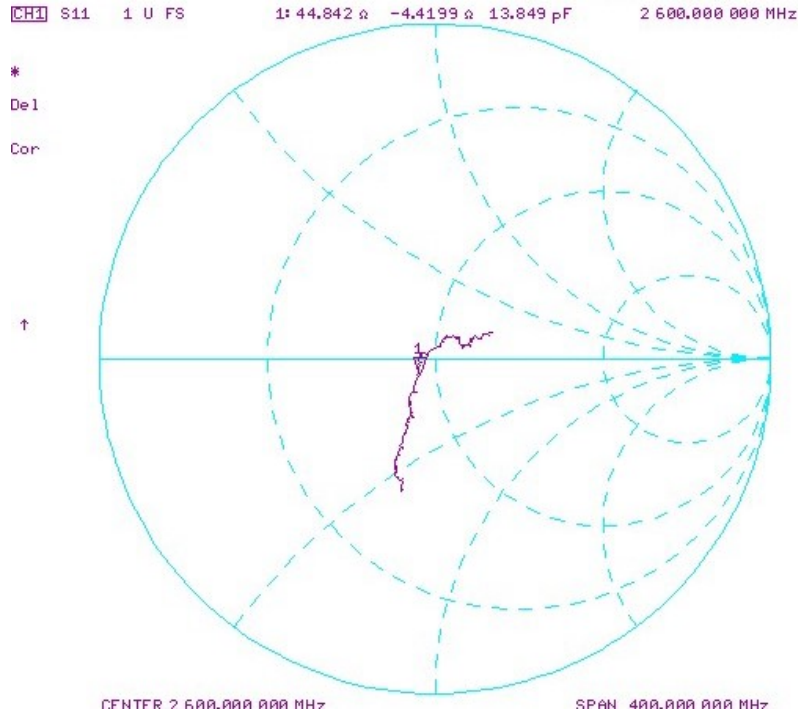



Accredited by the Swiss Accreditation Service (SAS)
The Swiss Accreditation Service is one of the signatories to the EA
Multilateral Agreement for the recognition of calibration certificates

Accreditation No.: **SCS 0108**

Client **PC Test**

Certificate No: **D5GHzV2-1120_Feb20**

CALIBRATION CERTIFICATE

Object **D5GHzV2 - SN:1120**

Calibration procedure(s) **QA CAL-22.v4
Calibration Procedure for SAR Validation Sources between 3-6 GHz**

Calibration date: **February 18, 2020** BN ✓
02-26-2020

This calibration certificate documents the traceability to national standards, which realize the physical units of measurements (SI).
The measurements and the uncertainties with confidence probability are given on the following pages and are part of the certificate.

All calibrations have been conducted in the closed laboratory facility: environment temperature (22 ± 3)°C and humidity < 70%.

Calibration Equipment used (M&TE critical for calibration)

Primary Standards	ID #	Cal Date (Certificate No.)	Scheduled Calibration
Power meter NRP	SN: 104778	03-Apr-19 (No. 217-02892/02893)	Apr-20
Power sensor NRP-Z91	SN: 103244	03-Apr-19 (No. 217-02892)	Apr-20
Power sensor NRP-Z91	SN: 103245	03-Apr-19 (No. 217-02893)	Apr-20
Reference 20 dB Attenuator	SN: 5058 (20k)	04-Apr-19 (No. 217-02894)	Apr-20
Type-N mismatch combination	SN: 5047.2 / 06327	04-Apr-19 (No. 217-02895)	Apr-20
Reference Probe EX3DV4	SN: 3503	31-Dec-19 (No. EX3-3503_Dec19)	Dec-20
DAE4	SN: 601	27-Dec-19 (No. DAE4-601_Dec19)	Dec-20
Secondary Standards	ID #	Check Date (in house)	Scheduled Check
Power meter E4419B	SN: GB39512475	30-Oct-14 (in house check Feb-19)	In house check: Oct-20
Power sensor HP 8481A	SN: US37292783	07-Oct-15 (in house check Oct-18)	In house check: Oct-20
Power sensor HP 8481A	SN: MY41092317	07-Oct-15 (in house check Oct-18)	In house check: Oct-20
RF generator R&S SMT-06	SN: 100972	15-Jun-15 (in house check Oct-18)	In house check: Oct-20
Network Analyzer Agilent E8358A	SN: US41080477	31-Mar-14 (in house check Oct-19)	In house check: Oct-20

Calibrated by:	Name Michael Weber	Function Laboratory Technician	Signature
Approved by:	Name Katja Pokovic	Technical Manager	

Issued: February 18, 2020

This calibration certificate shall not be reproduced except in full without written approval of the laboratory.



Accredited by the Swiss Accreditation Service (SAS)

The Swiss Accreditation Service is one of the signatories to the EA
Multilateral Agreement for the recognition of calibration certificates

Accreditation No.: **SCS 0108**

Glossary:

TSL	tissue simulating liquid
ConvF	sensitivity in TSL / NORM x,y,z
N/A	not applicable or not measured

Calibration is Performed According to the Following Standards:

- IEEE Std 1528-2013, "IEEE Recommended Practice for Determining the Peak Spatial-Averaged Specific Absorption Rate (SAR) in the Human Head from Wireless Communications Devices: Measurement Techniques", June 2013
- IEC 62209-1, "Measurement procedure for the assessment of Specific Absorption Rate (SAR) from hand-held and body-mounted devices used next to the ear (frequency range of 300 MHz to 6 GHz)", July 2016
- IEC 62209-2, "Procedure to determine the Specific Absorption Rate (SAR) for wireless communication devices used in close proximity to the human body (frequency range of 30 MHz to 6 GHz)", March 2010
- KDB 865664, "SAR Measurement Requirements for 100 MHz to 6 GHz"

Additional Documentation:

- DASY4/5 System Handbook

Methods Applied and Interpretation of Parameters:

- Measurement Conditions:** Further details are available from the Validation Report at the end of the certificate. All figures stated in the certificate are valid at the frequency indicated.
- Antenna Parameters with TSL:** The dipole is mounted with the spacer to position its feed point exactly below the center marking of the flat phantom section, with the arms oriented parallel to the body axis.
- Feed Point Impedance and Return Loss:** These parameters are measured with the dipole positioned under the liquid filled phantom. The impedance stated is transformed from the measurement at the SMA connector to the feed point. The Return Loss ensures low reflected power. No uncertainty required.
- Electrical Delay:** One-way delay between the SMA connector and the antenna feed point. No uncertainty required.
- SAR measured:** SAR measured at the stated antenna input power.
- SAR normalized:** SAR as measured, normalized to an input power of 1 W at the antenna connector.
- SAR for nominal TSL parameters:** The measured TSL parameters are used to calculate the nominal SAR result.

The reported uncertainty of measurement is stated as the standard uncertainty of measurement multiplied by the coverage factor $k=2$, which for a normal distribution corresponds to a coverage probability of approximately 95%.

Measurement Conditions

DASY system configuration, as far as not given on page 1.

DASY Version	DASY5	V52.10.4
Extrapolation	Advanced Extrapolation	
Phantom	Modular Flat Phantom V5.0	
Distance Dipole Center - TSL	10 mm	with Spacer
Zoom Scan Resolution	dx, dy = 4.0 mm, dz = 1.4 mm	Graded Ratio = 1.4 (Z direction)
Frequency	5250 MHz ± 1 MHz 5600 MHz ± 1 MHz 5750 MHz ± 1 MHz	

Head TSL parameters at 5250 MHz

The following parameters and calculations were applied.

	Temperature	Permittivity	Conductivity
Nominal Head TSL parameters	22.0 °C	35.9	4.71 mho/m
Measured Head TSL parameters	(22.0 ± 0.2) °C	35.0 ± 6 %	4.53 mho/m ± 6 %
Head TSL temperature change during test	< 0.5 °C	----	----

SAR result with Head TSL at 5250 MHz

SAR averaged over 1 cm³ (1 g) of Head TSL	Condition	
SAR measured	100 mW input power	8.08 W/kg
SAR for nominal Head TSL parameters	normalized to 1W	80.3 W/kg ± 19.9 % (k=2)

SAR averaged over 10 cm³ (10 g) of Head TSL	condition	
SAR measured	100 mW input power	2.31 W/kg
SAR for nominal Head TSL parameters	normalized to 1W	22.9 W/kg ± 19.5 % (k=2)

Head TSL parameters at 5600 MHz

The following parameters and calculations were applied.

	Temperature	Permittivity	Conductivity
Nominal Head TSL parameters	22.0 °C	35.5	5.07 mho/m
Measured Head TSL parameters	(22.0 ± 0.2) °C	34.5 ± 6 %	4.88 mho/m ± 6 %
Head TSL temperature change during test	< 0.5 °C	----	----

SAR result with Head TSL at 5600 MHz

SAR averaged over 1 cm ³ (1 g) of Head TSL	Condition	
SAR measured	100 mW input power	8.42 W/kg
SAR for nominal Head TSL parameters	normalized to 1W	83.6 W/kg ± 19.9 % (k=2)

SAR averaged over 10 cm ³ (10 g) of Head TSL	condition	
SAR measured	100 mW input power	2.40 W/kg
SAR for nominal Head TSL parameters	normalized to 1W	23.8 W/kg ± 19.5 % (k=2)

Head TSL parameters at 5750 MHz

The following parameters and calculations were applied.

	Temperature	Permittivity	Conductivity
Nominal Head TSL parameters	22.0 °C	35.4	5.22 mho/m
Measured Head TSL parameters	(22.0 ± 0.2) °C	34.3 ± 6 %	5.03 mho/m ± 6 %
Head TSL temperature change during test	< 0.5 °C	----	----

SAR result with Head TSL at 5750 MHz

SAR averaged over 1 cm ³ (1 g) of Head TSL	Condition	
SAR measured	100 mW input power	8.10 W/kg
SAR for nominal Head TSL parameters	normalized to 1W	80.4 W/kg ± 19.9 % (k=2)

SAR averaged over 10 cm ³ (10 g) of Head TSL	condition	
SAR measured	100 mW input power	2.29 W/kg
SAR for nominal Head TSL parameters	normalized to 1W	22.7 W/kg ± 19.5 % (k=2)

Body TSL parameters at 5250 MHz

The following parameters and calculations were applied.

	Temperature	Permittivity	Conductivity
Nominal Body TSL parameters	22.0 °C	48.9	5.36 mho/m
Measured Body TSL parameters	(22.0 ± 0.2) °C	47.3 ± 6 %	5.52 mho/m ± 6 %
Body TSL temperature change during test	< 0.5 °C	----	----

SAR result with Body TSL at 5250 MHz

SAR averaged over 1 cm ³ (1 g) of Body TSL	Condition	
SAR measured	100 mW input power	7.52 W/kg
SAR for nominal Body TSL parameters	normalized to 1W	74.8 W/kg ± 19.9 % (k=2)

SAR averaged over 10 cm ³ (10 g) of Body TSL	condition	
SAR measured	100 mW input power	2.10 W/kg
SAR for nominal Body TSL parameters	normalized to 1W	20.9 W/kg ± 19.5 % (k=2)

Body TSL parameters at 5600 MHz

The following parameters and calculations were applied.

	Temperature	Permittivity	Conductivity
Nominal Body TSL parameters	22.0 °C	48.5	5.77 mho/m
Measured Body TSL parameters	(22.0 ± 0.2) °C	46.7 ± 6 %	5.99 mho/m ± 6 %
Body TSL temperature change during test	< 0.5 °C	----	----

SAR result with Body TSL at 5600 MHz

SAR averaged over 1 cm ³ (1 g) of Body TSL	Condition	
SAR measured	100 mW input power	7.84 W/kg
SAR for nominal Body TSL parameters	normalized to 1W	78.0 W/kg ± 19.9 % (k=2)

SAR averaged over 10 cm ³ (10 g) of Body TSL	condition	
SAR measured	100 mW input power	2.18 W/kg
SAR for nominal Body TSL parameters	normalized to 1W	21.6 W/kg ± 19.5 % (k=2)

Body TSL parameters at 5750 MHz

The following parameters and calculations were applied.

	Temperature	Permittivity	Conductivity
Nominal Body TSL parameters	22.0 °C	48.3	5.94 mho/m
Measured Body TSL parameters	(22.0 ± 0.2) °C	46.4 ± 6 %	6.20 mho/m ± 6 %
Body TSL temperature change during test	< 0.5 °C	----	----

SAR result with Body TSL at 5750 MHz

SAR averaged over 1 cm ³ (1 g) of Body TSL	Condition	
SAR measured	100 mW input power	7.54 W/kg
SAR for nominal Body TSL parameters	normalized to 1W	75.0 W/kg ± 19.9 % (k=2)

SAR averaged over 10 cm ³ (10 g) of Body TSL	condition	
SAR measured	100 mW input power	2.11 W/kg
SAR for nominal Body TSL parameters	normalized to 1W	20.9 W/kg ± 19.5 % (k=2)

Appendix (Additional assessments outside the scope of SCS 0108)

Antenna Parameters with Head TSL at 5250 MHz

Impedance, transformed to feed point	52.0 Ω - 3.2 j Ω
Return Loss	- 28.5 dB

Antenna Parameters with Head TSL at 5600 MHz

Impedance, transformed to feed point	57.8 Ω - 2.0 j Ω
Return Loss	- 22.5 dB

Antenna Parameters with Head TSL at 5750 MHz

Impedance, transformed to feed point	54.7 Ω + 3.8 j Ω
Return Loss	- 24.8 dB

Antenna Parameters with Body TSL at 5250 MHz

Impedance, transformed to feed point	52.4 Ω - 0.7 j Ω
Return Loss	- 32.4 dB

Antenna Parameters with Body TSL at 5600 MHz

Impedance, transformed to feed point	58.4 Ω - 0.9 j Ω
Return Loss	- 22.2 dB

Antenna Parameters with Body TSL at 5750 MHz

Impedance, transformed to feed point	55.8 Ω + 4.1 j Ω
Return Loss	- 23.5 dB

General Antenna Parameters and Design

Electrical Delay (one direction)	1.204 ns
----------------------------------	----------

After long term use with 100W radiated power, only a slight warming of the dipole near the feedpoint can be measured.

The dipole is made of standard semirigid coaxial cable. The center conductor of the feeding line is directly connected to the second arm of the dipole. The antenna is therefore short-circuited for DC-signals. On some of the dipoles, small end caps are added to the dipole arms in order to improve matching when loaded according to the position as explained in the "Measurement Conditions" paragraph. The SAR data are not affected by this change. The overall dipole length is still according to the Standard.

No excessive force must be applied to the dipole arms, because they might bend or the soldered connections near the feedpoint may be damaged.

Additional EUT Data

Manufactured by	SPEAG
-----------------	-------

DASY5 Validation Report for Head TSL

Date: 17.02.2020

Test Laboratory: SPEAG, Zurich, Switzerland

DUT: Dipole D5GHzV2; Type: D5GHzV2; Serial: D5GHzV2 - SN: 1120

Communication System: UID 0 - CW; Frequency: 5250 MHz, Frequency: 5600 MHz, Frequency: 5750 MHz

Medium parameters used: $f = 5250$ MHz; $\sigma = 4.53$ S/m; $\epsilon_r = 35$; $\rho = 1000$ kg/m³,

Medium parameters used: $f = 5600$ MHz; $\sigma = 4.88$ S/m; $\epsilon_r = 34.5$; $\rho = 1000$ kg/m³,

Medium parameters used: $f = 5750$ MHz; $\sigma = 5.03$ S/m; $\epsilon_r = 34.3$; $\rho = 1000$ kg/m³

Phantom section: Flat Section

Measurement Standard: DASY5 (IEEE/IEC/ANSI C63.19-2011)

DASY52 Configuration:

- Probe: EX3DV4 - SN3503; ConvF(5.5, 5.5, 5.5) @ 5250 MHz, ConvF(5.1, 5.1, 5.1) @ 5600 MHz, ConvF(5.08, 5.08, 5.08) @ 5750 MHz; Calibrated: 31.12.2019
- Sensor-Surface: 1.4mm (Mechanical Surface Detection)
- Electronics: DAE4 Sn601; Calibrated: 27.12.2019
- Phantom: Flat Phantom 5.0 (front); Type: QD 000 P50 AA; Serial: 1001
- DASY52 52.10.4(1527); SEMCAD X 14.6.14(7483)

Dipole Calibration for Head Tissue/Pin=100mW, dist=10mm, f=5250 MHz/Zoom Scan,

dist=1.4mm (8x8x8)/Cube 0: Measurement grid: dx=4mm, dy=4mm, dz=1.4mm

Reference Value = 77.59 V/m; Power Drift = 0.04 dB

Peak SAR (extrapolated) = 28.2 W/kg

SAR(1 g) = 8.08 W/kg; SAR(10 g) = 2.31 W/kg

Smallest distance from peaks to all points 3 dB below = 7.4 mm

Ratio of SAR at M2 to SAR at M1 = 69.5%

Maximum value of SAR (measured) = 18.7 W/kg

Dipole Calibration for Head Tissue/Pin=100mW, dist=10mm, f=5600 MHz/Zoom Scan,

dist=1.4mm (8x8x8)/Cube 0: Measurement grid: dx=4mm, dy=4mm, dz=1.4mm

Reference Value = 77.23 V/m; Power Drift = -0.01 dB

Peak SAR (extrapolated) = 32.0 W/kg

SAR(1 g) = 8.42 W/kg; SAR(10 g) = 2.4 W/kg

Smallest distance from peaks to all points 3 dB below = 7.4 mm

Ratio of SAR at M2 to SAR at M1 = 66.7%

Maximum value of SAR (measured) = 20.2 W/kg

Dipole Calibration for Head Tissue/Pin=100mW, dist=10mm, f=5750 MHz/Zoom Scan,

dist=1.4mm (8x8x8)/Cube 0: Measurement grid: dx=4mm, dy=4mm, dz=1.4mm

Reference Value = 74.96 V/m; Power Drift = 0.01 dB

Peak SAR (extrapolated) = 32.5 W/kg

SAR(1 g) = 8.1 W/kg; SAR(10 g) = 2.29 W/kg

Smallest distance from peaks to all points 3 dB below = 7.4 mm

Ratio of SAR at M2 to SAR at M1 = 65.1%

Maximum value of SAR (measured) = 19.8 W/kg

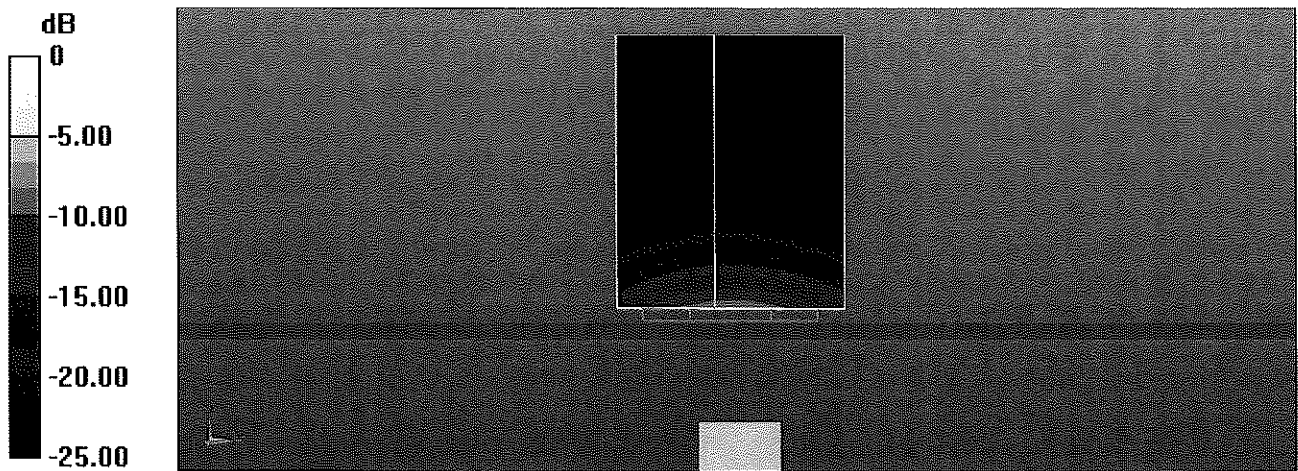

0 dB = 20.2 W/kg = 13.05 dBW/kg

Impedance Measurement Plot for Head TSL

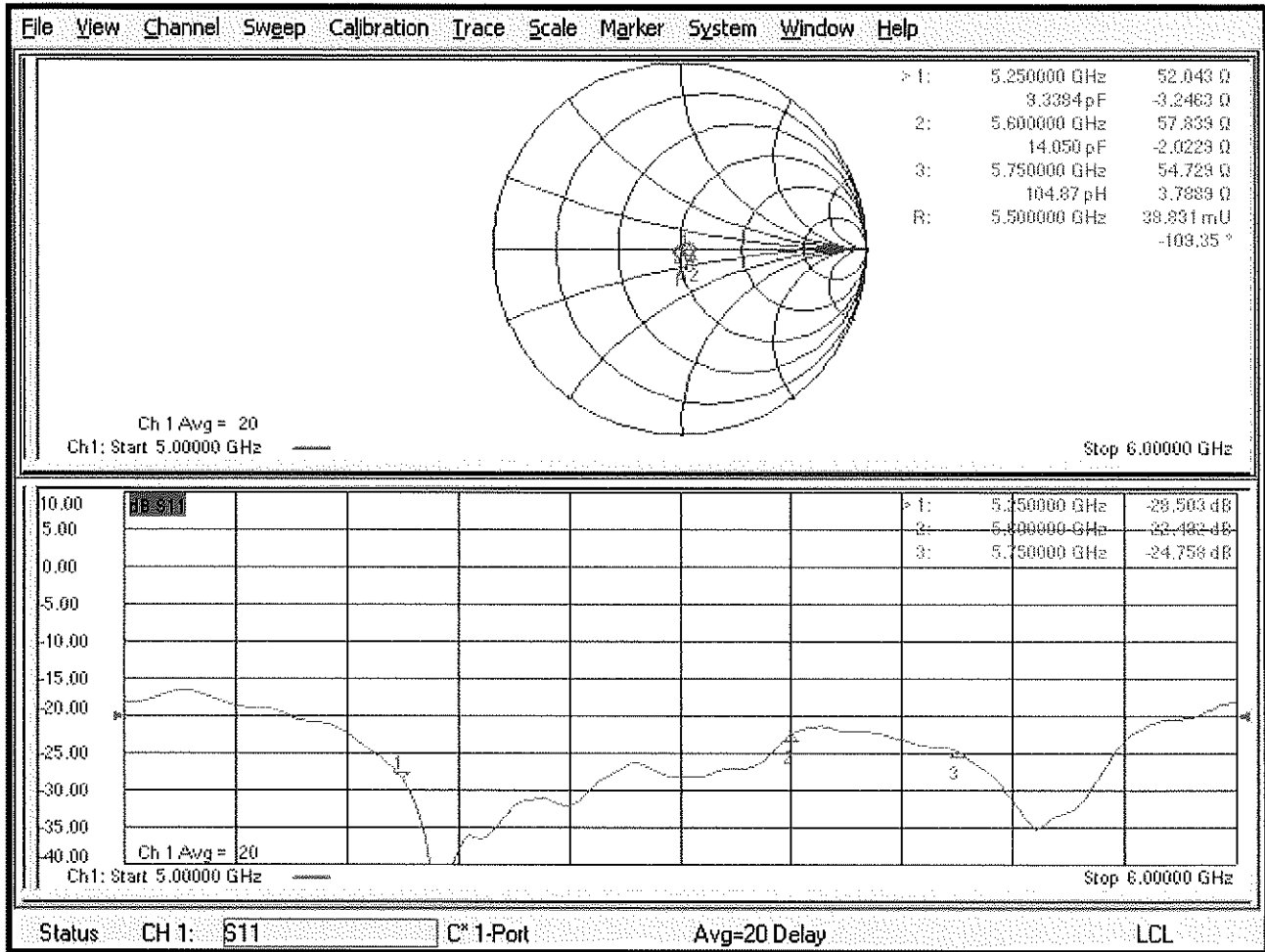

DASY5 Validation Report for Body TSL

Date: 18.02.2020

Test Laboratory: SPEAG, Zurich, Switzerland

DUT: Dipole D5GHzV2; Type: D5GHzV2; Serial: D5GHzV2 - SN:1120

Communication System: UID 0 - CW; Frequency: 5250 MHz, Frequency: 5600 MHz, Frequency: 5750 MHz

Medium parameters used: $f = 5250$ MHz; $\sigma = 5.52$ S/m; $\epsilon_r = 47.3$; $\rho = 1000$ kg/m³,

Medium parameters used: $f = 5600$ MHz; $\sigma = 5.99$ S/m; $\epsilon_r = 46.7$; $\rho = 1000$ kg/m³,

Medium parameters used: $f = 5750$ MHz; $\sigma = 6.2$ S/m; $\epsilon_r = 46.4$; $\rho = 1000$ kg/m³

Phantom section: Flat Section

Measurement Standard: DASY5 (IEEE/IEC/ANSI C63.19-2011)

DASY52 Configuration:

- Probe: EX3DV4 - SN3503; ConvF(5.26, 5.26, 5.26) @ 5250 MHz, ConvF(4.79, 4.79, 4.79) @ 5600 MHz, ConvF(4.66, 4.66, 4.66) @ 5750 MHz; Calibrated: 31.12.2019
- Sensor-Surface: 1.4mm (Mechanical Surface Detection)
- Electronics: DAE4 Sn601; Calibrated: 27.12.2019
- Phantom: Flat Phantom 5.0 (back); Type: QD 000 P50 AA; Serial: 1002
- DASY52 52.10.4(1527); SEMCAD X 14.6.14(7483)

Dipole Calibration for Body Tissue/Pin=100mW, dist=10mm, f=5250 MHz/Zoom Scan,

dist=1.4mm (8x8x8)/Cube 0: Measurement grid: dx=4mm, dy=4mm, dz=1.4mm

Reference Value = 67.21 V/m; Power Drift = -0.04 dB

Peak SAR (extrapolated) = 29.0 W/kg

SAR(1 g) = 7.52 W/kg; SAR(10 g) = 2.10 W/kg

Smallest distance from peaks to all points 3 dB below = 6.8 mm

Ratio of SAR at M2 to SAR at M1 = 66.9%

Maximum value of SAR (measured) = 17.4 W/kg

Dipole Calibration for Body Tissue/Pin=100mW, dist=10mm, f=5600 MHz/Zoom Scan,

dist=1.4mm (8x8x8)/Cube 0: Measurement grid: dx=4mm, dy=4mm, dz=1.4mm

Reference Value = 65.96 V/m; Power Drift = -0.09 dB

Peak SAR (extrapolated) = 33.6 W/kg

SAR(1 g) = 7.84 W/kg; SAR(10 g) = 2.18 W/kg

Smallest distance from peaks to all points 3 dB below = 7.2 mm

Ratio of SAR at M2 to SAR at M1 = 63.3%

Maximum value of SAR (measured) = 19.0 W/kg

Dipole Calibration for Body Tissue/Pin=100mW, dist=10mm, f=5750 MHz/Zoom Scan, dist=1.4mm (8x8x8)/Cube 0: Measurement grid: dx=4mm, dy=4mm, dz=1.4mm
Reference Value = 64.77 V/m; Power Drift = -0.07 dB
Peak SAR (extrapolated) = 33.6 W/kg
SAR(1 g) = 7.54 W/kg; SAR(10 g) = 2.11 W/kg
Smallest distance from peaks to all points 3 dB below = 7.2 mm
Ratio of SAR at M2 to SAR at M1 = 61.9%
Maximum value of SAR (measured) = 18.6 W/kg

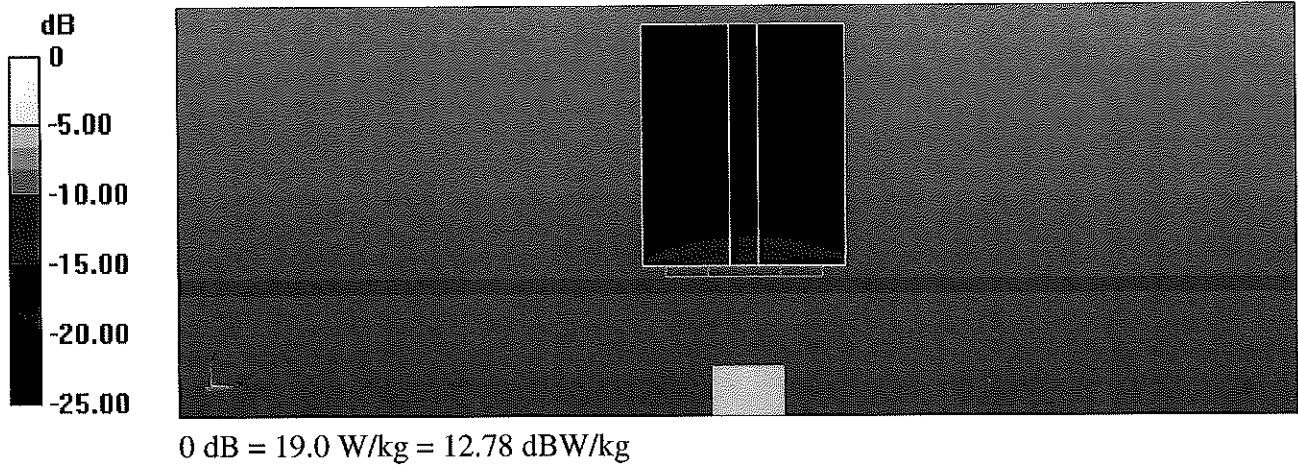

Impedance Measurement Plot for Body TSL

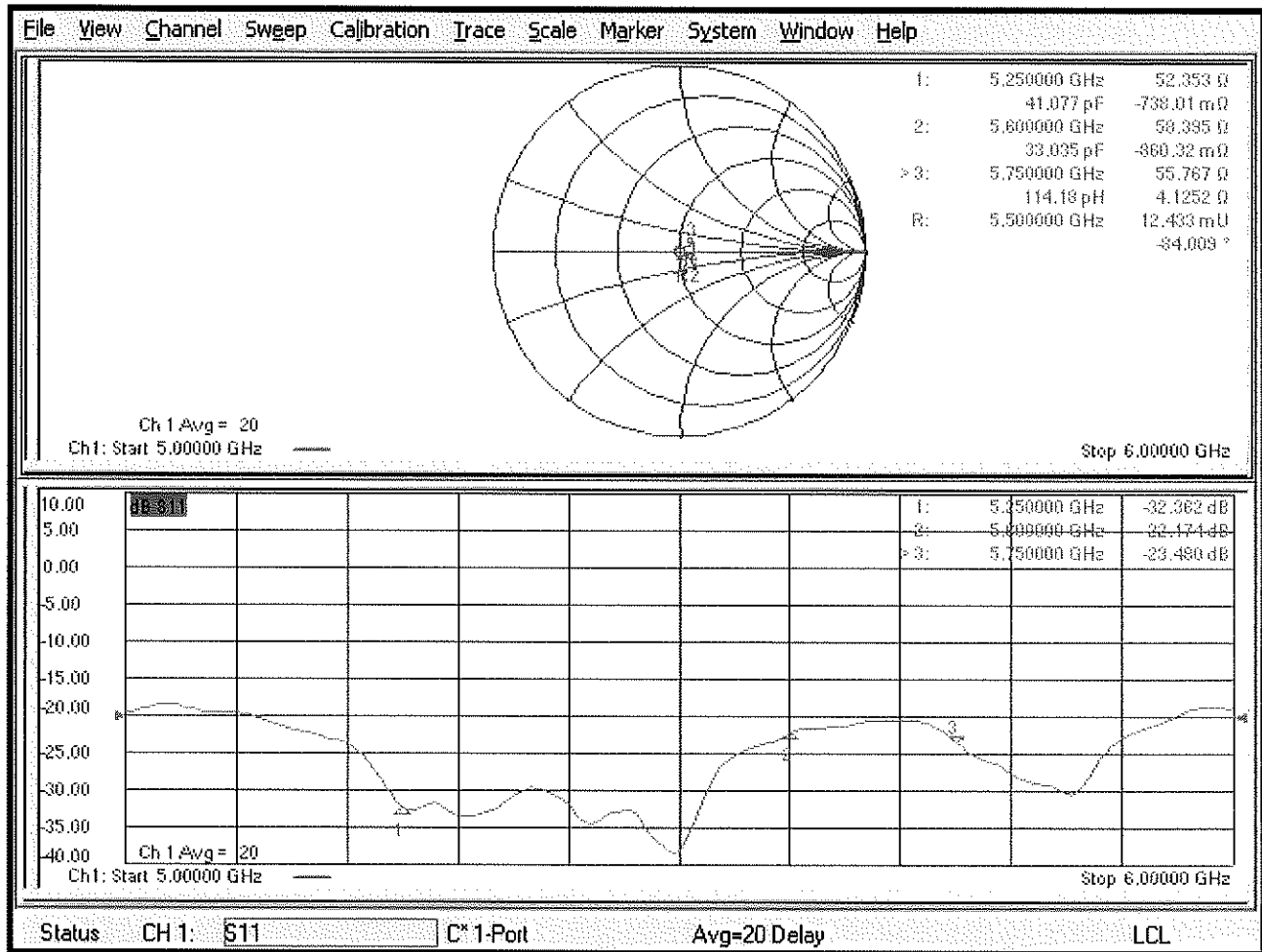



Accredited by the Swiss Accreditation Service (SAS)
The Swiss Accreditation Service is one of the signatories to the EA
Multilateral Agreement for the recognition of calibration certificates

Accreditation No.: **SCS 0108**

Client **PC Test**

Certificate No: **D1900V2-5d180_Aug20**

CALIBRATION CERTIFICATE

Object **D1900V2 - SN:5d180**

✓
9/9/20 ATM

Calibration procedure(s) **QA CAL-05.v11
Calibration Procedure for SAR Validation Sources between 0.7-3 GHz**

Calibration date: **August 10, 2020**

This calibration certificate documents the traceability to national standards, which realize the physical units of measurements (SI).
The measurements and the uncertainties with confidence probability are given on the following pages and are part of the certificate.

All calibrations have been conducted in the closed laboratory facility: environment temperature (22 ± 3)°C and humidity < 70%.

Calibration Equipment used (M&TE critical for calibration)

Primary Standards	ID #	Cal Date (Certificate No.)	Scheduled Calibration
Power meter NRP	SN: 104778	01-Apr-20 (No. 217-03100/03101)	Apr-21
Power sensor NRP-Z91	SN: 103244	01-Apr-20 (No. 217-03100)	Apr-21
Power sensor NRP-Z91	SN: 103245	01-Apr-20 (No. 217-03101)	Apr-21
Reference 20 dB Attenuator	SN: BH9394 (20k)	31-Mar-20 (No. 217-03106)	Apr-21
Type-N mismatch combination	SN: 310982 / 06327	31-Mar-20 (No. 217-03104)	Apr-21
Reference Probe EX3DV4	SN: 7349	29-Jun-20 (No. EX3-7349_Jun20)	Jun-21
DAE4	SN: 601	27-Dec-19 (No. DAE4-601_Dec19)	Dec-20

Secondary Standards	ID #	Check Date (in house)	Scheduled Check
Power meter E4419B	SN: GB39512475	30-Oct-14 (in house check Feb-19)	In house check: Oct-20
Power sensor HP 8481A	SN: US37292783	07-Oct-15 (in house check Oct-18)	In house check: Oct-20
Power sensor HP 8481A	SN: MY41092317	07-Oct-15 (in house check Oct-18)	In house check: Oct-20
RF generator R&S SMT-06	SN: 100972	15-Jun-15 (in house check Oct-18)	In house check: Oct-20
Network Analyzer Agilent E8358A	SN: US41080477	31-Mar-14 (in house check Oct-19)	In house check: Oct-20

Calibrated by: **Jeffrey Katzman** **Jeffrey Katzman** **Laboratory Technician**

Signature

Approved by: **Katja Pokovic** **Katja Pokovic** **Technical Manager**

Issued: August 11, 2020

This calibration certificate shall not be reproduced except in full without written approval of the laboratory.



Accredited by the Swiss Accreditation Service (SAS)
The Swiss Accreditation Service is one of the signatories to the EA
Multilateral Agreement for the recognition of calibration certificates

Accreditation No.: **SCS 0108**

Glossary:

TSL	tissue simulating liquid
ConvF	sensitivity in TSL / NORM x,y,z
N/A	not applicable or not measured

Calibration is Performed According to the Following Standards:

- a) IEEE Std 1528-2013, "IEEE Recommended Practice for Determining the Peak Spatial-Averaged Specific Absorption Rate (SAR) in the Human Head from Wireless Communications Devices: Measurement Techniques", June 2013
- b) IEC 62209-1, "Measurement procedure for the assessment of Specific Absorption Rate (SAR) from hand-held and body-mounted devices used next to the ear (frequency range of 300 MHz to 6 GHz)", July 2016
- c) IEC 62209-2, "Procedure to determine the Specific Absorption Rate (SAR) for wireless communication devices used in close proximity to the human body (frequency range of 30 MHz to 6 GHz)", March 2010
- d) KDB 865664, "SAR Measurement Requirements for 100 MHz to 6 GHz"

Additional Documentation:

- e) DASY4/5 System Handbook

Methods Applied and Interpretation of Parameters:

- *Measurement Conditions:* Further details are available from the Validation Report at the end of the certificate. All figures stated in the certificate are valid at the frequency indicated.
- *Antenna Parameters with TSL:* The dipole is mounted with the spacer to position its feed point exactly below the center marking of the flat phantom section, with the arms oriented parallel to the body axis.
- *Feed Point Impedance and Return Loss:* These parameters are measured with the dipole positioned under the liquid filled phantom. The impedance stated is transformed from the measurement at the SMA connector to the feed point. The Return Loss ensures low reflected power. No uncertainty required.
- *Electrical Delay:* One-way delay between the SMA connector and the antenna feed point. No uncertainty required.
- *SAR measured:* SAR measured at the stated antenna input power.
- *SAR normalized:* SAR as measured, normalized to an input power of 1 W at the antenna connector.
- *SAR for nominal TSL parameters:* The measured TSL parameters are used to calculate the nominal SAR result.

The reported uncertainty of measurement is stated as the standard uncertainty of measurement multiplied by the coverage factor $k=2$, which for a normal distribution corresponds to a coverage probability of approximately 95%.

Measurement Conditions

DASY system configuration, as far as not given on page 1.

DASY Version	DASY5	V52.10.4
Extrapolation	Advanced Extrapolation	
Phantom	Modular Flat Phantom	
Distance Dipole Center - TSL	10 mm	with Spacer
Zoom Scan Resolution	dx, dy, dz = 5 mm	
Frequency	1900 MHz ± 1 MHz	

Head TSL parameters

The following parameters and calculations were applied.

	Temperature	Permittivity	Conductivity
Nominal Head TSL parameters	22.0 °C	40.0	1.40 mho/m
Measured Head TSL parameters	(22.0 ± 0.2) °C	41.2 ± 6 %	1.39 mho/m ± 6 %
Head TSL temperature change during test	< 0.5 °C	----	----

SAR result with Head TSL

SAR averaged over 1 cm³ (1 g) of Head TSL	Condition	
SAR measured	250 mW input power	9.84 W/kg
SAR for nominal Head TSL parameters	normalized to 1W	39.8 W/kg ± 17.0 % (k=2)

SAR averaged over 10 cm³ (10 g) of Head TSL	condition	
SAR measured	250 mW input power	5.16 W/kg
SAR for nominal Head TSL parameters	normalized to 1W	20.8 W/kg ± 16.5 % (k=2)

Body TSL parameters

The following parameters and calculations were applied.

	Temperature	Permittivity	Conductivity
Nominal Body TSL parameters	22.0 °C	53.3	1.52 mho/m
Measured Body TSL parameters	(22.0 ± 0.2) °C	53.9 ± 6 %	1.49 mho/m ± 6 %
Body TSL temperature change during test	< 0.5 °C	----	----

SAR result with Body TSL

SAR averaged over 1 cm³ (1 g) of Body TSL	Condition	
SAR measured	250 mW input power	9.60 W/kg
SAR for nominal Body TSL parameters	normalized to 1W	39.0 W/kg ± 17.0 % (k=2)

SAR averaged over 10 cm³ (10 g) of Body TSL	condition	
SAR measured	250 mW input power	5.10 W/kg
SAR for nominal Body TSL parameters	normalized to 1W	20.6 W/kg ± 16.5 % (k=2)

Appendix (Additional assessments outside the scope of SCS 0108)

Antenna Parameters with Head TSL

Impedance, transformed to feed point	52.8 Ω + 5.6 j Ω
Return Loss	- 24.3 dB

Antenna Parameters with Body TSL

Impedance, transformed to feed point	48.1 Ω + 5.9 j Ω
Return Loss	- 24.0 dB

General Antenna Parameters and Design

Electrical Delay (one direction)	1.203 ns
----------------------------------	----------

After long term use with 100W radiated power, only a slight warming of the dipole near the feedpoint can be measured.

The dipole is made of standard semirigid coaxial cable. The center conductor of the feeding line is directly connected to the second arm of the dipole. The antenna is therefore short-circuited for DC-signals. On some of the dipoles, small end caps are added to the dipole arms in order to improve matching when loaded according to the position as explained in the "Measurement Conditions" paragraph. The SAR data are not affected by this change. The overall dipole length is still according to the Standard.

No excessive force must be applied to the dipole arms, because they might bend or the soldered connections near the feedpoint may be damaged.

Additional EUT Data

Manufactured by	SPEAG
-----------------	-------

DASY5 Validation Report for Head TSL

Date: 10.08.2020

Test Laboratory: SPEAG, Zurich, Switzerland

DUT: Dipole 1900 MHz; Type: D1900V2; Serial: D1900V2 - SN:5d180

Communication System: UID 0 - CW; Frequency: 1900 MHz

Medium parameters used: $f = 1900 \text{ MHz}$; $\sigma = 1.39 \text{ S/m}$; $\epsilon_r = 41.2$; $\rho = 1000 \text{ kg/m}^3$

Phantom section: Flat Section

Measurement Standard: DASY5 (IEEE/IEC/ANSI C63.19-2011)

DASY52 Configuration:

- Probe: EX3DV4 - SN7349; ConvF(8.26, 8.26, 8.26) @ 1900 MHz; Calibrated: 29.06.2020
- Sensor-Surface: 1.4mm (Mechanical Surface Detection)
- Electronics: DAE4 Sn601; Calibrated: 27.12.2019
- Phantom: Flat Phantom 5.0 (front); Type: QD 000 P50 AA; Serial: 1001
- DASY52 52.10.4(1527); SEMCAD X 14.6.14(7483)

Dipole Calibration for Head Tissue/Pin=250 mW, d=10mm/Zoom Scan (7x7x7)/Cube 0:

Measurement grid: $dx=5\text{mm}$, $dy=5\text{mm}$, $dz=5\text{mm}$

Reference Value = 106.6 V/m; Power Drift = -0.09 dB

Peak SAR (extrapolated) = 18.1 W/kg

SAR(1 g) = 9.84 W/kg; SAR(10 g) = 5.16 W/kg

Smallest distance from peaks to all points 3 dB below = 10 mm

Ratio of SAR at M2 to SAR at M1 = 56%

Maximum value of SAR (measured) = 14.6 W/kg

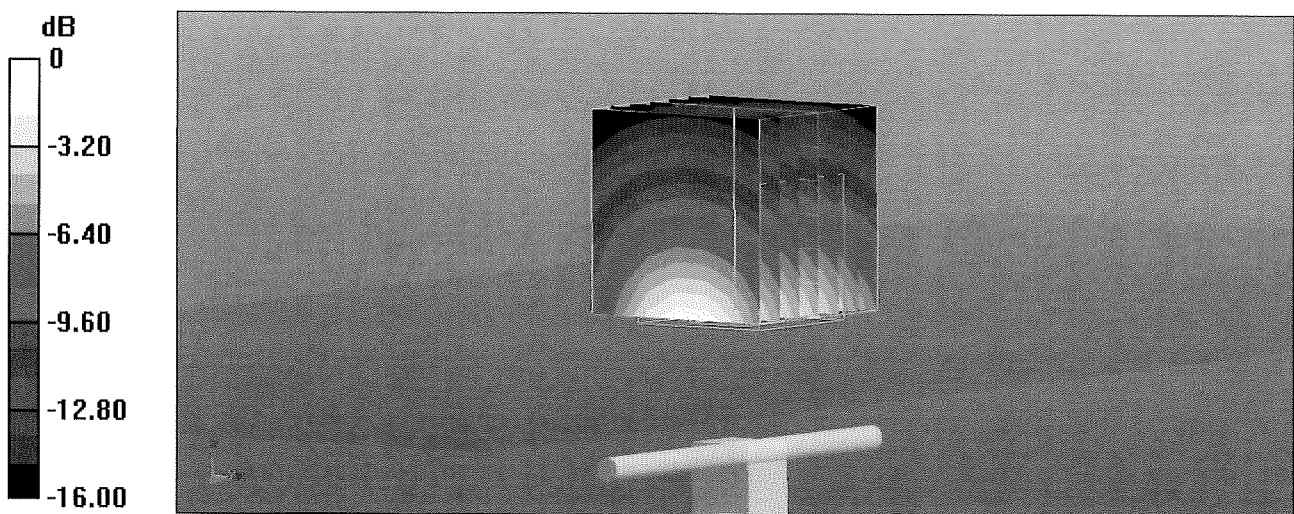

0 dB = 14.6 W/kg = 11.64 dBW/kg

Impedance Measurement Plot for Head TSL

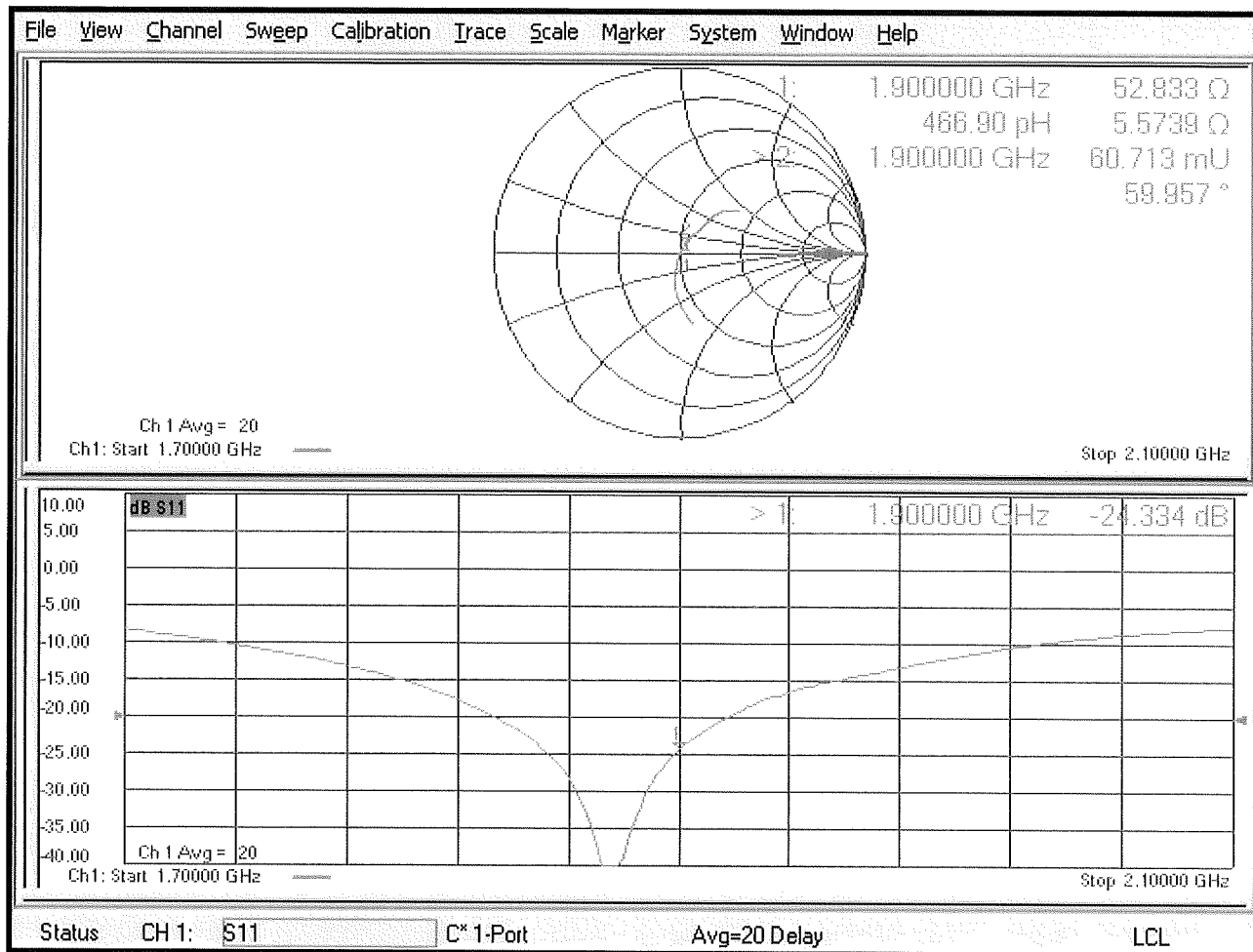

DASY5 Validation Report for Body TSL

Date: 10.08.2020

Test Laboratory: SPEAG, Zurich, Switzerland

DUT: Dipole 1900 MHz; Type: D1900V2; Serial: D1900V2 - SN:5d180

Communication System: UID 0 - CW; Frequency: 1900 MHz

Medium parameters used: $f = 1900$ MHz; $\sigma = 1.49$ S/m; $\epsilon_r = 53.9$; $\rho = 1000$ kg/m³

Phantom section: Flat Section

Measurement Standard: DASY5 (IEEE/IEC/ANSI C63.19-2011)

DASY52 Configuration:

- Probe: EX3DV4 - SN7349; ConvF(8.21, 8.21, 8.21) @ 1900 MHz; Calibrated: 29.06.2020
- Sensor-Surface: 1.4mm (Mechanical Surface Detection)
- Electronics: DAE4 Sn601; Calibrated: 27.12.2019
- Phantom: Flat Phantom 5.0 (back); Type: QD 000 P50 AA; Serial: 1002
- DASY52 52.10.4(1527); SEMCAD X 14.6.14(7483)

Dipole Calibration for Body Tissue/Pin=250 mW, d=10mm/Zoom Scan (7x7x7)/Cube 0:

Measurement grid: dx=5mm, dy=5mm, dz=5mm

Reference Value = 103.6 V/m; Power Drift = -0.08 dB

Peak SAR (extrapolated) = 16.7 W/kg

SAR(1 g) = 9.60 W/kg; SAR(10 g) = 5.10 W/kg

Smallest distance from peaks to all points 3 dB below = 9 mm

Ratio of SAR at M2 to SAR at M1 = 58.5%

Maximum value of SAR (measured) = 14.2 W/kg

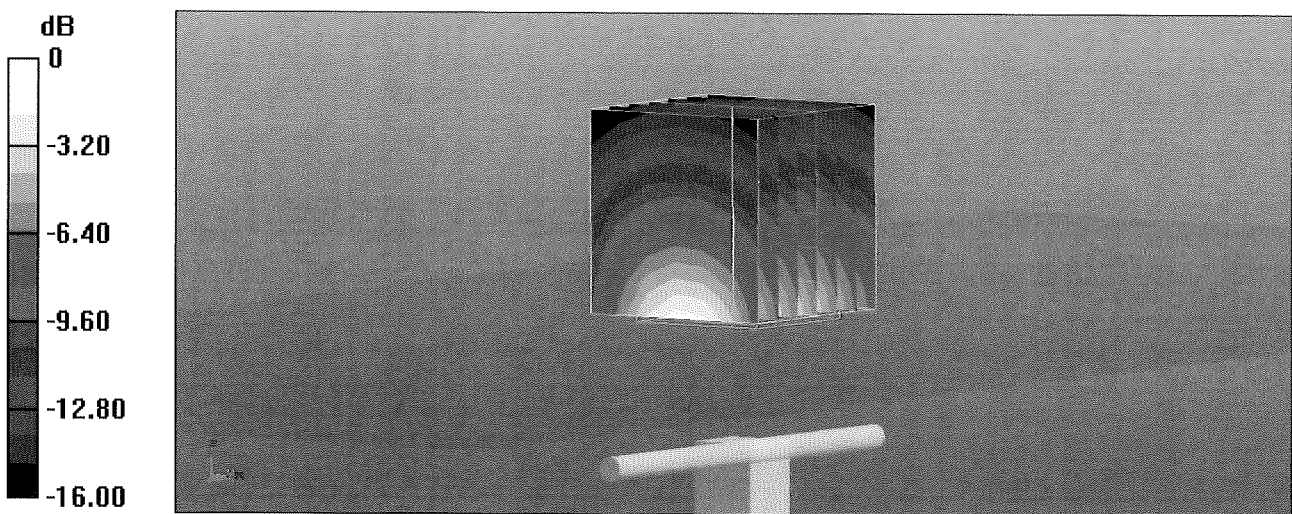

0 dB = 14.2 W/kg = 11.52 dBW/kg

Impedance Measurement Plot for Body TSL

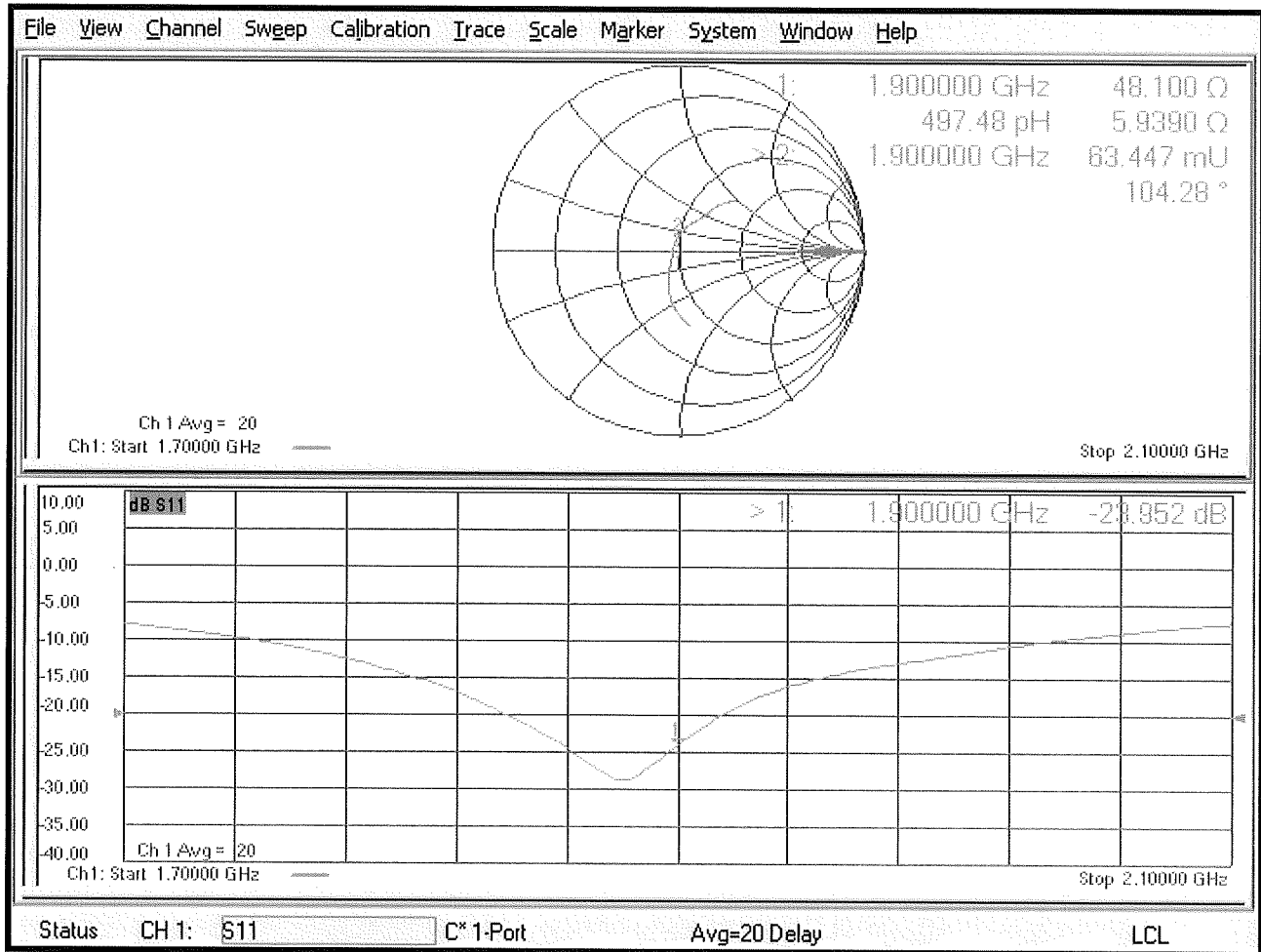



Accredited by the Swiss Accreditation Service (SAS)
The Swiss Accreditation Service is one of the signatories to the EA
Multilateral Agreement for the recognition of calibration certificates

Accreditation No.: **SCS 0108**

Client **PC Test**

Certificate No: **D1900V2-5d080_Oct18**

CALIBRATION CERTIFICATE

Object **D1900V2 - SN:5d080**

Calibration procedure(s) **QA CAL-05 v10
Calibration procedure for dipole validation kits above 700 MHz**

Calibration date: **October 23, 2018**

*BN ✓
10-30-2018
BN ✓
10-20-2019*

This calibration certificate documents the traceability to national standards, which realize the physical units of measurements (SI).
The measurements and the uncertainties with confidence probability are given on the following pages and are part of the certificate.

All calibrations have been conducted in the closed laboratory facility: environment temperature (22 ± 3)°C and humidity < 70%.

Calibration Equipment used (M&TE critical for calibration)

Primary Standards	ID #	Cal Date (Certificate No.)	Scheduled Calibration
Power meter NRP	SN: 104778	04-Apr-18 (No. 217-02672/02673)	Apr-19
Power sensor NRP-Z91	SN: 103244	04-Apr-18 (No. 217-02672)	Apr-19
Power sensor NRP-Z91	SN: 103245	04-Apr-18 (No. 217-02673)	Apr-19
Reference 20 dB Attenuator	SN: 5058 (20k)	04-Apr-18 (No. 217-02682)	Apr-19
Type-N mismatch combination	SN: 5047.2 / 06327	04-Apr-18 (No. 217-02683)	Apr-19
Reference Probe EX3DV4	SN: 7349	30-Dec-17 (No. EX3-7349_Dec17)	Dec-18
DAE4	SN: 601	04-Oct-18 (No. DAE4-601_Oct18)	Oct-19

Secondary Standards	ID #	Check Date (in house)	Scheduled Check
Power meter EPM-442A	SN: GB37480704	07-Oct-15 (in house check Oct-18)	In house check: Oct-20
Power sensor HP 8481A	SN: US37292783	07-Oct-15 (in house check Oct-18)	In house check: Oct-20
Power sensor HP 8481A	SN: MY41092317	07-Oct-15 (in house check Oct-18)	In house check: Oct-20
RF generator R&S SMT-06	SN: 100972	15-Jun-15 (in house check Oct-18)	In house check: Oct-20
Network Analyzer Agilent E8358A	SN: US41080477	31-Mar-14 (in house check Oct-18)	In house check: Oct-19

	Name	Function	Signature
Calibrated by:	Jeton Kastrati	Laboratory Technician	<i>[Signature]</i>
Approved by:	Katja Pokovic	Technical Manager	<i>[Signature]</i>

Issued: October 23, 2018

This calibration certificate shall not be reproduced except in full without written approval of the laboratory.



Accredited by the Swiss Accreditation Service (SAS)
The Swiss Accreditation Service is one of the signatories to the EA
Multilateral Agreement for the recognition of calibration certificates

Accreditation No.: **SCS 0108**

Glossary:

TSL	tissue simulating liquid
ConvF	sensitivity in TSL / NORM x,y,z
N/A	not applicable or not measured

Calibration is Performed According to the Following Standards:

- IEEE Std 1528-2013, "IEEE Recommended Practice for Determining the Peak Spatial-Averaged Specific Absorption Rate (SAR) in the Human Head from Wireless Communications Devices: Measurement Techniques", June 2013
- IEC 62209-1, "Measurement procedure for the assessment of Specific Absorption Rate (SAR) from hand-held and body-mounted devices used next to the ear (frequency range of 300 MHz to 6 GHz)", July 2016
- IEC 62209-2, "Procedure to determine the Specific Absorption Rate (SAR) for wireless communication devices used in close proximity to the human body (frequency range of 30 MHz to 6 GHz)", March 2010
- KDB 865664, "SAR Measurement Requirements for 100 MHz to 6 GHz"

Additional Documentation:

- DASY4/5 System Handbook

Methods Applied and Interpretation of Parameters:

- Measurement Conditions:** Further details are available from the Validation Report at the end of the certificate. All figures stated in the certificate are valid at the frequency indicated.
- Antenna Parameters with TSL:** The dipole is mounted with the spacer to position its feed point exactly below the center marking of the flat phantom section, with the arms oriented parallel to the body axis.
- Feed Point Impedance and Return Loss:** These parameters are measured with the dipole positioned under the liquid filled phantom. The impedance stated is transformed from the measurement at the SMA connector to the feed point. The Return Loss ensures low reflected power. No uncertainty required.
- Electrical Delay:** One-way delay between the SMA connector and the antenna feed point. No uncertainty required.
- SAR measured:** SAR measured at the stated antenna input power.
- SAR normalized:** SAR as measured, normalized to an input power of 1 W at the antenna connector.
- SAR for nominal TSL parameters:** The measured TSL parameters are used to calculate the nominal SAR result.

The reported uncertainty of measurement is stated as the standard uncertainty of measurement multiplied by the coverage factor $k=2$, which for a normal distribution corresponds to a coverage probability of approximately 95%.

Measurement Conditions

DASY system configuration, as far as not given on page 1.

DASY Version	DASY5	V52.10.2
Extrapolation	Advanced Extrapolation	
Phantom	Modular Flat Phantom	
Distance Dipole Center - TSL	10 mm	with Spacer
Zoom Scan Resolution	dx, dy, dz = 5 mm	
Frequency	1900 MHz \pm 1 MHz	

Head TSL parameters

The following parameters and calculations were applied.

	Temperature	Permittivity	Conductivity
Nominal Head TSL parameters	22.0 °C	40.0	1.40 mho/m
Measured Head TSL parameters	(22.0 \pm 0.2) °C	40.3 \pm 6 %	1.40 mho/m \pm 6 %
Head TSL temperature change during test	< 0.5 °C	----	----

SAR result with Head TSL

SAR averaged over 1 cm³ (1 g) of Head TSL	Condition	
SAR measured	250 mW input power	9.93 W/kg
SAR for nominal Head TSL parameters	normalized to 1W	39.8 W/kg \pm 17.0 % (k=2)

SAR averaged over 10 cm³ (10 g) of Head TSL	condition	
SAR measured	250 mW input power	5.18 W/kg
SAR for nominal Head TSL parameters	normalized to 1W	20.7 W/kg \pm 16.5 % (k=2)

Body TSL parameters

The following parameters and calculations were applied.

	Temperature	Permittivity	Conductivity
Nominal Body TSL parameters	22.0 °C	53.3	1.52 mho/m
Measured Body TSL parameters	(22.0 \pm 0.2) °C	52.9 \pm 6 %	1.47 mho/m \pm 6 %
Body TSL temperature change during test	< 0.5 °C	----	----

SAR result with Body TSL

SAR averaged over 1 cm³ (1 g) of Body TSL	Condition	
SAR measured	250 mW input power	9.62 W/kg
SAR for nominal Body TSL parameters	normalized to 1W	39.2 W/kg \pm 17.0 % (k=2)

SAR averaged over 10 cm³ (10 g) of Body TSL	condition	
SAR measured	250 mW input power	5.09 W/kg
SAR for nominal Body TSL parameters	normalized to 1W	20.6 W/kg \pm 16.5 % (k=2)

Appendix (Additional assessments outside the scope of SCS 0108)

Antenna Parameters with Head TSL

Impedance, transformed to feed point	$52.5 \Omega + 7.9 j\Omega$
Return Loss	- 21.8 dB

Antenna Parameters with Body TSL

Impedance, transformed to feed point	$48.1 \Omega + 8.1 j\Omega$
Return Loss	- 21.5 dB

General Antenna Parameters and Design

Electrical Delay (one direction)	1.193 ns
----------------------------------	----------

After long term use with 100W radiated power, only a slight warming of the dipole near the feedpoint can be measured.

The dipole is made of standard semirigid coaxial cable. The center conductor of the feeding line is directly connected to the second arm of the dipole. The antenna is therefore short-circuited for DC-signals. On some of the dipoles, small end caps are added to the dipole arms in order to improve matching when loaded according to the position as explained in the "Measurement Conditions" paragraph. The SAR data are not affected by this change. The overall dipole length is still according to the Standard.

No excessive force must be applied to the dipole arms, because they might bend or the soldered connections near the feedpoint may be damaged.

Additional EUT Data

Manufactured by	SPEAG
Manufactured on	June 28, 2006

DASY5 Validation Report for Head TSL

Date: 23.10.2018

Test Laboratory: SPEAG, Zurich, Switzerland

DUT: Dipole 1900 MHz; Type: D1900V2; Serial: D1900V2 - SN:5d080

Communication System: UID 0 - CW; Frequency: 1900 MHz

Medium parameters used: $f = 1900$ MHz; $\sigma = 1.4$ S/m; $\epsilon_r = 40.3$; $\rho = 1000$ kg/m³

Phantom section: Flat Section

Measurement Standard: DASY5 (IEEE/IEC/ANSI C63.19-2011)

DASY52 Configuration:

- Probe: EX3DV4 - SN7349; ConvF(8.18, 8.18, 8.18) @ 1900 MHz; Calibrated: 30.12.2017
- Sensor-Surface: 1.4mm (Mechanical Surface Detection)
- Electronics: DAE4 Sn601; Calibrated: 04.10.2018
- Phantom: Flat Phantom 5.0 (front); Type: QD 000 P50 AA; Serial: 1001
- DASY52 52.10.2(1495); SEMCAD X 14.6.12(7450)

Dipole Calibration for Head Tissue/Pin=250 mW, d=10mm/Zoom Scan (7x7x7)/Cube 0:

Measurement grid: dx=5mm, dy=5mm, dz=5mm

Reference Value = 110.0 V/m; Power Drift = -0.05 dB

Peak SAR (extrapolated) = 18.7 W/kg

SAR(1 g) = 9.93 W/kg; SAR(10 g) = 5.18 W/kg

Maximum value of SAR (measured) = 15.6 W/kg

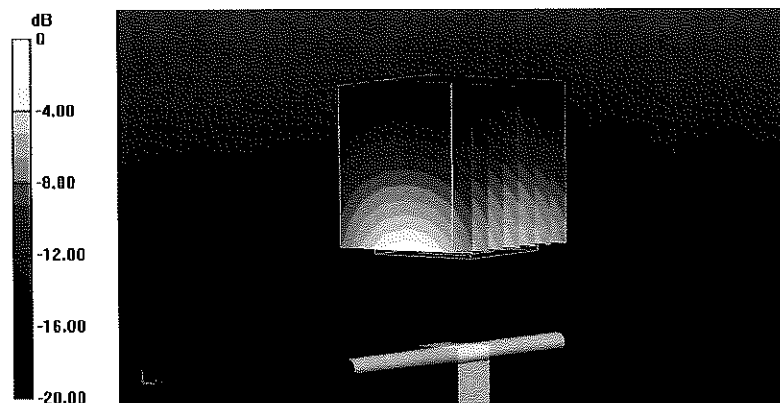

0 dB = 15.6 W/kg = 11.93 dBW/kg

Impedance Measurement Plot for Head TSL

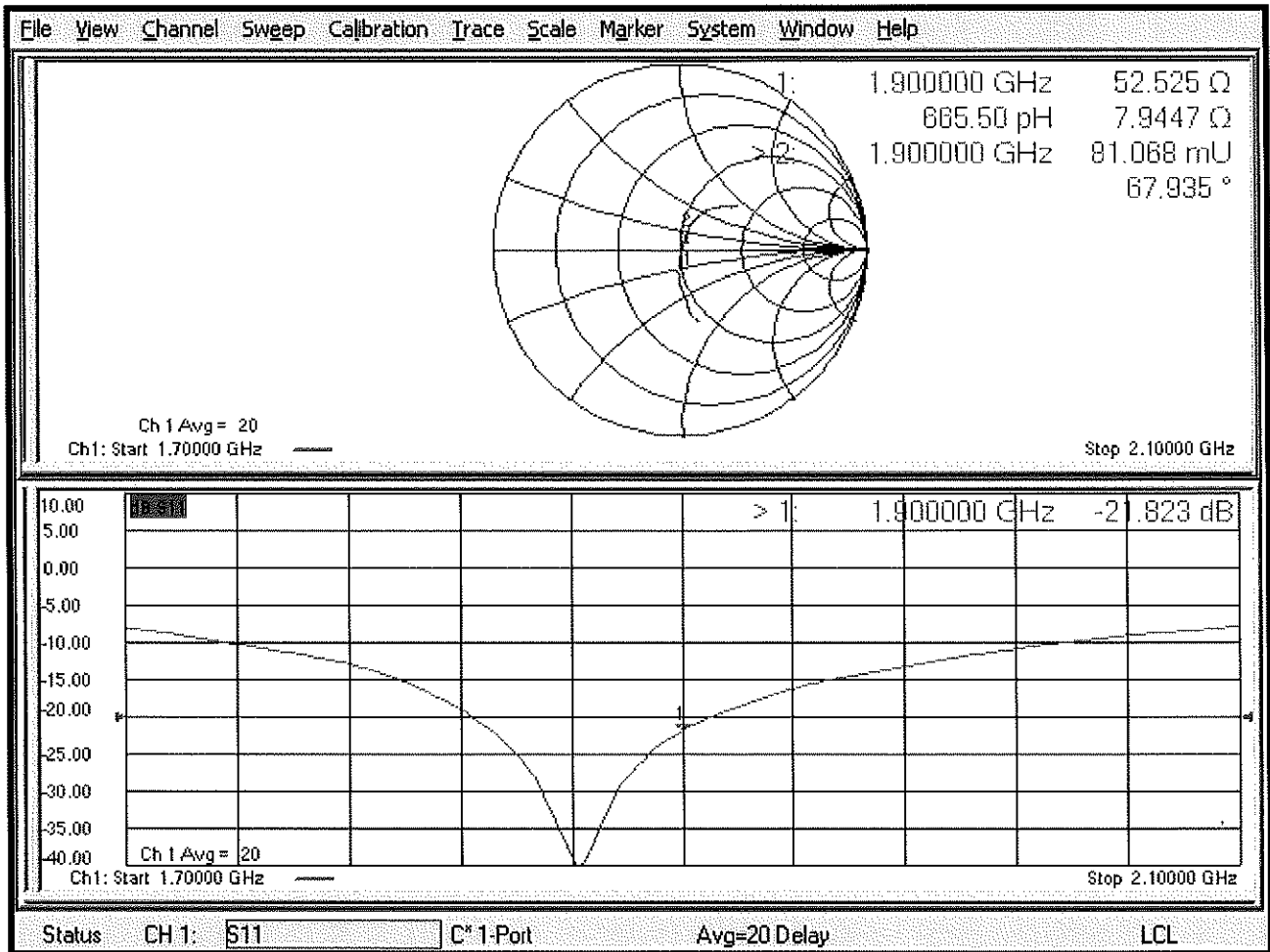

DASY5 Validation Report for Body TSL

Date: 23.10.2018

Test Laboratory: SPEAG, Zurich, Switzerland

DUT: Dipole 1900 MHz; Type: D1900V2; Serial: D1900V2 - SN:5d080

Communication System: UID 0 - CW; Frequency: 1900 MHz

Medium parameters used: $f = 1900$ MHz; $\sigma = 1.47$ S/m; $\epsilon_r = 52.9$; $\rho = 1000$ kg/m³

Phantom section: Flat Section

Measurement Standard: DASY5 (IEEE/IEC/ANSI C63.19-2011)

DASY52 Configuration:

- Probe: EX3DV4 - SN7349; ConvF(8.15, 8.15, 8.15) @ 1900 MHz; Calibrated: 30.12.2017
- Sensor-Surface: 1.4mm (Mechanical Surface Detection)
- Electronics: DAE4 Sn601; Calibrated: 04.10.2018
- Phantom: Flat Phantom 5.0 (back); Type: QD 000 P50 AA; Serial: 1002
- DASY52 52.10.2(1495); SEMCAD X 14.6.12(7450)

Dipole Calibration for Body Tissue/Pin=250 mW, d=10mm/Zoom Scan (7x7x7)/Cube 0:

Measurement grid: dx=5mm, dy=5mm, dz=5mm

Reference Value = 99.86 V/m; Power Drift = 0.00 dB

Peak SAR (extrapolated) = 17.3 W/kg

SAR(1 g) = 9.62 W/kg; SAR(10 g) = 5.09 W/kg

Maximum value of SAR (measured) = 14.1 W/kg

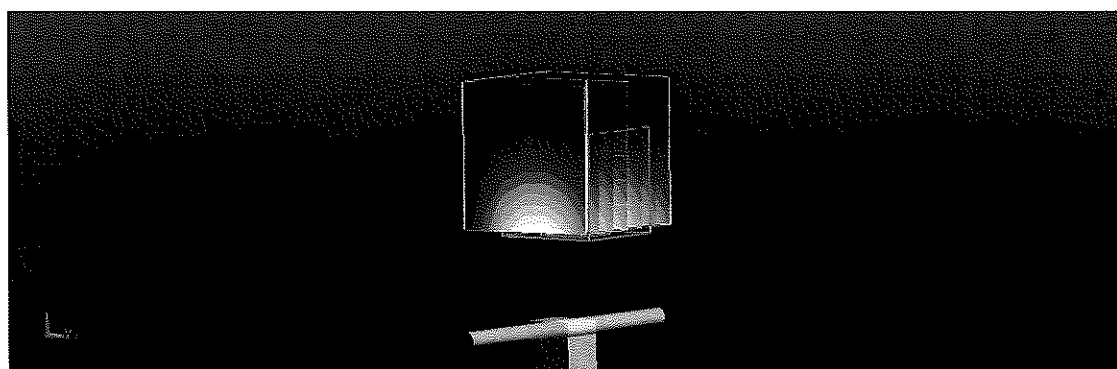
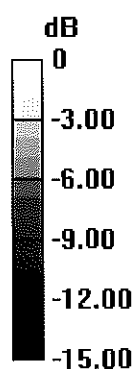

0 dB = 14.1 W/kg = 11.49 dBW/kg

Impedance Measurement Plot for Body TSL

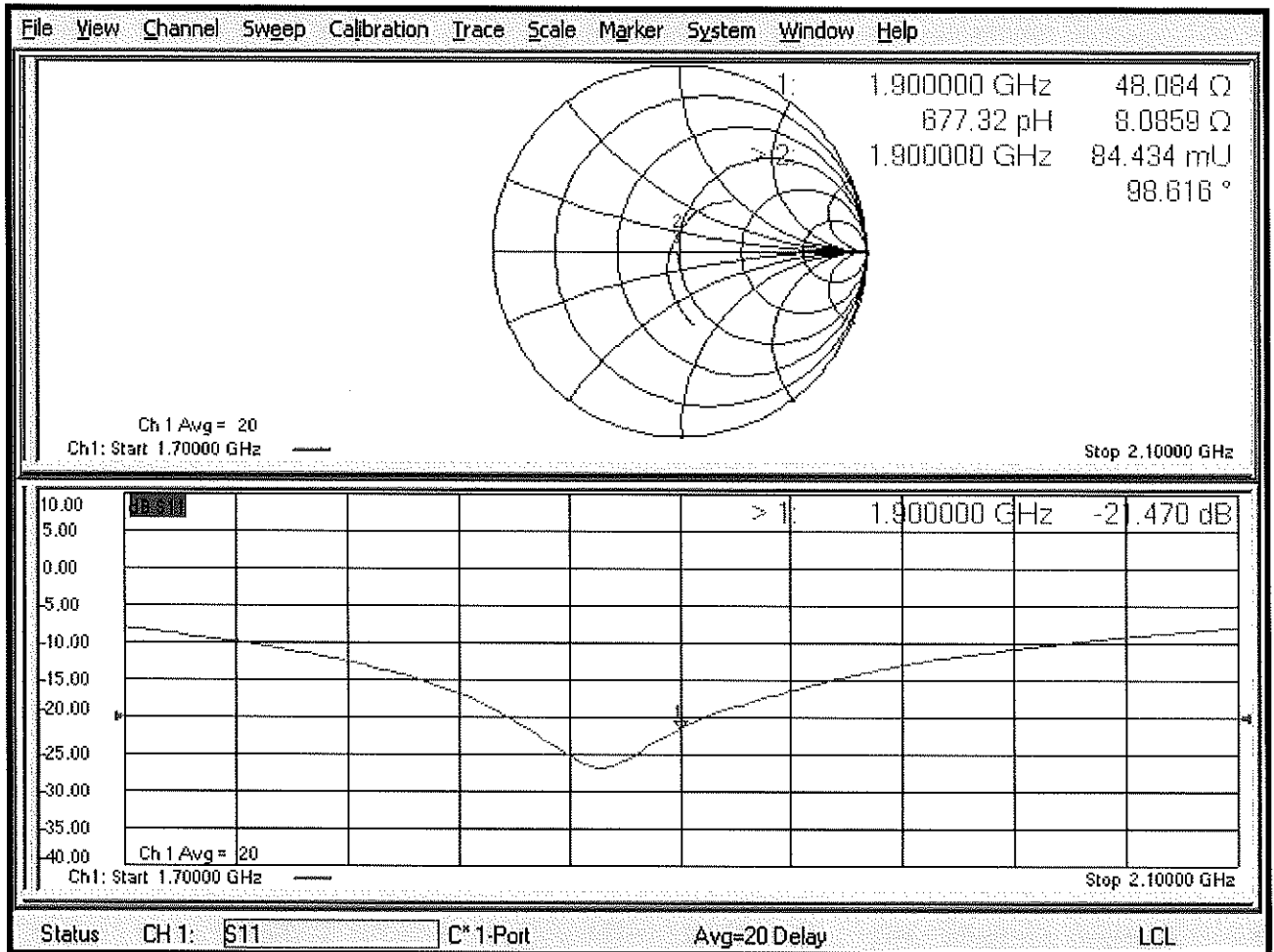

Certification of Calibration

Object: D1900V2 – SN:5d080

Calibration procedure(s): Procedure for Calibration Extension for SAR Dipoles.

Extended Calibration date: October 18, 2019

Description: SAR Validation Dipole at 1900 MHz.

Calibration Equipment used:

Manufacturer	Model	Description	Cal Date	Cal Interval	Cal Due	Serial Number
Control Company	4040	Therm./Clock/Humidity Monitor	6/29/2019	Biennial	6/29/2021	192291470
Control Company	4352	Ultra Long Stem Thermometer	8/2/2018	Biennial	8/2/2020	181334684
Amplifier Research	15S1G6	Amplifier	CBT	N/A	CBT	433971
Narda	4772-3	Attenuator (3dB)	CBT	N/A	CBT	9406
Keysight Technologies	85033E	Standard Mechanical Calibration Kit (DC to 9GHz, 3.5mm)	7/2/2019	Annual	7/2/2020	MY53401181
Rohde & Schwarz	ZNLE6	Vector Network Analyzer	10/11/2019	Annual	10/11/2020	101307
Mini-Circuits	BW-N20W5+	DC to 18 GHz Precision Fixed 20 dB Attenuator	CBT	N/A	CBT	N/A
SPEAG	DAKS-3.5	Portable Dielectric Assessment Kit	8/13/2019	Annual	8/13/2020	1041
Anritsu	MA2411B	Pulse Power Sensor	8/14/2019	Annual	8/14/2020	1315051
Anritsu	MA2411B	Pulse Power Sensor	8/8/2019	Annual	8/8/2020	1339008
Anritsu	ML2495A	Power Meter	11/20/2018	Annual	11/20/2019	1039008
Agilent	N5182A	MXG Vector Signal Generator	8/19/2019	Annual	8/19/2020	MY47420837
Seekonk	NC-100	Torque Wrench	5/9/2018	Biennial	5/9/2020	22217
Mini-Circuits	NLP-2950+	Low Pass Filter DC to 2700 MHz	CBT	N/A	CBT	N/A
MiniCircuits	ZHDC-16-63-S+	Bidirectional Coupler	CBT	N/A	CBT	N/A
MiniCircuits	VLF-6000+	Low Pass Filter	CBT	N/A	CBT	N/A
SPEAG	EX3DV4	SAR Probe	2/19/2019	Annual	2/19/2020	3914
SPEAG	EX3DV4	SAR Probe	5/16/2019	Annual	5/16/2020	7406
SPEAG	DAE4	Dasy Data Acquisition Electronics	5/8/2019	Annual	5/8/2020	859
SPEAG	DAE4	Dasy Data Acquisition Electronics	2/14/2019	Annual	2/14/2020	1272

Note: CBT (Calibrated Before Testing). Prior to testing, the measurement paths containing a cable, amplifier, attenuator, coupler or filter were connected to a calibrated source (i.e. a signal generator) to determine the losses of the measurement path.

Measurement Uncertainty = $\pm 23\%$ (k=2)

	Name	Function	Signature
Calibrated By:	Brodie Halfoster	Team Lead Engineer	<i>BRODIE HALBFOSTER</i>
Approved By:	Kaitlin O'Keefe	Senior Technical Manager	<i>KOK</i>

DIPOLE CALIBRATION EXTENSION

Per KDB 865664 D01, calibration intervals of up to three years may be considered for reference dipoles when it is demonstrated that the SAR target, impedance and return loss of a dipole have remained stable according to the following requirements:

1. The measured SAR does not deviate more than 10% from the target on the calibration certificate.
2. The return-loss does not deviate more than 20% from the previous measurement and meets the required 20dB minimum return-loss requirement.
3. The measurement of real or imaginary parts of impedance does not deviate more than 5Ω from the previous measurement.

The following dipole was checked to pass the above 3 requirements to have 2-year calibration period from the calibration date:

Calibration Date	Extension Date	Certificate Electrical Delay (ms)	Certificate SAR Target Head (1g) W/kg @ 20.0 dBm	Measured Head SAR (1g) W/kg @ 20.0 dBm	Deviation 1g (%)	Certificate SAR Target Head (10g) W/kg @ 20.0 dBm	Measured Head SAR (10g) W/kg @ 20.0 dBm	Deviation 10g (%)	Certificate Impedance Head (Ohm) Real	Measured Impedance Head (Ohm) Real	Difference (Ohm) Real	Certificate Impedance Head (Ohm) Imaginary	Measured Impedance Head (Ohm) Imaginary	Difference (Ohm) Imaginary	Certificate Return Loss Head (dB)	Measured Return Loss Head (dB)	Deviation (%)	PASS/FAIL
10/23/2018	10/18/2019	1.193	3.98	4.16	4.52%	2.07	2.13	2.90%	52.5	50.4	2.1	7.9	6.2	1.7	-21.8	-24.2	-10.90%	PASS
Calibration Date	Extension Date	Certificate Electrical Delay (ms)	Certificate SAR Target Body (1g) W/kg @ 20.0 dBm	Measured Body SAR (1g) W/kg @ 20.0 dBm	Deviation 1g (%)	Certificate SAR Target Body (10g) W/kg @ 20.0 dBm	Measured Body SAR (10g) W/kg @ 20.0 dBm	Deviation 10g (%)	Certificate Impedance Body (Ohm) Real	Measured Impedance Body (Ohm) Real	Difference (Ohm) Real	Certificate Impedance Body (Ohm) Imaginary	Measured Impedance Body (Ohm) Imaginary	Difference (Ohm) Imaginary	Certificate Return Loss Body (dB)	Measured Return Loss Body (dB)	Deviation (%)	PASS/FAIL
10/23/2018	10/18/2019	1.193	3.92	4.21	7.40%	2.06	2.16	4.85%	48.1	46.5	1.6	8.1	6.6	1.5	-21.5	-22.2	-3.40%	PASS

Impedance & Return-Loss Measurement Plot for Head TSL

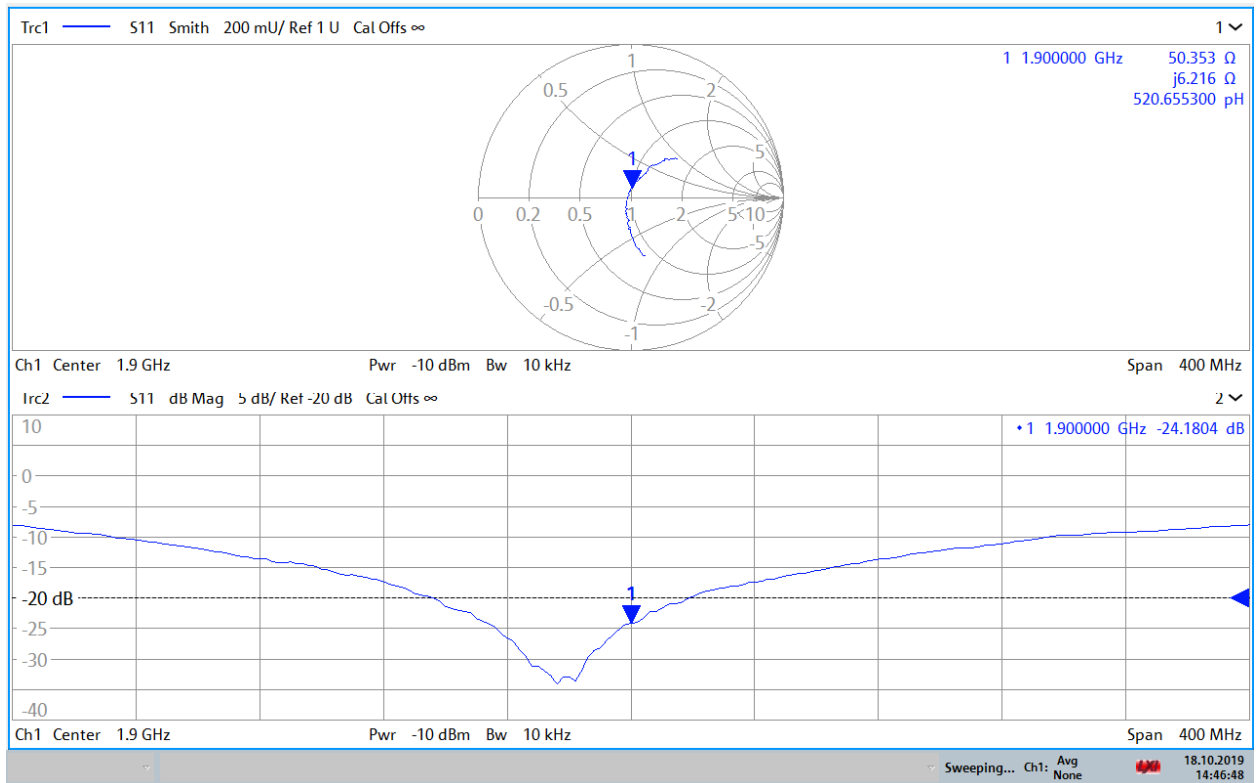

14:46:49 18.10.2019

Impedance & Return-Loss Measurement Plot for Body TSL

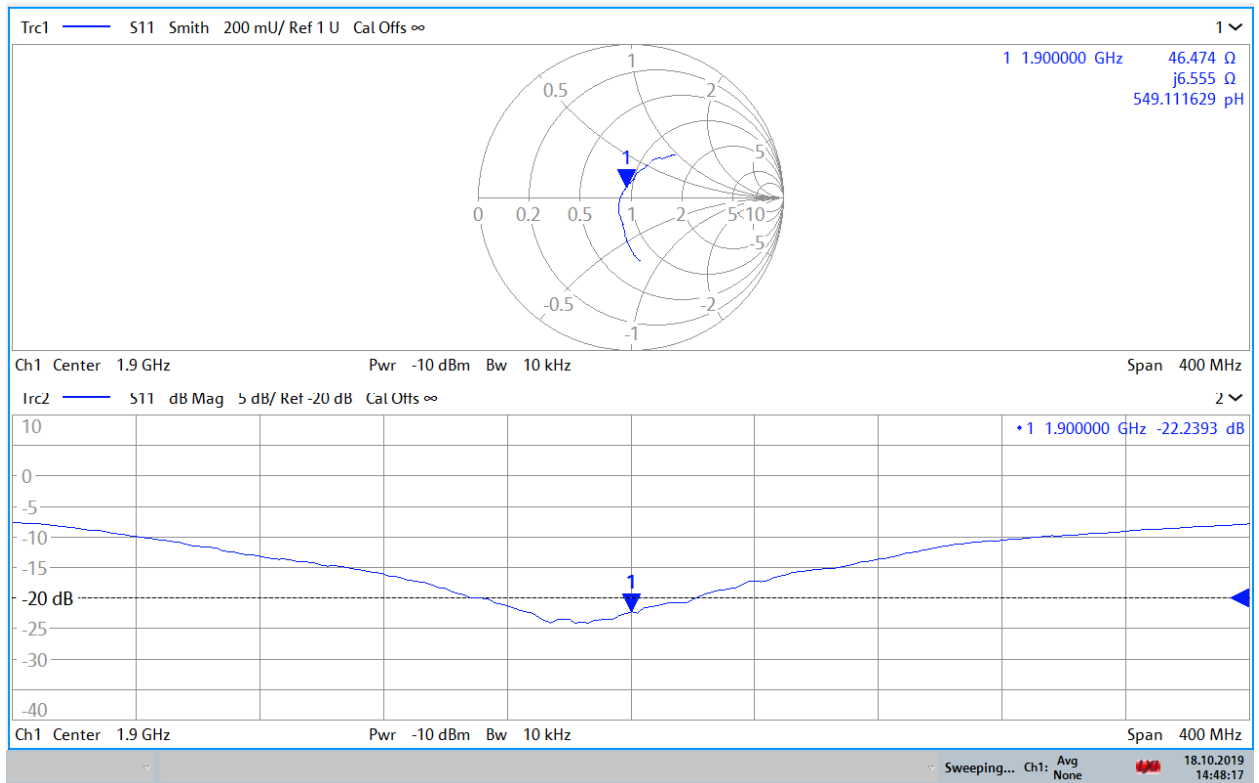

14:48:18 18.10.2019



Accredited by the Swiss Accreditation Service (SAS)
The Swiss Accreditation Service is one of the signatories to the EA
Multilateral Agreement for the recognition of calibration certificates

Accreditation No.: **SCS 0108**

Client **PC Test**

Certificate No: **D2450V2-882_Feb20**

CALIBRATION CERTIFICATE

Object **D2450V2 - SN:882**

Calibration procedure(s) **QA CAL-05.v11
Calibration Procedure for SAR Validation Sources between 0.7-3 GHz**

Calibration date: **February 10, 2020**

*BNV
02-26-2020*

This calibration certificate documents the traceability to national standards, which realize the physical units of measurements (SI).
The measurements and the uncertainties with confidence probability are given on the following pages and are part of the certificate.

All calibrations have been conducted in the closed laboratory facility: environment temperature (22 ± 3)°C and humidity < 70%.

Calibration Equipment used (M&TE critical for calibration)

Primary Standards	ID #	Cal Date (Certificate No.)	Scheduled Calibration
Power meter NRP	SN: 104778	03-Apr-19 (No. 217-02892/02893)	Apr-20
Power sensor NRP-Z91	SN: 103244	03-Apr-19 (No. 217-02892)	Apr-20
Power sensor NRP-Z91	SN: 103245	03-Apr-19 (No. 217-02893)	Apr-20
Reference 20 dB Attenuator	SN: 5058 (20k)	04-Apr-19 (No. 217-02894)	Apr-20
Type-N mismatch combination	SN: 5047.2 / 06327	04-Apr-19 (No. 217-02895)	Apr-20
Reference Probe EX3DV4	SN: 7349	31-Dec-19 (No. EX3-7349_Dec19)	Dec-20
DAE4	SN: 601	27-Dec-19 (No. DAE4-601_Dec19)	Dec-20

Secondary Standards	ID #	Check Date (in house)	Scheduled Check
Power meter E4419B	SN: GB39512475	30-Oct-14 (in house check Feb-19)	In house check: Oct-20
Power sensor HP 8481A	SN: US37292783	07-Oct-15 (in house check Oct-18)	In house check: Oct-20
Power sensor HP 8481A	SN: MY41092317	07-Oct-15 (in house check Oct-18)	In house check: Oct-20
RF generator R&S SMT-06	SN: 100972	15-Jun-15 (in house check Oct-18)	In house check: Oct-20
Network Analyzer Agilent E8358A	SN: US41080477	31-Mar-14 (in house check Oct-19)	In house check: Oct-20

Calibrated by: **Michael Weber** **Laboratory Technician**

Signature
M. Weber

Approved by: **Katja Pokovic** **Technical Manager**

[Signature]

Issued: February 11, 2020

This calibration certificate shall not be reproduced except in full without written approval of the laboratory.



Accredited by the Swiss Accreditation Service (SAS)

Accreditation No.: **SCS 0108**

The Swiss Accreditation Service is one of the signatories to the EA
Multilateral Agreement for the recognition of calibration certificates

Glossary:

TSL	tissue simulating liquid
ConvF	sensitivity in TSL / NORM x,y,z
N/A	not applicable or not measured

Calibration is Performed According to the Following Standards:

- IEEE Std 1528-2013, "IEEE Recommended Practice for Determining the Peak Spatial-Averaged Specific Absorption Rate (SAR) in the Human Head from Wireless Communications Devices: Measurement Techniques", June 2013
- IEC 62209-1, "Measurement procedure for the assessment of Specific Absorption Rate (SAR) from hand-held and body-mounted devices used next to the ear (frequency range of 300 MHz to 6 GHz)", July 2016
- IEC 62209-2, "Procedure to determine the Specific Absorption Rate (SAR) for wireless communication devices used in close proximity to the human body (frequency range of 30 MHz to 6 GHz)", March 2010
- KDB 865664, "SAR Measurement Requirements for 100 MHz to 6 GHz"

Additional Documentation:

- DASY4/5 System Handbook

Methods Applied and Interpretation of Parameters:

- Measurement Conditions:** Further details are available from the Validation Report at the end of the certificate. All figures stated in the certificate are valid at the frequency indicated.
- Antenna Parameters with TSL:** The dipole is mounted with the spacer to position its feed point exactly below the center marking of the flat phantom section, with the arms oriented parallel to the body axis.
- Feed Point Impedance and Return Loss:** These parameters are measured with the dipole positioned under the liquid filled phantom. The impedance stated is transformed from the measurement at the SMA connector to the feed point. The Return Loss ensures low reflected power. No uncertainty required.
- Electrical Delay:** One-way delay between the SMA connector and the antenna feed point. No uncertainty required.
- SAR measured:** SAR measured at the stated antenna input power.
- SAR normalized:** SAR as measured, normalized to an input power of 1 W at the antenna connector.
- SAR for nominal TSL parameters:** The measured TSL parameters are used to calculate the nominal SAR result.

The reported uncertainty of measurement is stated as the standard uncertainty of measurement multiplied by the coverage factor $k=2$, which for a normal distribution corresponds to a coverage probability of approximately 95%.

Measurement Conditions

DASY system configuration, as far as not given on page 1.

DASY Version	DASY5	V52.10.4
Extrapolation	Advanced Extrapolation	
Phantom	Modular Flat Phantom	
Distance Dipole Center - TSL	10 mm	with Spacer
Zoom Scan Resolution	dx, dy, dz = 5 mm	
Frequency	2450 MHz \pm 1 MHz	

Head TSL parameters

The following parameters and calculations were applied.

	Temperature	Permittivity	Conductivity
Nominal Head TSL parameters	22.0 °C	39.2	1.80 mho/m
Measured Head TSL parameters	(22.0 \pm 0.2) °C	38.4 \pm 6 %	1.86 mho/m \pm 6 %
Head TSL temperature change during test	< 0.5 °C	----	----

SAR result with Head TSL

SAR averaged over 1 cm ³ (1 g) of Head TSL	Condition	
SAR measured	250 mW input power	13.5 W/kg
SAR for nominal Head TSL parameters	normalized to 1W	52.9 W/kg \pm 17.0 % (k=2)

SAR averaged over 10 cm ³ (10 g) of Head TSL	condition	
SAR measured	250 mW input power	6.22 W/kg
SAR for nominal Head TSL parameters	normalized to 1W	24.6 W/kg \pm 16.5 % (k=2)

Body TSL parameters

The following parameters and calculations were applied.

	Temperature	Permittivity	Conductivity
Nominal Body TSL parameters	22.0 °C	52.7	1.95 mho/m
Measured Body TSL parameters	(22.0 \pm 0.2) °C	51.4 \pm 6 %	2.03 mho/m \pm 6 %
Body TSL temperature change during test	< 0.5 °C	----	----

SAR result with Body TSL

SAR averaged over 1 cm ³ (1 g) of Body TSL	Condition	
SAR measured	250 mW input power	13.2 W/kg
SAR for nominal Body TSL parameters	normalized to 1W	51.5 W/kg \pm 17.0 % (k=2)

SAR averaged over 10 cm ³ (10 g) of Body TSL	condition	
SAR measured	250 mW input power	6.14 W/kg
SAR for nominal Body TSL parameters	normalized to 1W	24.2 W/kg \pm 16.5 % (k=2)

Appendix (Additional assessments outside the scope of SCS 0108)

Antenna Parameters with Head TSL

Impedance, transformed to feed point	$54.7 \Omega + 2.3 j\Omega$
Return Loss	- 26.0 dB

Antenna Parameters with Body TSL

Impedance, transformed to feed point	$51.4 \Omega + 3.8 j\Omega$
Return Loss	- 28.0 dB

General Antenna Parameters and Design

Electrical Delay (one direction)	1.157 ns
----------------------------------	----------

After long term use with 100W radiated power, only a slight warming of the dipole near the feedpoint can be measured.

The dipole is made of standard semirigid coaxial cable. The center conductor of the feeding line is directly connected to the second arm of the dipole. The antenna is therefore short-circuited for DC-signals. On some of the dipoles, small end caps are added to the dipole arms in order to improve matching when loaded according to the position as explained in the "Measurement Conditions" paragraph. The SAR data are not affected by this change. The overall dipole length is still according to the Standard.

No excessive force must be applied to the dipole arms, because they might bend or the soldered connections near the feedpoint may be damaged.

Additional EUT Data

Manufactured by	SPEAG
-----------------	-------

DASY5 Validation Report for Head TSL

Date: 10.02.2020

Test Laboratory: SPEAG, Zurich, Switzerland

DUT: Dipole 2450 MHz; Type: D2450V2; Serial: D2450V2 - SN:882

Communication System: UID 0 - CW; Frequency: 2450 MHz

Medium parameters used: $f = 2450$ MHz; $\sigma = 1.86$ S/m; $\epsilon_r = 38.4$; $\rho = 1000$ kg/m³

Phantom section: Flat Section

Measurement Standard: DASY5 (IEEE/IEC/ANSI C63.19-2011)

DASY52 Configuration:

- Probe: EX3DV4 - SN7349; ConvF(7.98, 7.98, 7.98) @ 2450 MHz; Calibrated: 31.12.2019
- Sensor-Surface: 1.4mm (Mechanical Surface Detection)
- Electronics: DAE4 Sn601; Calibrated: 27.12.2019
- Phantom: Flat Phantom 5.0 (front); Type: QD 000 P50 AA; Serial: 1001
- DASY52 52.10.4(1527); SEMCAD X 14.6.14(7483)

Dipole Calibration for Head Tissue/Pin=250 mW, d=10mm/Zoom Scan (7x7x7)/Cube 0:

Measurement grid: dx=5mm, dy=5mm, dz=5mm

Reference Value = 118.2 V/m; Power Drift = 0.04 dB

Peak SAR (extrapolated) = 26.8 W/kg

SAR(1 g) = 13.5 W/kg; SAR(10 g) = 6.22 W/kg

Smallest distance from peaks to all points 3 dB below = 9 mm

Ratio of SAR at M2 to SAR at M1 = 50.3%

Maximum value of SAR (measured) = 22.2 W/kg

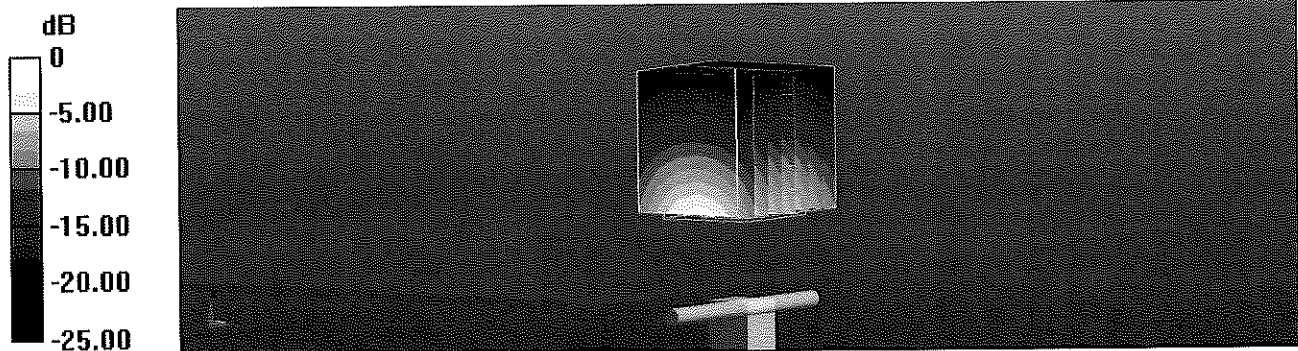

0 dB = 22.2 W/kg = 13.47 dBW/kg

Impedance Measurement Plot for Head TSL

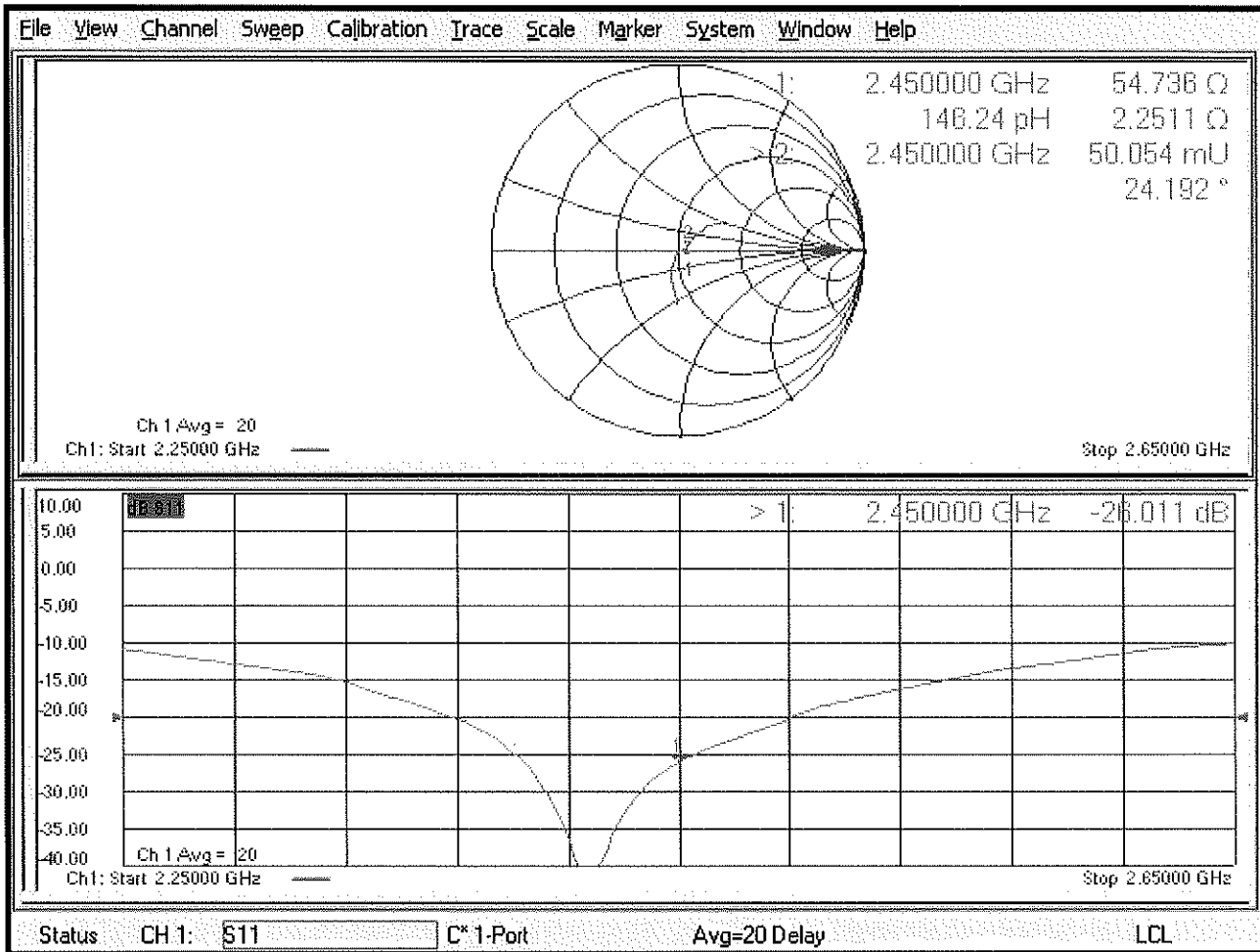

DASY5 Validation Report for Body TSL

Date: 10.02.2020

Test Laboratory: SPEAG, Zurich, Switzerland

DUT: Dipole 2450 MHz; Type: D2450V2; Serial: D2450V2 - SN:882

Communication System: UID 0 - CW; Frequency: 2450 MHz

Medium parameters used: $f = 2450$ MHz; $\sigma = 2.03$ S/m; $\epsilon_r = 51.4$; $\rho = 1000$ kg/m³

Phantom section: Flat Section

Measurement Standard: DASY5 (IEEE/IEC/ANSI C63.19-2011)

DASY52 Configuration:

- Probe: EX3DV4 - SN7349; ConvF(8.02, 8.02, 8.02) @ 2450 MHz; Calibrated: 31.12.2019
- Sensor-Surface: 1.4mm (Mechanical Surface Detection)
- Electronics: DAE4 Sn601; Calibrated: 27.12.2019
- Phantom: Flat Phantom 5.0 (back); Type: QD 000 P50 AA; Serial: 1002
- DASY52 52.10.4(1527); SEMCAD X 14.6.14(7483)

Dipole Calibration for Body Tissue/Pin=250 mW, d=10mm/Zoom Scan (7x7x7)/Cube 0:

Measurement grid: dx=5mm, dy=5mm, dz=5mm

Reference Value = 110.1 V/m; Power Drift = -0.05 dB

Peak SAR (extrapolated) = 25.0 W/kg

SAR(1 g) = 13.2 W/kg; SAR(10 g) = 6.14 W/kg

Smallest distance from peaks to all points 3 dB below = 9 mm

Ratio of SAR at M2 to SAR at M1 = 53.5%

Maximum value of SAR (measured) = 21.1 W/kg

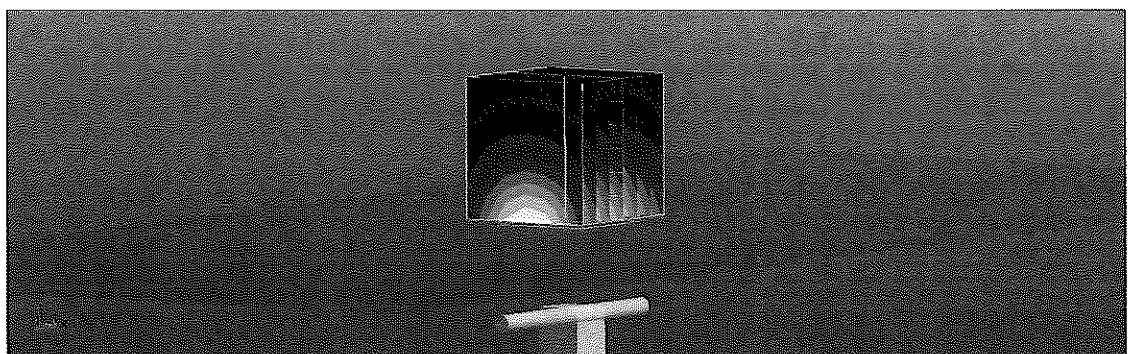
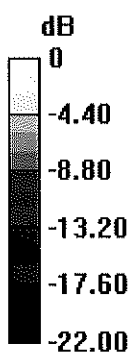

0 dB = 21.1 W/kg = 13.24 dBW/kg

Impedance Measurement Plot for Body TSL

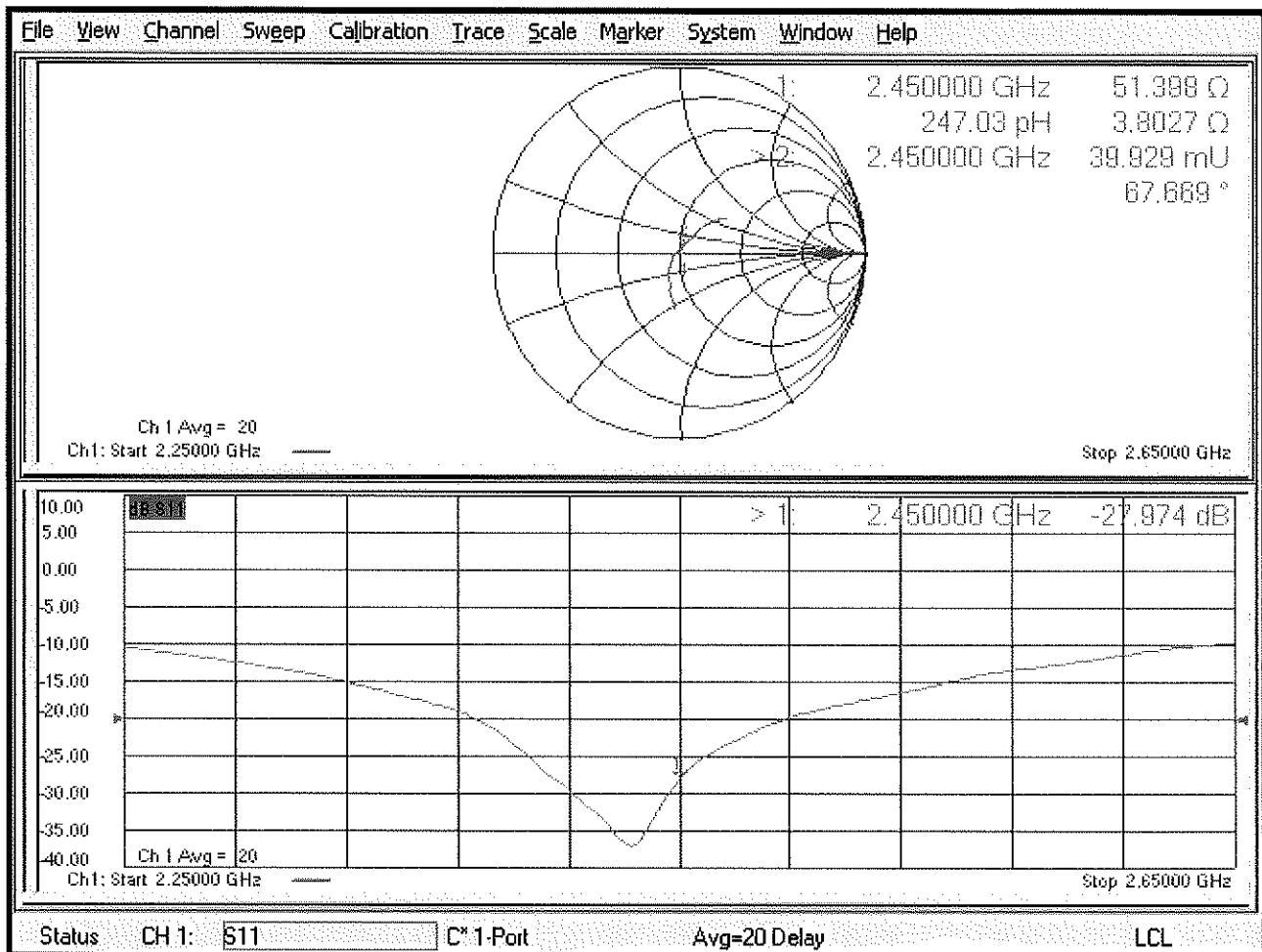



Accredited by the Swiss Accreditation Service (SAS)
The Swiss Accreditation Service is one of the signatories to the EA
Multilateral Agreement for the recognition of calibration certificates

Accreditation No.: **SCS 0108**

Client **PC Test**

Certificate No: **D5GHzV2-1237_Aug18**

CALIBRATION CERTIFICATE

Object **D5GHzV2 - SN:1237**

Calibration procedure(s) **QA CAL-22.v3
Calibration procedure for dipole validation kits between 3-6 GHz**

*BNV
09-06-2018*

Calibration date: **August 10, 2018**

*BNV
08/09/2019*

This calibration certificate documents the traceability to national standards, which realize the physical units of measurements (SI).
The measurements and the uncertainties with confidence probability are given on the following pages and are part of the certificate.

BNV 08-20-20

All calibrations have been conducted in the closed laboratory facility: environment temperature (22 ± 3)°C and humidity < 70%.

Calibration Equipment used (M&TE critical for calibration)

Primary Standards	ID #	Cal Date (Certificate No.)	Scheduled Calibration
Power meter NRP	SN: 104778	04-Apr-18 (No. 217-02672/02673)	Apr-19
Power sensor NRP-Z91	SN: 103244	04-Apr-18 (No. 217-02672)	Apr-19
Power sensor NRP-Z91	SN: 103245	04-Apr-18 (No. 217-02673)	Apr-19
Reference 20 dB Attenuator	SN: 5058 (20k)	04-Apr-18 (No. 217-02682)	Apr-19
Type-N mismatch combination	SN: 5047.2 / 06327	04-Apr-18 (No. 217-02683)	Apr-19
Reference Probe EX3DV4	SN: 3503	30-Dec-17 (No. EX3-3503_Dec17)	Dec-18
DAE4	SN: 601	26-Oct-17 (No. DAE4-601_Oct17)	Oct-18
Secondary Standards	ID #	Check Date (in house)	Scheduled Check
Power meter EPM-442A	SN: GB37480704	07-Oct-15 (in house check Oct-16)	In house check: Oct-18
Power sensor HP 8481A	SN: US37292783	07-Oct-15 (in house check Oct-16)	In house check: Oct-18
Power sensor HP 8481A	SN: MY41092317	07-Oct-15 (in house check Oct-16)	In house check: Oct-18
RF generator R&S SMT-06	SN: 100972	15-Jun-15 (in house check Oct-16)	In house check: Oct-18
Network Analyzer Agilent E8358A	SN: US41080477	31-Mar-14 (in house check Oct-17)	In house check: Oct-18

Calibrated by: **Manu Seitz** Name: **Manu Seitz** Function: **Laboratory Technician**

Signature: *[Handwritten Signature]*

Approved by: **Katja Pokovic** Name: **Katja Pokovic** Technical Manager

Issued: August 17, 2018

This calibration certificate shall not be reproduced except in full without written approval of the laboratory.



Accredited by the Swiss Accreditation Service (SAS)

The Swiss Accreditation Service is one of the signatories to the EA Multilateral Agreement for the recognition of calibration certificates

Accreditation No.: **SCS 0108**

Glossary:

TSL	tissue simulating liquid
ConvF	sensitivity in TSL / NORM x,y,z
N/A	not applicable or not measured

Calibration is Performed According to the Following Standards:

- IEEE Std 1528-2013, "IEEE Recommended Practice for Determining the Peak Spatial-Averaged Specific Absorption Rate (SAR) in the Human Head from Wireless Communications Devices: Measurement Techniques", June 2013
- IEC 62209-1, "Measurement procedure for the assessment of Specific Absorption Rate (SAR) from hand-held and body-mounted devices used next to the ear (frequency range of 300 MHz to 6 GHz)", July 2016
- IEC 62209-2, "Procedure to determine the Specific Absorption Rate (SAR) for wireless communication devices used in close proximity to the human body (frequency range of 30 MHz to 6 GHz)", March 2010
- KDB 865664, "SAR Measurement Requirements for 100 MHz to 6 GHz"

Additional Documentation:

- DASY4/5 System Handbook

Methods Applied and Interpretation of Parameters:

- Measurement Conditions:** Further details are available from the Validation Report at the end of the certificate. All figures stated in the certificate are valid at the frequency indicated.
- Antenna Parameters with TSL:** The dipole is mounted with the spacer to position its feed point exactly below the center marking of the flat phantom section, with the arms oriented parallel to the body axis.
- Feed Point Impedance and Return Loss:** These parameters are measured with the dipole positioned under the liquid filled phantom. The impedance stated is transformed from the measurement at the SMA connector to the feed point. The Return Loss ensures low reflected power. No uncertainty required.
- Electrical Delay:** One-way delay between the SMA connector and the antenna feed point. No uncertainty required.
- SAR measured:** SAR measured at the stated antenna input power.
- SAR normalized:** SAR as measured, normalized to an input power of 1 W at the antenna connector.
- SAR for nominal TSL parameters:** The measured TSL parameters are used to calculate the nominal SAR result.

The reported uncertainty of measurement is stated as the standard uncertainty of measurement multiplied by the coverage factor $k=2$, which for a normal distribution corresponds to a coverage probability of approximately 95%.

Measurement Conditions

DASY system configuration, as far as not given on page 1.

DASY Version	DASY5	V52.10.1
Extrapolation	Advanced Extrapolation	
Phantom	Modular Flat Phantom V5.0	
Distance Dipole Center - TSL	10 mm	with Spacer
Zoom Scan Resolution	dx, dy = 4.0 mm, dz = 1.4 mm	Graded Ratio = 1.4 (Z direction)
Frequency	5250 MHz ± 1 MHz 5600 MHz ± 1 MHz 5750 MHz ± 1 MHz	

Head TSL parameters at 5250 MHz

The following parameters and calculations were applied.

	Temperature	Permittivity	Conductivity
Nominal Head TSL parameters	22.0 °C	35.9	4.71 mho/m
Measured Head TSL parameters	(22.0 ± 0.2) °C	35.6 ± 6 %	4.61 mho/m ± 6 %
Head TSL temperature change during test	< 0.5 °C	----	----

SAR result with Head TSL at 5250 MHz

SAR averaged over 1 cm³ (1 g) of Head TSL	Condition	
SAR measured	100 mW input power	8.15 W/kg
SAR for nominal Head TSL parameters	normalized to 1W	81.3 W/kg ± 19.9 % (k=2)

SAR averaged over 10 cm³ (10 g) of Head TSL	condition	
SAR measured	100 mW input power	2.36 W/kg
SAR for nominal Head TSL parameters	normalized to 1W	23.5 W/kg ± 19.5 % (k=2)

Head TSL parameters at 5600 MHz

The following parameters and calculations were applied.

	Temperature	Permittivity	Conductivity
Nominal Head TSL parameters	22.0 °C	35.5	5.07 mho/m
Measured Head TSL parameters	(22.0 ± 0.2) °C	35.1 ± 6 %	4.98 mho/m ± 6 %
Head TSL temperature change during test	< 0.5 °C	----	----

SAR result with Head TSL at 5600 MHz

SAR averaged over 1 cm ³ (1 g) of Head TSL	Condition	
SAR measured	100 mW input power	8.60 W/kg
SAR for nominal Head TSL parameters	normalized to 1W	85.7 W / kg ± 19.9 % (k=2)

SAR averaged over 10 cm ³ (10 g) of Head TSL	condition	
SAR measured	100 mW input power	2.46 W/kg
SAR for nominal Head TSL parameters	normalized to 1W	24.5 W/kg ± 19.5 % (k=2)

Head TSL parameters at 5750 MHz

The following parameters and calculations were applied.

	Temperature	Permittivity	Conductivity
Nominal Head TSL parameters	22.0 °C	35.4	5.22 mho/m
Measured Head TSL parameters	(22.0 ± 0.2) °C	34.9 ± 6 %	5.14 mho/m ± 6 %
Head TSL temperature change during test	< 0.5 °C	----	----

SAR result with Head TSL at 5750 MHz

SAR averaged over 1 cm ³ (1 g) of Head TSL	Condition	
SAR measured	100 mW input power	8.09 W/kg
SAR for nominal Head TSL parameters	normalized to 1W	80.6 W/kg ± 19.9 % (k=2)

SAR averaged over 10 cm ³ (10 g) of Head TSL	condition	
SAR measured	100 mW input power	2.32 W/kg
SAR for nominal Head TSL parameters	normalized to 1W	23.1 W/kg ± 19.5 % (k=2)

Body TSL parameters at 5250 MHz

The following parameters and calculations were applied.

	Temperature	Permittivity	Conductivity
Nominal Body TSL parameters	22.0 °C	48.9	5.36 mho/m
Measured Body TSL parameters	(22.0 ± 0.2) °C	46.9 ± 6 %	5.49 mho/m ± 6 %
Body TSL temperature change during test	< 0.5 °C	----	----

SAR result with Body TSL at 5250 MHz

SAR averaged over 1 cm ³ (1 g) of Body TSL	Condition	
SAR measured	100 mW input power	7.62 W/kg
SAR for nominal Body TSL parameters	normalized to 1W	75.6 W/kg ± 19.9 % (k=2)

SAR averaged over 10 cm ³ (10 g) of Body TSL	condition	
SAR measured	100 mW input power	2.14 W/kg
SAR for nominal Body TSL parameters	normalized to 1W	21.2 W/kg ± 19.5 % (k=2)

Body TSL parameters at 5600 MHz

The following parameters and calculations were applied.

	Temperature	Permittivity	Conductivity
Nominal Body TSL parameters	22.0 °C	48.5	5.77 mho/m
Measured Body TSL parameters	(22.0 ± 0.2) °C	46.3 ± 6 %	5.96 mho/m ± 6 %
Body TSL temperature change during test	< 0.5 °C	----	----

SAR result with Body TSL at 5600 MHz

SAR averaged over 1 cm ³ (1 g) of Body TSL	Condition	
SAR measured	100 mW input power	7.91 W/kg
SAR for nominal Body TSL parameters	normalized to 1W	78.5 W/kg ± 19.9 % (k=2)

SAR averaged over 10 cm ³ (10 g) of Body TSL	condition	
SAR measured	100 mW input power	2.22 W/kg
SAR for nominal Body TSL parameters	normalized to 1W	22.0 W/kg ± 19.5 % (k=2)

Body TSL parameters at 5750 MHz

The following parameters and calculations were applied.

	Temperature	Permittivity	Conductivity
Nominal Body TSL parameters	22.0 °C	48.3	5.94 mho/m
Measured Body TSL parameters	(22.0 ± 0.2) °C	46.0 ± 6 %	6.16 mho/m ± 6 %
Body TSL temperature change during test	< 0.5 °C	----	----

SAR result with Body TSL at 5750 MHz

SAR averaged over 1 cm ³ (1 g) of Body TSL	Condition	
SAR measured	100 mW input power	7.65 W/kg
SAR for nominal Body TSL parameters	normalized to 1W	75.9 W/kg ± 19.9 % (k=2)

SAR averaged over 10 cm ³ (10 g) of Body TSL	condition	
SAR measured	100 mW input power	2.14 W/kg
SAR for nominal Body TSL parameters	normalized to 1W	21.2 W/kg ± 19.5 % (k=2)

Appendix (Additional assessments outside the scope of SCS 0108)

Antenna Parameters with Head TSL at 5250 MHz

Impedance, transformed to feed point	47.5 Ω - 3.5 j Ω
Return Loss	- 27.0 dB

Antenna Parameters with Head TSL at 5600 MHz

Impedance, transformed to feed point	50.1 Ω + 4.7 j Ω
Return Loss	- 26.7 dB

Antenna Parameters with Head TSL at 5750 MHz

Impedance, transformed to feed point	52.7 Ω + 0.8 j Ω
Return Loss	- 31.2 dB

Antenna Parameters with Body TSL at 5250 MHz

Impedance, transformed to feed point	46.5 Ω - 1.3 j Ω
Return Loss	- 28.2 dB

Antenna Parameters with Body TSL at 5600 MHz

Impedance, transformed to feed point	53.1 Ω + 6.2 j Ω
Return Loss	- 23.5 dB

Antenna Parameters with Body TSL at 5750 MHz

Impedance, transformed to feed point	53.6 Ω + 2.1 j Ω
Return Loss	- 27.9 dB

General Antenna Parameters and Design

Electrical Delay (one direction)	1,195 ns
----------------------------------	----------

After long term use with 100W radiated power, only a slight warming of the dipole near the feedpoint can be measured.

The dipole is made of standard semirigid coaxial cable. The center conductor of the feeding line is directly connected to the second arm of the dipole. The antenna is therefore short-circuited for DC-signals. On some of the dipoles, small end caps are added to the dipole arms in order to improve matching when loaded according to the position as explained in the "Measurement Conditions" paragraph. The SAR data are not affected by this change. The overall dipole length is still according to the Standard.

No excessive force must be applied to the dipole arms, because they might bend or the soldered connections near the feedpoint may be damaged.

Additional EUT Data

Manufactured by	SPEAG
Manufactured on	May 04, 2015

DASY5 Validation Report for Head TSL

Date: 10.08.2018

Test Laboratory: SPEAG, Zurich, Switzerland

DUT: Dipole D5GHzV2; Type: D5GHzV2; Serial: D5GHzV2 - SN:1237

Communication System: UID 0 - CW; Frequency: 5250 MHz, Frequency: 5600 MHz, Frequency: 5750 MHz
Medium parameters used: $f = 5250$ MHz; $\sigma = 4.61$ S/m; $\epsilon_r = 35.6$; $\rho = 1000$ kg/m³,
Medium parameters used: $f = 5600$ MHz; $\sigma = 4.98$ S/m; $\epsilon_r = 35.1$; $\rho = 1000$ kg/m³,
Medium parameters used: $f = 5750$ MHz; $\sigma = 5.14$ S/m; $\epsilon_r = 34.9$; $\rho = 1000$ kg/m³
Phantom section: Flat Section
Measurement Standard: DASY5 (IEEE/IEC/ANSI C63.19-2011)

DASY52 Configuration:

- Probe: EX3DV4 - SN3503; ConvF(5.51, 5.51, 5.51) @ 5250 MHz, ConvF(5.05, 5.05, 5.05) @ 5600 MHz, ConvF(4.98, 4.98, 4.98) @ 5750 MHz; Calibrated: 30.12.2017
- Sensor-Surface: 1.4mm (Mechanical Surface Detection)
- Electronics: DAE4 Sn601 (5GHz); Calibrated: 26.10.2017
- Phantom: Flat Phantom 5.0 (front); Type: QD 000 P50 AA; Serial: 1001
- DASY52 52.10.1(1476); SEMCAD X 14.6.11(7439)

Dipole Calibration for Head Tissue/Pin=100mW, dist=10mm, f=5250 MHz/Zoom Scan,

dist=1.4mm (8x8x7)/Cube 0: Measurement grid: dx=4mm, dy=4mm, dz=1.4mm

Reference Value = 75.17 V/m; Power Drift = -0.03 dB

Peak SAR (extrapolated) = 27.8 W/kg

SAR(1 g) = 8.15 W/kg; SAR(10 g) = 2.36 W/kg

Maximum value of SAR (measured) = 18.4 W/kg

Dipole Calibration for Head Tissue/Pin=100mW, dist=10mm, f=5600 MHz/Zoom Scan,

dist=1.4mm (8x8x7)/Cube 0: Measurement grid: dx=4mm, dy=4mm, dz=1.4mm

Reference Value = 75.53 V/m; Power Drift = -0.05 dB

Peak SAR (extrapolated) = 32.4 W/kg

SAR(1 g) = 8.6 W/kg; SAR(10 g) = 2.46 W/kg

Maximum value of SAR (measured) = 20.2 W/kg

Dipole Calibration for Head Tissue/Pin=100mW, dist=10mm, f=5750 MHz/Zoom Scan,

dist=1.4mm (8x8x7)/Cube 0: Measurement grid: dx=4mm, dy=4mm, dz=1.4mm

Reference Value = 73.04 V/m; Power Drift = -0.04 dB

Peak SAR (extrapolated) = 31.1 W/kg

SAR(1 g) = 8.09 W/kg; SAR(10 g) = 2.32 W/kg

Maximum value of SAR (measured) = 19.9 W/kg

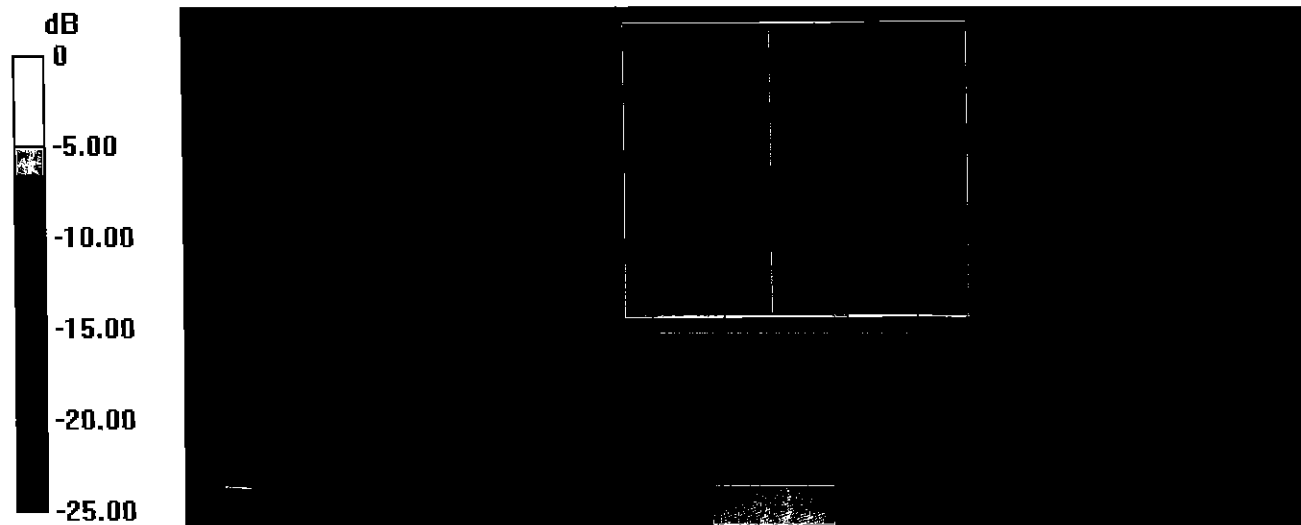

0 dB = 19.9 W/kg = 12.99 dBW/kg

Impedance Measurement Plot for Head TSL

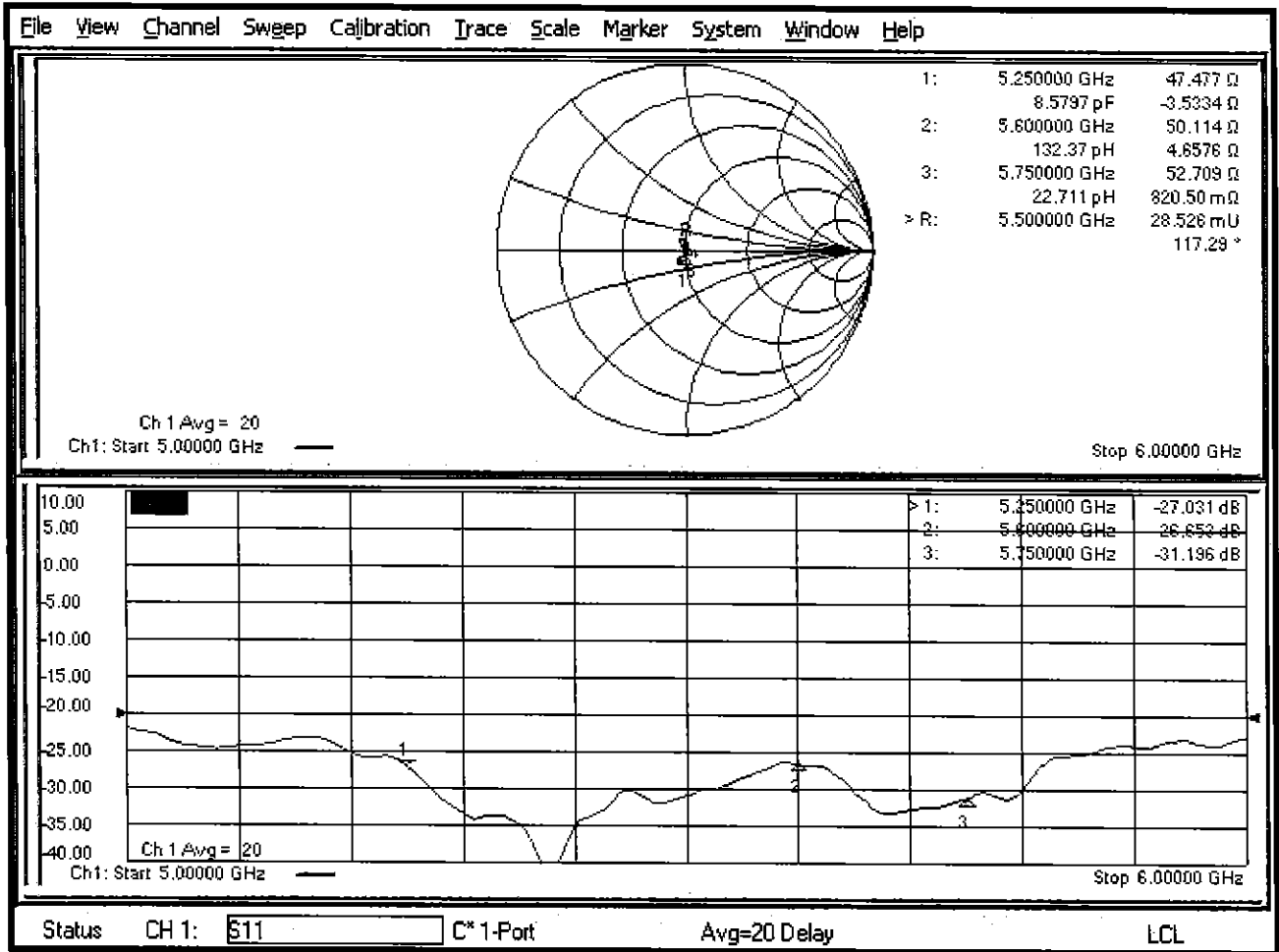

DASY5 Validation Report for Body TSL

Date: 10.08.2018

Test Laboratory: SPEAG, Zurich, Switzerland

DUT: Dipole D5GHzV2; Type: D5GHzV2; Serial: D5GHzV2 - SN:1237

Communication System: UID 0 - CW; Frequency: 5250 MHz, Frequency: 5600 MHz, Frequency: 5750 MHz

Medium parameters used: $f = 5250$ MHz; $\sigma = 5.49$ S/m; $\epsilon_r = 46.9$; $\rho = 1000$ kg/m³,

Medium parameters used: $f = 5600$ MHz; $\sigma = 5.96$ S/m; $\epsilon_r = 46.3$; $\rho = 1000$ kg/m³,

Medium parameters used: $f = 5750$ MHz; $\sigma = 6.16$ S/m; $\epsilon_r = 46$; $\rho = 1000$ kg/m³

Phantom section: Flat Section

Measurement Standard: DASY5 (IEEE/IEC/ANSI C63.19-2011)

DASY52 Configuration:

- Probe: EX3DV4 - SN3503; ConvF(5.26, 5.26, 5.26) @ 5250 MHz, ConvF(4.65, 4.65, 4.65) @ 5600 MHz, ConvF(4.57, 4.57, 4.57) @ 5750 MHz; Calibrated: 30.12.2017
- Sensor-Surface: 1.4mm (Mechanical Surface Detection)
- Electronics: DAE4 Sn601 (5GHz); Calibrated: 26.10.2017
- Phantom: Flat Phantom 5.0 (back); Type: QD 000 P50 AA; Serial: 1002
- DASY52 52.10.1(1476); SEMCAD X 14.6.11(7439)

Dipole Calibration for Body Tissue/Pin=100mW, dist=10mm, f=5250 MHz/Zoom Scan,

dist=1.4mm (8x8x7)/Cube 0: Measurement grid: dx=4mm, dy=4mm, dz=1.4mm

Reference Value = 68.22 V/m; Power Drift = -0.09 dB

Peak SAR (extrapolated) = 28.5 W/kg

SAR(1 g) = 7.62 W/kg; SAR(10 g) = 2.14 W/kg

Maximum value of SAR (measured) = 17.3 W/kg

Dipole Calibration for Body Tissue/Pin=100mW, dist=10mm, f=5600 MHz/Zoom Scan,

dist=1.4mm (8x8x7)/Cube 0: Measurement grid: dx=4mm, dy=4mm, dz=1.4mm

Reference Value = 67.51 V/m; Power Drift = -0.07 dB

Peak SAR (extrapolated) = 32.1 W/kg

SAR(1 g) = 7.91 W/kg; SAR(10 g) = 2.22 W/kg

Maximum value of SAR (measured) = 18.5 W/kg

Dipole Calibration for Body Tissue/Pin=100mW, dist=10mm, f=5750 MHz/Zoom Scan,

dist=1.4mm (8x8x7)/Cube 0: Measurement grid: dx=4mm, dy=4mm, dz=1.4mm

Reference Value = 65.91 V/m; Power Drift = -0.08 dB

Peak SAR (extrapolated) = 31.7 W/kg

SAR(1 g) = 7.65 W/kg; SAR(10 g) = 2.14 W/kg

Maximum value of SAR (measured) = 18.0 W/kg

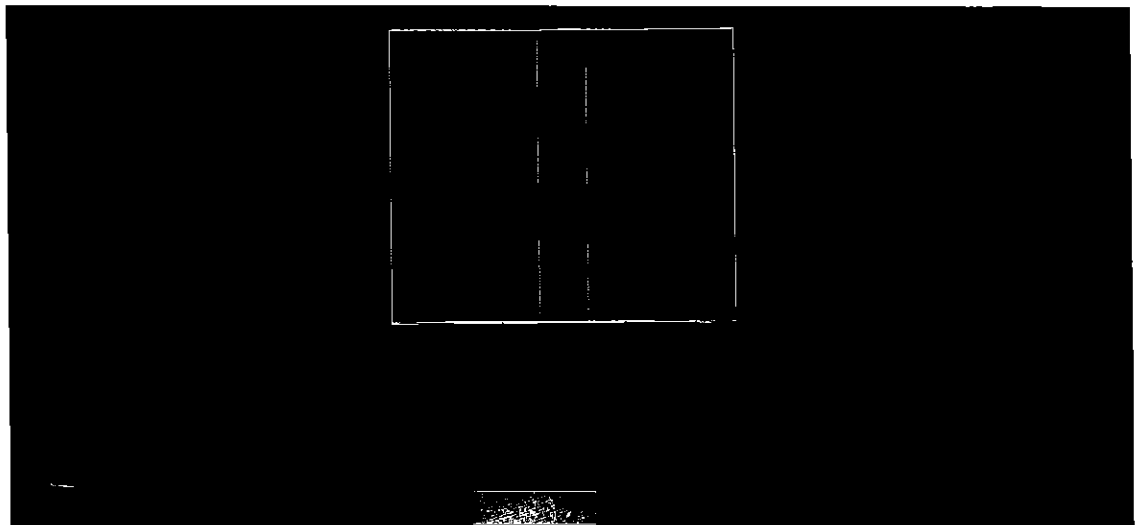

0 dB = 18.0 W/kg = 12.55 dBW/kg

Impedance Measurement Plot for Body TSL

