

# FCC LTE REPORT

## FCC Certification

|  |   |
|--|---|
| <b>Applicant Name:</b><br>LG Electronics MobileComm U.S.A., Inc. | <b>Date of Issue:</b><br>July 12, 2016  |
| <b>Address:</b><br>1000 Sylvan Avenue, Englewood Cliffs NJ 07632 | <b>Location:</b><br>HCT CO., LTD.,<br>74, Seoicheon-ro 578beon-gil, Majang-myeon,<br>Icheon-si, Gyeonggi-do, 17383, Rep. of KOREA |
|  | <b>Report No.:</b> HCT-R-1607-F017<br><b>HCT FRN:</b> 0005866421  |

**FCC ID:** ZNFK600

**APPLICANT:** LG Electronics MobileComm U.S.A., Inc.

**FCC Model(s):** LG-K600  
**Additional FCC Model(s):** LGK600, K600  
**EUT Type:** GSM/WCDMA/LTE Phone with Bluetooth, WLAN, NFC  
**FCC Classification:** Licensed Portable Transmitter Held to Ear (PCE)  
**FCC Rule Part(s):** §27, §2

| Mode (MHz)         | Tx Frequency (MHz) | Emission Designator | Modulation | ERP            |                  |
|--------------------|--------------------|---------------------|------------|----------------|------------------|
|                    |                    |                     |            | Max. Power (W) | Max. Power (dBm) |
| LTE – Band12 (1.4) | 699.7 – 715.3      | 1M09G7D             | QPSK       | 0.070          | 18.48            |
|                    |                    | 1M09W7D             | 16QAM      | 0.058          | 17.64            |
| LTE – Band12 (3)   | 700.5 – 714.5      | 2M69G7D             | QPSK       | 0.074          | 18.71            |
|                    |                    | 2M68W7D             | 16QAM      | 0.059          | 17.72            |
| LTE – Band12 (5)   | 701.5 – 713.5      | 4M50G7D             | QPSK       | 0.073          | 18.64            |
|                    |                    | 4M49W7D             | 16QAM      | 0.059          | 17.71            |
| LTE – Band12 (10)  | 704.0 – 711.0      | 8M98G7D             | QPSK       | 0.069          | 18.39            |
|                    |                    | 8M98W7D             | 16QAM      | 0.058          | 17.63            |

The measurements shown in this report were made in accordance with the procedures specified in CFR47 section §2.947. I assume full responsibility for the accuracy and completeness of these measurements, and for the qualifications of all persons taking them.

HCT CO., LTD. Certifies that no party to this application has subject to a denial of Federal benefits that includes FCC benefits pursuant to section 5301 of the Anti-Drug Abuse Act of 1998, 21 U.S.C. 853(a)



**Report prepared by**  
: Jeong Ho Kim  
**Test engineer of RF Team**



**Approved by**  
: Kyoung Houn Seo  
**Manager of RF Team**

This report only responds to the tested sample and may not be reproduced, except in full, without written approval of the HCT Co., Ltd.

## Version

| TEST REPORT NO. | DATE          | DESCRIPTION             |
|-----------------|---------------|-------------------------|
| HCT-R-1607-F017 | July 12, 2016 | - First Approval Report |
|                 |               |                         |
|                 |               |                         |
|                 |               |                         |

# Table of Contents

|  |    |
|--|----|
| 1. GENERAL INFORMATION .....   | 4  |
| 2. INTRODUCTION .....  | 5  |
| 2.1. EUT DESCRIPTION.....  | 5  |
| 2.2. MEASURING INSTRUMENT CALIBRATION.....                                     | 5  |
| 2.3. TEST FACILITY .....   | 5  |
| 3. DESCRIPTION OF TESTS .....  | 6  |
| 3.1 ERP RADIATED POWER AND RADIATED SPURIOUS EMISSIONS .....                   | 6  |
| 3.2 BLOCK B FREQUENCY RANGE (704 – 710 and 734 – 740 MHz, 777 – 792 MHz) ..... | 6  |
| 3.3 OCCUPIED BANDWIDTH. ....   | 8  |
| 3.4 SPURIOUS AND HARMONIC EMISSIONS AT ANTENNA TERMINAL.....                   | 9  |
| 3.5 FREQUENCY STABILITY / VARIATION OF AMBIENT TEMPERATURE .....               | 10 |
| 4. LIST OF TEST EQUIPMENT .....  | 11 |
| 5. MEASUREMENT UNCERTAINTY.....  | 12 |
| 6. SUMMARY OF TEST RESULTS .....   | 13 |
| 7. SAMPLE CALCULATION.....   | 14 |
| 8. TEST DATA .....   | 15 |
| 8.1 EFFECTIVE RADIATED POWER (Band 12).....                                    | 15 |
| 8.2RADIATED SPURIOUS EMISSIONS.....  | 18 |
| 8.2.1 RADIATED SPURIOUS EMISSIONS (1.4 MHz Band 12 LTE).....                   | 18 |
| 8.2.2 RADIATED SPURIOUS EMISSIONS (3 MHz Band 12 LTE).....                     | 19 |
| 8.2.3RADIATED SPURIOUS EMISSIONS (5 MHz Band 12 LTE) .....                     | 20 |
| 8.2.4 RADIATED SPURIOUS EMISSIONS (10 MHz Band 12 LTE).....                    | 21 |
| 8.3OCCUPIED BANDWIDTH .....  | 22 |
| 8.4CONDUCTED SPURIOUS EMISSIONS .....  | 23 |
| 8.4.1 BAND EDGE.....   | 23 |
| 8.5FREQUENCY STABILITY / VARIATION OF AMBIENT TEMPERATURE .....                | 24 |
| 8.5.1 FREQUENCY STABILITY (1.4 MHz Band 12 LTE).....                           | 24 |
| 8.5.2 FREQUENCY STABILITY (3 MHz Band 12 LTE) .....                            | 25 |
| 8.5.3 FREQUENCY STABILITY (5 MHz Band 12 LTE) .....                            | 26 |
| 8.5.4 FREQUENCY STABILITY (10 MHz Band 12 LTE) .....                           | 27 |
| 9. TEST PLOTS.....   | 28 |

# MEASUREMENT REPORT

## 1. GENERAL INFORMATION

**Applicant Name:** LG Electronics MobileComm U.S.A., Inc.

**Address:** 1000 Sylvan Avenue, Englewood Cliffs NJ 07632

**FCC ID:** ZNFK600

**Application Type:** Certification

**FCC Classification:** Licensed Portable Transmitter Held to Ear (PCE)

**FCC Rule Part(s):** §27, §2

**EUT Type:** GSM/WCDMA/LTE Phone with Bluetooth, WLAN, NFC

**FCC Model(s):** LG-K600

**Additional FCC Model(s):** LGK600, K600

**Tx Frequency:** 699.7 MHz – 715.3 MHz (LTE – Band12 (1.4 MHz))  
700.5 MHz – 714.5 MHz (LTE – Band12 (3 MHz))  
701.5 MHz – 713.5 MHz (LTE – Band12 (5 MHz))  
704.0 MHz – 711.0 MHz (LTE – Band12 (10 MHz))

**Max. RF Output Power:**

|                     |                              |
|---------------------|------------------------------|
| Band 12 (1.4 MHz) : | 0.070 W (QPSK) (18.48 dBm)   |
|                     | 0.058 W (16-QAM) (17.64 dBm) |
| Band 12 (3 MHz) :   | 0.074 W (QPSK) (18.71 dBm)   |
|                     | 0.059 W (16-QAM) (17.72 dBm) |
| Band 12 (5 MHz) :   | 0.073 W (QPSK) (18.64 dBm)   |
|                     | 0.059 W (16-QAM) (17.71 dBm) |
| Band 12 (10 MHz) :  | 0.069 W (QPSK) (18.39 dBm)   |
|                     | 0.058 W (16-QAM) (17.63 dBm) |

**Emission Designator(s):**

|                     |                                   |
|---------------------|-----------------------------------|
| Band 12 (1.4 MHz) : | 1M09G7D (QPSK) / 1M09W7D (16-QAM) |
| Band 12 (3 MHz) :   | 2M69G7D (QPSK) / 2M68W7D (16-QAM) |
| Band 12 (5 MHz) :   | 4M50G7D (QPSK) / 4M49W7D (16-QAM) |
| Band 12 (10 MHz) :  | 8M98G7D (QPSK) / 8M98W7D (16-QAM) |

**Date(s) of Tests:** May 10, 2016 ~ July 06, 2016

**Antenna Specification**

|               |                                  |
|---------------|----------------------------------|
| Manufacturer: | Molex KOREA                      |
| Antenna type: | PIFA Antenna (Planar Inverted F) |
| Peak Gain:    | Band 12: -13.06 dBi              |

## **2. INTRODUCTION**

### **2.1. EUT DESCRIPTION**

The LG Electronics MobileComm U.S.A., Inc.LG-K600 GSM/WCDMA/LTE Phone with Bluetooth, WLAN, NFC consists of LTE 12.

### **2.2. MEASURING INSTRUMENT CALIBRATION**

The measuring equipment, which was utilized in performing the tests documented herein, has been calibrated in accordance with the manufacturer's recommendations for utilizing calibration equipment, which is traceable to recognized national standards.

### **2.3. TEST FACILITY**

The Fully-anechoic chamber and conducted measurement facility used to collect the radiated data are located at the **74, Seoicheon-ro 578beon-gil, Majang-myeon, Icheon-si, Gyeonggi-do, 17383, Rep. of KOREA.**

## **3. DESCRIPTION OF TESTS**

### **3.1 ERP RADIATED POWER AND RADIATED SPURIOUS EMISSIONS**

Note: ERP(Effective Radiated Power)

Test Procedure

Radiated emission measurements are performed in the Fully-anechoic chamber. The equipment under test is placed on a non-conductive table 3-meters away from the receive antenna in accordance with ANSI/TIA-603-D-2010 Clause 2.2.17. The turntable is rotated through 360 degrees, and the receiving antenna scans in order to determine the level of the maximized emission. The level and position of the maximized emission is recorded with the spectrum analyzer using a RMS detector.

A half wave dipole is then substituted in place of the EUT. For emissions above 1GHz, a horn antenna is substituted in place of the EUT. The substitute antenna is driven by a signal generator and the previously recorded signal was duplicated.

The power is calculated by the following formula;

$$P_{d(\text{dBm})} = P_{g(\text{dBm})} - \text{cable loss}_{(\text{dB})} + \text{antenna gain}_{(\text{dB})}$$

Where:  $P_d$  is the dipole equivalent power and  $P_g$  is the generator output power into the substitution antenna.

#### **Radiated spurious emissions**

: Frequency Range : 30 MHz ~ 10<sup>th</sup> Harmonics of highest channel fundamental frequency.

### **3.2 BLOCK B FREQUENCY RANGE (704 – 710 and 734 – 740 MHz, 777 – 792 MHz)**

§27.5(c)

698-746 MHz Band. The following frequencies are available for licensing pursuant to this part in the 698–746 MHz band: (1) Three paired channel blocks of 12 MHz each are available for assignment as follows :

Block A : 698 – 704 MHz and 728 – 734 MHz ;

Block B : 704 – 710 MHz and 734 – 740 MHz ; and

Block C : 710 – 716 MHz and 740 – 746 MHz.

### 5.1.1 Peak power measurements with a spectrum/signal analyzer or EMI receiver

The following procedure can be used to determine the total peak output power.

- a) Set the RBW  $\geq$  OBW.
- b) Set VBW  $\geq 3 \times$  RBW.
- c) Set span  $\geq 2 \times$  RBW
- d) Sweep time = auto couple.
- e) Detector = peak.
- f) Ensure that the number of measurement points  $\geq$  span/RBW.
- g) Trace mode = max hold.
- h) Allow trace to fully stabilize.
- i) Use the peak marker function to determine the peak amplitude level.

### 5.2.2 Procedures for use with a spectrum/signal analyzer when EUT cannot be configured to transmit continuously and sweep triggering/signal gating cannot be properly implemented

If the EUT cannot be configured to transmit continuously (burst duty cycle  $< 98\%$ ), then one of the following procedures can be used. The selection of the applicable procedure will depend on the characteristics of the measured burst duty cycle.

Measure the burst duty cycle with a spectrum/signal analyzer or EMC receiver can be used in zero-span mode if the response time and spacing between bins on the sweep are sufficient to permit accurate measurement of the burst on/off time of the transmitted signal.

#### 5.2.2.2 Constant burst duty cycle

If the measured burst duty cycle is constant (i.e., duty cycle variations are less than  $\pm 2$  percent), then:

- a) Set span to at least 1.5 times the OBW.
- b) Set RBW = 1-5% of the OBW, not to exceed 1 MHz.
- c) Set VBW  $\geq 3 \times$  RBW.
- d) Number of points in sweep  $\geq 2 \times$  span / RBW. (This gives bin-to-bin spacing  $\leq$  RBW/2, so that narrowband signals are not lost between frequency bins.)
- e) Sweep time = auto.
- f) Detector = RMS (power averaging).
- g) Set sweep trigger to "free run".
- h) Trace average at least 100 traces in power averaging (i.e., RMS) mode.
- i) Compute power by integrating the spectrum across the OBW of the signal using the instrument's band power measurement function with band limits set equal to the OBW band edges. If the instrument does not have a band power function, sum the spectrum levels (in power units) at intervals equal to the RBW extending across the entire OBW of the spectrum.
- j) Add  $10 \log (1/x)$ , where  $x$  is the duty cycle, to the measured power in order to compute the average power during the actual transmission times (because the measurement represents an average over both the on and off times of the transmission).

For example, add  $10 \log (1/0.25) = 6$  dB if the duty cycle is a constant 25%.

### 3.3 OCCUPIED BANDWIDTH.

Test set-up

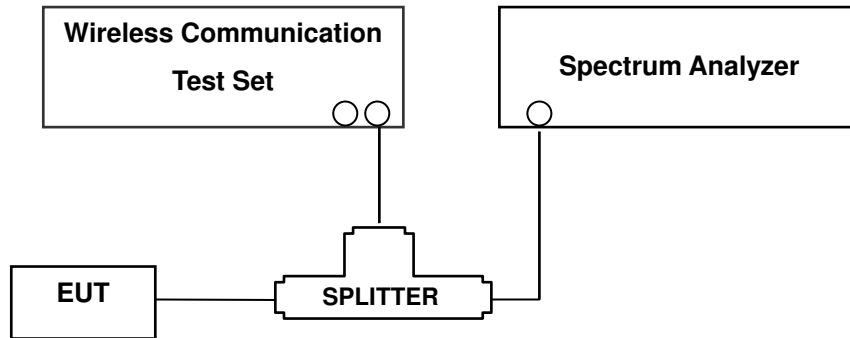

(Configuration of conducted Emission measurement)

The width of a frequency band such that, below the lower and above the upper frequency limits, the mean powers emitted are each equal to a specified percentage 0.5 % of the total mean power of a given emission.

#### Test Procedure

OBW is tested in accordance with KDB971168 D01 Power Meas License Digital Systems v02r02, October 17, 2014, Section 4.2.

The EUT makes a call to the communication simulator. The power was measured with R&S Spectrum Analyzer. All measurements were done at 3 channels(low, middle and high operational range.)

The conducted occupied bandwidth used the power splitter via EUT RF power connector between simulation base station and spectrum analyzer.

The communication simulator station system controlled a EUT to export maximum output power under transmission mode and specific channel frequency. Use OBW measurement function of Spectrum analyzer to measure 99 % occupied bandwidth



### 3.4 SPURIOUS AND HARMONIC EMISSIONS AT ANTENNA TERMINAL.

#### Test Procedure

Spurious and harmonic emissions at antenna terminal is tested in accordance with KDB971168 D01 Power Meas License Digital Systems v02r02, October 17, 2014, Section 6.0.

The level of the carrier and the various conducted spurious and harmonic frequencies is measured by means of a calibrated spectrum analyzer.

The spectrum is scanned from the lowest frequency generated in the equipment up to a frequency including its 10th harmonic. On any frequency outside a licensee's frequency block, the power of any emission shall be attenuated below the transmitter power (P) by at least  $43 + 10 \log(P)$  dB. Compliance with these provisions is based on the use of measurement instrumentation employing a resolution bandwidth of 1 MHz or greater. However, in the 100 kHz bands immediately outside and adjacent to the frequency block a resolution bandwidth of at least 30kHz bandwidth may be employed. The emission bandwidth is defined as the width of the signal between two points, one below the carrier center frequency and one above the carrier center frequency.

**NOTES:** The analyzer plot offsets were determined by below conditions.

- For LTE Band 12, total offset 27.1 dB = 20 dB attenuator + 6 dB Divider + 1.1 dB RF cables.

### 3.5 FREQUENCY STABILITY / VARIATION OF AMBIENT TEMPERATURE

#### Test Set-up

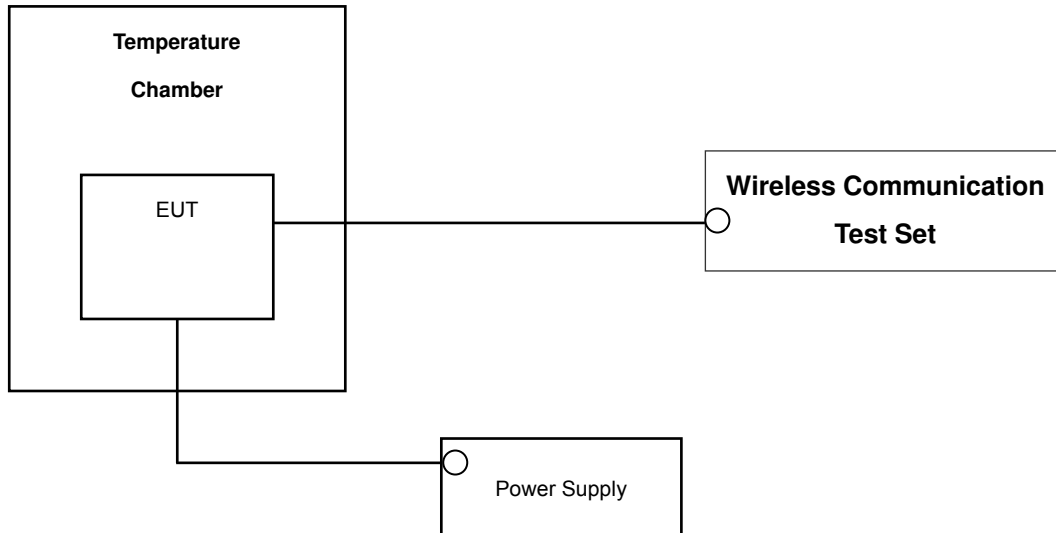

\* Nominal Operating Voltage

#### Test Procedure

Frequency stability is tested in accordance with ANSI/TIA-603-D-2010 section 2.2.2

The frequency stability of the transmitter is measured by:

- a.) **Temperature:** The temperature is varied from - 30 °C to + 50 °C using an environmental chamber.
- b.) **Primary Supply Voltage:** The primary supply voltage is varied from the end point to 100 % of the voltage normally at the input to the device or at the power supply terminals if cables are not normally supplied.

Specification — the frequency stability shall be sufficient to ensure that the fundamental emission stays within the authorized frequency block

#### Time Period and Procedure:

The carrier frequency of the transmitter is measured at room temperature (20°C to provide a reference).

1. The equipment is turned on in a “standby” condition for one minute before applying power to the transmitter. Measurement of the carrier frequency of the transmitter is made within one minute after applying power to the transmitter.
2. Frequency measurements are made at 10°C intervals ranging from -30°C to +50°C. A period of at least one half-hour is provided to allow stabilization of the equipment at each temperature level.

**NOTE: The EUT is tested down to the battery endpoint.**

## 4. LIST OF TEST EQUIPMENT

| Manufacture     | Model/ Equipment                            | Serial Number          | Calibration Interval | Calibration Due |
|-----------------|---|------------------------|----------------------|-----------------|
| MITEQ           | AMF-6D-001180-35-20P/AMP                    | 1081666                | Annual               | 09/03/2016      |
| Wainwright      | WHK1.2/15G-10EF/H.P.F                       | 4                      | Annual               | 04/11/2017      |
| Wainwright      | WHK3.3/18G-10EF/H.P.F                       | 2                      | Annual               | 04/11/2017      |
| Hewlett Packard | 11667B / Power Splitter                     | 10545                  | Annual               | 02/15/2017      |
| Hewlett Packard | 11667B / Power Splitter                     | 11275                  | Annual               | 04/29/2017      |
| ITECH           | IT6720/ Power Supply                        | 0100215626700119       | Annual               | 11/02/2016      |
| Schwarzbeck     | UHAP/ Dipole Antenna                        | 557                    | Biennial             | 03/23/2017      |
| Schwarzbeck     | UHAP/ Dipole Antenna                        | 558                    | Biennial             | 03/23/2017      |
| EXP             | EX-TH400/ Chamber                           | None                   | Annual               | 05/31/2017      |
| Schwarzbeck     | BBHA 9120D/ Horn Antenna                    | 147                    | Biennial             | 09/01/2016      |
| Schwarzbeck     | BBHA 9120D/ Horn Antenna                    | 1299                   | Biennial             | 05/15/2017      |
| Schwarzbeck     | BBHA 9170/ Horn Antenna(15~40GHz)           | BBHA9170342            | Biennial             | 04/30/2017      |
| Schwarzbeck     | BBHA 9170/ Horn Antenna(15~35GHz)           | BBHA9170124            | Biennial             | 04/30/2017      |
| Agilent         | N9020A/Signal Analyzer                      | MY52090906             | Annual               | 05/13/2017      |
| Hewlett Packard | 8493C/ATTENUATOR                            | 17280                  | Annual               | 06/22/2017      |
| REOHDE&SCHWARZ  | FSV40/Spectrum Analyzer                     | 1307.9002K40-100931-NK | Annual               | 06/15/2017      |
| Agilent         | 8960 (E5515C)/ Base Station                 | MY48360800             | Annual               | 10/30/2016      |
| Anritsu Corp.   | MT8820C/Wideband Radio Communication Tester | 6200863156             | Annual               | 02/26/2017      |
| Anritsu Corp.   | MT8820C/Wideband Radio Communication Tester | 6201026545             | Annual               | 02/16/2017      |
| Schwarzbeck     | VULB9160/ Bilog Antenna                     | 3150                   | Biennial             | 11/17/2016      |
| Schwarzbeck     | VULB9160/ Bilog Antenna                     | 3368                   | Biennial             | 10/10/2016      |

## 5. MEASUREMENT UNCERTAINTY

The measurement uncertainties shown below were calculated in accordance with the requirements of ANSI C63.4:2014.

All measurement uncertainty values are shown with a coverage factor of  $k = 2$  to indicate a 95 % level of confidence. The measurement data shown herein meets or exceeds the  $U_{\text{CISPR}}$  measurement uncertainty values specified in CISPR 16-4-2 and, thus, can be compared directly to specified limits to determine compliance.

| Parameter                                | Expanded Uncertainty ( $\pm$ dB) |
|--|----------------------------------|
| Conducted Disturbance (150 kHz ~ 30 MHz) | 1.82                             |
| Radiated Disturbance (9 kHz ~ 30 MHz)    | 3.40                             |
| Radiated Disturbance (30 MHz ~ 1 GHz)    | 4.80                             |
| Radiated Disturbance (1 GHz ~ 18 GHz)    | 6.07                             |

## 6. SUMMARY OF TEST RESULTS

| FCC Part Section(s) | Test Description   | Test Limit  | Test Condition | Test Result |
|---------------------|--|---|----------------|-------------|
| 2.1049              | Occupied Bandwidth   | N/A   | CONDUCTED      | PASS        |
| 2.1051, 27.53(g)    | Band Edge / Spurious and Harmonic Emissions at Antenna Terminal. | $< 43 + 10 \log_{10}(P[\text{Watts}])$ at Band Edge and for all-of-band emissions |                | PASS        |
| *2.1046             | Conducted Output Power   | N/A   |                | PASS        |
| 2.1055, 27.54       | Frequency stability / variation of ambient temperature           | Emission must remain in band  |                | PASS        |
| 27.50(c)(10)        | Effective Radiated Power (Band 12)                               | $< 3$ Watts max. ERP  | RADIATED       | PASS        |
| 2.1053, 27.53(g)    | Undesirable Out-of-Band Emissions                                | $< 43 + 10 \log_{10}(P[\text{Watts}])$ for all out-of-band emissions              |                | PASS        |

\*: See SAR Report

## 7. SAMPLE CALCULATION

### A. ERP Sample Calculation

| Mode       | Ch./ Freq. |            | Measured<br>Level(dBm) | Substitute<br>LEVEL(dBm) | Ant. Gain<br>(dBd) | C.L  | Pol. | Limit<br>W | ERP   |       |
|------------|------------|------------|------------------------|--------------------------|--------------------|------|------|------------|-------|-------|
|            | channel    | Freq.(MHz) |                        |                          |                    |      |      |            | W     | dBm   |
| LTE Band12 | 23095      | 707.50     | -28.85                 | 31.95                    | -10.21             | 1.08 | H    | <3.00      | 0.116 | 20.66 |

**ERP = Substitute LEVEL(dBm) + Ant. Gain – CL(Cable Loss)**

- 1) The EUT mounted on a wooden tripod is 2.5 meter above test site ground level.
- 2) During the test , the turn table is rotated and the antenna height is found.
- 3) Record the field strength meter's level.
- 4) Replace the EUT with dipole/Horn antenna that is connected to a calibrated signal generator.
- 5) Increase the signal generator output till the field strength meter's level is equal to the item (3).
- 6) The signal generator output level with Ant. Gain and cable loss are the rating of effective radiated power (**ERP**).

## B. Emission Designator

### QPSK Modulation

#### **5MHz Bandwidth**

**Emission Designator = 4M48G7D**

LTE BW = 4.48 MHz

G = Phase Modulation

7 = Quantized/Digital Info

D = Data transmission; telemetry; telecommand

#### **10MHz Bandwidth**

**Emission Designator = 8M95G7D**

LTE BW = 8.95 MHz

G = Phase Modulation

7 = Quantized/Digital Info

D = Data transmission; telemetry; telecommand

### 16QAM Modulation

#### **5MHz Bandwidth**

**Emission Designator = 4M48W7D**

LTE BW = 4.48 MHz

W = main carrier modulated in a combination of two or more of the following modes;  
amplitude, angle, pulse

7 = Quantized/Digital Info

D = Data transmission; telemetry; telecommand

#### **10MHz Bandwidth**

**Emission Designator = 8M95W7D**

LTE BW = 8.95 MHz

W = main carrier modulated in a combination of two or more of the following modes;  
amplitude, angle, pulse

7 = Quantized/Digital Info

D = Data transmission; telemetry; telecommand

## 8. TEST DATA

### 8.1 EFFECTIVE RADIATED POWER (Band 12)

| Freq (MHz) | Bandwidth | Modulation | Measured Level (dBm) | Substitute Level (dBm) | Ant. Gain(dBd) | C.L  | Pol | Limit  | ERP   |       |
|------------|-----------|------------|----------------------|------------------------|----------------|------|-----|--------|-------|-------|
|            |           |            |                      |                        |                |      |     | W      | W     | dBm   |
| 699.7      | 1.4 MHz   | QPSK       | -32.15               | 30.06                  | -10.17         | 1.54 | V   | < 3.00 | 0.068 | 18.35 |
|            |           | 16-QAM     | -32.95               | 29.26                  | -10.17         | 1.54 | V   |        | 0.057 | 17.55 |
| 707.5      |           | QPSK       | -31.57               | 30.23                  | -10.21         | 1.54 | V   |        | 0.070 | 18.48 |
|            |           | 16-QAM     | -32.41               | 29.39                  | -10.21         | 1.54 | V   |        | 0.058 | 17.64 |
| 715.3      |           | QPSK       | -31.24               | 30.17                  | -10.25         | 1.55 | V   |        | 0.069 | 18.37 |
|            |           | 16-QAM     | -32.05               | 29.36                  | -10.25         | 1.55 | V   |        | 0.057 | 17.56 |

#### Effective Radiated Power Data (1.4 MHz Band 12 LTE)

Note: All of RB size has been tested for emissions and ERP, with the 1RB configuration observed as the worst case

| Freq (MHz) | Bandwidth | Modulation | Measured Level (dBm) | Substitute Level (dBm) | Ant. Gain(dBd) | C.L  | Pol | Limit  | ERP   |       |
|------------|-----------|------------|----------------------|------------------------|----------------|------|-----|--------|-------|-------|
|            |           |            |                      |                        |                |      |     | W      | W     | dBm   |
| 700.5      | 3 MHz     | QPSK       | -31.94               | 30.22                  | -10.17         | 1.54 | V   | < 3.00 | 0.071 | 18.51 |
|            |           | 16-QAM     | -32.84               | 29.32                  | -10.17         | 1.54 | V   |        | 0.058 | 17.61 |
| 707.5      |           | QPSK       | -31.34               | 30.46                  | -10.21         | 1.54 | V   |        | 0.074 | 18.71 |
|            |           | 16-QAM     | -32.33               | 29.47                  | -10.21         | 1.54 | V   |        | 0.059 | 17.72 |
| 714.5      |           | QPSK       | -31.05               | 21.39                  | -10.25         | 1.55 | V   |        | 0.009 | 9.59  |
|            |           | 16-QAM     | -32.02               | 20.42                  | -10.25         | 1.55 | V   |        | 0.007 | 8.62  |

#### Effective Radiated Power Data (3 MHz Band 12 LTE)

Note: All of RB size has been tested for emissions and ERP, with the 1RB configuration observed as the worst case

| Freq (MHz) | Bandwidth | Modulation | Measured Level (dBm) | Substitute Level (dBm) | Ant. Gain(dBd) | C.L  | Pol | Limit  | ERP   |       |
|------------|-----------|------------|----------------------|------------------------|----------------|------|-----|--------|-------|-------|
|            |           |            |                      |                        |                |      |     | W      | W     | dBm   |
| 701.5      | 5 MHz     | QPSK       | -32.07               | 30.00                  | -10.18         | 1.54 | V   | < 3.00 | 0.067 | 18.28 |
|            |           | 16-QAM     | -32.94               | 29.13                  | -10.18         | 1.54 | V   |        | 0.055 | 17.41 |
| 707.5      |           | QPSK       | -31.41               | 30.39                  | -10.21         | 1.54 | V   |        | 0.073 | 18.64 |
|            |           | 16-QAM     | -32.34               | 29.46                  | -10.21         | 1.54 | V   |        | 0.059 | 17.71 |
| 713.5      |           | QPSK       | -31.05               | 30.38                  | -10.24         | 1.55 | V   |        | 0.072 | 18.59 |
|            |           | 16-QAM     | -31.97               | 29.47                  | -10.24         | 1.55 | V   |        | 0.059 | 17.68 |

**Effective Radiated Power Data (5 MHz Band 12 LTE)**

Note: All of RB size has been tested for emissions and ERP, with the 1RB configuration observed as the worst case

| Freq (MHz) | Bandwidth | Modulation | Measured Level (dBm) | Substitute Level (dBm) | Ant. Gain(dBd) | C.L  | Pol | Limit  | ERP   |       |
|------------|-----------|------------|----------------------|------------------------|----------------|------|-----|--------|-------|-------|
|            |           |            |                      |                        |                |      |     | W      | W     | dBm   |
| 704.0      | 10 MHz    | QPSK       | -32.10               | 29.84                  | -10.19         | 1.54 | V   | < 3.00 | 0.065 | 18.11 |
|            |           | 16-QAM     | -32.85               | 29.09                  | -10.19         | 1.54 | V   |        | 0.054 | 17.36 |
| 707.5      |           | QPSK       | -31.67               | 30.13                  | -10.21         | 1.54 | V   |        | 0.069 | 18.38 |
|            |           | 16-QAM     | -32.42               | 29.38                  | -10.21         | 1.54 | V   |        | 0.058 | 17.63 |
| 711.0      |           | QPSK       | -31.32               | 30.17                  | -10.23         | 1.55 | V   |        | 0.069 | 18.39 |
|            |           | 16-QAM     | -32.14               | 29.35                  | -10.23         | 1.55 | V   |        | 0.057 | 17.57 |

**Effective Radiated Power Data (10 MHz Band 12 LTE)**

Note: All of RB size has been tested for emissions and ERP, with the 1RB configuration observed as the worst case



**NOTES:**

Effective Radiated Power Output Measurements by Substitution Method

according to ANSI/TIA/EIA-603-D-2010 June 24, 2010:

The EUT was placed on a non-conductive styrofoam resin table 3-meters from the receive antenna. The receive antenna height and turntable rotation was adjusted for the highest reading on the receive spectrum analyzer. For LTE signals, RBW = 1-5% of the OBW, not to exceed 1MHz, VBW  $\geq 3 \times$  RBW, Detector = RMS. A half-wave dipole was substituted in place of the EUT. This dipole antenna was driven by a signal generator and the level of the signal generator was adjusted to obtain the same receive spectrum analyzer reading. The conducted power at the terminals of the dipole is measured. The ERP is recorded.

Also, we have done x, y, z planes in EUT and horizontal and vertical polarization in detecting antenna. The worst case of the EUT is y plane in LTE mode. Also worst case of detecting Antenna is vertical polarization in LTE mode.

## 8.2 RADIATED SPURIOUS EMISSIONS

### 8.2.1 RADIATED SPURIOUS EMISSIONS (1.4 MHz Band 12 LTE)

- ▣ OPERATING FREQUENCY: 707.50 MHz
- ▣ MEASURED OUTPUT POWER: 18.48 dBm = 0.070 W
- ▣ MODULATION SIGNAL: 1.4 MHz QPSK
- ▣ DISTANCE: 3 meters
- ▣ LIMIT:  $43 + 10 \log_{10}(W) =$  31.48 dBc

| Ch               | Freq (MHz) | Measured Level (dBm) | Ant. Gain (dBd) | Substitute Level (dBm) | C.L  | Pol | ERP (dBm) | dBc   |
|------------------|------------|----------------------|-----------------|------------------------|------|-----|-----------|-------|
| 23017<br>(699.7) | 1,399.40   | -58.83               | 7.96            | -59.14                 | 2.21 | V   | -53.39    | 71.87 |
|                  | 2,099.10   | -60.25               | 10.43           | -60.13                 | 2.72 | V   | -52.42    | 70.90 |
|                  | 2,798.80   | -60.33               | 11.17           | -58.01                 | 3.11 | V   | -49.95    | 68.43 |
| 23095<br>(707.5) | 1,415.00   | -59.11               | 8.06            | -58.88                 | 2.23 | V   | -53.05    | 71.53 |
|                  | 2,122.50   | -58.98               | 10.44           | -57.88                 | 2.78 | V   | -50.22    | 68.70 |
|                  | 2,830.00   | -59.39               | 11.19           | -56.92                 | 3.14 | H   | -48.87    | 67.35 |
| 23173<br>(715.3) | 1,430.60   | -58.26               | 8.15            | -58.48                 | 2.22 | H   | -52.55    | 71.03 |
|                  | 2,145.90   | -58.90               | 10.50           | -57.41                 | 2.75 | V   | -49.66    | 68.14 |
|                  | 2,861.20   | -60.11               | 11.20           | -57.73                 | 3.13 | V   | -49.66    | 68.14 |

- NOTES:**
1. Radiated Spurious Emission Measurements at 3 meters by Substitution Method according to ANSI/TIA/EIA-603-D-2010 June 24, 2010:
  2. We are performed all frequency to 10<sup>th</sup> harmonics from 30 MHz. Measurements above show only up to 3 maximum emissions noted, or would be lesser if no specific emissions from the EUT are recorded (ie: margin > 20 dB from the applicable limit) and considered that's already beyond the background noise floor.
  3. We have done x, y, z planes in EUT and horizontal and vertical polarization in detecting antenna.
  4. All of RB size has been tested for emissions and ERP, with the 1RB configuration observed as the worst case
  5. We are performed 16QAM and QPSK modulations. The worst case data are reported in the table above.

### 8.2.2 RADIATED SPURIOUS EMISSIONS (3 MHz Band 12 LTE)

- ▣ OPERATING FREQUENCY: 707.50 MHz
- ▣ MEASURED OUTPUT POWER: 18.71 dBm = 0.074 W
- ▣ MODULATION SIGNAL: 3 MHz QPSK
- ▣ DISTANCE: 3 meters
- ▣ LIMIT:  $43 + 10 \log_{10}(W) =$  31.71dBc

| Ch               | Freq (MHz) | Measured Level (dBm) | Ant. Gain (dBd) | Substitute Level (dBm) | C.L  | Pol | ERP (dBm) | dBc   |
|------------------|------------|----------------------|-----------------|------------------------|------|-----|-----------|-------|
| 23025<br>(700.5) | 1,401.00   | -58.93               | 7.96            | -59.24                 | 2.21 | V   | -53.49    | 72.20 |
|                  | 2,101.50   | -59.53               | 10.43           | -59.41                 | 2.72 | H   | -51.70    | 70.41 |
|                  | 2,802.00   | -58.98               | 11.17           | -56.66                 | 3.11 | H   | -48.60    | 67.31 |
| 23095<br>(707.5) | 1,415.00   | -59.05               | 8.06            | -58.82                 | 2.23 | V   | -52.99    | 71.70 |
|                  | 2,122.50   | -59.00               | 10.44           | -57.90                 | 2.78 | H   | -50.24    | 68.95 |
|                  | 2,830.00   | -59.82               | 11.19           | -57.35                 | 3.14 | V   | -49.30    | 68.01 |
| 23165<br>(714.5) | 1,429.00   | -58.68               | 8.15            | -58.90                 | 2.22 | V   | -52.97    | 71.68 |
|                  | 2,143.50   | -59.10               | 10.50           | -57.61                 | 2.75 | H   | -49.86    | 68.57 |
|                  | 2,858.00   | -59.41               | 11.20           | -57.03                 | 3.13 | V   | -48.96    | 67.67 |

- NOTES:**
1. Radiated Spurious Emission Measurements at 3 meters by Substitution Method according to ANSI/TIA/EIA-603-D-2010 June 24, 2010:
  2. We are performed all frequency to 10<sup>th</sup> harmonics from 30 MHz. Measurements above show only up to 3 maximum emissions noted, or would be lesser if no specific emissions from the EUT are recorded (ie: margin > 20 dB from the applicable limit) and considered that's already beyond the background noise floor.
  3. We have done x, y, z planes in EUT and horizontal and vertical polarization in detecting antenna.
  4. All of RB size has been tested for emissions and ERP, with the 1RB configuration observed as the worst case
  5. We are performed 16QAM and QPSK modulations. The worst case data are reported in the table above.

### 8.2.3 RADIATED SPURIOUS EMISSIONS (5 MHz Band 12 LTE)

- ▣ OPERATING FREQUENCY: 707.50 MHz
- ▣ MEASURED OUTPUT POWER: 18.64 dBm = 0.073 W
- ▣ MODULATION SIGNAL: 5 MHz QPSK
- ▣ DISTANCE: 3 meters
- ▣ LIMIT:  $43 + 10 \log_{10}(W) =$  31.64dBc

| Ch               | Freq (MHz) | Measured Level (dBm) | Ant. Gain (dBd) | Substitute Level (dBm) | C.L  | Pol | ERP (dBm) | dBc   |
|------------------|------------|----------------------|-----------------|------------------------|------|-----|-----------|-------|
| 23035<br>(701.5) | 1,403.00   | -57.91               | 7.96            | -57.76                 | 2.21 | V   | -52.01    | 70.65 |
|                  | 2,104.50   | -59.43               | 10.44           | -58.82                 | 2.75 | V   | -51.13    | 69.77 |
|                  | 2,806.00   | -60.58               | 11.18           | -58.09                 | 3.11 | H   | -50.02    | 68.66 |
| 23095<br>(707.5) | 1,415.00   | -57.44               | 8.06            | -57.21                 | 2.23 | H   | -51.38    | 70.02 |
|                  | 2,122.50   | -58.41               | 10.44           | -57.31                 | 2.78 | H   | -49.65    | 68.29 |
|                  | 2,830.00   | -60.25               | 11.19           | -57.78                 | 3.14 | H   | -49.73    | 68.37 |
| 23155<br>(713.5) | 1,427.00   | -58.12               | 8.15            | -58.34                 | 2.22 | H   | -52.41    | 71.05 |
|                  | 2,140.50   | -58.92               | 10.49           | -57.44                 | 2.74 | V   | -49.69    | 68.33 |
|                  | 2,854.00   | -59.76               | 11.20           | -57.35                 | 3.13 | H   | -49.28    | 67.92 |

- NOTES:**
1. Radiated Spurious Emission Measurements at 3 meters by Substitution Method according to ANSI/TIA/EIA-603-D-2010 June 24, 2010:
  2. We are performed all frequency to 10<sup>th</sup> harmonics from 30 MHz. Measurements above show only up to 3 maximum emissions noted, or would be lesser if no specific emissions from the EUT are recorded (ie: margin > 20 dB from the applicable limit) and considered that's already beyond the background noise floor.
  3. We have done x, y, z planes in EUT and horizontal and vertical polarization in detecting antenna.
  4. All of RB size has been tested for emissions and ERP, with the 1RB configuration observed as the worst case
  5. We are performed 16QAM and QPSK modulations. The worst case data are reported in the table above.

### 8.2.4 RADIATED SPURIOUS EMISSIONS (10 MHz Band 12 LTE)

- ▣ OPERATING FREQUENCY: 711.00 MHz
- ▣ MEASURED OUTPUT POWER: 18.39 dBm = 0.069 W
- ▣ MODULATION SIGNAL: 10 MHz QPSK
- ▣ DISTANCE: 3 meters
- ▣ LIMIT:  $43 + 10 \log_{10}(W) =$  31.39dBc

| Ch               | Freq (MHz) | Measured Level (dBm) | Ant. Gain (dBd) | Substitute Level (dBm) | C.L  | Pol | ERP (dBm) | dBc   |
|------------------|------------|----------------------|-----------------|------------------------|------|-----|-----------|-------|
| 23060<br>(704.0) | 1,408.00   | -57.67               | 8.03            | -57.34                 | 2.21 | V   | -51.52    | 69.91 |
|                  | 2,112.00   | -59.31               | 10.44           | -58.21                 | 2.78 | V   | -50.55    | 68.94 |
|                  | 2,816.00   | -59.45               | 11.18           | -57.14                 | 3.15 | V   | -49.11    | 67.50 |
| 23095<br>(707.5) | 1,415.00   | -57.81               | 8.06            | -57.58                 | 2.23 | H   | -51.75    | 70.14 |
|                  | 2,122.50   | -59.26               | 10.44           | -58.16                 | 2.78 | H   | -50.50    | 68.89 |
|                  | 2,830.00   | -59.04               | 11.19           | -56.57                 | 3.14 | V   | -48.52    | 66.91 |
| 23130<br>(711.0) | 1,422.00   | -57.63               | 8.09            | -57.52                 | 2.24 | H   | -51.67    | 70.06 |
|                  | 2,133.00   | -59.54               | 10.47           | -58.12                 | 2.72 | V   | -50.37    | 68.76 |
|                  | 2,844.00   | -59.70               | 11.20           | -57.29                 | 3.13 | H   | -49.22    | 67.61 |

- NOTES:**
1. Radiated Spurious Emission Measurements at 3 meters by Substitution Method according to ANSI/TIA/EIA-603-D-2010 June 24, 2010:
  2. We are performed all frequency to 10<sup>th</sup> harmonics from 30 MHz. Measurements above show only up to 3 maximum emissions noted, or would be lesser if no specific emissions from the EUT are recorded (ie: margin > 20 dB from the applicable limit) and considered that's already beyond the background noise floor.
  3. We have done x, y, z planes in EUT and horizontal and vertical polarization in detecting antenna.
  4. All of RB size has been tested for emissions and ERP, with the 1RB configuration observed as the worst case
  5. We are performed 16QAM and QPSK modulations. The worst case data are reported in the table above.

**8.3 OCCUPIED BANDWIDTH**

| Band | Band Width (MHz) | Frequency (MHz) | Modulation | Resource Block Size | Resource Block Offset | Data ( MHz ) |
|------|------------------|-----------------|------------|---------------------|-----------------------|--------------|
| 12   | 1.4              | 707.5           | QPSK       | 6                   | 0                     | 1.0920       |
|      |                  |                 | 16-QAM     | 6                   |                       | 1.0915       |
|      | 3                |                 | QPSK       | 15                  |                       | 2.6874       |
|      |                  |                 | 16-QAM     | 15                  |                       | 2.6849       |
|      | 5                |                 | QPSK       | 25                  |                       | 4.5029       |
|      |                  |                 | 16-QAM     | 25                  |                       | 4.4925       |
|      | 10               |                 | QPSK       | 50                  |                       | 8.9755       |
|      |                  |                 | 16-QAM     | 50                  |                       | 8.9826       |

- Plots of the EUT's Occupied Bandwidth are shown Page 29 ~ 32.

### 8.4 CONDUCTED SPURIOUS EMISSIONS

■ FACTORS FOR FREQUENCY

| Frequency Range (GHz) | Factor [dB] |
|-----------------------|-------------|
| 0.03 – 1              | 27.145      |
| 1 – 5                 | 26.960      |
| 5 – 10                | 27.542      |
| 10 – 15               | 28.439      |
| 15 – 20               | 29.144      |
| Above 20              | 30.148      |

**NOTES:**

Factor(dB) = Cable Loss + Attenuator + Power Splitter

| Band | Band Width (MHz) | Frequency (MHz) | Frequency of Maximum Harmonic (GHz) | Factor (dB) | Measurement Maximum Data (dBm) | Result (dBm) | Limit (dBm) |
|------|------------------|-----------------|-------------------------------------|-------------|--------------------------------|--------------|-------------|
| 12   | 1.4              | 699.7           | 5.4876                              | 27.542      | -58.851                        | -31.309      | -13.00      |
|      |                  | 707.5           | 3.6840                              | 26.960      | -59.743                        | -32.783      |             |
|      |                  | 715.3           | 3.3560                              | 26.960      | -59.323                        | -32.363      |             |
|      | 3                | 700.5           | 5.6416                              | 27.542      | -60.673                        | -33.131      |             |
|      |                  | 707.5           | 3.7079                              | 26.960      | -59.882                        | -32.922      |             |
|      |                  | 714.5           | 3.6985                              | 26.960      | -59.072                        | -32.112      |             |
|      | 5                | 701.5           | 3.6855                              | 26.960      | -60.193                        | -33.233      |             |
|      |                  | 707.5           | 3.7149                              | 26.960      | -59.219                        | -32.259      |             |
|      |                  | 713.5           | 6.5025                              | 27.542      | -60.177                        | -32.635      |             |
|      | 10               | 704.0           | 7.2418                              | 27.542      | -59.835                        | -32.293      |             |
|      |                  | 707.5           | 7.2563                              | 27.542      | -59.143                        | -31.601      |             |
|      |                  | 711.0           | 3.7099                              | 26.960      | -59.983                        | -33.023      |             |

**NOTES:**

1. Conducted Spurious Emissions was Tested QPSK Modulation, Resource Block Size 1 and Resource Block Offset 0
2. Result (dBm) = Measurement Maximum Data (dBm) + Factor (dB)

- Plots of the EUT's Conducted Spurious Emissions are shown Page 45 ~ 50.

#### 8.4.1 BAND EDGE

- Plots of the EUT's Band Edge are shown Page 33 ~ 44.

**8.5 FREQUENCY STABILITY / VARIATION OF AMBIENT TEMPERATURE**

**8.5.1 FREQUENCY STABILITY (1.4 MHz Band 12 LTE)**

- ▣ OPERATING FREQUENCY: 707,500,000 Hz
- ▣ CHANNEL: 23095 (1.4 MHz)
- ▣ REFERENCE VOLTAGE: 3.85 VDC
- ▣ DEVIATION LIMIT: Emission must remain in band

| Voltage (%)    | Power (VDC) | Temp. (°C) | Frequency (Hz) | Frequency Error (Hz) | Deviation (%) | ppm     |
|----------------|-------------|------------|----------------|----------------------|---------------|---------|
| 100%           | 3.85        | +20(Ref)   | 707 499 998    | 0.0                  | 0.000 000     | 0.0000  |
| 100%           |             | -30        | 707 499 994    | -3.3                 | 0.000 000     | -0.0047 |
| 100%           |             | -20        | 707 500 000    | 2.8                  | 0.000 000     | 0.0040  |
| 100%           |             | -10        | 707 499 994    | -3.3                 | 0.000 000     | -0.0047 |
| 100%           |             | 0          | 707 499 995    | -2.4                 | 0.000 000     | -0.0034 |
| 100%           |             | +10        | 707 499 993    | -4.8                 | -0.000 001    | -0.0068 |
| 100%           |             | +30        | 707 499 994    | -3.8                 | -0.000 001    | -0.0054 |
| 100%           |             | +40        | 707 499 995    | -2.6                 | 0.000 000     | -0.0037 |
| 100%           |             | +50        | 707 500 001    | 3.4                  | 0.000 000     | 0.0048  |
| Batt. Endpoint | 3.60        | +20        | 707 500 001    | 3.1                  | 0.000 000     | 0.0044  |

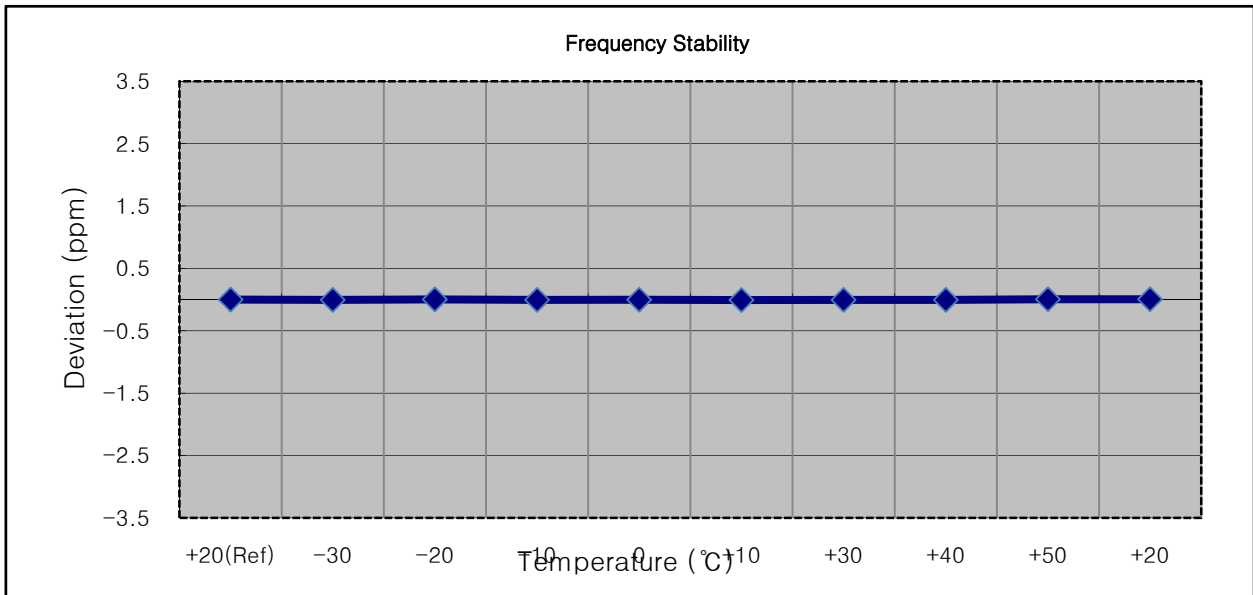



**8.5.2 FREQUENCY STABILITY (3 MHz Band 12 LTE)**

- ▣ OPERATING FREQUENCY: 707,500,000 Hz
- ▣ CHANNEL: 23095 (3 MHz)
- ▣ REFERENCE VOLTAGE: 3.85 VDC
- ▣ DEVIATION LIMIT: Emission must remain in band

| Voltage (%)    | Power (VDC) | Temp. (°C) | Frequency (Hz) | Frequency Error (Hz) | Deviation (%) | ppm     |
|----------------|-------------|------------|----------------|----------------------|---------------|---------|
| 100%           | 3.85        | +20(Ref)   | 707 500 002    | 0.0                  | 0.000 000     | 0.0000  |
| 100%           |             | -30        | 707 500 004    | 2.4                  | 0.000 000     | 0.0034  |
| 100%           |             | -20        | 707 499 997    | -5.0                 | -0.000 001    | -0.0071 |
| 100%           |             | -10        | 707 499 999    | -3.3                 | 0.000 000     | -0.0047 |
| 100%           |             | 0          | 707 499 998    | -3.4                 | 0.000 000     | -0.0048 |
| 100%           |             | +10        | 707 500 004    | 2.5                  | 0.000 000     | 0.0035  |
| 100%           |             | +30        | 707 499 998    | -3.6                 | -0.000 001    | -0.0051 |
| 100%           |             | +40        | 707 499 997    | -4.5                 | -0.000 001    | -0.0064 |
| 100%           |             | +50        | 707 499 999    | -3.1                 | 0.000 000     | -0.0044 |
| Batt. Endpoint | 3.60        | +20        | 707 499 997    | -4.4                 | -0.000 001    | -0.0062 |

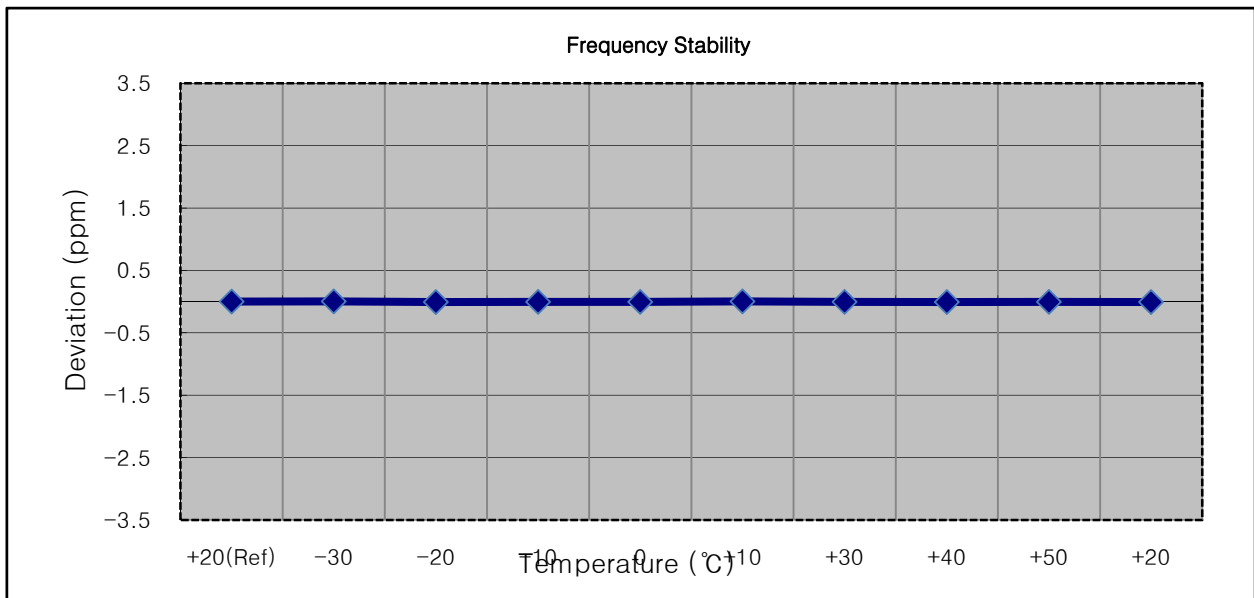

**8.5.3 FREQUENCY STABILITY (5 MHz Band 12 LTE)**

- ▣ OPERATING FREQUENCY: 707,500,000 Hz
- ▣ CHANNEL: 23095 (5 MHz)
- ▣ REFERENCE VOLTAGE: 3.85 VDC
- ▣ DEVIATION LIMIT: Emission must remain in band

| Voltage (%)    | Power (VDC) | Temp. (°C) | Frequency (Hz) | Frequency Error (Hz) | Deviation (%) | ppm    |
|----------------|-------------|------------|----------------|----------------------|---------------|--------|
| 100%           | 3.85        | +20(Ref)   | 707 500 002    | 0.0                  | 0.000 000     | 0.000  |
| 100%           |             | -30        | 707 500 005    | 3.1                  | 0.000 000     | 0.004  |
| 100%           |             | -20        | 707 499 998    | -4.0                 | -0.000 001    | -0.006 |
| 100%           |             | -10        | 707 499 997    | -4.8                 | -0.000 001    | -0.007 |
| 100%           |             | 0          | 707 499 999    | -2.8                 | 0.000 000     | -0.004 |
| 100%           |             | +10        | 707 500 004    | 2.1                  | 0.000 000     | 0.003  |
| 100%           |             | +30        | 707 500 004    | 2.0                  | 0.000 000     | 0.003  |
| 100%           |             | +40        | 707 499 999    | -3.0                 | 0.000 000     | -0.004 |
| 100%           |             | +50        | 707 500 004    | 2.1                  | 0.000 000     | 0.003  |
| Batt. Endpoint | 3.60        | +20        | 707 500 006    | 3.7                  | 0.000 001     | 0.005  |

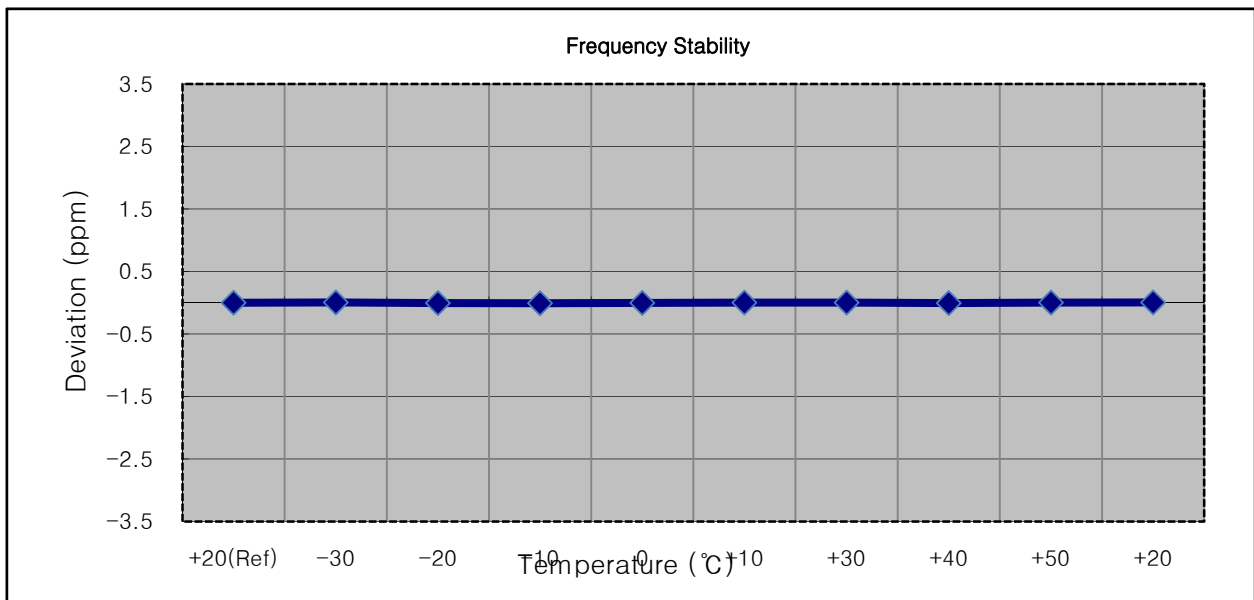

**8.5.4 FREQUENCY STABILITY (10 MHz Band 12 LTE)**

- ▣ OPERATING FREQUENCY: 707,500,000 Hz
- ▣ CHANNEL: 23095 (10 MHz)
- ▣ REFERENCE VOLTAGE: 3.85 VDC
- ▣ DEVIATION LIMIT: Emission must remain in band

| Voltage (%)    | Power (VDC) | Temp. (°C) | Frequency (Hz) | Frequency Error (Hz) | Deviation (%) | ppm    |
|----------------|-------------|------------|----------------|----------------------|---------------|--------|
| 100%           | 3.85        | +20(Ref)   | 707 500 003    | 0.0                  | 0.000 000     | 0.000  |
| 100%           |             | -30        | 707 500 000    | -3.1                 | 0.000 000     | -0.004 |
| 100%           |             | -20        | 707 500 006    | 2.9                  | 0.000 000     | 0.004  |
| 100%           |             | -10        | 707 500 000    | -2.3                 | 0.000 000     | -0.003 |
| 100%           |             | 0          | 707 500 000    | -2.9                 | 0.000 000     | -0.004 |
| 100%           |             | +10        | 707 500 007    | 4.2                  | 0.000 001     | 0.006  |
| 100%           |             | +30        | 707 500 001    | -1.8                 | 0.000 000     | -0.003 |
| 100%           |             | +40        | 707 499 997    | -5.5                 | -0.000 001    | -0.008 |
| 100%           |             | +50        | 707 499 998    | -4.3                 | -0.000 001    | -0.006 |
| Batt. Endpoint | 3.60        | +20        | 707 500 005    | 2.0                  | 0.000 000     | 0.003  |

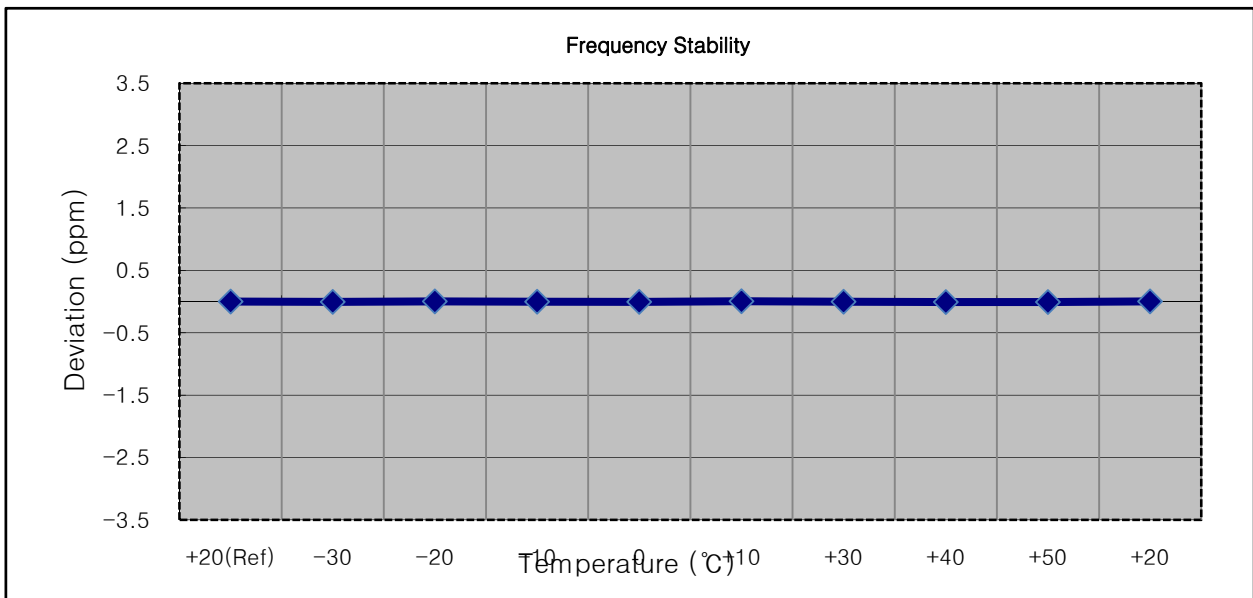

## 9. TEST PLOTS

BAND 12. Occupied Bandwidth Plot (1.4M BW Ch.23095 QPSK\_RB6\_0)

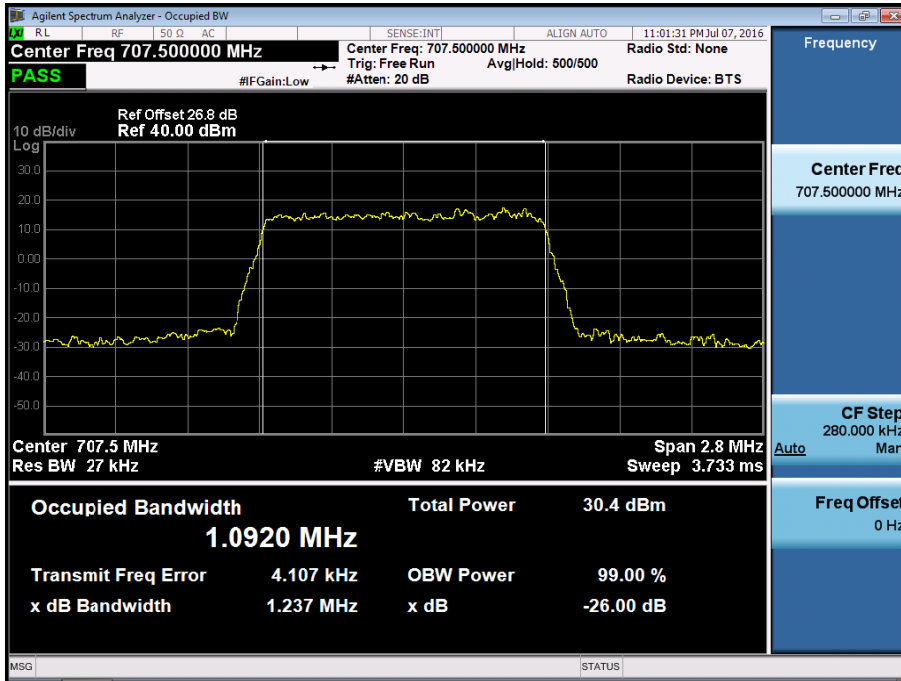

BAND 12. Occupied Bandwidth Plot (1.4M BW Ch.23095 16QAM\_RB6\_0)

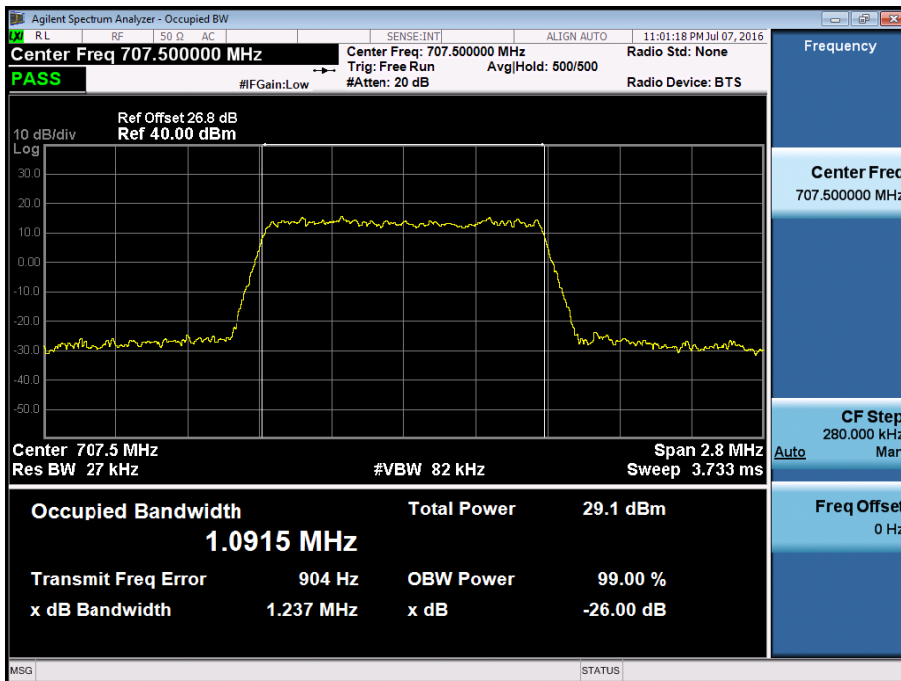

BAND 12. Occupied Bandwidth Plot (3M BW Ch.23095 QPSK\_RB15\_0)

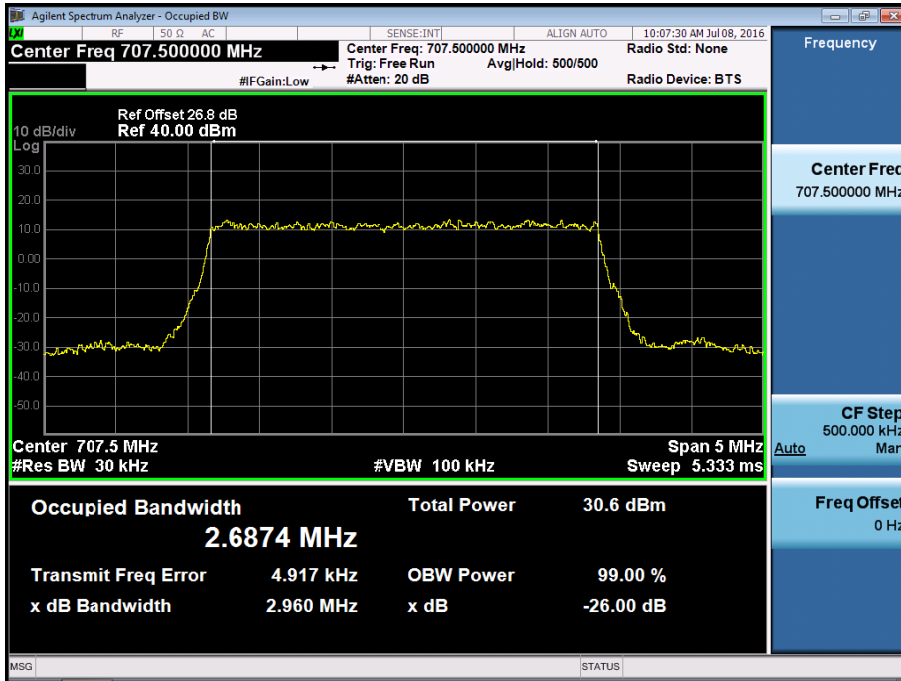

BAND 12. Occupied Bandwidth Plot (3M BW Ch.23095 16QAM\_RB15\_0)

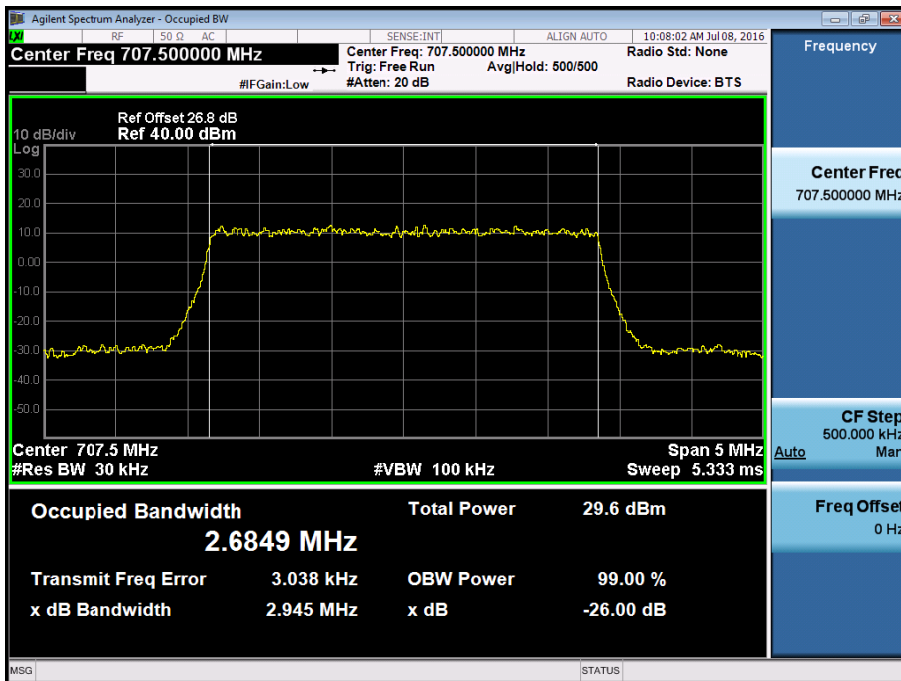

BAND 12. Occupied Bandwidth Plot (5M BW Ch.23095 QPSK\_RB25\_0)

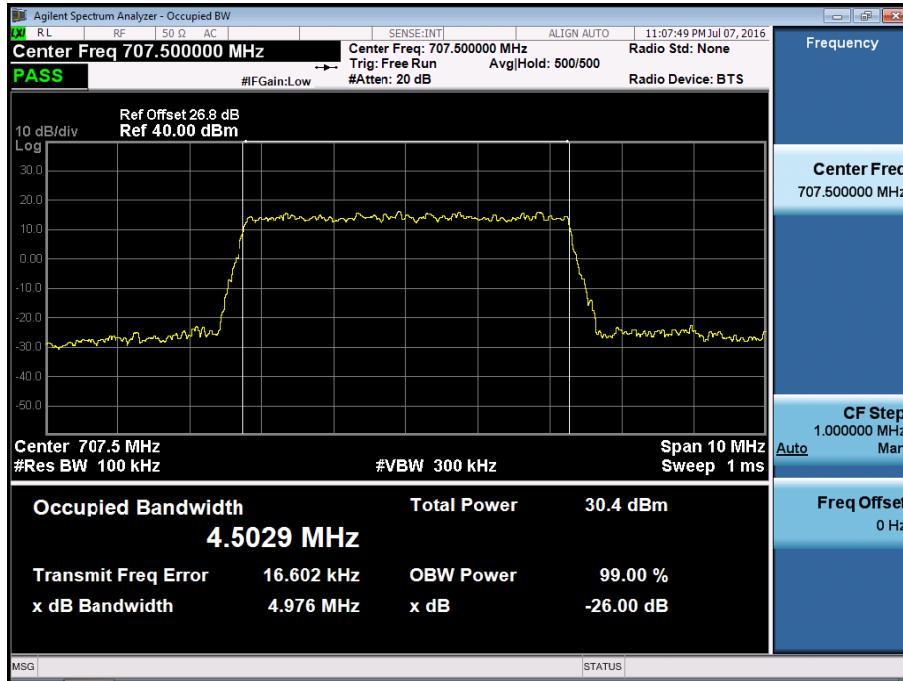

BAND 12. Occupied Bandwidth Plot (5M BW Ch.23095 16QAM\_RB25\_0)

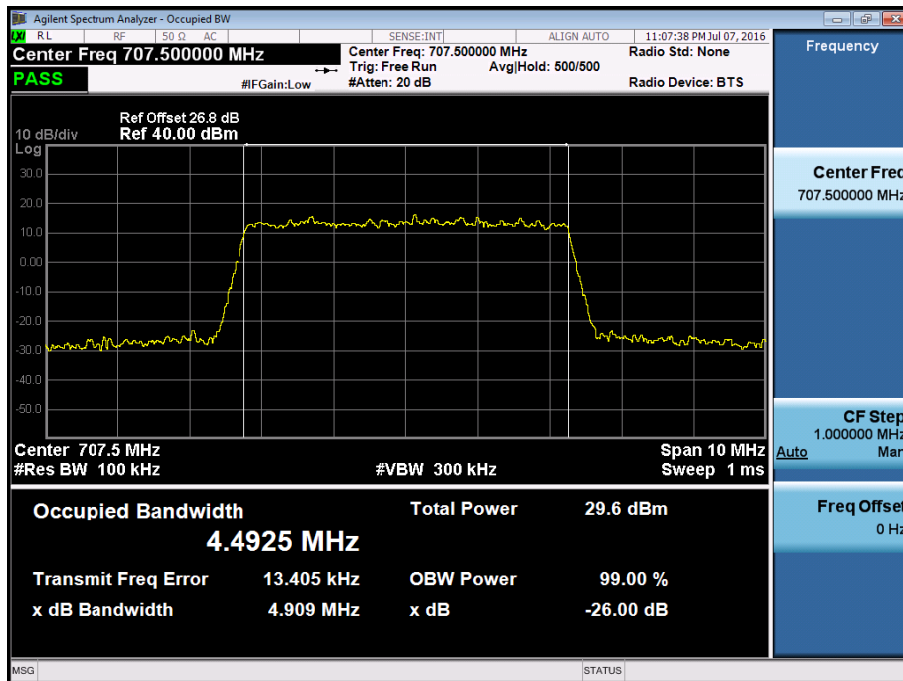

BAND 12. Occupied Bandwidth Plot (10M BW Ch.23095 QPSK\_RB50\_0)

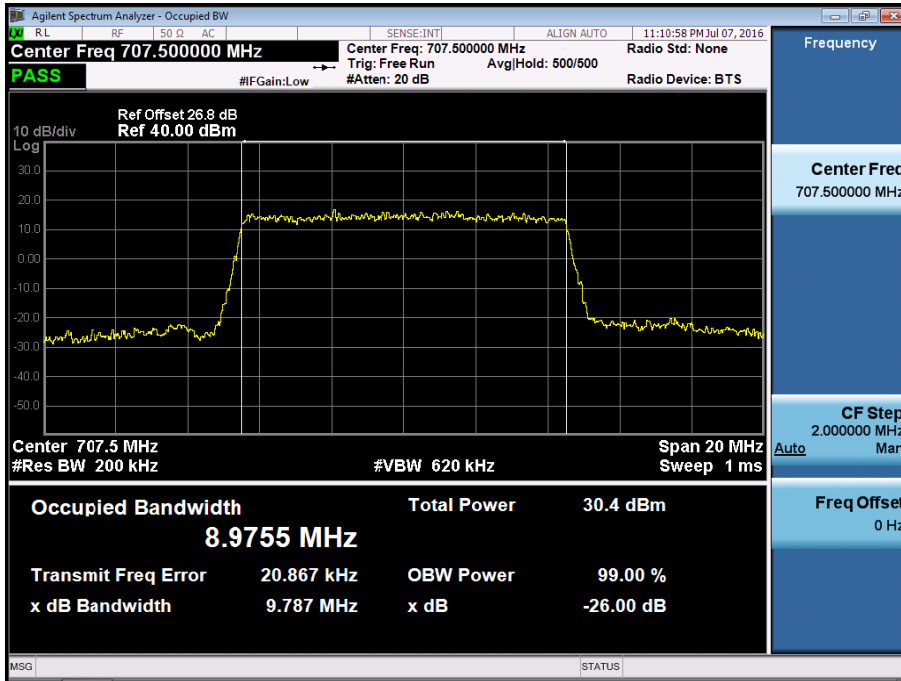

BAND 12. Occupied Bandwidth Plot (10M BW Ch.23095 16QAM\_RB50\_0)

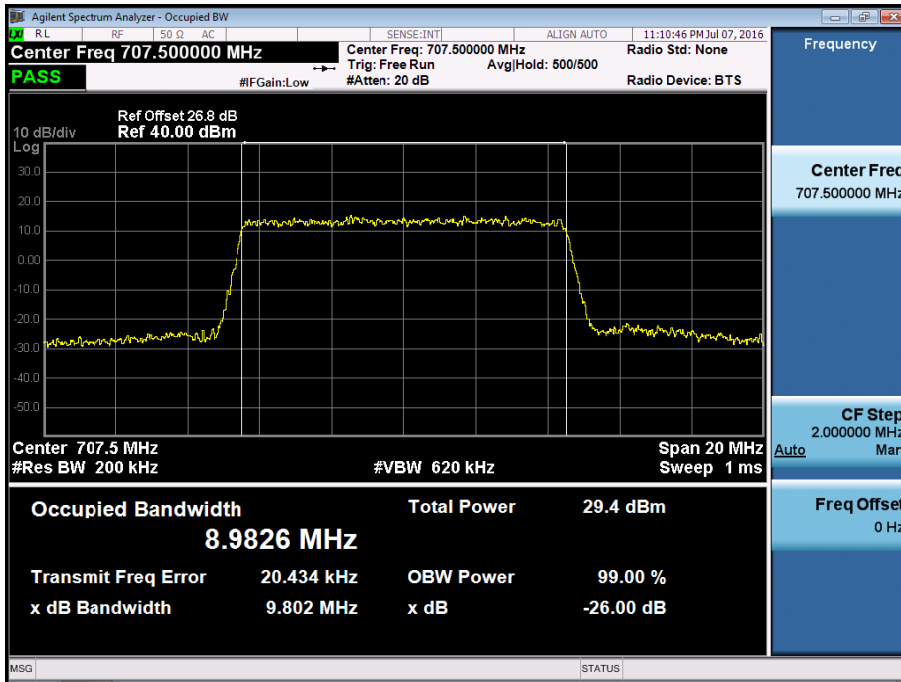



BAND 12. Lower Band Edge Plot (1.4M BW Ch.23017 QPSK\_RB1\_Offset 0)

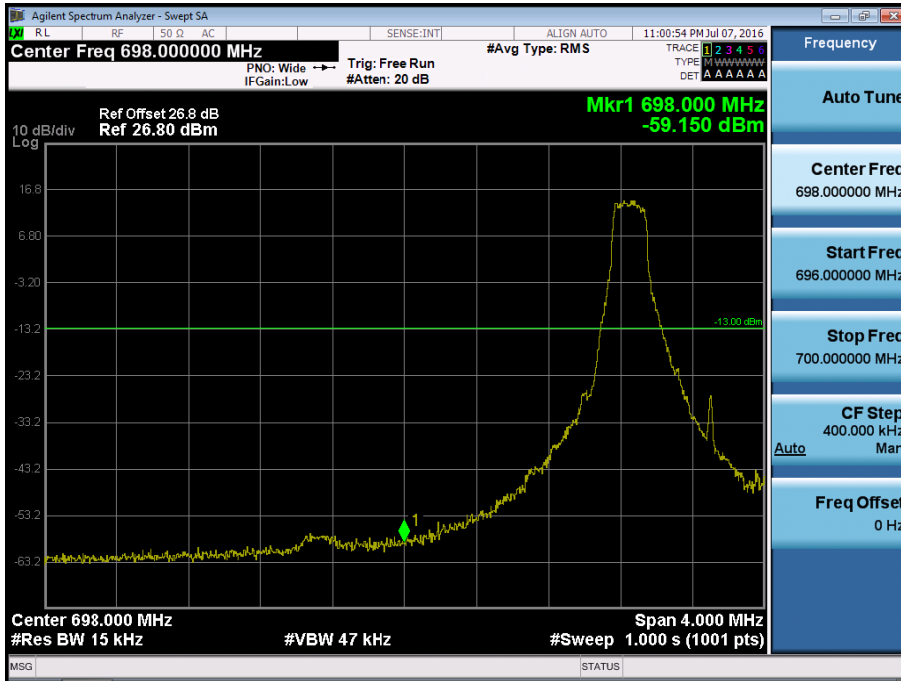

BAND 12. Lower Band Edge Plot (1.4M BW Ch.23017 QPSK\_RB6\_Offset 0)

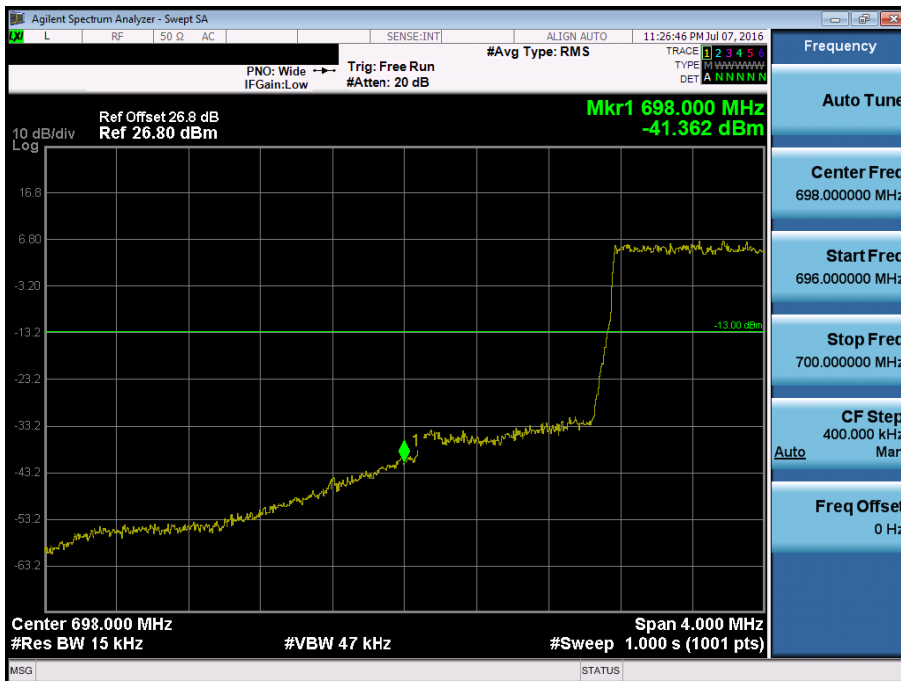

BAND 12. Lower Extended Band Edge Plot (1.4M BW Ch.23017 QPSK\_RB6\_0)

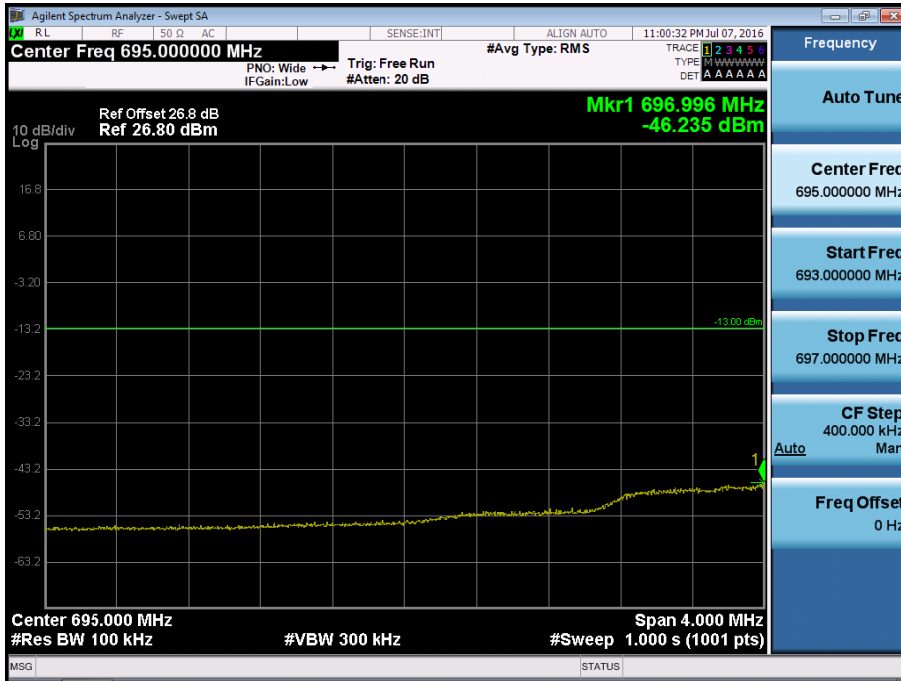

BAND 12. Lower Band Edge Plot (3M BW Ch.23025 QPSK\_RB1\_Offset 0)

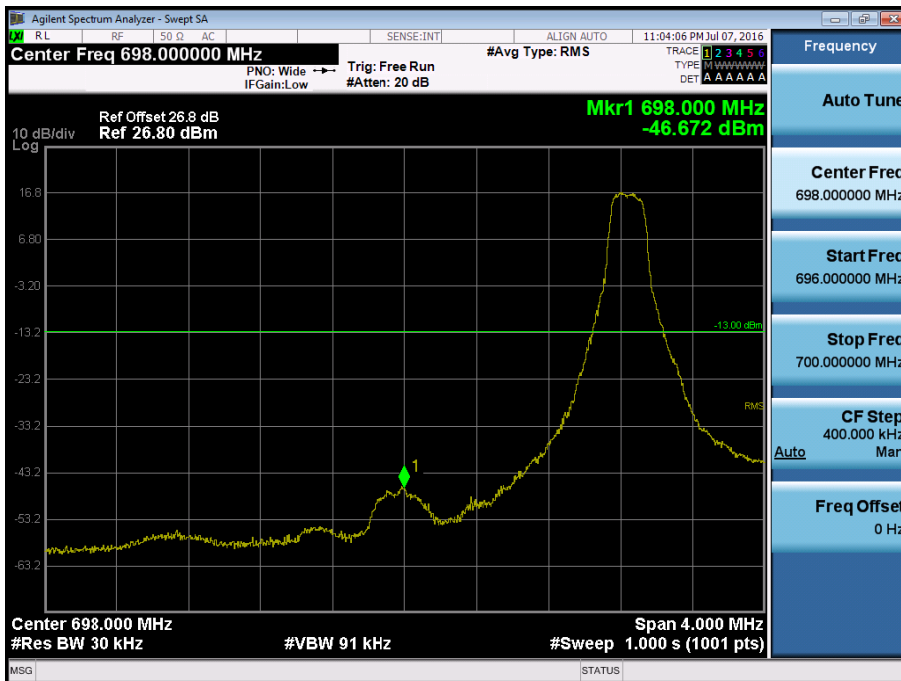

BAND 12. Lower Band Edge Plot (3M BW Ch.23025 QPSK\_RB15\_Offset 0)

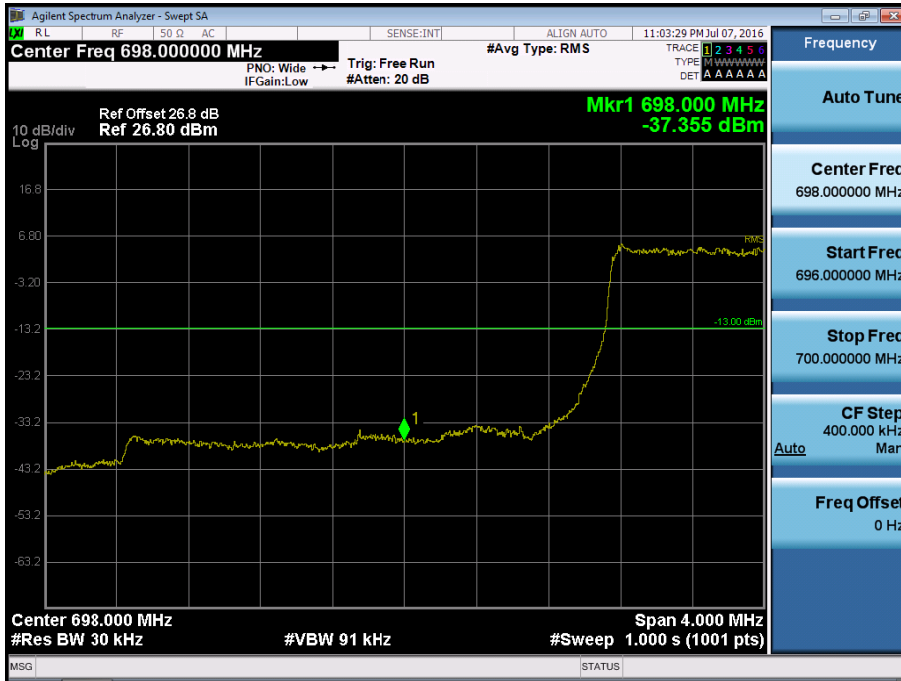

BAND 12. Lower Extended Band Edge Plot (3M BW Ch.23025 QPSK\_RB15\_0)

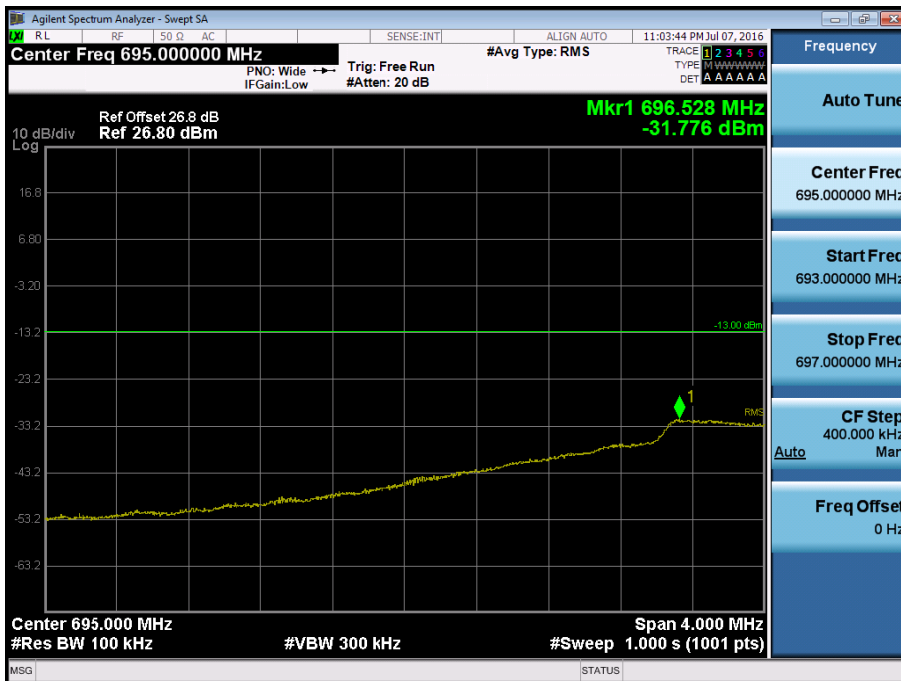

BAND 12. Lower Band Edge Plot (5M BW Ch.23035 QPSK\_RB1\_Offset 0)

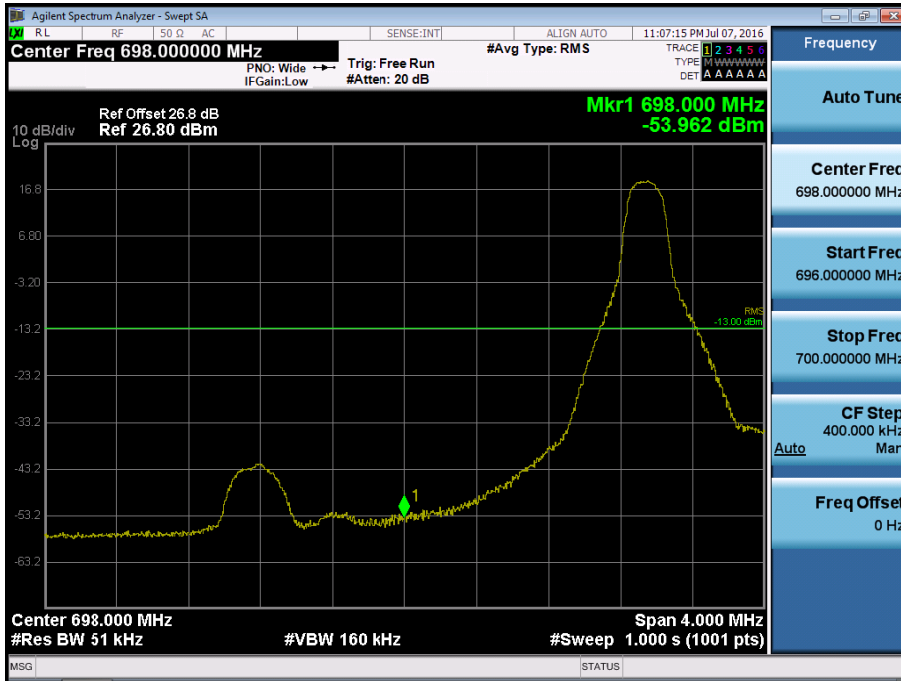

BAND 12. Lower Band Edge Plot (5M BW Ch.23035 QPSK\_RB25\_Offset 0)

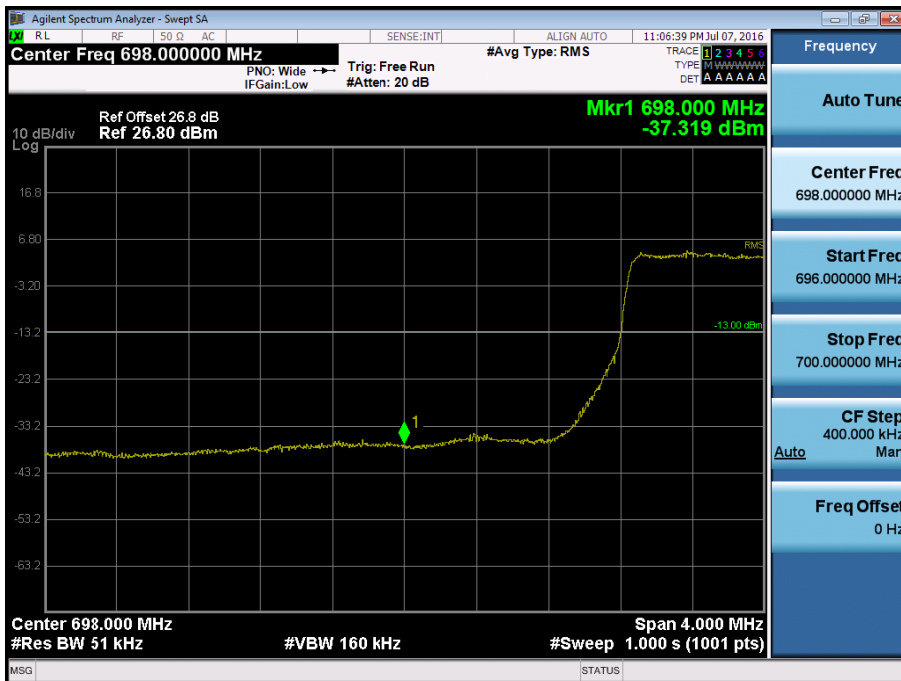

BAND 12. Lower Extended Band Edge Plot (5M BW Ch.23035 QPSK\_RB25\_0)



BAND 12. Lower Band Edge Plot (10M BW Ch.23060 QPSK\_RB1\_Offset 0)

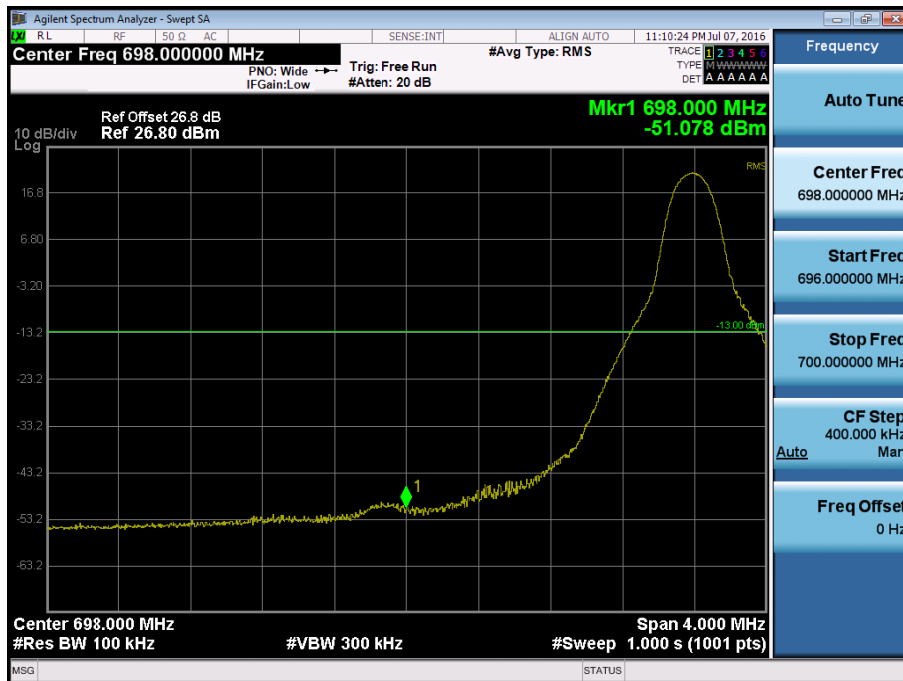

BAND 12. Lower Band Edge Plot (10M BW Ch.23060 QPSK\_RB50\_Offset 0)

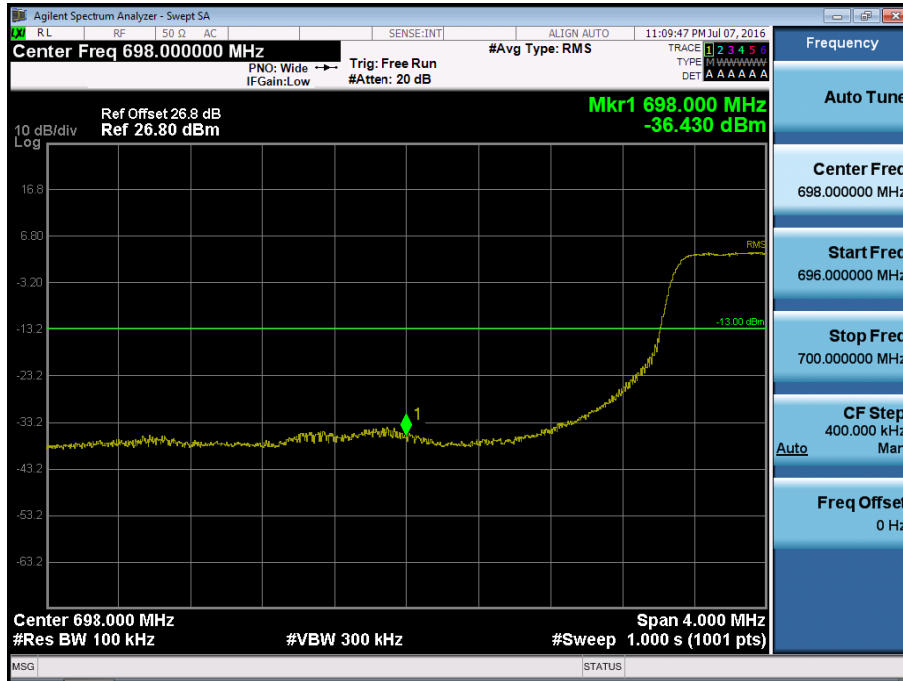

BAND 12. Lower Extended Band Edge Plot (10M BW Ch.23060 QPSK\_RB50\_0)

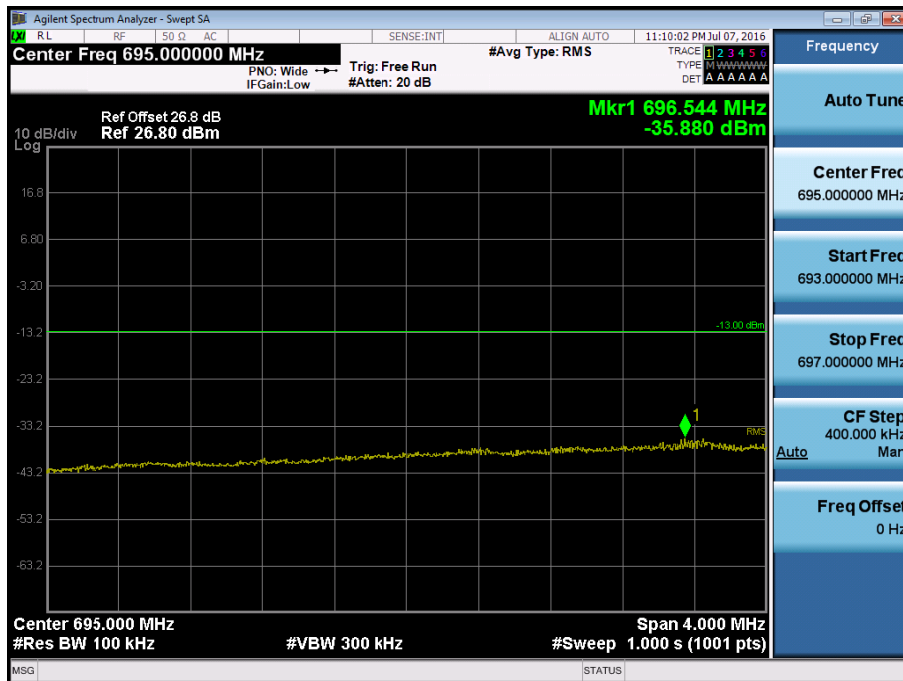

BAND 12. Upper Band Edge Plot (1.4M BW Ch.23173 QPSK\_RB1\_Offset 5)

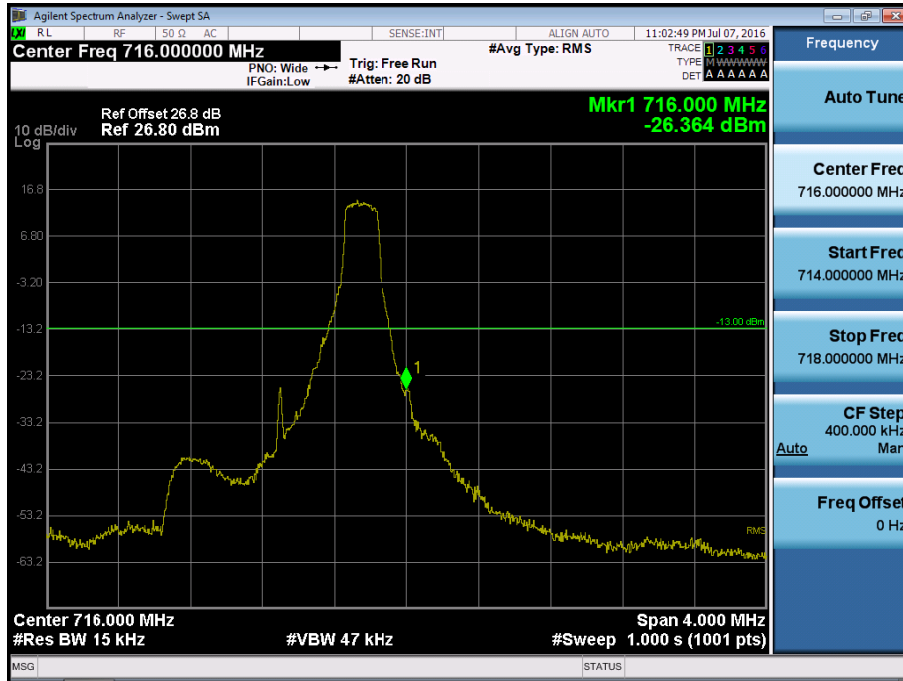

BAND 12. Upper Band Edge Plot (1.4M BW Ch.23173 QPSK\_RB6\_Offset 0)



BAND 12. Upper Extended Band Edge Plot (1.4M BW Ch.23173 QPSK\_RB6\_0)



BAND 12. Upper Band Edge Plot (3M BW Ch.23165 QPSK\_RB1\_Offset 14)

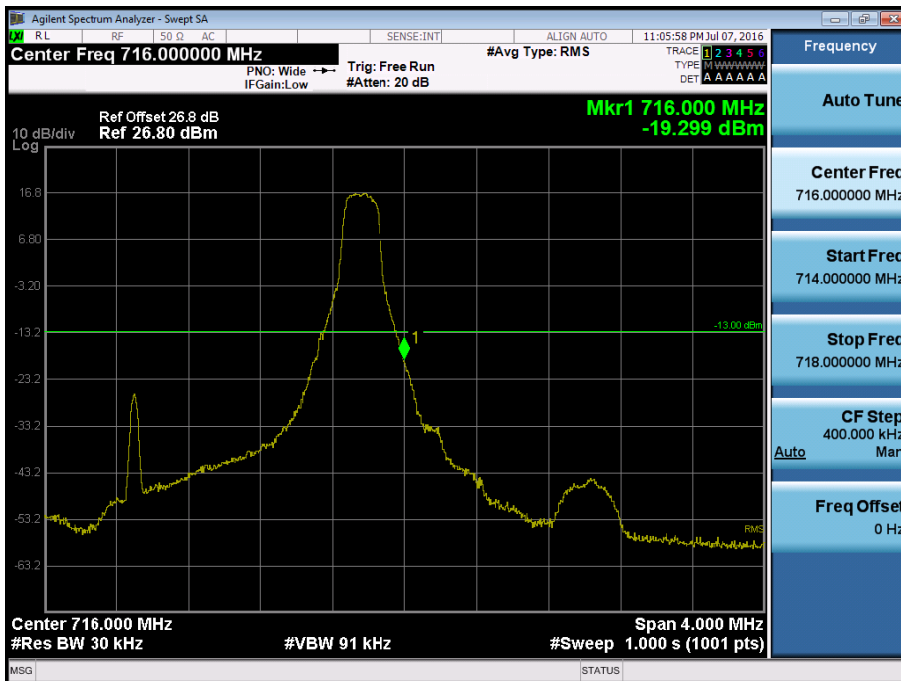



BAND 12. Upper Band Edge Plot (3M BW Ch.23165 QPSK\_RB15\_Offset 0)

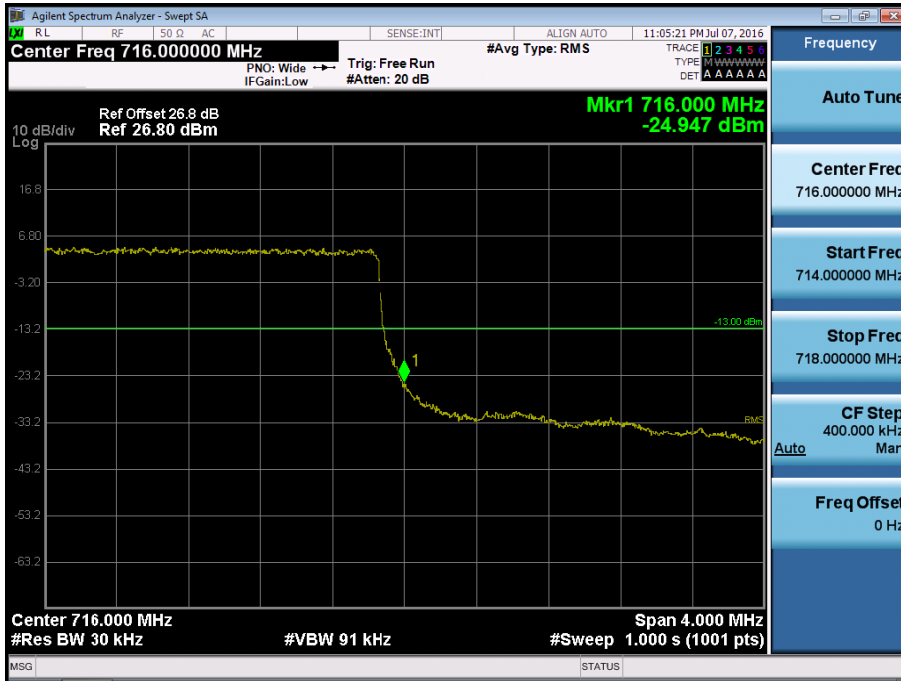

BAND 12. Upper Extended Band Edge Plot (3M BW Ch.23165 QPSK\_RB15\_0)



BAND 12. Upper Band Edge Plot (5M BW Ch.23155 QPSK\_RB1\_Offset 24)

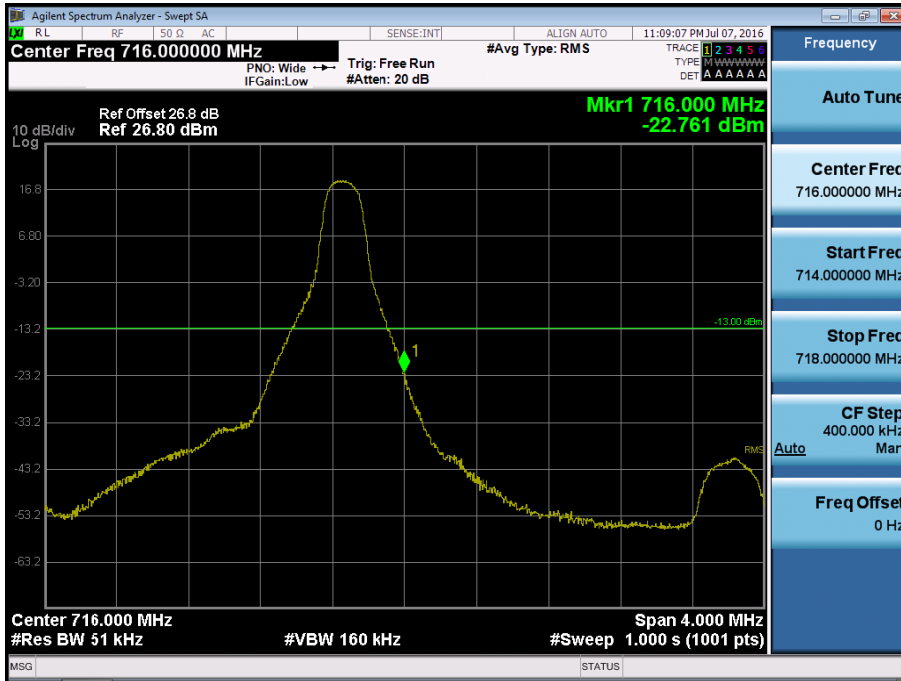

BAND 12. Upper Band Edge Plot (5M BW Ch.23155 QPSK\_RB25\_Offset 0)

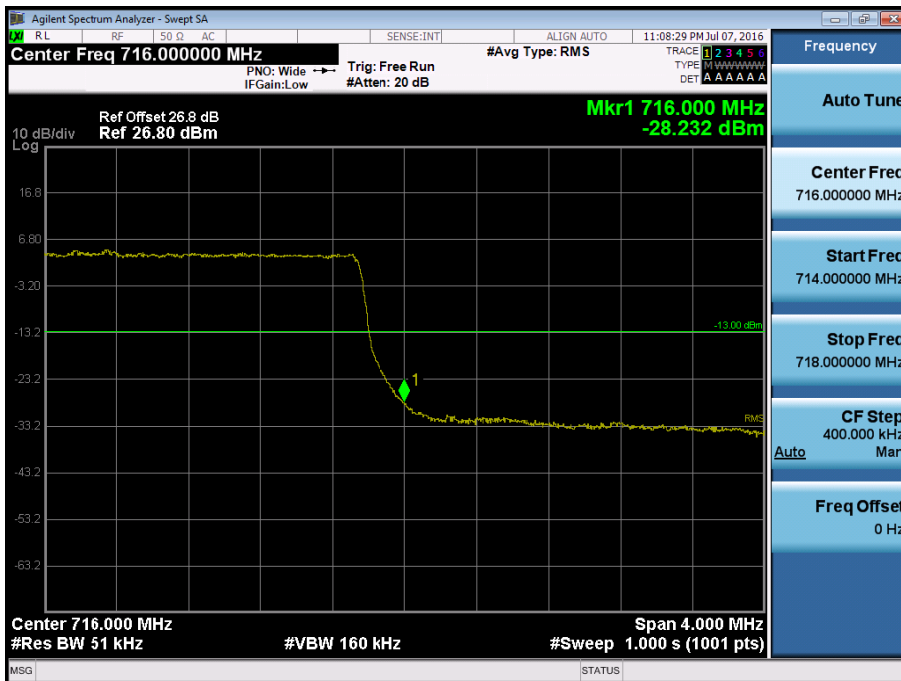

BAND 12. Upper Extended Band Edge Plot (5M BW Ch.23155 QPSK\_RB25\_0)



BAND 12. Upper Band Edge Plot (10M BW Ch.23130 QPSK\_RB1\_Offset 49)

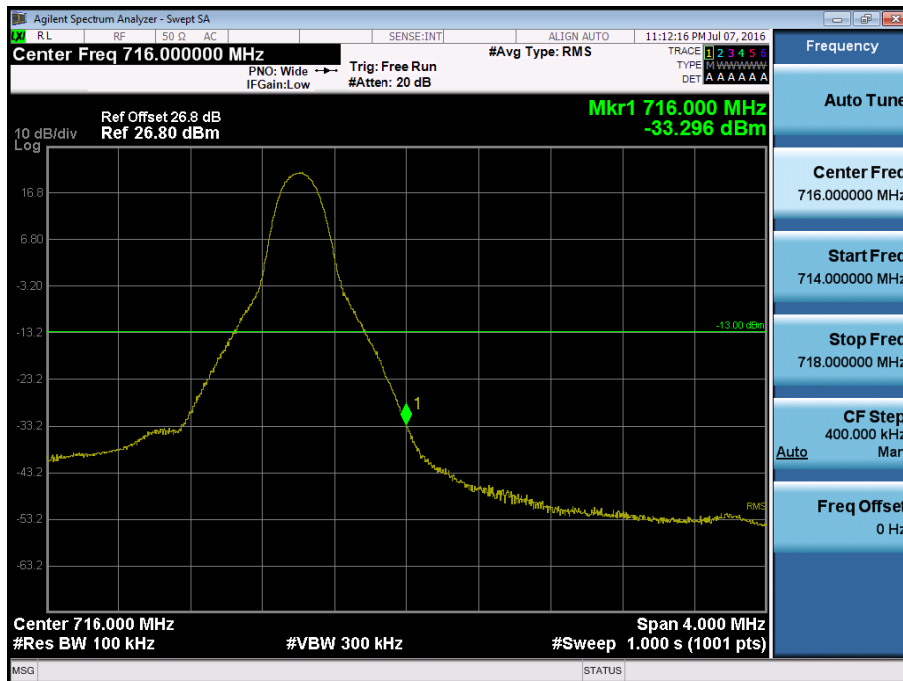

BAND 12. Upper Band Edge Plot (10M BW Ch.23130 QPSK\_RB50\_Offset 0)



BAND 12. Upper Extended Band Edge Plot (10M BW Ch.23130 QPSK\_RB50\_0)



BAND 12. Conducted Spurious Plot \_ (23017ch\_1.4MHz\_QPSK\_RB 1\_0)

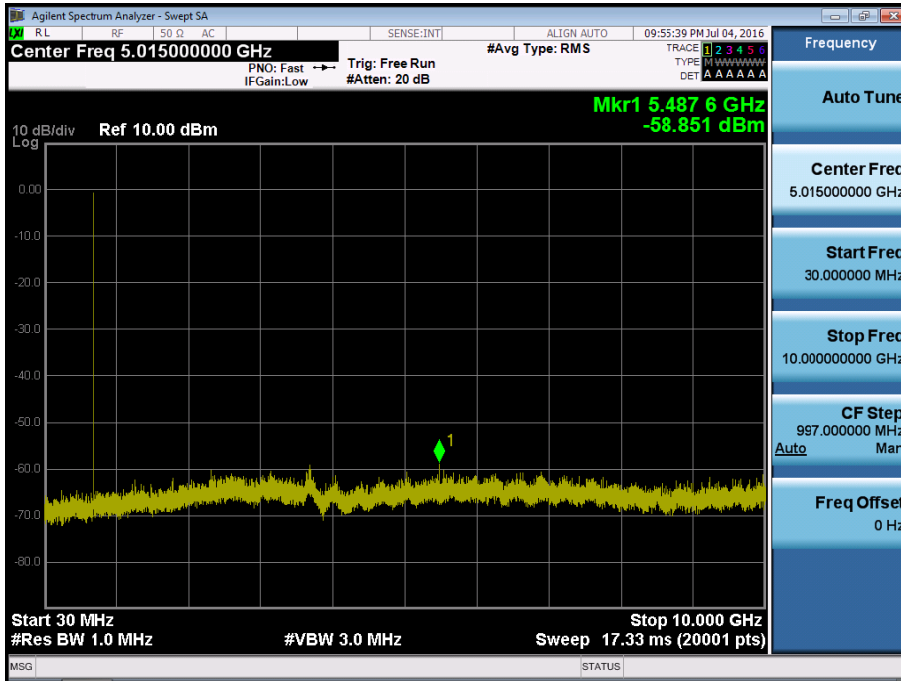

BAND 12. Conducted Spurious Plot \_ (23095ch\_1.4MHz\_QPSK\_RB 1\_0)

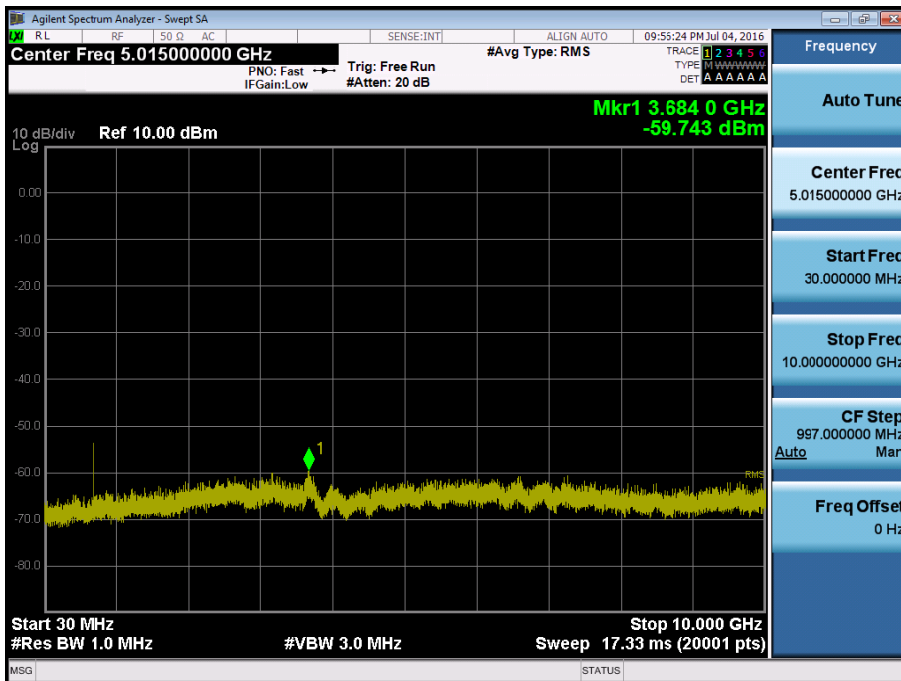

BAND 12. Conducted Spurious Plot \_ (23173ch\_1.4MHz\_QPSK\_RB 1\_0)

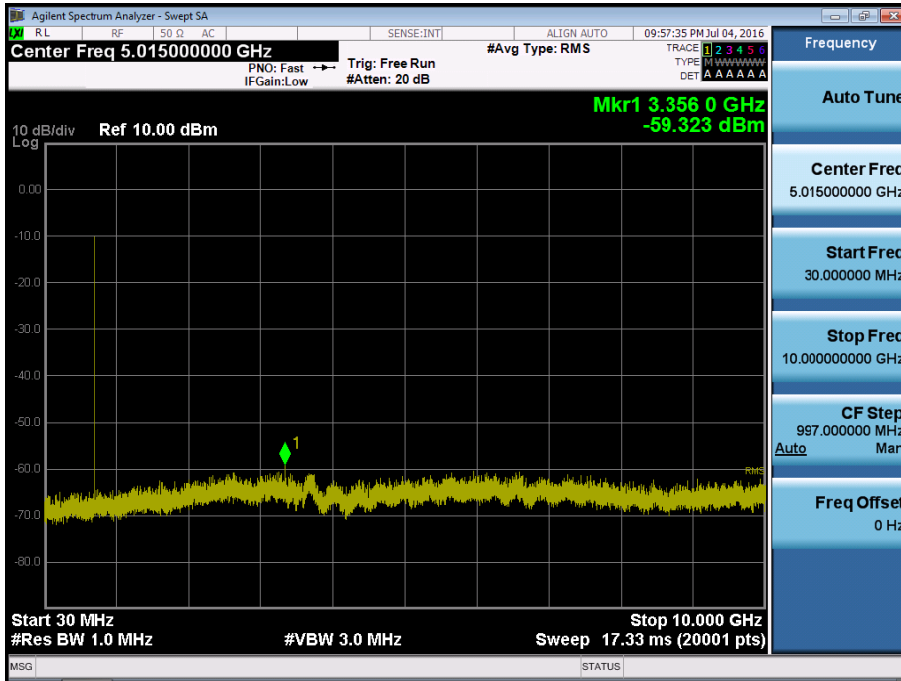

BAND 12. Conducted Spurious Plot \_ (23025ch\_3MHz\_QPSK\_RB 1\_0)

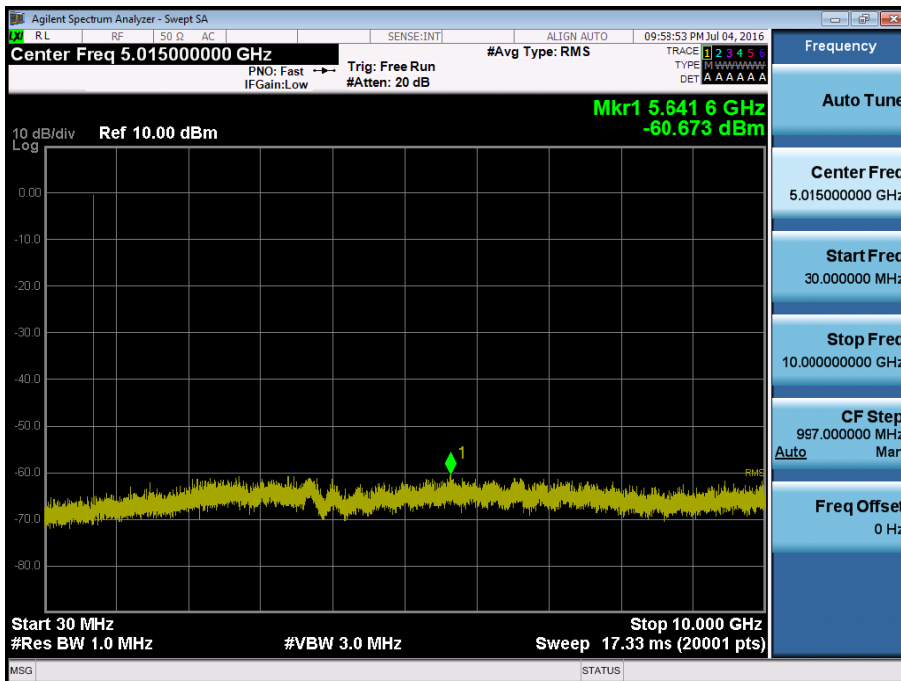

BAND 12. Conducted Spurious Plot \_ (23095ch\_3MHz\_QPSK\_RB 1\_0)

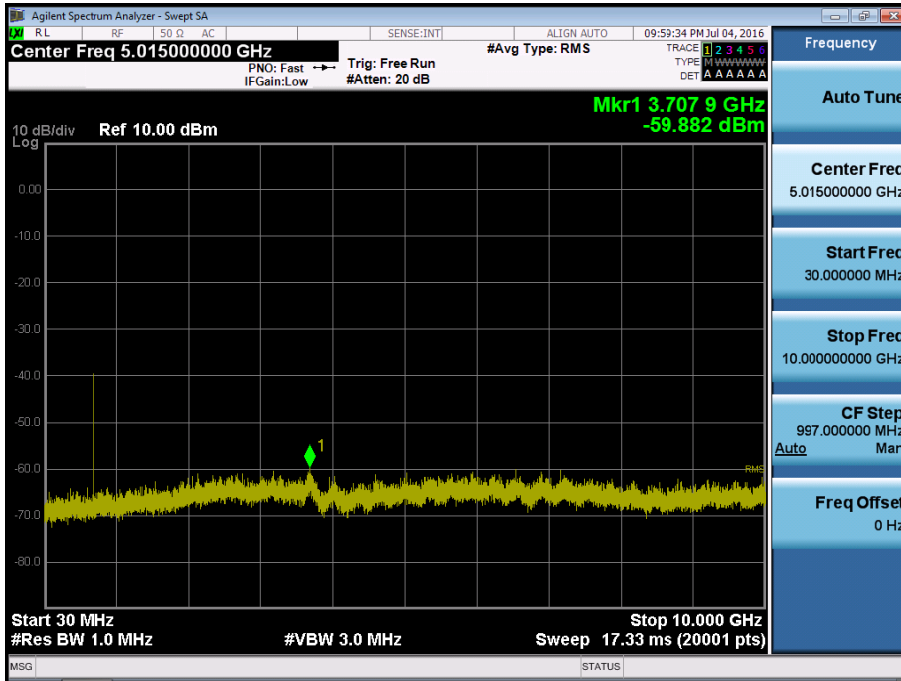

BAND 12. Conducted Spurious Plot \_ (23165ch\_3MHz\_QPSK\_RB 1\_0)

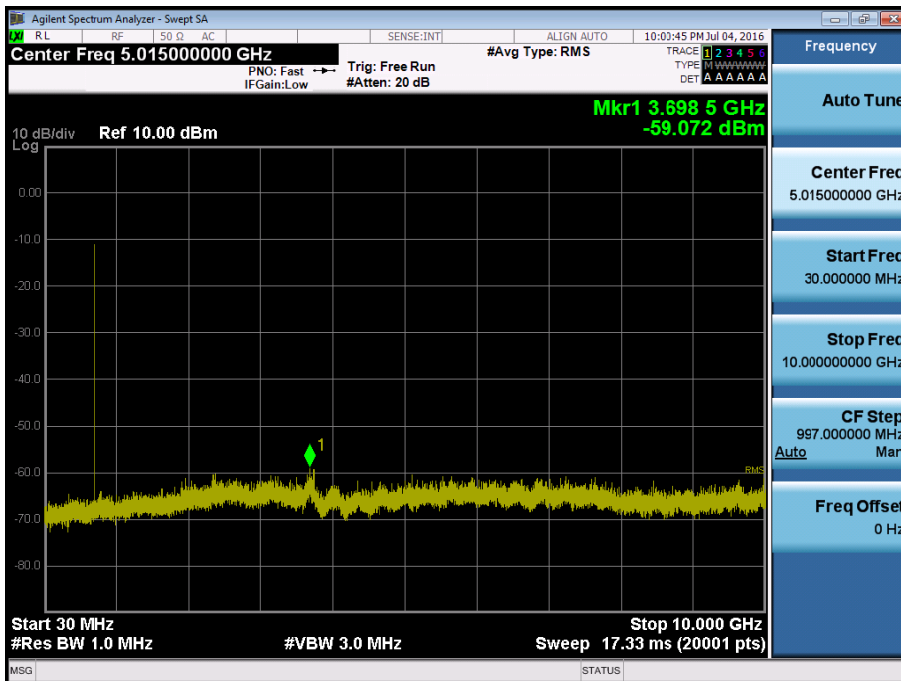

BAND 12. Conducted Spurious Plot \_ (23035ch\_5MHz\_QPSK\_RB 1\_0)

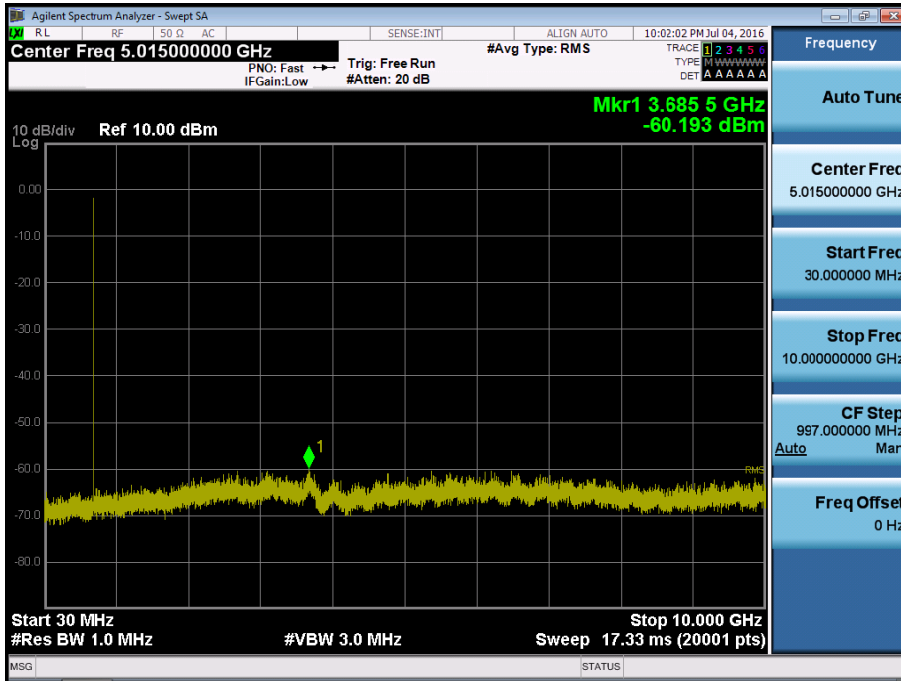

BAND 12. Conducted Spurious Plot \_ (23095ch\_5MHz\_QPSK\_RB 1\_0)

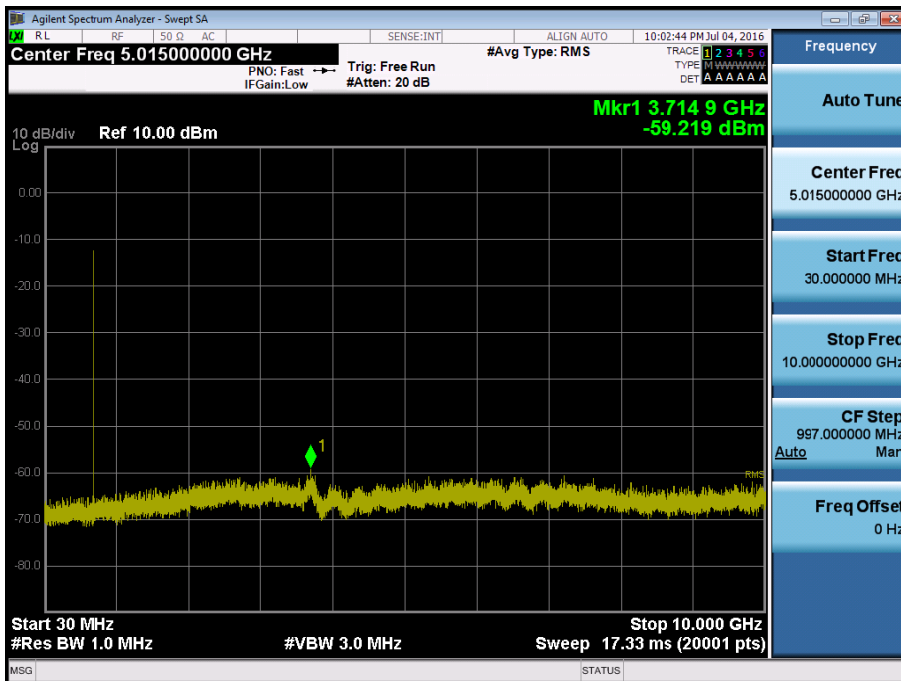



BAND 12. Conducted Spurious Plot \_ (23155ch\_5MHz\_QPSK\_RB 1\_0)

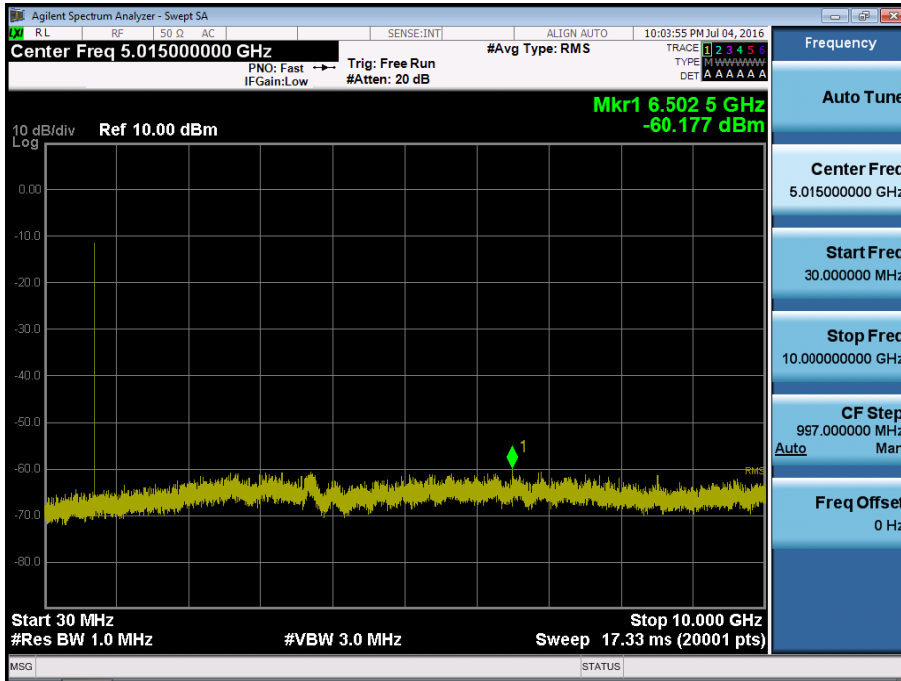

BAND 12. Conducted Spurious Plot \_ (23060ch\_10MHz\_QPSK\_RB 1\_0)

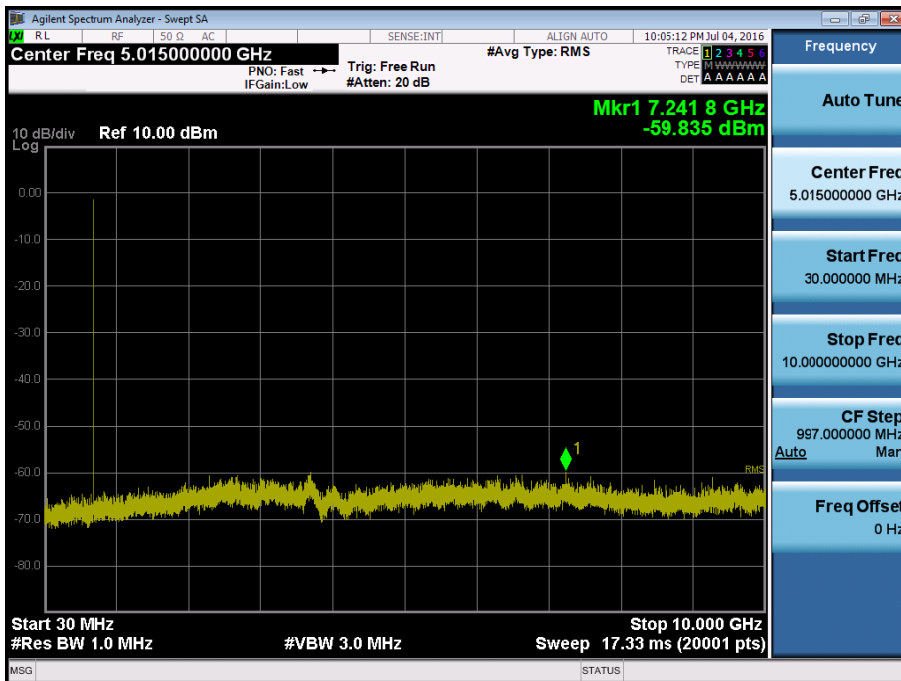

BAND 12. Conducted Spurious Plot \_ (23095ch\_10MHz\_QPSK\_RB 1\_0)

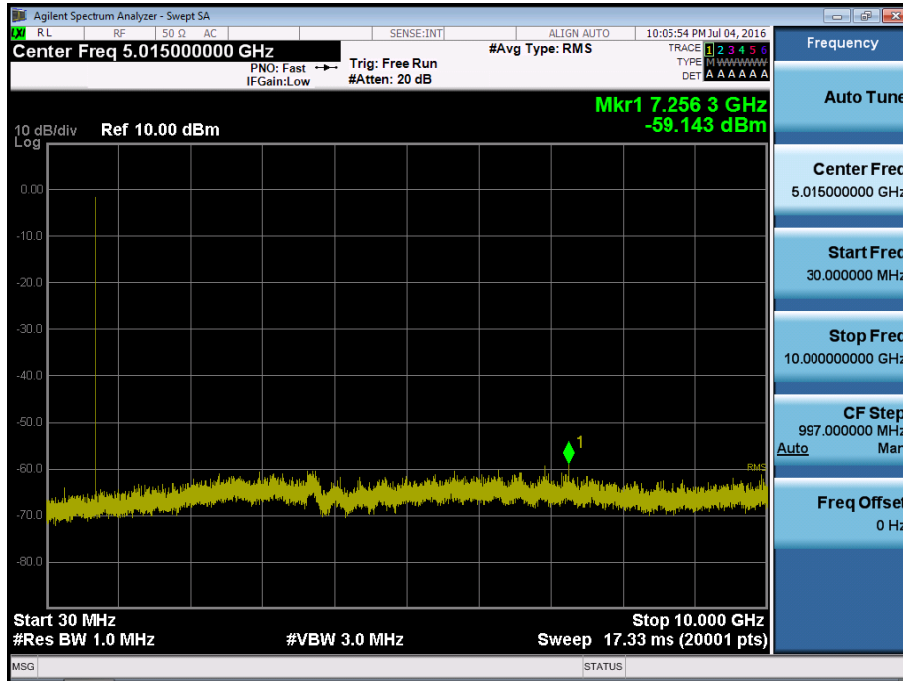

BAND 12. Conducted Spurious Plot \_ (23130ch\_10MHz\_QPSK\_RB 1\_0)

