

# FCC LTE REPORT

## FCC Certification

<b>Applicant Name:</b> LG Electronics MobileComm U.S.A., Inc.	<b>Date of Issue:</b> March 24, 2016
<b>Address:</b> 1000 Sylvan Avenue, Englewood Cliffs NJ 07632	<b>Location:</b> HCT CO., LTD., 74, Seoicheon-ro 578beon-gil, Majang-myeon, Icheon-si, Gyeonggi-do, 17383, Rep. of KOREA
	<b>Report No.:</b> HCT-R-1603-F057-1 <b>HCT FRN:</b> 0005866421

**FCC ID:** ZNFK530F

**APPLICANT:** LG Electronics MobileComm U.S.A., Inc.

**FCC Model(s):** LG-K530F  
**Additional FCC Model(s):** LGK530F, K530F  
**EUT Type:** Cellular/PCS GSM/GPRS/EDGE, Cellular/PCS/AWS WCDMA/HSDPA/HSUPA and LTE Phone with Bluetooth and Wi-Fi  
**FCC Classification:** Licensed Portable Transmitter Held to Ear (PCE)  
**FCC Rule Part(s):** §22, §24, §2

Mode (MHz)	Tx Frequency (MHz)	Emission Designator	Modulation	EIRP	
				Max. Power (W)	Max. Power (dBm)
LTE – Band2 (1.4)	1850.7 - 1909.3	1M09G7D	QPSK	0.207	23.16
		1M10W7D	16QAM	0.162	22.09
LTE – Band2 (3)	1851.5 - 1908.5	2M70G7D	QPSK	0.211	23.24
		2M70W7D	16QAM	0.159	22.02
LTE – Band2 (5)	1852.5 - 1907.5	4M51G7D	QPSK	0.204	23.11
		4M49W7D	16QAM	0.158	21.99
LTE – Band2 (10)	1855.0 - 1905.0	8M97G7D	QPSK	0.212	23.27
		8M93W7D	16QAM	0.160	22.03
LTE – Band2 (15)	1857.5 - 1902.5	13M4G7D	QPSK	0.208	23.19
		13M4W7D	16QAM	0.162	22.10
LTE – Band2 (20)	1860.0 - 1900.0	17M9G7D	QPSK	0.212	23.27
		17M9W7D	16QAM	0.166	22.21

Mode (MHz)	Tx Frequency (MHz)	Emission Designator	Modulation	ERP	
				Max. Power (W)	Max. Power (dBm)
LTE – Band5 (1.4)	824.7 – 848.3	1M10G7D	QPSK	0.075	18.75
		1M10W7D	16QAM	0.065	18.15
LTE – Band5 (3)	825.5 – 847.5	2M71G7D	QPSK	0.081	19.08
		2M69W7D	16QAM	0.061	17.83
LTE – Band5 (5)	826.5 – 846.5	4M51G7D	QPSK	0.080	19.02
		4M48W7D	16QAM	0.059	17.73
LTE – Band5 (10)	829.0 – 844.0	8M95G7D	QPSK	0.082	19.14
		8M95W7D	16QAM	0.058	17.62

The measurements shown in this report were made in accordance with the procedures specified in CFR47 section §2.947. I assume full responsibility for the accuracy and completeness of these measurements, and for the qualifications of all persons taking them.

HCT CO., LTD. Certifies that no party to this application has subject to a denial of Federal benefits that includes FCC benefits pursuant to section 5301 of the Anti-Drug Abuse Act of 1998,21 U.S. C.853(a)



Report prepared by  
: Jeong Ho Kim  
Test engineer of RF Team



Approved by  
: Sang Jun Lee  
Manager of RF Team

This report only responds to the tested sample and may not be reproduced, except in full, without written approval of the HCT Co., Ltd.

## Version

TEST REPORT NO.	DATE	DESCRIPTION
HCT-R-1603-F057	March 10, 2016	- First Approval Report
HCT-R-1603-F057-1	March 24, 2016	- Retested the occupied bandwidth on pages 53 and 59.

---

---

# Table of Contents

1. GENERAL INFORMATION .....	6
2. INTRODUCTION .....	8
2.1. EUT DESCRIPTION.....	8
2.2. MEASURING INSTRUMENT CALIBRATION.....	8
2.3. TEST FACILITY .....	8
3. DESCRIPTION OF TESTS .....	9
3.1 ERP/ EIRP RADIATED POWER AND RADIATED SPURIOUS EMISSIONS.....	9
3.2 FREQUENCY RANGE.....	10
3.3 PEAK-AVERAGE RATIO. ....	11
3.4 OCCUPIED BANDWIDTH. ....	13
3.5 SPURIOUS AND HARMONIC EMISSIONS AT ANTENNA TERMINAL.....	14
3.6 FREQUENCY STABILITY / VARIATION OF AMBIENT TEMPERATURE .....	15
4. LIST OF TEST EQUIPMENT .....	16
5. MEASUREMENT UNCERTAINTY.....	17
6. SUMMARY OF TEST RESULTS .....	18
7. SAMPLE CALCULATION.....	19
8. TEST DATA .....	20
8.1 EQUIVALENT ISOTROPIC RADIATED POWER (Band 2) .....	20
8.2 EFFECTIVE RADIATED POWER (Band 5).....	24
8.3 RADIATED SPURIOUS EMISSIONS.....	26
8.3.1 RADIATED SPURIOUS EMISSIONS (1.4 MHz Band 2 LTE).....	26
8.3.2 RADIATED SPURIOUS EMISSIONS (3 MHz Band 2 LTE).....	27
8.3.3 RADIATED SPURIOUS EMISSIONS (5 MHz Band 2 LTE).....	28
8.3.4 RADIATED SPURIOUS EMISSIONS (10 MHz Band 2 LTE).....	29
8.3.5 RADIATED SPURIOUS EMISSIONS (15 MHz Band 2 LTE).....	30
8.3.6 RADIATED SPURIOUS EMISSIONS (20 MHz Band 2 LTE).....	31
8.3.7 RADIATED SPURIOUS EMISSIONS (1.4 MHz Band 5 LTE).....	32
8.3.8 RADIATED SPURIOUS EMISSIONS (3 MHz Band 5 LTE).....	33
8.3.9 RADIATED SPURIOUS EMISSIONS (5 MHz Band 5 LTE).....	34
8.3.10 RADIATED SPURIOUS EMISSIONS (10 MHz Band 5 LTE).....	35
8.4 PEAK-TO-AVERAGE RATIO .....	36
8.5 OCCUPIED BANDWIDTH .....	37
8.6 CONDUCTED SPURIOUS EMISSIONS .....	38
8.6.1 BAND EDGE.....	39
8.7 FREQUENCY STABILITY / VARIATION OF AMBIENT TEMPERATURE .....	40

8.7.1 FREQUENCY STABILITY (1.4 MHz Band 2 LTE) .....	40
8.7.2 FREQUENCY STABILITY (3 MHz Band 2 LTE) .....	41
8.7.3 FREQUENCY STABILITY (5 MHz Band 2 LTE) .....	42
8.7.4 FREQUENCY STABILITY (10 MHz Band 2 LTE) .....	43
8.7.5 FREQUENCY STABILITY (15 MHz Band 2 LTE) .....	44
8.7.6 FREQUENCY STABILITY (20 MHz Band 2 LTE) .....	45
8.7.7 FREQUENCY STABILITY (1.4 MHz Band 5 LTE) .....	46
8.7.8 FREQUENCY STABILITY (3 MHz Band 5 LTE) .....	47
8.7.9 FREQUENCY STABILITY (5 MHz Band 5 LTE) .....	48
8.7.10 FREQUENCY STABILITY (10 MHz Band 5 LTE) .....	49
8. TEST PLOTS.....	50

# MEASUREMENT REPORT

## 1. GENERAL INFORMATION

**Applicant Name:** LG Electronics MobileComm U.S.A., Inc.

**Address:** 1000 Sylvan Avenue, Englewood Cliffs NJ 07632

**FCC ID:** ZNFK530F

**Application Type:** Certification

**FCC Classification:** Licensed Portable Transmitter Held to Ear (PCE)

**FCC Rule Part(s):** §22, §24, §2

**EUT Type:** Cellular/PCS GSM/GPRS/EDGE, Cellular/PCS/AWS WCDMA/HSDPA/HSUPA and LTE Phone with Bluetooth and Wi-Fi

**FCC Model(s):** LG-K530F

**Additional FCC Model(s):** LGK530F, K530F

**Tx Frequency:**

1850.7 MHz – 1909.3 MHz (LTE – Band2 (1.4 MHz))  
1851.5 MHz – 1908.5 MHz (LTE – Band2 (3 MHz))  
1852.5 MHz – 1907.5 MHz (LTE – Band2 (5 MHz))  
1855.0 MHz – 1905.0 MHz (LTE – Band2 (10 MHz))  
1857.5 MHz – 1902.5 MHz (LTE – Band2 (15 MHz))  
1860.0 MHz – 1900.0 MHz (LTE – Band2 (20 MHz))

824.7 MHz – 848.3 MHz (LTE – Band 5 (1.4 MHz))  
825.5 MHz – 847.5 MHz (LTE – Band 5 (3 MHz))  
826.5 MHz – 846.5 MHz (LTE – Band 5 (5 MHz))  
829.0 MHz – 844.0 MHz (LTE – Band 5 (10 MHz))

**Max. RF Output Power:**

Band 2 (1.4 MHz) : 0.207 W (QPSK) (23.16 dBm)  
0.162 W (16-QAM) (22.09 dBm)

Band 2 (3 MHz) : 0.211 W (QPSK) (23.24 dBm)  
0.159 W (16-QAM) (22.02 dBm)

Band 2 (5 MHz) : 0.204 W (QPSK) (23.11 dBm)  
0.158 W (16-QAM) (21.99 dBm)

Band 2 (10 MHz) : 0.212 W (QPSK) (23.27 dBm)  
0.160 W (16-QAM) (22.03 dBm)

Band 2 (15 MHz) : 0.208 W (QPSK) (23.19 dBm)  
0.162 W (16-QAM) (22.10 dBm)

Band 2 (20 MHz) : 0.212 W (QPSK) (23.27 dBm)  
0.166 W (16-QAM) (22.21 dBm)

Band 5 (1.4 MHz) : 0.075 W (QPSK) (18.75 dBm)  
0.065 W (16-QAM) (18.15 dBm)

Band 5 (3 MHz) : 0.081 W (QPSK) (19.08 dBm)  
0.061 W (16-QAM) (17.83 dBm)

Band 5 (5 MHz) : 0.080 W (QPSK) (19.02 dBm)  
0.059 W (16-QAM) (17.73 dBm)

Band 5 (10 MHz) : 0.082 W (QPSK) (19.14 dBm)  
0.058 W (16-QAM) (17.62 dBm)

**Emission Designator(s):**

Band 2 (1.4 MHz) :	1M09G7D (QPSK) / 1M10W7D (16-QAM)
Band 2 (3 MHz)	2M70G7D (QPSK) / 2M70W7D (16-QAM)
Band 2 (5 MHz) :	4M51G7D (QPSK) / 4M49W7D (16-QAM)
Band 2 (10 MHz)	8M97G7D (QPSK) / 8M93W7D (16-QAM)
Band 2 (15 MHz) :	13M4G7D (QPSK) / 13M4W7D (16-QAM)
Band 2 (20 MHz)	17M9G7D (QPSK) / 17M9W7D (16-QAM)
Band 5 (1.4 MHz) :	1M10G7D (QPSK) / 1M10W7D (16-QAM)
Band 5 (3 MHz) :	2M71G7D (QPSK) / 2M69W7D (16-QAM)
Band 5 (5 MHz) :	4M51G7D (QPSK) / 4M48W7D (16-QAM)
Band 5 (10 MHz) :	8M95G7D (QPSK) / 8M95W7D (16-QAM)

**Date(s) of Tests:** February 01, 2016 ~ March 24, 2016

**Antenna Specification:**

Manufacturer:	LS Mtron Co., Ltd.
Antenna type:	PIFA Antenna (Planar Inverted F)
Peak Gain:	Band 2 : -2.8 dBi
	Band 5 : -3.2 dBi

## **2. INTRODUCTION**

### **2.1. EUT DESCRIPTION**

The LG Electronics MobileComm U.S.A., Inc. LG-K530F Cellular/PCS GSM/GPRS/EDGE, Cellular/PCS/AWS WCDMA/HSDPA/HSUPA and LTE Phone with Bluetooth and Wi-Fi consists of LTE 2 and 5.

### **2.2. MEASURING INSTRUMENT CALIBRATION**

The measuring equipment, which was utilized in performing the tests documented herein, has been calibrated in accordance with the manufacturer's recommendations for utilizing calibration equipment, which is traceable to recognized national standards.

### **2.3. TEST FACILITY**

The Fully-anechoic chamber and conducted measurement facility used to collect the radiated data are located at the **74, Seoicheon-ro 578beon-gil, Majang-myeon, Icheon-si, Gyeonggi-do, 17383, Rep. of KOREA.**



## **3. DESCRIPTION OF TESTS**

### **3.1 ERP/ EIRP RADIATED POWER AND RADIATED SPURIOUS EMISSIONS**

Note: ERP(Effective Radiated Power), EIRP(Effective Isotropic Radiated Power)

Test Procedure

Radiated emission measurements are performed in the Fully-anechoic chamber. The equipment under test is placed on a non-conductive table 3-meters away from the receive antenna in accordance with ANSI/TIA-603-D-2010 Clause 2.2.17. The turntable is rotated through 360 degrees, and the receiving antenna scans in order to determine the level of the maximized emission. The level and position of the maximized emission is recorded with the spectrum analyzer using a RMS detector.

A half wave dipole is then substituted in place of the EUT. For emissions above 1GHz, a horn antenna is substituted in place of the EUT. The substitute antenna is driven by a signal generator and the previously recorded signal was duplicated.

The power is calculated by the following formula;

$$P_{d(\text{dBm})} = P_{g(\text{dBm})} - \text{cable loss}_{(\text{dB})} + \text{antenna gain}_{(\text{dB})}$$

Where:  $P_d$  is the dipole equivalent power and  $P_g$  is the generator output power into the substitution antenna.

The maximum EIRP is calculated by adding the forward power to the calibrated source plus its appropriate gain value. These steps are repeated with the receiving antenna in both vertical and horizontal polarization. the difference between the gain of the horn and an isotropic antenna are taken into consideration

#### **Radiated spurious emissions**

: Frequency Range : 30 MHz ~ 10<sup>th</sup> Harmonics of highest channel fundamental frequency.

### 3.2 FREQUENCY RANGE

§ 24.229: PCS – Mobile Frequency Blocks

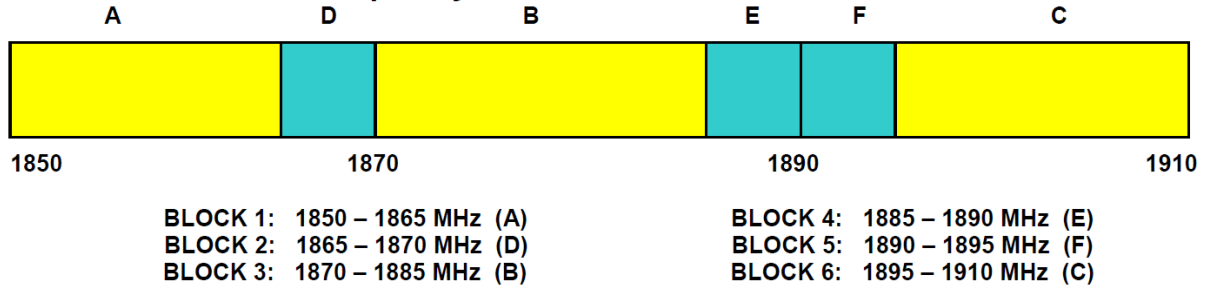

§22.917(a): Cellular – Mobile Frequency Blocks

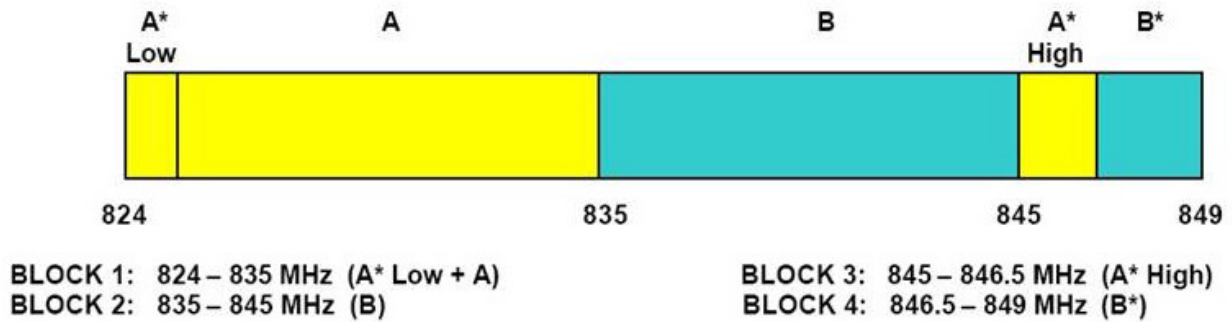

### 3.3 PEAK-AVERAGE RATIO.

#### Test Procedure

Peak to Average Power Ratio is tested in accordance with KDB971168 D01 Power Meas License Digital Systems v02r02, October 17, 2014, Section 5.7.

#### - Section 5.7.1 CCDF Procedure

- a) Set resolution/measurement bandwidth  $\geq$  signal's occupied bandwidth;
- b) Set the number of counts to a value that stabilizes the measured CCDF curve;
- c) Set the measurement interval as follows:
  - 1) for continuous transmissions, set to 1 ms,
  - 2) for burst transmissions, employ an external trigger that is synchronized with the EUT burst timing sequence, or use the internal burst trigger with a trigger level that allows the burst to stabilize and set the measurement interval to a time that is less than or equal to the burst duration.
- d) Record the maximum PAPR level associated with a probability of 0.1%.

#### - Section 5.7.2 Alternate Procedure

Use one of the procedures presented in 5.1 to measure the total peak power and record as  $P_{Pk}$ . Use one of the applicable procedures presented 5.2 to measure the total average power and record as  $P_{Avg}$ . Determine the P.A.R. from:  $P.A.R_{(dB)} = P_{Pk (dBm)} - P_{Avg (dBm)}$  ( $P_{Avg}$  = Average Power + Duty cycle Factor)

#### 5.1.1 Peak power measurements with a spectrum/signal analyzer or EMI receiver

The following procedure can be used to determine the total peak output power.

- a) Set the RBW  $\geq$  OBW.
- b) Set VBW  $\geq 3 \times$  RBW.
- c) Set span  $\geq 2 \times$  RBW
- d) Sweep time = auto couple.
- e) Detector = peak.
- f) Ensure that the number of measurement points  $\geq$  span/RBW.
- g) Trace mode = max hold.
- h) Allow trace to fully stabilize.
- i) Use the peak marker function to determine the peak amplitude level.

### **5.2.2 Procedures for use with a spectrum/signal analyzer when EUT cannot be configured to transmit continuously and sweep triggering/signal gating cannot be properly implemented**

If the EUT cannot be configured to transmit continuously (burst duty cycle < 98%), then one of the following procedures can be used. The selection of the applicable procedure will depend on the characteristics of the measured burst duty cycle.

Measure the burst duty cycle with a spectrum/signal analyzer or EMC receiver can be used in zero-span mode if the response time and spacing between bins on the sweep are sufficient to permit accurate measurement of the burst on/off time of the transmitted signal.

#### **5.2.2.2 Constant burst duty cycle**

If the measured burst duty cycle is constant (i.e., duty cycle variations are less than  $\pm 2$  percent), then:

- a) Set span to at least 1.5 times the OBW.
- b) Set RBW = 1-5% of the OBW, not to exceed 1 MHz.
- c) Set VBW  $\geq 3 \times$  RBW.
- d) Number of points in sweep  $\geq 2 \times$  span / RBW. (This gives bin-to-bin spacing  $\leq$  RBW/2, so that narrowband signals are not lost between frequency bins.)
- e) Sweep time = auto.
- f) Detector = RMS (power averaging).
- g) Set sweep trigger to "free run".
- h) Trace average at least 100 traces in power averaging (i.e., RMS) mode.
- i) Compute power by integrating the spectrum across the OBW of the signal using the instrument's band power measurement function with band limits set equal to the OBW band edges. If the instrument does not have a band power function, sum the spectrum levels (in power units) at intervals equal to the RBW extending across the entire OBW of the spectrum.
- j) Add  $10 \log (1/x)$ , where  $x$  is the duty cycle, to the measured power in order to compute the average power during the actual transmission times (because the measurement represents an average over both the on and off times of the transmission).

For example, add  $10 \log (1/0.25) = 6$  dB if the duty cycle is a constant 25%.

### 3.4 OCCUPIED BANDWIDTH.

#### Test set-up

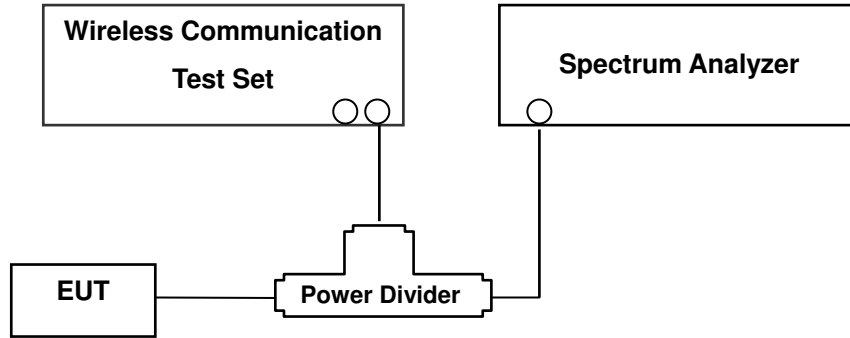

(Configuration of conducted Emission measurement)

The width of a frequency band such that, below the lower and above the upper frequency limits, the mean powers emitted are each equal to a specified percentage 0.5 % of the total mean power of a given emission.

#### Test Procedure

OBW is tested in accordance with KDB971168 D01 Power Meas License Digital Systems v02r02, October 17, 2014, Section 4.2.

The EUT makes a call to the communication simulator. The power was measured with R&S Spectrum Analyzer. All measurements were done at 3 channels(low, middle and high operational range.)

The conducted occupied bandwidth used the power splitter via EUT RF power connector between simulation base station and spectrum analyzer.

The communication simulator station system controlled a EUT to export maximum output power under transmission mode and specific channel frequency. Use OBW measurement function of Spectrum analyzer to measure 99 % occupied bandwidth

### 3.5 SPURIOUS AND HARMONIC EMISSIONS AT ANTENNA TERMINAL.

#### Test Procedure

Spurious and harmonic emissions at antenna terminal is tested in accordance with KDB971168 D01 Power Meas License Digital Systems v02r02, October 17, 2014, Section 6.0.

The level of the carrier and the various conducted spurious and harmonic frequencies is measured by means of a calibrated spectrum analyzer.

The EUT was setup to maximum output power at its lowest channel. The Resolution BW of the analyzer is set to 1 % of the emission bandwidth to show compliance with the -13 dBm limit, in the 1 MHz bands immediately outside and adjacent to the edge of the frequency block. The 1 MHz RBW was used to scan from 30 MHz to 10<sup>th</sup> Harmonics. A display line was placed at -13 dBm to show compliance. The high, lowest and a middle channel were tested for out of band measurements.

- Band Edge Requirement : In the 1MHz bands immediately outside and adjacent to the frequency block, a resolution bandwidth of at least 1 percent of the emission bandwidth of the fundamental emission of the transmitter may be employed to measure the out of band Emissions. Limit, -13 dBm.

**NOTES:** The analyzer plot offsets were determined by below conditions.

- For LTE Band 2, total offset 27.7 dBm = 20 dBm attenuator + 6 dBm Divider + 1.7 dBm RF cables.
- For LTE Band 5, total offset 27.2 dBm = 20 dBm attenuator + 6 dBm Divider + 1.2 dBm RF cables.

### 3.6 FREQUENCY STABILITY / VARIATION OF AMBIENT TEMPERATURE

#### Test Set-up

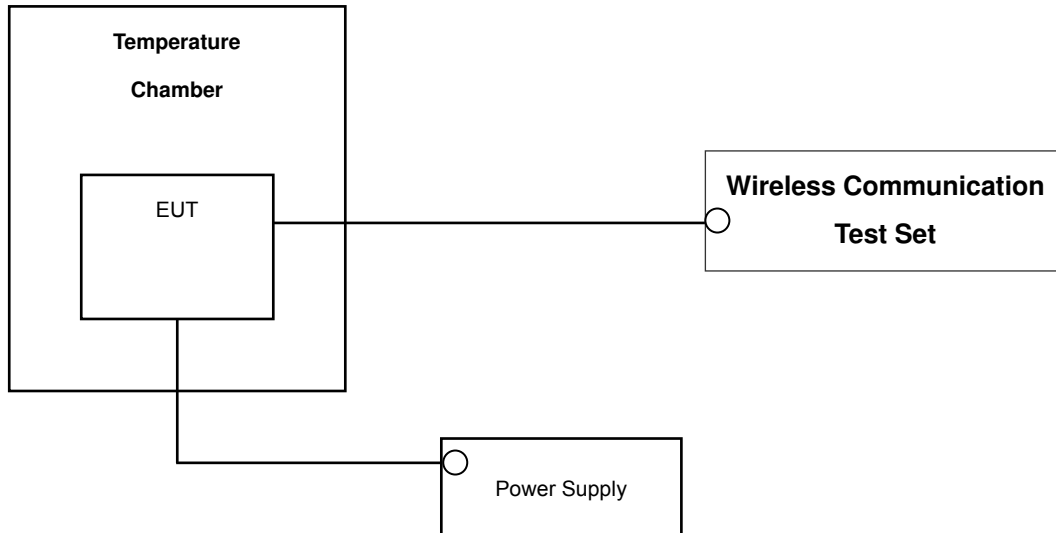

\* Nominal Operating Voltage

#### Test Procedure

Frequency stability is tested in accordance with ANSI/TIA-603-D-2010 section 2.2.2

The frequency stability of the transmitter is measured by:

- a.) **Temperature:** The temperature is varied from - 30 °C to + 50 °C using an environmental chamber.
- b.) **Primary Supply Voltage:** The primary supply voltage is varied from the end point to 100 % of the voltage normally at the input to the device or at the power supply terminals if cables are not normally supplied.

Specification — the frequency stability shall be sufficient to ensure that the fundamental emission stays within the authorized frequency block(LTE Band2). The frequency stability of the transmitter shall be maintained within  $\pm 0.00025\%$  ( $\pm 2.5$  ppm) of the center frequency. (LTE Band5).

#### Time Period and Procedure:

The carrier frequency of the transmitter is measured at room temperature (20°C to provide a reference).

1. The equipment is turned on in a “standby” condition for one minute before applying power to the transmitter. Measurement of the carrier frequency of the transmitter is made within one minute after applying power to the transmitter.
2. Frequency measurements are made at 10°C intervals ranging from -30°C to +50°C. A period of at least one half-hour is provided to allow stabilization of the equipment at each temperature level.

**NOTE: The EUT is tested down to the battery endpoint.**

## 4. LIST OF TEST EQUIPMENT

Manufacture	Model/ Equipment	Serial Number	Calibration Interval	Calibration Due
MITEQ	AMF-6D-001180-35-20P/AMP	1081666	Annual	09/03/2016
Wainwright	WHK1.2/15G-10EF/H.P.F	4	Annual	04/27/2016
Wainwright	WHK3.3/18G-10EF/H.P.F	2	Annual	04/27/2016
Hewlett Packard	11667B / Power Splitter	10545	Annual	02/15/2017
Hewlett Packard	11667B / Power Splitter	11275	Annual	04/29/2016
ITECH	IT6720/ Power Supply	0100215626700119	Annual	11/02/2016
Schwarzbeck	UHAP/ Dipole Antenna	557	Biennial	03/23/2017
Schwarzbeck	UHAP/ Dipole Antenna	558	Biennial	03/23/2017
EXP	EX-TH400/ Chamber	None	Annual	05/29/2016
Schwarzbeck	BBHA 9120D/ Horn Antenna	147	Biennial	09/01/2016
Schwarzbeck	BBHA 9120D/ Horn Antenna	1299	Biennial	05/15/2017
Schwarzbeck	BBHA 9170/ Horn Antenna(15~40GHz)	BBHA9170342	Biennial	04/30/2017
Schwarzbeck	BBHA 9170/ Horn Antenna(15~35GHz)	BBHA9170124	Biennial	04/30/2017
Agilent	N9020A/Signal Analyzer	MY52090906	Annual	05/15/2016
Hewlett Packard	8493C/ATTENUATOR	17280	Annual	06/29/2016
REOHDE&SCHWARZ	FSV40/Spectrum Analyzer	1307.9002K40-100931-NK	Annual	06/04/2016
Agilent	8960 (E5515C)/ Base Station	MY48360800	Annual	10/30/2016
Anritsu Corp.	MT8820C/Wideband Radio Communication Tester	6200863156	Annual	02/26/2017
Anritsu Corp.	MT8820C/Wideband Radio Communication Tester	6201026545	Annual	02/16/2017



## 5. MEASUREMENT UNCERTAINTY

The measurement uncertainties shown below were calculated in accordance with the requirements of ANSI C63.4:2014.

All measurement uncertainty values are shown with a coverage factor of  $k = 2$  to indicate a 95 % level of confidence. The measurement data shown herein meets or exceeds the  $U_{\text{CISPR}}$  measurement uncertainty values specified in CISPR 16-4-2 and, thus, can be compared directly to specified limits to determine compliance.

Parameter	Expanded Uncertainty ( $\pm$ dB)
Conducted Disturbance (150 kHz ~ 30 MHz)	1.82
Radiated Disturbance (9 kHz ~ 30 MHz)	3.40
Radiated Disturbance (30 MHz ~ 1 GHz)	4.80
Radiated Disturbance (1 GHz ~ 18 GHz)	6.07

## 6. SUMMARY OF TEST RESULTS

FCC Part Section(s)	Test Description	Test Limit	Test Condition	Test Result
2.1049	Occupied Bandwidth	N/A	CONDUCTED	PASS
2.1051, 22.917(a), 24.238(a)	Band Edge / Spurious and Harmonic Emissions at Antenna Terminal.	< 43 + 10log <sub>10</sub> (P[Watts]) at Band Edge and for all out-of-band emissions		PASS
2.1046	*Conducted Output Power	N/A		PASS
24.232(d)	Peak- to- Average Ratio	< 13 dB		PASS
2.1055, 22.355	Frequency stability / variation of ambient temperature	< 2.5 ppm (Part22)		PASS
24.235		Emission must remain in band (Part24)		
22.913(a)(2)	Effective Radiated Power (Band 5)	< 7 Watts max. ERP	RADIATED	PASS
24.232(c)	Equivalent Isotropic Radiated Power (Band 2)	< 2 Watts max. EIRP		PASS
2.1053, 22.917(a), 24.238(a)	Radiated Spurious and Harmonic Emissions	< 43 + 10log <sub>10</sub> (P[Watts]) for all out-of band emissions		PASS

\*See SAR Report

## 7. SAMPLE CALCULATION

### A. ERP Sample Calculation

Mode	Ch./ Freq.		Measured Level(dBm)	Substitute LEVEL(dBm)	Ant. Gain (dBd)	C.L	Pol.	Limit W	ERP	
	channel	Freq.(MHz)							W	dBm
LTE Band5	20525	836.50	-6.73	40.89	-10.54	0.96	V	7	0.869	29.39

#### ERP = Substitute LEVEL(dBm) + Ant. Gain – CL(Cable Loss)

- 1) The EUT mounted on a wooden tripod is 2.5 meter above test site ground level.
- 2) During the test , the turn table is rotated until the maximum signal is found.
- 3) Record the field strength meter's level.
- 4) Replace the EUT with dipole/Horn antenna that is connected to a calibrated signal generator.
- 5) Increase the signal generator output till the field strength meter's level is equal to the item (3).
- 6) The signal generator output level with Ant. Gain and cable loss are the rating of equivalent isotropic radiated power(ERP).

## B. Emission Designator

### QPSK Modulation

#### **5MHz Bandwidth**

**Emission Designator = 4M48G7D**

LTE BW = 4.48 MHz

G = Phase Modulation

7 = Quantized/Digital Info

D = Data transmission; telemetry; telecommand

#### **10MHz Bandwidth**

**Emission Designator = 8M95G7D**

LTE BW = 8.95 MHz

G = Phase Modulation

7 = Quantized/Digital Info

D = Data transmission; telemetry; telecommand

### 16QAM Modulation

#### **5MHz Bandwidth**

**Emission Designator = 4M48W7D**

LTE BW = 4.48 MHz

W = main carrier modulated in a combination of two or more of the following modes;  
amplitude, angle, pulse

7 = Quantized/Digital Info

D = Data transmission; telemetry; telecommand

#### **10MHz Bandwidth**

**Emission Designator = 8M95W7D**

LTE BW = 8.95 MHz

W = main carrier modulated in a combination of two or more of the following modes;  
amplitude, angle, pulse

7 = Quantized/Digital Info

D = Data transmission; telemetry; telecommand

## 8. TEST DATA

### 8.1 EQUIVALENT ISOTROPIC RADIATED POWER (Band 2)

Freq (MHz)	Bandwidth	Modulation	Measured Level (dBm)	Substitute Level (dBm)	Ant. Gain(dBi)	C.L	Pol	Limit	EIRP	
								W	W	dBm
1850.7	1.4 MHz	QPSK	-18.21	14.48	10.04	1.36	V	2	0.207	23.16
		16-QAM	-19.32	13.37	10.04	1.36	V	2	0.160	22.05
1880.0		QPSK	-18.50	14.46	10.05	1.37	V	2	0.206	23.14
		16-QAM	-19.55	13.41	10.05	1.37	V	2	0.162	22.09
1909.3		QPSK	-19.22	13.98	10.06	1.38	V	2	0.185	22.66
		16-QAM	-20.38	12.82	10.06	1.38	V	2	0.141	21.50

#### Equivalent Isotropic Radiated Power Data (1.4 MHz Band 2 LTE)

Note: All of RB size has been tested for emissions and EIRP, with the 1RB configuration observed as the worst case

Freq (MHz)	Bandwidth	Modulation	Measured Level (dBm)	Substitute Level (dBm)	Ant. Gain(dBi)	C.L	Pol	Limit	EIRP	
								W	W	dBm
1851.5	3 MHz	QPSK	-18.13	14.56	10.04	1.36	V	2	0.211	23.24
		16-QAM	-19.35	13.34	10.04	1.36	V	2	0.159	22.02
1880.0		QPSK	-18.52	14.44	10.05	1.37	V	2	0.205	23.12
		16-QAM	-19.79	13.17	10.05	1.37	V	2	0.153	21.85
1908.5		QPSK	-19.40	13.77	10.06	1.38	V	2	0.176	22.45
		16-QAM	-20.34	12.83	10.06	1.38	V	2	0.142	21.51

#### Equivalent Isotropic Radiated Power Data (3 MHz Band 2 LTE)

Note: All of RB size has been tested for emissions and EIRP, with the 1RB configuration observed as the worst case

Freq (MHz)	Bandwidth	Modulation	Measured Level (dBm)	Substitute Level (dBm)	Ant. Gain(dBi)	C.L	Pol	EIRP		
								Limit	W	dBm
1852.5	5 MHz	QPSK	-18.26	14.43	10.04	1.36	V	2	0.204	23.11
		16-QAM	-19.38	13.31	10.04	1.36	V	2	0.158	21.99
1880.0		QPSK	-18.58	14.38	10.05	1.37	V	2	0.202	23.06
		16-QAM	-19.77	13.19	10.05	1.37	V	2	0.154	21.87
1907.5		QPSK	-19.31	13.83	10.06	1.38	V	2	0.178	22.51
		16-QAM	-20.55	12.59	10.06	1.38	V	2	0.134	21.27

**Equivalent Isotropic Radiated Power Data (5 MHz Band 2 LTE)**

Note: All of RB size has been tested for emissions and EIRP, with the 1RB configuration observed as the worst case

Freq (MHz)	Bandwidth	Modulation	Measured Level (dBm)	Substitute Level (dBm)	Ant. Gain(dBi)	C.L	Pol	EIRP		
								Limit	W	dBm
1855.0	10 MHz	QPSK	-18.10	14.59	10.04	1.36	V	2	0.212	23.27
		16-QAM	-19.34	13.35	10.04	1.36	V	2	0.160	22.03
1880.0		QPSK	-18.56	14.39	10.05	1.37	V	2	0.203	23.07
		16-QAM	-19.86	13.09	10.05	1.37	V	2	0.150	21.77
1905.0		QPSK	-19.03	14.03	10.05	1.38	V	2	0.186	22.70
		16-QAM	-20.42	12.64	10.05	1.38	V	2	0.135	21.31

**Equivalent Isotropic Radiated Power Data (10 MHz Band 2 LTE)**

Note: All of RB size has been tested for emissions and EIRP, with the 1RB configuration observed as the worst case

Freq (MHz)	Bandwidth	Modulation	Measured Level (dBm)	Substitute Level (dBm)	Ant. Gain(dBi)	C.L	Pol	Limit	EIRP	
								W	W	dBm
1857.5	15 MHz	QPSK	-18.19	14.50	10.04	1.36	V	2	0.208	23.18
		16-QAM	-19.27	13.42	10.04	1.36	V	2	0.162	22.10
1880.0		QPSK	-18.43	14.51	10.04	1.36	V	2	0.208	23.19
		16-QAM	-19.62	13.32	10.04	1.36	V	2	0.158	22.00
1902.5		QPSK	-18.93	14.12	10.05	1.38	V	2	0.190	22.79
		16-QAM	-20.29	12.76	10.05	1.38	V	2	0.139	21.43

**Equivalent Isotropic Radiated Power Data (15 MHz Band 2 LTE)**

Note: All of RB size has been tested for emissions and EIRP, with the 1RB configuration observed as the worst case

Freq (MHz)	Bandwidth	Modulation	Measured Level (dBm)	Substitute Level (dBm)	Ant. Gain(dBi)	C.L	Pol	Limit	EIRP	
								W	W	dBm
1860.0	20 MHz	QPSK	-18.20	14.49	10.04	1.36	V	2	0.208	23.17
		16-QAM	-19.45	13.24	10.04	1.36	V	2	0.156	21.92
1880.0		QPSK	-18.34	14.59	10.04	1.36	V	2	0.212	23.27
		16-QAM	-19.40	13.53	10.04	1.36	V	2	0.166	22.21
1900.0		QPSK	-18.71	14.35	10.05	1.38	V	2	0.200	23.02
		16-QAM	-20.17	12.89	10.05	1.38	V	2	0.143	21.56

**Equivalent Isotropic Radiated Power Data ( 20 MHz Band 2 LTE)**

Note: All of RB size has been tested for emissions and EIRP, with the 1RB configuration observed as the worst case

**NOTES:**

Equivalent Isotropic Radiated Power Measurements by Substitution Method  
according to ANSI/TIA/EIA-603-D-2010 June 24, 2010:

The EUT was placed on a non-conductive styrofoam resin table 3-meters from the receive antenna. Turntable rotation was adjusted for the highest reading on the receive spectrum analyzer. For LTE signals, RBW = 1-5% of the OBW, not to exceed 1MHz, VBW  $\geq 3 \times$  RBW, Detector = RMS. A Horn antenna was substituted in place of the EUT. This Horn antenna was driven by a signal generator and the level of the signal generator was adjusted to obtain the same receive spectrum analyzer reading. The conducted power at the terminals of the Horn antenna is measured. The difference between the gain of the horn and an isotropic antenna is taken into consideration and the EIRP is recorded.

Also, we have done x, y, z planes in EUT and horizontal and vertical polarization in detecting antenna. The worst case of the EUT is z plane in LTE mode. Also worst case of detecting Antenna is vertical polarization in LTE mode.

### 8.2 EFFECTIVE RADIATED POWER (Band 5)

Freq (MHz)	Bandwidth	Modulation	Measured Level (dBm)	Substitute Level (dBm)	Ant. Gain(dBd)	C.L	Pol	Limit		ERP	
								W	W	dBm	dBm
824.7	1.4 MHz	QPSK	-31.71	30.22	-10.59	0.88	H	7	0.075	18.75	
		16-QAM	-32.31	29.62	-10.59	0.88	H	7	0.065	18.15	
836.5		QPSK	-33.46	28.30	-10.54	0.89	H	7	0.049	16.87	
		16-QAM	-34.38	27.38	-10.54	0.89	H	7	0.039	15.95	
848.3		QPSK	-33.08	27.88	-10.49	0.89	H	7	0.045	16.50	
		16-QAM	-33.89	27.07	-10.49	0.89	H	7	0.037	15.69	

**Effective Radiated Power Data (1.4 MHz Band 5 LTE)**

Note: All of RB size has been tested for emissions and ERP, with the 1RB configuration observed as the worst case

Freq (MHz)	Bandwidth	Modulation	Measured Level (dBm)	Substitute Level (dBm)	Ant. Gain(dBd)	C.L	Pol	Limit		ERP	
								W	W	dBm	dBm
825.5	3 MHz	QPSK	-31.38	30.55	-10.59	0.88	H	7	0.081	19.08	
		16-QAM	-32.63	29.30	-10.59	0.88	H	7	0.061	17.83	
836.5		QPSK	-32.90	28.80	-10.54	0.89	H	7	0.055	17.37	
		16-QAM	-34.29	27.41	-10.54	0.89	H	7	0.040	15.98	
847.5		QPSK	-33.03	28.04	-10.50	0.89	H	7	0.046	16.65	
		16-QAM	-34.38	26.69	-10.50	0.89	H	7	0.034	15.30	

**Effective Radiated Power Data (3 MHz Band 5 LTE)**

Note: All of RB size has been tested for emissions and ERP, with the 1RB configuration observed as the worst case



Freq (MHz)	Bandwidth	Modulation	Measured Level (dBm)	Substitute Level (dBm)	Ant. Gain(dBd)	C.L	Pol	Limit		
								W	W	dBm
826.5	5 MHz	QPSK	-31.42	30.49	-10.59	0.88	H	7	0.080	19.02
		16-QAM	-32.71	29.20	-10.59	0.88	H	7	0.059	17.73
836.5		QPSK	-32.87	28.88	-10.55	0.89	H	7	0.056	17.44
		16-QAM	-34.08	27.67	-10.55	0.89	H	7	0.042	16.23
846.5		QPSK	-33.23	28.16	-10.51	0.89	H	7	0.047	16.76
		16-QAM	-34.27	27.12	-10.51	0.89	H	7	0.037	15.72

**Effective Radiated Power Data (5 MHz Band 5 LTE)**

Note: All of RB size has been tested for emissions and ERP, with the 1RB configuration observed as the worst case

Freq (MHz)	Bandwidth	Modulation	Measured Level (dBm)	Substitute Level (dBm)	Ant. Gain(dBd)	C.L	Pol	Limit		
								W	W	dBm
829.0	10 MHz	QPSK	-31.27	30.61	-10.59	0.88	H	7	0.082	19.14
		16-QAM	-32.79	29.09	-10.59	0.88	H	7	0.058	17.62
836.5		QPSK	-32.58	29.32	-10.56	0.89	H	7	0.061	17.87
		16-QAM	-33.76	28.14	-10.56	0.89	H	7	0.047	16.69
844.0		QPSK	-33.32	28.20	-10.52	0.89	H	7	0.048	16.79
		16-QAM	-34.71	26.81	-10.52	0.89	H	7	0.035	15.40

**Effective Radiated Power Data (10 MHz Band 5 LTE)**

Note: All of RB size has been tested for emissions and ERP, with the 1RB configuration observed as the worst case

**NOTES:**

Effective Radiated Power Output Measurements by Substitution Method

according to ANSI/TIA/EIA-603-D-2010 June 24, 2010:

The EUT was placed on a non-conductive styrofoam resin table 3-meters from the receive antenna. The receive antenna height and turntable rotation was adjusted for the highest reading on the receive spectrum analyzer. For LTE signals, RBW = 1-5% of the OBW, not to exceed 1MHz, VBW ≥ 3 x RBW, Detector = RMS.

A half-wave dipole was substituted in place of the EUT. This dipole antenna was driven by a signal generator and the level of the signal generator was adjusted to obtain the same receive spectrum analyzer reading. The conducted power at the terminals of the dipole is measured. The ERP is recorded.

Also, we have done x, y, z planes in EUT and horizontal and vertical polarization in detecting antenna. The worst case of the EUT is z plane in LTE mode. Also worst case of detecting Antenna is horizontal polarization in LTE mode.

## 8.3 RADIATED SPURIOUS EMISSIONS

### 8.3.1 RADIATED SPURIOUS EMISSIONS (1.4 MHz Band 2 LTE)

- ▣ OPERATING FREQUENCY: 1850.70 MHz
- ▣ MEASURED OUTPUT POWER: 23.16 dBm = 0.207 W
- ▣ MODULATION SIGNAL: 1.4 MHz QPSK
- ▣ DISTANCE: 3 meters
- ▣ LIMIT:  $43 + 10 \log_{10}(W) =$  36.16 dBc

Ch	Freq (MHz)	Measured Level (dBm)	Ant. Gain (dBi)	Substitute Level (dBm)	C.L	Pol	EIRP (dBm)	dBc
18607 (1850.7)	3,701.40	-54.01	12.32	-57.67	2.02	H	-47.37	70.53
	5,552.10	-48.33	13.02	-47.21	2.52	V	-36.71	59.87
	7,402.80	-58.04	11.06	-48.67	2.91	V	-40.52	63.68
18900 (1880.0)	3,760.00	-56.90	12.29	-60.50	1.93	H	-50.14	73.30
	5,640.00	-52.33	13.12	-51.40	2.57	V	-40.85	64.01
	7,520.00	-57.52	11.09	-48.68	3.03	H	-40.62	63.78
19193 (1909.3)	3,818.60	-54.21	12.28	-57.24	2.04	V	-47.00	70.16
	5,727.90	-46.99	13.06	-45.80	2.55	V	-35.29	58.45
	7,637.20	-56.71	11.37	-47.27	3.13	V	-39.03	62.19

- NOTES:**
1. Radiated Spurious Emission Measurements at 3 meters by Substitution Method according to ANSI/TIA/EIA-603-D-2010 June 24, 2010:
  2. We are performed all frequency to 10<sup>th</sup> harmonics from 30 MHz. Measurements above show only up to 3 maximum emissions noted, or would be lesser if no specific emissions from the EUT are recorded (ie: margin > 20 dB from the applicable limit) and considered that's already beyond the background noise floor.
  3. We have done x, y, z planes in EUT and horizontal and vertical polarization in detecting antenna.
  4. All of RB size has been tested for emissions and EIRP, with the 1RB configuration observed as the worst case
  5. We are performed 16QAM and QPSK modulations. The worst case data are reported in the table above.

### 8.3.2 RADIATED SPURIOUS EMISSIONS (3 MHz Band 2 LTE)

- ▣ OPERATING FREQUENCY: 1851.50 MHz
- ▣ MEASURED OUTPUT POWER: 23.24 dBm = 0.211 W
- ▣ MODULATION SIGNAL: 3 MHz QPSK
- ▣ DISTANCE: 3 meters
- ▣ LIMIT:  $43 + 10 \log_{10}(W) =$  36.24 dBc

Ch	Freq (MHz)	Measured Level (dBm)	Ant. Gain (dBi)	Substitute Level (dBm)	C.L	Pol	EIRP (dBm)	dBc
18615 (1851.5)	3,703.00	-55.03	12.32	-58.67	2.02	H	-48.37	71.61
	5,554.50	-47.04	13.03	-45.93	2.52	V	-35.42	58.66
	7,406.00	-57.65	11.05	-48.21	2.92	H	-40.08	63.32
18900 (1880.0)	3,760.00	-55.02	12.29	-58.62	1.93	V	-48.26	71.50
	5,640.00	-52.30	13.12	-51.37	2.57	V	-40.82	64.06
	7,520.00	-58.02	11.09	-49.18	3.03	H	-41.12	64.36
19185 (1908.5)	3,817.00	-54.50	12.28	-57.61	2.04	V	-47.37	70.61
	5,725.50	-46.74	13.07	-45.55	2.56	V	-35.04	58.28
	7,634.00	-58.28	11.37	-48.83	3.16	V	-40.62	63.86

- NOTES:**
1. Radiated Spurious Emission Measurements at 3 meters by Substitution Method according to ANSI/TIA/EIA-603-D-2010 June 24, 2010:
  2. We are performed all frequency to 10<sup>th</sup> harmonics from 30 MHz. Measurements above show only up to 3 maximum emissions noted, or would be lesser if no specific emissions from the EUT are recorded (ie: margin > 20 dB from the applicable limit) and considered that's already beyond the background noise floor.
  3. We have done x, y, z planes in EUT and horizontal and vertical polarization in detecting antenna.
  4. All of RB size has been tested for emissions and EIRP, with the 1RB configuration observed as the worst case
  5. We are performed 16QAM and QPSK modulations. The worst case data are reported in the table above.

**8.3.3 RADIATED SPURIOUS EMISSIONS (5 MHz Band 2 LTE)**

- ▣ OPERATING FREQUENCY: 1852.50 MHz
- ▣ MEASURED OUTPUT POWER: 23.11 dBm = 0.204 W
- ▣ MODULATION SIGNAL: 5 MHz QPSK
- ▣ DISTANCE: 3 meters
- ▣ LIMIT:  $43 + 10 \log_{10}(W) =$  36.11 dBc

Ch	Freq (MHz)	Measured Level (dBm)	Ant. Gain (dBi)	Substitute Level (dBm)	C.L	Pol	EIRP (dBm)	dBc
18625 (1852.5)	3,705.00	-55.84	12.32	-59.47	2.01	H	-49.16	72.27
	5,557.50	-49.25	13.04	-48.13	2.53	V	-37.62	60.73
	7,410.00	-56.21	11.05	-46.71	2.92	V	-38.58	61.69
18900 (1880.0)	3,760.00	-55.54	12.29	-59.14	1.93	H	-48.78	71.89
	5,640.00	-53.74	13.12	-52.81	2.57	V	-42.26	65.37
	7,520.00	-57.73	11.09	-48.89	3.03	H	-40.83	63.94
19175 (1907.5)	3,815.00	-57.76	12.29	-60.97	2.04	H	-50.72	73.83
	5,722.50	-49.09	13.08	-47.90	2.57	V	-37.39	60.50
	7,630.00	-57.41	11.36	-47.95	3.19	H	-39.78	62.89

- NOTES:**
1. Radiated Spurious Emission Measurements at 3 meters by Substitution Method according to ANSI/TIA/EIA-603-D-2010 June 24, 2010:
  2. We are performed all frequency to 10<sup>th</sup> harmonics from 30 MHz. Measurements above show only up to 3 maximum emissions noted, or would be lesser if no specific emissions from the EUT are recorded (ie: margin > 20 dB from the applicable limit) and considered that's already beyond the background noise floor.
  3. We have done x, y, z planes in EUT and horizontal and vertical polarization in detecting antenna.
  4. All of RB size has been tested for emissions and EIRP, with the 1RB configuration observed as the worst case
  5. We are performed 16QAM and QPSK modulations. The worst case data are reported in the table above.

### 8.3.4 RADIATED SPURIOUS EMISSIONS (10 MHz Band 2 LTE)

- ▣ OPERATING FREQUENCY: 1855.00 MHz
- ▣ MEASURED OUTPUT POWER: 23.27 dBm = 0.212 W
- ▣ MODULATION SIGNAL: 10 MHz QPSK
- ▣ DISTANCE: 3 meters
- ▣ LIMIT:  $43 + 10 \log_{10}(W) =$  36.27 dBc

Ch	Freq (MHz)	Measured Level (dBm)	Ant. Gain (dBi)	Substitute Level (dBm)	C.L	Pol	EIRP (dBm)	dBc
18650 (1855.0)	3,710.00	-56.20	12.31	-59.78	1.99	H	-49.46	72.73
	5,565.00	-49.31	13.05	-48.15	2.51	V	-37.61	60.88
	7,420.00	-56.89	11.05	-47.41	2.93	V	-39.29	62.56
18900 (1880.0)	3,760.00	-56.75	12.29	-60.35	1.93	H	-49.99	73.26
	5,640.00	-52.76	13.12	-51.83	2.57	V	-41.28	64.55
	7,520.00	-57.60	11.09	-48.76	3.03	V	-40.70	63.97
19150 (1905.0)	3,810.00	-57.65	12.29	-61.10	2.03	V	-50.84	74.11
	5,715.00	-50.01	13.10	-48.67	2.54	V	-38.11	61.38
	7,620.00	-57.23	11.33	-47.89	3.08	H	-39.64	62.91

- NOTES:**
1. Radiated Spurious Emission Measurements at 3 meters by Substitution Method according to ANSI/TIA/EIA-603-D-2010 June 24, 2010:
  2. We are performed all frequency to 10<sup>th</sup> harmonics from 30 MHz. Measurements above show only up to 3 maximum emissions noted, or would be lesser if no specific emissions from the EUT are recorded (ie: margin > 20 dB from the applicable limit) and considered that's already beyond the background noise floor.
  3. We have done x, y, z planes in EUT and horizontal and vertical polarization in detecting antenna.
  4. All of RB size has been tested for emissions and EIRP, with the 1RB configuration observed as the worst case
  5. We are performed 16QAM and QPSK modulations. The worst case data are reported in the table above.

**8.3.5 RADIATED SPURIOUS EMISSIONS (15 MHz Band 2 LTE)**

- ▣ OPERATING FREQUENCY: 1880.00 MHz
- ▣ MEASURED OUTPUT POWER: 23.19 dBm = 0.208 W
- ▣ MODULATION SIGNAL: 15 MHz QPSK
- ▣ DISTANCE: 3 meters
- ▣ LIMIT:  $43 + 10 \log_{10}(W) =$  36.19 dBc

Ch	Freq (MHz)	Measured Level (dBm)	Ant. Gain (dBi)	Substitute Level (dBm)	C.L	Pol	EIRP (dBm)	dBc
18675 (1857.5)	3,715.00	-55.20	12.31	-60.36	2.08	H	-50.13	73.32
	5,572.50	-48.87	13.06	-50.10	2.54	V	-39.58	62.77
	7,430.00	-57.75	11.04	-50.96	2.92	V	-42.84	66.03
18900 (1880.0)	3,760.00	-56.30	12.29	-59.90	1.93	H	-49.54	72.73
	5,640.00	-53.18	13.12	-52.25	2.57	V	-41.70	64.89
	7,520.00	-56.69	11.09	-47.85	3.03	H	-39.79	62.98
19125 (1902.5)	3,805.00	-57.72	12.30	-61.09	2.04	V	-50.83	74.02
	5,707.50	-49.38	13.12	-47.97	2.51	V	-37.36	60.55
	7,610.00	-56.21	11.31	-47.08	3.09	H	-38.86	62.05

- NOTES:**
1. Radiated Spurious Emission Measurements at 3 meters by Substitution Method according to ANSI/TIA/EIA-603-D-2010 June 24, 2010:
  2. We are performed all frequency to 10<sup>th</sup> harmonics from 30 MHz. Measurements above show only up to 3 maximum emissions noted, or would be lesser if no specific emissions from the EUT are recorded (ie: margin > 20 dB from the applicable limit) and considered that's already beyond the background noise floor.
  3. We have done x, y, z planes in EUT and horizontal and vertical polarization in detecting antenna.
  4. All of RB size has been tested for emissions and EIRP, with the 1RB configuration observed as the worst case
  5. We are performed 16QAM and QPSK modulations. The worst case data are reported in the table above.

### 8.3.6 RADIATED SPURIOUS EMISSIONS (20 MHz Band 2 LTE)

- ▣ OPERATING FREQUENCY: 1880.00 MHz
- ▣ MEASURED OUTPUT POWER: 23.27 dBm = 0.212 W
- ▣ MODULATION SIGNAL: 20 MHz QPSK
- ▣ DISTANCE: 3 meters
- ▣ LIMIT:  $43 + 10 \log_{10}(W) =$  36.27 dBc

Ch	Freq (MHz)	Measured Level (dBm)	Ant. Gain (dBi)	Substitute Level (dBm)	C.L	Pol	EIRP (dBm)	dBc
18700 (1860.0)	3,720.00	-54.66	12.31	-58.45	2.07	H	-48.21	71.48
	5,580.00	-47.84	13.07	-46.56	2.51	V	-36.00	59.27
	7,440.00	-56.69	11.04	-47.38	2.92	H	-39.26	62.53
18900 (1880.0)	3,760.00	-57.50	12.29	-61.10	1.93	H	-50.74	74.01
	5,640.00	-50.29	13.12	-49.36	2.57	V	-38.81	62.08
	7,520.00	-56.13	11.09	-47.29	3.03	V	-39.23	62.50
19100 (1900.0)	3,800.00	-56.16	12.30	-59.45	2.04	H	-49.19	72.46
	5,700.00	-48.53	13.13	-47.35	2.52	V	-36.74	60.01
	7,600.00	-55.85	11.29	-46.61	3.05	V	-38.37	61.64

- NOTES:**
1. Radiated Spurious Emission Measurements at 3 meters by Substitution Method according to ANSI/TIA/EIA-603-D-2010 June 24, 2010:
  2. We are performed all frequency to 10<sup>th</sup> harmonics from 30 MHz. Measurements above show only up to 3 maximum emissions noted, or would be lesser if no specific emissions from the EUT are recorded (ie: margin > 20 dB from the applicable limit) and considered that's already beyond the background noise floor.
  3. We have done x, y, z planes in EUT and horizontal and vertical polarization in detecting antenna.
  4. All of RB size has been tested for emissions and EIRP, with the 1RB configuration observed as the worst case
  5. We are performed 16QAM and QPSK modulations. The worst case data are reported in the table above.

### 8.3.7 RADIATED SPURIOUS EMISSIONS (1.4 MHz Band 5 LTE)

- ▣ OPERATING FREQUENCY: 824.70 MHz
- ▣ MEASURED OUTPUT POWER: 18.75 dBm = 0.075 W
- ▣ MODULATION SIGNAL: 1.4 MHz QPSK
- ▣ DISTANCE: 3 meters
- ▣ LIMIT:  $43 + 10 \log_{10}(W) =$  31.75 dBc

Ch	Freq (MHz)	Measured Level (dBm)	Ant. Gain (dBd)	Substitute Level (dBm)	C.L	Pol	ERP (dBm)	dBc
20407 (824.7)	1,649.40	-51.85	9.71	-59.89	1.29	H	-51.47	70.22
	2,474.10	-59.71	10.54	-64.83	1.60	V	-55.89	74.64
	3,298.80	-58.86	12.23	-63.94	1.85	V	-53.56	72.31
20525 (836.5)	1,673.00	-56.56	9.78	-64.73	1.28	H	-56.23	74.98
	2,509.50	-58.85	10.65	-63.85	1.61	H	-54.81	73.56
	3,346.00	-57.53	12.41	-63.01	1.86	V	-52.46	71.21
20643 (848.3)	1,696.60	-57.21	9.84	-65.43	1.30	V	-56.89	75.64
	2,544.90	-59.62	10.72	-64.51	1.63	V	-55.42	74.17
	3,393.20	-58.61	12.40	-63.90	1.87	V	-53.37	72.12

- NOTES:**
1. Radiated Spurious Emission Measurements at 3 meters by Substitution Method according to ANSI/TIA/EIA-603-D-2010 June 24, 2010:
  2. We are performed all frequency to 10<sup>th</sup> harmonics from 30 MHz. Measurements above show only up to 3 maximum emissions noted, or would be lesser if no specific emissions from the EUT are recorded (ie: margin > 20 dB from the applicable limit) and considered that's already beyond the background noise floor.
  3. We have done x, y, z planes in EUT and horizontal and vertical polarization in detecting antenna.
  4. All of RB size has been tested for emissions and ERP, with the 1RB configuration observed as the worst case
  5. We are performed 16QAM and QPSK modulations. The worst case data are reported in the table above.



### 8.3.8 RADIATED SPURIOUS EMISSIONS (3 MHz Band 5 LTE)

- ▣ OPERATING FREQUENCY: 825.50 MHz
- ▣ MEASURED OUTPUT POWER: 19.08 dBm = 0.081 W
- ▣ MODULATION SIGNAL: 3 MHz QPSK
- ▣ DISTANCE: 3 meters
- ▣ LIMIT:  $43 + 10 \log_{10}(W) =$  32.08 dBc

Ch	Freq (MHz)	Measured Level (dBm)	Ant. Gain (dBd)	Substitute Level (dBm)	C.L	Pol	ERP (dBm)	dBc
20415 (825.5)	1,651.00	-53.27	9.71	-61.31	1.29	V	-52.89	71.97
	2,476.50	-50.80	10.54	-55.87	1.61	H	-46.94	66.02
	3,302.00	-59.04	12.25	-64.17	1.85	H	-53.77	72.85
20525 (836.5)	1,673.00	-58.60	9.78	-66.77	1.28	H	-58.27	77.35
	2,509.50	-52.60	10.65	-57.60	1.61	H	-48.56	67.64
	3,346.00	-57.58	12.41	-63.06	1.86	H	-52.51	71.59
20635 (847.5)	1,695.00	-58.19	9.84	-66.43	1.30	H	-57.89	76.97
	2,542.50	-53.78	10.72	-58.64	1.63	H	-49.55	68.63
	3,390.00	-58.19	12.40	-63.42	1.84	V	-52.86	71.94

- NOTES:**
1. Radiated Spurious Emission Measurements at 3 meters by Substitution Method according to ANSI/TIA/EIA-603-D-2010 June 24, 2010:
  2. We are performed all frequency to 10<sup>th</sup> harmonics from 30 MHz. Measurements above show only up to 3 maximum emissions noted, or would be lesser if no specific emissions from the EUT are recorded (ie: margin > 20 dB from the applicable limit) and considered that's already beyond the background noise floor.
  3. We have done x, y, z planes in EUT and horizontal and vertical polarization in detecting antenna.
  4. All of RB size has been tested for emissions and ERP, with the 1RB configuration observed as the worst case
  5. We are performed 16QAM and QPSK modulations. The worst case data are reported in the table above.

### 8.3.9 RADIATED SPURIOUS EMISSIONS (5 MHz Band 5 LTE)

- ▣ OPERATING FREQUENCY: 826.50 MHz
- ▣ MEASURED OUTPUT POWER: 19.02 dBm = 0.080 W
- ▣ MODULATION SIGNAL: 5 MHz QPSK
- ▣ DISTANCE: 3 meters
- ▣ LIMIT:  $43 + 10 \log_{10}(W) =$  32.02 dBc

Ch	Freq (MHz)	Measured Level (dBm)	Ant. Gain (dBd)	Substitute Level (dBm)	C.L	Pol	ERP (dBm)	dBc
20425 (826.5)	1,653.00	-53.69	9.72	-61.74	1.29	V	-53.31	72.33
	2,479.50	-51.30	10.54	-56.32	1.61	H	-47.39	66.41
	3,306.00	-58.90	12.26	-64.09	1.86	V	-53.69	72.71
20525 (836.5)	1,673.00	-57.38	9.78	-65.55	1.28	V	-57.05	76.07
	2,509.50	-55.12	10.65	-60.12	1.61	H	-51.08	70.10
	3,346.00	-58.82	12.41	-64.30	1.86	V	-53.75	72.77
20625 (846.5)	1,693.00	-57.41	9.83	-65.66	1.30	H	-57.13	76.15
	2,539.50	-52.88	10.71	-57.70	1.63	H	-48.62	67.64
	3,386.00	-59.32	12.40	-64.71	1.84	H	-54.15	73.17

- NOTES:**
1. Radiated Spurious Emission Measurements at 3 meters by Substitution Method according to ANSI/TIA/EIA-603-D-2010 June 24, 2010:
  2. We are performed all frequency to 10<sup>th</sup> harmonics from 30 MHz. Measurements above show only up to 3 maximum emissions noted, or would be lesser if no specific emissions from the EUT are recorded (ie: margin > 20 dB from the applicable limit) and considered that's already beyond the background noise floor.
  3. We have done x, y, z planes in EUT and horizontal and vertical polarization in detecting antenna.
  4. All of RB size has been tested for emissions and ERP, with the 1RB configuration observed as the worst case
  5. We are performed 16QAM and QPSK modulations. The worst case data are reported in the table above.

**8.3.10 RADIATED SPURIOUS EMISSIONS (10 MHz Band 5 LTE)**

- ▣ OPERATING FREQUENCY: 829.00 MHz
- ▣ MEASURED OUTPUT POWER: 19.14 dBm = 0.082 W
- ▣ MODULATION SIGNAL: 10 MHz QPSK
- ▣ DISTANCE: 3 meters
- ▣ LIMIT:  $43 + 10 \log_{10}(W) =$  32.14 dBc

Ch	Freq (MHz)	Measured Level (dBm)	Ant. Gain (dBd)	Substitute Level (dBm)	C.L	Pol	ERP (dBm)	dBc
20450 (829.0)	1,658.00	-53.56	9.73	-61.63	1.28	H	-53.18	72.32
	2,487.00	-54.21	10.54	-59.19	1.62	H	-50.27	69.41
	3,316.00	-58.59	12.30	-63.90	1.89	V	-53.49	72.63
20525 (836.5)	1,673.00	-56.27	9.78	-64.44	1.28	H	-55.94	75.08
	2,509.50	-55.20	10.65	-60.20	1.61	H	-51.16	70.30
	3,346.00	-58.14	12.41	-63.62	1.86	V	-53.07	72.21
20600 (844.0)	1,688.00	-56.45	9.81	-64.69	1.30	V	-56.18	75.32
	2,532.00	-54.98	10.69	-59.75	1.62	H	-50.68	69.82
	3,376.00	-57.75	12.41	-63.28	1.85	V	-52.72	71.86

- NOTES:**
1. Radiated Spurious Emission Measurements at 3 meters by Substitution Method according to ANSI/TIA/EIA-603-D-2010 June 24, 2010:
  2. We are performed all frequency to 10<sup>th</sup> harmonics from 30 MHz. Measurements above show only up to 3 maximum emissions noted, or would be lesser if no specific emissions from the EUT are recorded (ie: margin > 20 dB from the applicable limit) and considered that's already beyond the background noise floor.
  3. We have done x, y, z planes in EUT and horizontal and vertical polarization in detecting antenna.
  4. All of RB size has been tested for emissions and ERP, with the 1RB configuration observed as the worst case
  5. We are performed 16QAM and QPSK modulations. The worst case data are reported in the table above.

### 8.4 PEAK-TO-AVERAGE RATIO

Band	Band Width	Frequency (MHz)	Modulation	Resource Block Size	Resource Block Offset	Data ( dB )
2	1.4 MHz	1880.0	QPSK	6	0	4.97
			16-QAM	6	0	5.76
	3 MHz		QPSK	15	0	5.13
			16-QAM	15	0	5.95
	5 MHz		QPSK	25	0	5.05
			16-QAM	25	0	5.82
	10 MHz		QPSK	50	0	5.04
			16-QAM	50	0	5.81
	15 MHz		QPSK	75	0	4.77
			16-QAM	75	0	5.65
	20 MHz		QPSK	100	0	4.84
			16-QAM	100	0	5.71

- Plots of the EUT's Peak- to- Average Ratio are shown Page 61 ~ 66.

### 8.5 OCCUPIED BANDWIDTH

Band	Band Width	Frequency (MHz)	Modulation	Resource Block Size	Resource Block Offset	Data ( MHz )
2	1.4 MHz	1880.0	QPSK	6	0	1.0943
			16-QAM	6	0	1.0962
	3 MHz		QPSK	15	0	2.6963
			16-QAM	15	0	2.6977
	5 MHz		QPSK	25	0	4.5057
			16-QAM	25	0	4.4917
	10 MHz		QPSK	50	0	8.9730
			16-QAM	50	0	8.9328
	15 MHz		QPSK	75	0	13.409
			16-QAM	75	0	13.395
	20 MHz		QPSK	100	0	17.859
			16-QAM	100	0	17.909

Band	Band Width	Frequency (MHz)	Modulation	Resource Block Size	Resource Block Offset	Data ( MHz )
5	1.4 MHz	836.5	QPSK	6	0	1.0964
			16-QAM	6	0	1.0962
	3 MHz		QPSK	15	0	2.7062
			16-QAM	15	0	2.6914
	5 MHz		QPSK	25	0	4.5068
			16-QAM	25	0	4.4845
	10 MHz		QPSK	50	0	8.9475
			16-QAM	50	0	8.9509

- Plots of the EUT's Occupied Bandwidth are shown Page 51 ~ 60.

### 8.6 CONDUCTED SPURIOUS EMISSIONS

■ FACTORS FOR FREQUENCY

Frequency Range (GHz)	Factor [dB]
0.03 – 1	27.145
1 – 5	26.960
5 – 10	27.542
10 – 15	28.439
15 – 20	29.144
Above 20	30.148

**NOTES:**

Factor(dB) = Cable Loss + Attenuator + Power Splitter

Band	Band Width (MHz)	Frequency (MHz)	Frequency of Maximum Harmonic (GHz)	Factor (dB)	Measurement Maximum Data (dBm)	Result (dBm)	Limit (dBm)
2	1.4	1850.7	18.93850	29.144	-55.40	-26.256	-13.00
		1880.0	18.92400	29.144	-54.83	-25.686	
		1909.3	19.13300	29.144	-55.31	-26.166	
	3	1851.5	18.62500	29.144	-55.84	-26.696	
		1880.0	18.82700	29.144	-55.77	-26.626	
		1908.5	19.56800	29.144	-55.87	-26.726	
	5	1852.5	19.54750	29.144	-54.82	-25.676	
		1880.0	16.57150	29.144	-55.37	-26.226	
		1907.5	18.66150	29.144	-55.03	-25.886	
	10	1855.0	18.93950	29.144	-55.75	-26.606	
		1880.0	18.33950	29.144	-55.47	-26.326	
		1905.0	19.55150	29.144	-54.98	-25.836	
	15	1857.5	19.16850	29.144	-55.72	-26.576	
		1880.0	19.63950	29.144	-54.99	-25.846	
		1902.5	19.03150	29.144	-55.29	-26.146	
	20	1860.0	19.55800	29.144	-55.59	-26.446	
		1880.0	18.90500	29.144	-55.86	-26.716	
		1900.0	18.63050	29.144	-55.99	-26.846	

Band	Band Width (MHz)	Frequency (MHz)	Frequency of Maximum Harmonic (GHz)	Factor (dB)	Measurement Maximum Data (dBm)	Result (dBm)	Limit (dBm)
5	1.4	824.7	2.55054	27.145	-58.68	-31.535	-13.00
		836.5	3.71451	27.145	-58.90	-31.755	
		848.3	6.23000	27.542	-58.58	-31.038	
	3	825.5	7.26550	27.542	-59.09	-31.548	
		836.5	6.92025	27.542	-57.56	-30.018	
		847.5	6.54850	27.542	-58.92	-31.378	
	5	826.5	3.68817	27.145	-58.71	-31.565	
		836.5	6.18575	27.542	-58.34	-30.798	
		846.5	3.11165	27.145	-58.55	-31.405	
	10	829.0	3.70656	27.145	-58.92	-31.775	
		836.5	3.13774	27.145	-59.06	-31.915	
		844.0	3.58405	27.145	-58.51	-31.365	

**NOTES:**

1. Conducted Spurious Emissions was Tested QPSK Modulation, Resource Block Size 1 and Resource Block Offset 0
2. Result (dBm) = Measurement Maximum Data (dBm) + Factor (dB)

- Plots of the EUT's Conducted Spurious Emissions are shown Page 97 ~ 126.

**8.6.1 BAND EDGE**

- Plots of the EUT's Band Edge are shown Page 67 ~ 96.

## 8.7 FREQUENCY STABILITY / VARIATION OF AMBIENT TEMPERATURE

### 8.7.1 FREQUENCY STABILITY (1.4 MHz Band 2 LTE)

- ▣ OPERATING FREQUENCY: 1880,000,000 Hz
- ▣ CHANNEL: 18900 (1.4 MHz)
- ▣ REFERENCE VOLTAGE: 3.85 VDC
- ▣ DEVIATION LIMIT: Emission must remain in band

Voltage (%)	Power (VDC)	Temp. (°C)	Frequency (Hz)	Frequency Error (Hz)	Deviation (%)	ppm
100%	3.85	+20(Ref)	1879 999 993	0.0	0.000 000	0.000
100%		-30	1879 999 990	-3.3	0.000 000	-0.002
100%		-20	1879 999 985	-7.7	0.000 000	-0.004
100%		-10	1879 999 987	-6.2	0.000 000	-0.003
100%		0	1879 999 984	-8.9	0.000 000	-0.005
100%		+10	1879 999 986	-6.8	0.000 000	-0.004
100%		+30	1879 999 989	-4.1	0.000 000	-0.002
100%		+40	1879 999 986	-7.2	0.000 000	-0.004
100%		+50	1879 999 983	-9.6	-0.000 001	-0.005
Batt. Endpoint	3.70	+20	1879 999 985	-7.7	0.000 000	-0.004

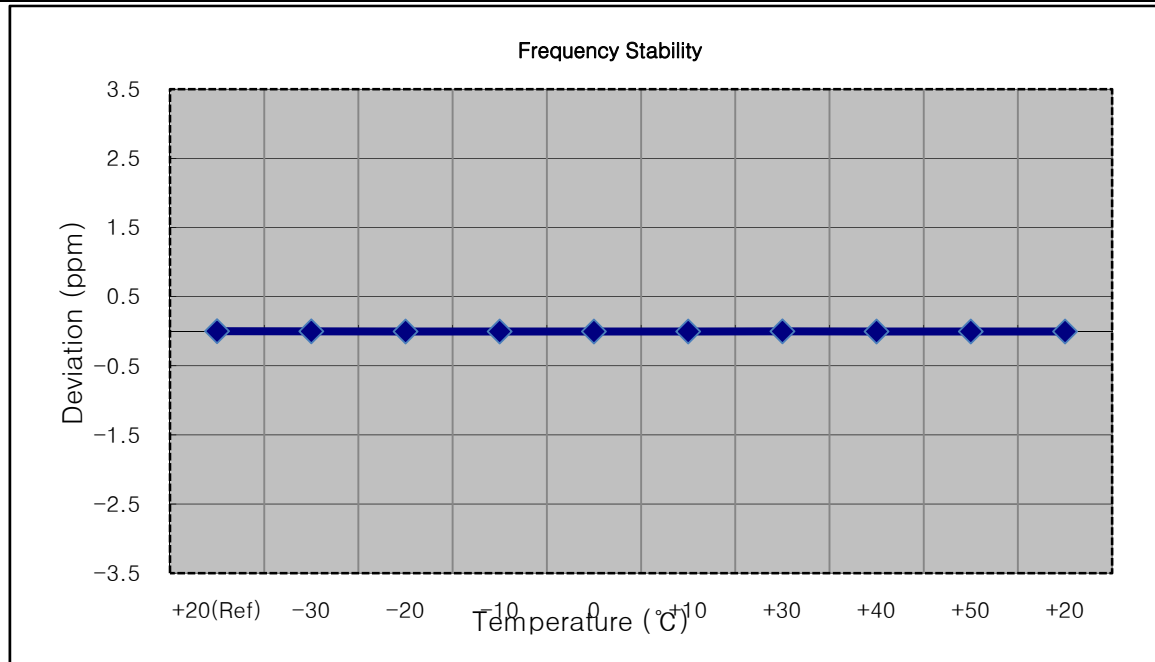



**8.7.2 FREQUENCY STABILITY (3 MHz Band 2 LTE)**

- ▣ OPERATING FREQUENCY: 1880,000,000 Hz
- ▣ CHANNEL: 18900 (3 MHz)
- ▣ REFERENCE VOLTAGE: 3.85 VDC
- ▣ DEVIATION LIMIT: Emission must remain in band

Voltage (%)	Power (VDC)	Temp. (°C)	Frequency (Hz)	Frequency Error (Hz)	Deviation (%)	ppm
100%	3.85	+20(Ref)	1879 999 993	0.0	0.000 000	0.000
100%		-30	1879 999 988	-5.6	0.000 000	-0.003
100%		-20	1879 999 990	-3.3	0.000 000	-0.002
100%		-10	1879 999 986	-7.3	0.000 000	-0.004
100%		0	1879 999 987	-6.2	0.000 000	-0.003
100%		+10	1879 999 986	-7.1	0.000 000	-0.004
100%		+30	1879 999 986	-7.3	0.000 000	-0.004
100%		+40	1879 999 986	-7.8	0.000 000	-0.004
100%		+50	1879 999 989	-4.3	0.000 000	-0.002
Batt. Endpoint	3.70	+20	1879 999 988	-5.3	0.000 000	-0.003

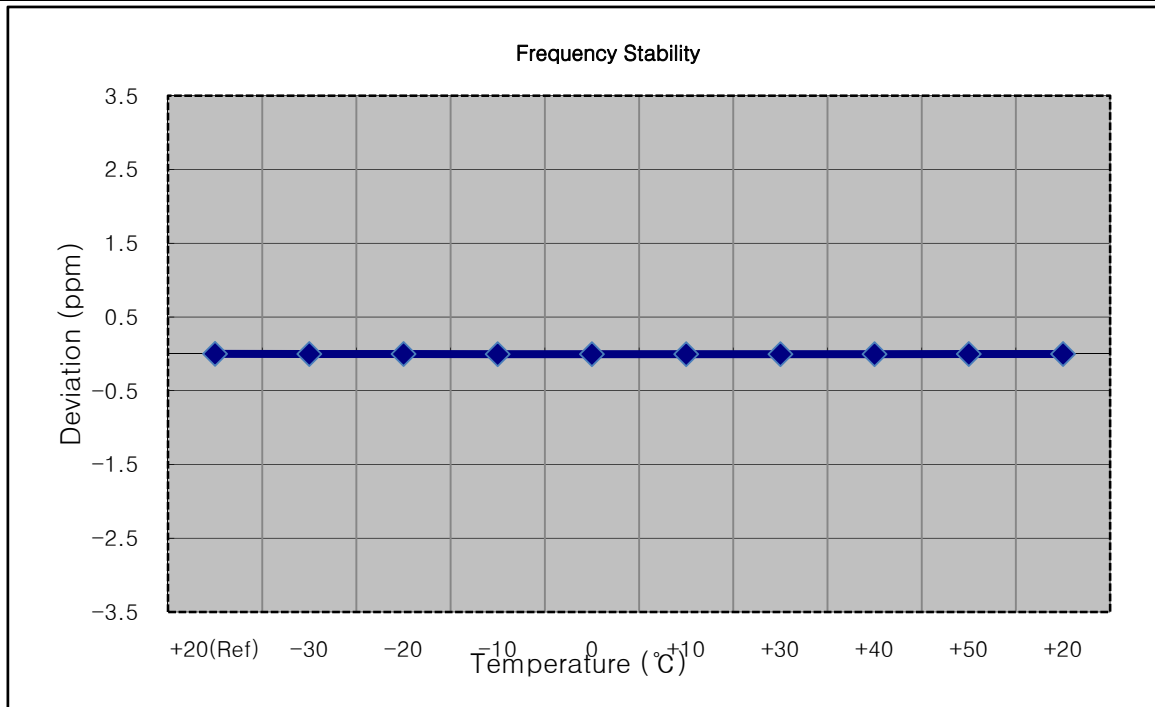

**8.7.3 FREQUENCY STABILITY (5 MHz Band 2 LTE)**

- ▣ OPERATING FREQUENCY: 1880,000,000 Hz
- ▣ CHANNEL: 18900 (5 MHz)
- ▣ REFERENCE VOLTAGE: 3.85 VDC
- ▣ DEVIATION LIMIT: Emission must remain in band

Voltage (%)	Power (VDC)	Temp. (°C)	Frequency (Hz)	Frequency Error (Hz)	Deviation (%)	ppm
100%	3.85	+20(Ref)	1879 999 992	0.0	0.000 000	0.000
100%		-30	1879 999 988	-4.6	0.000 000	-0.002
100%		-20	1879 999 986	-6.7	0.000 000	-0.004
100%		-10	1879 999 987	-5.3	0.000 000	-0.003
100%		0	1879 999 986	-6.7	0.000 000	-0.004
100%		+10	1879 999 984	-8.8	0.000 000	-0.005
100%		+30	1879 999 987	-5.6	0.000 000	-0.003
100%		+40	1879 999 984	-8.9	0.000 000	-0.005
100%		+50	1879 999 988	-4.3	0.000 000	-0.002
Batt. Endpoint	3.70	+20	1879 999 984	-8.0	0.000 000	-0.004

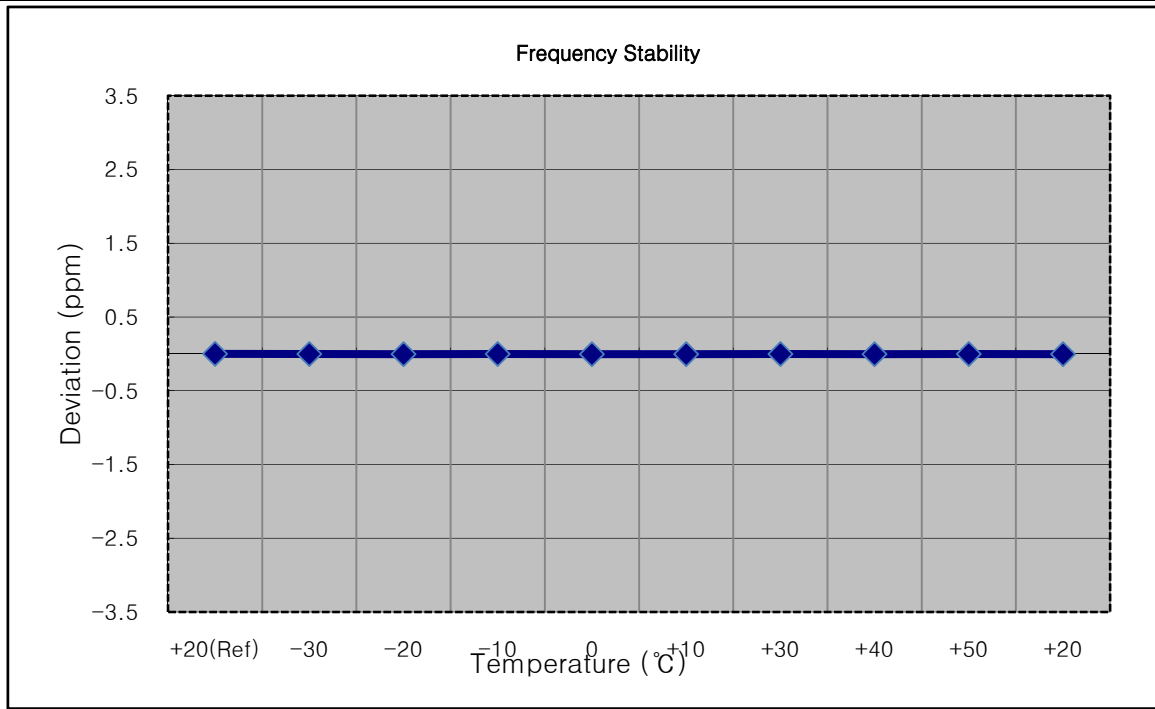

**8.7.4 FREQUENCY STABILITY (10 MHz Band 2 LTE)**

- ▣ OPERATING FREQUENCY: 1880,000,000 Hz
- ▣ CHANNEL: 18900 (10 MHz)
- ▣ REFERENCE VOLTAGE: 3.85 VDC
- ▣ DEVIATION LIMIT: Emission must remain in band

Voltage (%)	Power (VDC)	Temp. (°C)	Frequency (Hz)	Frequency Error (Hz)	Deviation (%)	ppm
100%	3.85	+20(Ref)	1879 999 992	0.0	0.000 000	0.000
100%		-30	1879 999 981	-10.9	-0.000 001	-0.006
100%		-20	1879 999 986	-5.8	0.000 000	-0.003
100%		-10	1879 999 987	-5.3	0.000 000	-0.003
100%		0	1879 999 985	-7.1	0.000 000	-0.004
100%		+10	1879 999 985	-7.0	0.000 000	-0.004
100%		+30	1879 999 984	-8.3	0.000 000	-0.004
100%		+40	1879 999 986	-5.7	0.000 000	-0.003
100%		+50	1879 999 986	-5.7	0.000 000	-0.003
Batt. Endpoint	3.70	+20	1879 999 987	-5.3	0.000 000	-0.003

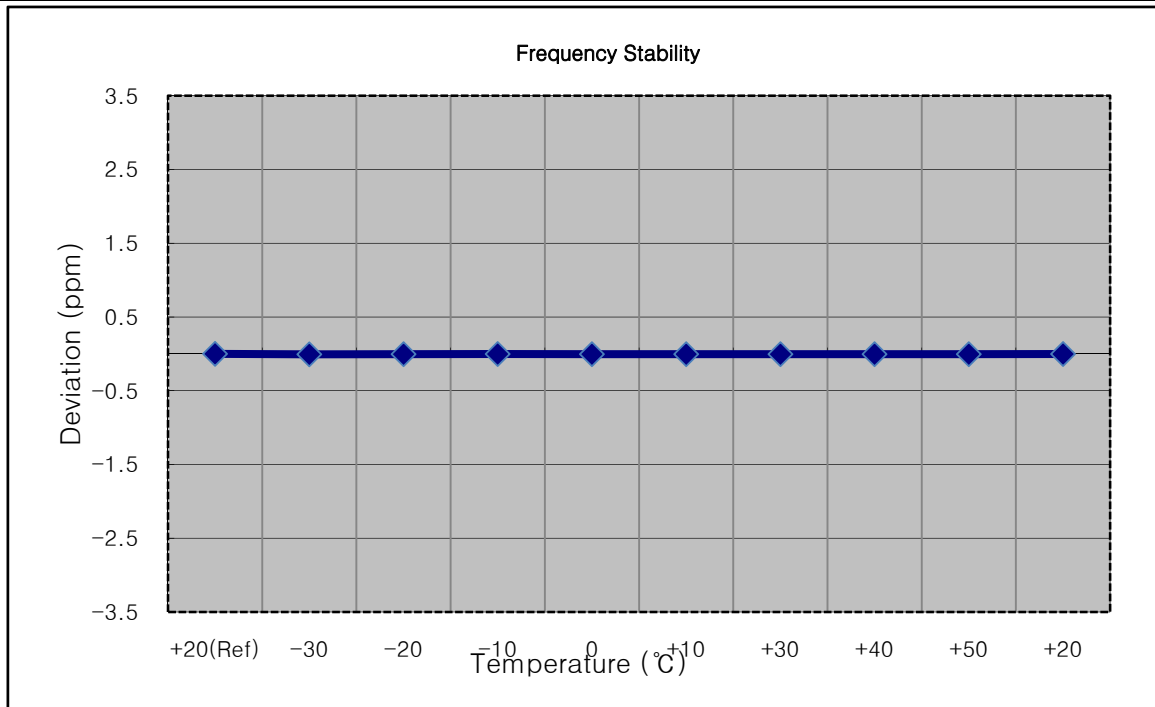

**8.7.5 FREQUENCY STABILITY (15 MHz Band 2 LTE)**

- ▣ OPERATING FREQUENCY: 1880,000,000 Hz
- ▣ CHANNEL: 18900 (15 MHz)
- ▣ REFERENCE VOLTAGE: 3.85 VDC
- ▣ DEVIATION LIMIT: Emission must remain in band

Voltage (%)	Power (VDC)	Temp. (°C)	Frequency (Hz)	Frequency Error (Hz)	Deviation (%)	ppm
100%	3.85	+20(Ref)	1879 999 994	0.0	0.000 000	0.000
100%		-30	1879 999 988	-6.0	0.000 000	-0.003
100%		-20	1879 999 986	-7.4	0.000 000	-0.004
100%		-10	1879 999 990	-3.4	0.000 000	-0.002
100%		0	1879 999 989	-4.4	0.000 000	-0.002
100%		+10	1879 999 987	-7.0	0.000 000	-0.004
100%		+30	1879 999 985	-8.5	0.000 000	-0.005
100%		+40	1879 999 987	-6.4	0.000 000	-0.003
100%		+50	1879 999 984	-9.7	-0.000 001	-0.005
Batt. Endpoint	3.70	+20	1879 999 984	-10.2	-0.000 001	-0.005

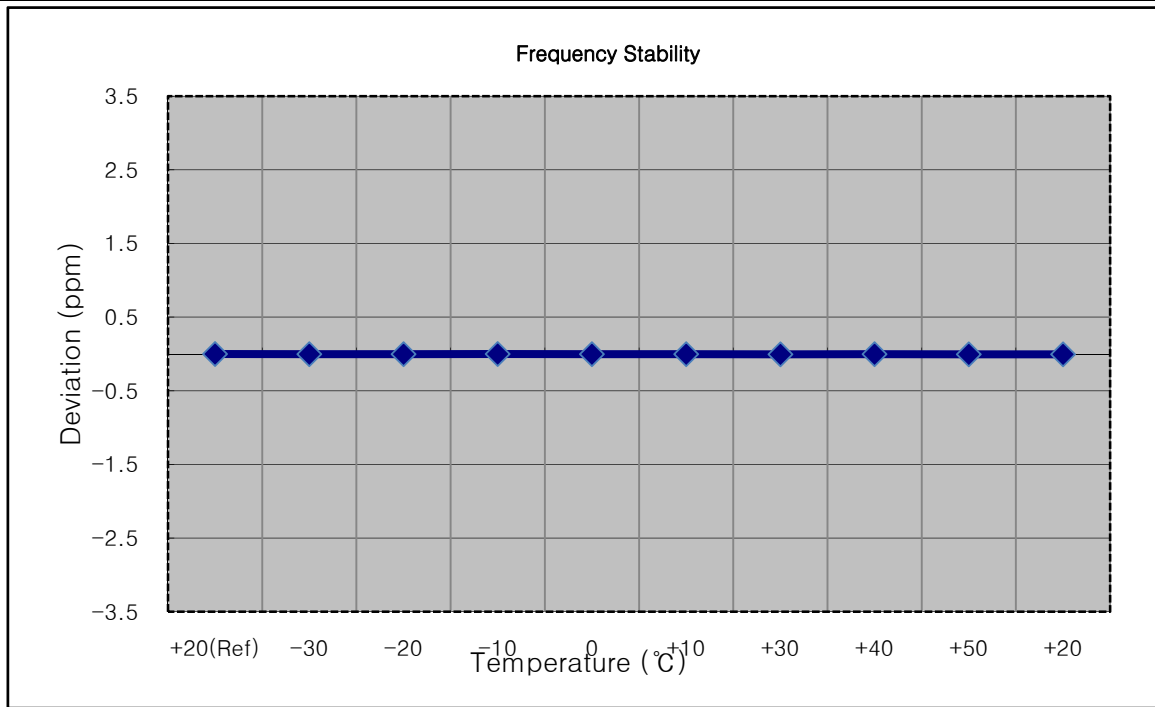

**8.7.6 FREQUENCY STABILITY (20 MHz Band 2 LTE)**

- ▣ OPERATING FREQUENCY: 1880,000,000 Hz
- ▣ CHANNEL: 18900 (20 MHz)
- ▣ REFERENCE VOLTAGE: 3.85 VDC
- ▣ DEVIATION LIMIT: Emission must remain in band

Voltage (%)	Power (VDC)	Temp. (°C)	Frequency (Hz)	Frequency Error (Hz)	Deviation (%)	ppm
100%	3.85	+20(Ref)	1879 999 994	0.0	0.000 000	0.000
100%		-30	1879 999 987	-6.8	0.000 000	-0.004
100%		-20	1879 999 983	-10.6	-0.000 001	-0.006
100%		-10	1879 999 987	-6.8	0.000 000	-0.004
100%		0	1879 999 987	-6.4	0.000 000	-0.003
100%		+10	1879 999 988	-5.5	0.000 000	-0.003
100%		+30	1879 999 985	-8.5	0.000 000	-0.005
100%		+40	1879 999 986	-8.2	0.000 000	-0.004
100%		+50	1879 999 984	-9.8	-0.000 001	-0.005
Batt. Endpoint	3.70	+20	1879 999 986	-8.1	0.000 000	-0.004

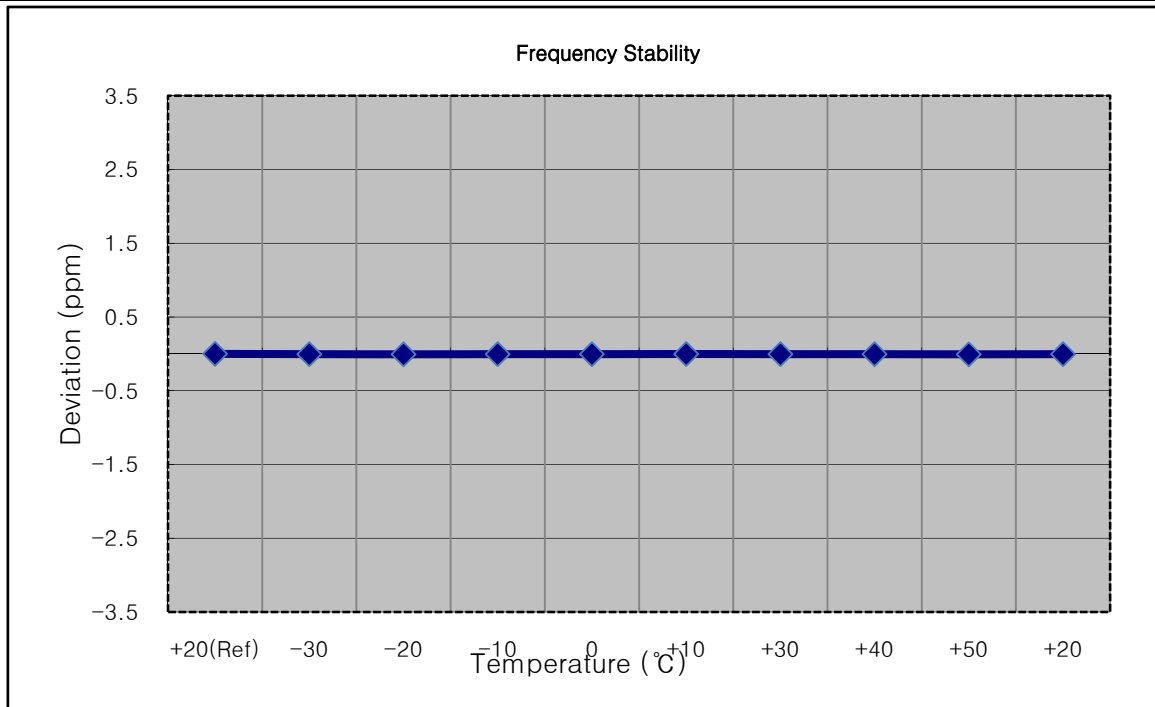

**8.7.7 FREQUENCY STABILITY (1.4 MHz Band 5 LTE)**

- ▣ OPERATING FREQUENCY: 836,500,000 Hz
- ▣ CHANNEL: 20525 (1.4 MHz)
- ▣ REFERENCE VOLTAGE: 3.85 VDC
- ▣ DEVIATION LIMIT: ± 0.000 25 % or 2.5 ppm

Voltage (%)	Power (VDC)	Temp. (°C)	Frequency (Hz)	Frequency Error (Hz)	Deviation (%)	ppm
100%	3.85	+20(Ref)	836 499 994	0.0	0.000 000	0.000
100%		-30	836 499 992	-2.5	0.000 000	-0.003
100%		-20	836 499 991	-2.7	0.000 000	-0.003
100%		-10	836 499 996	2.2	0.000 000	0.003
100%		0	836 499 998	3.5	0.000 000	0.004
100%		+10	836 499 990	-3.7	0.000 000	-0.004
100%		+30	836 499 989	-4.9	-0.000 001	-0.006
100%		+40	836 499 991	-3.1	0.000 000	-0.004
100%		+50	836 499 990	-4.0	0.000 000	-0.005
Batt. Endpoint	3.70	+20	836 499 993	-1.6	0.000 000	-0.002

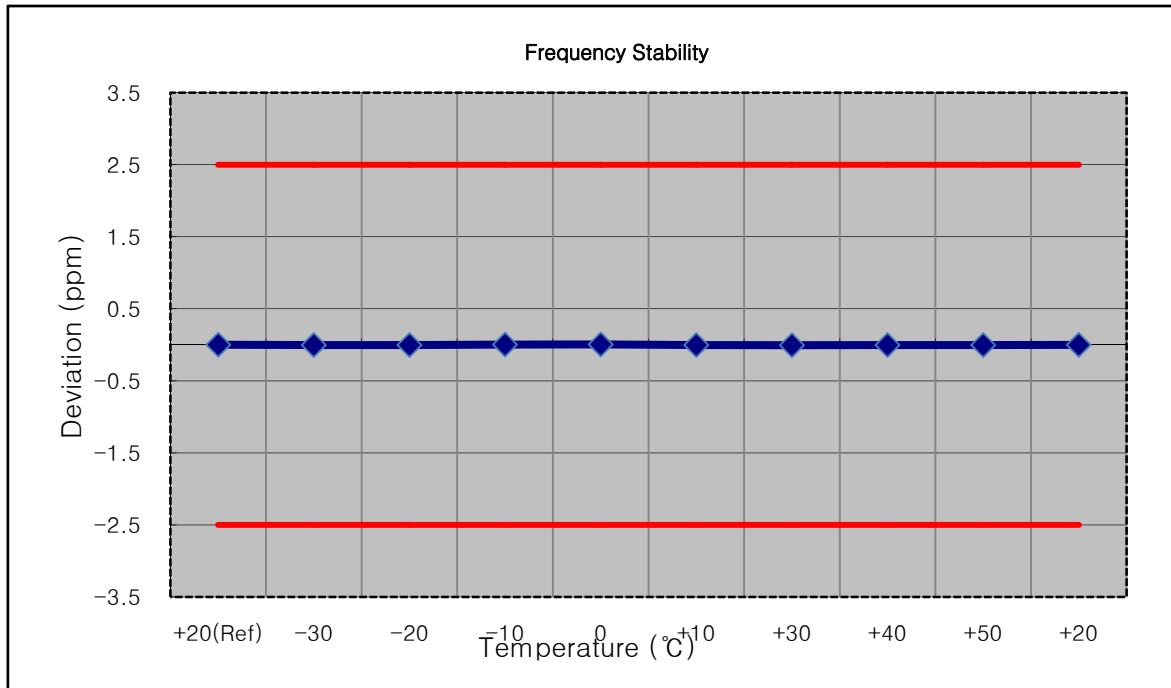

**8.7.8 FREQUENCY STABILITY (3 MHz Band 5 LTE)**

- ▣ OPERATING FREQUENCY: 836,500,000 Hz
- ▣ CHANNEL: 20525 (3 MHz)
- ▣ REFERENCE VOLTAGE: 3.85 VDC
- ▣ DEVIATION LIMIT: ± 0.000 25 % or 2.5 ppm

Voltage (%)	Power (VDC)	Temp. (°C)	Frequency (Hz)	Frequency Error (Hz)	Deviation (%)	ppm
100%	3.85	+20(Ref)	836 499 998	0.0	0.000 000	0.000
100%		-30	836 499 994	-3.5	0.000 000	-0.004
100%		-20	836 500 001	2.9	0.000 000	0.003
100%		-10	836 499 995	-2.9	0.000 000	-0.003
100%		0	836 499 995	-3.2	0.000 000	-0.004
100%		+10	836 499 993	-5.1	-0.000 001	-0.006
100%		+30	836 499 994	-3.7	0.000 000	-0.004
100%		+40	836 499 994	-3.9	0.000 000	-0.005
100%		+50	836 499 995	-2.6	0.000 000	-0.003
Batt. Endpoint	3.70	+20	836 499 993	-4.6	-0.000 001	-0.005

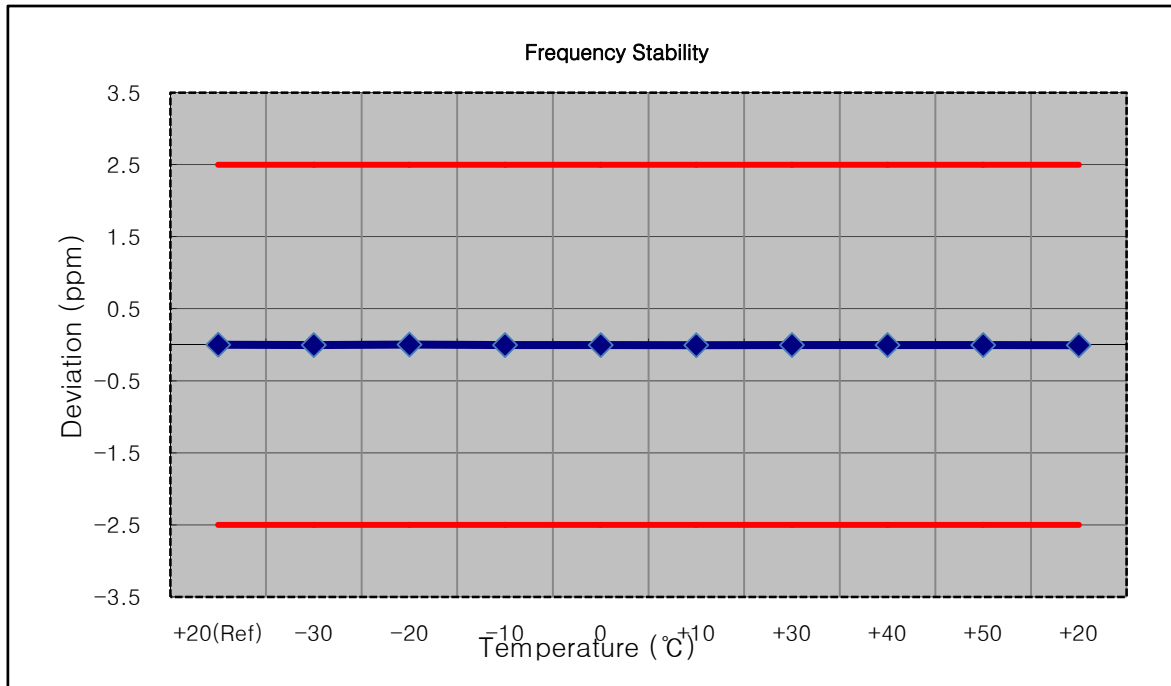

**8.7.9 FREQUENCY STABILITY (5 MHz Band 5 LTE)**

- ▣ OPERATING FREQUENCY: 836,500,000 Hz
- ▣ CHANNEL: 20525 (5 MHz)
- ▣ REFERENCE VOLTAGE: 3.85 VDC
- ▣ DEVIATION LIMIT: ± 0.000 25 % or 2.5 ppm

Voltage (%)	Power (VDC)	Temp. (°C)	Frequency (Hz)	Frequency Error (Hz)	Deviation (%)	ppm
100%	3.85	+20(Ref)	836 499 998	0.0	0.000 000	0.000
100%		-30	836 499 996	-2.8	0.000 000	-0.003
100%		-20	836 499 993	-5.0	-0.000 001	-0.006
100%		-10	836 500 000	1.2	0.000 000	0.001
100%		0	836 499 996	-2.4	0.000 000	-0.003
100%		+10	836 499 995	-3.4	0.000 000	-0.004
100%		+30	836 499 996	-2.6	0.000 000	-0.003
100%		+40	836 499 995	-2.9	0.000 000	-0.003
100%		+50	836 499 995	-3.0	0.000 000	-0.004
Batt. Endpoint	3.70	+20	836 499 995	-3.2	0.000 000	-0.004

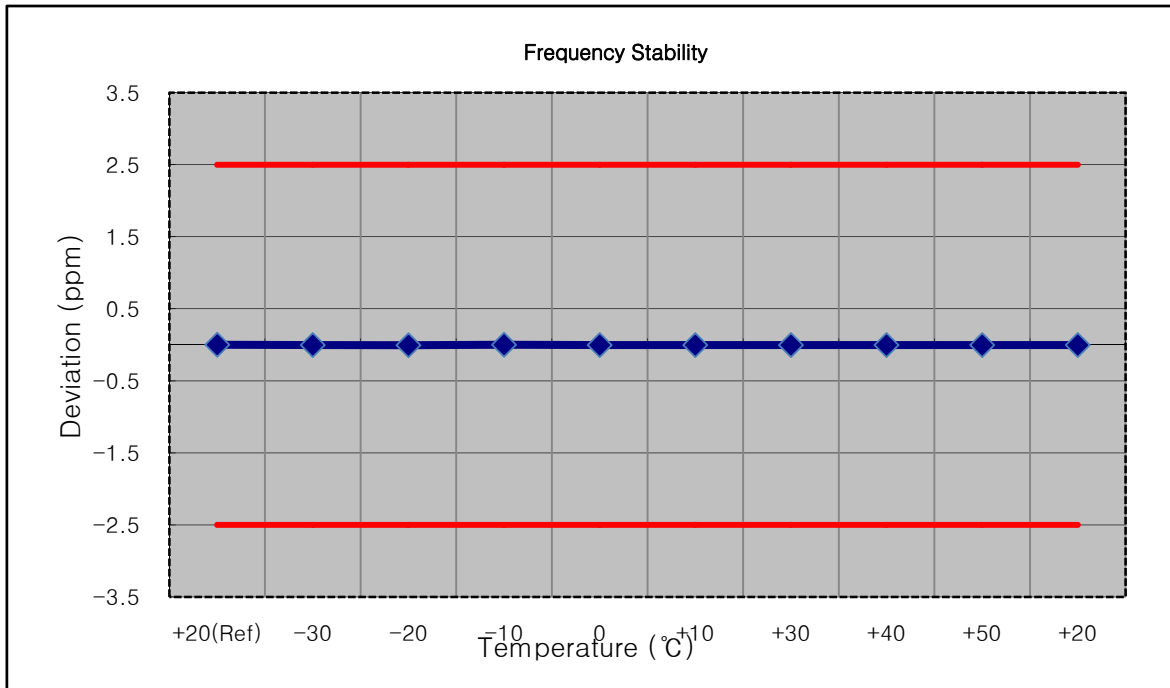



**8.7.10 FREQUENCY STABILITY (10 MHz Band 5 LTE)**

- ▣ OPERATING FREQUENCY: 836,500,000 Hz
- ▣ CHANNEL: 20525 (10 MHz)
- ▣ REFERENCE VOLTAGE: 3.85 VDC
- ▣ DEVIATION LIMIT: ± 0.000 25 % or 2.5 ppm

Voltage (%)	Power (VDC)	Temp. (°C)	Frequency (Hz)	Frequency Error (Hz)	Deviation (%)	ppm
100%	3.85	+20(Ref)	836 499 999	0.0	0.000 000	0.000
100%		-30	836 499 997	-2.2	0.000 000	-0.003
100%		-20	836 499 995	-3.6	0.000 000	-0.004
100%		-10	836 499 996	-2.6	0.000 000	-0.003
100%		0	836 500 001	2.6	0.000 000	0.003
100%		+10	836 499 997	-1.9	0.000 000	-0.002
100%		+30	836 499 995	-3.3	0.000 000	-0.004
100%		+40	836 499 996	-2.3	0.000 000	-0.003
100%		+50	836 499 996	-3.0	0.000 000	-0.004
Batt. Endpoint		3.70	+20	836 499 996	-2.9	0.000 000

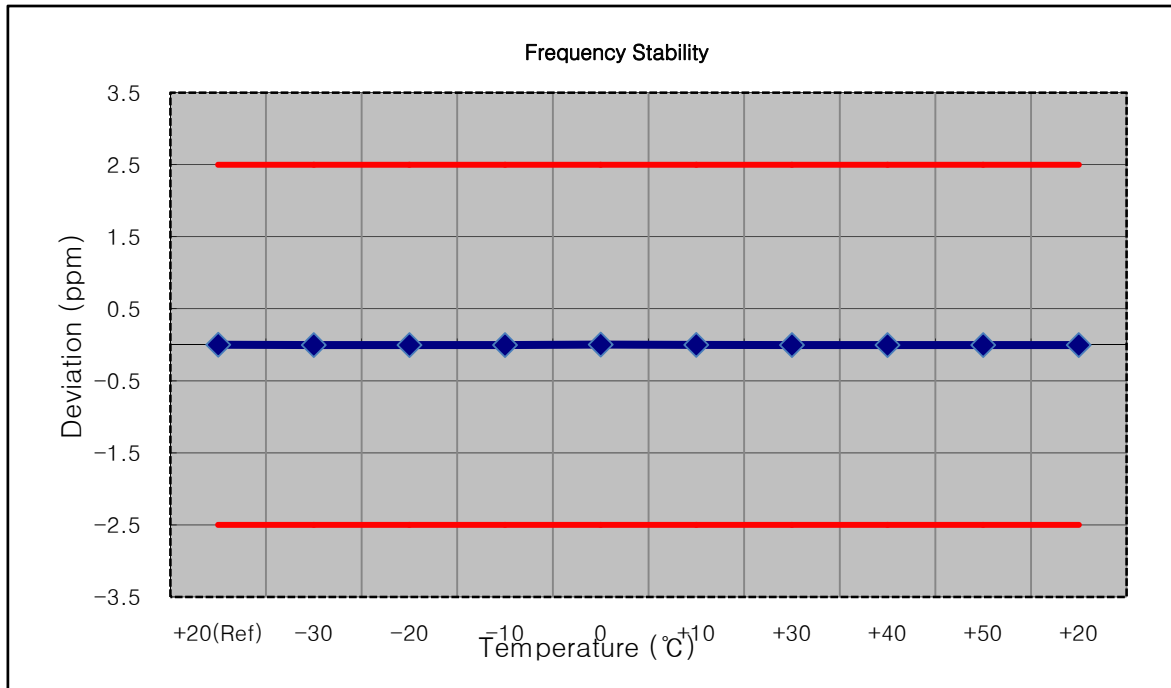

## 8. TEST PLOTS

BAND 2. Occupied Bandwidth Plot (1.4M BW Ch.18900 QPSK RB 6\_0)

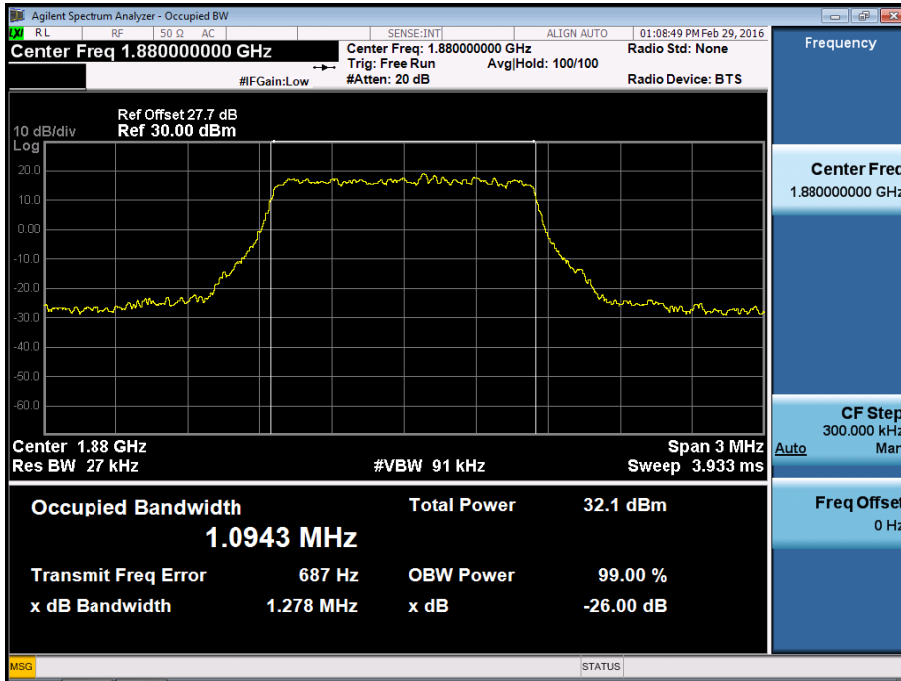

BAND 2. Occupied Bandwidth Plot (1.4M BW Ch.18900 16QAM RB 6\_0)

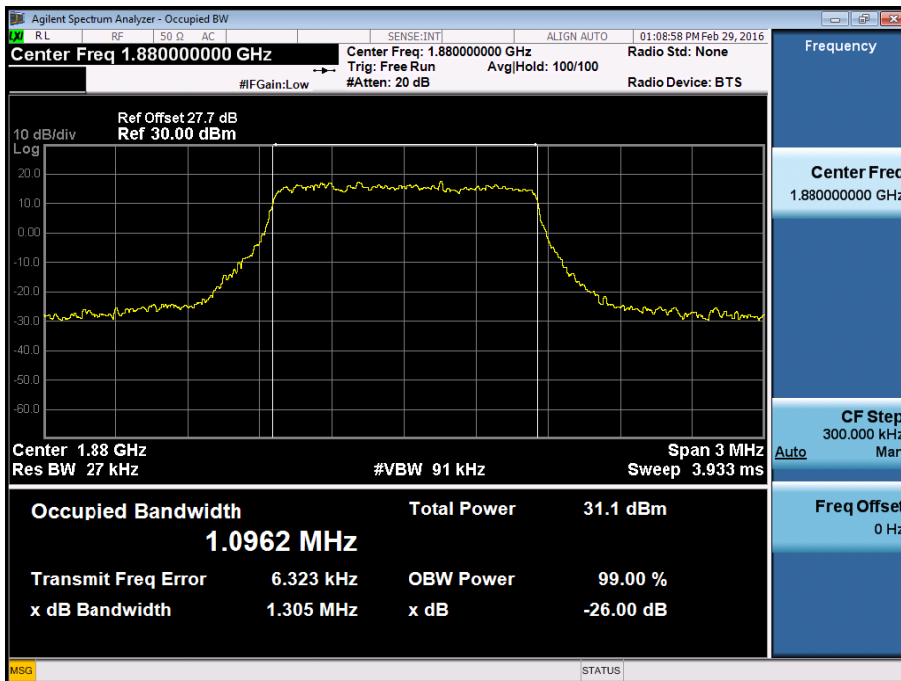

BAND 2. Occupied Bandwidth Plot (3M BW Ch.18900 QPSK RB 15\_0)

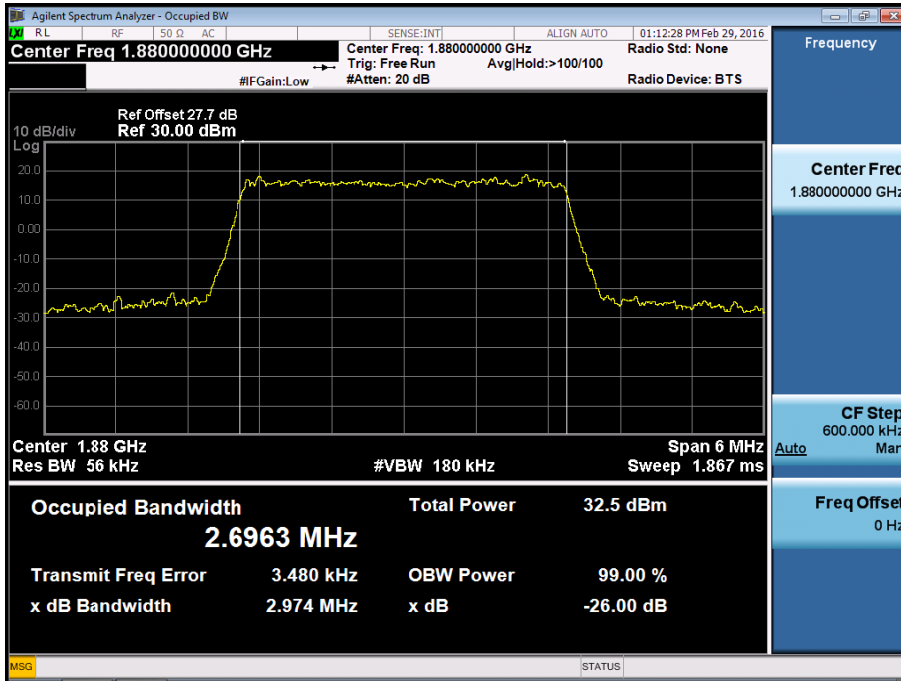

BAND 2. Occupied Bandwidth Plot (3M BW Ch.18900 16QAM RB 15\_0)

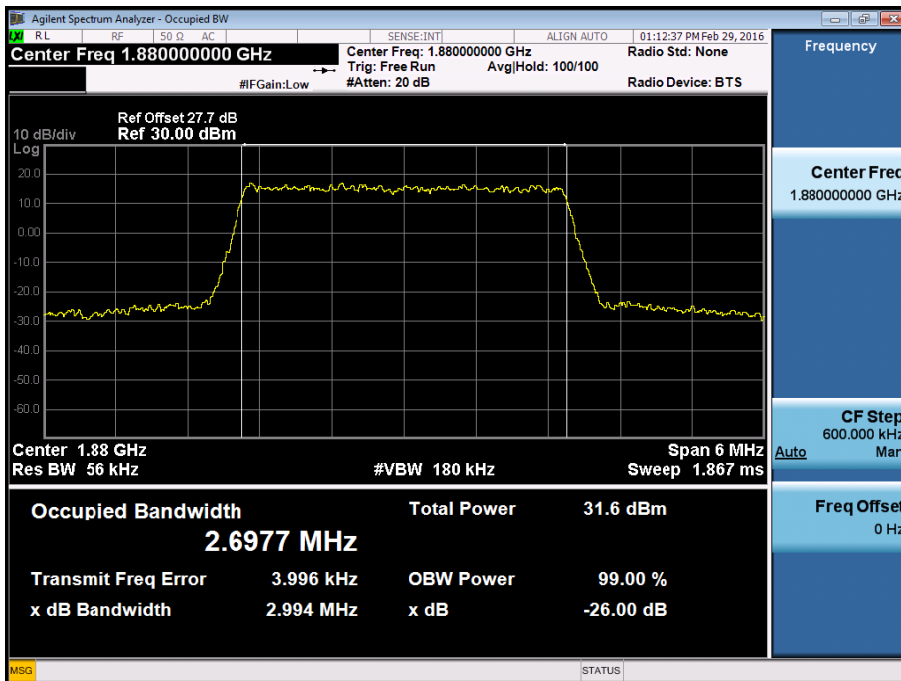

BAND 2. Occupied Bandwidth Plot (5M BW Ch.18900 QPSK RB 25\_0)

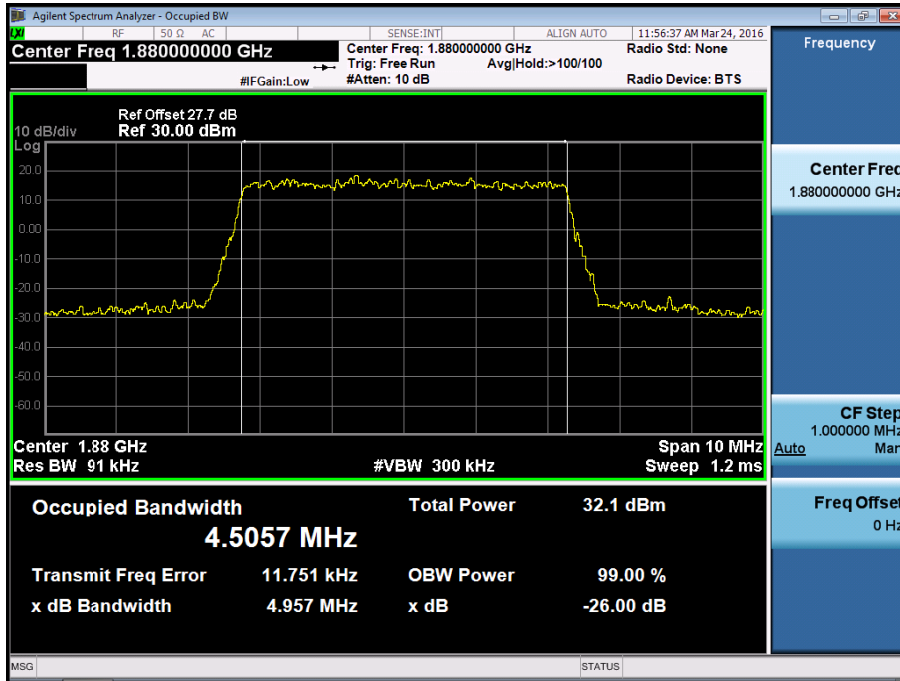

BAND 2. Occupied Bandwidth Plot (5M BW Ch.18900 16QAM RB 25\_0)

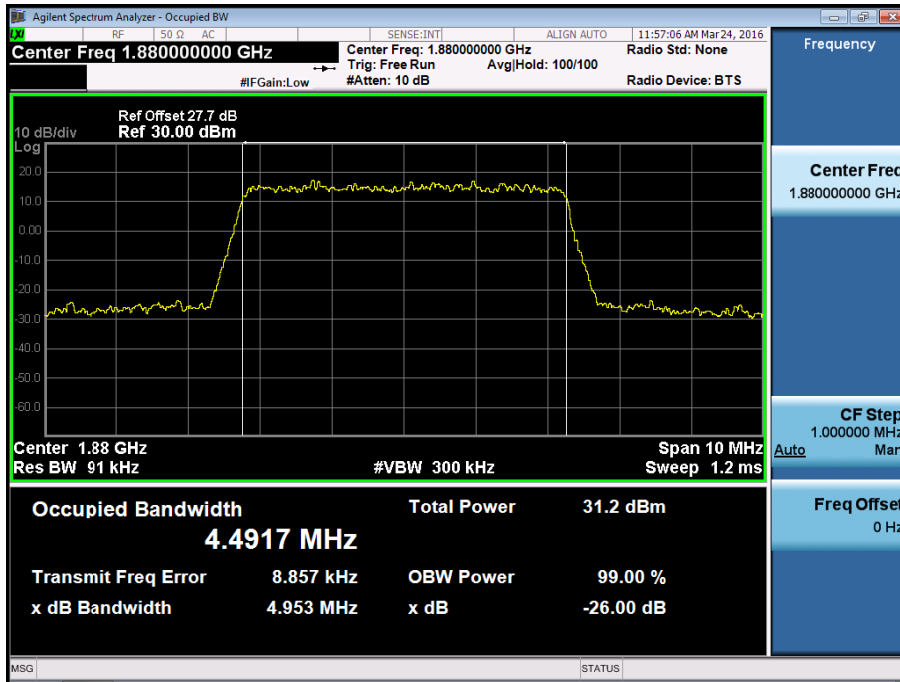

BAND 2. Occupied Bandwidth Plot (10M BW Ch.18900 QPSK RB 50\_0)

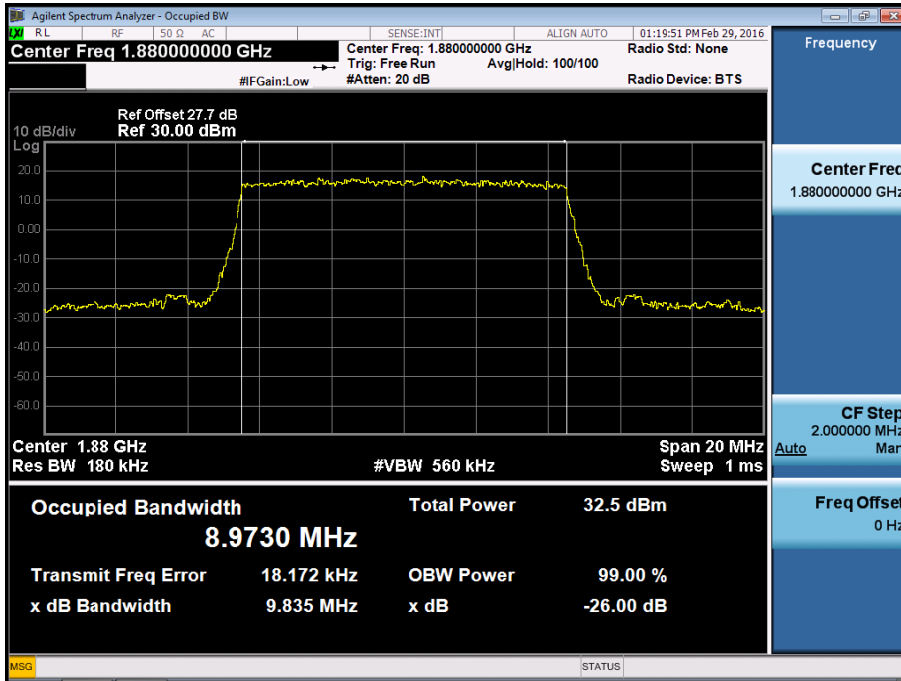

BAND 2. Occupied Bandwidth Plot (10M BW Ch.18900 16QAM RB 50\_0)

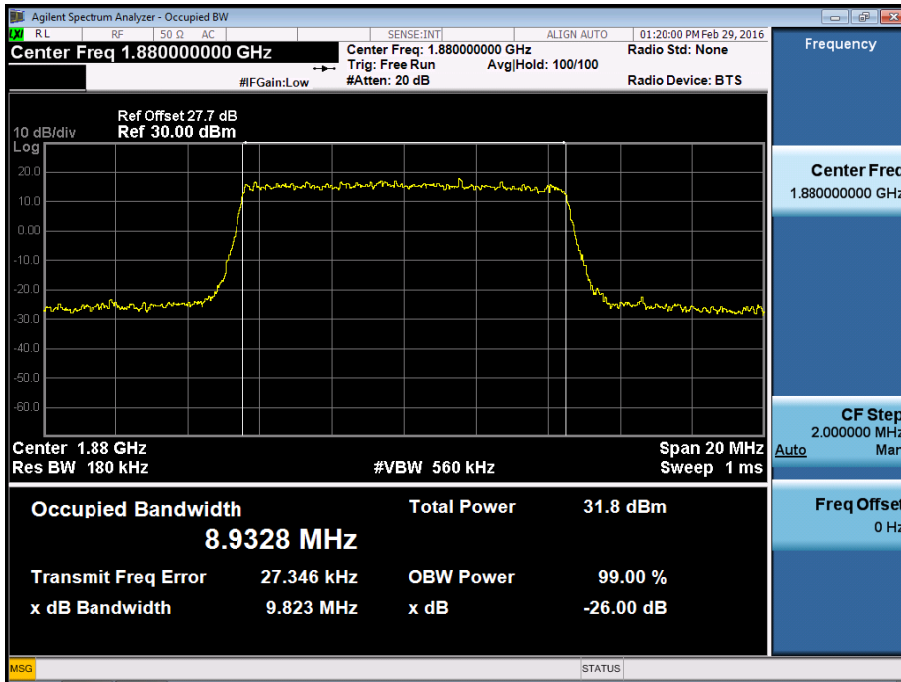

BAND 2. Occupied Bandwidth Plot (15M BW Ch.18900 QPSK RB 75\_0)

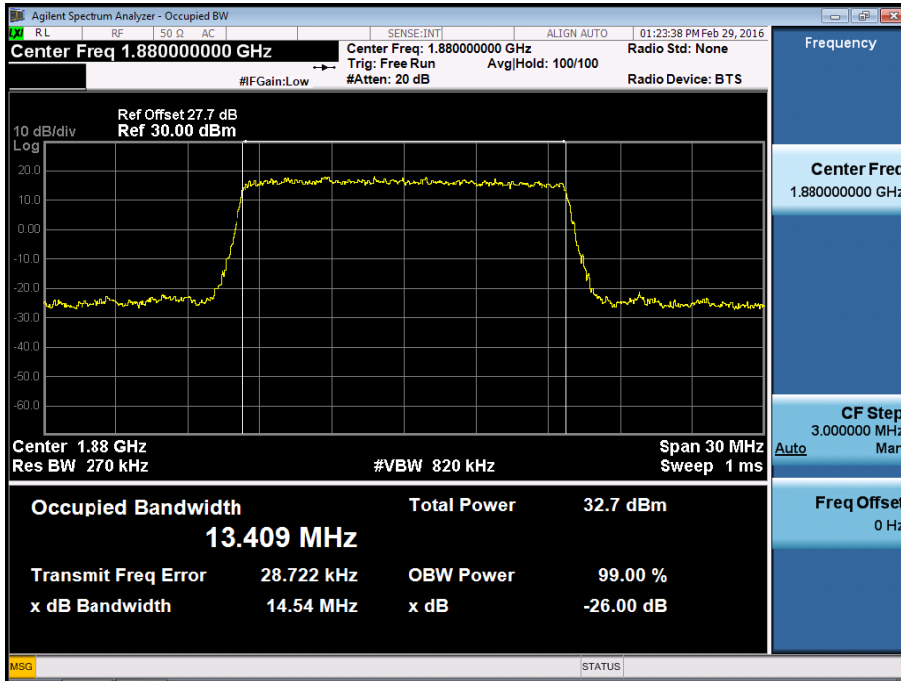

BAND 2. Occupied Bandwidth Plot (15M BW Ch.18900 16QAM RB 75\_0)

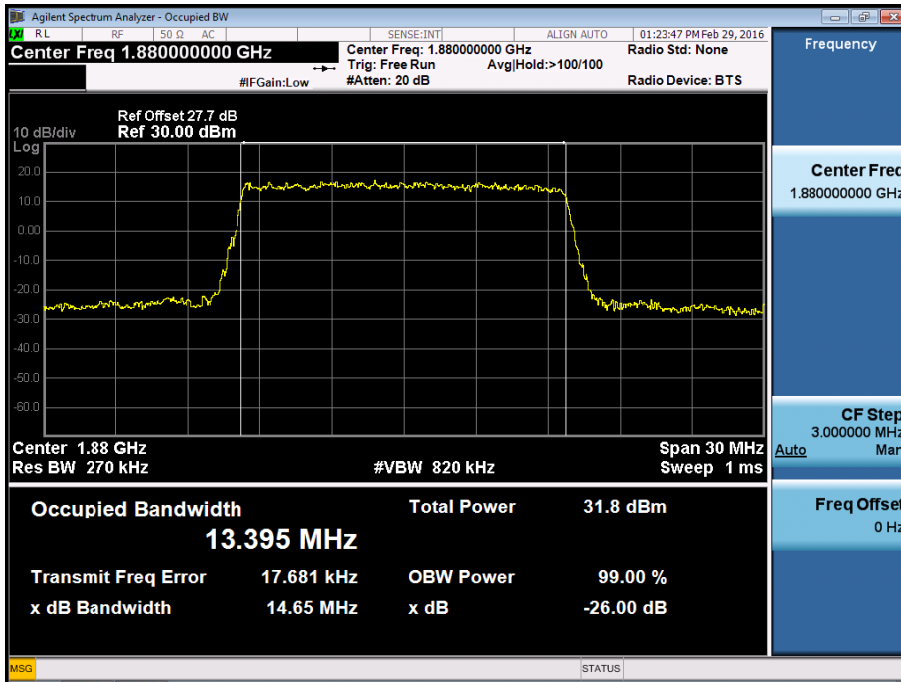

BAND 2. Occupied Bandwidth Plot (20M BW Ch.18900 QPSK RB 100\_0)

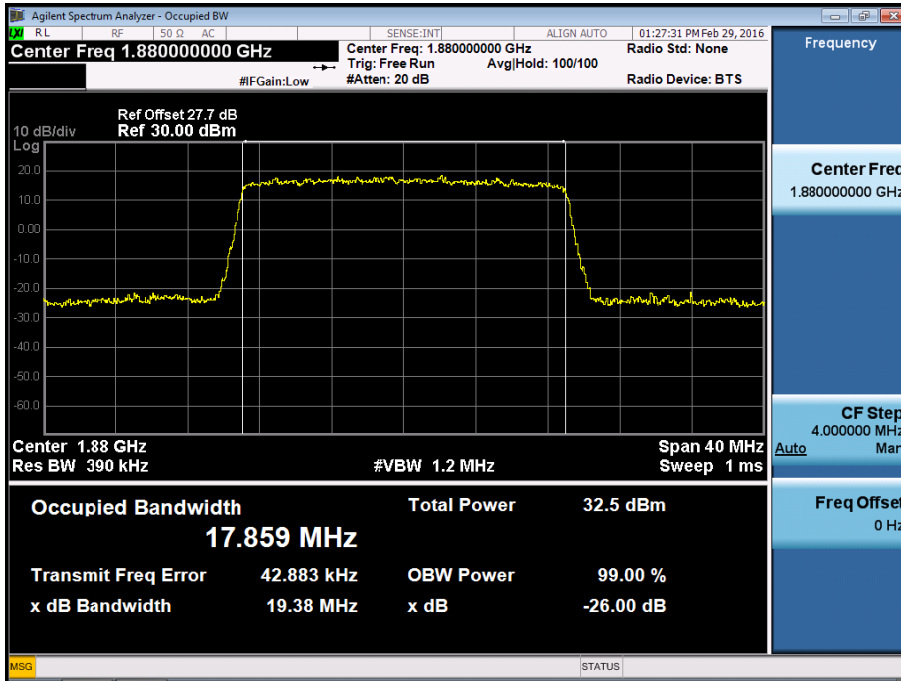

BAND 2. Occupied Bandwidth Plot (20M BW Ch.18900 16QAM RB 100\_0)

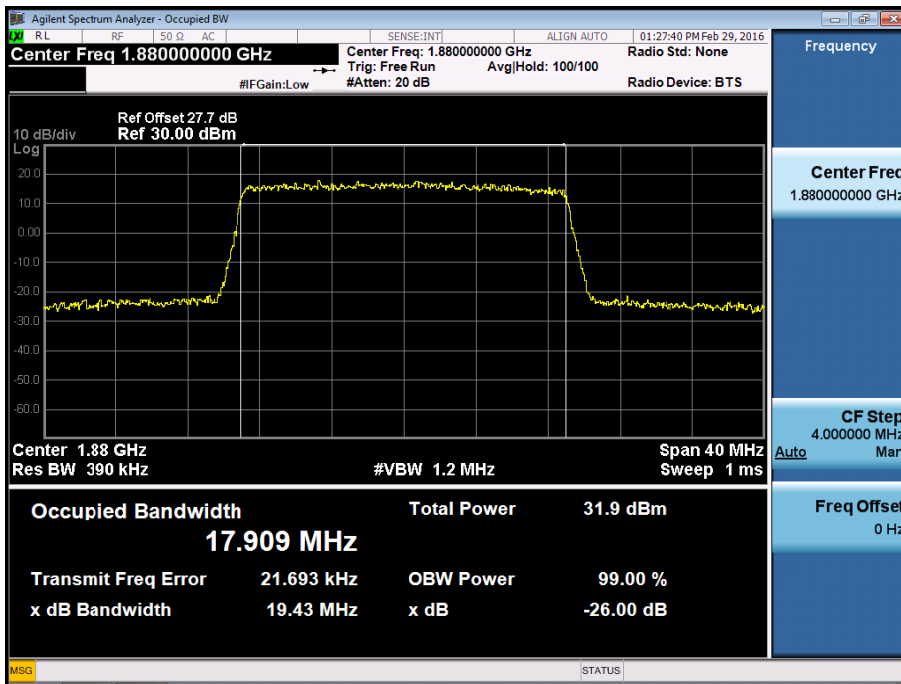



BAND 5. Occupied Bandwidth Plot (1.4M BW Ch.20525 QPSK\_RB6\_0)

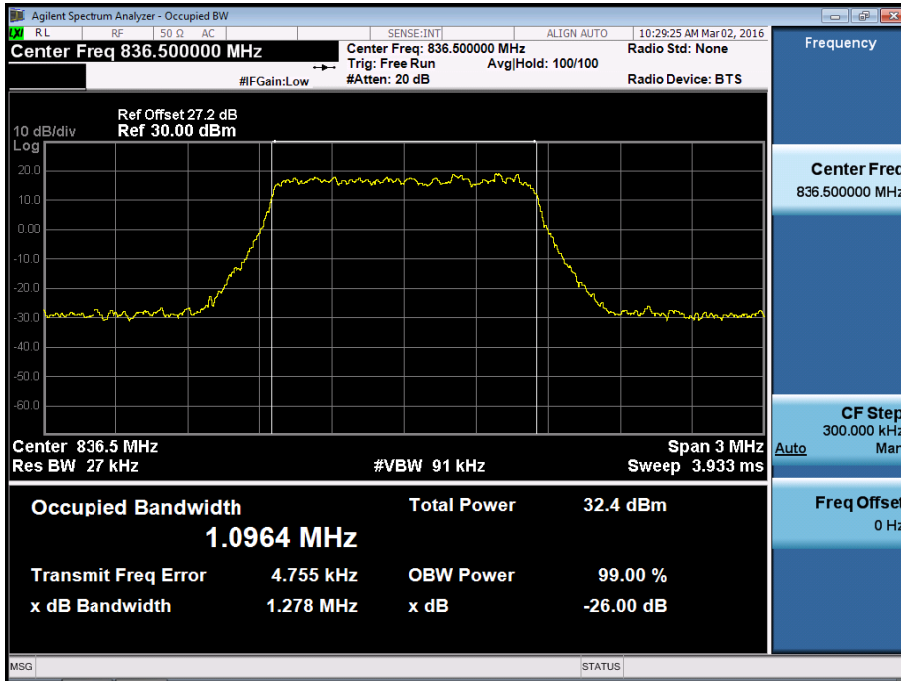

BAND 5. Occupied Bandwidth Plot (1.4M BW Ch.20525 16QAM\_RB6\_0)

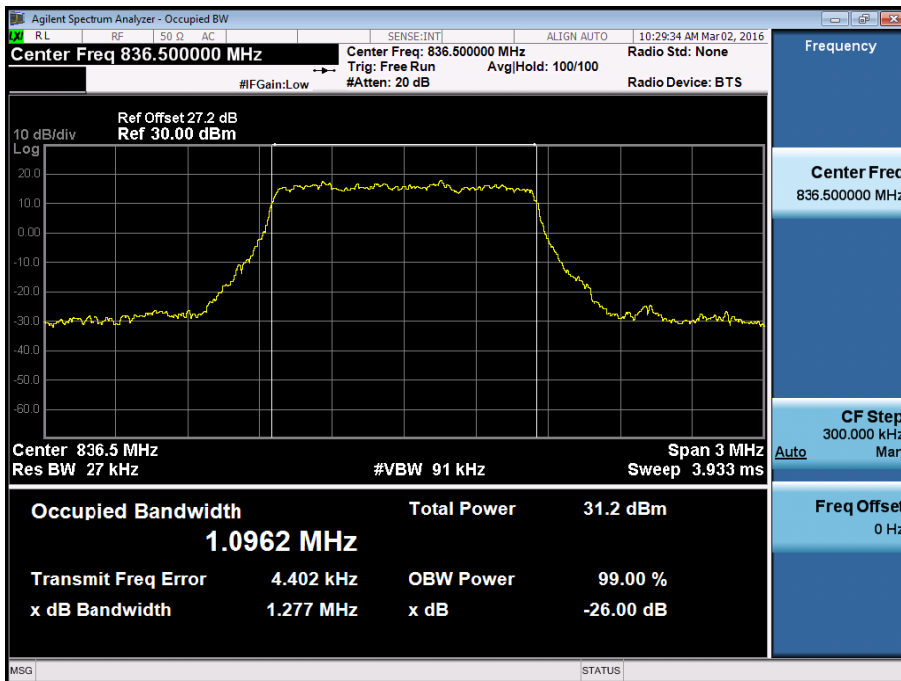

BAND 5. Occupied Bandwidth Plot (3M BW Ch.20525 QPSK\_RB15\_0)

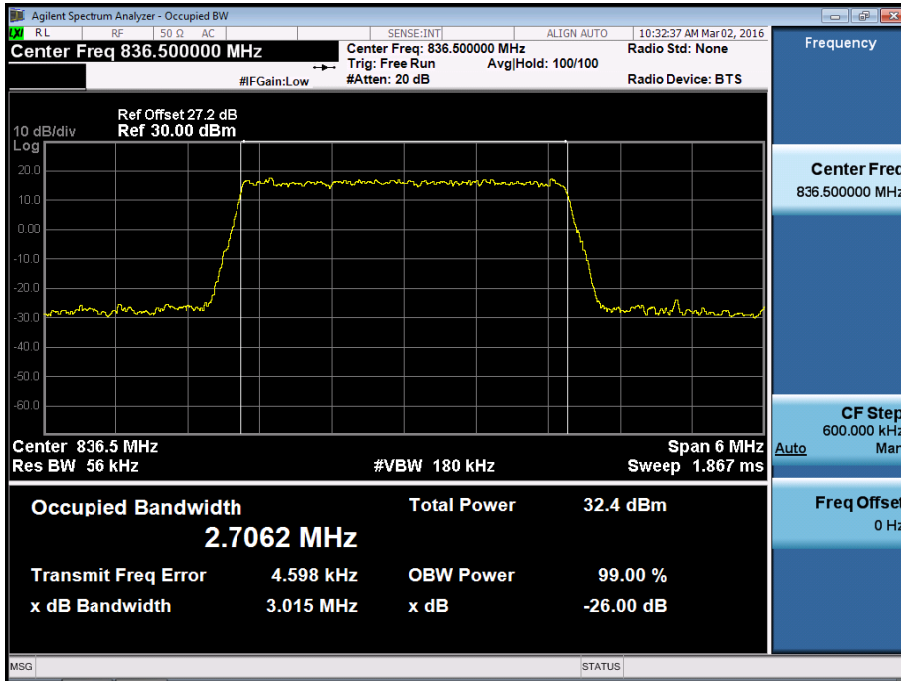

BAND 5. Occupied Bandwidth Plot (3M BW Ch.20525 16QAM\_RB15\_0)

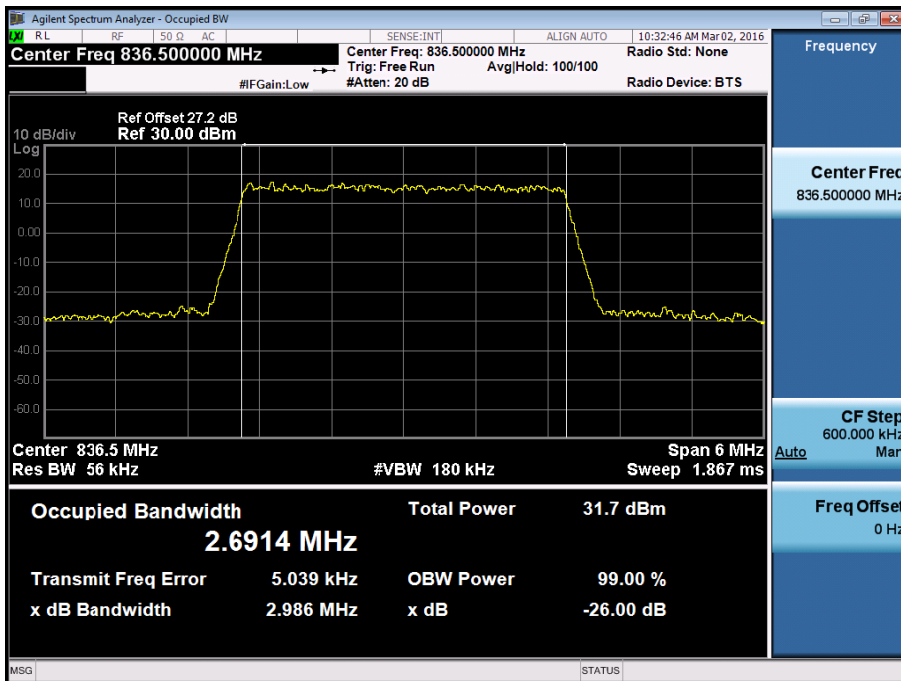

BAND 5. Occupied Bandwidth Plot (5M BW Ch.20525 QPSK\_RB25\_0)

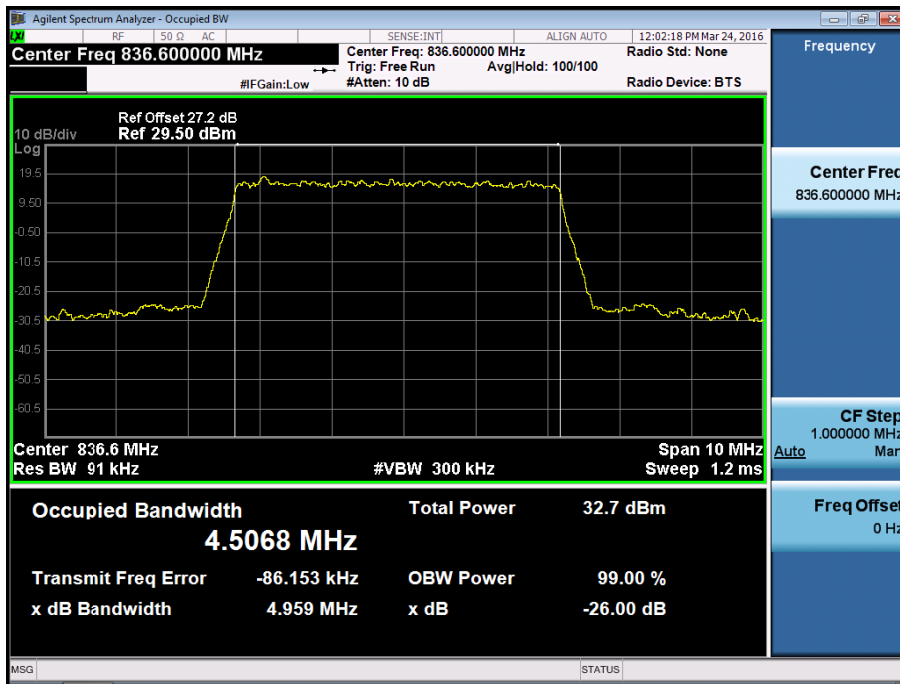

BAND 5. Occupied Bandwidth Plot (5M BW Ch.20525 16QAM\_RB25\_0)

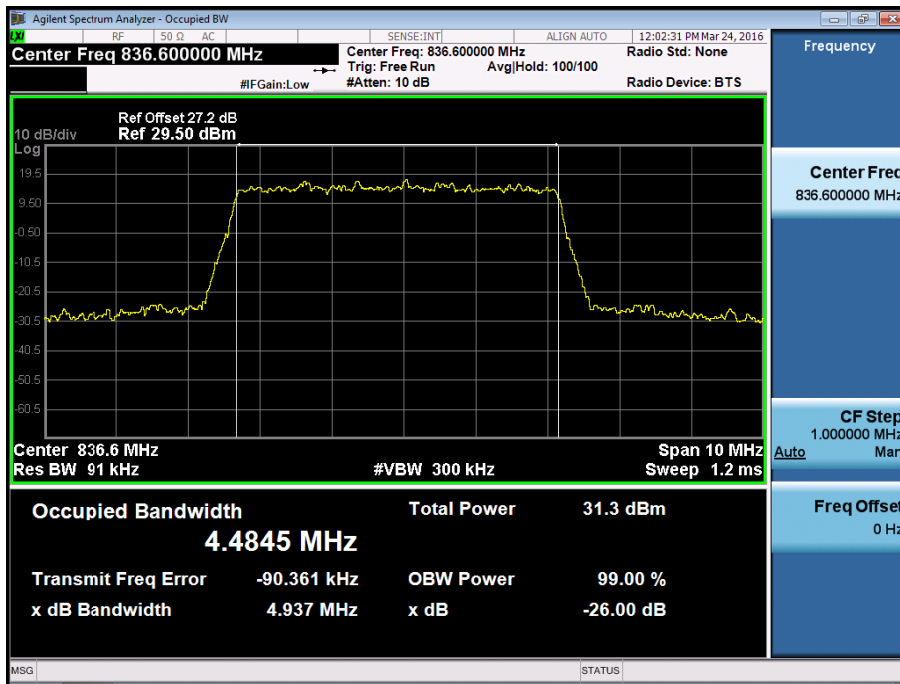

BAND 5. Occupied Bandwidth Plot (10M BW Ch.20525 QPSK\_RB50\_0)

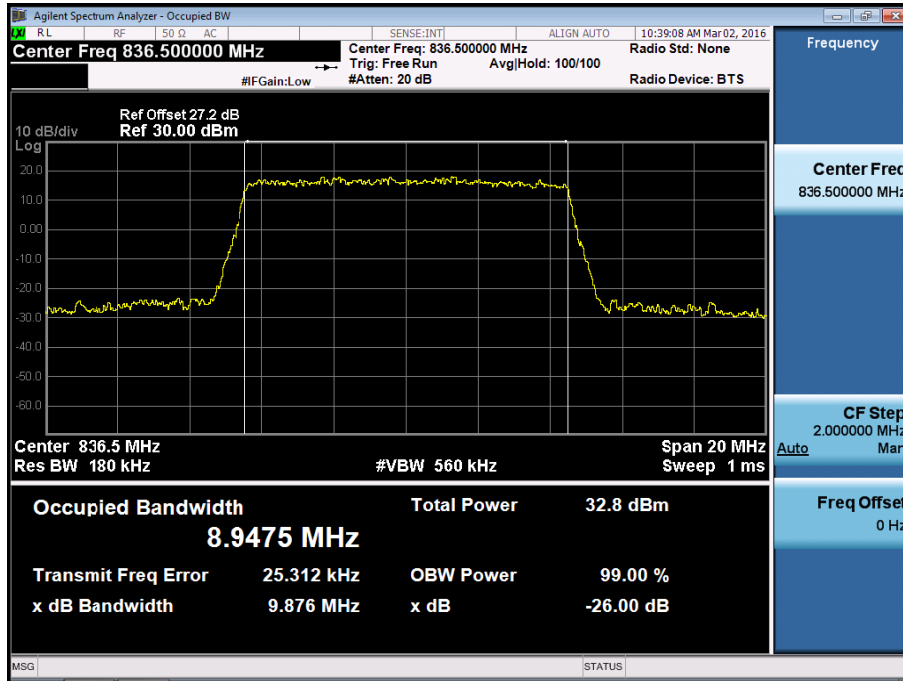

BAND 5. Occupied Bandwidth Plot (10M BW Ch.20525 16QAM\_RB50\_0)

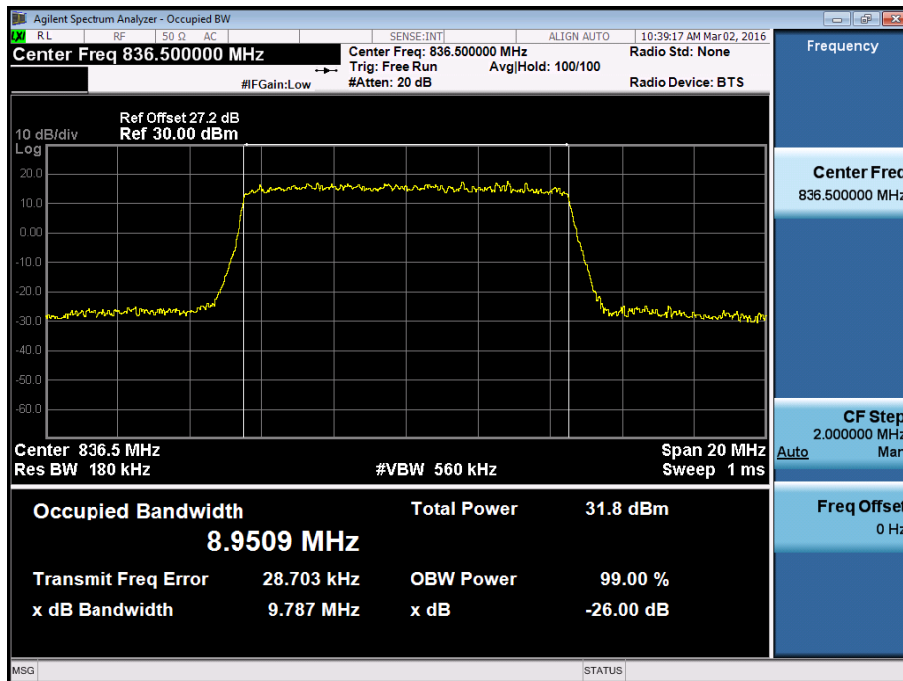

BAND 2. PAR Plot (1.4M BW Ch.18900 QPSK RB 6\_0)

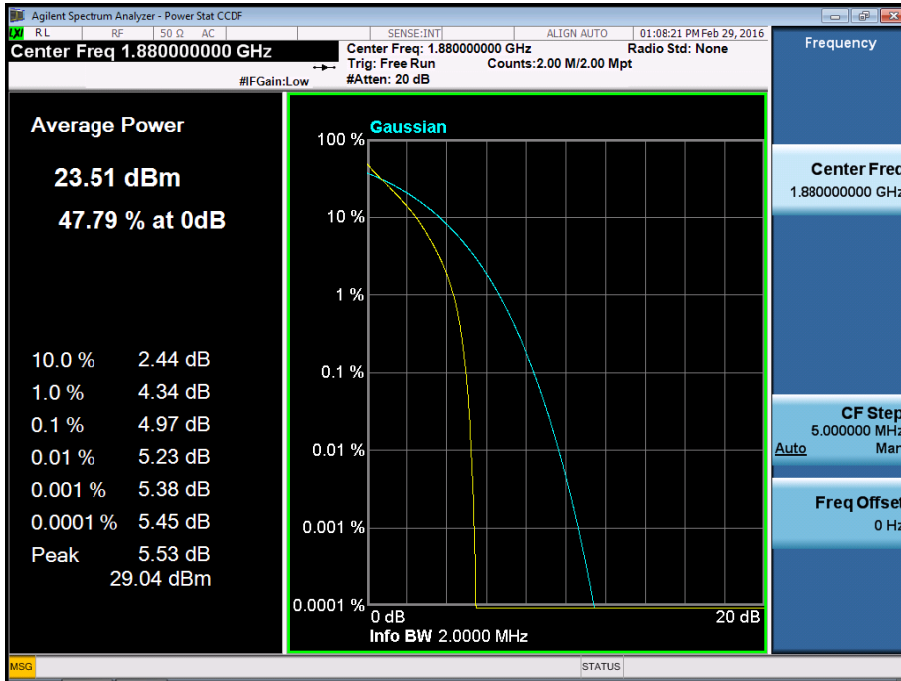

BAND 2. PAR Plot (1.4M BW Ch.18900 16QAM RB 6\_0)

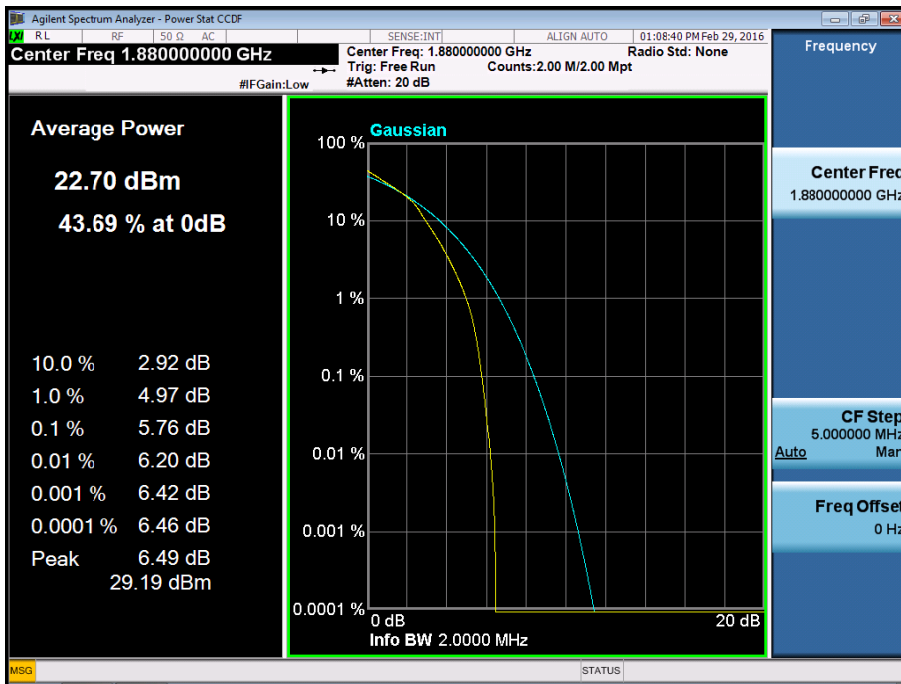

BAND 2. PAR Plot (3M BW Ch.18900 QPSK RB 15\_0)

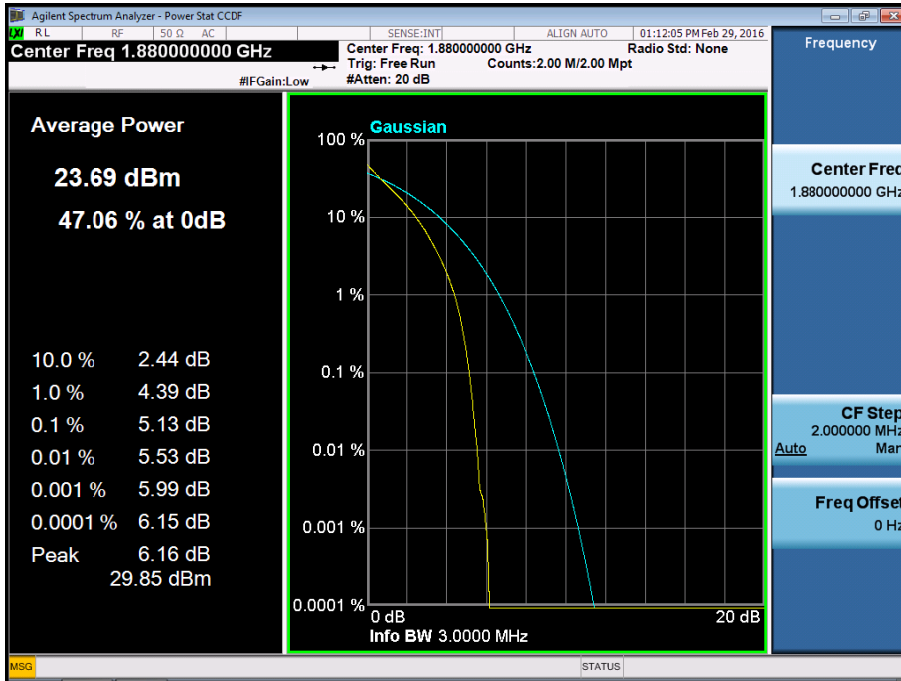

BAND 2. PAR Plot (3M BW Ch.18900 16QAM RB 15\_0)

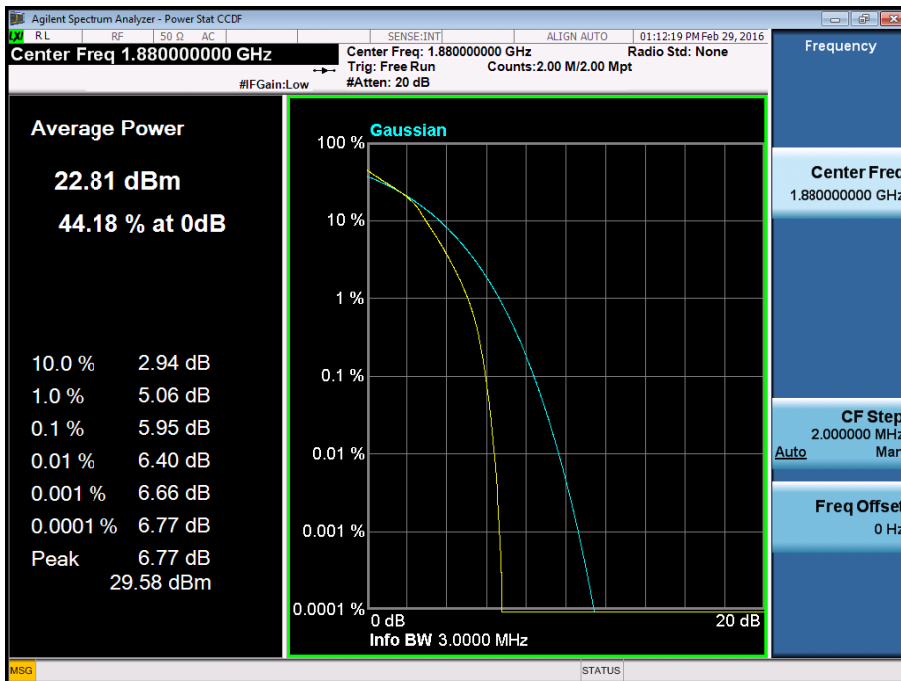

BAND 2. PAR Plot (5M BW Ch.18900 QPSK RB 25\_0)

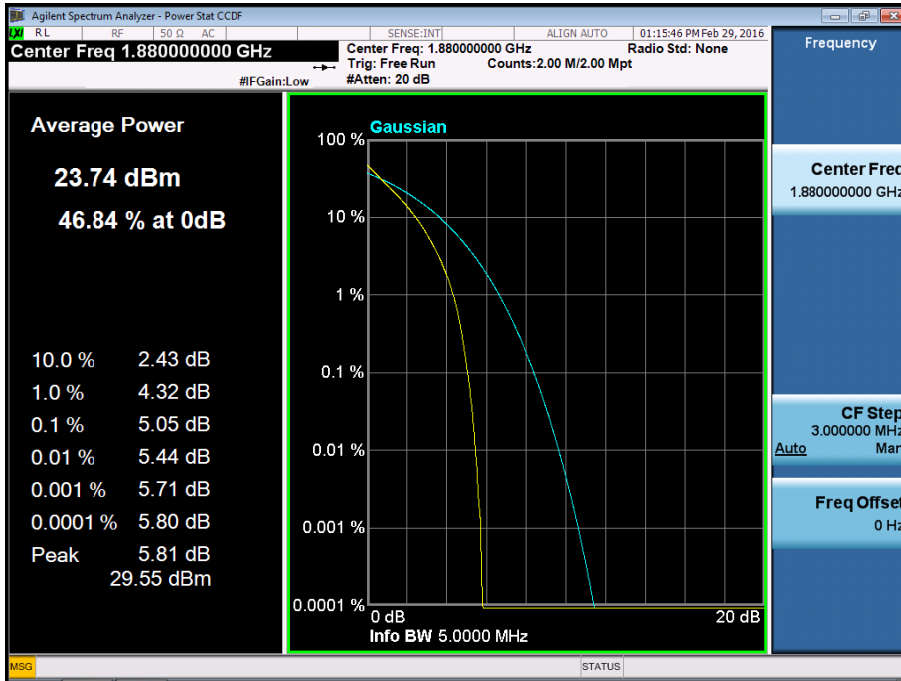

BAND 2. PAR Plot (5M BW Ch.18900 16QAM RB 25\_0)

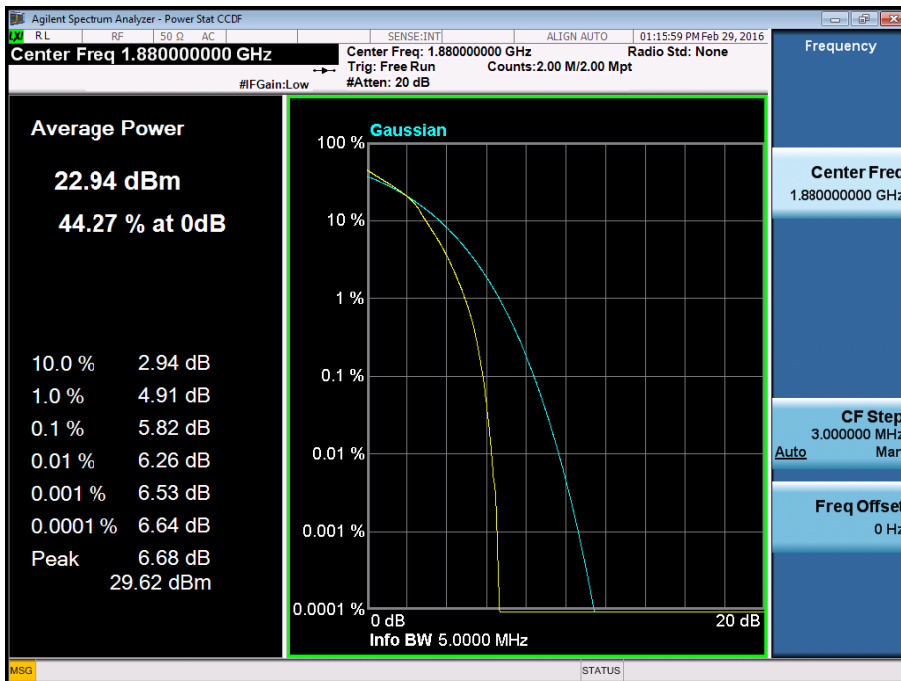

BAND 2. PAR Plot (10M BW Ch.18900 QPSK RB 50\_0)

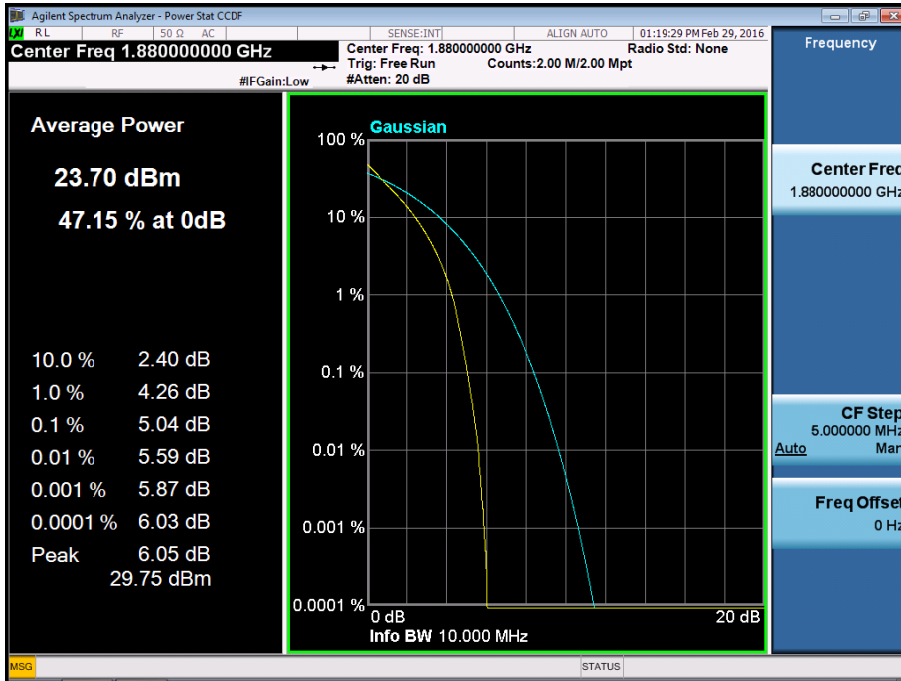

BAND 2. PAR Plot (10M BW Ch.18900 16QAM RB 50\_0)

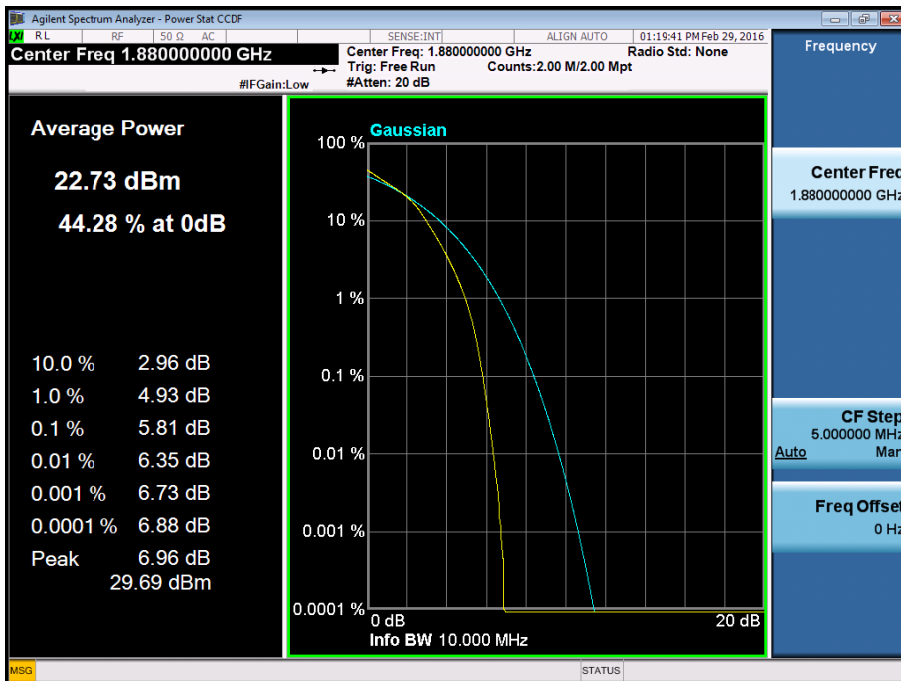



BAND 2. PAR Plot (15M BW Ch.18900 QPSK RB 75\_0)

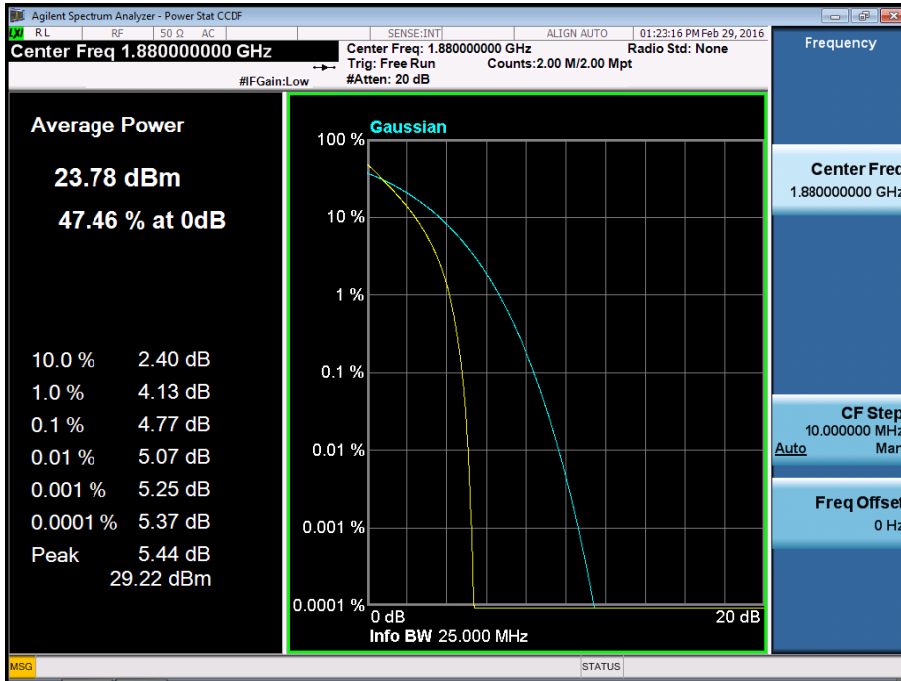

BAND 2. PAR Plot (15M BW Ch.18900 16QAM RB 75\_0)

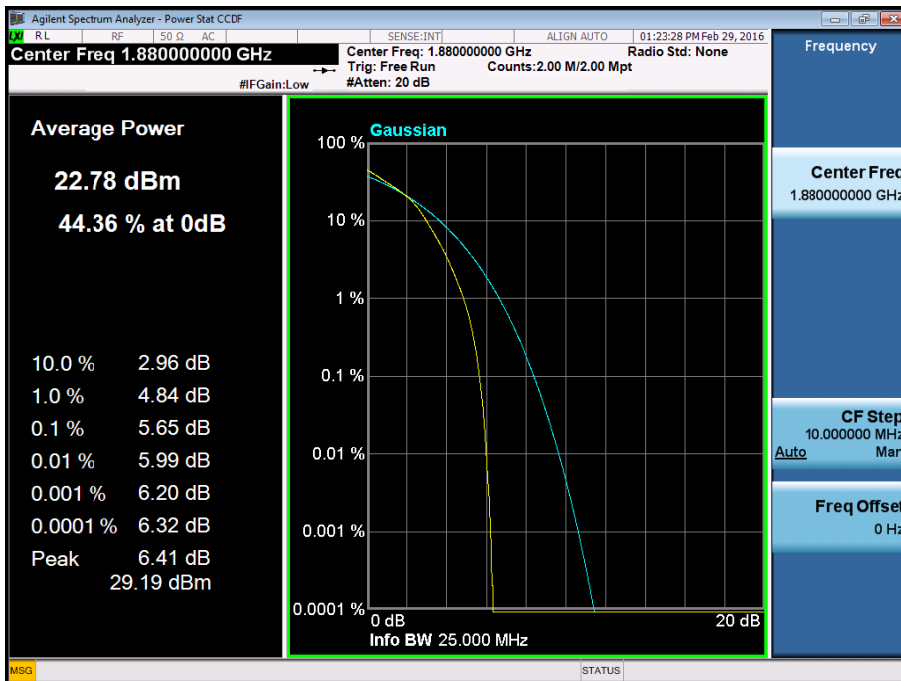

BAND 2. PAR Plot (20M BW Ch.18900 QPSK RB 100\_0)

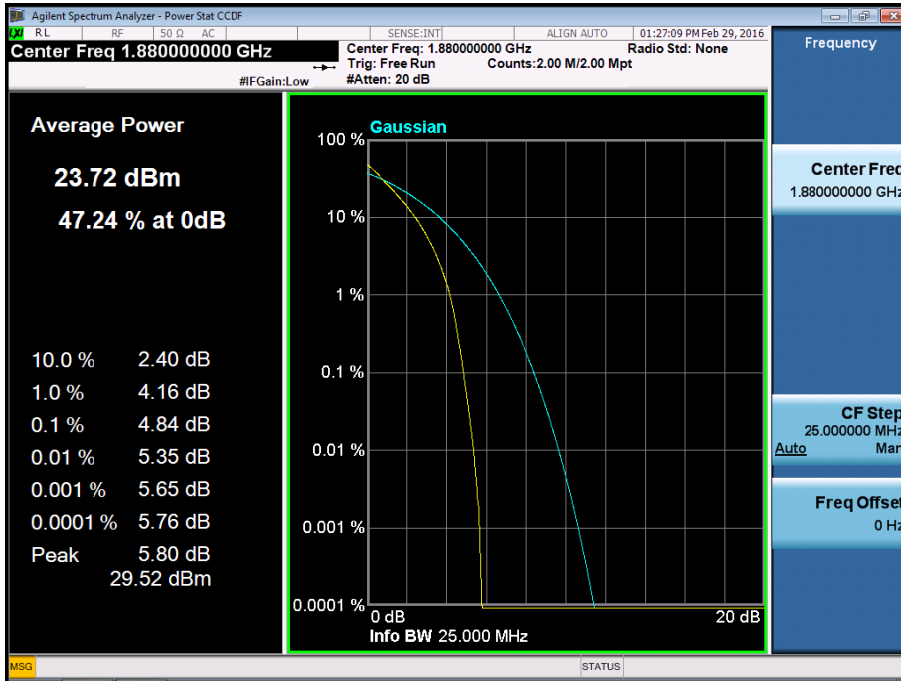

BAND 2. PAR Plot (20M BW Ch.18900 16QAM RB 100\_0)

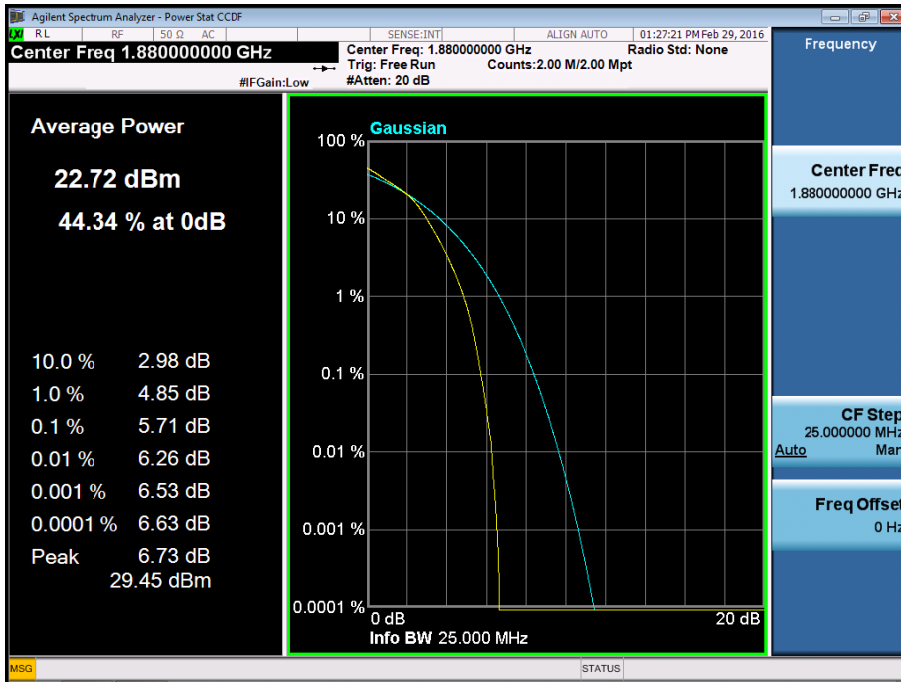

BAND 2. Lower Band Edge Plot (1.4M BW Ch.18607 QPSK\_RB1\_Offset 0) -1

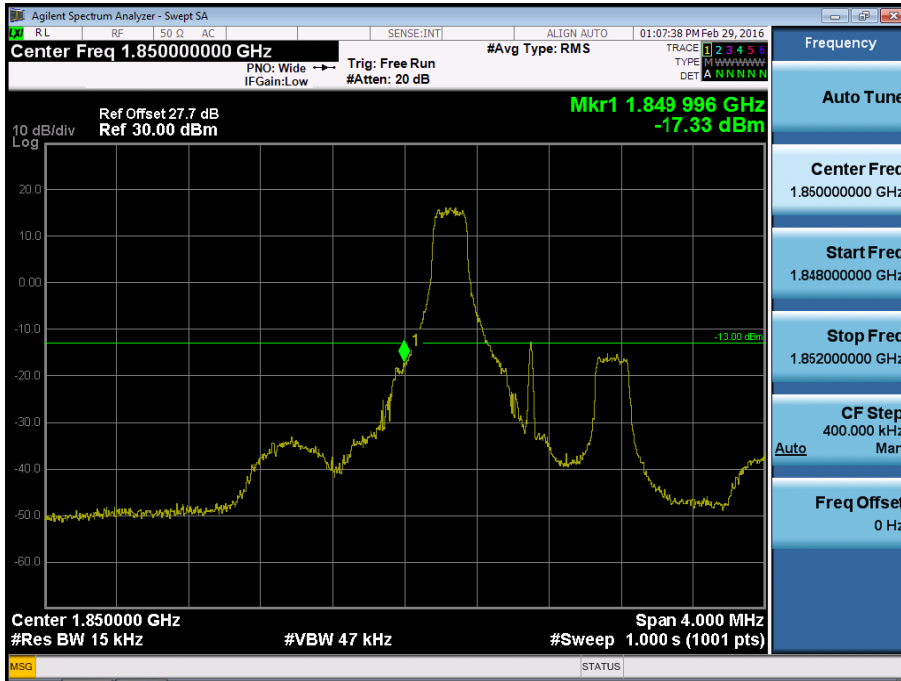

BAND 2. Lower Band Edge Plot (1.4M BW Ch.18607 QPSK\_RB6\_Offset 0) -2

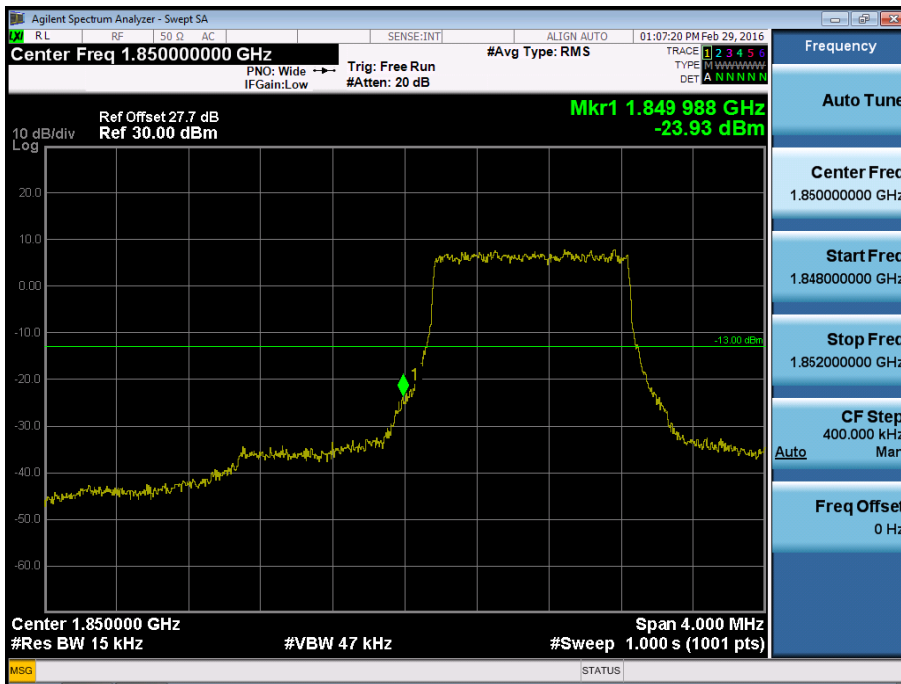

BAND 2. Lower Extended Band Edge Plot (1.4M BW Ch.18607 QPSK\_RB6\_0) -3

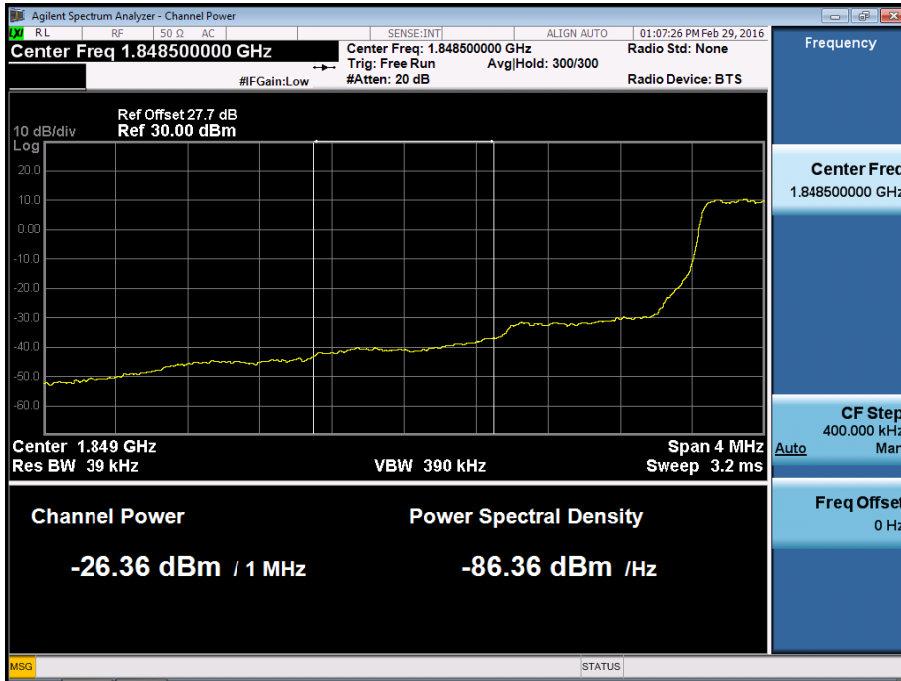

BAND 2. Lower Band Edge Plot (3M BW Ch.18615 QPSK\_RB1\_Offset 0) -1

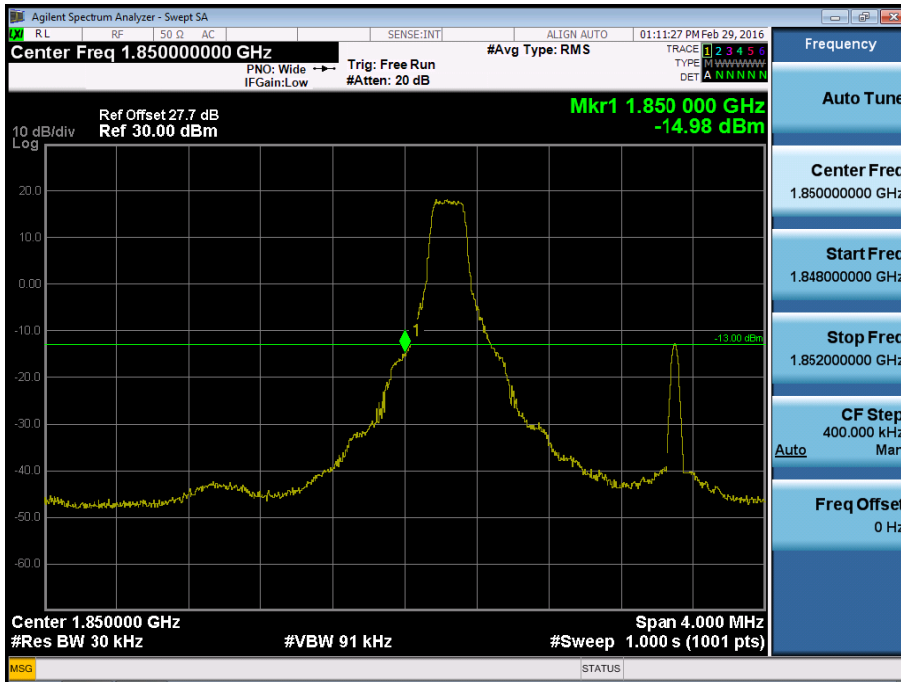

BAND 2. Lower Band Edge Plot (3M BW Ch.18615 QPSK\_RB15\_Offset 0) -2

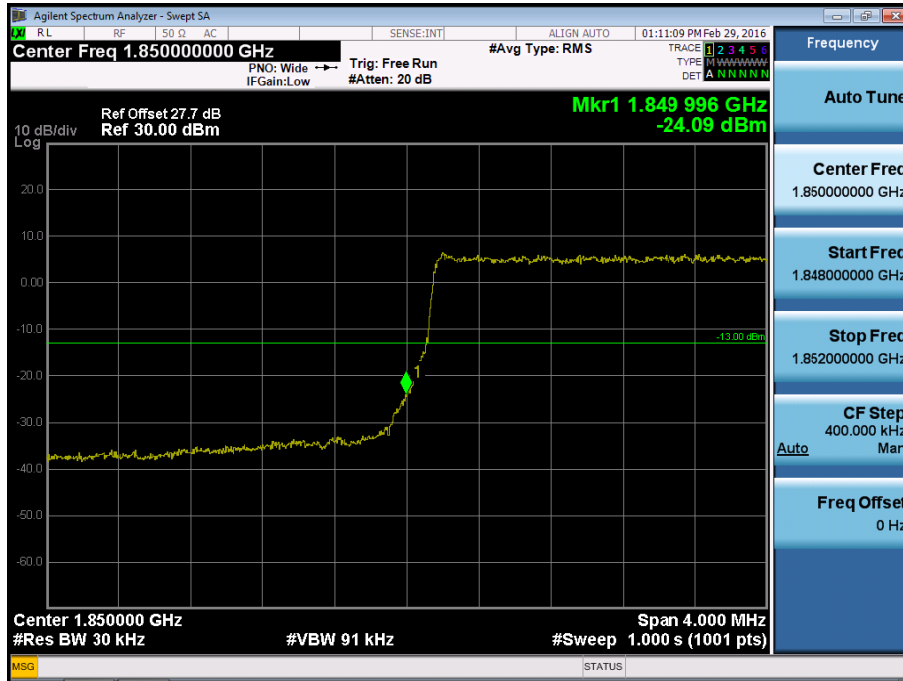

BAND 2. Lower Extended Band Edge Plot (3M BW Ch.18615 QPSK\_RB15\_0) -3

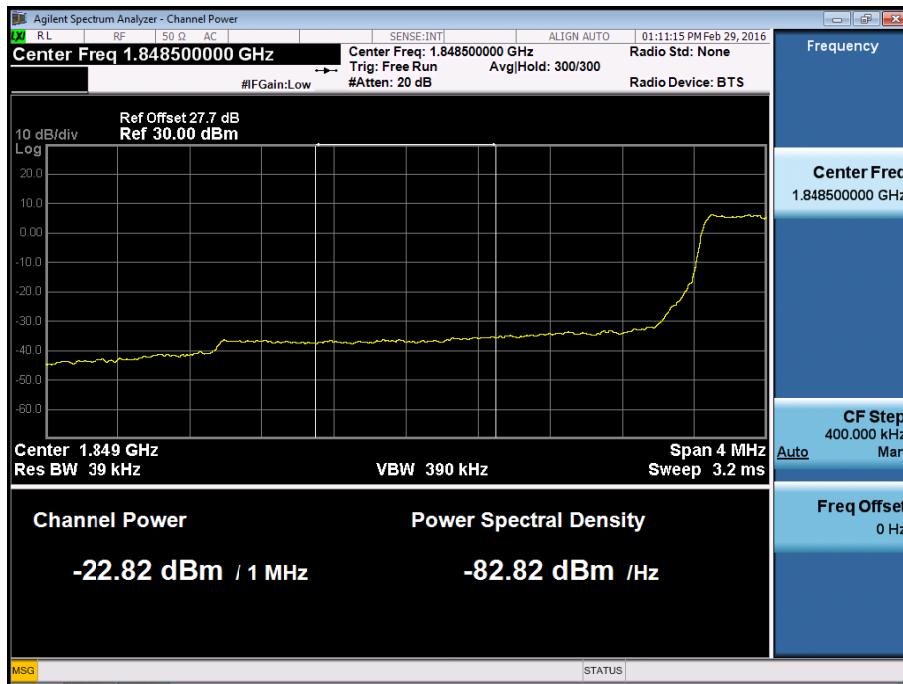

BAND 2. Lower Band Edge Plot (5M BW Ch.18625 QPSK\_RB1\_Offset 0) -1

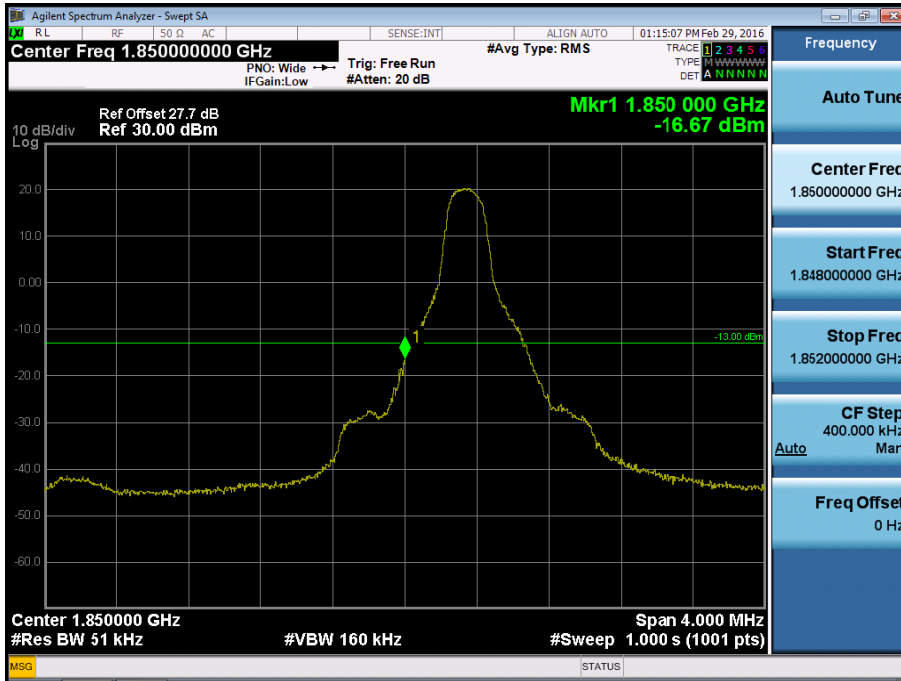

BAND 2. Lower Band Edge Plot (5M BW Ch.18625 QPSK\_RB25\_Offset 0) -2

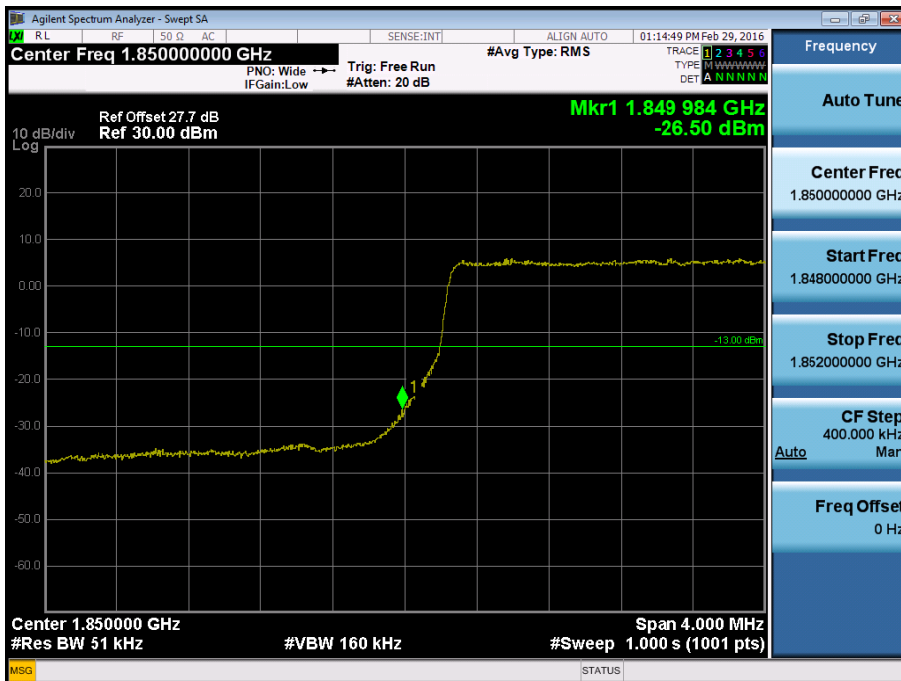

BAND 2. Lower Extended Band Edge Plot (5M BW Ch.18625 QPSK\_RB25\_0) -3

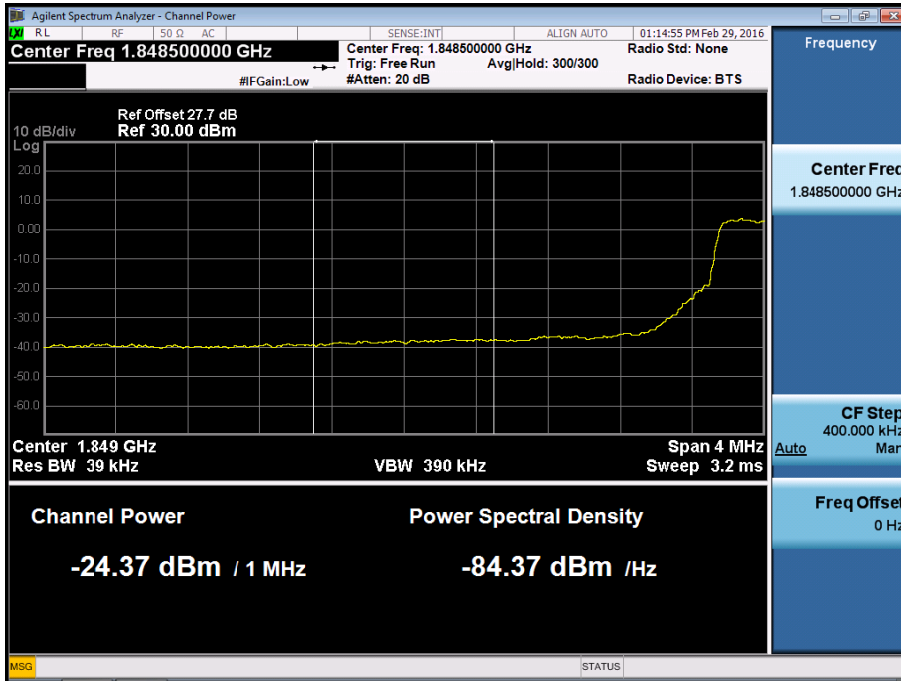

BAND 2. Lower Band Edge Plot (10M BW Ch.18650 QPSK\_RB1\_Offset 0) -1

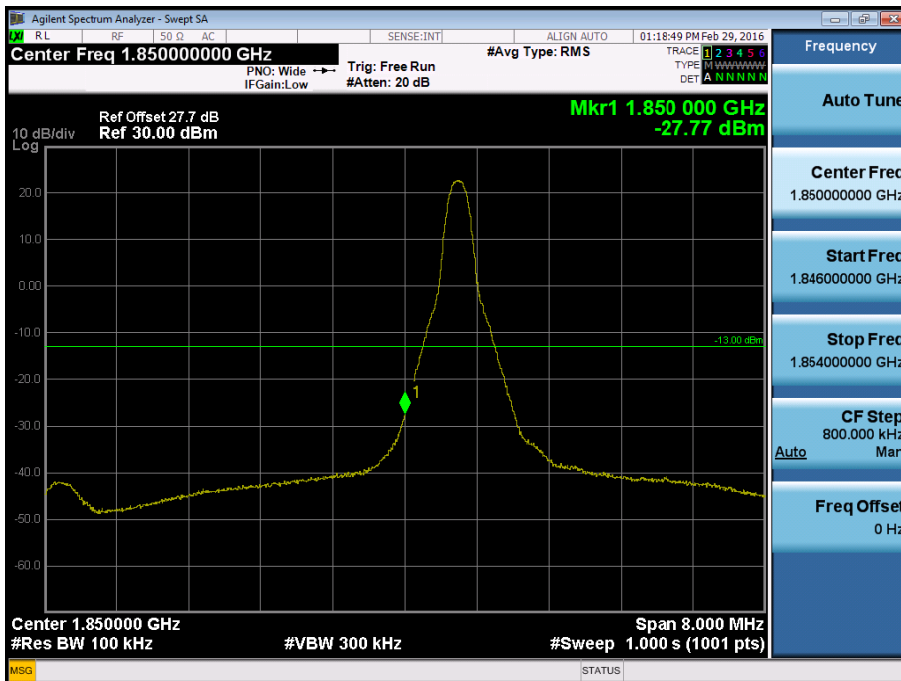

BAND 2. Lower Band Edge Plot (10M BW Ch.18650 QPSK\_RB50\_Offset 0) -2

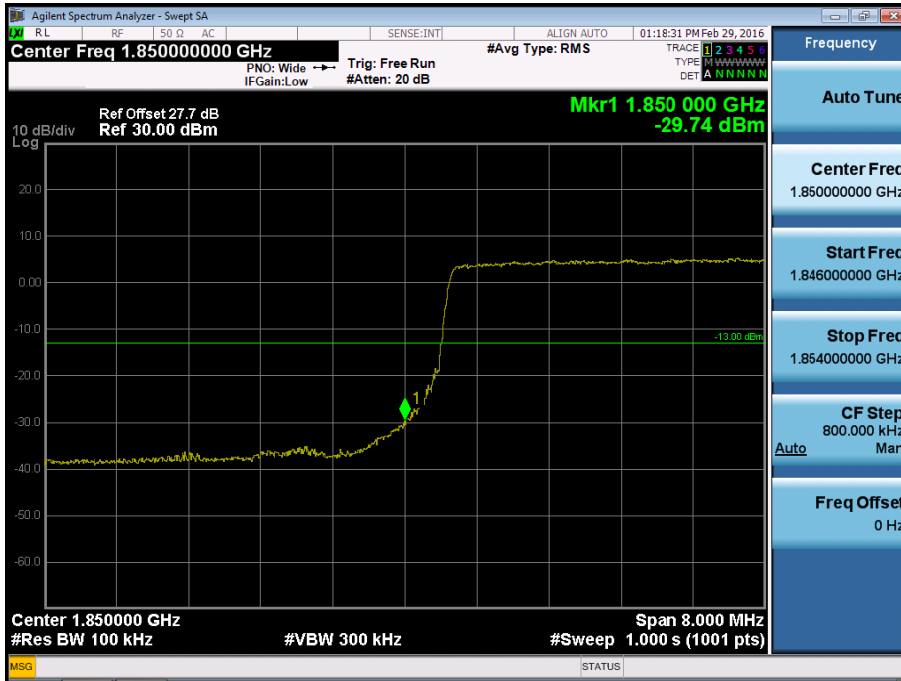

BAND 2. Lower Extended Band Edge Plot (10M BW Ch.18650 QPSK\_RB50\_0) -3

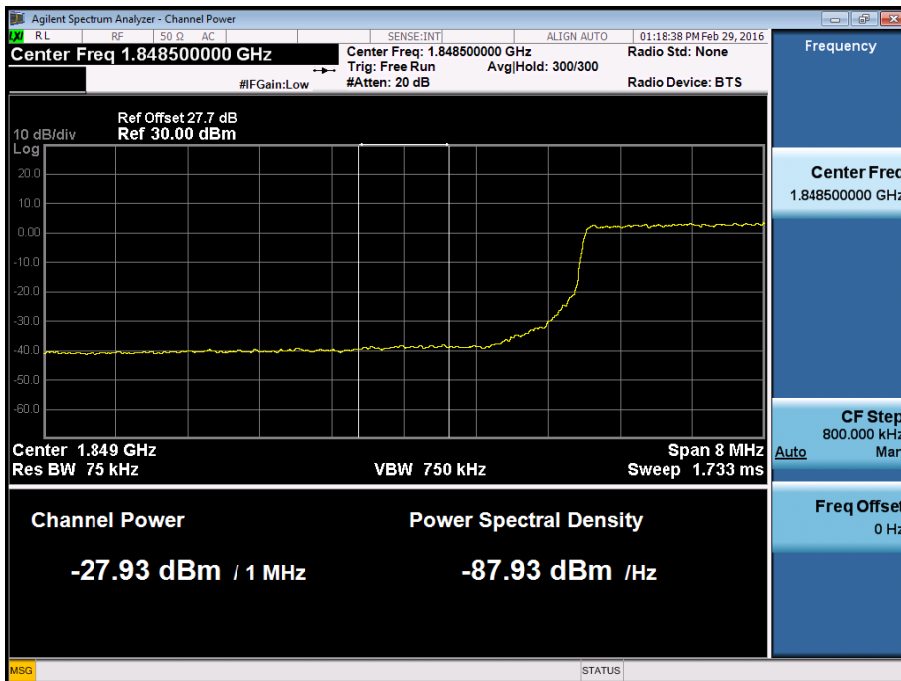



BAND 2. Lower Band Edge Plot (15M BW Ch.18675 QPSK\_RB75\_Offset 0) -1

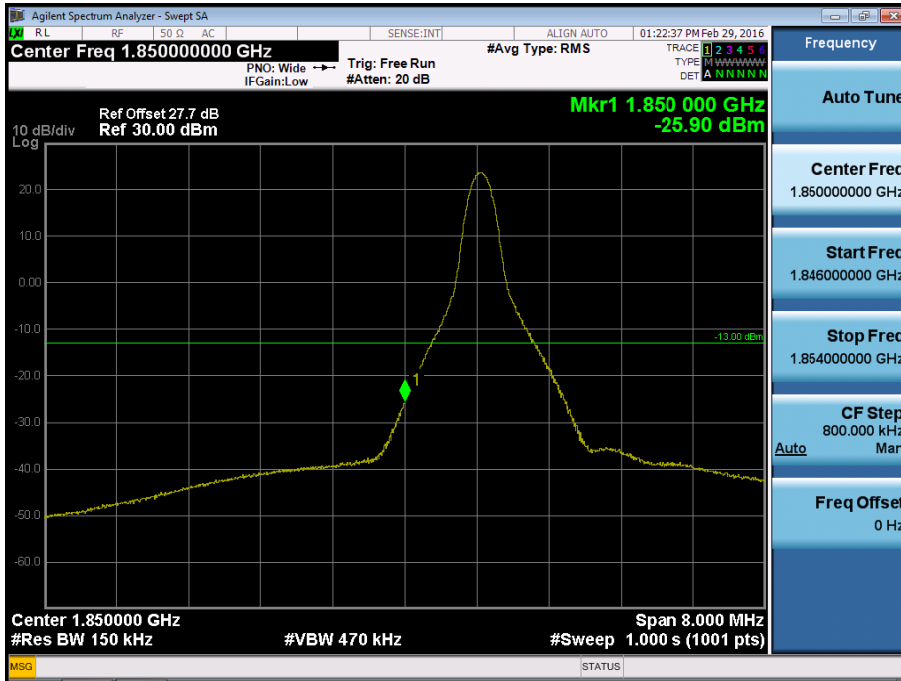

BAND 2. Lower Band Edge Plot (15M BW Ch.18675 QPSK\_RB75\_Offset 0) -2

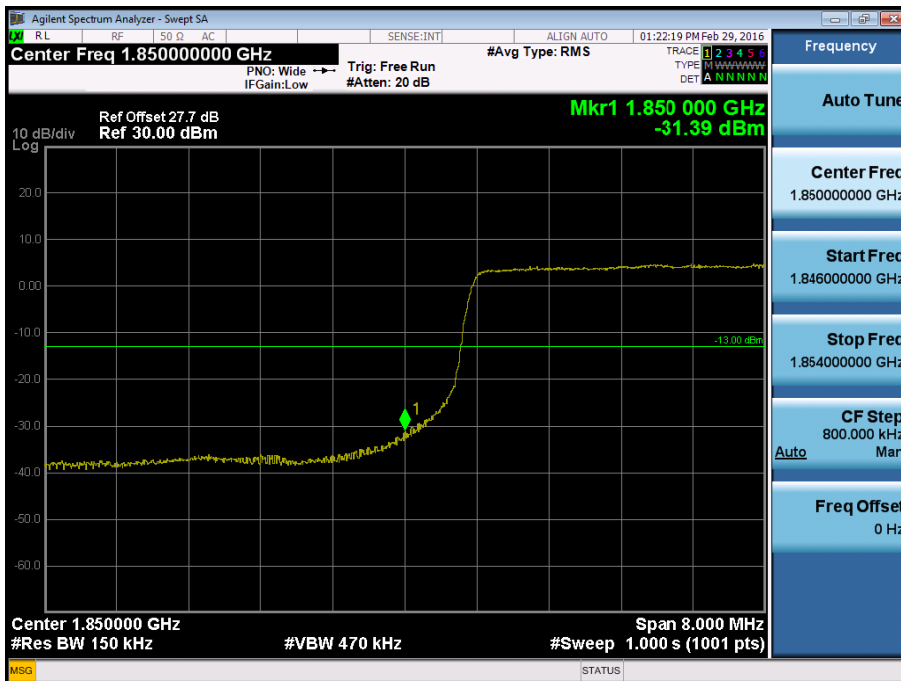

BAND 2. Lower Extended Band Edge Plot (15M BW Ch.18675 QPSK\_RB75\_0) -3

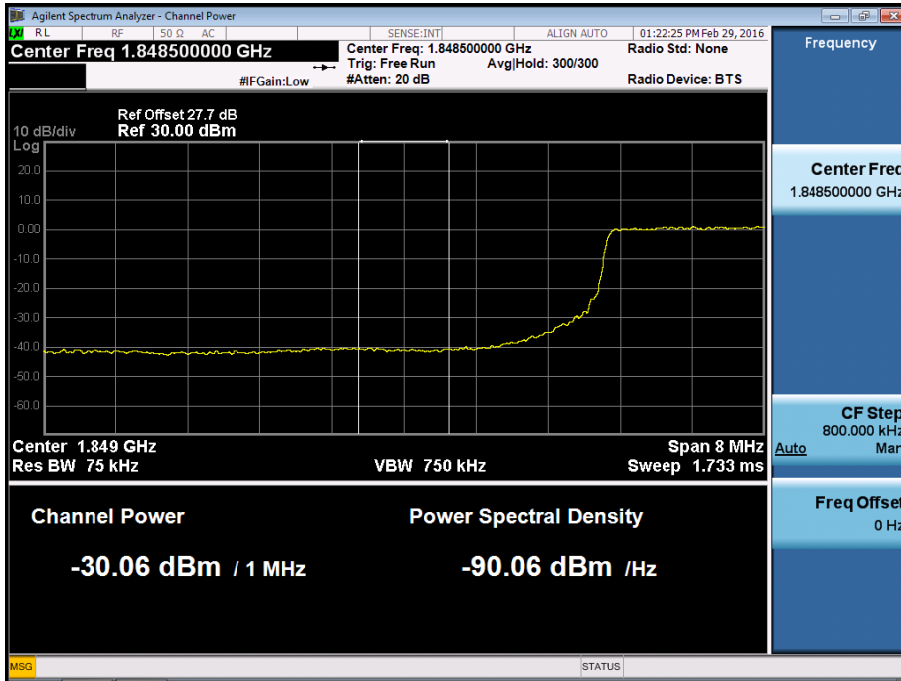

BAND 2. Lower Band Edge Plot (20M BW Ch.18700 QPSK\_RB1\_Offset 0) -1

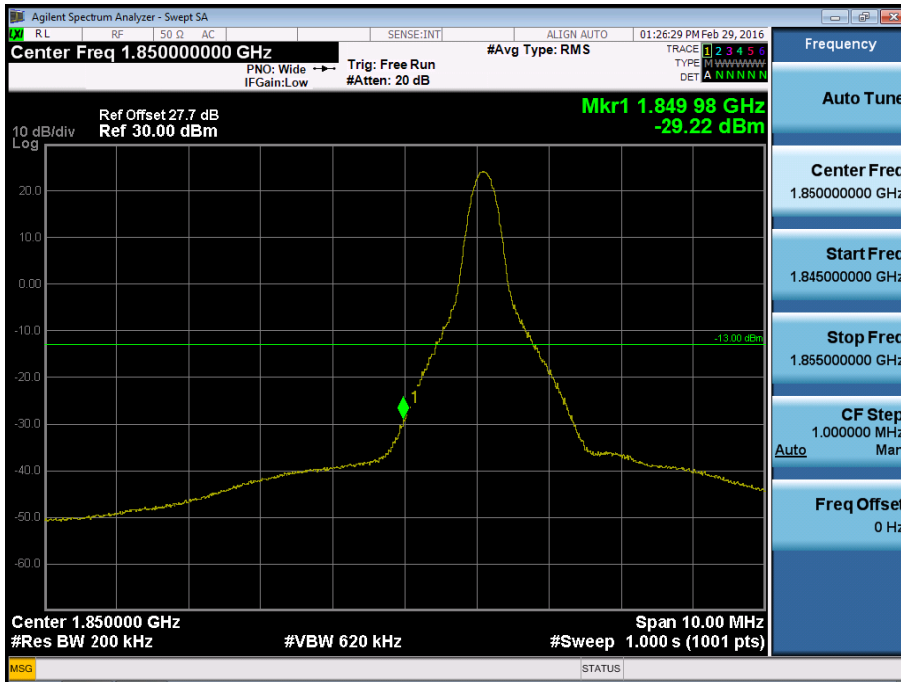

BAND 2. Lower Band Edge Plot (20M BW Ch.18700 QPSK\_RB100\_Offset 0) -2



BAND 2. Lower Extended Band Edge Plot (20M BW Ch.18700 QPSK\_RB100\_0) -3

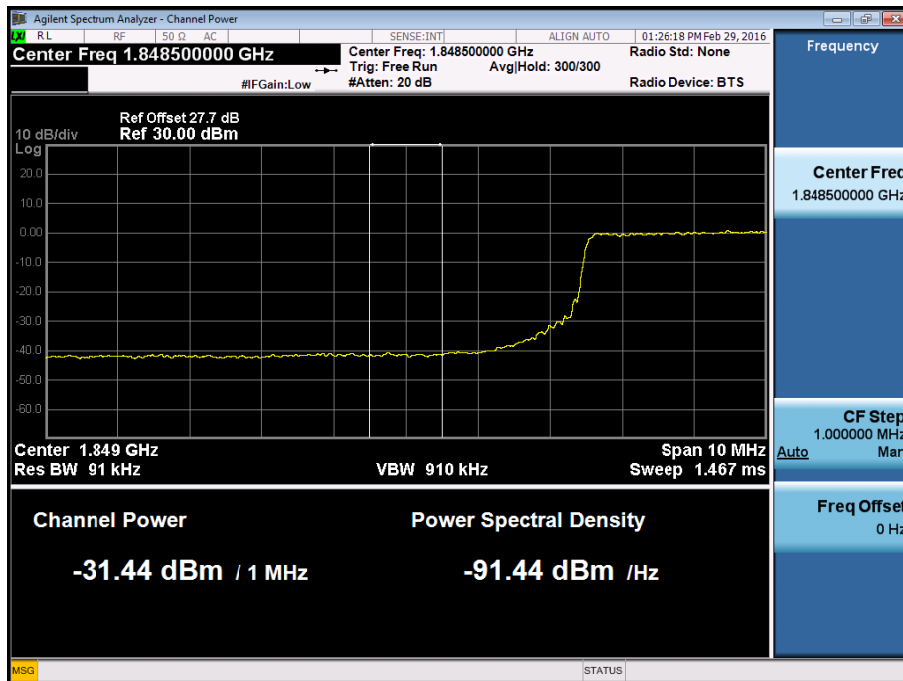

BAND 2. Upper Band Edge Plot (1.4M BW Ch.19193 QPSK\_RB1\_Offset 5) -1

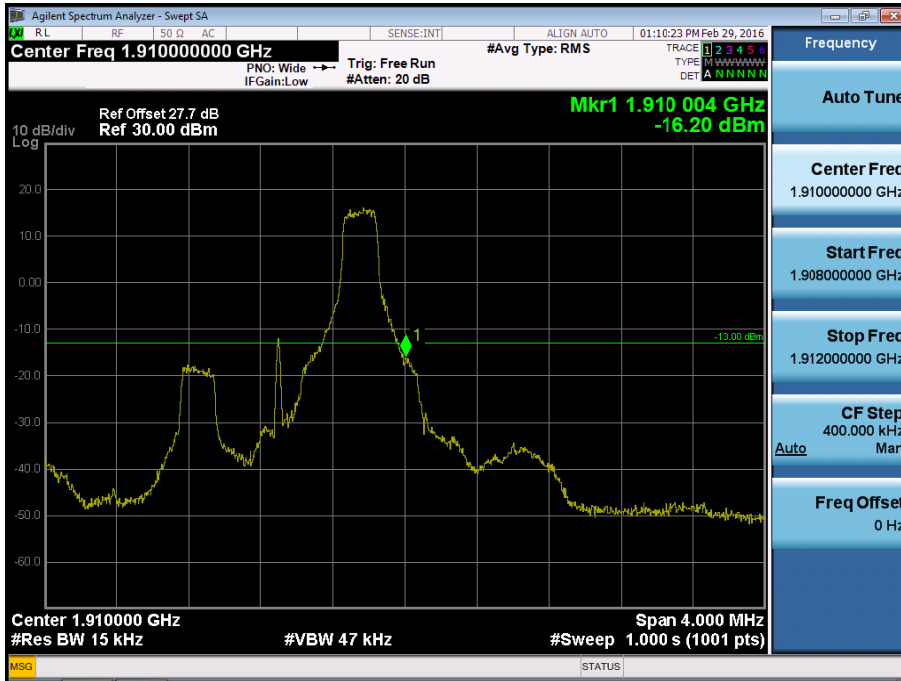

BAND 2. Upper Band Edge Plot (1.4M BW Ch.19193 QPSK\_RB6\_Offset 0) -2



BAND 2. Upper Extended Band Edge Plot (1.4M BW Ch.19193 QPSK\_RB6\_0) -3

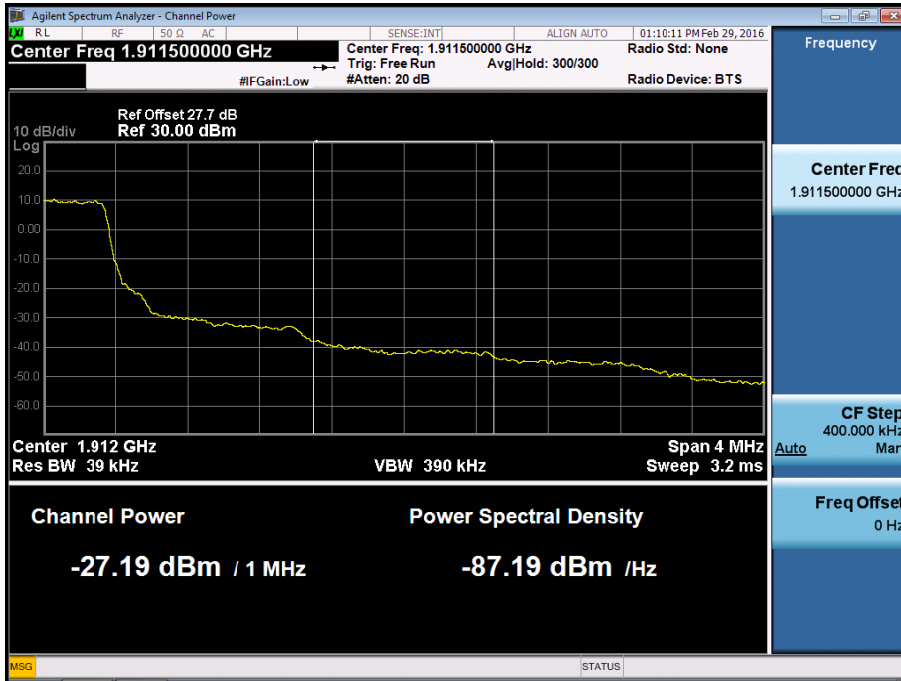

BAND 2. Upper Band Edge Plot (3M BW Ch.19185 QPSK\_RB1\_Offset 14) -1

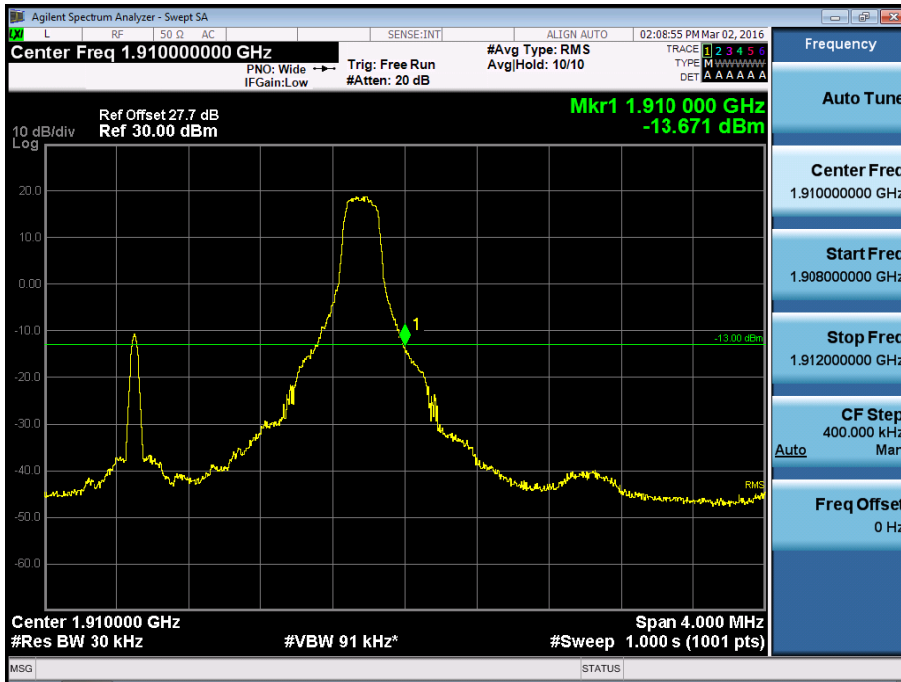

BAND 2. Upper Band Edge Plot (3M BW Ch.19185 QPSK\_RB15\_Offset 0) -2



BAND 2. Upper Extended Band Edge Plot (3M BW Ch.19185 QPSK\_RB15 0) -3

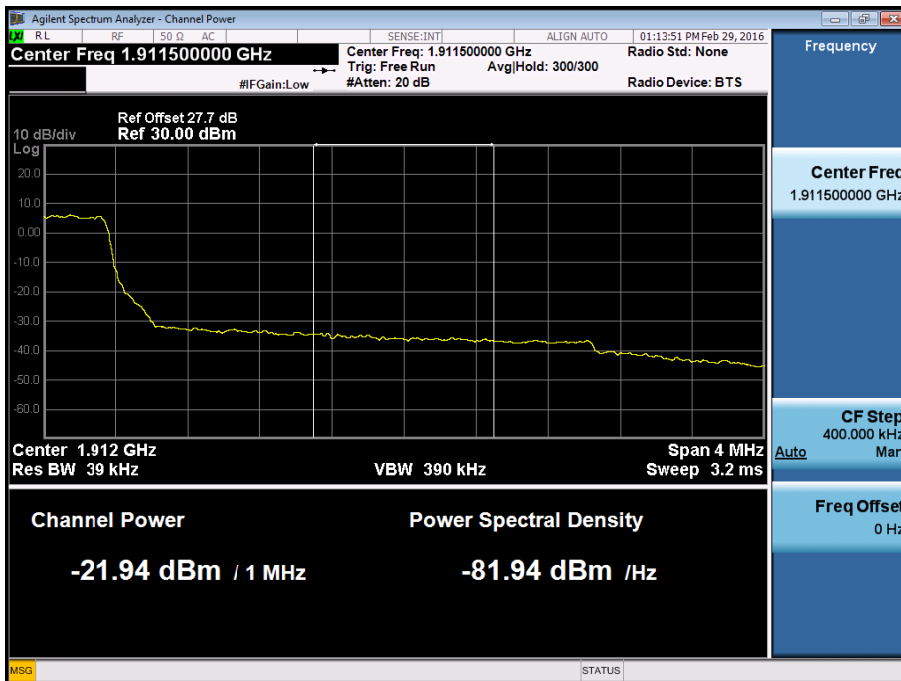

BAND 2. Upper Band Edge Plot (5M BW Ch.19175 QPSK\_RB1\_Offset 24) -1

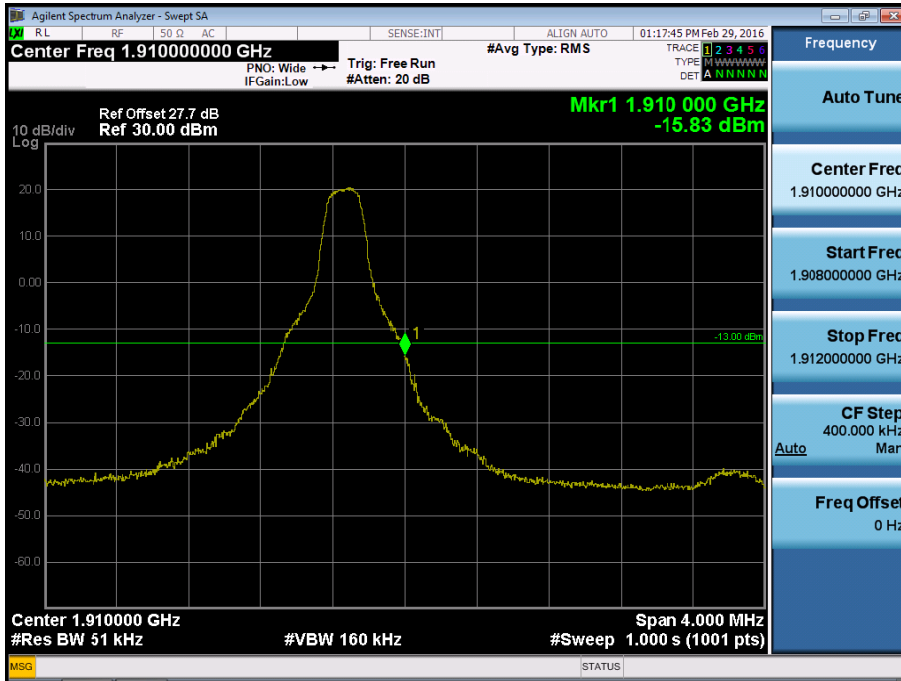

BAND 2. Upper Band Edge Plot (5M BW Ch.19175 QPSK\_RB25\_Offset 0) -2



BAND 2. Upper Extended Band Edge Plot (5M BW Ch.19175 QPSK\_RB25\_0) -3

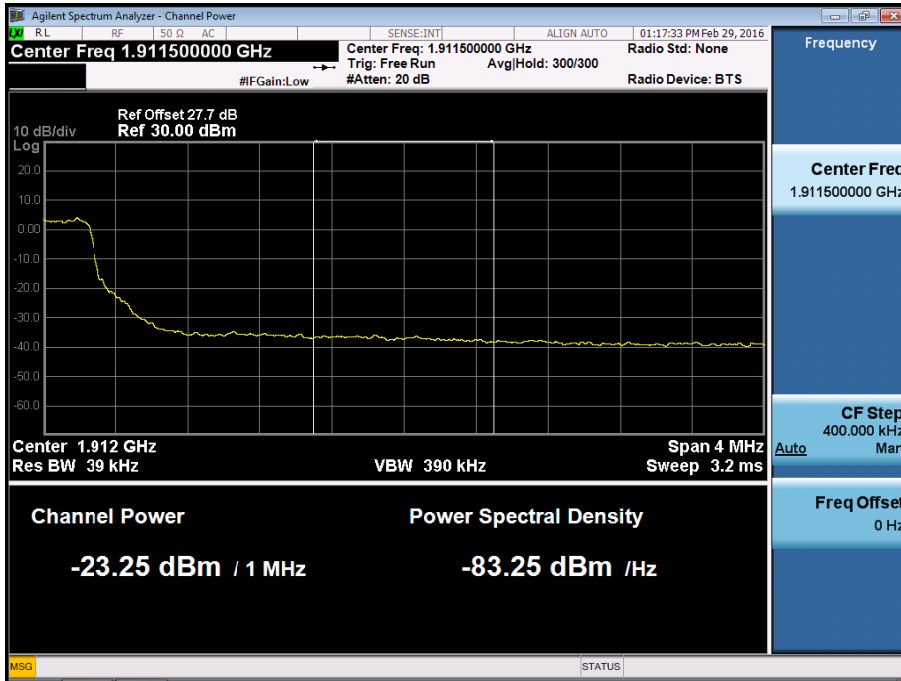

BAND 2. Upper Band Edge Plot (10M BW Ch.19150 QPSK\_RB1\_Offset 49) -1

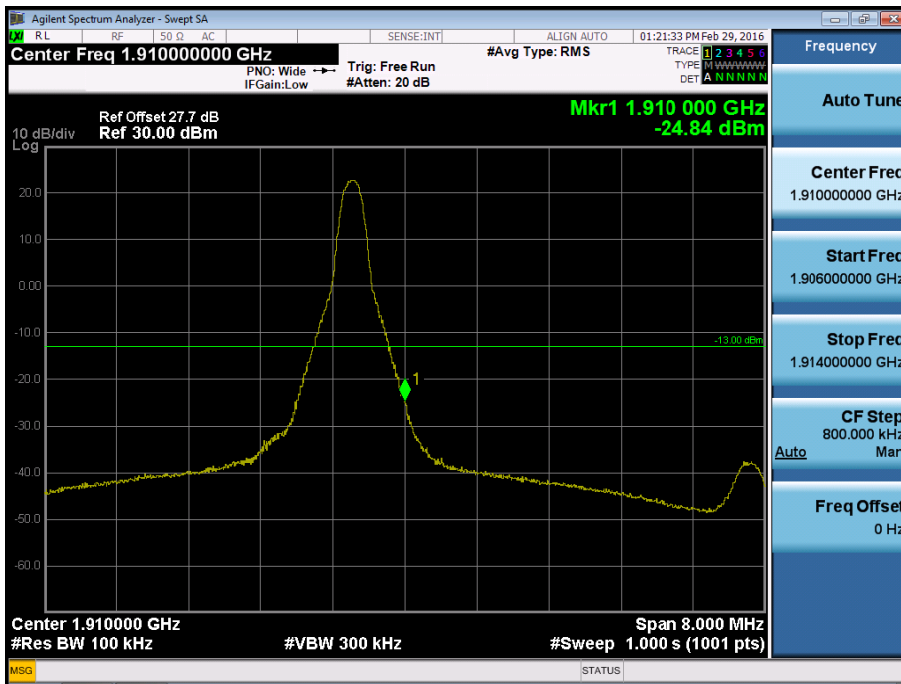



BAND 2. Upper Band Edge Plot (10M BW Ch.19150 QPSK\_RB50\_Offset 0) -2



BAND 2. Upper Extended Band Edge Plot (10M BW Ch.19150 QPSK\_RB50\_0) -3

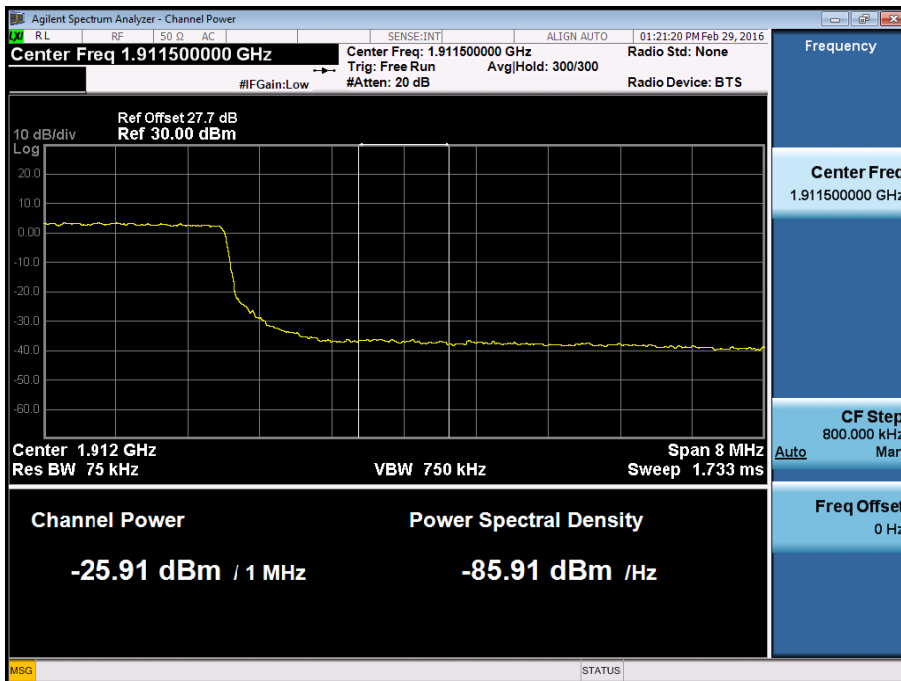

BAND 2. Upper Band Edge Plot (15M BW Ch.19125 QPSK\_RB1\_Offset 74) -1

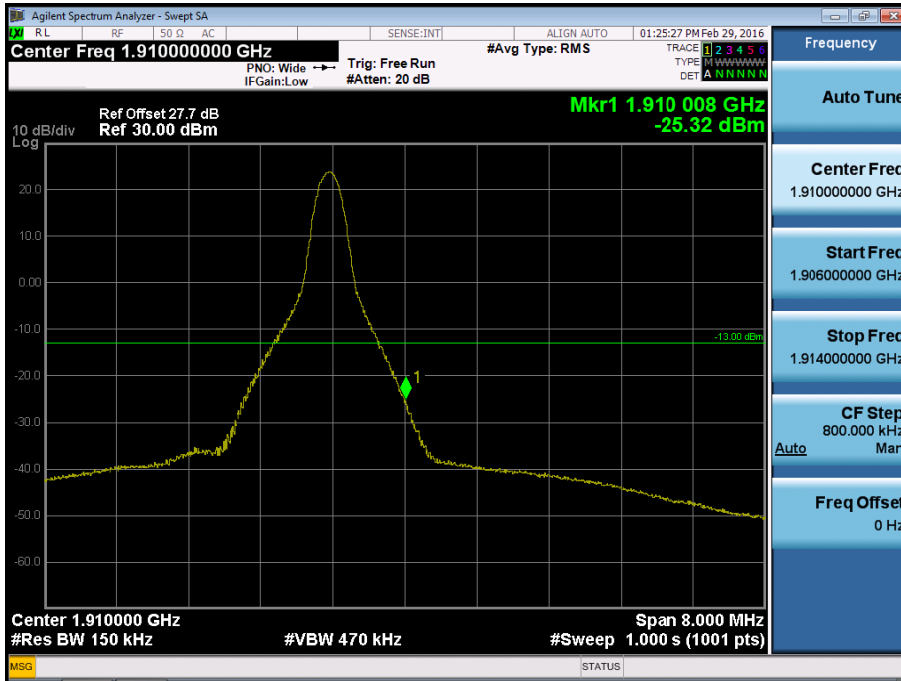

BAND 2. Upper Band Edge Plot (15M BW Ch.19125 QPSK\_RB75\_Offset 0) -2

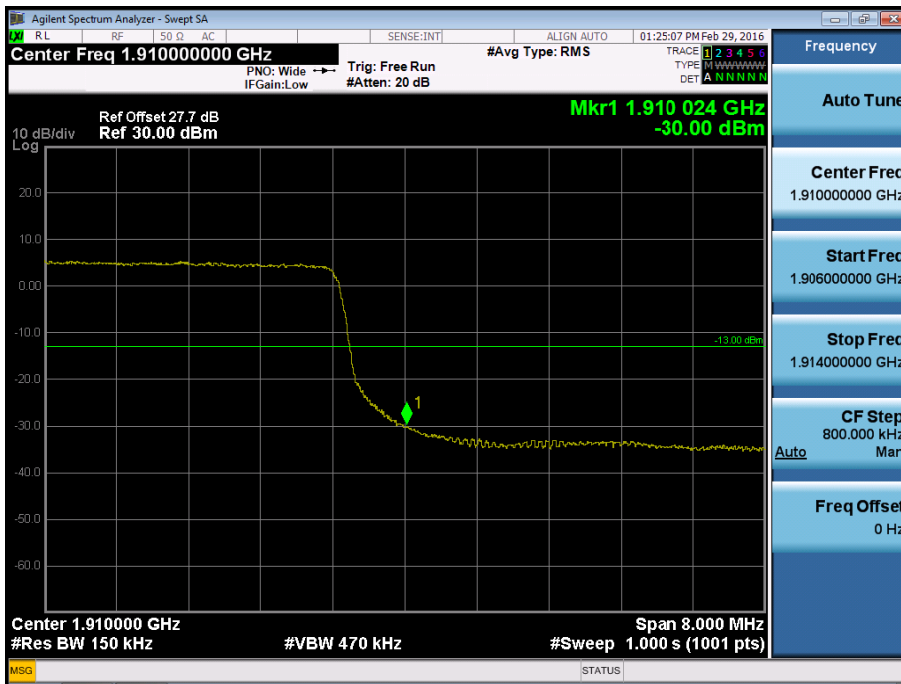

BAND 2. Upper Extended Band Edge Plot (15M BW Ch.19125 QPSK\_RB75\_0) -3

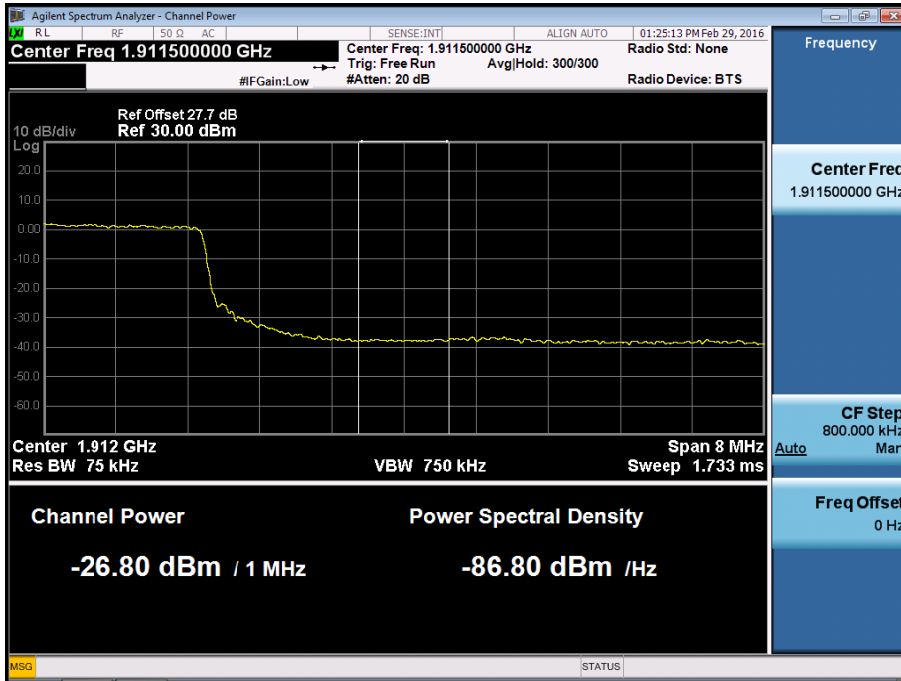

BAND 2. Upper Band Edge Plot (20M BW Ch.19100 QPSK\_RB1\_Offset 99) -1

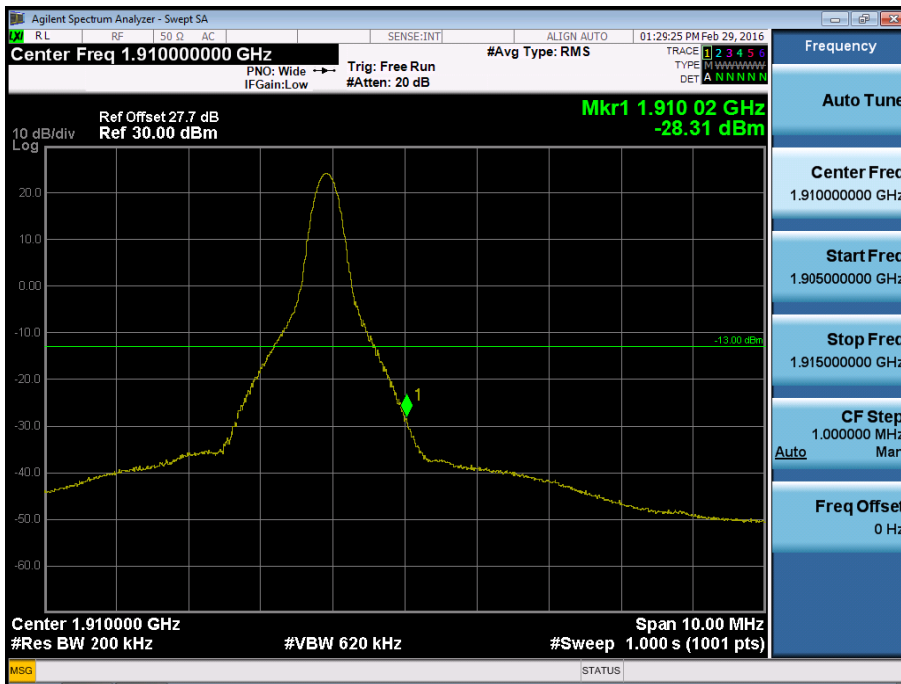

BAND 2. Upper Band Edge Plot (20M BW Ch.19100 QPSK\_RB100\_Offset 0) -2



BAND 2. Upper Extended Band Edge Plot (20M BW Ch.19100 QPSK\_RB100\_0) -3

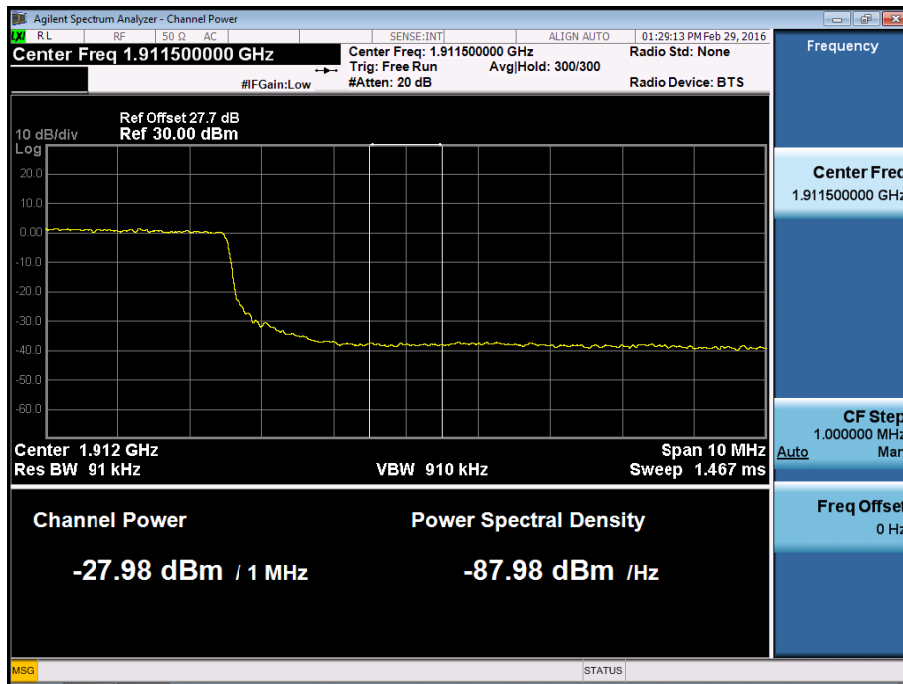

BAND 5. Lower Band Edge Plot (1.4M BW Ch.20407 QPSK\_RB1\_Offset 0)

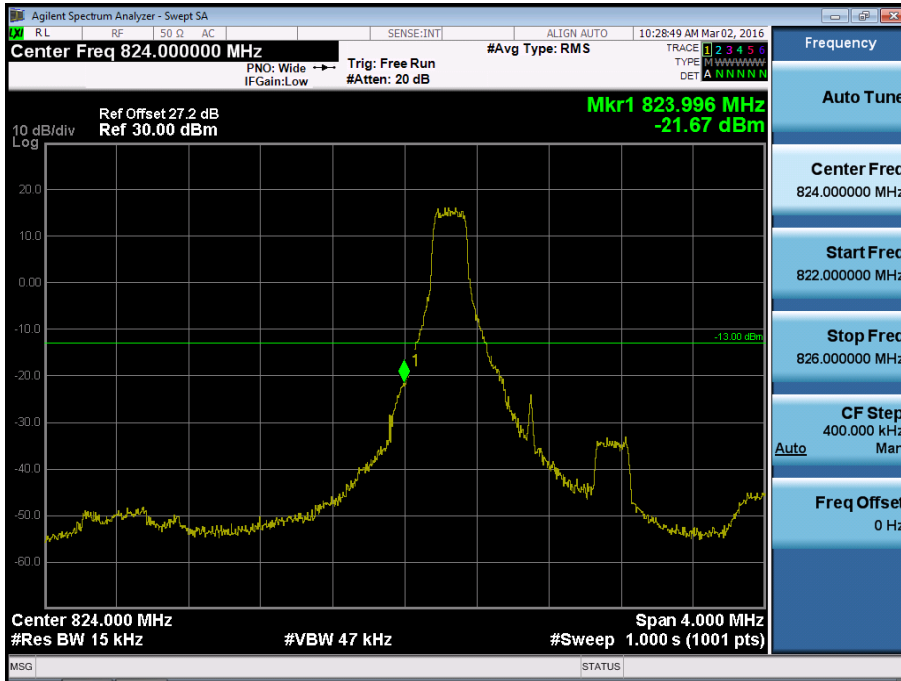

BAND 5. Lower Band Edge Plot (1.4M BW Ch.20407 QPSK\_RB6\_Offset 0)



BAND 5. Lower Extended Band Edge Plot (1.4M BW Ch.20407 QPSK\_RB6\_0)



BAND 5. Lower Band Edge Plot (3M BW Ch.20415 QPSK\_RB1\_Offset 0)

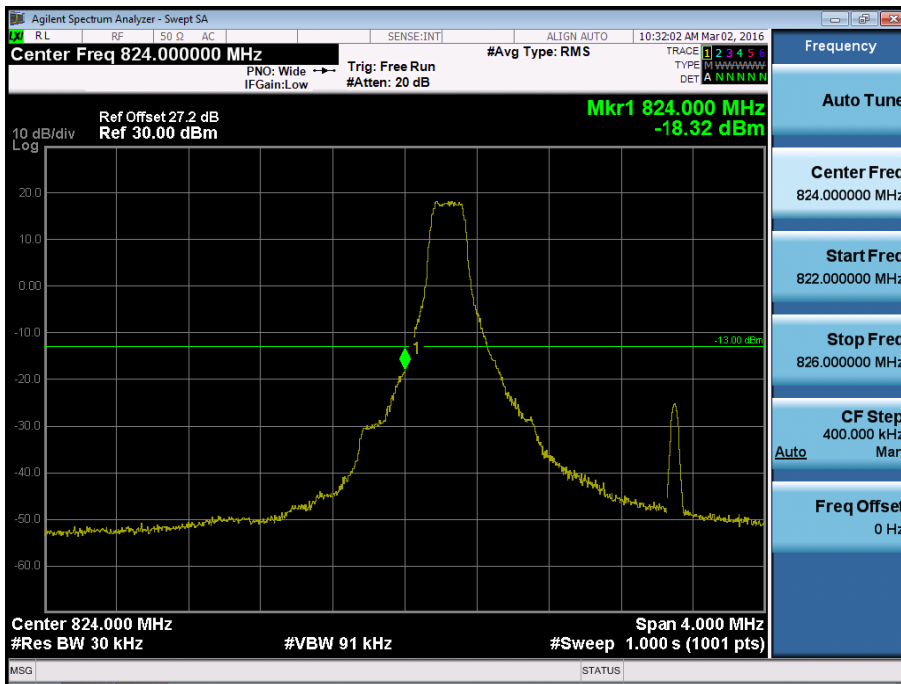

BAND 5. Lower Band Edge Plot (3M BW Ch.20415 QPSK\_RB15\_Offset 0)

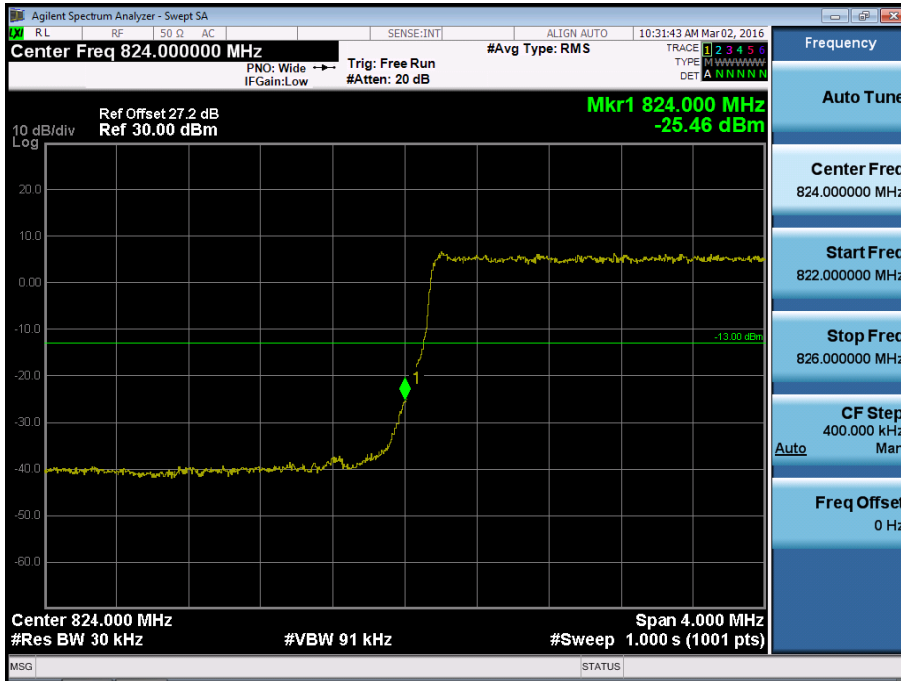

BAND 5. Lower Extended Band Edge Plot (3M BW Ch.20415 QPSK\_RB15\_0)

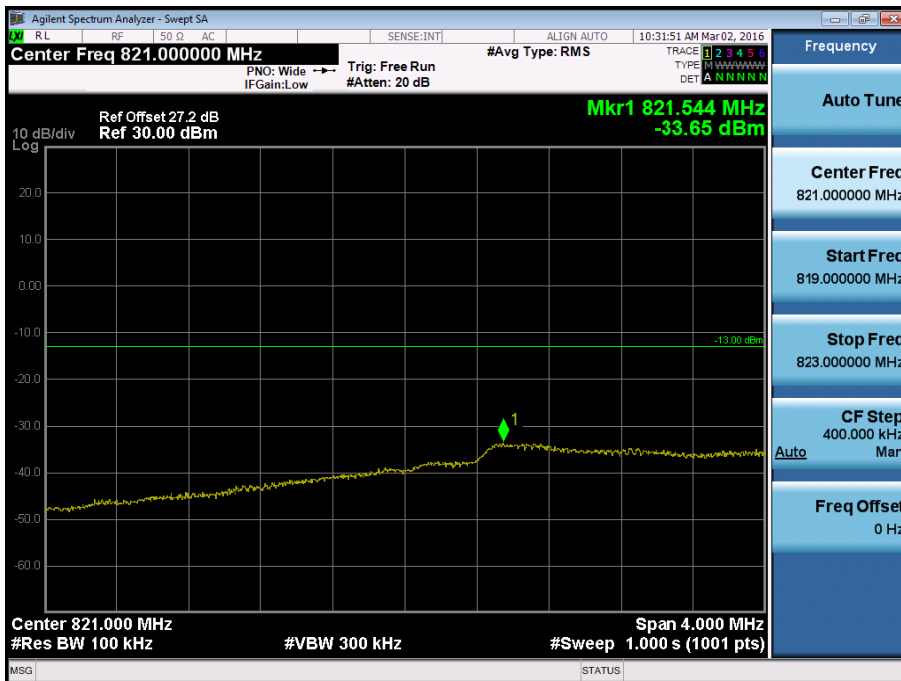

BAND 5. Lower Band Edge Plot (5M BW Ch.20425 QPSK\_RB1\_Offset 0)

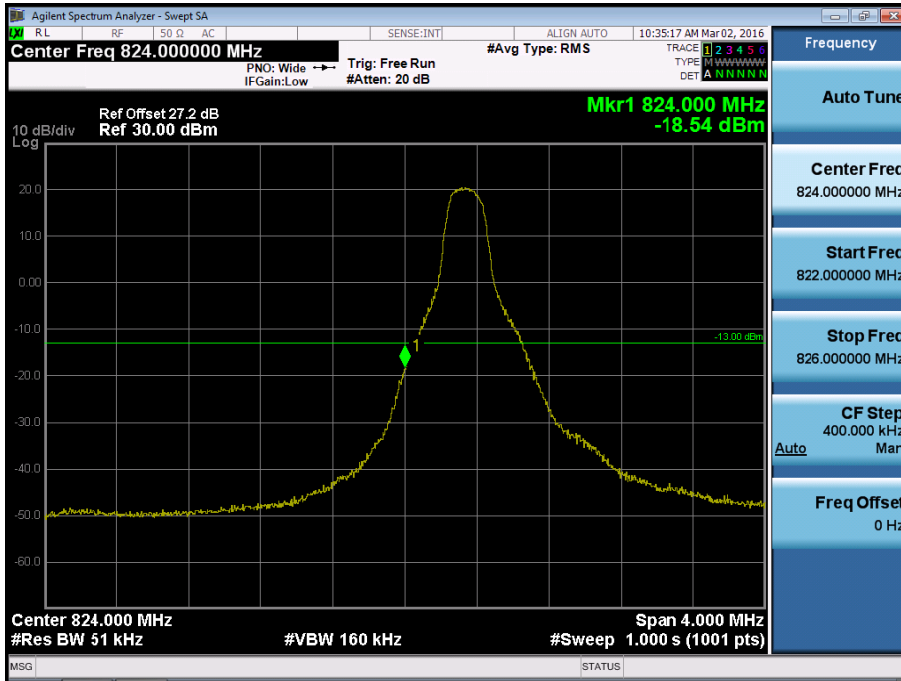

BAND 5. Lower Band Edge Plot (5M BW Ch.20425 QPSK\_RB25\_Offset 0)

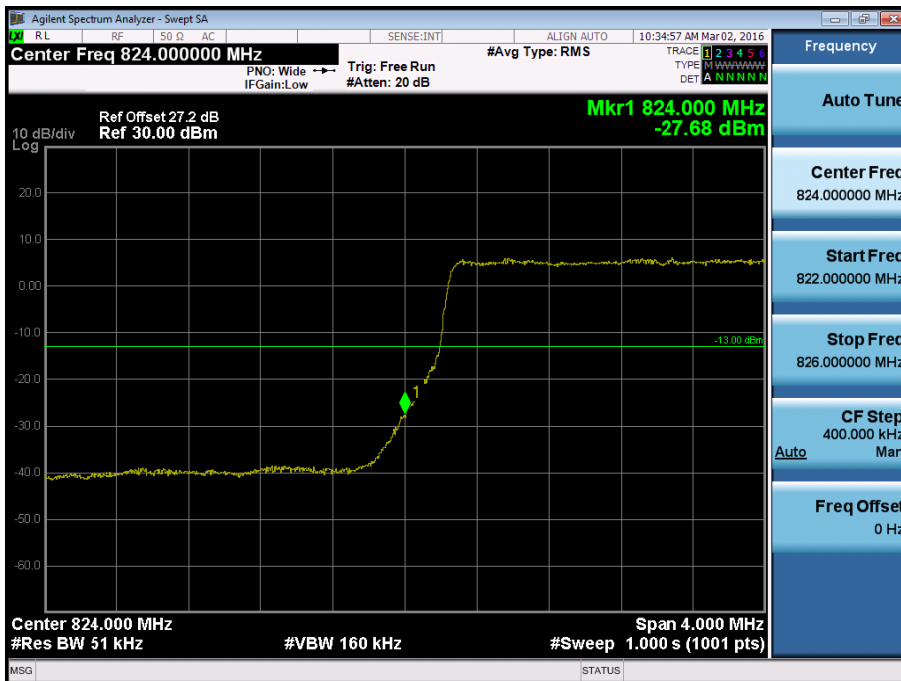



BAND 5. Lower Extended Band Edge Plot (5M BW Ch.20425 QPSK\_RB25\_0)

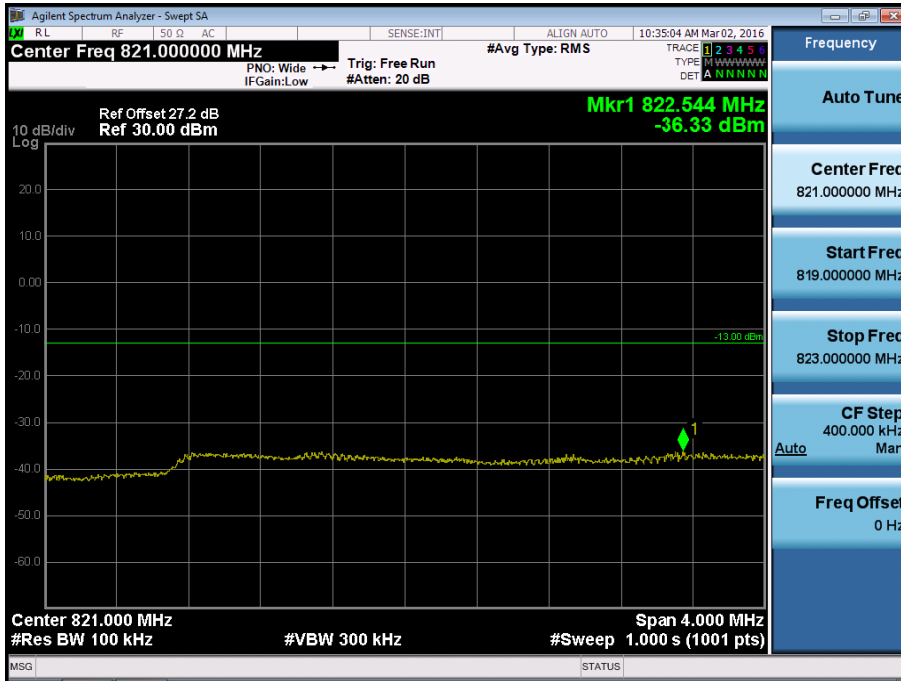

BAND 5. Lower Band Edge Plot (10M BW Ch.20450 QPSK\_RB1\_Offset 0)

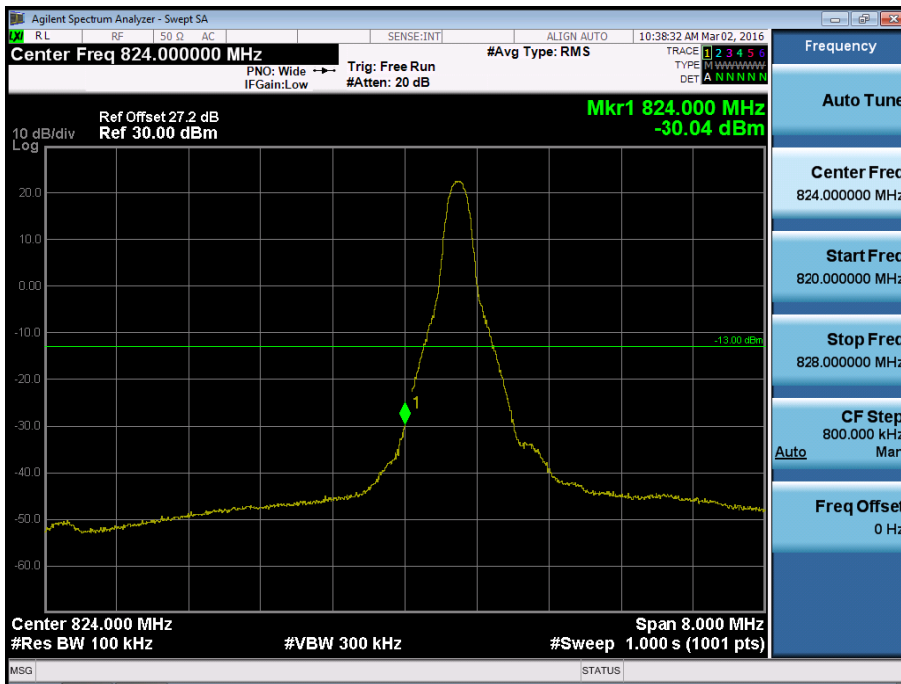

BAND 5. Lower Band Edge Plot (10M BW Ch.20450 QPSK\_RB50\_Offset 0)

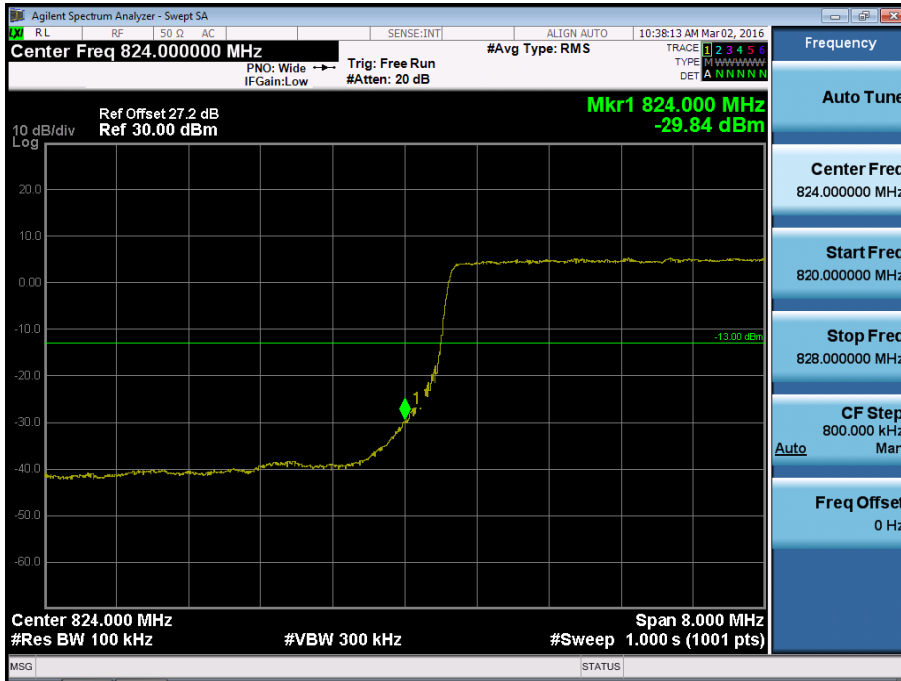

BAND 5. Lower Extended Band Edge Plot (10M BW Ch.20450 QPSK\_RB50\_0)

