

FCC LTE REPORT

FCC Certification

Applicant Name: LG Electronics MobileComm U.S.A., Inc.	Date of Issue: January 07, 2016
Address: 1000 Sylvan Avenue, Englewood Cliffs NJ 07632	Location: HCT CO., LTD., 74, Seoicheon-ro 578beon-gil, Majang-myeon, Icheon-si, Gyeonggi-do, 17383, Rep. of KOREA
	Report No.: HCT-R-1601-F008 HCT FRN: 0005866421

FCC ID: ZNFK430T

APPLICANT: LG Electronics MobileComm U.S.A., Inc.

FCC Model(s): LG-K430T

Additional FCC Model(s): LGK430T, K430T

EUT Type: GSM WCDMA LTE Phone with BT & WLAN

FCC Classification: Licensed Portable Transmitter Held to Ear (PCE)

FCC Rule Part(s): §22, §24, §2

Mode (MHz)	Tx Frequency (MHz)	Emission Designator	Modulation	EIRP	
				Max. Power (W)	Max. Power (dBm)
LTE – Band2 (1.4)	1850.7 - 1909.3	1M09G7D	QPSK	0.121	20.84
		1M10W7D	16QAM	0.100	20.00
LTE – Band2 (3)	1851.5 - 1908.5	2M70G7D	QPSK	0.122	20.86
		2M70W7D	16QAM	0.098	19.93
LTE – Band2 (5)	1852.5 - 1907.5	4M51G7D	QPSK	0.119	20.76
		4M52W7D	16QAM	0.097	19.87
LTE – Band2 (10)	1855.0 - 1905.0	8M98G7D	QPSK	0.128	21.06
		8M96W7D	16QAM	0.104	20.16
LTE – Band2 (15)	1857.5 - 1902.5	13M5G7D	QPSK	0.123	20.91
		13M5W7D	16QAM	0.100	20.02
LTE – Band2 (20)	1860.0 - 1900.0	18M0G7D	QPSK	0.126	20.99
		18M0W7D	16QAM	0.102	20.10

Mode (MHz)	Tx Frequency (MHz)	Emission Designator	Modulation	ERP	
				Max. Power (W)	Max. Power (dBm)
LTE – Band5 (1.4)	824.7 – 848.3	1M09G7D	QPSK	0.066	18.17
		1M09W7D	16QAM	0.057	17.53
LTE – Band5 (3)	825.5 – 847.5	2M71G7D	QPSK	0.069	18.38
		2M69W7D	16QAM	0.057	17.55
LTE – Band5 (5)	826.5 – 846.5	4M52G7D	QPSK	0.066	18.21
		4M51W7D	16QAM	0.057	17.58
LTE – Band5 (10)	829.0 – 844.0	8M99G7D	QPSK	0.067	18.24
		8M97W7D	16QAM	0.056	17.45

The measurements shown in this report were made in accordance with the procedures specified in CFR47 section §2.947. I assume full responsibility for the accuracy and completeness of these measurements, and for the qualifications of all persons taking them.

HCT CO., LTD. Certifies that no party to this application has subject to a denial of Federal benefits that includes FCC benefits pursuant to section 5301 of the Anti-Drug Abuse Act of 1998, 21 U.S. C. 853(a)



Report prepared by
: Ki Hyun Kim
Test engineer of RF Team



Approved by
: Sang Jun Lee
Manager of RF Team

This report only responds to the tested sample and may not be reproduced, except in full, without written approval of the HCT Co., Ltd.

Report Revision

TEST REPORT NO.	DATE	DESCRIPTION
HCT-R-1601-F008	January 07, 2016	- First Approval Report

Table of Contents

1. GENERAL INFORMATION	6
2. INTRODUCTION	8
2.1. EUT DESCRIPTION.....	8
2.2. MEASURING INSTRUMENT CALIBRATION.....	8
2.3. TEST FACILITY	8
3. DESCRIPTION OF TESTS	9
3.1 ERP/ EIRP RADIATED POWER AND RADIATED SPURIOUS EMISSIONS.....	9
3.2 FREQUENCY RANGE.....	10
3.3 PEAK-AVERAGE RATIO.	11
3.4 OCCUPIED BANDWIDTH.	13
3.5 SPURIOUS AND HARMONIC EMISSIONS AT ANTENNA TERMINAL.....	14
3.6 FREQUENCY STABILITY / VARIATION OF AMBIENT TEMPERATURE	15
4. LIST OF TEST EQUIPMENT	16
5. SUMMARY OF TEST RESULTS	17
6. SAMPLE CALCULATION.....	18
7. TEST DATA	19
7.1 EQUIVALENT ISOTROPIC RADIATED POWER (Band 2)	19
7.2 EFFECTIVE RADIATED POWER (Band 5).....	23
7.3 RADIATED SPURIOUS EMISSIONS.....	25
7.3.1 RADIATED SPURIOUS EMISSIONS (1.4 MHz Band 2 LTE).....	25
7.3.2 RADIATED SPURIOUS EMISSIONS (3 MHz Band 2 LTE).....	26
7.3.3 RADIATED SPURIOUS EMISSIONS (5 MHz Band 2 LTE).....	27
7.3.4 RADIATED SPURIOUS EMISSIONS (10 MHz Band 2 LTE).....	28
7.3.5 RADIATED SPURIOUS EMISSIONS (15 MHz Band 2 LTE).....	29
7.3.6 RADIATED SPURIOUS EMISSIONS (20 MHz Band 2 LTE).....	30
7.3.7 RADIATED SPURIOUS EMISSIONS (1.4 MHz Band 5 LTE).....	31
7.3.8 RADIATED SPURIOUS EMISSIONS (3 MHz Band 5 LTE).....	32
7.3.9 RADIATED SPURIOUS EMISSIONS (5 MHz Band 5 LTE).....	33
7.3.10 RADIATED SPURIOUS EMISSIONS (10 MHz Band 5 LTE).....	34
7.4 PEAK-TO-AVERAGE RATIO	35
7.5 OCCUPIED BANDWIDTH	36
7.6 CONDUCTED SPURIOUS EMISSIONS	37
7.6.1 BAND EDGE.....	38
7.7 FREQUENCY STABILITY / VARIATION OF AMBIENT TEMPERATURE	39
7.7.1 FREQUENCY STABILITY (1.4 MHz Band 2 LTE)	39

7.7.2 FREQUENCY STABILITY (3 MHz Band 2 LTE) 40

7.7.3 FREQUENCY STABILITY (5 MHz Band 2 LTE) 41

7.7.4 FREQUENCY STABILITY (10 MHz Band 2 LTE) 42

7.7.5 FREQUENCY STABILITY (15 MHz Band 2 LTE) 43

7.7.6 FREQUENCY STABILITY (20 MHz Band 2 LTE) 44

7.7.7 FREQUENCY STABILITY (1.4 MHz Band 5 LTE) 45

7.7.8 FREQUENCY STABILITY (3 MHz Band 5 LTE) 46

7.7.9 FREQUENCY STABILITY (5 MHz Band 5 LTE) 47

7.7.10 FREQUENCY STABILITY (10 MHz Band 5 LTE) 48

8. TEST PLOTS..... 49

MEASUREMENT REPORT

1. GENERAL INFORMATION

Applicant Name: LG Electronics MobileComm U.S.A., Inc.
Address: 1000 Sylvan Avenue, Englewood Cliffs NJ 07632
FCC ID: ZNFK430T
Application Type: Certification
FCC Classification: Licensed Portable Transmitter Held to Ear (PCE)
FCC Rule Part(s): §22, §24, §2
EUT Type: GSM WCDMA LTE Phone with BT & WLAN
FCC Model(s): LG-K430T
Additional LGK430T, K430T

Tx Frequency: 1850.7 MHz – 1909.3 MHz (LTE – Band2 (1.4 MHz))
1851.5 MHz – 1908.5 MHz (LTE – Band2 (3 MHz))
1852.5 MHz – 1907.5 MHz (LTE – Band2 (5 MHz))
1855.0 MHz – 1905.0 MHz (LTE – Band2 (10 MHz))
1857.5 MHz – 1902.5 MHz (LTE – Band2 (15 MHz))
1860.0 MHz – 1900.0 MHz (LTE – Band2 (20 MHz))

824.7 MHz – 848.3 MHz (LTE – Band 5 (1.4 MHz))
825.5 MHz – 847.5 MHz (LTE – Band 5 (3 MHz))
826.5 MHz – 846.5 MHz (LTE – Band 5 (5 MHz))
829.0 MHz – 844.0 MHz (LTE – Band 5 (10 MHz))

Max. RF Output Power:

Band 2 (1.4 MHz) :	0.121 W (QPSK) (20.84 dBm)
	0.100 W (16-QAM) (20.00 dBm)
Band 2 (3 MHz) :	0.122 W (QPSK) (20.86 dBm)
	0.098 W (16-QAM) (19.93 dBm)
Band 2 (5 MHz) :	0.119 W (QPSK) (20.76 dBm)
	0.097 W (16-QAM) (19.87 dBm)
Band 2 (10 MHz) :	0.128 W (QPSK) (21.06 dBm)
	0.104 W (16-QAM) (20.16 dBm)
Band 2 (15 MHz) :	0.123 W (QPSK) (20.91 dBm)
	0.100 W (16-QAM) (20.02 dBm)
Band 2 (20 MHz) :	0.126 W (QPSK) (20.99 dBm)
	0.102 W (16-QAM) (20.10 dBm)
Band 5 (1.4 MHz) :	0.066 W (QPSK) (18.17 dBm)
	0.057 W (16-QAM) (17.53 dBm)
Band 5 (3 MHz) :	0.069 W (QPSK) (18.38 dBm)
	0.057 W (16-QAM) (17.55 dBm)
Band 5 (5 MHz) :	0.066 W (QPSK) (18.21 dBm)
	0.057 W (16-QAM) (17.58 dBm)
Band 5 (10 MHz) :	0.067 W (QPSK) (18.24 dBm)
	0.056 W (16-QAM) (17.45 dBm)

Emission Designator(s):	Band 2 (1.4 MHz) :	1M09G7D (QPSK) / 1M10W7D (16-QAM)
	Band 2 (3 MHz)	2M70G7D (QPSK) / 2M70W7D (16-QAM)
	Band 2 (5 MHz) :	4M51G7D (QPSK) / 4M52W7D (16-QAM)
	Band 2 (10 MHz)	8M98G7D (QPSK) / 8M96W7D (16-QAM)
	Band 2 (15 MHz) :	13M5G7D (QPSK) / 13M5W7D (16-QAM)
	Band 2 (20 MHz)	18M0G7D (QPSK) / 18M0W7D (16-QAM)
	Band 5 (1.4 MHz) :	1M09G7D (QPSK) / 1M09W7D (16-QAM)
	Band 5 (3 MHz) :	2M71G7D (QPSK) / 2M69W7D (16-QAM)
	Band 5 (5 MHz) :	4M52G7D (QPSK) / 4M51W7D (16-QAM)
Band 5 (10 MHz) :	8M99G7D (QPSK) / 8M97W7D (16-QAM)	

Date(s) of Tests: December 08, 2015 ~ January 05, 2016

Antenna Specification:
Manufacturer: AT&C Co.LTD.
Antenna type: Internal Antenna
Peak Gain: Band 2 : -2.48 dBi
Peak Gain: Band 5 : -7.07 dBi

2. INTRODUCTION

2.1. EUT DESCRIPTION

The LG Electronics MobileComm U.S.A., Inc. LG-K430T GSM WCDMA LTE Phone with BT & WLAN consists of LTE 2 and 5.

2.2. MEASURING INSTRUMENT CALIBRATION

The measuring equipment, which was utilized in performing the tests documented herein, has been calibrated in accordance with the manufacturer's recommendations for utilizing calibration equipment, which is traceable to recognized national standards.

2.3. TEST FACILITY

The Fully-anechoic chamber and conducted measurement facility used to collect the radiated data are located at the **74, Seoicheon-ro 578beon-gil, Majang-myeon, Icheon-si, Gyeonggi-do, 17383, Rep. of KOREA.**

3. DESCRIPTION OF TESTS

3.1 ERP/ EIRP RADIATED POWER AND RADIATED SPURIOUS EMISSIONS

Note: ERP(Effective Radiated Power), EIRP(Effective Isotropic Radiated Power)

Test Procedure

Radiated emission measurements are performed in the Fully-anechoic chamber. The equipment under test is placed on a non-conductive table 3-meters away from the receive antenna in accordance with ANSI/TIA-603-D-2010 Clause 2.2.17. The turntable is rotated through 360 degrees, and the receiving antenna scans in order to determine the level of the maximized emission. The level and position of the maximized emission is recorded with the spectrum analyzer using a RMS detector.

A half wave dipole is then substituted in place of the EUT. For emissions above 1GHz, a horn antenna is substituted in place of the EUT. The substitute antenna is driven by a signal generator and the previously recorded signal was duplicated.

The power is calculated by the following formula;

$$P_{d(\text{dBm})} = P_{g(\text{dBm})} - \text{cable loss}_{(\text{dB})} + \text{antenna gain}_{(\text{dB})}$$

Where: P_d is the dipole equivalent power and P_g is the generator output power into the substitution antenna.

The maximum EIRP is calculated by adding the forward power to the calibrated source plus its appropriate gain value. These steps are repeated with the receiving antenna in both vertical and horizontal polarization. the difference between the gain of the horn and an isotropic antenna are taken into consideration

Radiated spurious emissions

: Frequency Range : 30 MHz ~ 10th Harmonics of highest channel fundamental frequency.

3.2 FREQUENCY RANGE

§ 24.229: PCS – Mobile Frequency Blocks

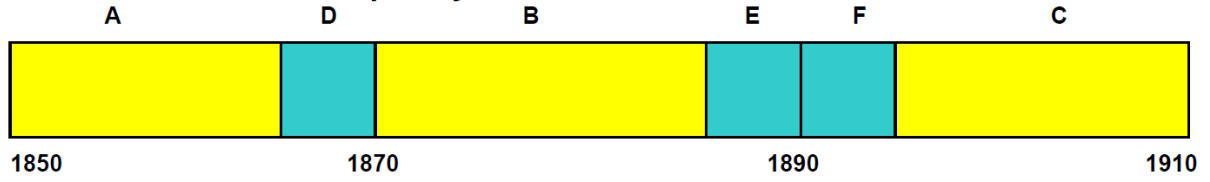

- | | |
|-------------------------------------|-------------------------------------|
| BLOCK 1: 1850 – 1865 MHz (A) | BLOCK 4: 1885 – 1890 MHz (E) |
| BLOCK 2: 1865 – 1870 MHz (D) | BLOCK 5: 1890 – 1895 MHz (F) |
| BLOCK 3: 1870 – 1885 MHz (B) | BLOCK 6: 1895 – 1910 MHz (C) |

§22.917(a): Cellular – Mobile Frequency Blocks

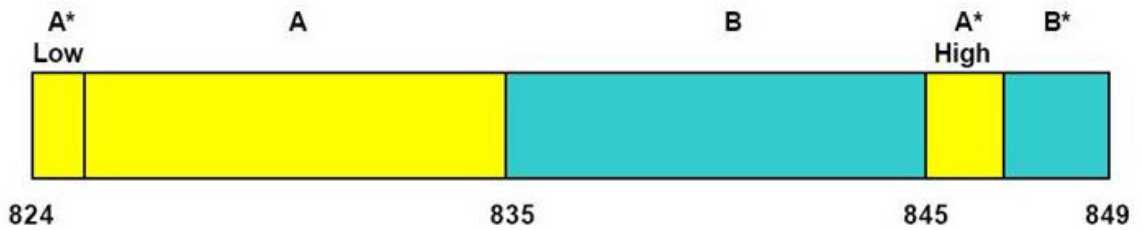

- | | |
|--|---|
| BLOCK 1: 824 – 835 MHz (A* Low + A) | BLOCK 3: 845 – 846.5 MHz (A* High) |
| BLOCK 2: 835 – 845 MHz (B) | BLOCK 4: 846.5 – 849 MHz (B*) |

3.3 PEAK-AVERAGE RATIO.

Test Procedure

Peak to Average Power Ratio is tested in accordance with KDB971168 D01 Power Meas License Digital Systems v02r02, October 17, 2014, Section 5.7.

- Section 5.7.1 CCDF Procedure

- a) Set resolution/measurement bandwidth \geq signal's occupied bandwidth;
- b) Set the number of counts to a value that stabilizes the measured CCDF curve;
- c) Set the measurement interval as follows:
 - 1) for continuous transmissions, set to 1 ms,
 - 2) for burst transmissions, employ an external trigger that is synchronized with the EUT burst timing sequence, or use the internal burst trigger with a trigger level that allows the burst to stabilize and set the measurement interval to a time that is less than or equal to the burst duration.
- d) Record the maximum PAPR level associated with a probability of 0.1%.

- Section 5.7.2 Alternate Procedure

Use one of the procedures presented in 5.1 to measure the total peak power and record as P_{Pk} . Use one of the applicable procedures presented 5.2 to measure the total average power and record as P_{Avg} . Determine the P.A.R. from: $P.A.R_{(dB)} = P_{Pk (dBm)} - P_{Avg (dBm)}$ (P_{Avg} = Average Power + Duty cycle Factor)

5.1.1 Peak power measurements with a spectrum/signal analyzer or EMI receiver

The following procedure can be used to determine the total peak output power.

- a) Set the RBW \geq OBW.
- b) Set VBW $\geq 3 \times$ RBW.
- c) Set span $\geq 2 \times$ RBW
- d) Sweep time = auto couple.
- e) Detector = peak.
- f) Ensure that the number of measurement points \geq span/RBW.
- g) Trace mode = max hold.
- h) Allow trace to fully stabilize.
- i) Use the peak marker function to determine the peak amplitude level.

5.2.2 Procedures for use with a spectrum/signal analyzer when EUT cannot be configured to transmit continuously and sweep triggering/signal gating cannot be properly implemented

If the EUT cannot be configured to transmit continuously (burst duty cycle < 98%), then one of the following procedures can be used. The selection of the applicable procedure will depend on the characteristics of the measured burst duty cycle.

Measure the burst duty cycle with a spectrum/signal analyzer or EMC receiver can be used in zero-span mode if the response time and spacing between bins on the sweep are sufficient to permit accurate measurement of the burst on/off time of the transmitted signal.

5.2.2.2 Constant burst duty cycle

If the measured burst duty cycle is constant (i.e., duty cycle variations are less than ± 2 percent), then:

- a) Set span to at least 1.5 times the OBW.
- b) Set RBW = 1-5% of the OBW, not to exceed 1 MHz.
- c) Set VBW $\geq 3 \times$ RBW.
- d) Number of points in sweep $\geq 2 \times$ span / RBW. (This gives bin-to-bin spacing \leq RBW/2, so that narrowband signals are not lost between frequency bins.)
- e) Sweep time = auto.
- f) Detector = RMS (power averaging).
- g) Set sweep trigger to "free run".
- h) Trace average at least 100 traces in power averaging (i.e., RMS) mode.
- i) Compute power by integrating the spectrum across the OBW of the signal using the instrument's band power measurement function with band limits set equal to the OBW band edges. If the instrument does not have a band power function, sum the spectrum levels (in power units) at intervals equal to the RBW extending across the entire OBW of the spectrum.
- j) Add $10 \log (1/x)$, where x is the duty cycle, to the measured power in order to compute the average power during the actual transmission times (because the measurement represents an average over both the on and off times of the transmission).

For example, add $10 \log (1/0.25) = 6$ dB if the duty cycle is a constant 25%.

3.4 OCCUPIED BANDWIDTH.

Test set-up

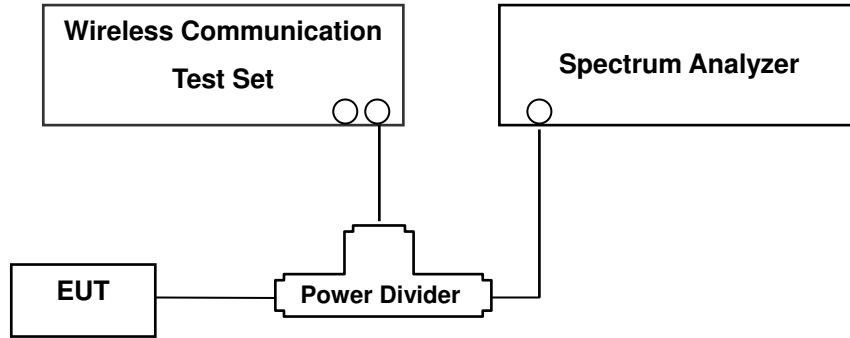

(Configuration of conducted Emission measurement)

The width of a frequency band such that, below the lower and above the upper frequency limits, the mean powers emitted are each equal to a specified percentage 0.5 % of the total mean power of a given emission.

Test Procedure

OBW is tested in accordance with KDB971168 D01 Power Meas License Digital Systems v02r02, October 17, 2014, Section 4.2.

The EUT makes a call to the communication simulator. The power was measured with R&S Spectrum Analyzer. All measurements were done at 3 channels(low, middle and high operational range.)

The conducted occupied bandwidth used the power splitter via EUT RF power connector between simulation base station and spectrum analyzer.

The communication simulator station system controlled a EUT to export maximum output power under transmission mode and specific channel frequency. Use OBW measurement function of Spectrum analyzer to measure 99 % occupied bandwidth

3.5 SPURIOUS AND HARMONIC EMISSIONS AT ANTENNA TERMINAL.

Test Procedure

Spurious and harmonic emissions at antenna terminal is tested in accordance with KDB971168 D01 Power Meas License Digital Systems v02r02, October 17, 2014, Section 6.0.

The level of the carrier and the various conducted spurious and harmonic frequencies is measured by means of a calibrated spectrum analyzer.

The EUT was setup to maximum output power at its lowest channel. The Resolution BW of the analyzer is set to 1 % of the emission bandwidth to show compliance with the -13 dBm limit, in the 1 MHz bands immediately outside and adjacent to the edge of the frequency block. The 1 MHz RBW was used to scan from 30 MHz to 10th Harmonics. A display line was placed at -13 dBm to show compliance. The high, lowest and a middle channel were tested for out of band measurements.

- Band Edge Requirement : In the 1MHz bands immediately outside and adjacent to the frequency block, a resolution bandwidth of at least 1 percent of the emission bandwidth of the fundamental emission of the transmitter may be employed to measure the out of band Emissions. Limit, -13 dBm.

NOTES: The analyzer plot offsets were determined by below conditions.

- For LTE Band 2, total offset 27.7 dBm = 20 dBm attenuator + 6 dBm Divider + 1.7 dBm RF cables.
- For LTE Band 5, total offset 27.1 dB = 20 dB attenuator + 6 dB Divider + 1.1 dB RF cables.

3.6 FREQUENCY STABILITY / VARIATION OF AMBIENT TEMPERATURE

Test Set-up

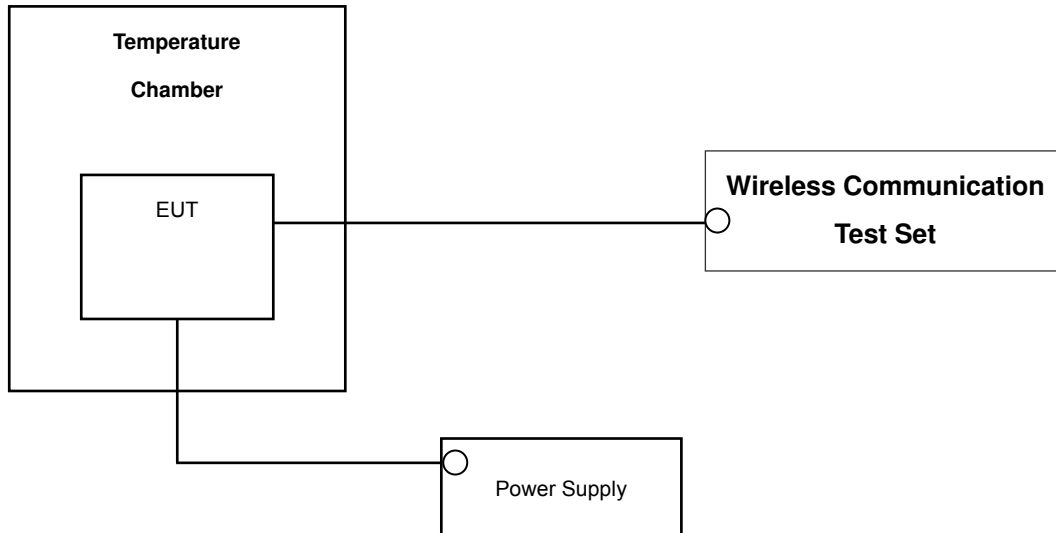

* Nominal Operating Voltage

Test Procedure

Frequency stability is tested in accordance with ANSI/TIA-603-D-2010 section 2.2.2

The frequency stability of the transmitter is measured by:

- a.) **Temperature:** The temperature is varied from - 30 °C to + 50 °C using an environmental chamber.
- b.) **Primary Supply Voltage:** The primary supply voltage is varied from the end point to 100 % of the voltage normally at the input to the device or at the power supply terminals if cables are not normally supplied.

Specification — the frequency stability shall be sufficient to ensure that the fundamental emission stays within the authorized frequency block(LTE Band2). The frequency stability of the transmitter shall be maintained within ± 0.00025 % (± 2.5 ppm) of the center frequency. (LTE Band5).

Time Period and Procedure:

The carrier frequency of the transmitter is measured at room temperature (20°C to provide a reference).

1. The equipment is turned on in a “standby” condition for one minute before applying power to the transmitter. Measurement of the carrier frequency of the transmitter is made within one minute after applying power to the transmitter.
2. Frequency measurements are made at 10°C intervals ranging from -30°C to +50°C. A period of at least one half-hour is provided to allow stabilization of the equipment at each temperature level.

NOTE: The EUT is tested down to the battery endpoint.

4. LIST OF TEST EQUIPMENT

Manufacture	Model/ Equipment	Serial Number	Calibration Interval	Calibration Due
Agilent	N1921A/ Power Sensor	MY45241059	Annual	07/09/2016
Agilent	N1911A/ Power Meter	MY45100523	Annual	07/09/2016
MITEQ	AMF-6D-001180-35-20P/AMP	1081666	Annual	09/03/2016
Wainwright	WHK1.2/15G-10EF/H.P.F	4	Annual	04/27/2016
Wainwright	WHK3.3/18G-10EF/H.P.F	2	Annual	04/27/2016
Hewlett Packard	11667B / Power Splitter	10545	Annual	02/16/2016
Hewlett Packard	11667B / Power Splitter	11275	Annual	04/29/2016
ITECH	IT6720/ Power Supply	0100215626700119	Annual	11/02/2016
Schwarzbeck	UHAP/ Dipole Antenna	557	Biennial	03/23/2017
Schwarzbeck	UHAP/ Dipole Antenna	558	Biennial	03/23/2017
EXP	EX-TH400/ Chamber	None	Annual	05/29/2016
Schwarzbeck	BBHA 9120D/ Horn Antenna	147	Biennial	09/01/2016
Schwarzbeck	BBHA 9120D/ Horn Antenna	1299	Biennial	05/15/2017
Schwarzbeck	BBHA 9170/ Horn Antenna(15~40GHz)	BBHA9170342	Biennial	04/30/2017
Schwarzbeck	BBHA 9170/ Horn Antenna(15~35GHz)	BBHA9170124	Biennial	04/30/2017
Agilent	N9020A/Signal Analyzer	MY52090906	Annual	05/15/2016
Hewlett Packard	8493C/ATTENUATOR	17280	Annual	06/29/2016
REOHDE&SCHWARZ	FSV40/Spectrum Analyzer	1307.9002K40-100931-NK	Annual	06/04/2016
Agilent	8960 (E5515C)/ Base Station	MY48360800	Annual	10/30/2016
Anritsu Corp.	MT8820C/Wideband Radio Communication Tester	6201041449	Annual	07/28/2016

5. SUMMARY OF TEST RESULTS

FCC Part Section(s)	Test Description	Test Limit	Test Condition	Test Result
2.1049	Occupied Bandwidth	N/A	CONDUCTED	PASS
2.1051, 22.917(a), 24.238(a)	Band Edge / Spurious and Harmonic Emissions at Antenna Terminal.	< 43 + 10log ₁₀ (P[Watts]) at Band Edge and for all out-of-band emissions		PASS
2.1046	*Conducted Output Power	N/A		PASS
24.232(d)	Peak- to- Average Ratio	< 13 dB		PASS
2.1055, 22.355	Frequency stability / variation of ambient temperature	< 2.5 ppm (Part22)		PASS
24.235		Emission must remain in band (Part24)		
22.913(a)(2)	Effective Radiated Power (Band 5)	< 7 Watts max. ERP	RADIATED	PASS
24.232(c)	Equivalent Isotropic Radiated Power (Band 2)	< 2 Watts max. EIRP		PASS
2.1053, 22.917(a), 24.238(a)	Radiated Spurious and Harmonic Emissions	< 43 + 10log ₁₀ (P[Watts]) for all out-of band emissions		PASS

*See SAR Report

6. SAMPLE CALCULATION

A. ERP Sample Calculation

Mode	Ch./ Freq.		Measured Level(dBm)	Substitute LEVEL(dBm)	Ant. Gain (dBd)	C.L	Pol.	ERP	
	channel	Freq.(MHz)						W	dBm
LTE Band5	20525	836.60	-6.73	40.89	-10.54	0.96	V	0.869	29.39

ERP = SubstituteLEVEL(dBm) + Ant. Gain – CL(Cable Loss)

- 1) The EUT mounted on a wooden tripod is 2.5 meter above test site ground level.
- 2) During the test , the turn table is rotated and the antenna height is found.
- 3) Record the field strength meter’s level.
- 4) Replace the EUT with dipole/Horn antenna that is connected to a calibrated signal generator.
- 5) Increase the signal generator output till the field strength meter’s level is equal to the item (3).
- 6) The signal generator output level with Ant. Gain and cable loss are the rating of effective radiated power (**ERP**).

B. Emission Designator

QPSK Modulation

5MHz Bandwidth

Emission Designator = 4M48G7D

LTE BW = 4.48 MHz

G = Phase Modulation

7 = Quantized/Digital Info

D = Data transmission; telemetry; telecommand

10MHz Bandwidth

Emission Designator = 8M95G7D

LTE BW = 8.95 MHz

G = Phase Modulation

7 = Quantized/Digital Info

D = Data transmission; telemetry; telecommand

16QAM Modulation

5MHz Bandwidth

Emission Designator = 4M48W7D

LTE BW = 4.48 MHz

W = main carrier modulated in a combination of two or more of the following modes;
amplitude, angle, pulse

7 = Quantized/Digital Info

D = Data transmission; telemetry; telecommand

10MHz Bandwidth

Emission Designator = 8M95W7D

LTE BW = 8.95 MHz

W = main carrier modulated in a combination of two or more of the following modes;
amplitude, angle, pulse

7 = Quantized/Digital Info

D = Data transmission; telemetry; telecommand

7. TEST DATA

7.1 EQUIVALENT ISOTROPIC RADIATED POWER (Band 2)

Freq (MHz)	Bandwidth	Modulation	Measured Level (dBm)	Substitute Level (dBm)	Ant. Gain(dBi)	C.L	Pol	EIRP	
								W	dBm
1850.7	1.4 MHz	QPSK	-21.00	11.69	10.04	1.36	H	0.109	20.37
		16-QAM	-21.87	10.82	10.04	1.36	H	0.089	19.50
1880.0		QPSK	-20.80	12.16	10.05	1.37	H	0.121	20.84
		16-QAM	-21.64	11.32	10.05	1.37	H	0.100	20.00
1909.3		QPSK	-21.83	11.37	10.06	1.38	H	0.101	20.05
		16-QAM	-22.65	10.55	10.06	1.38	H	0.084	19.23

Equivalent Isotropic Radiated Power Data (1.4 MHz Band 2 LTE)

Note: All of RB size has been tested for emissions and EIRP, with the 1RB configuration observed as the worst case

Freq (MHz)	Bandwidth	Modulation	Measured Level (dBm)	Substitute Level (dBm)	Ant. Gain(dBi)	C.L	Pol	EIRP	
								W	dBm
1851.5	3 MHz	QPSK	-21.00	11.69	10.04	1.36	H	0.109	20.37
		16-QAM	-21.88	10.81	10.04	1.36	H	0.089	19.49
1880.0		QPSK	-20.78	12.18	10.05	1.37	H	0.122	20.86
		16-QAM	-21.71	11.25	10.05	1.37	H	0.098	19.93
1908.5		QPSK	-21.86	11.31	10.06	1.38	H	0.100	19.99
		16-QAM	-22.70	10.47	10.06	1.38	H	0.082	19.15

Equivalent Isotropic Radiated Power Data (3 MHz Band 2 LTE)

Note: All of RB size has been tested for emissions and EIRP, with the 1RB configuration observed as the worst case

Freq (MHz)	Bandwidth	Modulation	Measured Level (dBm)	Substitute Level (dBm)	Ant. Gain(dBi)	C.L	Pol	EIRP	
								W	dBm
1852.5	5 MHz	QPSK	-20.95	11.74	10.04	1.36	H	0.110	20.42
		16-QAM	-21.82	10.87	10.04	1.36	H	0.090	19.55
1880.0		QPSK	-20.88	12.08	10.05	1.37	H	0.119	20.76
		16-QAM	-21.77	11.19	10.05	1.37	H	0.097	19.87
1907.5		QPSK	-21.48	11.66	10.06	1.38	H	0.108	20.34
		16-QAM	-22.35	10.79	10.06	1.38	H	0.088	19.47

Equivalent Isotropic Radiated Power Data (5 MHz Band 2 LTE)

Note: All of RB size has been tested for emissions and EIRP, with the 1RB configuration observed as the worst case

Freq (MHz)	Bandwidth	Modulation	Measured Level (dBm)	Substitute Level (dBm)	Ant. Gain(dBi)	C.L	Pol	EIRP	
								W	dBm
1855.0	10 MHz	QPSK	-20.98	11.71	10.04	1.36	H	0.109	20.39
		16-QAM	-21.84	10.85	10.04	1.36	H	0.090	19.53
1880.0		QPSK	-20.57	12.38	10.05	1.37	H	0.128	21.06
		16-QAM	-21.47	11.48	10.05	1.37	H	0.104	20.16
1905.0		QPSK	-21.68	11.38	10.05	1.38	H	0.101	20.05
		16-QAM	-22.51	10.55	10.05	1.38	H	0.083	19.22

Equivalent Isotropic Radiated Power Data (10 MHz Band 2 LTE)

Note: All of RB size has been tested for emissions and EIRP, with the 1RB configuration observed as the worst case

Freq (MHz)	Bandwidth	Modulation	Measured Level (dBm)	Substitute Level (dBm)	Ant. Gain(dBi)	C.L	Pol	EIRP	
								W	dBm
1857.5	15 MHz	QPSK	-21.00	11.69	10.04	1.36	H	0.109	20.37
		16-QAM	-21.83	10.86	10.04	1.36	H	0.090	19.54
1880.0		QPSK	-20.71	12.23	10.04	1.36	H	0.123	20.91
		16-QAM	-21.60	11.34	10.04	1.36	H	0.100	20.02
1902.5		QPSK	-21.30	11.75	10.05	1.38	H	0.110	20.42
		16-QAM	-22.10	10.95	10.05	1.38	H	0.092	19.62

Equivalent Isotropic Radiated Power Data (15 MHz Band 2 LTE)

Note: All of RB size has been tested for emissions and EIRP, with the 1RB configuration observed as the worst case

Freq (MHz)	Bandwidth	Modulation	Measured Level (dBm)	Substitute Level (dBm)	Ant. Gain(dBi)	C.L	Pol	EIRP	
								W	dBm
1860.0	20 MHz	QPSK	-20.83	11.86	10.04	1.36	H	0.113	20.54
		16-QAM	-21.68	11.01	10.04	1.36	H	0.093	19.69
1880.0		QPSK	-20.62	12.31	10.04	1.36	H	0.126	20.99
		16-QAM	-21.51	11.42	10.04	1.36	H	0.102	20.10
1900.0		QPSK	-20.92	12.14	10.05	1.38	H	0.121	20.81
		16-QAM	-21.69	11.37	10.05	1.38	H	0.101	20.04

Equivalent Isotropic Radiated Power Data (20 MHz Band 2 LTE)

Note: All of RB size has been tested for emissions and EIRP, with the 1RB configuration observed as the worst case

NOTES:

Equivalent Isotropic Radiated Power Measurements by Substitution Method

according to ANSI/TIA/EIA-603-D-2010 June 24, 2010:

The EUT was placed on a non-conductive styrofoam resin table 3-meters from the receive antenna. Turntable rotation was adjusted for the highest reading on the receive spectrum analyzer. For LTE signals, RBW = 1-5% of the OBW, not to exceed 1MHz, VBW ≥ 3 x RBW, Detector = RMS. A Horn antenna was substituted in place of the EUT. This Horn antenna was driven by a signal generator and the level of the signal generator was adjusted to obtain the same receive spectrum analyzer reading. The conducted power at the terminals of the Horn antenna is measured. The difference between the gain of the horn and an isotropic antenna is

taken into consideration and the EIRP is recorded.

Also, we have done x, y, z planes in EUT and horizontal and vertical polarization in detecting antenna. The worst case of the EUT is x plane in LTE mode. Also worst case of detecting Antenna is horizontal polarization in LTE mode.

7.2 EFFECTIVE RADIATED POWER (Band 5)

Freq (MHz)	Bandwidth	Modulation	Measured Level (dBm)	Substitute Level (dBm)	Ant. Gain(dBd)	C.L	Pol	ERP	
								W	dBm
824.7	1.4 MHz	QPSK	-32.29	29.64	-10.59	0.88	V	0.066	18.17
		16-QAM	-32.93	29.00	-10.59	0.88	V	0.057	17.53
836.5		QPSK	-33.16	28.60	-10.54	0.89	V	0.052	17.17
		16-QAM	-33.76	28.00	-10.54	0.89	V	0.045	16.57
848.3		QPSK	-33.82	27.14	-10.49	0.89	V	0.038	15.76
		16-QAM	-34.54	26.42	-10.49	0.89	V	0.032	15.04

Effective Radiated Power Data (1.4 MHz Band 5 LTE)

Note: All of RB size has been tested for emissions and ERP, with the 1RB configuration observed as the worst case

Freq (MHz)	Bandwidth	Modulation	Measured Level (dBm)	Substitute Level (dBm)	Ant. Gain(dBd)	C.L	Pol	ERP	
								W	dBm
825.5	3 MHz	QPSK	-32.08	29.85	-10.59	0.88	V	0.069	18.38
		16-QAM	-32.91	29.02	-10.59	0.88	V	0.057	17.55
836.5		QPSK	-33.29	28.41	-10.54	0.89	V	0.050	16.98
		16-QAM	-33.93	27.77	-10.54	0.89	V	0.043	16.34
847.5		QPSK	-33.59	27.48	-10.50	0.89	V	0.041	16.09
		16-QAM	-34.35	26.72	-10.50	0.89	V	0.034	15.33

Effective Radiated Power Data (3 MHz Band 5 LTE)

Note: All of RB size has been tested for emissions and ERP, with the 1RB configuration observed as the worst case

Freq (MHz)	Bandwidth	Modulation	Measured Level (dBm)	Substitute Level (dBm)	Ant. Gain(dBd)	C.L	Pol	ERP	
								W	dBm
826.5	5 MHz	QPSK	-32.23	29.68	-10.59	0.88	V	0.066	18.21
		16-QAM	-32.86	29.05	-10.59	0.88	V	0.057	17.58
836.5		QPSK	-33.14	28.61	-10.55	0.89	V	0.052	17.17
		16-QAM	-33.91	27.84	-10.55	0.89	V	0.044	16.40
846.5		QPSK	-33.46	27.93	-10.51	0.89	V	0.045	16.53
		16-QAM	-34.13	27.26	-10.51	0.89	V	0.039	15.86

Effective Radiated Power Data (5 MHz Band 5 LTE)

Note: All of RB size has been tested for emissions and ERP, with the 1RB configuration observed as the worst case

Freq (MHz)	Bandwidth	Modulation	Measured Level (dBm)	Substitute Level (dBm)	Ant. Gain(dBd)	C.L	Pol	ERP	
								W	dBm
829.0	10 MHz	QPSK	-32.17	29.71	-10.59	0.88	V	0.067	18.24
		16-QAM	-32.96	28.92	-10.59	0.88	V	0.056	17.45
836.5		QPSK	-32.83	29.07	-10.56	0.89	V	0.058	17.62
		16-QAM	-33.61	28.29	-10.56	0.89	V	0.048	16.84
844.0		QPSK	-33.58	27.94	-10.52	0.89	V	0.045	16.53
		16-QAM	-34.11	27.41	-10.52	0.89	V	0.040	16.00

Effective Radiated Power Data (10 MHz Band 5 LTE)

Note: All of RB size has been tested for emissions and ERP, with the 1RB configuration observed as the worst case

NOTES:

Effective Radiated Power Output Measurements by Substitution Method

according to ANSI/TIA/EIA-603-D-2010 June 24, 2010:

The EUT was placed on a non-conductive styrofoam resin table 3-meters from the receive antenna. The receive antenna height and turntable rotation was adjusted for the highest reading on the receive spectrum analyzer. For LTE signals, RBW = 1-5% of the OBW, not to exceed 1MHz, VBW ≥ 3 x RBW, Detector = RMS. A half-wave dipole was substituted in place of the EUT. This dipole antenna was driven by a signal generator and the level of the signal generator was adjusted to obtain the same receive spectrum analyzer reading. The conducted power at the terminals of the dipole is measured. The ERP is recorded.

Also, we have done x, y, z planes in EUT and horizontal and vertical polarization in detecting antenna. The worst case of the EUT is y plane in LTE mode. Also worst case of detecting Antenna is vertical polarization in LTE mode.

7.3 RADIATED SPURIOUS EMISSIONS

7.3.1 RADIATED SPURIOUS EMISSIONS (1.4 MHz Band 2 LTE)

- ▣ OPERATING FREQUENCY: 1880.00 MHz
- ▣ MEASURED OUTPUT POWER: 20.84 dBm = 0.121 W
- ▣ MODULATION SIGNAL: 1.4 MHz QPSK
- ▣ DISTANCE: 3 meters
- ▣ LIMIT: $43 + 10 \log_{10}(W) =$ 33.84 dBc

Ch	Freq (MHz)	Measured Level (dBm)	Ant. Gain (dBi)	Substitute Level (dBm)	C.L	Pol	EIRP (dBm)	dBc
18607 (1850.7)	3,701.40	-46.55	12.32	-50.21	2.02	H	-39.91	60.75
	5,552.10	-51.11	13.02	-49.99	2.52	H	-39.49	60.33
	7,402.80	-60.09	11.06	-50.72	2.91	H	-42.57	63.41
18900 (1880.0)	3,760.00	-49.97	12.29	-53.57	1.93	H	-43.21	64.05
	5,640.00	-50.76	13.12	-49.83	2.57	H	-39.28	60.12
	7,520.00	-58.72	11.09	-49.88	3.03	H	-41.82	62.66
19193 (1909.3)	3,818.60	-46.81	12.28	-49.84	2.04	H	-39.60	60.44
	5,727.90	-48.08	13.06	-46.89	2.55	H	-36.38	57.22
	7,637.20	-59.34	11.37	-49.90	3.13	H	-41.66	62.50

- NOTES:**
1. Radiated Spurious Emission Measurements at 3 meters by Substitution Method according to ANSI/TIA/EIA-603-D-2010 June 24, 2010:
 2. We are performed all frequency to 10th harmonics from 30 MHz. Measurements above show only up to 3 maximum emissions noted, or would be lesser if no specific emissions from the EUT are recorded (ie: margin > 20 dB from the applicable limit) and considered that's already beyond the background noise floor.
 3. We have done x, y, z planes in EUT and horizontal and vertical polarization in detecting antenna.
 4. All of RB size has been tested for emissions and EIRP, with the 1RB configuration observed as the worst case
 5. We are performed 16QAM and QPSK modulations. The worst case data are reported in the table above.

7.3.2 RADIATED SPURIOUS EMISSIONS (3 MHz Band 2 LTE)

- ▣ OPERATING FREQUENCY: 1880.00 MHz
- ▣ MEASURED OUTPUT POWER: 20.86 dBm = 0.122 W
- ▣ MODULATION SIGNAL: 3 MHz QPSK
- ▣ DISTANCE: 3 meters
- ▣ LIMIT: $43 + 10 \log_{10}(W) =$ 33.86 dBc

Ch	Freq (MHz)	Measured Level (dBm)	Ant. Gain (dBi)	Substitute Level (dBm)	C.L	Pol	EIRP (dBm)	dBc
18615 (1851.5)	3,703.00	-45.75	12.32	-49.39	2.02	H	-39.09	59.95
	5,554.50	-51.86	13.03	-50.75	2.52	H	-40.24	61.10
	7,406.00	-59.58	11.05	-50.14	2.92	H	-42.01	62.87
18900 (1880.0)	3,760.00	-48.17	12.29	-51.77	1.93	H	-41.41	62.27
	5,640.00	-50.39	13.12	-49.45	2.57	H	-38.90	59.76
	7,520.00	-59.81	11.09	-50.97	3.03	H	-42.91	63.77
19185 (1908.5)	3,817.00	-49.31	12.28	-52.42	2.04	H	-42.18	63.04
	5,725.50	-47.99	13.07	-46.80	2.56	H	-36.29	57.15
	7,634.00	-60.15	11.37	-50.70	3.16	H	-42.49	63.35

- NOTES:**
1. Radiated Spurious Emission Measurements at 3 meters by Substitution Method according to ANSI/TIA/EIA-603-D-2010 June 24, 2010:
 2. We are performed all frequency to 10th harmonics from 30 MHz. Measurements above show only up to 3 maximum emissions noted, or would be lesser if no specific emissions from the EUT are recorded (ie: margin > 20 dB from the applicable limit) and considered that's already beyond the background noise floor.
 3. We have done x, y, z planes in EUT and horizontal and vertical polarization in detecting antenna.
 4. All of RB size has been tested for emissions and EIRP, with the 1RB configuration observed as the worst case
 5. We are performed 16QAM and QPSK modulations. The worst case data are reported in the table above.

7.3.3 RADIATED SPURIOUS EMISSIONS (5 MHz Band 2 LTE)

- ▣ OPERATING FREQUENCY: 1880.00 MHz
- ▣ MEASURED OUTPUT POWER: 20.76 dBm = 0.119 W
- ▣ MODULATION SIGNAL: 5 MHz QPSK
- ▣ DISTANCE: 3 meters
- ▣ LIMIT: $43 + 10 \log_{10}(W) =$ 33.76 dBc

Ch	Freq (MHz)	Measured Level (dBm)	Ant. Gain (dBi)	Substitute Level (dBm)	C.L	Pol	EIRP (dBm)	dBc
18625 (1852.5)	3,705.00	-45.83	12.32	-49.46	2.01	H	-39.15	59.91
	5,557.50	-51.09	13.04	-49.97	2.53	H	-39.46	60.22
	7,410.00	-59.12	11.05	-49.62	2.92	H	-41.49	62.25
18900 (1880.0)	3,760.00	-46.15	12.29	-49.75	1.93	H	-39.39	60.15
	5,640.00	-51.69	13.12	-50.76	2.57	H	-40.21	60.97
	7,520.00	-59.59	11.09	-50.75	3.03	H	-42.69	63.45
19175 (1907.5)	3,815.00	-50.22	12.29	-53.43	2.04	H	-43.18	63.94
	5,722.50	-49.64	13.08	-48.45	2.57	H	-37.94	58.70
	7,630.00	-59.66	11.36	-50.20	3.19	H	-42.03	62.79

- NOTES:**
1. Radiated Spurious Emission Measurements at 3 meters by Substitution Method according to ANSI/TIA/EIA-603-D-2010 June 24, 2010:
 2. We are performed all frequency to 10th harmonics from 30 MHz. Measurements above show only up to 3 maximum emissions noted, or would be lesser if no specific emissions from the EUT are recorded (ie: margin > 20 dB from the applicable limit) and considered that's already beyond the background noise floor.
 3. We have done x, y, z planes in EUT and horizontal and vertical polarization in detecting antenna.
 4. All of RB size has been tested for emissions and EIRP, with the 1RB configuration observed as the worst case
 5. We are performed 16QAM and QPSK modulations. The worst case data are reported in the table above.

7.3.4 RADIATED SPURIOUS EMISSIONS (10 MHz Band 2 LTE)

- ▣ OPERATING FREQUENCY: 1880.00 MHz
- ▣ MEASURED OUTPUT POWER: 21.06 dBm = 0.128 W
- ▣ MODULATION SIGNAL: 10 MHz QPSK
- ▣ DISTANCE: 3 meters
- ▣ LIMIT: $43 + 10 \log_{10}(W) =$ 34.06 dBc

Ch	Freq (MHz)	Measured Level (dBm)	Ant. Gain (dBi)	Substitute Level (dBm)	C.L	Pol	EIRP (dBm)	dBc
18650 (1855.0)	3,710.00	-45.87	12.31	-49.45	1.99	H	-39.13	60.19
	5,565.00	-52.51	13.05	-51.35	2.51	H	-40.81	61.87
	7,420.00	-59.68	11.05	-50.20	2.93	H	-42.08	63.14
18900 (1880.0)	3,760.00	-44.34	12.29	-47.94	1.93	H	-37.58	58.64
	5,640.00	-52.38	13.12	-51.45	2.57	H	-40.90	61.96
	7,520.00	-58.87	11.09	-50.03	3.03	H	-41.97	63.03
19150 (1905.0)	3,810.00	-47.36	12.29	-50.81	2.03	H	-40.55	61.61
	5,715.00	-50.08	13.10	-48.74	2.54	H	-38.18	59.24
	7,620.00	-58.92	11.33	-49.58	3.08	H	-41.33	62.39

- NOTES:**
1. Radiated Spurious Emission Measurements at 3 meters by Substitution Method according to ANSI/TIA/EIA-603-D-2010 June 24, 2010:
 2. We are performed all frequency to 10th harmonics from 30 MHz. Measurements above show only up to 3 maximum emissions noted, or would be lesser if no specific emissions from the EUT are recorded (ie: margin > 20 dB from the applicable limit) and considered that's already beyond the background noise floor.
 3. We have done x, y, z planes in EUT and horizontal and vertical polarization in detecting antenna.
 4. All of RB size has been tested for emissions and EIRP, with the 1RB configuration observed as the worst case
 5. We are performed 16QAM and QPSK modulations. The worst case data are reported in the table above.

7.3.5 RADIATED SPURIOUS EMISSIONS (15 MHz Band 2 LTE)

- ▣ OPERATING FREQUENCY: 1880.00 MHz
- ▣ MEASURED OUTPUT POWER: 20.91 dBm = 0.123 W
- ▣ MODULATION SIGNAL: 15 MHz QPSK
- ▣ DISTANCE: 3 meters
- ▣ LIMIT: $43 + 10 \log_{10}(W) =$ 33.91 dBc

Ch	Freq (MHz)	Measured Level (dBm)	Ant. Gain (dBi)	Substitute Level (dBm)	C.L	Pol	EIRP (dBm)	dBc
18675 (1857.5)	3,715.00	-45.03	12.31	-48.72	2.03	H	-38.44	59.35
	5,572.50	-51.57	13.06	-50.35	2.50	H	-39.79	60.70
	7,430.00	-59.81	11.04	-50.65	2.92	H	-42.53	63.44
18900 (1880.0)	3,760.00	-46.16	12.29	-49.76	1.93	H	-39.40	60.31
	5,640.00	-54.65	13.12	-53.72	2.57	H	-43.17	64.08
	7,520.00	-59.65	11.09	-50.81	3.03	H	-42.75	63.66
19125 (1902.5)	3,805.00	-45.04	12.30	-48.41	2.04	H	-38.15	59.06
	5,707.50	-51.35	13.12	-49.94	2.51	H	-39.33	60.24
	7,610.00	-57.95	11.31	-48.82	3.09	H	-40.60	61.51

- NOTES:**
1. Radiated Spurious Emission Measurements at 3 meters by Substitution Method according to ANSI/TIA/EIA-603-D-2010 June 24, 2010:
 2. We are performed all frequency to 10th harmonics from 30 MHz. Measurements above show only up to 3 maximum emissions noted, or would be lesser if no specific emissions from the EUT are recorded (ie: margin > 20 dB from the applicable limit) and considered that's already beyond the background noise floor.
 3. We have done x, y, z planes in EUT and horizontal and vertical polarization in detecting antenna.
 4. All of RB size has been tested for emissions and EIRP, with the 1RB configuration observed as the worst case
 5. We are performed 16QAM and QPSK modulations. The worst case data are reported in the table above.

7.3.6 RADIATED SPURIOUS EMISSIONS (20 MHz Band 2 LTE)

- ▣ OPERATING FREQUENCY: 1880.00 MHz
- ▣ MEASURED OUTPUT POWER: 20.99 dBm = 0.126 W
- ▣ MODULATION SIGNAL: 20 MHz QPSK
- ▣ DISTANCE: 3 meters
- ▣ LIMIT: $43 + 10 \log_{10}(W) =$ 33.99 dBc

Ch	Freq (MHz)	Measured Level (dBm)	Ant. Gain (dBi)	Substitute Level (dBm)	C.L	Pol	EIRP (dBm)	dBc
18700 (1860.0)	3,720.00	-43.85	12.31	-47.64	2.07	H	-37.40	58.39
	5,580.00	-51.83	13.07	-50.55	2.51	H	-39.99	60.98
	7,440.00	-58.52	11.04	-49.21	2.92	V	-41.09	62.08
18900 (1880.0)	3,760.00	-41.93	12.29	-45.53	1.93	H	-35.17	56.16
	5,640.00	-52.32	13.12	-51.39	2.57	H	-40.84	61.83
	7,520.00	-58.99	11.09	-50.15	3.03	V	-42.09	63.08
19100 (1900.0)	3,800.00	-44.75	12.30	-48.04	2.04	H	-37.78	58.77
	5,700.00	-47.38	13.13	-46.20	2.52	H	-35.59	56.58
	7,600.00	-59.24	11.29	-50.00	3.05	V	-41.76	62.75

- NOTES:**
1. Radiated Spurious Emission Measurements at 3 meters by Substitution Method according to ANSI/TIA/EIA-603-D-2010 June 24, 2010:
 2. We are performed all frequency to 10th harmonics from 30 MHz. Measurements above show only up to 3 maximum emissions noted, or would be lesser if no specific emissions from the EUT are recorded (ie: margin > 20 dB from the applicable limit) and considered that's already beyond the background noise floor.
 3. We have done x, y, z planes in EUT and horizontal and vertical polarization in detecting antenna.
 4. All of RB size has been tested for emissions and EIRP, with the 1RB configuration observed as the worst case
 5. We are performed 16QAM and QPSK modulations. The worst case data are reported in the table above.

7.3.7 RADIATED SPURIOUS EMISSIONS (1.4 MHz Band 5 LTE)

- ▣ OPERATING FREQUENCY: 824.70 MHz
- ▣ MEASURED OUTPUT POWER: 18.17 dBm = 0.066 W
- ▣ MODULATION SIGNAL: 1.4 MHz QPSK
- ▣ DISTANCE: 3 meters
- ▣ LIMIT: $43 + 10 \log_{10}(W) =$ 31.17 dBc

Ch	Freq (MHz)	Measured Level (dBm)	Ant. Gain (dBd)	Substitute Level (dBm)	C.L	Pol	ERP (dBm)	dBc
20407 (824.7)	1,649.40	-55.91	9.71	-63.95	1.29	H	-55.53	73.70
	2,474.10	-53.61	10.54	-58.73	1.60	V	-49.79	67.96
	3,298.80	-57.13	12.23	-62.21	1.85	V	-51.83	70.00
20525 (836.5)	1,673.00	-58.80	9.78	-66.97	1.28	V	-58.47	76.64
	2,509.50	-53.01	10.65	-58.01	1.61	V	-48.97	67.14
	3,346.00	-58.34	12.41	-63.82	1.86	V	-53.27	71.44
20643 (848.3)	1,696.60	-61.04	9.84	-69.26	1.30	V	-60.72	78.89
	2,544.90	-56.52	10.72	-61.41	1.63	H	-52.32	70.49
	3,393.20	-55.18	12.40	-60.47	1.87	V	-49.94	68.11

- NOTES:**
1. Radiated Spurious Emission Measurements at 3 meters by Substitution Method according to ANSI/TIA/EIA-603-D-2010 June 24, 2010:
 2. We are performed all frequency to 10th harmonics from 30 MHz. Measurements above show only up to 3 maximum emissions noted, or would be lesser if no specific emissions from the EUT are recorded (ie: margin > 20 dB from the applicable limit) and considered that's already beyond the background noise floor.
 3. We have done x, y, z planes in EUT and horizontal and vertical polarization in detecting antenna.
 4. All of RB size has been tested for emissions and ERP, with the 1RB configuration observed as the worst case
 5. We are performed 16QAM and QPSK modulations. The worst case data are reported in the table above.

7.3.8 RADIATED SPURIOUS EMISSIONS (3 MHz Band 5 LTE)

- ▣ OPERATING FREQUENCY: 825.50 MHz
- ▣ MEASURED OUTPUT POWER: 18.38 dBm = 0.069 W
- ▣ MODULATION SIGNAL: 3 MHz QPSK
- ▣ DISTANCE: 3 meters
- ▣ LIMIT: $43 + 10 \log_{10}(W) =$ 31.38 dBc

Ch	Freq (MHz)	Measured Level (dBm)	Ant. Gain (dBd)	Substitute Level (dBm)	C.L	Pol	ERP (dBm)	dBc
20415 (825.5)	1,651.00	-59.36	9.71	-67.40	1.29	H	-58.98	77.36
	2,476.50	-56.62	10.54	-61.69	1.61	H	-52.76	71.14
	3,302.00	-57.22	12.25	-62.35	1.85	H	-51.95	70.33
20525 (836.5)	1,673.00	-59.93	9.78	-68.10	1.28	H	-59.60	77.98
	2,509.50	-56.82	10.65	-61.82	1.61	H	-52.78	71.16
	3,346.00	-59.39	12.41	-64.87	1.86	H	-54.32	72.70
20635 (847.5)	1,695.00	-59.64	9.84	-67.88	1.30	V	-59.34	77.72
	2,542.50	-58.12	10.72	-62.98	1.63	H	-53.89	72.27
	3,390.00	-57.31	12.40	-62.54	1.84	H	-51.98	70.36

- NOTES:**
1. Radiated Spurious Emission Measurements at 3 meters by Substitution Method according to ANSI/TIA/EIA-603-D-2010 June 24, 2010:
 2. We are performed all frequency to 10th harmonics from 30 MHz. Measurements above show only up to 3 maximum emissions noted, or would be lesser if no specific emissions from the EUT are recorded (ie: margin > 20 dB from the applicable limit) and considered that's already beyond the background noise floor.
 3. We have done x, y, z planes in EUT and horizontal and vertical polarization in detecting antenna.
 4. All of RB size has been tested for emissions and ERP, with the 1RB configuration observed as the worst case
 5. We are performed 16QAM and QPSK modulations. The worst case data are reported in the table above.

7.3.9 RADIATED SPURIOUS EMISSIONS (5 MHz Band 5 LTE)

- ▣ OPERATING FREQUENCY: 826.50 MHz
- ▣ MEASURED OUTPUT POWER: 18.21 dBm = 0.066 W
- ▣ MODULATION SIGNAL: 5 MHz QPSK
- ▣ DISTANCE: 3 meters
- ▣ LIMIT: $43 + 10 \log_{10}(W) =$ 31.21 dBc

Ch	Freq (MHz)	Measured Level (dBm)	Ant. Gain (dBd)	Substitute Level (dBm)	C.L	Pol	ERP (dBm)	dBc
20425 (826.5)	1,653.00	-58.41	9.72	-66.46	1.29	H	-58.03	76.24
	2,479.50	-56.62	10.54	-61.64	1.61	H	-52.71	70.92
	3,306.00	-60.63	12.26	-65.82	1.86	H	-55.42	73.63
20525 (836.5)	1,673.00	-59.02	9.78	-67.19	1.28	H	-58.69	76.90
	2,509.50	-60.52	10.65	-65.52	1.61	H	-56.48	74.69
	3,346.00	-61.06	12.41	-66.54	1.86	H	-55.99	74.20
20625 (846.5)	1,693.00	-60.39	9.83	-68.64	1.30	H	-60.11	78.32
	2,539.50	-58.12	10.71	-62.94	1.63	H	-53.86	72.07
	3,386.00	-58.73	12.40	-64.12	1.84	H	-53.56	71.77

- NOTES:**
1. Radiated Spurious Emission Measurements at 3 meters by Substitution Method according to ANSI/TIA/EIA-603-D-2010 June 24, 2010:
 2. We are performed all frequency to 10th harmonics from 30 MHz. Measurements above show only up to 3 maximum emissions noted, or would be lesser if no specific emissions from the EUT are recorded (ie: margin > 20 dB from the applicable limit) and considered that's already beyond the background noise floor.
 3. We have done x, y, z planes in EUT and horizontal and vertical polarization in detecting antenna.
 4. All of RB size has been tested for emissions and ERP, with the 1RB configuration observed as the worst case
 5. We are performed 16QAM and QPSK modulations. The worst case data are reported in the table above.

7.3.10 RADIATED SPURIOUS EMISSIONS (10 MHz Band 5 LTE)

- ▣ OPERATING FREQUENCY: 829.00 MHz
- ▣ MEASURED OUTPUT POWER: 18.24 dBm = 0.067 W
- ▣ MODULATION SIGNAL: 10 MHz QPSK
- ▣ DISTANCE: 3 meters
- ▣ LIMIT: $43 + 10 \log_{10}(W) =$ 31.24 dBc

Ch	Freq (MHz)	Measured Level (dBm)	Ant. Gain (dBd)	Substitute Level (dBm)	C.L	Pol	ERP (dBm)	dBc
20450 (829.0)	1,658.00	-55.13	9.73	-63.20	1.28	H	-54.75	72.99
	2,487.00	-55.34	10.54	-60.32	1.62	H	-51.40	69.64
	3,316.00	-58.05	12.30	-63.36	1.89	H	-52.95	71.19
20525 (836.5)	1,673.00	-58.91	9.78	-67.08	1.28	H	-58.58	76.82
	2,509.50	-54.56	10.65	-59.56	1.61	H	-50.52	68.76
	3,346.00	-57.44	12.41	-62.92	1.86	H	-52.37	70.61
20600 (844.0)	1,688.00	-58.66	9.81	-66.90	1.30	H	-58.39	76.63
	2,532.00	-57.09	10.69	-61.86	1.62	H	-52.79	71.03
	3,376.00	-57.92	12.41	-63.45	1.85	H	-52.89	71.13

- NOTES:**
1. Radiated Spurious Emission Measurements at 3 meters by Substitution Method according to ANSI/TIA/EIA-603-D-2010 June 24, 2010:
 2. We are performed all frequency to 10th harmonics from 30 MHz. Measurements above show only up to 3 maximum emissions noted, or would be lesser if no specific emissions from the EUT are recorded (ie: margin > 20 dB from the applicable limit) and considered that's already beyond the background noise floor.
 3. We have done x, y, z planes in EUT and horizontal and vertical polarization in detecting antenna.
 4. All of RB size has been tested for emissions and ERP, with the 1RB configuration observed as the worst case
 5. We are performed 16QAM and QPSK modulations. The worst case data are reported in the table above.

7.4 PEAK-TO-AVERAGE RATIO

Band	Band Width	Frequency (MHz)	Modulation	Resource Block Size	Resource Block Offset	Data (dB)
2	1.4 MHz	1880.0	QPSK	6	0	4.94
			16-QAM	6	0	5.70
	3 MHz		QPSK	15	0	5.34
			16-QAM	15	0	6.07
	5 MHz		QPSK	25	0	5.34
			16-QAM	25	0	5.95
	10 MHz		QPSK	50	0	5.35
			16-QAM	50	0	5.92
	15 MHz		QPSK	75	0	5.07
			16-QAM	75	0	5.73
	20 MHz		QPSK	100	0	5.23
			16-QAM	100	0	5.91

- Plots of the EUT's Peak- to- Average Ratio are shown Page 60 ~ 65

7.5 OCCUPIED BANDWIDTH

Band	Band Width	Frequency (MHz)	Modulation	Resource Block Size	Resource Block Offset	Data (MHz)
2	1.4 MHz	1880.0	QPSK	6	0	1.0929
			16-QAM	6	0	1.0983
	3 MHz		QPSK	15	0	2.6970
			16-QAM	15	0	2.6956
	5 MHz		QPSK	25	0	4.5103
			16-QAM	25	0	4.5158
	10 MHz		QPSK	50	0	8.9838
			16-QAM	50	0	8.9617
	15 MHz		QPSK	75	0	13.4930
			16-QAM	75	0	13.4820
	20 MHz		QPSK	100	0	17.9760
			16-QAM	100	0	18.0040

Band	Band Width	Frequency (MHz)	Modulation	Resource Block Size	Resource Block Offset	Data (MHz)
5	1.4 MHz	836.5	QPSK	6	0	1.0926
			16-QAM	6	0	1.0941
	3 MHz		QPSK	15	0	2.7058
			16-QAM	15	0	2.6911
	5 MHz		QPSK	25	0	4.5177
			16-QAM	25	0	4.5148
	10 MHz		QPSK	50	0	8.9891
			16-QAM	50	0	8.9717

- Plots of the EUT's Occupied Bandwidth are shown Page 50 ~ 59.

7.6 CONDUCTED SPURIOUS EMISSIONS

■ FACTORS FOR FREQUENCY

Frequency Range (GHz)	Factor [dB]
0.03 – 1	27.145
1 – 5	26.960
5 – 10	27.542
10 – 15	28.439
15 – 20	29.144
Above 20	30.148

NOTES:

Factor(dB) = Cable Loss + Attenuator + Power Splitter

Band	Band Width (MHz)	Frequency (MHz)	Frequency of Maximum Harmonic (GHz)	Factor (dB)	Measurement Maximum Data (dBm)	Result (dBm)
2	1.4	1850.7	18.9260	29.144	-65.513	-36.369
		1880.0	18.9540	29.144	-65.308	-36.164
		1909.3	16.5210	29.144	-65.677	-36.533
	3	1851.5	18.9970	29.144	-65.829	-36.685
		1880.0	19.9370	29.144	-65.405	-36.261
		1908.5	18.6010	29.144	-65.729	-36.585
	5	1852.5	18.8310	29.144	-65.411	-36.267
		1880.0	18.9100	29.144	-64.740	-35.596
		1907.5	18.9525	29.144	-64.829	-35.685
	10	1855.0	16.4295	29.144	-65.815	-36.671
		1880.0	17.9455	29.144	-66.194	-37.050
		1905.0	18.9595	29.144	-65.686	-36.542
	15	1857.5	19.5435	29.144	-66.652	-37.508
		1880.0	19.2385	29.144	-65.900	-36.756
		1902.5	19.0055	29.144	-65.998	-36.854
	20	1860.0	17.6605	29.144	-65.874	-36.730
		1880.0	18.9070	29.144	-66.307	-37.163
		1900.0	16.7670	29.144	-66.519	-37.375

Band	Band Width (MHz)	Frequency (MHz)	Frequency of Maximum Harmonic (GHz)	Factor (dB)	Measurement Maximum Data (dBm)	Result (dBm)
5	1.4	824.7	2.473252	27.145	-64.730	-37.585
		836.5	2.509036	27.145	-61.728	-34.583
		848.3	2.544323	27.145	-64.415	-37.270
	3	825.5	2.473252	27.145	-64.021	-36.876
		836.5	2.506054	27.145	-64.024	-36.879
		847.5	2.538856	27.145	-63.389	-36.244
	5	826.5	2.473749	27.145	-64.827	-37.682
		836.5	2.503569	27.145	-60.300	-33.155
		846.5	2.533389	27.145	-61.335	-34.190
	10	829.0	2.474743	27.145	-64.801	-37.656
		836.5	2.497108	27.145	-59.384	-32.239
		844.0	2.519473	27.145	-66.708	-39.563

NOTES:

1. Conducted Spurious Emissions was Tested QPSK Modulation, Resource Block Size 1 and Resource Block Offset 0
2. Result (dBm) = Measurement Maximum Data (dBm) + Factor (dB)

- Plots of the EUT's Conducted Spurious Emissions are shown Page 96 ~ 125.

7.6.1 BAND EDGE

- Plots of the EUT's Band Edge are shown Page 66 ~ 95.

7.7 FREQUENCY STABILITY / VARIATION OF AMBIENT TEMPERATURE

7.7.1 FREQUENCY STABILITY (1.4 MHz Band 2 LTE)

- ▣ OPERATING FREQUENCY: 1880,000,000 Hz
- ▣ CHANNEL: 18900 (1.4 MHz)
- ▣ REFERENCE VOLTAGE: 3.8 VDC
- ▣ DEVIATION LIMIT: Emission must remain in band

Voltage (%)	Power (VDC)	Temp. (°C)	Frequency (Hz)	Frequency Error (Hz)	Deviation (%)	ppm
100%	3.8	+20(Ref)	1879 999 986	0.0	0.000 000	0.000
100%		-30	1879 999 981	-5.5	0.000 000	-0.003
100%		-20	1879 999 981	-5.5	0.000 000	-0.003
100%		-10	1879 999 979	-7.6	0.000 000	-0.004
100%		0	1879 999 983	-3.7	0.000 000	-0.002
100%		+10	1879 999 981	-5.9	0.000 000	-0.003
100%		+30	1879 999 977	-9.9	-0.000 001	-0.005
100%		+40	1879 999 982	-4.3	0.000 000	-0.002
100%		+50	1879 999 982	-4.6	0.000 000	-0.002
Batt. Endpoint	3.6	+20	1879 999 977	-9.3	0.000 000	-0.005

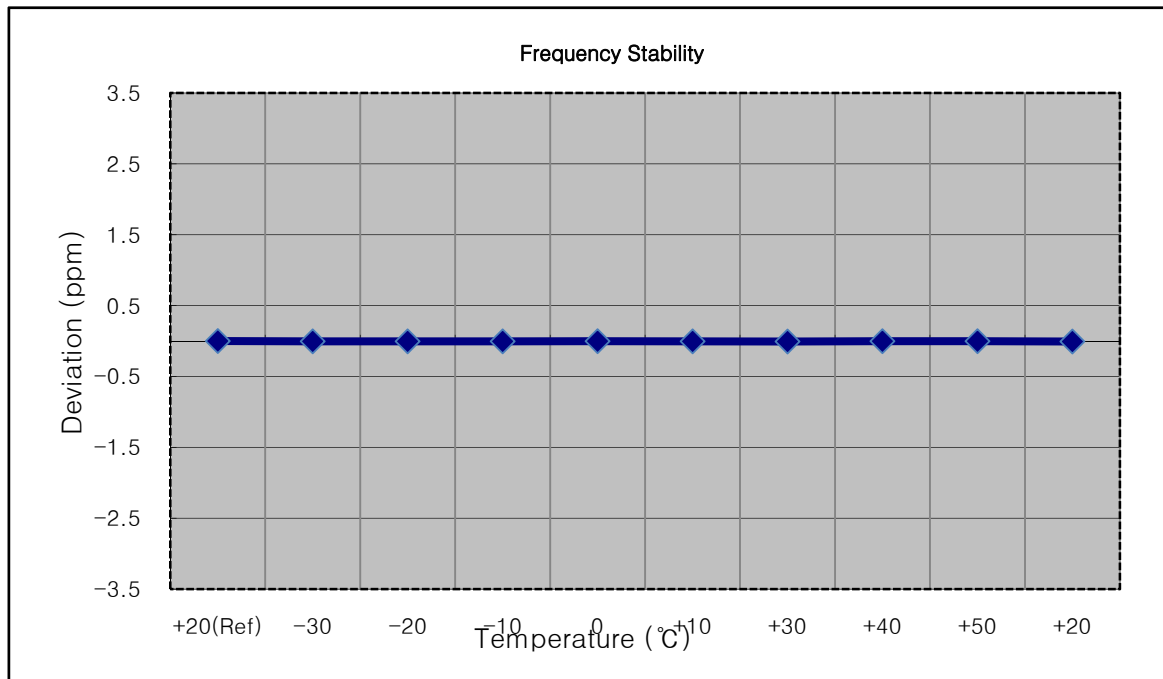

7.7.2 FREQUENCY STABILITY (3 MHz Band 2 LTE)

- ▣ OPERATING FREQUENCY: 1880,000,000 Hz
- ▣ CHANNEL: 18900 (3 MHz)
- ▣ REFERENCE VOLTAGE: 3.8 VDC
- ▣ DEVIATION LIMIT: Emission must remain in band

Voltage (%)	Power (VDC)	Temp. (°C)	Frequency (Hz)	Frequency Error (Hz)	Deviation (%)	ppm
100%	3.8	+20(Ref)	1879 999 991	0.0	0.000 000	0.000
100%		-30	1879 999 984	-7.1	0.000 000	-0.004
100%		-20	1879 999 995	3.7	0.000 000	0.002
100%		-10	1879 999 996	4.1	0.000 000	0.002
100%		0	1879 999 988	-3.5	0.000 000	-0.002
100%		+10	1879 999 985	-6.5	0.000 000	-0.003
100%		+30	1879 999 997	5.2	0.000 000	0.003
100%		+40	1879 999 988	-3.8	0.000 000	-0.002
100%		+50	1879 999 998	6.1	0.000 000	0.003
Batt. Endpoint	3.6	+20	1879 999 995	3.8	0.000 000	0.002

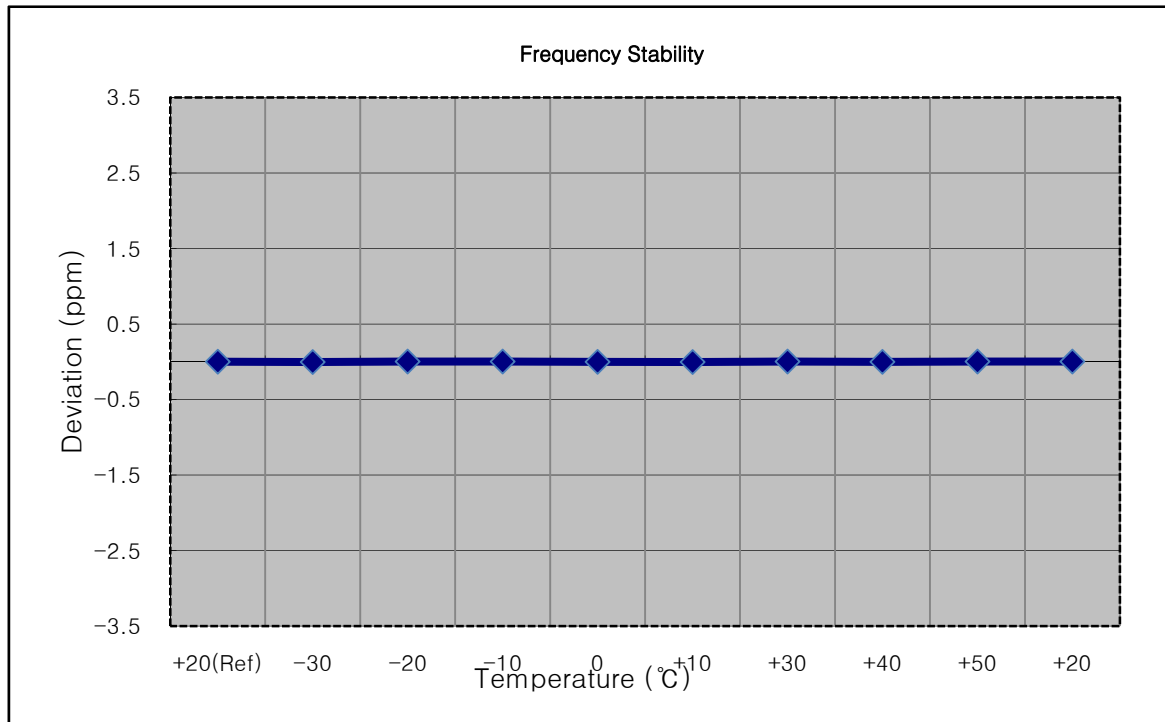

7.7.3 FREQUENCY STABILITY (5 MHz Band 2 LTE)

- ▣ OPERATING FREQUENCY: 1880,000,000 Hz
- ▣ CHANNEL: 18900 (5 MHz)
- ▣ REFERENCE VOLTAGE: 3.8 VDC
- ▣ DEVIATION LIMIT: Emission must remain in band

Voltage (%)	Power (VDC)	Temp. (°C)	Frequency (Hz)	Frequency Error (Hz)	Deviation (%)	ppm
100%	3.8	+20(Ref)	1879 999 993	0.0	0.000 000	0.000
100%		-30	1879 999 989	-4.3	0.000 000	-0.002
100%		-20	1879 999 990	-3.2	0.000 000	-0.002
100%		-10	1879 999 983	-10.5	-0.000 001	-0.006
100%		0	1879 999 985	-8.3	0.000 000	-0.004
100%		+10	1879 999 988	-5.2	0.000 000	-0.003
100%		+30	1879 999 989	-4.0	0.000 000	-0.002
100%		+40	1879 999 988	-5.8	0.000 000	-0.003
100%		+50	1879 999 990	-3.3	0.000 000	-0.002
Batt. Endpoint	3.6	+20	1879 999 986	-7.4	0.000 000	-0.004

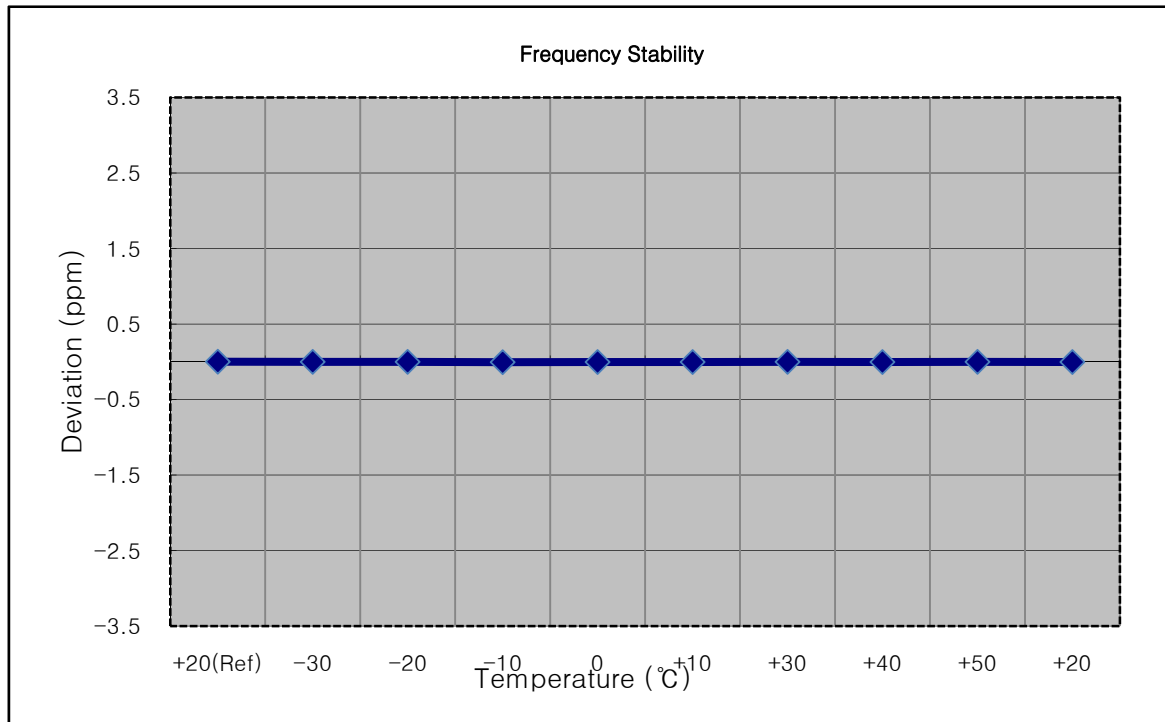

7.7.4 FREQUENCY STABILITY (10 MHz Band 2 LTE)

- ▣ OPERATING FREQUENCY: 1880,000,000 Hz
- ▣ CHANNEL: 18900 (10 MHz)
- ▣ REFERENCE VOLTAGE: 3.8 VDC
- ▣ DEVIATION LIMIT: Emission must remain in band

Voltage (%)	Power (VDC)	Temp. (°C)	Frequency (Hz)	Frequency Error (Hz)	Deviation (%)	ppm
100%	3.8	+20(Ref)	1879 999 993	0.0	0.000 000	0.000
100%		-30	1879 999 999	5.6	0.000 000	0.003
100%		-20	1879 999 999	6.4	0.000 000	0.003
100%		-10	1879 999 988	-5.4	0.000 000	-0.003
100%		0	1879 999 988	-4.7	0.000 000	-0.003
100%		+10	1879 999 986	-6.6	0.000 000	-0.004
100%		+30	1879 999 986	-6.7	0.000 000	-0.004
100%		+40	1879 999 999	6.1	0.000 000	0.003
100%		+50	1879 999 999	6.2	0.000 000	0.003
Batt. Endpoint	3.6	+20	1879 999 988	-5.0	0.000 000	-0.003

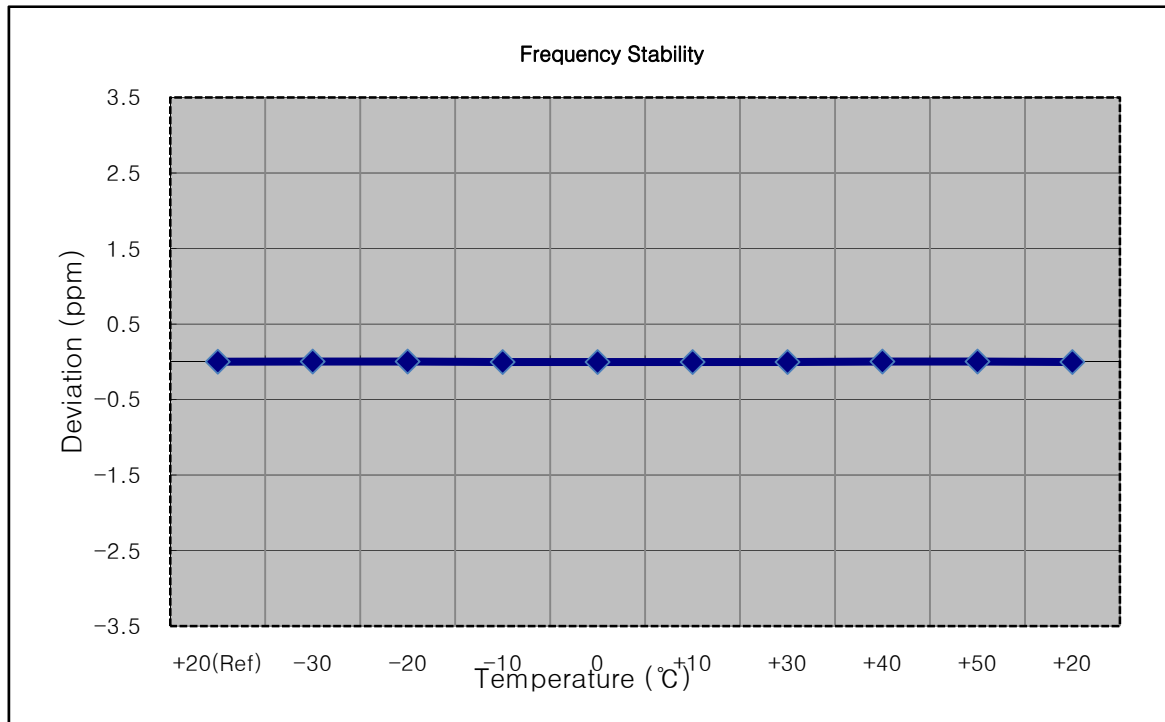

7.7.5 FREQUENCY STABILITY (15 MHz Band 2 LTE)

- ▣ OPERATING FREQUENCY: 1880,000,000 Hz
- ▣ CHANNEL: 18900 (15 MHz)
- ▣ REFERENCE VOLTAGE: 3.8 VDC
- ▣ DEVIATION LIMIT: Emission must remain in band

Voltage (%)	Power (VDC)	Temp. (°C)	Frequency (Hz)	Frequency Error (Hz)	Deviation (%)	ppm
100%	3.8	+20(Ref)	1879 999 987	0.0	0.000 000	0.000
100%		-30	1879 999 980	-7.1	0.000 000	-0.004
100%		-20	1879 999 979	-8.0	0.000 000	-0.004
100%		-10	1879 999 975	-12.0	-0.000 001	-0.006
100%		0	1879 999 979	-8.2	0.000 000	-0.004
100%		+10	1879 999 982	-5.5	0.000 000	-0.003
100%		+30	1879 999 983	-4.9	0.000 000	-0.003
100%		+40	1879 999 980	-7.8	0.000 000	-0.004
100%		+50	1879 999 980	-7.0	0.000 000	-0.004
Batt. Endpoint	3.6	+20	1879 999 980	-7.3	0.000 000	-0.004

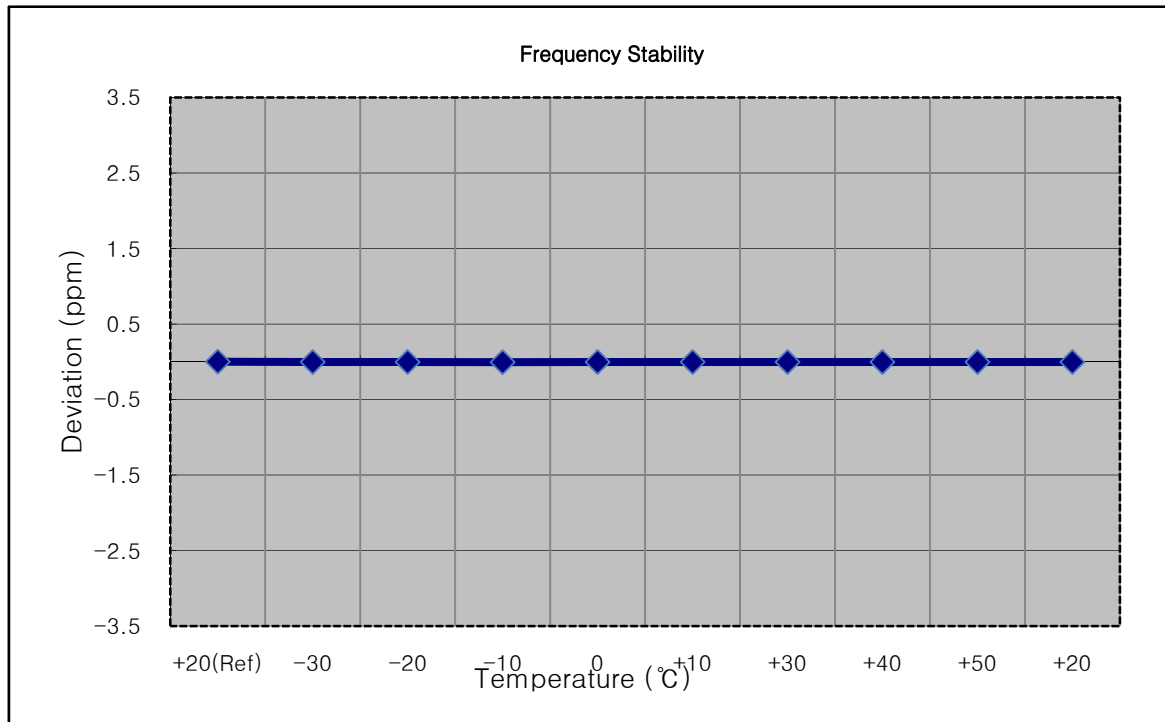

7.7.6 FREQUENCY STABILITY (20 MHz Band 2 LTE)

- ▣ OPERATING FREQUENCY: 1880,000,000 Hz
- ▣ CHANNEL: 18900 (20 MHz)
- ▣ REFERENCE VOLTAGE: 3.8 VDC
- ▣ DEVIATION LIMIT: Emission must remain in band

Voltage (%)	Power (VDC)	Temp. (°C)	Frequency (Hz)	Frequency Error (Hz)	Deviation (%)	ppm
100%	3.8	+20(Ref)	1879 999 992	0.0	0.000 000	0.000
100%		-30	1879 999 986	-5.6	0.000 000	-0.003
100%		-20	1879 999 986	-6.3	0.000 000	-0.003
100%		-10	1879 999 984	-7.7	0.000 000	-0.004
100%		0	1879 999 984	-8.3	0.000 000	-0.004
100%		+10	1879 999 988	-4.4	0.000 000	-0.002
100%		+30	1879 999 983	-9.5	-0.000 001	-0.005
100%		+40	1879 999 984	-8.5	0.000 000	-0.005
100%		+50	1879 999 980	-12.4	-0.000 001	-0.007
Batt. Endpoint	3.6	+20	1879 999 987	-5.1	0.000 000	-0.003

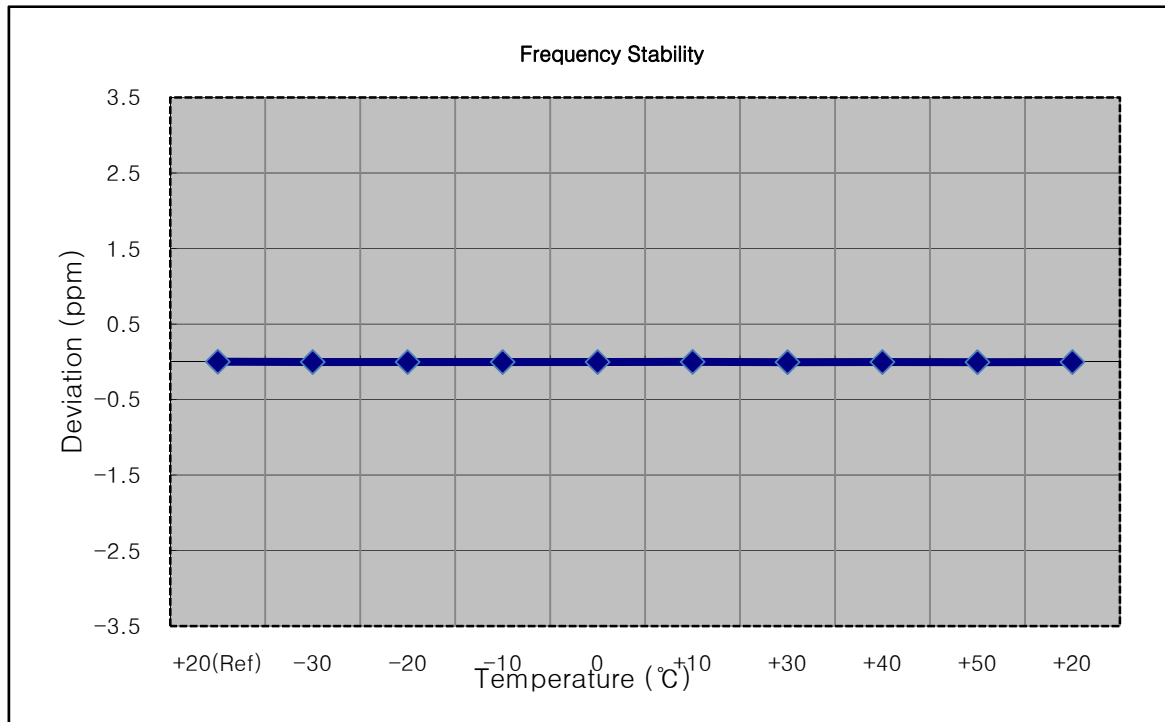

7.7.7 FREQUENCY STABILITY (1.4 MHz Band 5 LTE)

- ▣ OPERATING FREQUENCY: 836,500,000 Hz
- ▣ CHANNEL: 20525 (1.4 MHz)
- ▣ REFERENCE VOLTAGE: 3.8 VDC
- ▣ DEVIATION LIMIT: ± 0.000 25 % or 2.5 ppm

Voltage (%)	Power (VDC)	Temp. (°C)	Frequency (Hz)	Frequency Error (Hz)	Deviation (%)	ppm
100%	3.8	+20(Ref)	836 499 997	0.0	0.000 000	0.000
100%		-30	836 500 001	3.9	0.000 000	0.005
100%		-20	836 499 993	-4.2	-0.000 001	-0.005
100%		-10	836 500 001	4.2	0.000 001	0.005
100%		0	836 500 002	4.9	0.000 001	0.006
100%		+10	836 499 995	-2.4	0.000 000	-0.003
100%		+30	836 500 001	4.4	0.000 001	0.005
100%		+40	836 499 992	-5.2	-0.000 001	-0.006
100%		+50	836 499 991	-5.8	-0.000 001	-0.007
Batt. Endpoint		3.6	+20	836 500 001	4.1	0.000 000

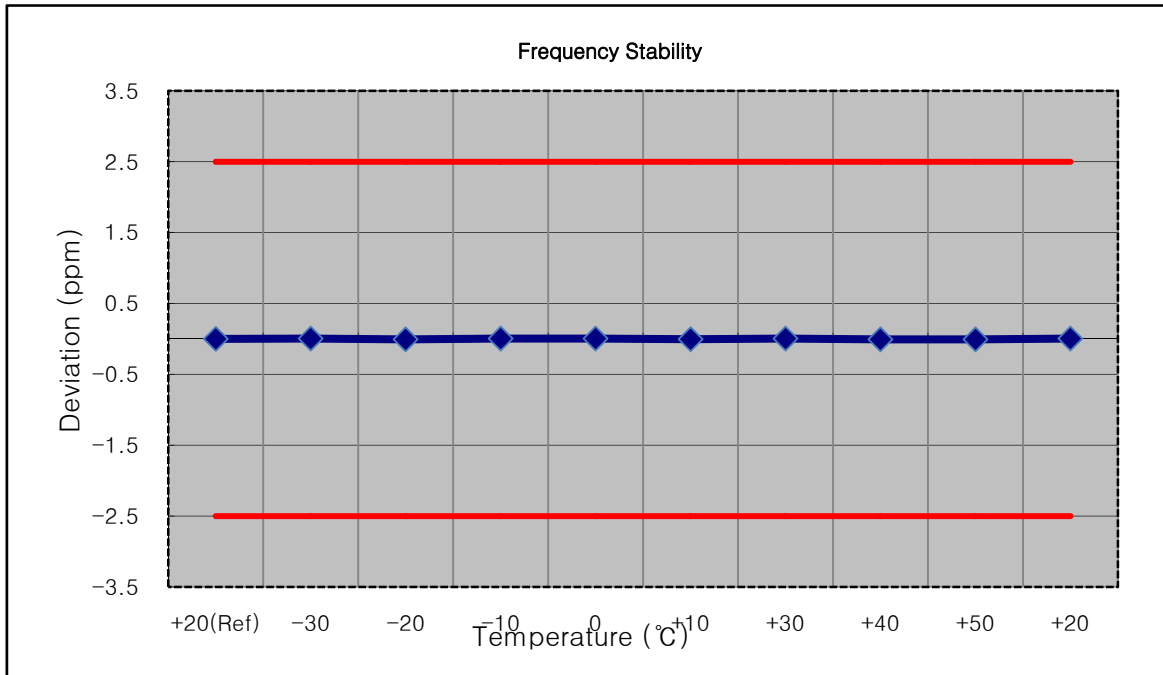

7.7.8 FREQUENCY STABILITY (3 MHz Band 5 LTE)

- ▣ OPERATING FREQUENCY: 836,500,000 Hz
- ▣ CHANNEL: 20525 (3 MHz)
- ▣ REFERENCE VOLTAGE: 3.8 VDC
- ▣ DEVIATION LIMIT: ± 0.000 25 % or 2.5 ppm

Voltage (%)	Power (VDC)	Temp. (°C)	Frequency (Hz)	Frequency Error (Hz)	Deviation (%)	ppm
100%	3.8	+20(Ref)	836 500 003	0.0	0.000 000	0.000
100%		-30	836 499 999	-3.5	0.000 000	-0.004
100%		-20	836 500 000	-2.9	0.000 000	-0.003
100%		-10	836 499 999	-3.7	0.000 000	-0.004
100%		0	836 500 006	3.5	0.000 000	0.004
100%		+10	836 500 000	-2.5	0.000 000	-0.003
100%		+30	836 500 005	2.4	0.000 000	0.003
100%		+40	836 500 000	-3.3	0.000 000	-0.004
100%		+50	836 500 010	7.4	0.000 001	0.009
Batt. Endpoint	3.6	+20	836 500 006	3.3	0.000 000	0.004

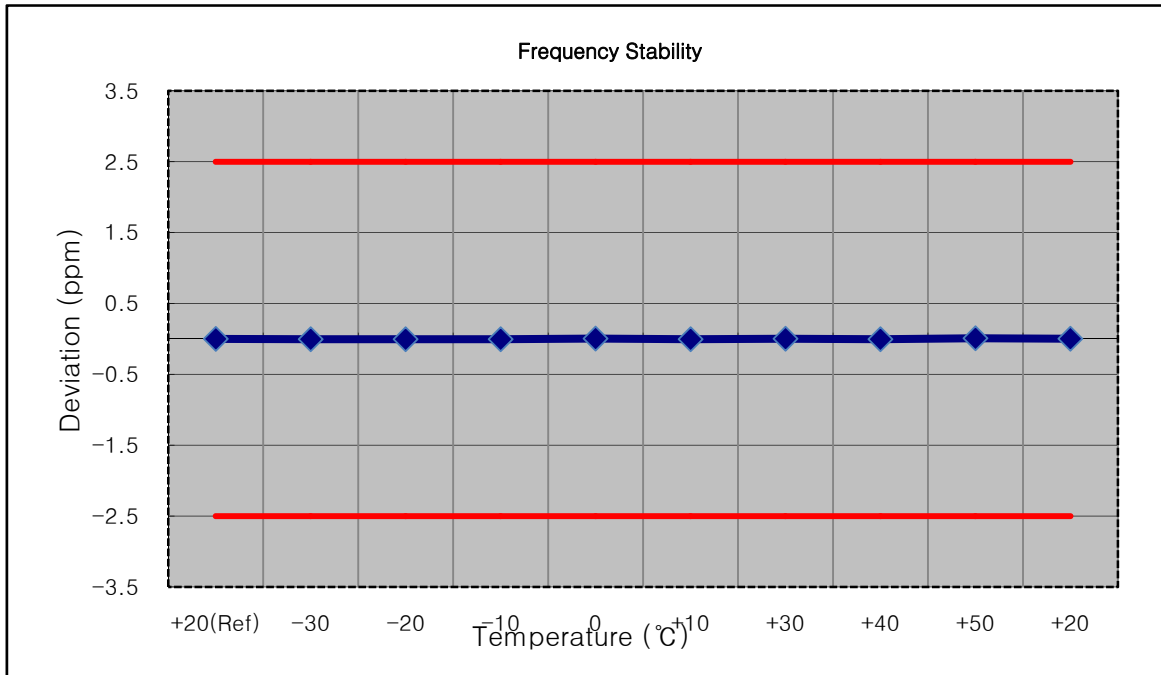

7.7.9 FREQUENCY STABILITY (5 MHz Band 5 LTE)

- ▣ OPERATING FREQUENCY: 836,500,000 Hz
- ▣ CHANNEL: 20525 (5 MHz)
- ▣ REFERENCE VOLTAGE: 3.8 VDC
- ▣ DEVIATION LIMIT: ± 0.000 25 % or 2.5 ppm

Voltage (%)	Power (VDC)	Temp. (°C)	Frequency (Hz)	Frequency Error (Hz)	Deviation (%)	ppm
100%	3.8	+20(Ref)	836 499 998	0.0	0.000 000	0.000
100%		-30	836 500 002	3.8	0.000 000	0.005
100%		-20	836 500 001	2.8	0.000 000	0.003
100%		-10	836 499 995	-3.5	0.000 000	-0.004
100%		0	836 500 002	4.2	0.000 001	0.005
100%		+10	836 500 001	3.3	0.000 000	0.004
100%		+30	836 499 994	-4.2	-0.000 001	-0.005
100%		+40	836 499 995	-3.5	0.000 000	-0.004
100%		+50	836 499 991	-7.5	-0.000 001	-0.009
Batt. Endpoint	3.6	+20	836 500 005	6.5	0.000 001	0.008

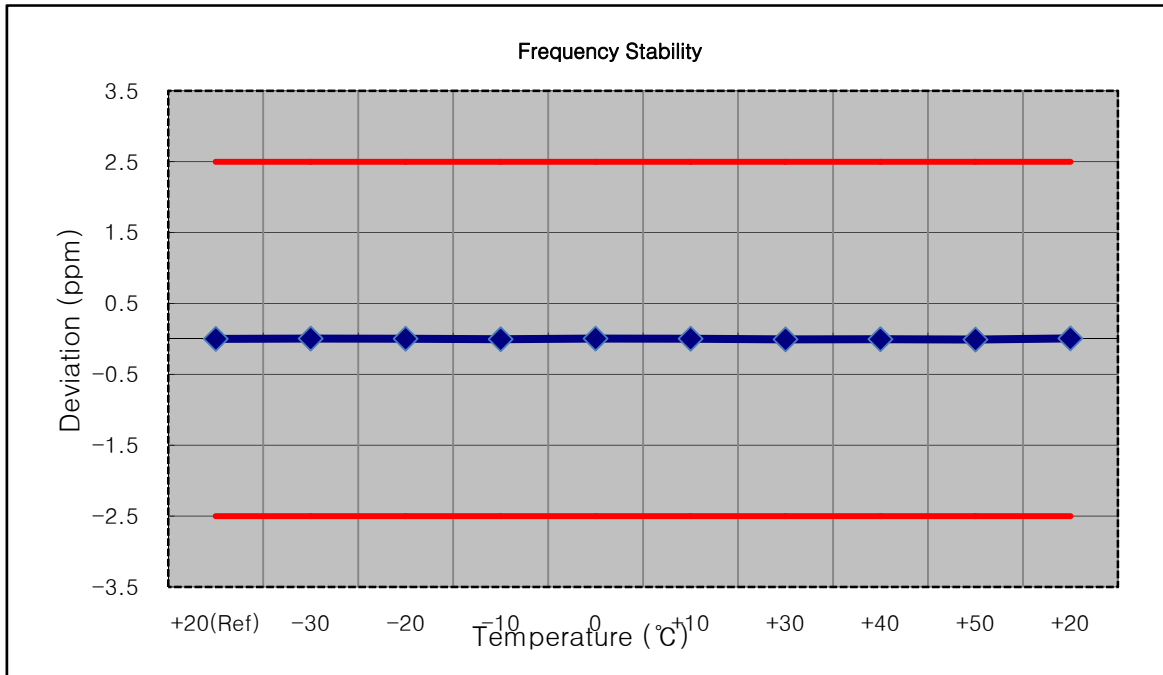

7.7.10 FREQUENCY STABILITY (10 MHz Band 5 LTE)

- ▣ OPERATING FREQUENCY: 836,500,000 Hz
- ▣ CHANNEL: 20525 (10 MHz)
- ▣ REFERENCE VOLTAGE: 3.8 VDC
- ▣ DEVIATION LIMIT: ± 0.000 25 % or 2.5 ppm

Voltage (%)	Power (VDC)	Temp. (°C)	Frequency (Hz)	Frequency Error (Hz)	Deviation (%)	ppm
100%	3.8	+20(Ref)	836 500 004	0.0	0.000 000	0.000
100%		-30	836 500 010	5.2	0.000 001	0.006
100%		-20	836 500 009	4.6	0.000 001	0.005
100%		-10	836 500 010	5.8	0.000 001	0.007
100%		0	836 500 002	-2.1	0.000 000	-0.003
100%		+10	836 500 009	4.3	0.000 001	0.005
100%		+30	836 500 002	-2.9	0.000 000	-0.003
100%		+40	836 500 010	5.8	0.000 001	0.007
100%		+50	836 500 002	-2.3	0.000 000	-0.003
Batt. Endpoint		3.6	+20	836 500 000	-4.5	-0.000 001

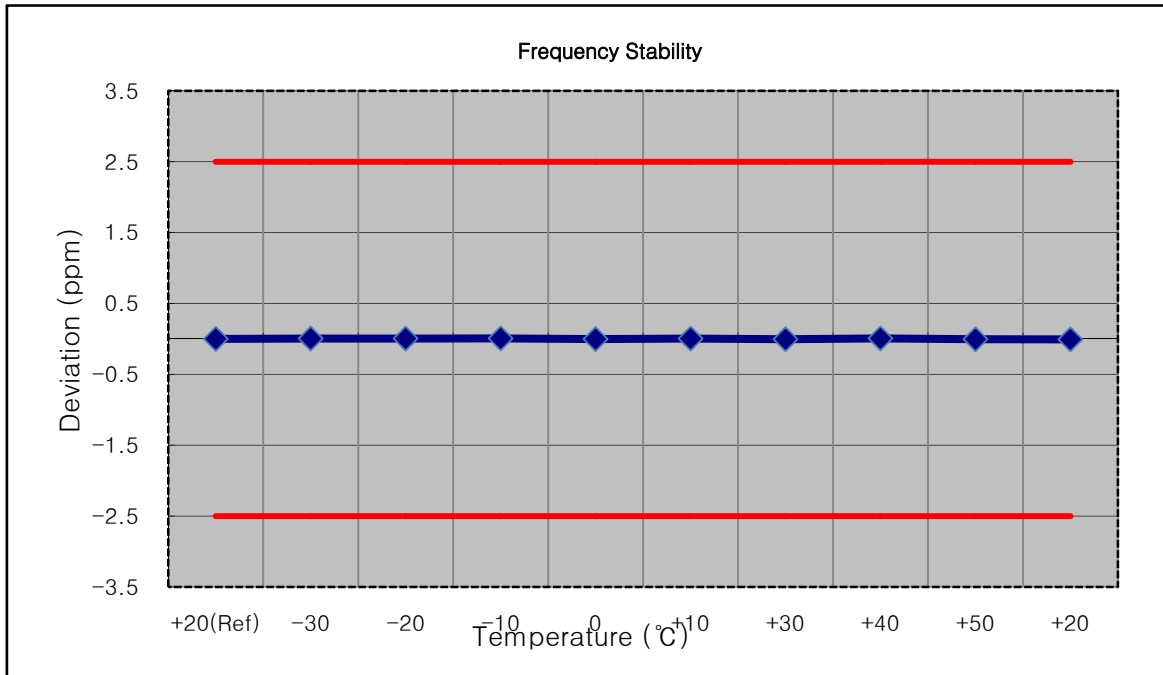

8. TEST PLOTS

BAND 2. Occupied Bandwidth Plot (1.4M BW Ch.18900 QPSK RB 6_0)

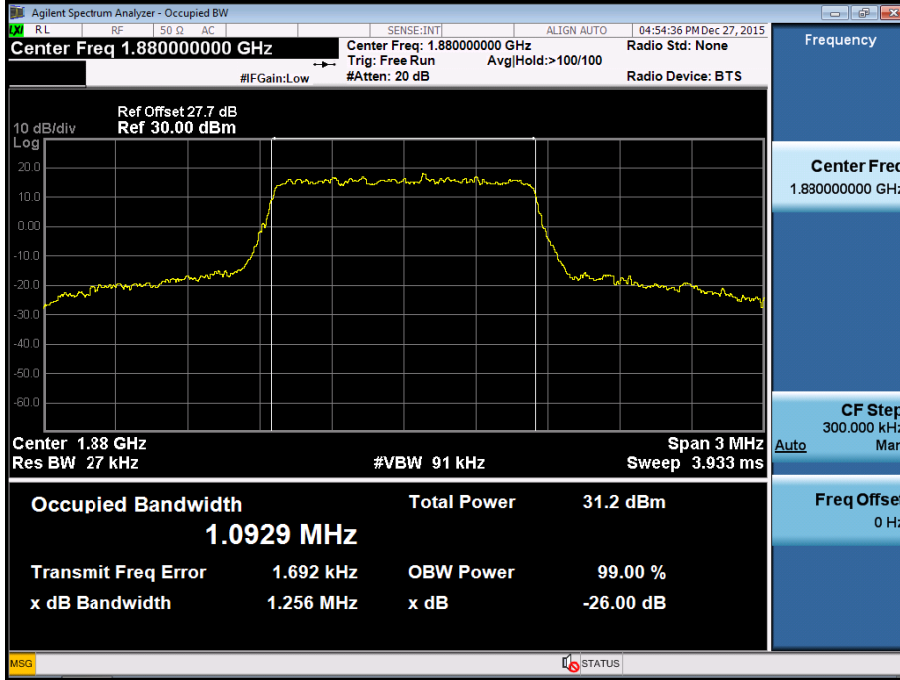

BAND 2. Occupied Bandwidth Plot (1.4M BW Ch.18900 16QAM RB 6_0)

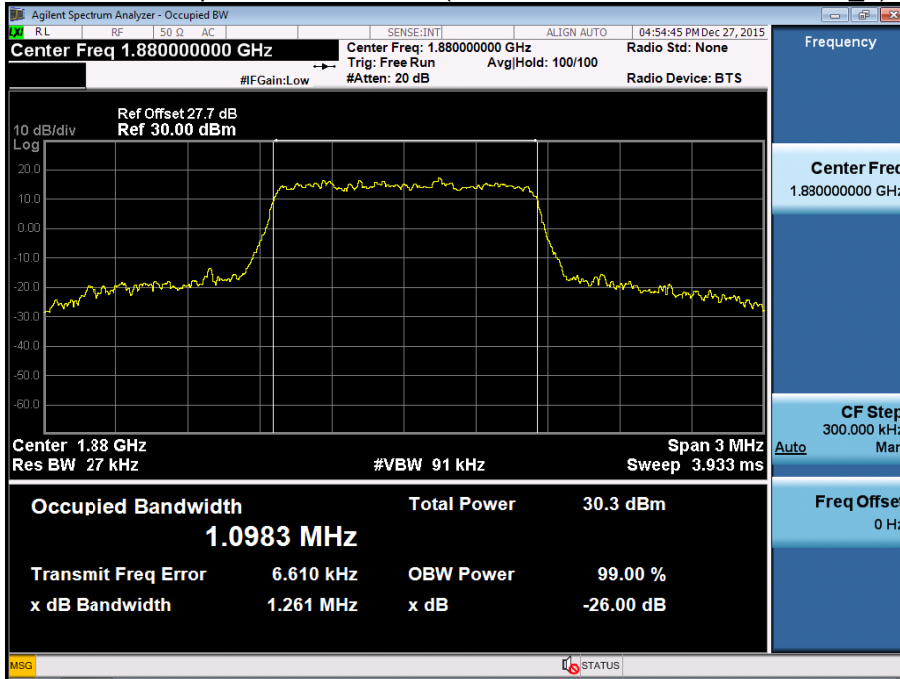

BAND 2. Occupied Bandwidth Plot (3M BW Ch.18900 QPSK RB 15_0)

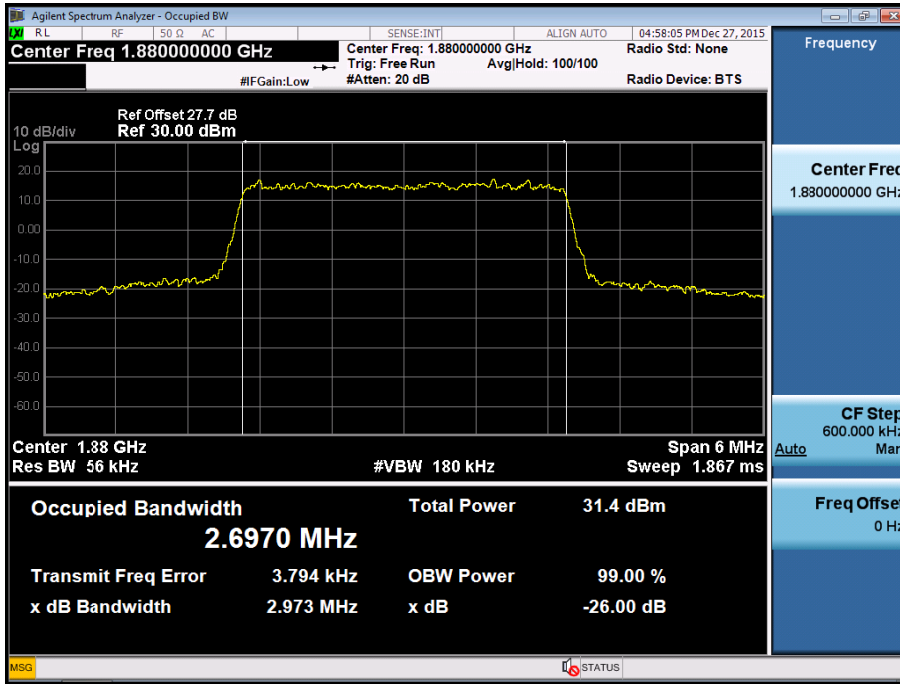

BAND 2. Occupied Bandwidth Plot (3M BW Ch.18900 16QAM RB 15_0)

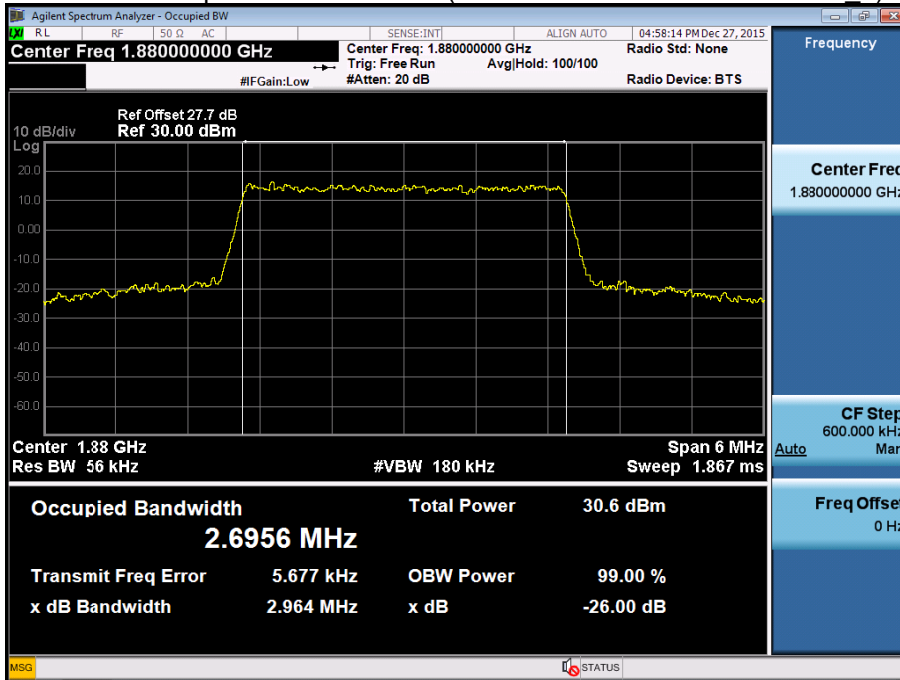

BAND 2. Occupied Bandwidth Plot (5M BW Ch.18900 QPSK RB 25_0)

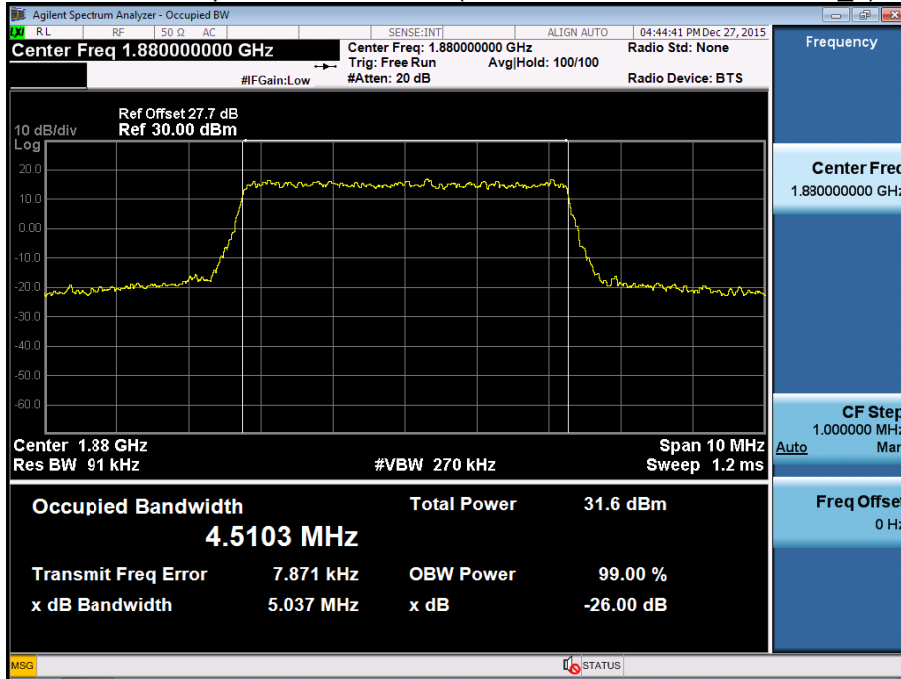

BAND 2. Occupied Bandwidth Plot (5M BW Ch.18900 16QAM RB 25_0)

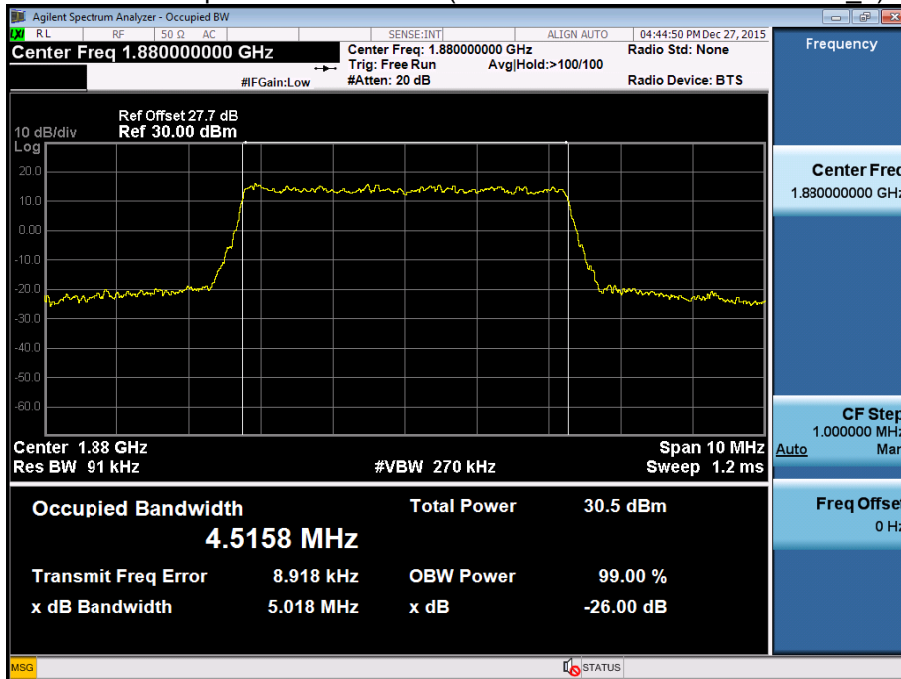

BAND 2. Occupied Bandwidth Plot (10M BW Ch.18900 QPSK RB 50_0)

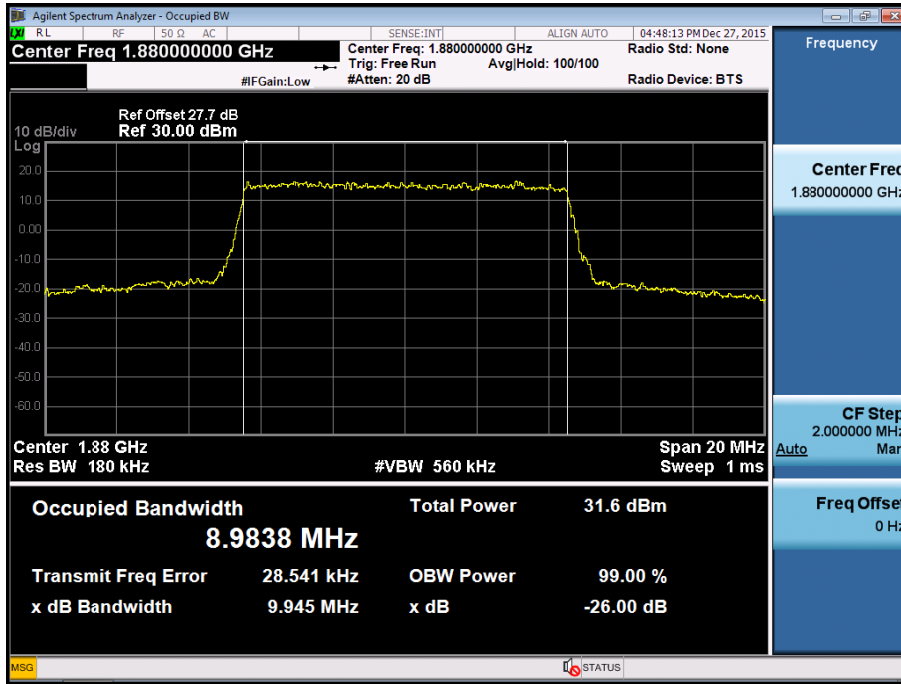

BAND 2. Occupied Bandwidth Plot (10M BW Ch.18900 16QAM RB 50_0)

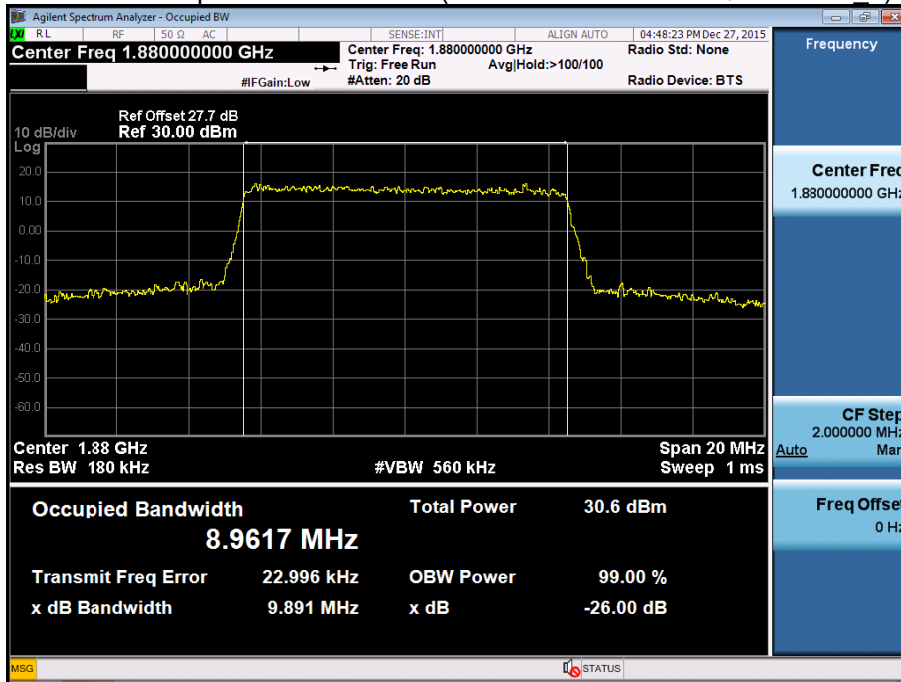

BAND 2. Occupied Bandwidth Plot (15M BW Ch.18900 QPSK RB 75_0)

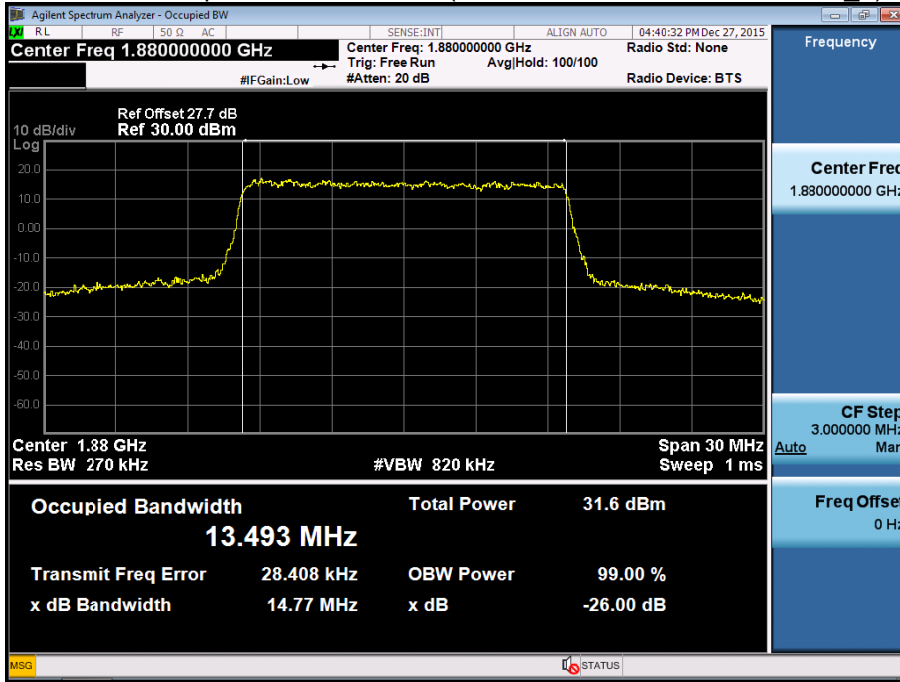

BAND 2. Occupied Bandwidth Plot (15M BW Ch.18900 16QAM RB 75_0)

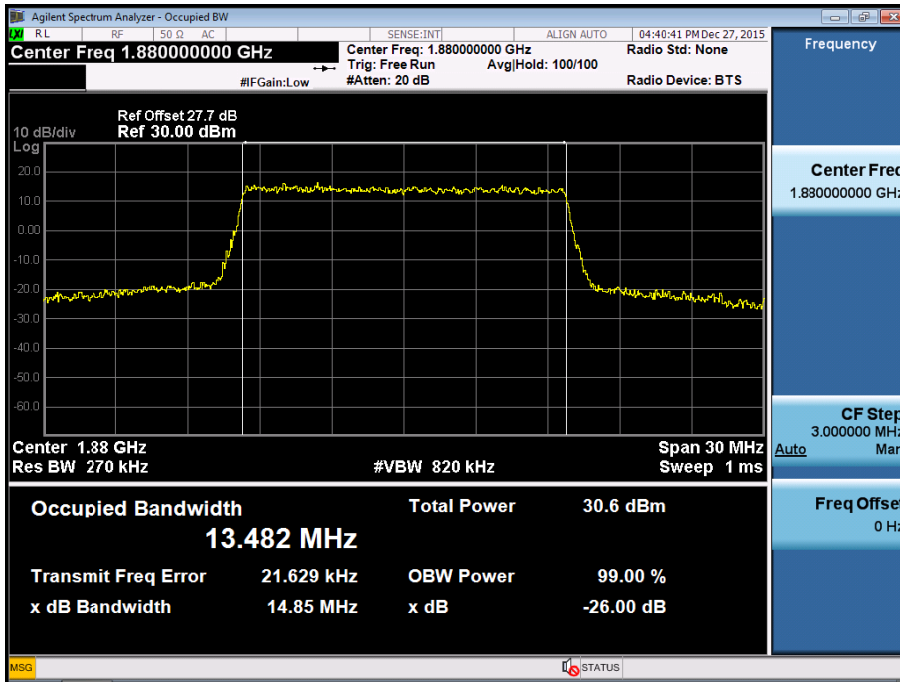

BAND 2. Occupied Bandwidth Plot (20M BW Ch.18900 QPSK RB 100_0)

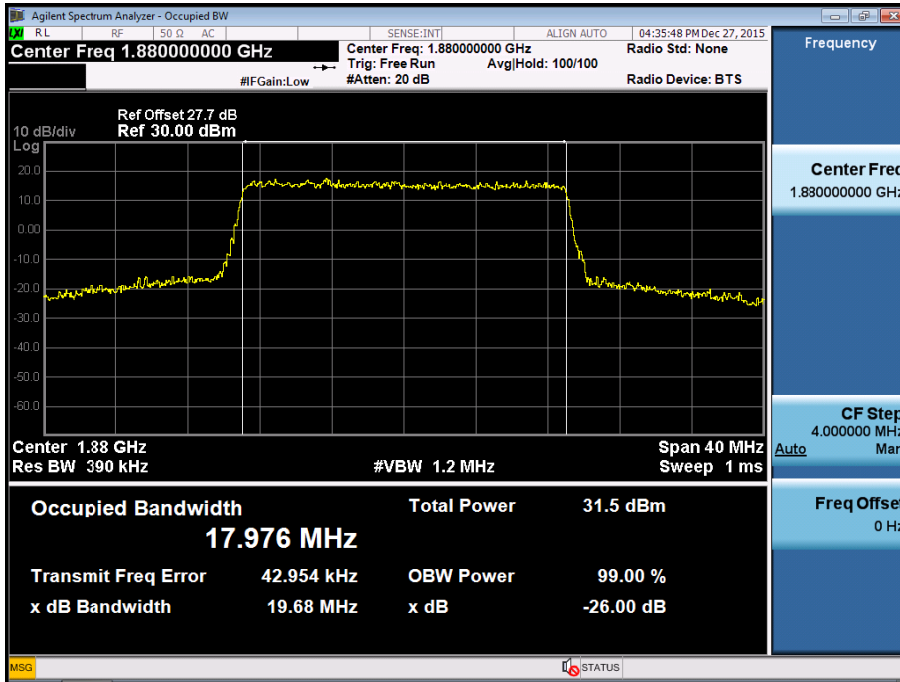

BAND 2. Occupied Bandwidth Plot (20M BW Ch.18900 16QAM RB 100_0)

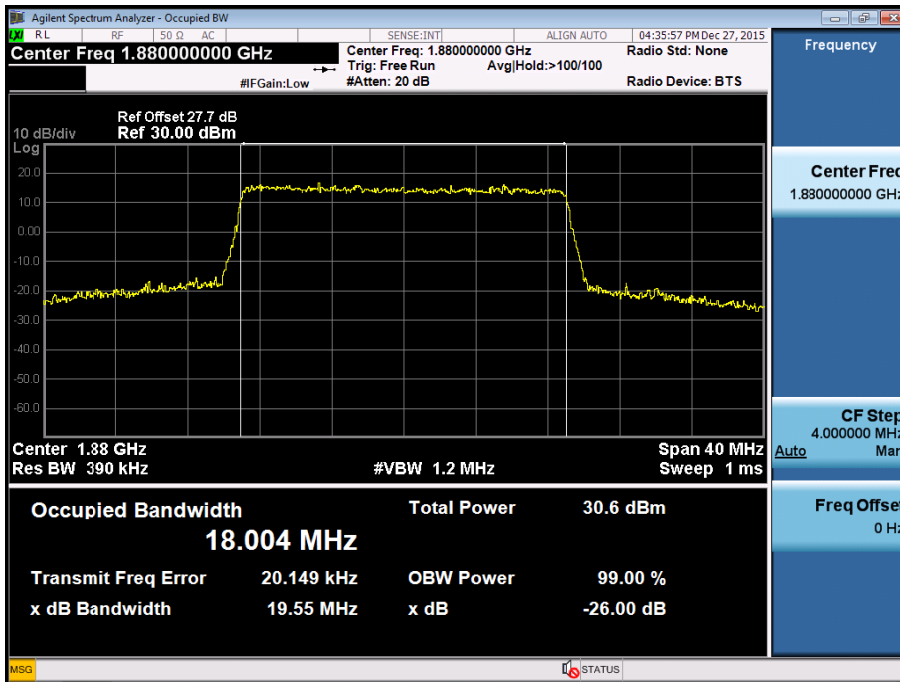

BAND 5. Occupied Bandwidth Plot (1.4M BW Ch.20525 QPSK_RB6_0)

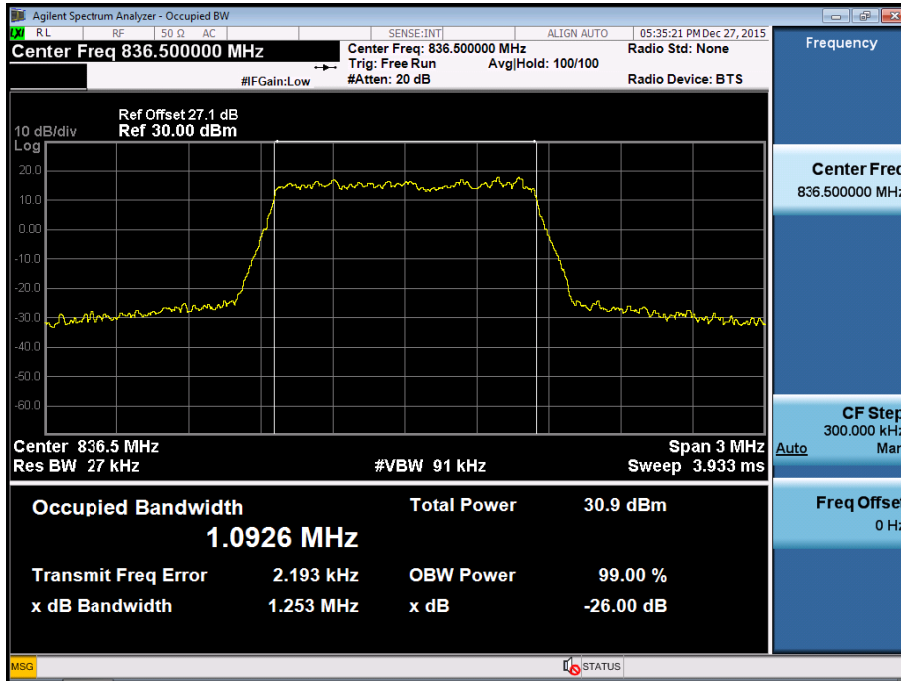

BAND 5. Occupied Bandwidth Plot (1.4M BW Ch.20525 16QAM_RB6_0)

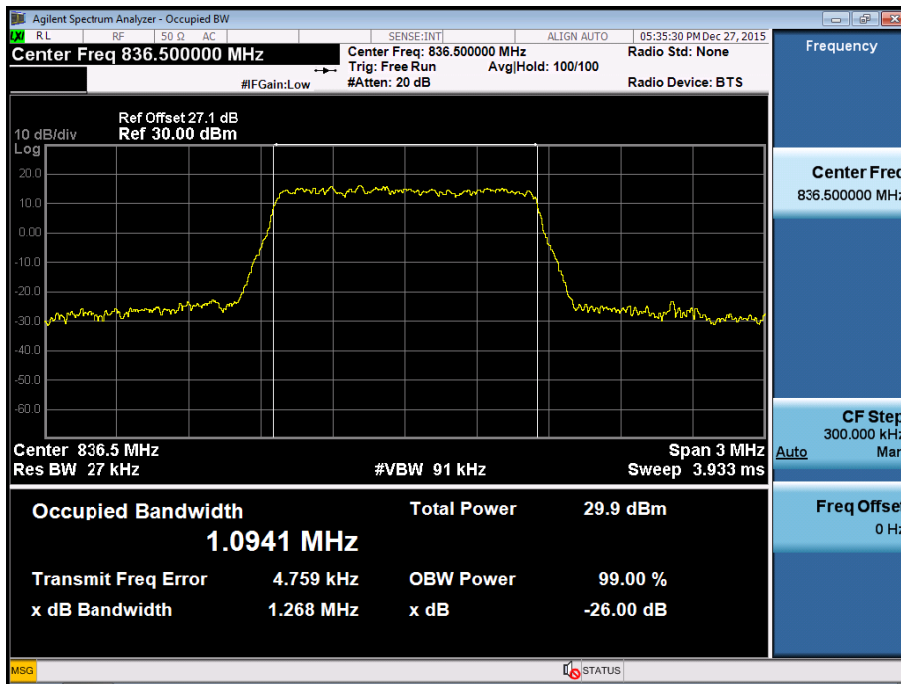

BAND 5. Occupied Bandwidth Plot (3M BW Ch.20525 QPSK_RB15_0)

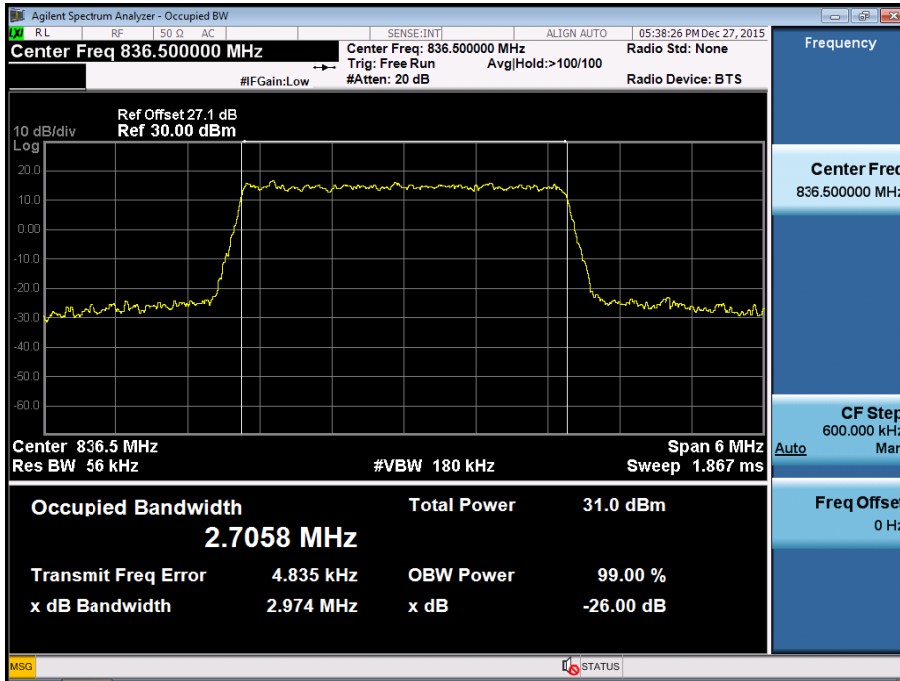

BAND 5. Occupied Bandwidth Plot (3M BW Ch.20525 16QAM_RB15_0)

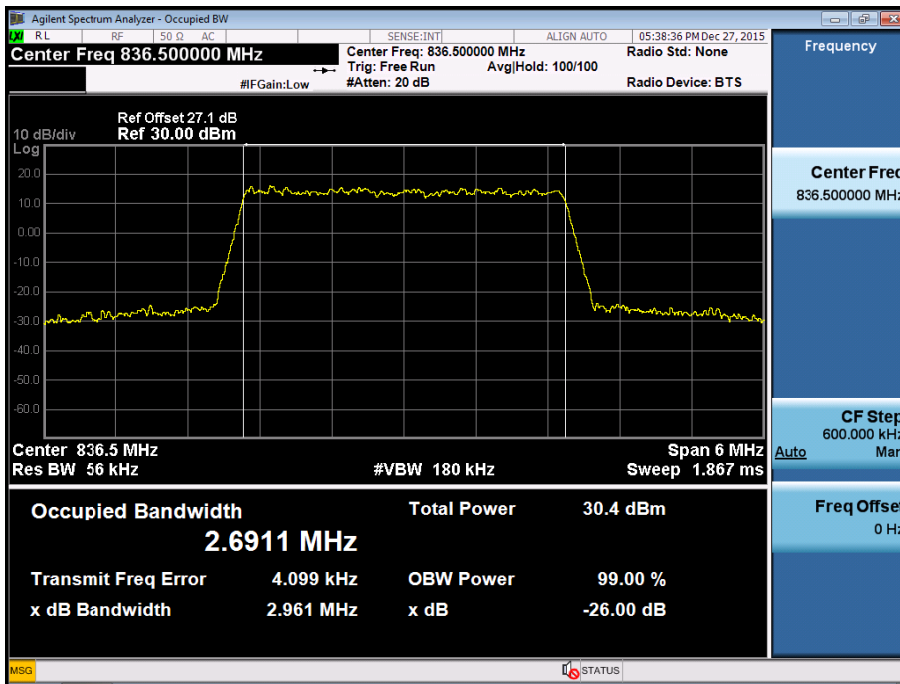

BAND 5. Occupied Bandwidth Plot (5M BW Ch.20525 QPSK_RB25_0)

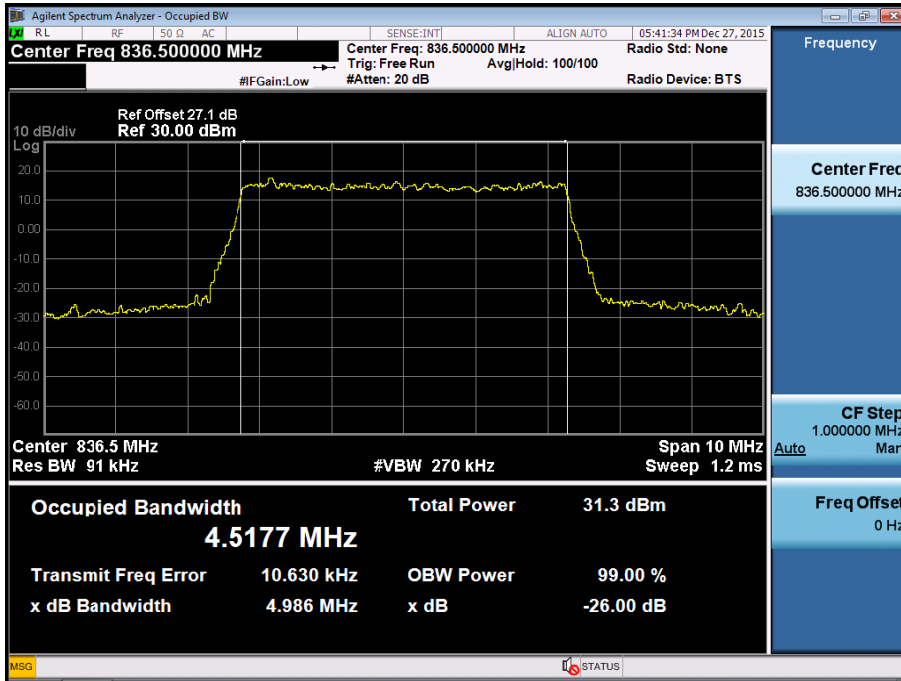

BAND 5. Occupied Bandwidth Plot (5M BW Ch.20525 16QAM_RB25_0)

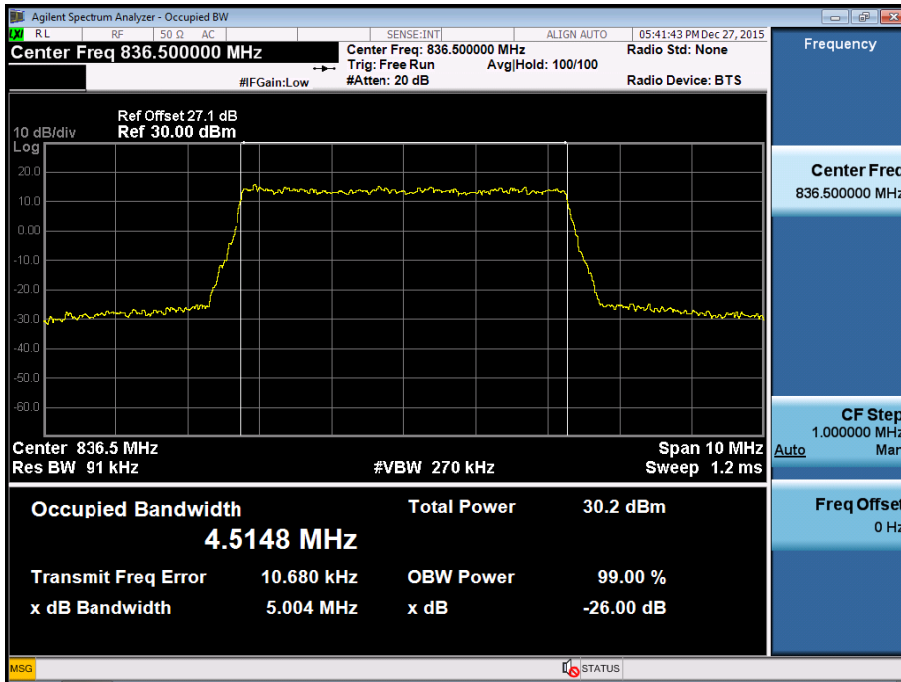

BAND 5. Occupied Bandwidth Plot (10M BW Ch.20525 QPSK_RB50_0)

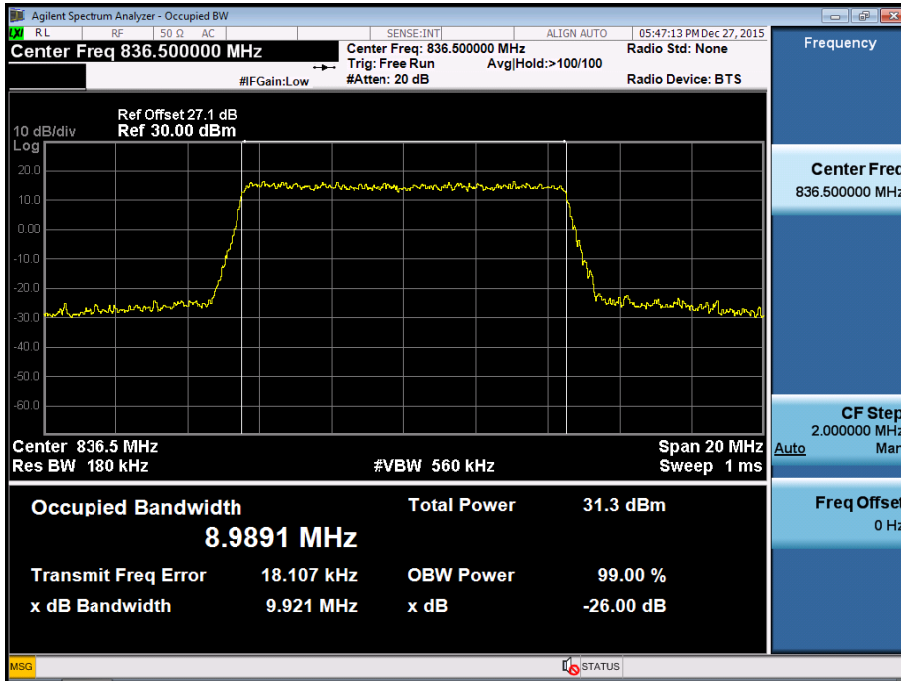

BAND 5. Occupied Bandwidth Plot (10M BW Ch.20525 16QAM_RB50_0)

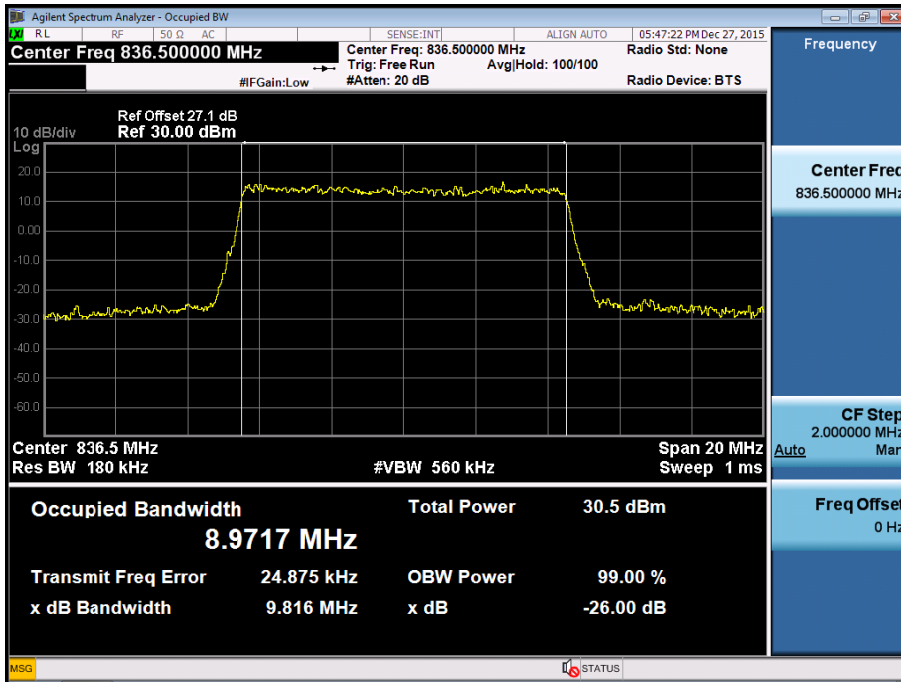

BAND 2. PAR Plot (1.4M BW Ch.18900 QPSK RB 6_0)

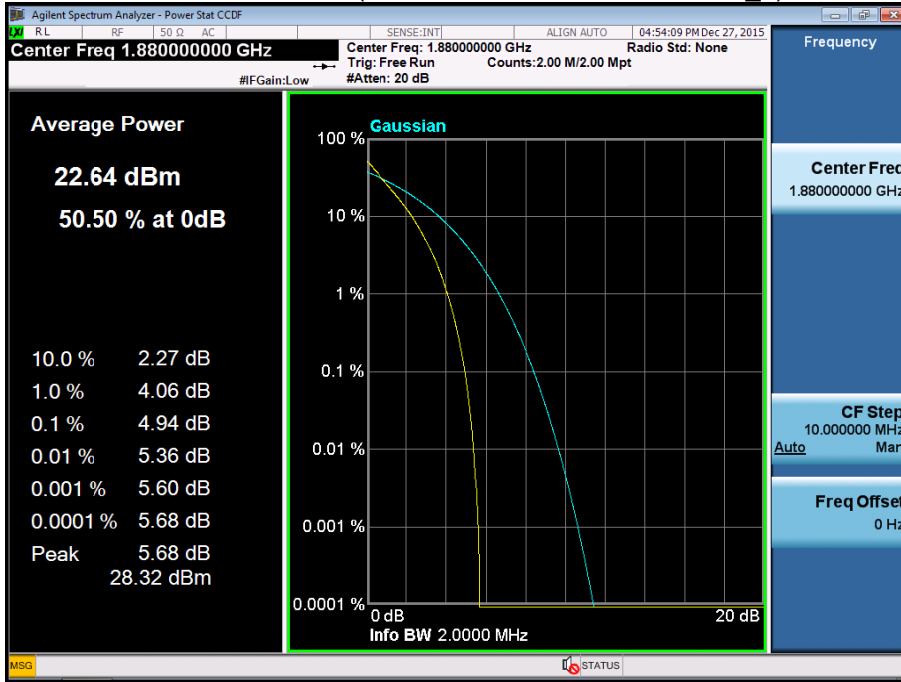

BAND 2. PAR Plot (1.4M BW Ch.18900 16QAM RB 6_0)

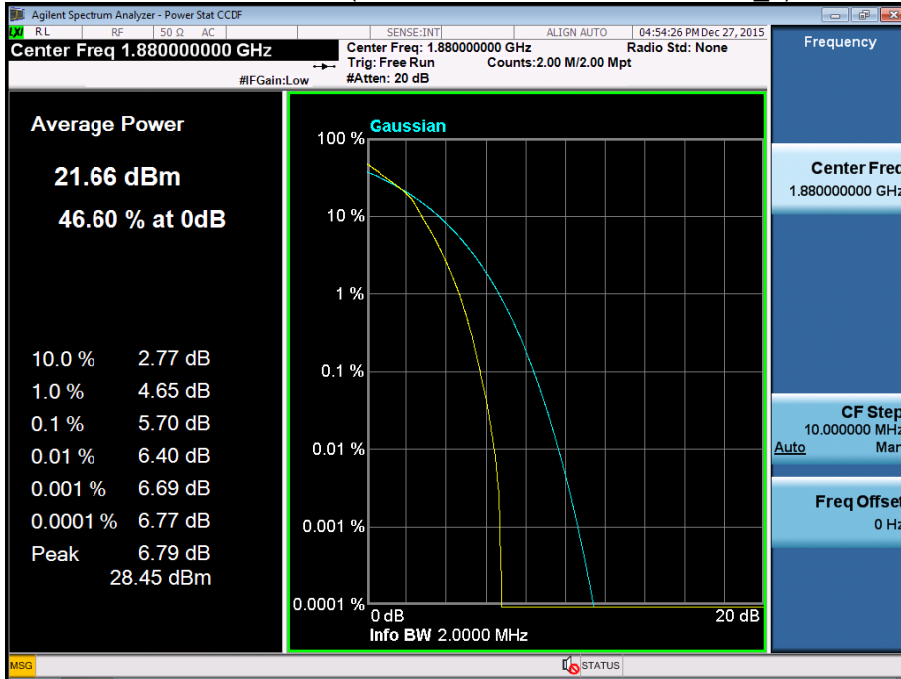

BAND 2. PAR Plot (3M BW Ch.18900 QPSK RB 15_0)

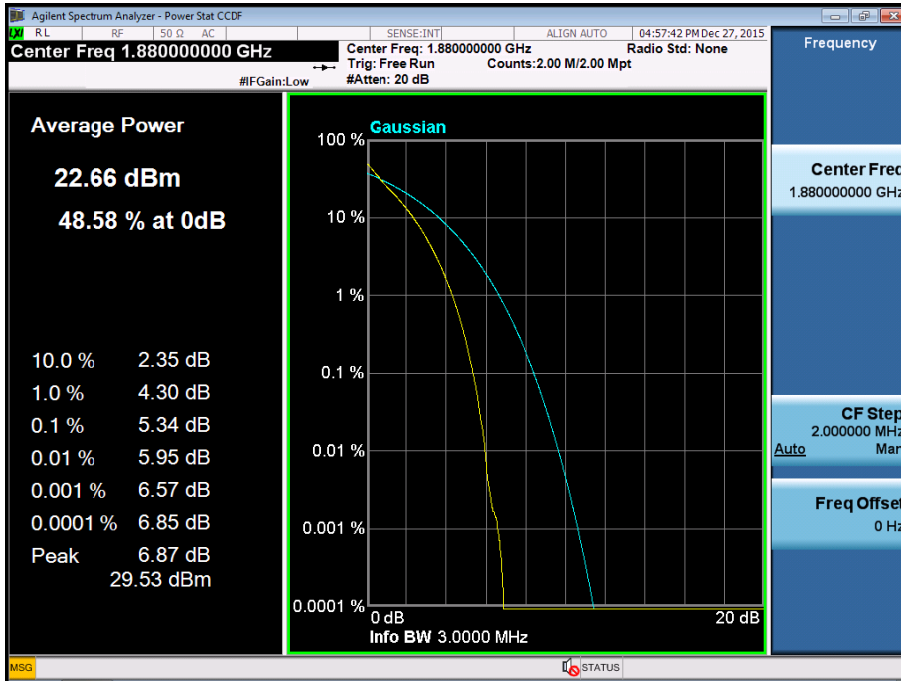

BAND 2. PAR Plot (3M BW Ch.18900 16QAM RB 15_0)

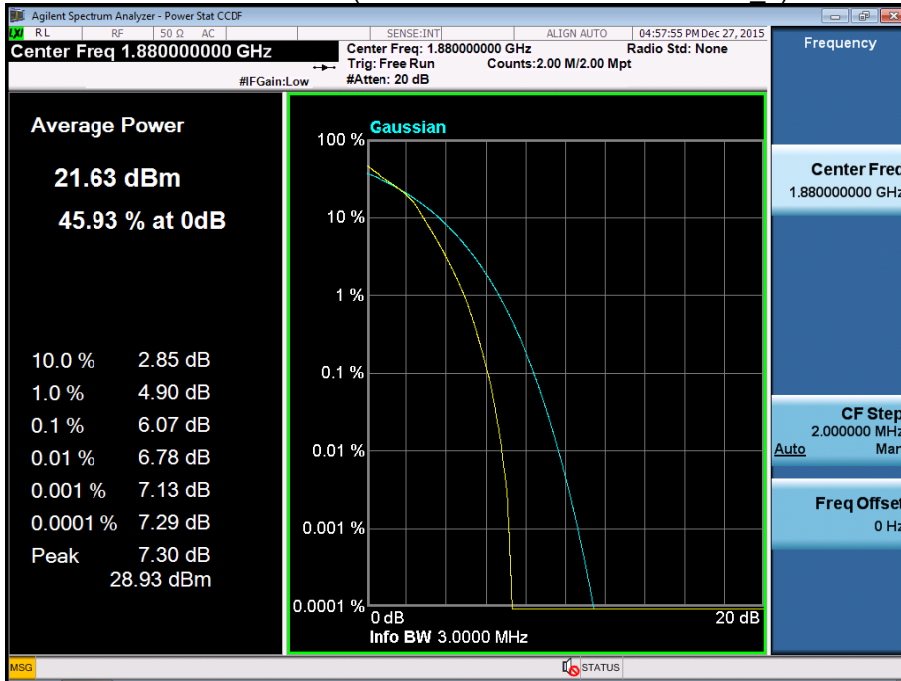

BAND 2. PAR Plot (5M BW Ch.18900 QPSK RB 25_0)

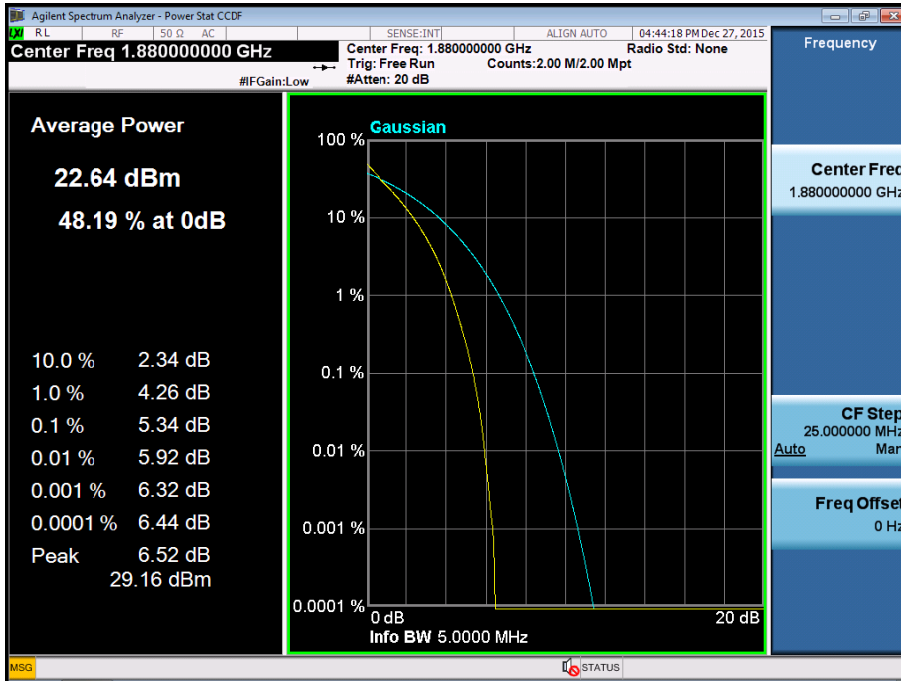

BAND 2. PAR Plot (5M BW Ch.18900 16QAM RB 25_0)

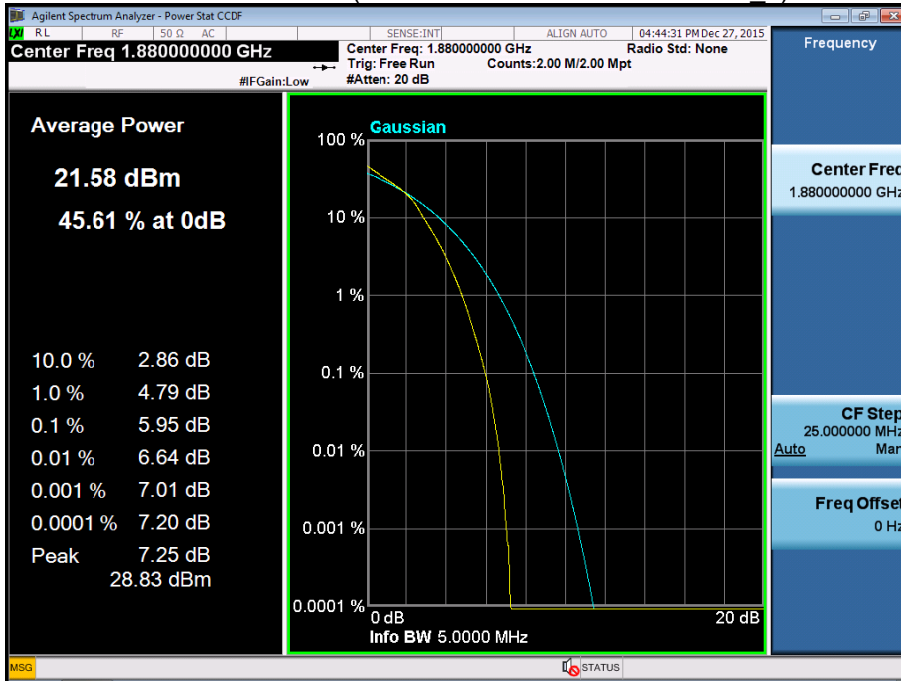

BAND 2. PAR Plot (10M BW Ch.18900 QPSK RB 50_0)

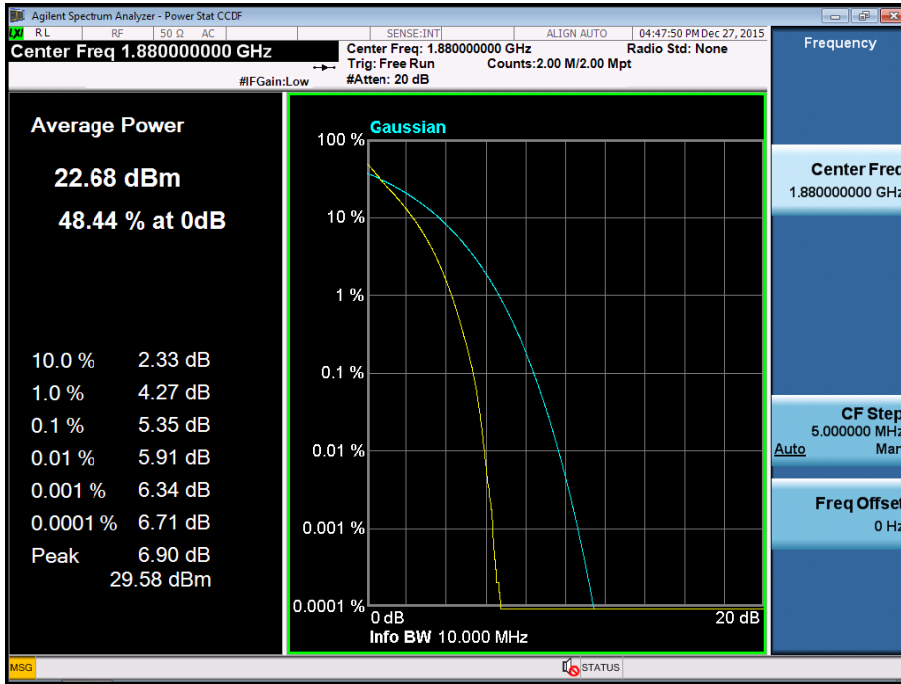

BAND 2. PAR Plot (10M BW Ch.18900 16QAM RB 50_0)

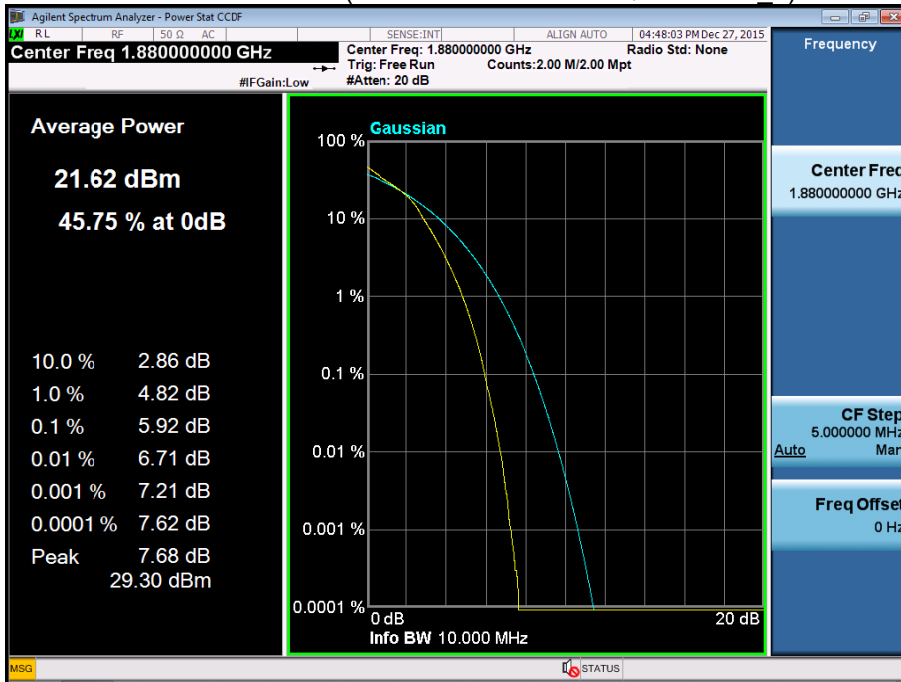

BAND 2. PAR Plot (15M BW Ch.18900 QPSK RB 75_0)

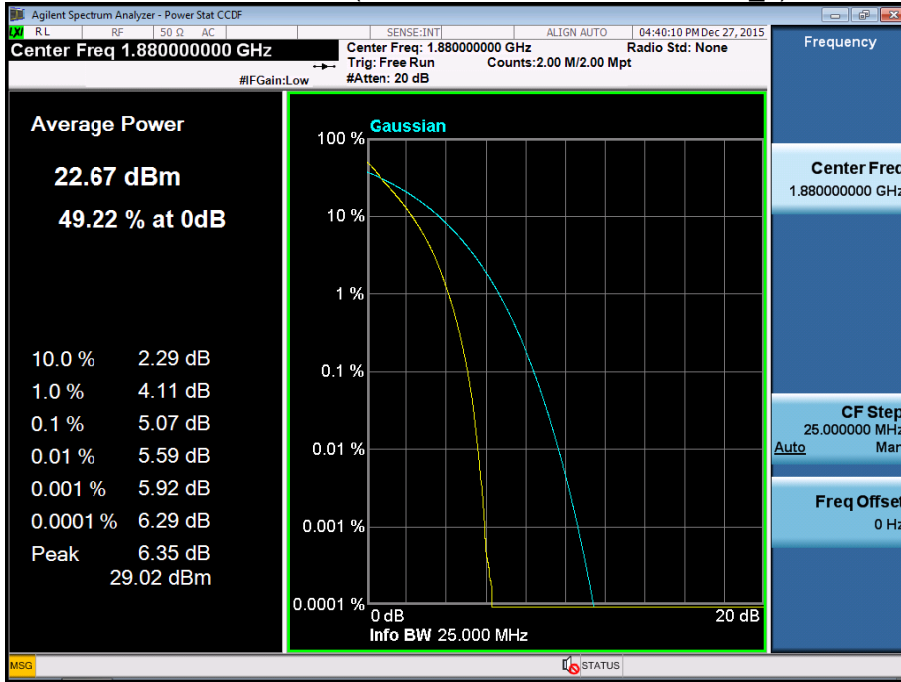

BAND 2. PAR Plot (15M BW Ch.18900 16QAM RB 75_0)

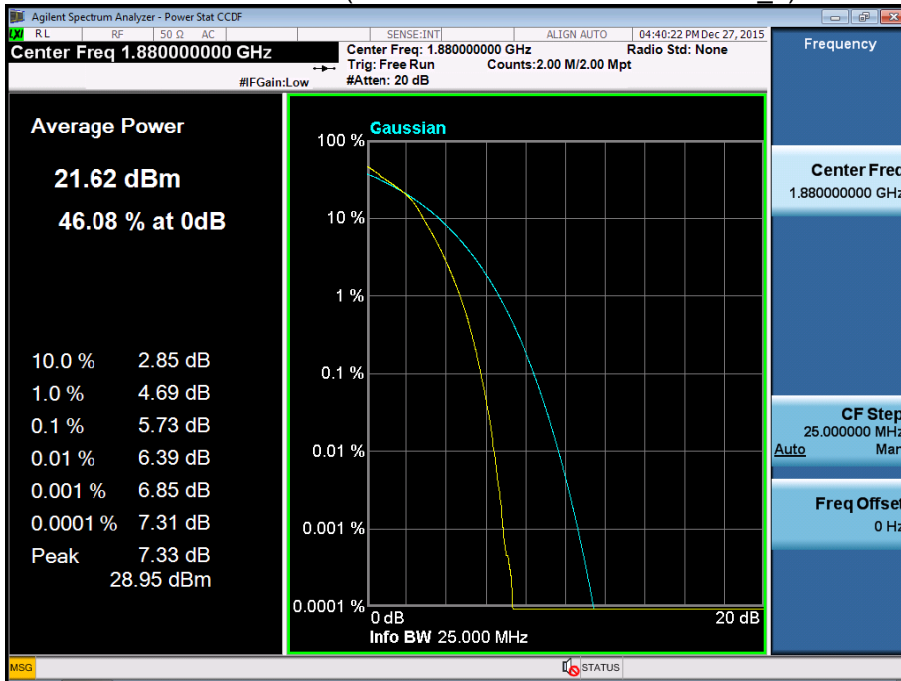

BAND 2. PAR Plot (20M BW Ch.18900 QPSK RB 100_0)

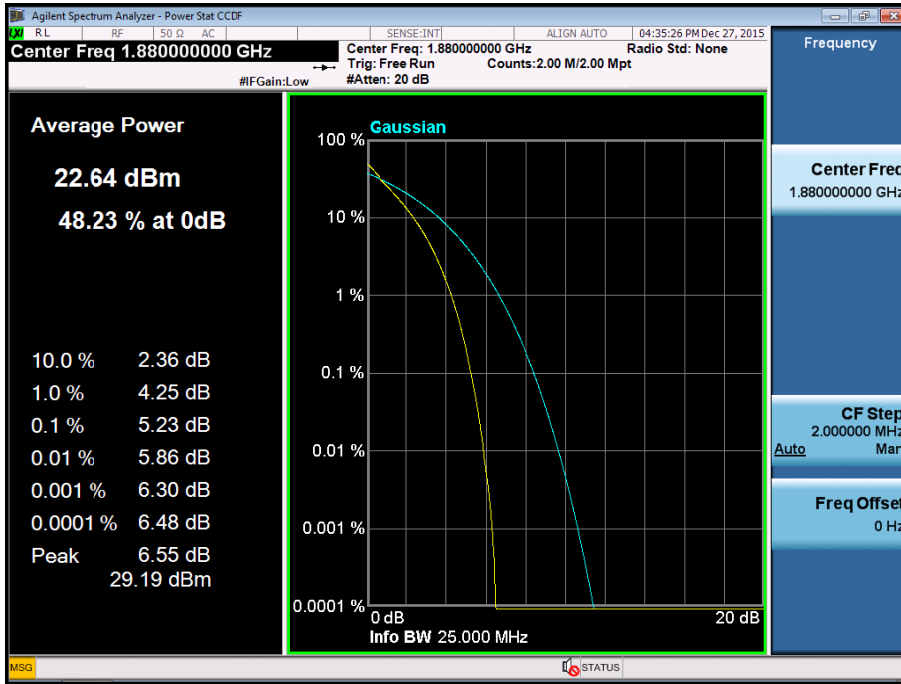

BAND 2. PAR Plot (20M BW Ch.18900 16QAM RB 100_0)

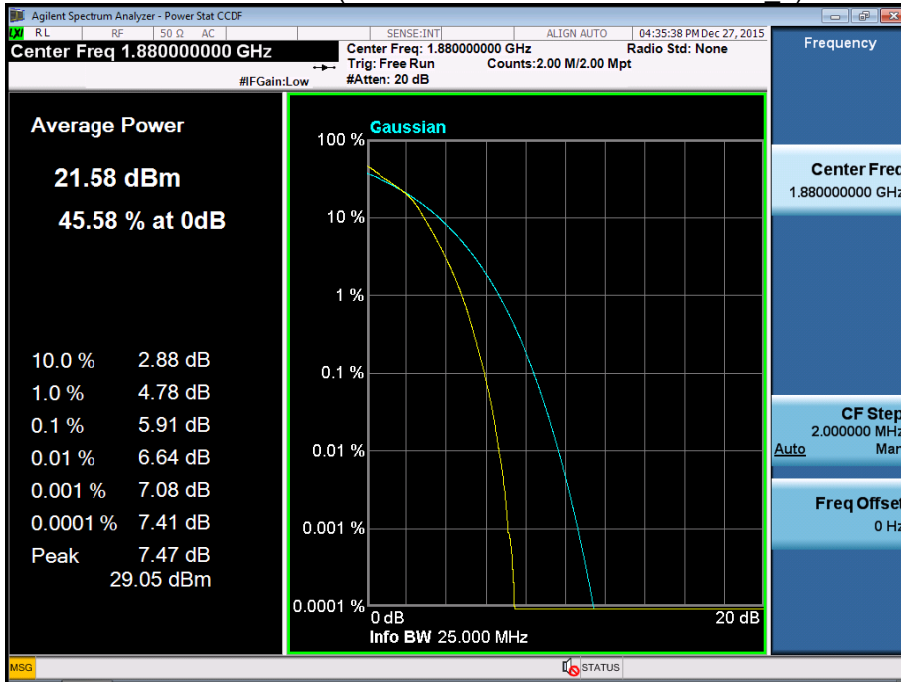

BAND 2. Lower Band Edge Plot (1.4M BW Ch.18607 QPSK_RB1_Offset 0) -1



BAND 2. Lower Band Edge Plot (1.4M BW Ch.18607 QPSK_RB6_Offset 0) -2

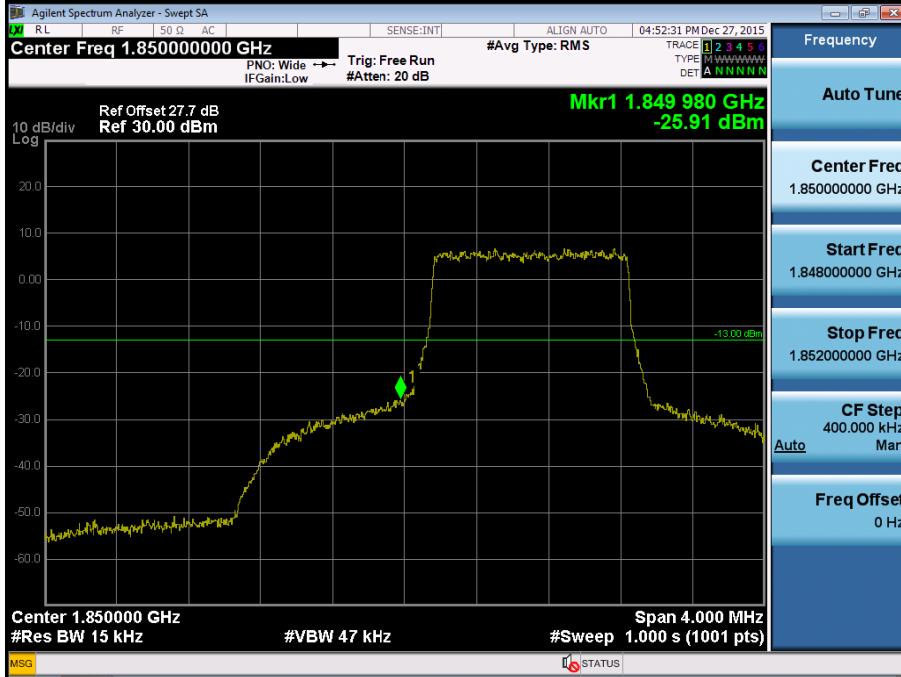

BAND 2. Lower Extended Band Edge Plot (1.4M BW Ch.18607 QPSK_RB6_0) -3

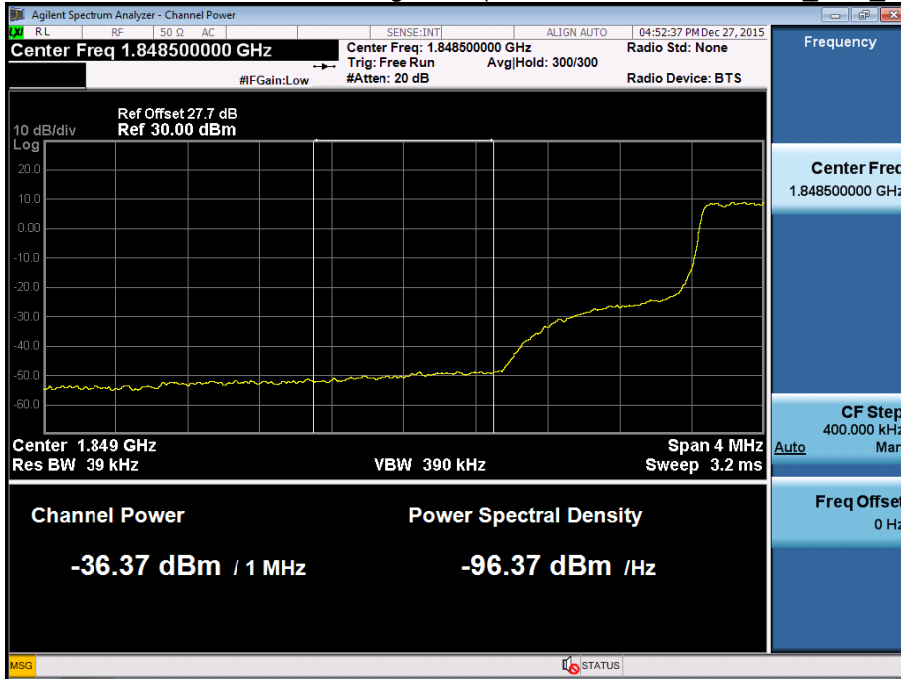

BAND 2. Lower Band Edge Plot (3M BW Ch.18615 QPSK_RB1_Offset 0) -1

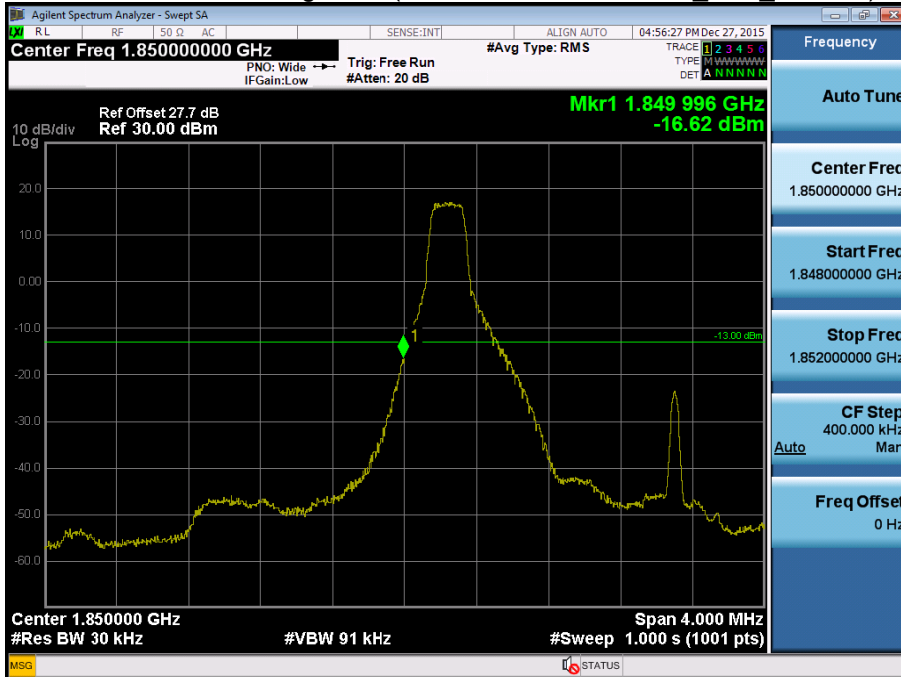

BAND 2. Lower Band Edge Plot (3M BW Ch.18615 QPSK_RB15_Offset 0) -2

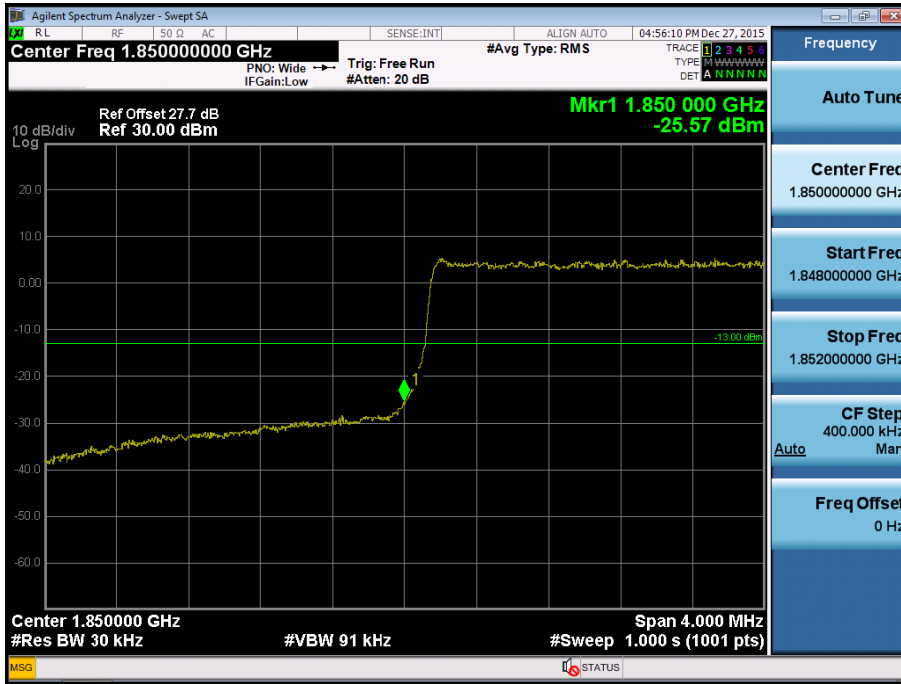

BAND 2. Lower Extended Band Edge Plot (3M BW Ch.18615 QPSK_RB15_0) -3

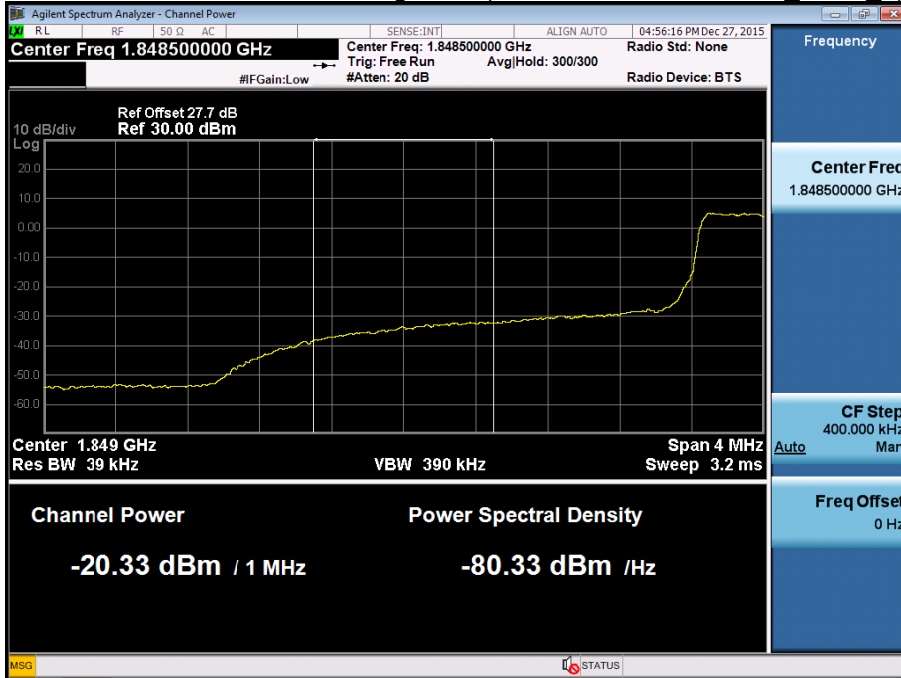

BAND 2. Lower Band Edge Plot (5M BW Ch.18625 QPSK_RB1_Offset 0) -1

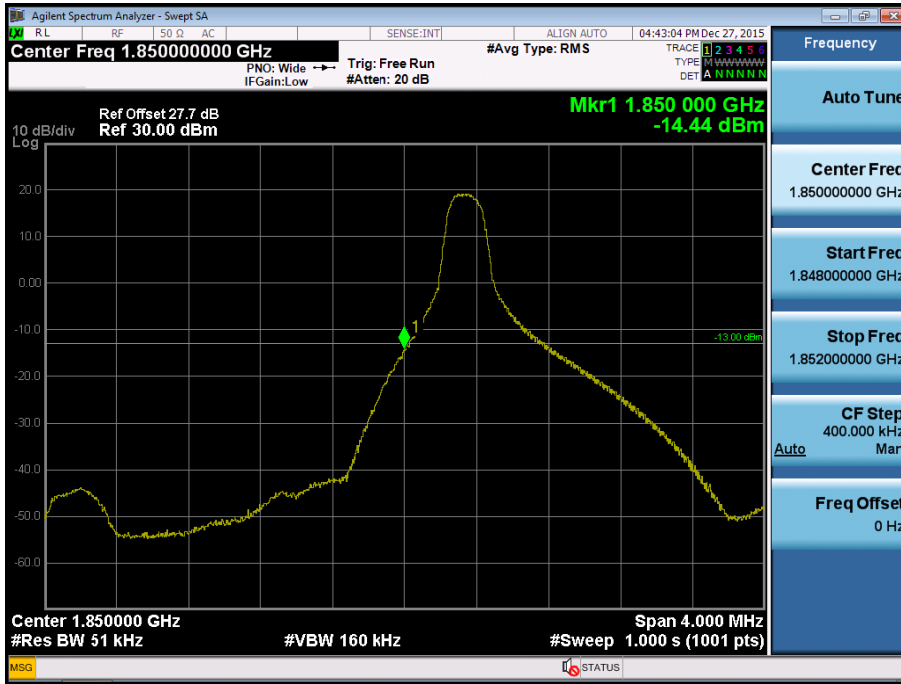

BAND 2. Lower Band Edge Plot (5M BW Ch.18625 QPSK_RB25_Offset 0) -2



BAND 2. Lower Extended Band Edge Plot (5M BW Ch.18625 QPSK_RB25_0) -3

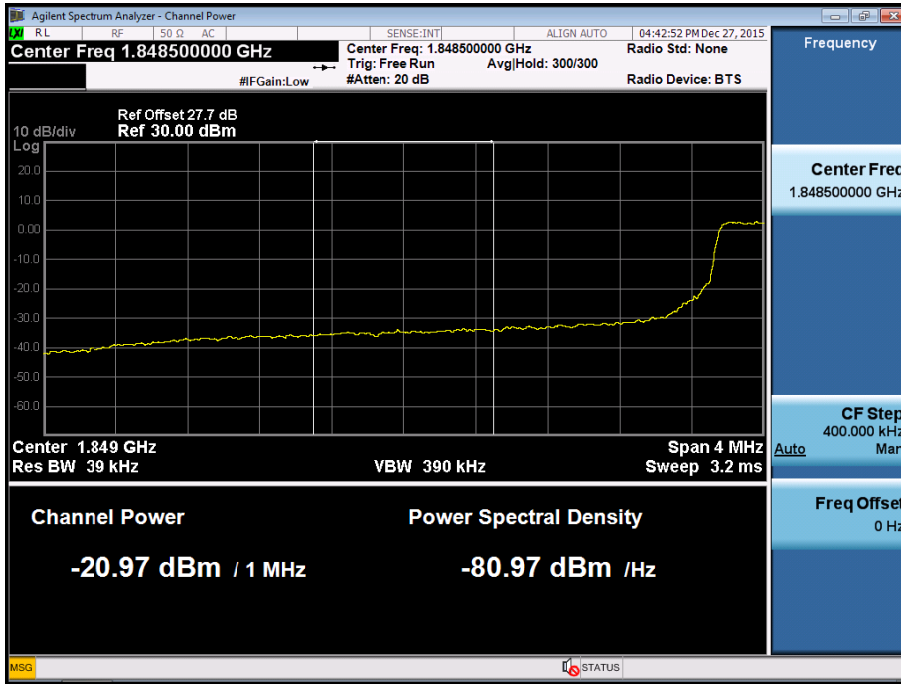

BAND 2. Lower Band Edge Plot (10M BW Ch.18650 QPSK_RB1_Offset 0) -1

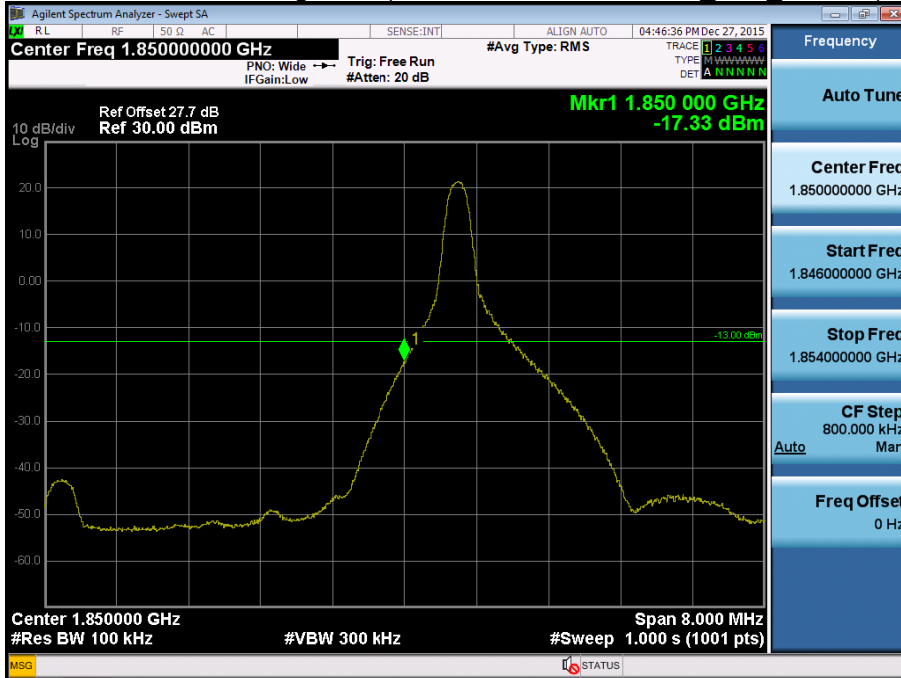

BAND 2. Lower Band Edge Plot (10M BW Ch.18650 QPSK_RB50_Offset 0) -2

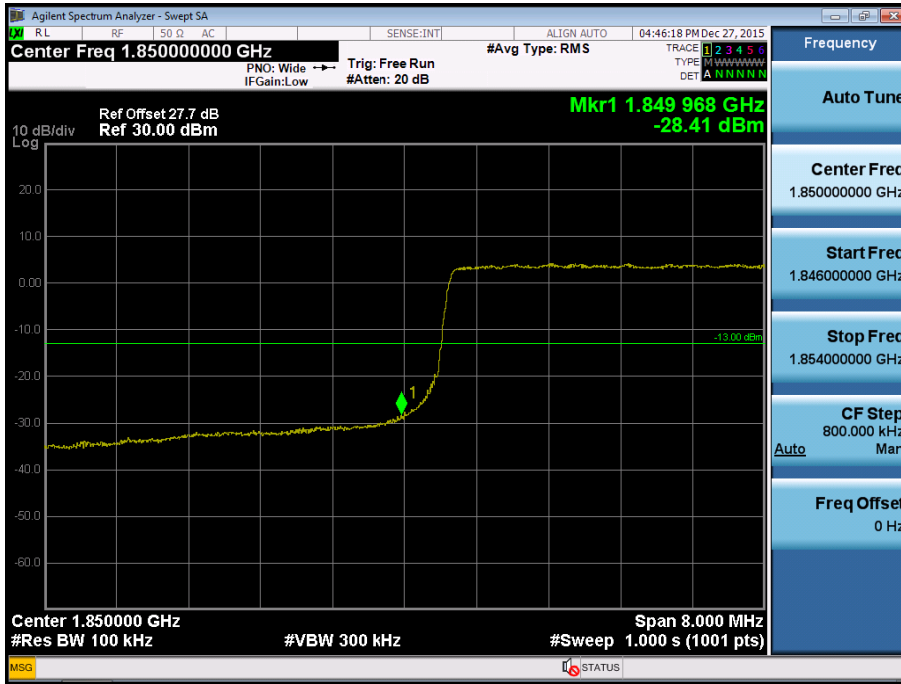

BAND 2. Lower Extended Band Edge Plot (10M BW Ch.18650 QPSK_RB50_0) -3

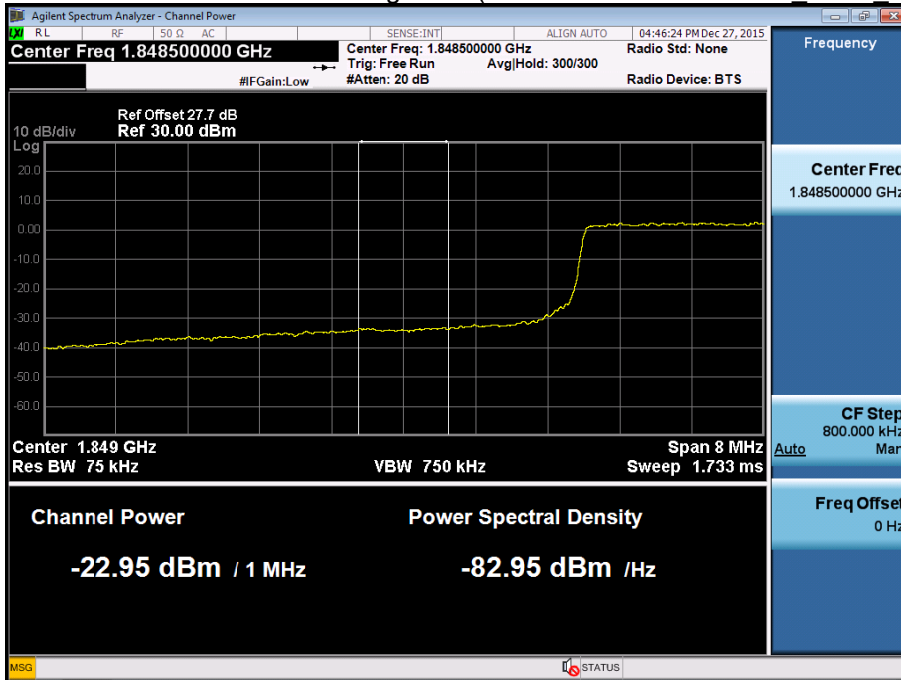

BAND 2. Lower Band Edge Plot (15M BW Ch.18675 QPSK_RB75_Offset 0) -1

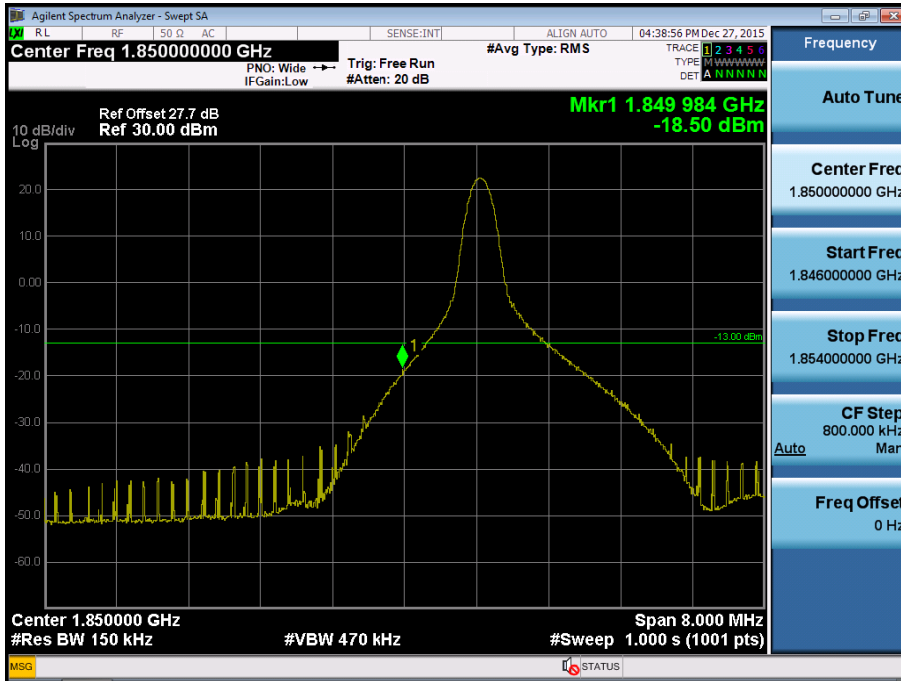

BAND 2. Lower Band Edge Plot (15M BW Ch.18675 QPSK_RB75_Offset 0) -2

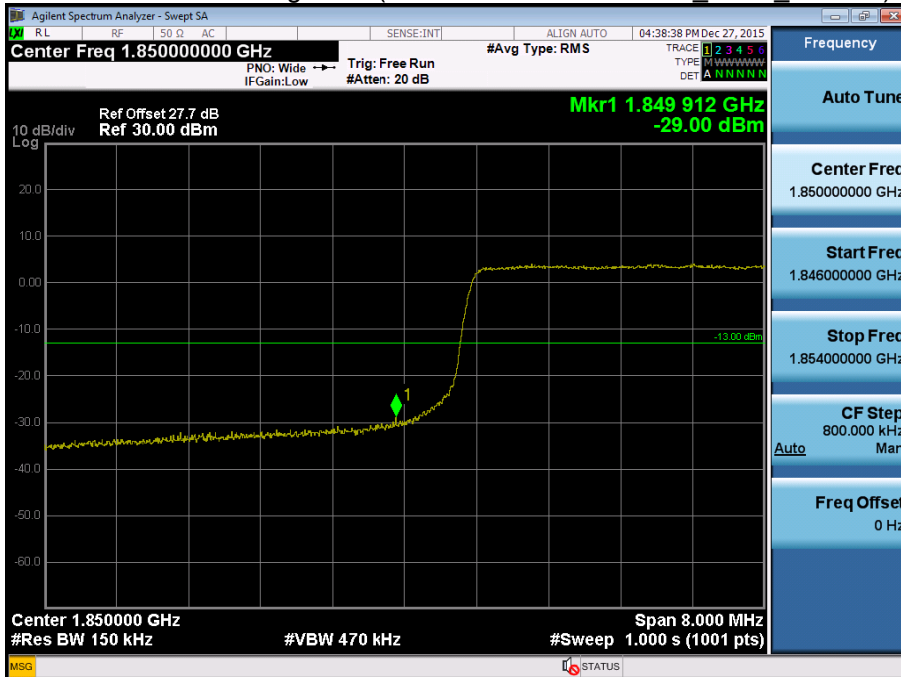

BAND 2. Lower Extended Band Edge Plot (15M BW Ch.18675 QPSK_RB75_0) -3

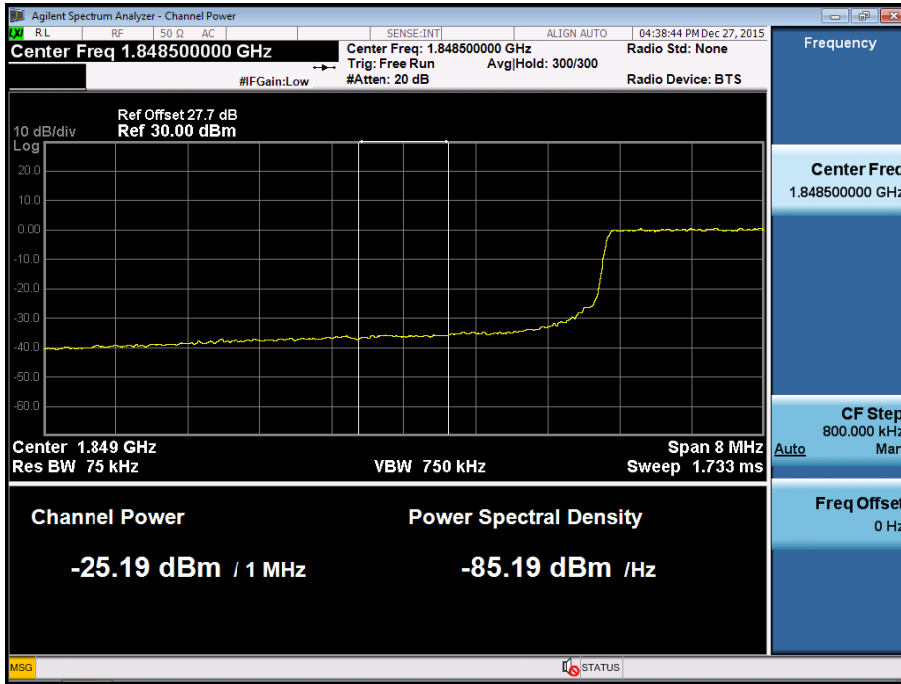

BAND 2. Lower Band Edge Plot (20M BW Ch.18700 QPSK_RB1_Offset 0) -1

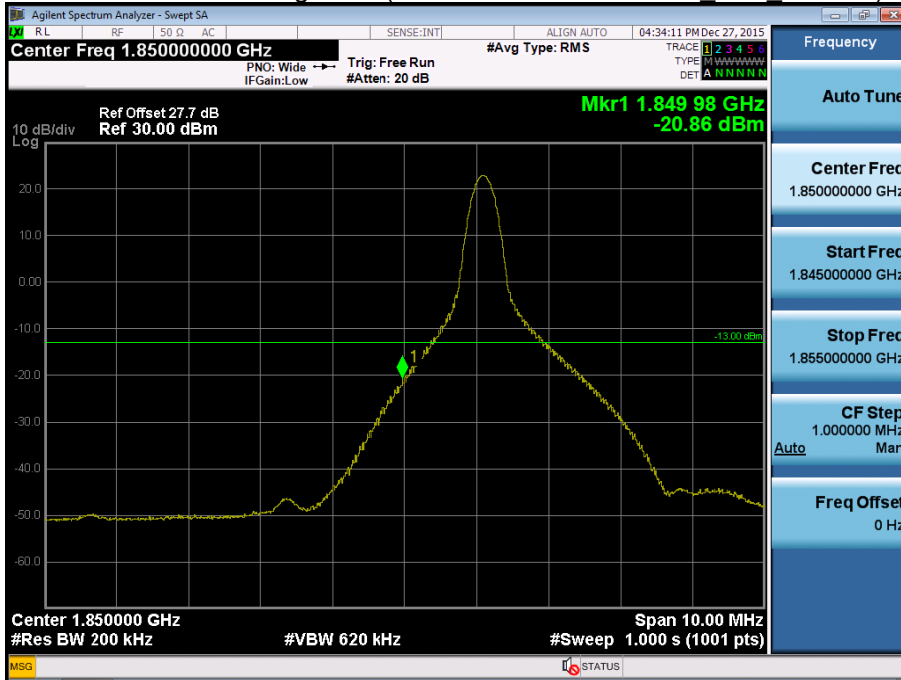

BAND 2. Lower Band Edge Plot (20M BW Ch.18700 QPSK_RB100_Offset 0) -2

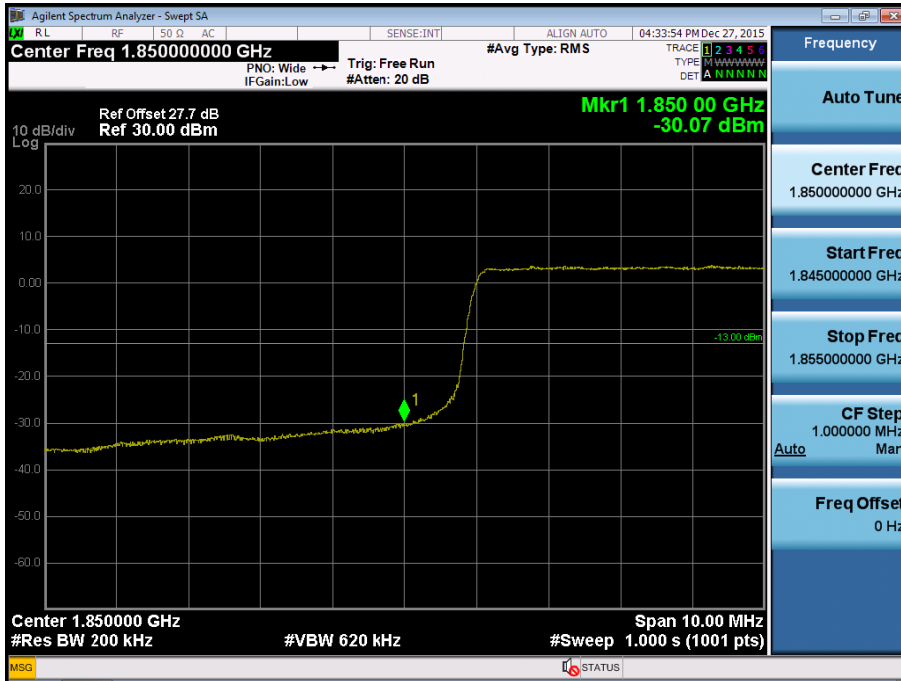

BAND 2. Lower Extended Band Edge Plot (20M BW Ch.18700 QPSK RB100 0) -3

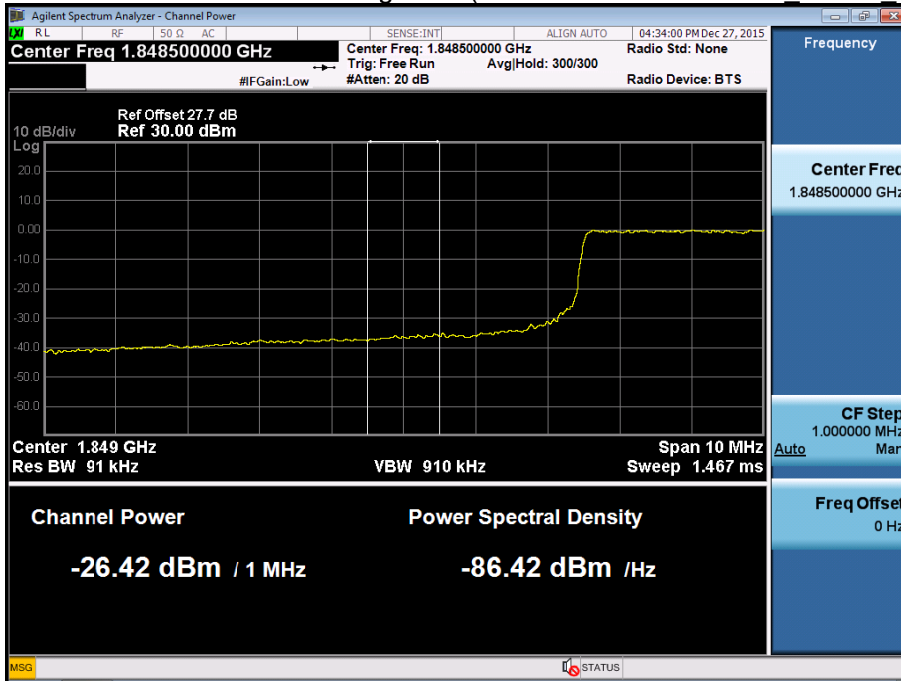

BAND 2. Upper Band Edge Plot (1.4M BW Ch.19193 QPSK_RB1_Offset 5) -1

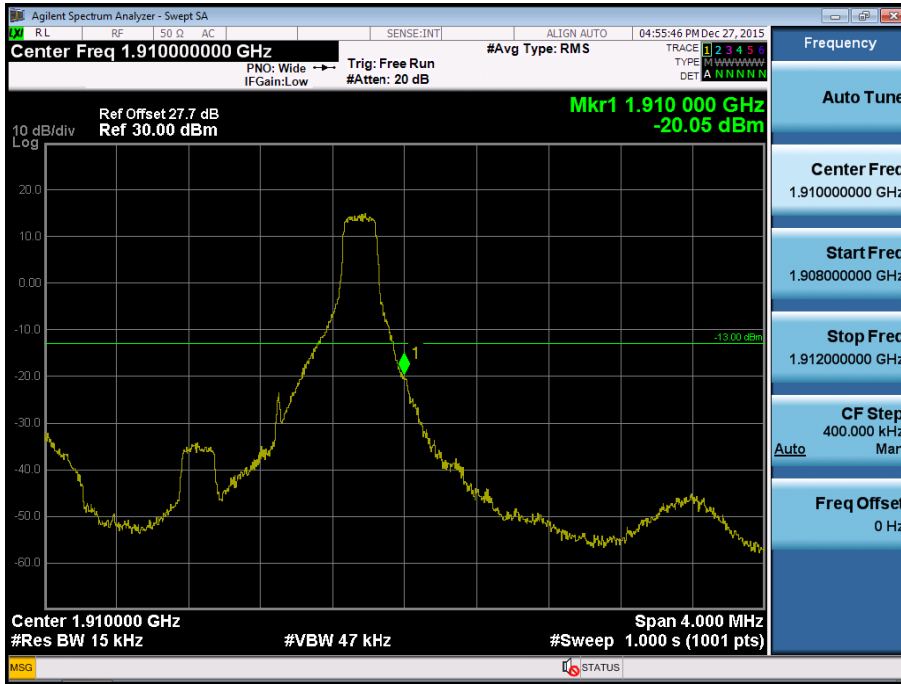

BAND 2. Upper Band Edge Plot (1.4M BW Ch.19193 QPSK_RB6_Offset 0) -2



BAND 2. Upper Extended Band Edge Plot (1.4M BW Ch.19193 QPSK_RB6_0) -3

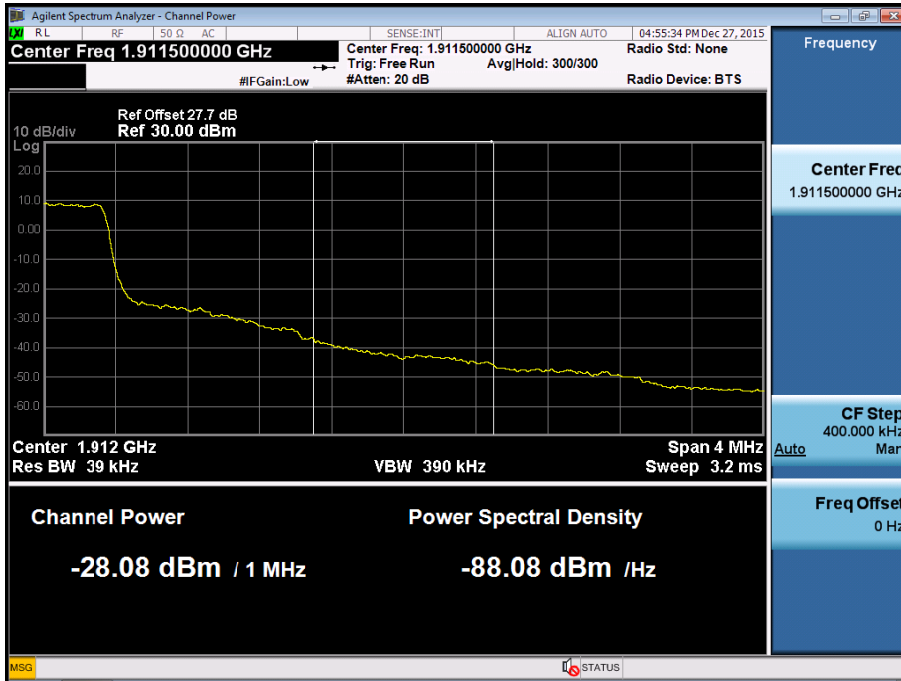

BAND 2. Upper Band Edge Plot (3M BW Ch.19185 QPSK_RB1_Offset 14) -1

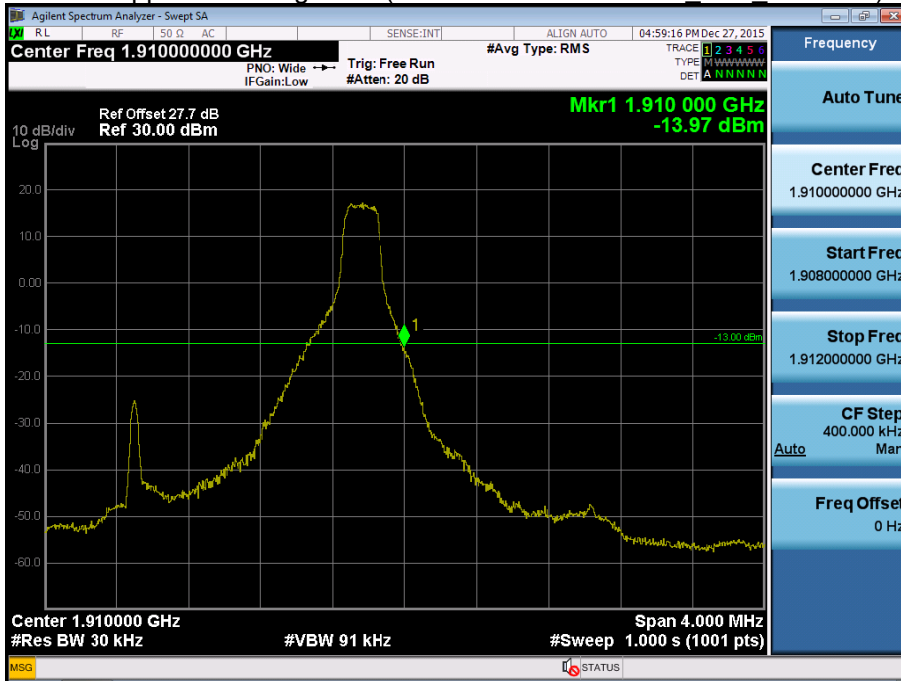

BAND 2. Upper Band Edge Plot (3M BW Ch.19185 QPSK_RB15_Offset 0) -2

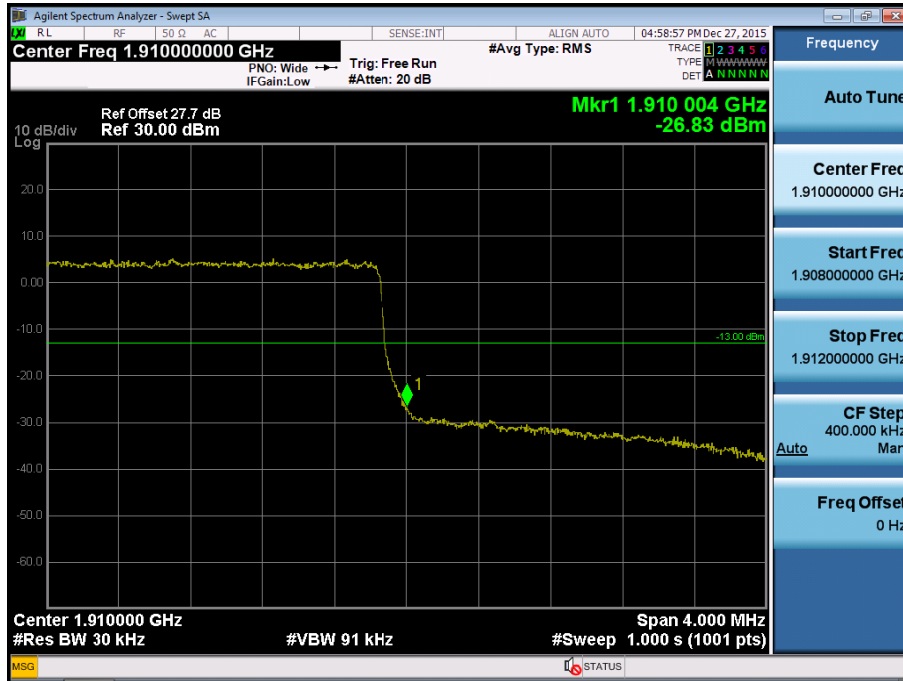

BAND 2. Upper Extended Band Edge Plot (3M BW Ch.19185 QPSK_RB15 0) -3



BAND 2. Upper Band Edge Plot (5M BW Ch.19175 QPSK_RB1_Offset 24) -1

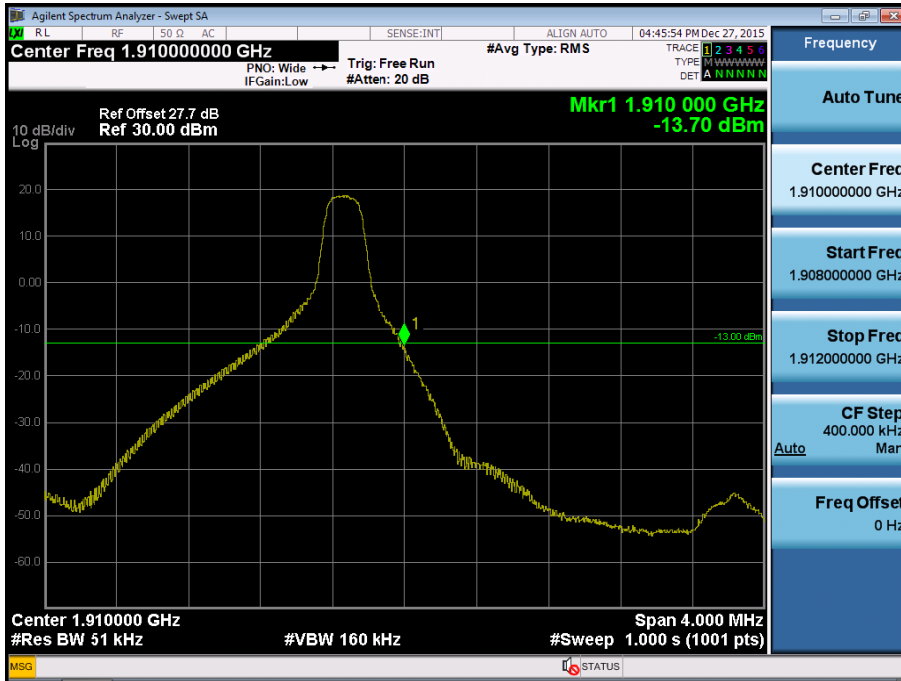

BAND 2. Upper Band Edge Plot (5M BW Ch.19175 QPSK_RB25_Offset 0) -2



BAND 2. Upper Extended Band Edge Plot (5M BW Ch.19175 QPSK_RB25_0) -3

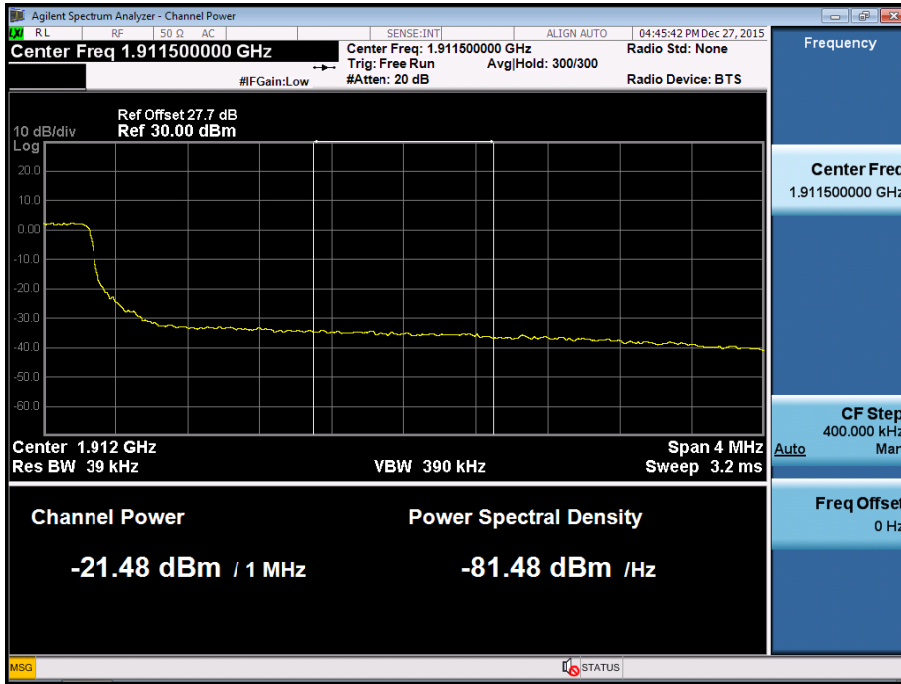

BAND 2. Upper Band Edge Plot (10M BW Ch.19150 QPSK_RB1_Offset 49) -1

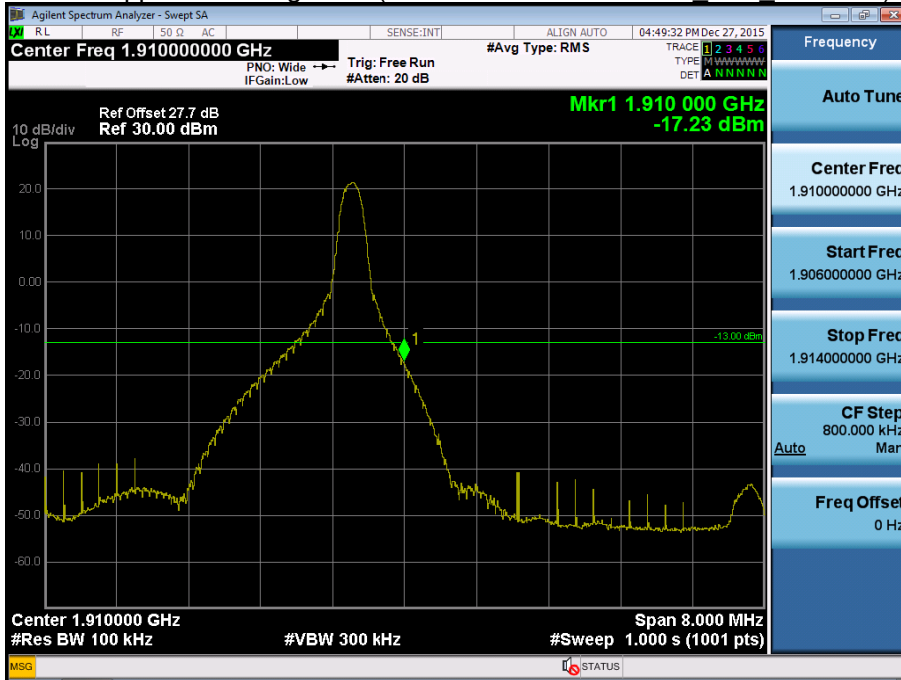

BAND 2. Upper Band Edge Plot (10M BW Ch.19150 QPSK_RB50_Offset 0) -2



BAND 2. Upper Extended Band Edge Plot (10M BW Ch.19150 QPSK_RB50_0) -3

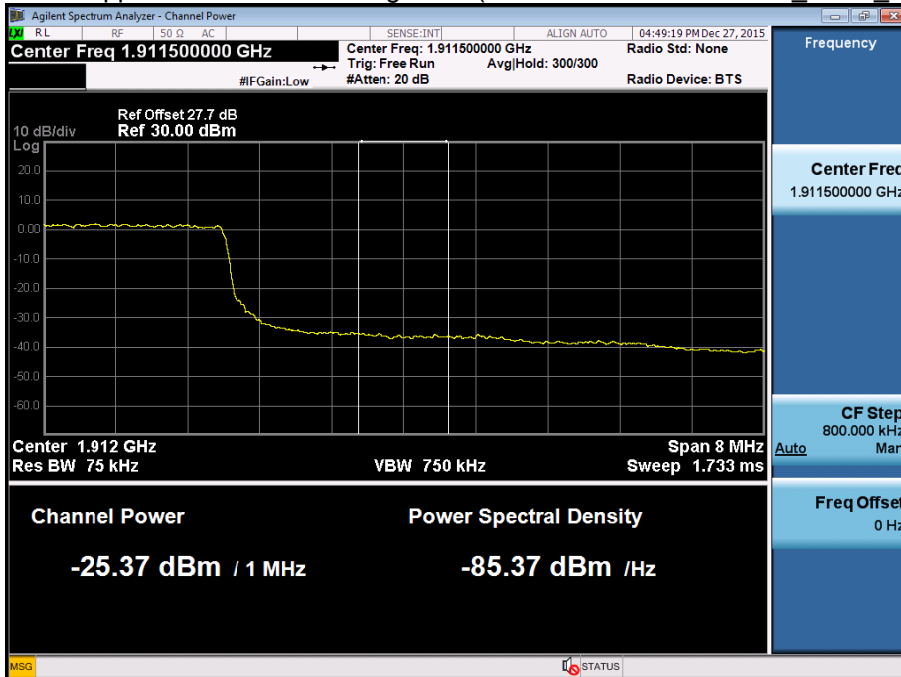

BAND 2. Upper Band Edge Plot (15M BW Ch.19125 QPSK_RB1_Offset 74) -1

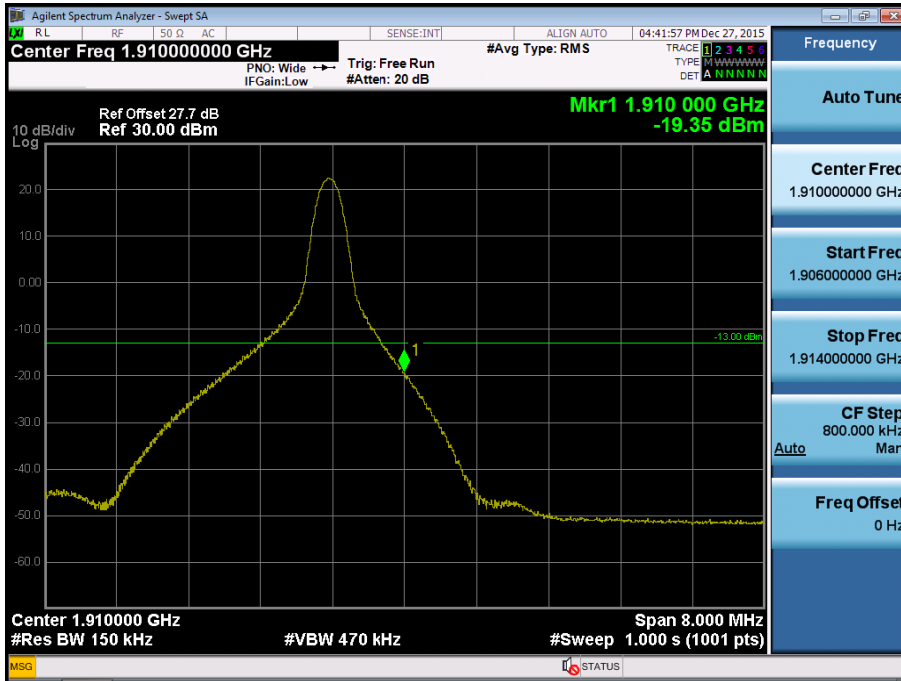

BAND 2. Upper Band Edge Plot (15M BW Ch.19125 QPSK_RB75_Offset 0) -2



BAND 2. Upper Extended Band Edge Plot (15M BW Ch.19125 QPSK_RB75_0) -3

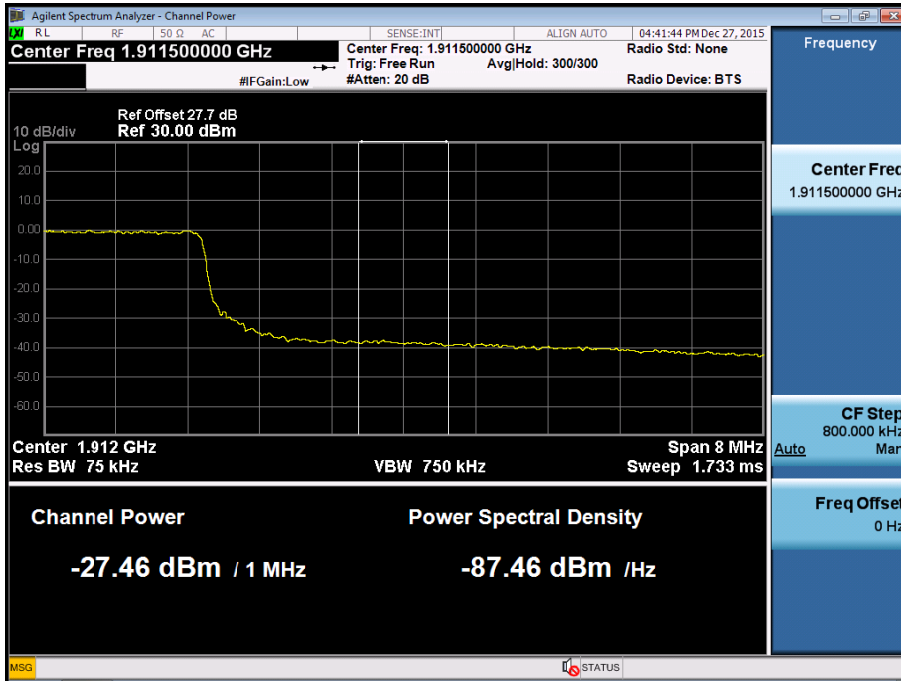

BAND 2. Upper Band Edge Plot (20M BW Ch.19100 QPSK_RB1_Offset 99) -1

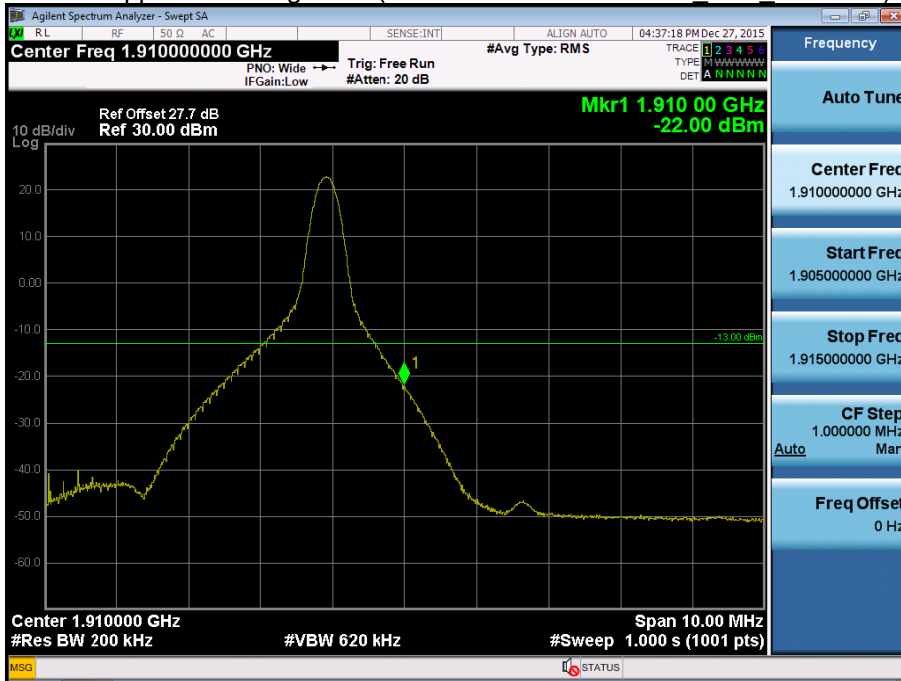

BAND 2. Upper Band Edge Plot (20M BW Ch.19100 QPSK_RB100_Offset 0) -2



BAND 2. Upper Extended Band Edge Plot (20M BW Ch.19100 QPSK_RB100_0) -3

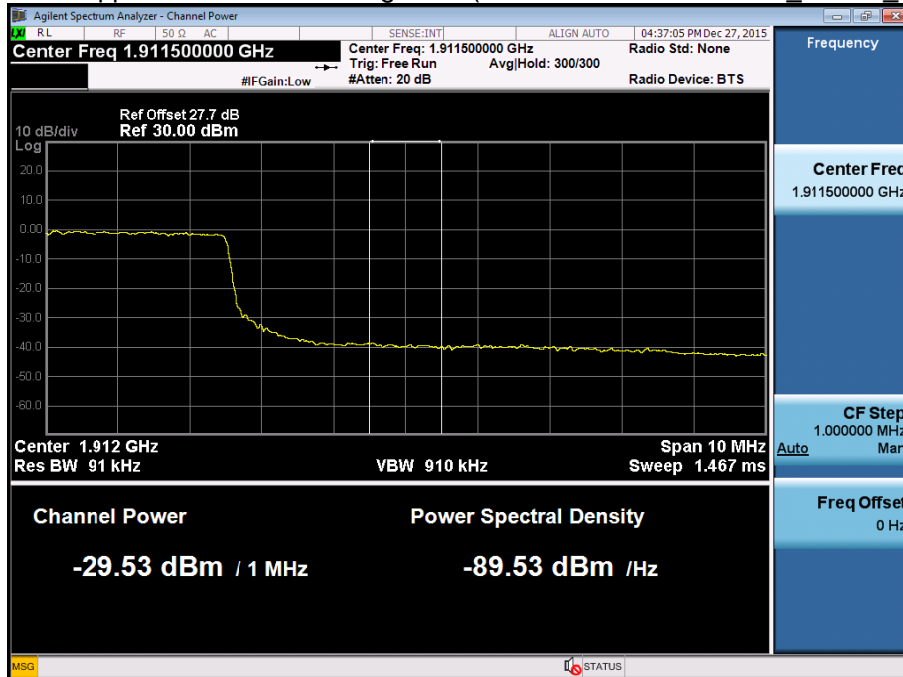

BAND 5. Lower Band Edge Plot (1.4M BW Ch.20407 QPSK_RB1_Offset 0)

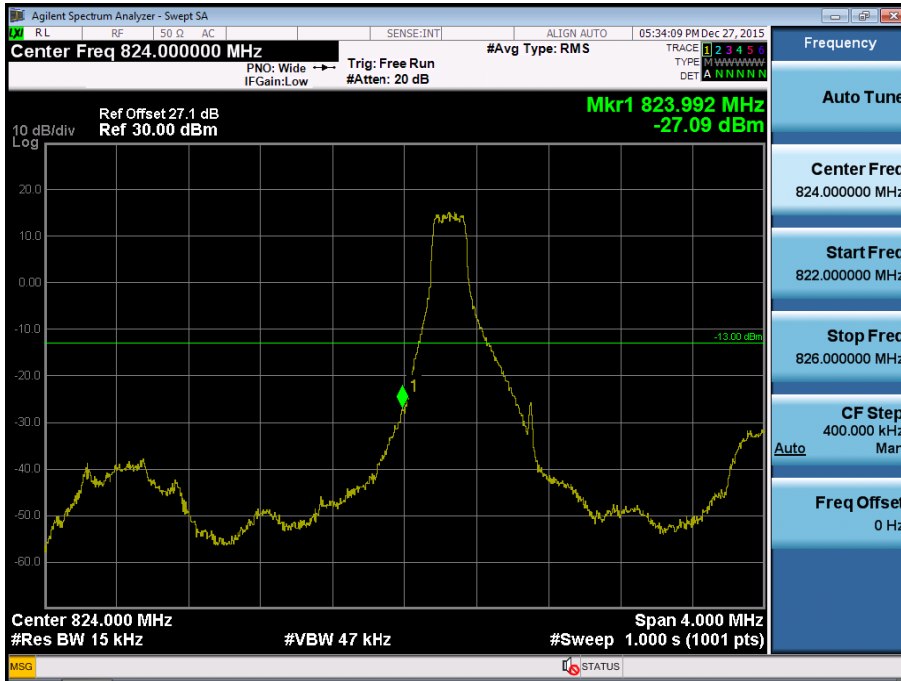

BAND 5. Lower Band Edge Plot (1.4M BW Ch.20407 QPSK_RB6_Offset 0)

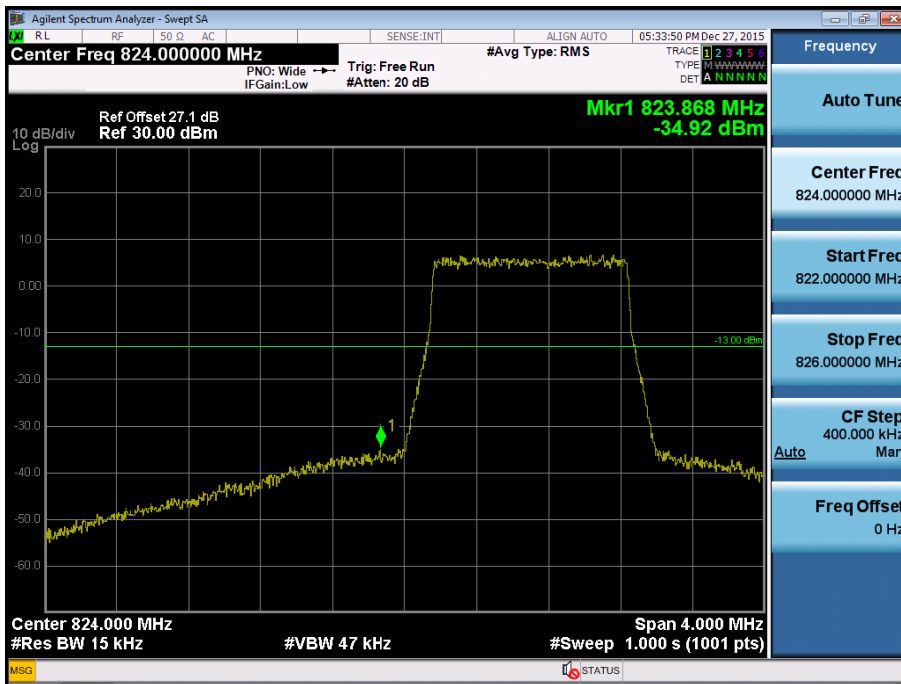

BAND 5. Lower Extended Band Edge Plot (1.4M BW Ch.20407 QPSK_RB6_0)



BAND 5. Lower Band Edge Plot (3M BW Ch.20415 QPSK_RB1_Offset 0)

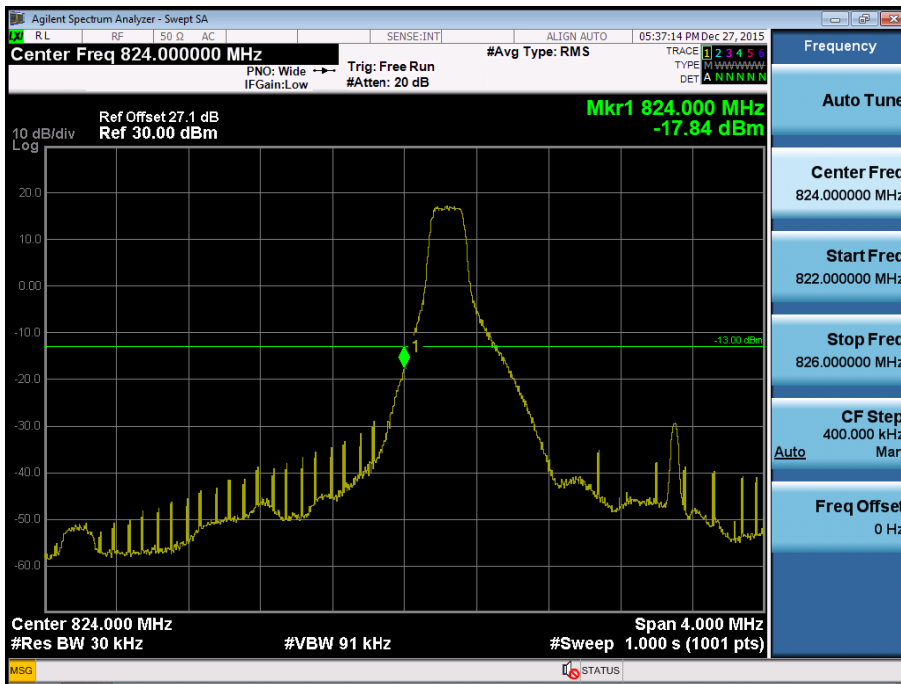

BAND 5. Lower Band Edge Plot (3M BW Ch.20415 QPSK_RB15_Offset 0)

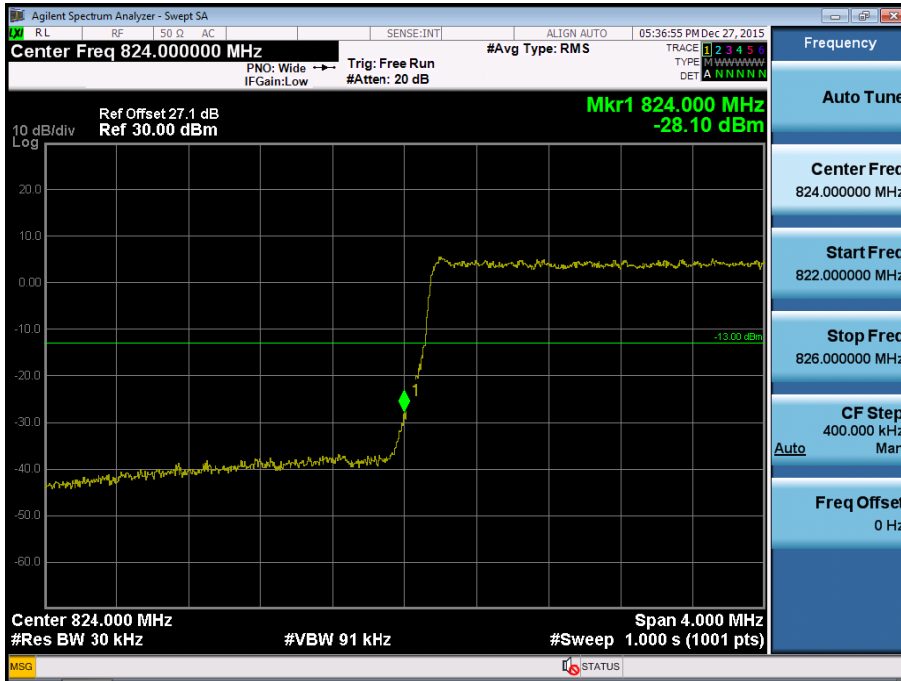

BAND 5. Lower Extended Band Edge Plot (3M BW Ch.20415 QPSK_RB15_0)

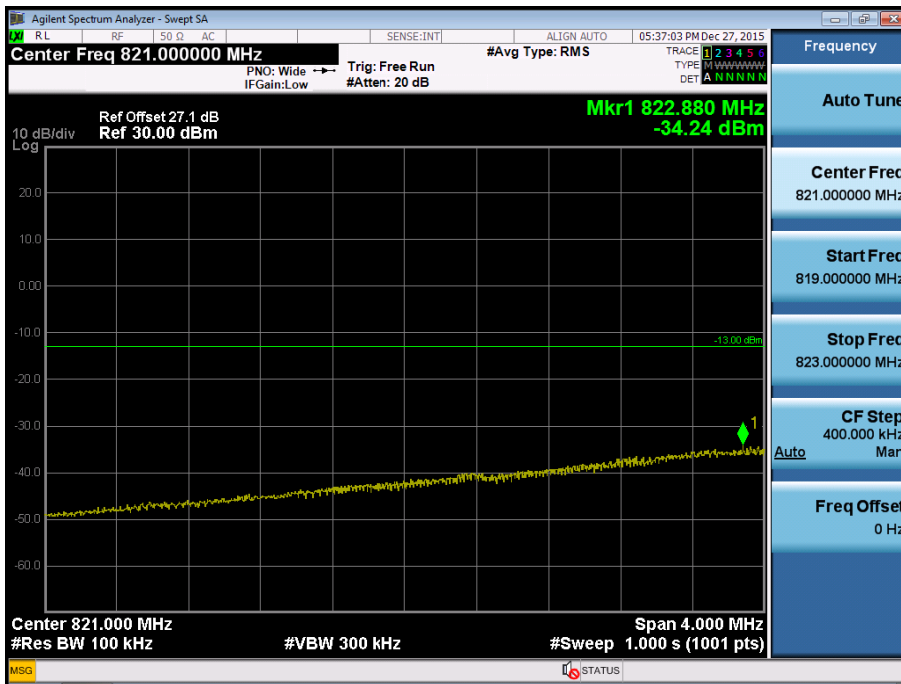

BAND 5. Lower Band Edge Plot (5M BW Ch.20425 QPSK_RB1_Offset 0)

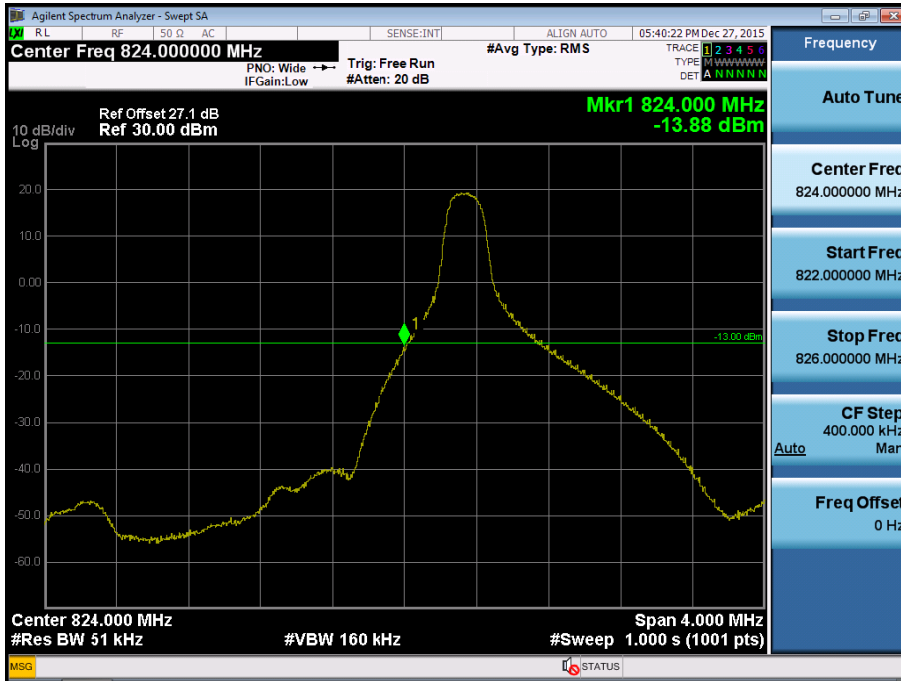

BAND 5. Lower Band Edge Plot (5M BW Ch.20425 QPSK_RB25_Offset 0)

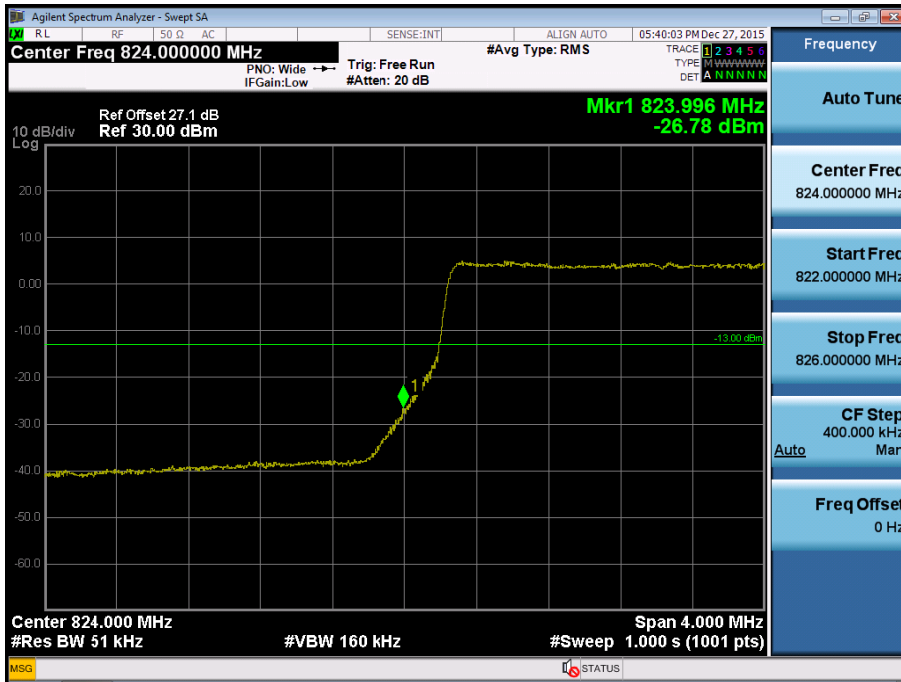

BAND 5. Lower Extended Band Edge Plot (5M BW Ch.20425 QPSK_RB25_0)



BAND 5. Lower Band Edge Plot (10M BW Ch.20450 QPSK_RB1_Offset 0)

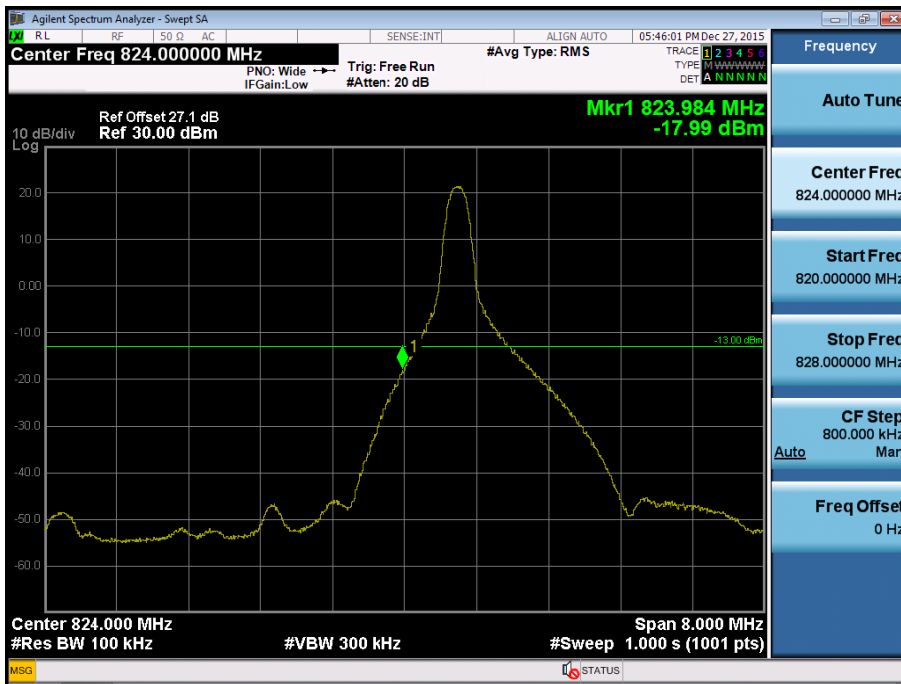

BAND 5. Lower Band Edge Plot (10M BW Ch.20450 QPSK_RB50_Offset 0)

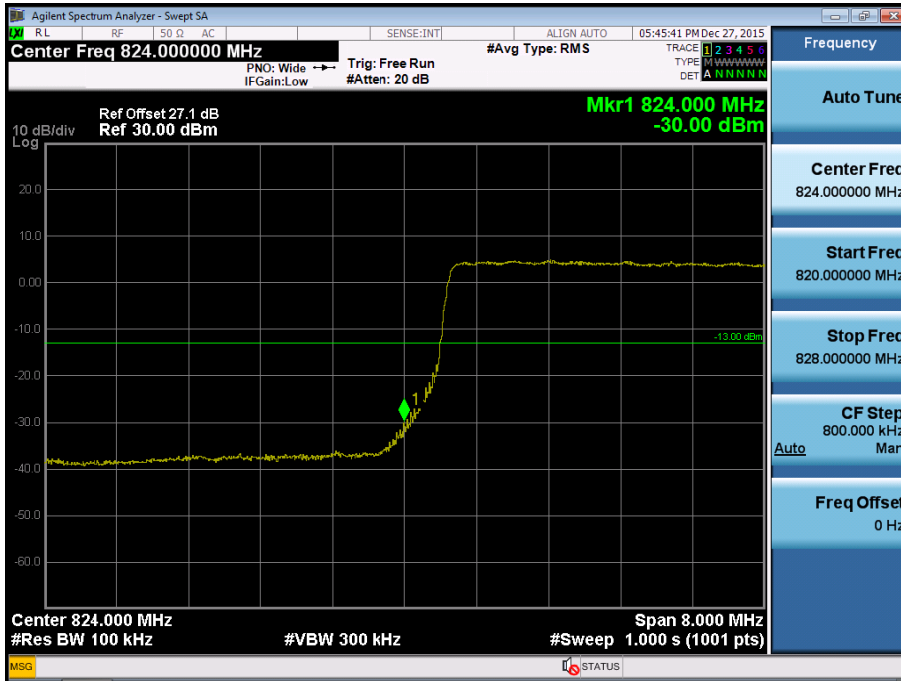

BAND 5. Lower Extended Band Edge Plot (10M BW Ch.20450 QPSK_RB50_0)

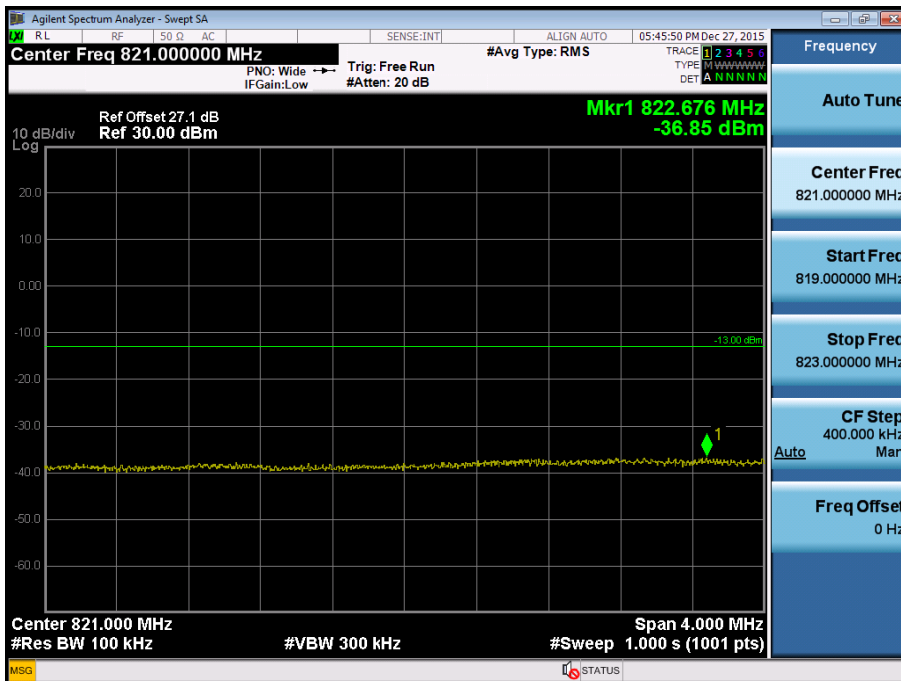

BAND 5. Upper Band Edge Plot (1.4M BW Ch.20643 QPSK_RB1_Offset 5)



BAND 5. Upper Band Edge Plot (1.4M BW Ch.20643 QPSK_RB6_Offset 0)

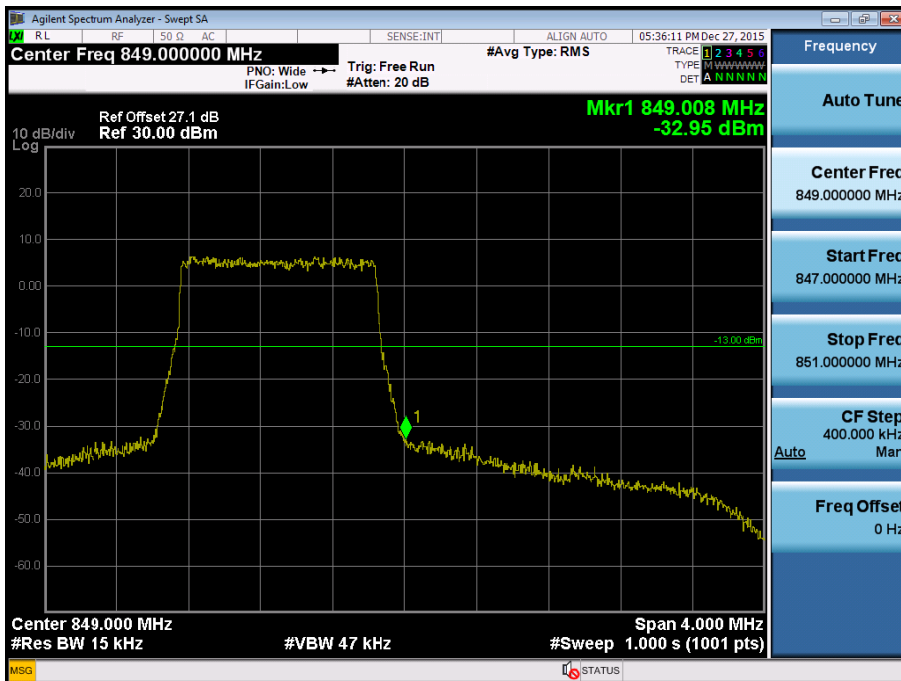

BAND 5. Upper Extended Band Edge Plot (1.4M BW Ch.20643 QPSK_RB6_0)



BAND 5. Upper Band Edge Plot (3M BW Ch.20635 QPSK_RB1_Offset 14)

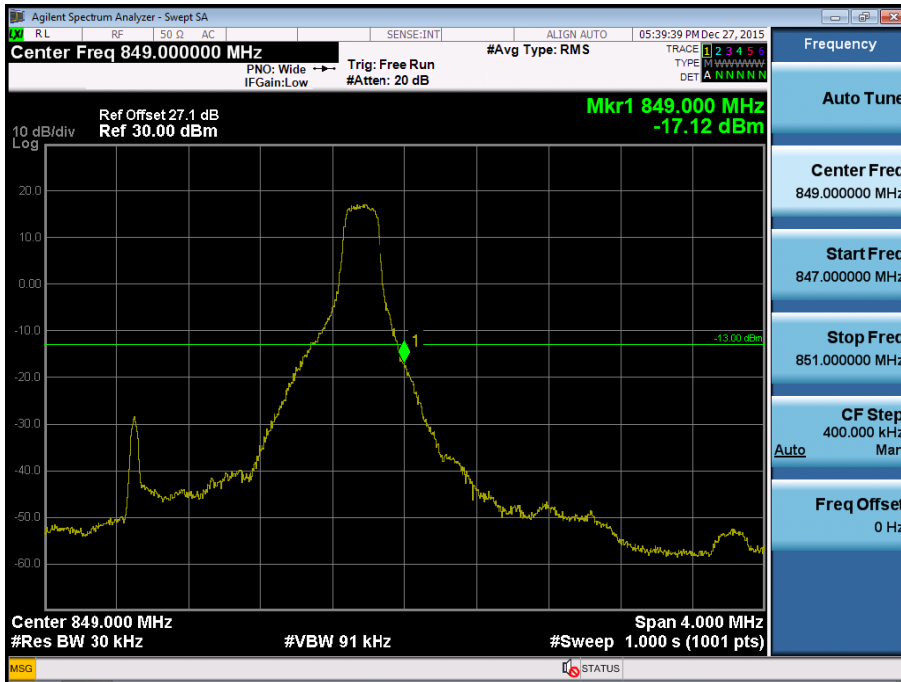

BAND 5. Upper Band Edge Plot (3M BW Ch.20635 QPSK_RB15_Offset 0)



BAND 5. Upper Extended Band Edge Plot (3M BW Ch.20635 QPSK_RB15_0)



BAND 5. Upper Band Edge Plot (5M BW Ch.20625 QPSK_RB1_Offset 24)



BAND 5. Upper Band Edge Plot (5M BW Ch.20625 QPSK_RB25_Offset 0)

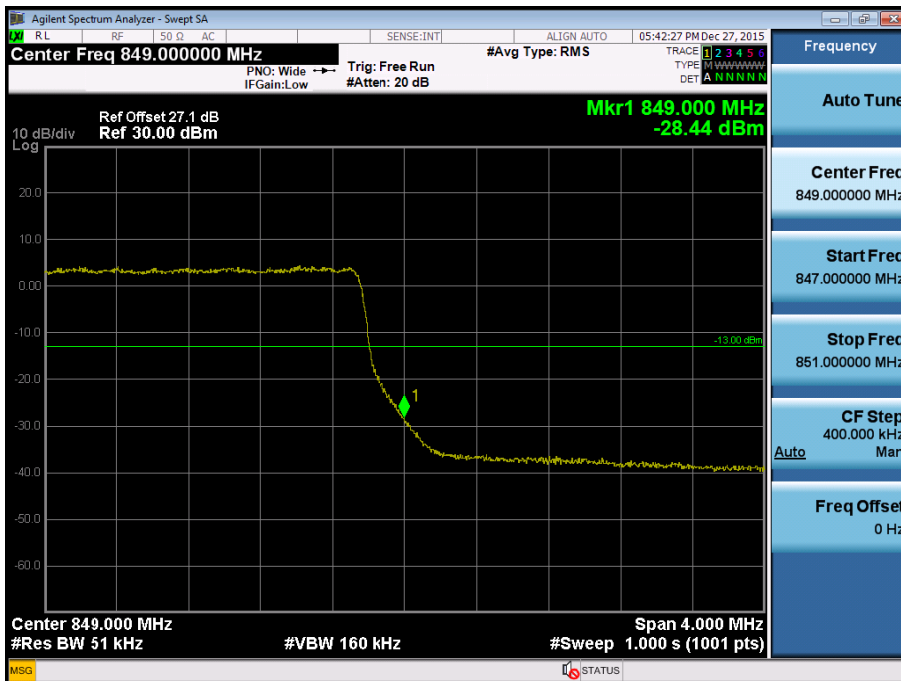

BAND 5. Upper Extended Band Edge Plot (5M BW Ch.20625 QPSK_RB25_0)

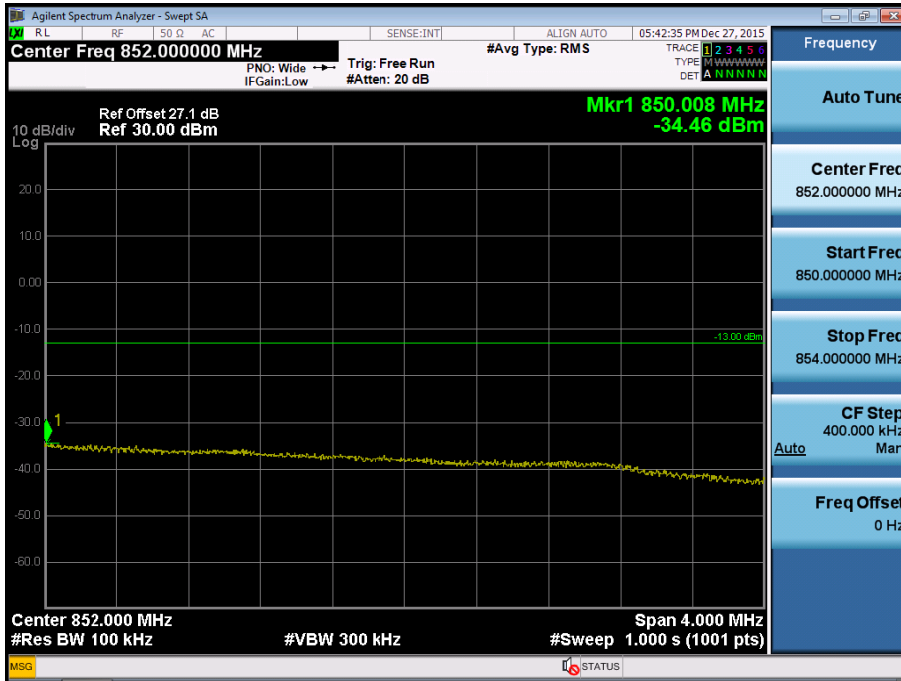

BAND 5. Upper Band Edge Plot (10M BW Ch.20600 QPSK_RB1_Offset 49)

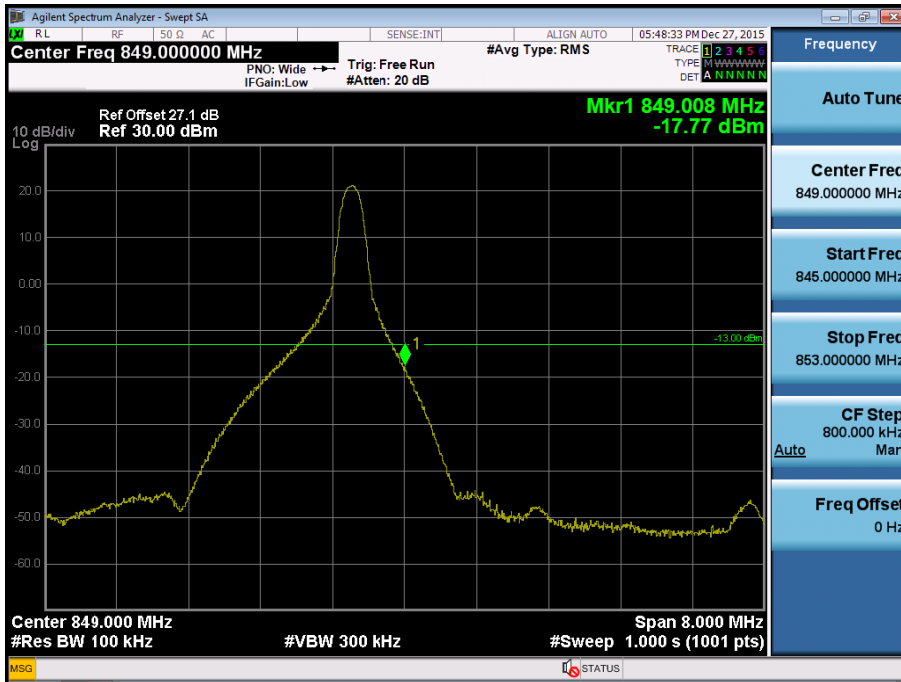

BAND 5. Upper Band Edge Plot (10M BW Ch.20600 QPSK_RB50_Offset 0)



BAND 5. Upper Extended Band Edge Plot (10M BW Ch.20600 QPSK_RB50_0)

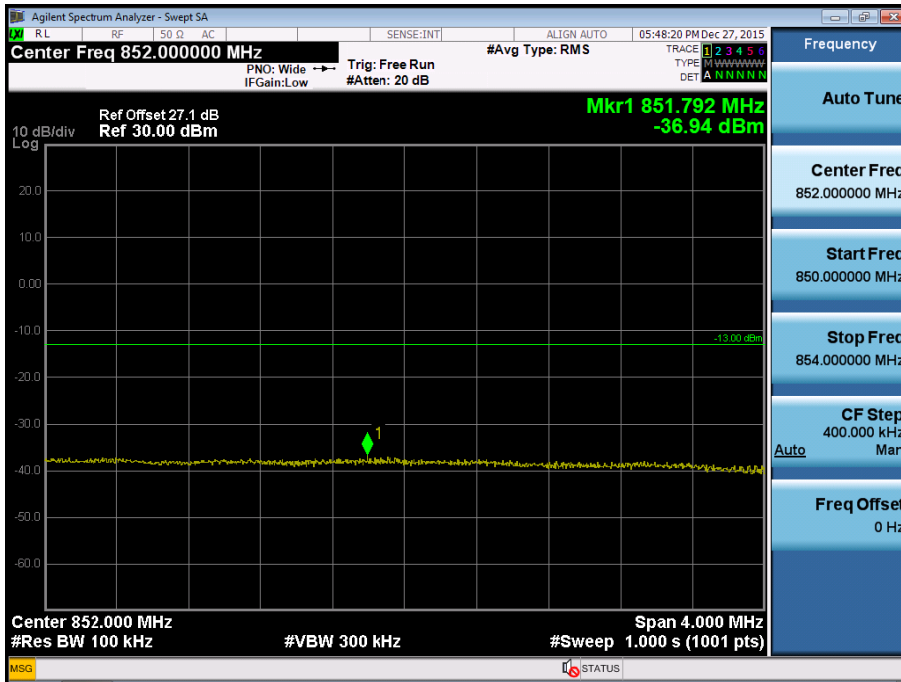

BAND 2. Conducted Spurious_1 (18607ch_1.4MHz_QPSK_RB 1_0)

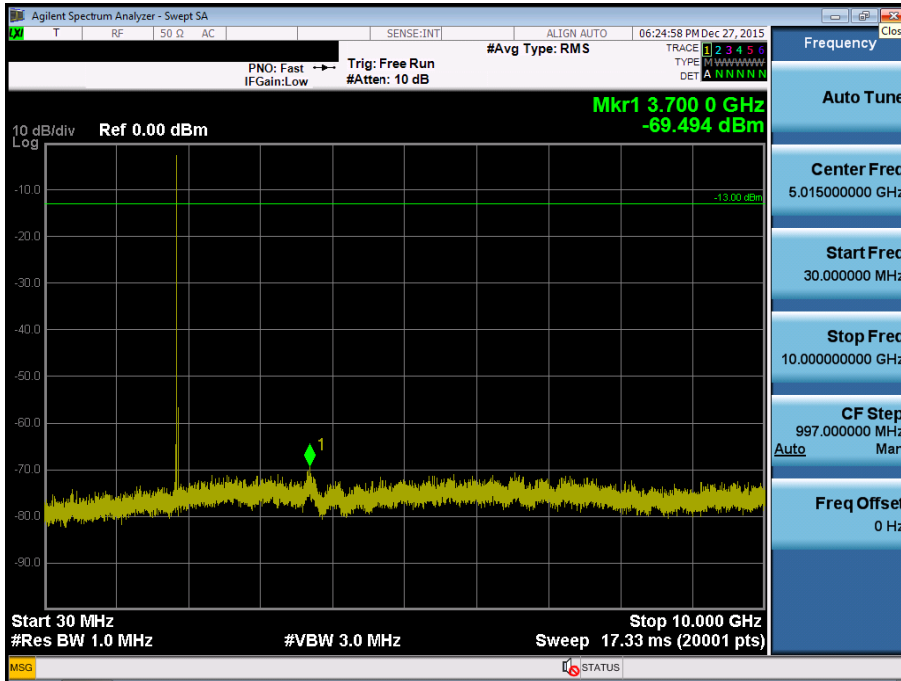

BAND 2. Conducted Spurious_2 (18607ch_1.4MHz_QPSK_RB 1_0)

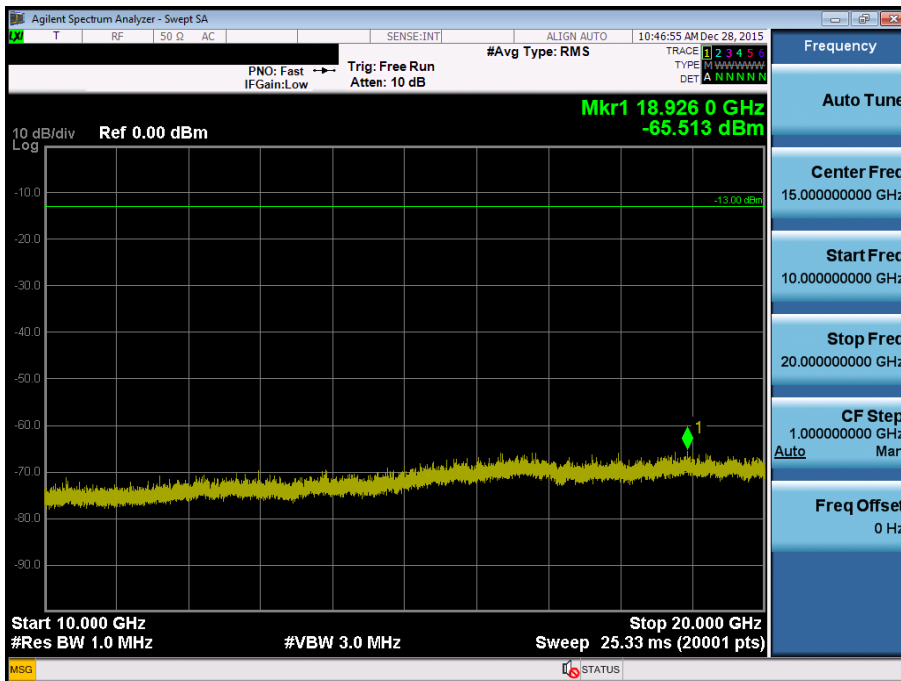

BAND 2. Conducted Spurious_1 (18900ch_1.4MHz_QPSK_RB 1_0)

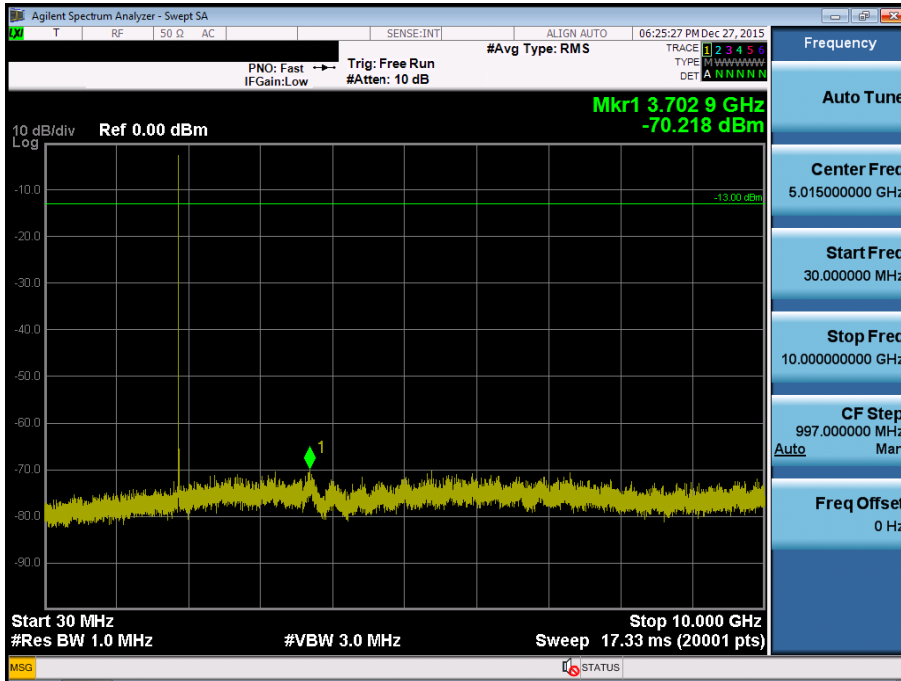

BAND 2. Conducted Spurious_2 (18900ch_1.4MHz_QPSK_RB 1_0)

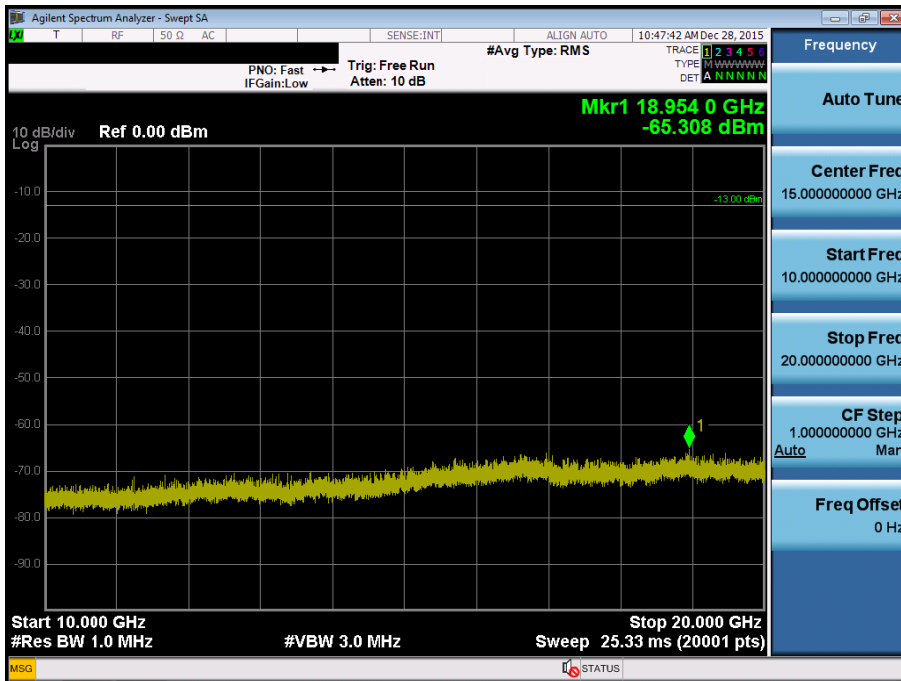

BAND 2. Conducted Spurious_1 (19193ch_1.4MHz_QPSK_RB 1_0)

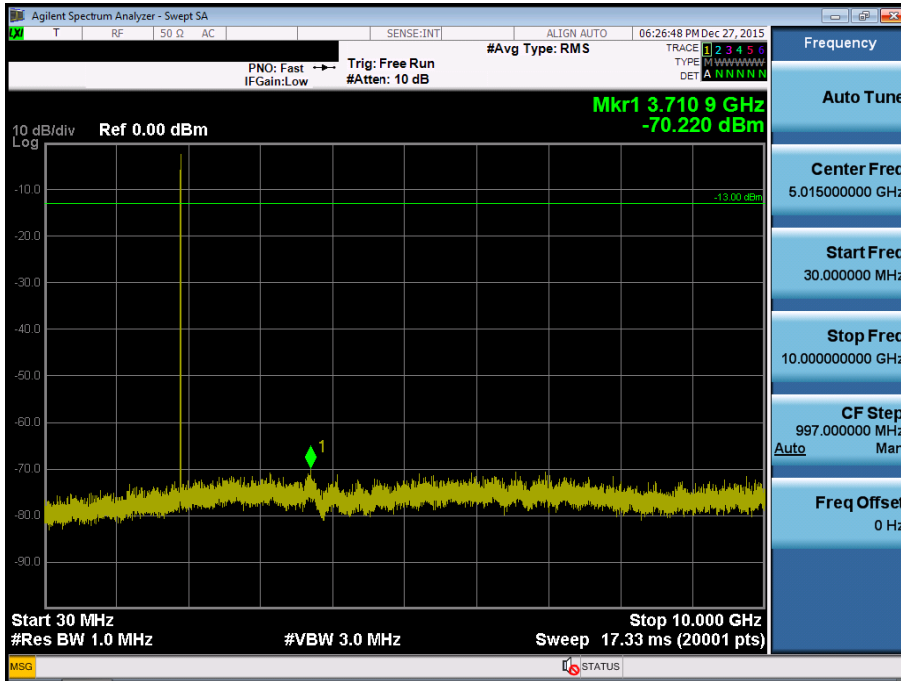

BAND 2. Conducted Spurious_2 (19193ch_1.4MHz_QPSK_RB 1_0)

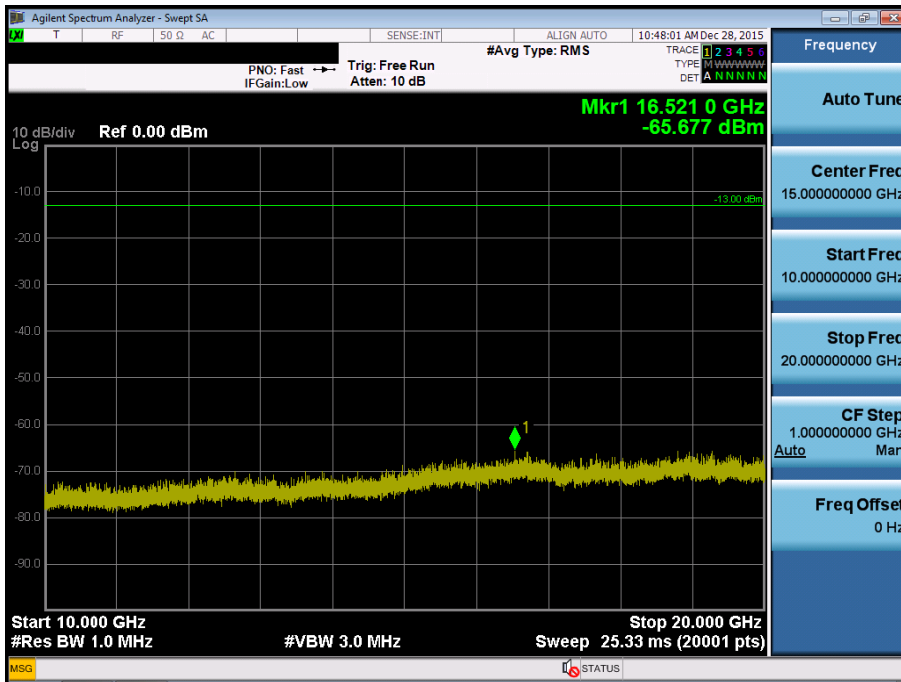

BAND 2. Conducted Spurious_1 (18615ch_3MHz_QPSK_RB 1_0)

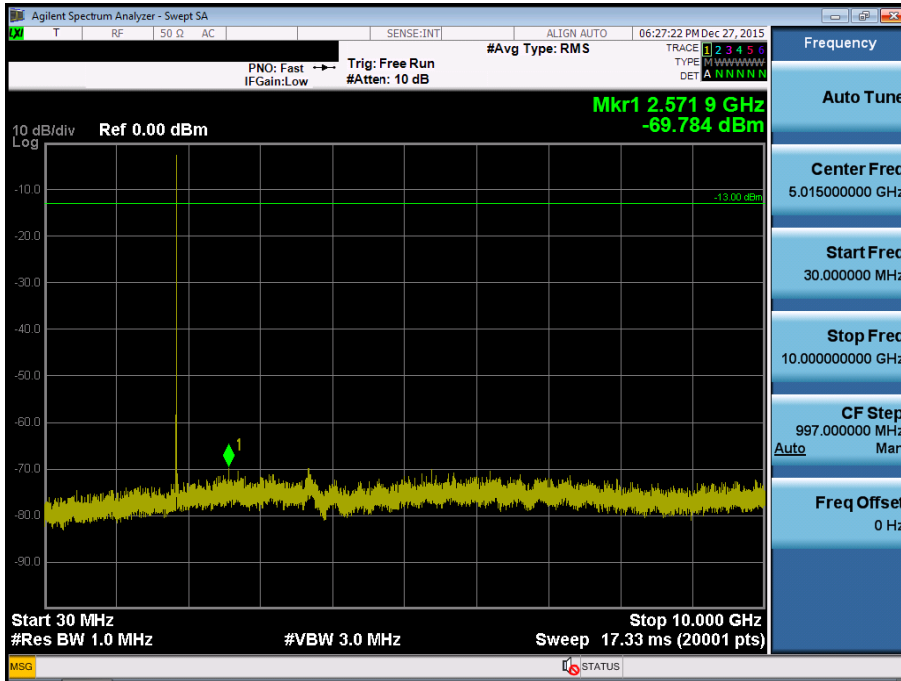

BAND 2. Conducted Spurious_2 (18615ch_3MHz_QPSK_RB 1_0)

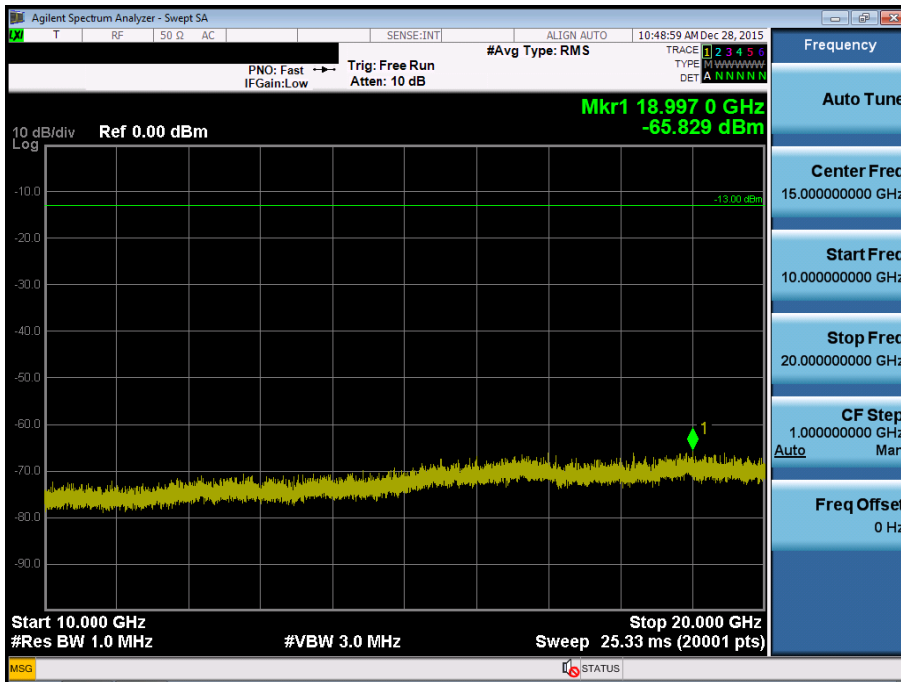

BAND 2. Conducted Spurious_1 (18900ch_3MHz_QPSK_RB 1_0)

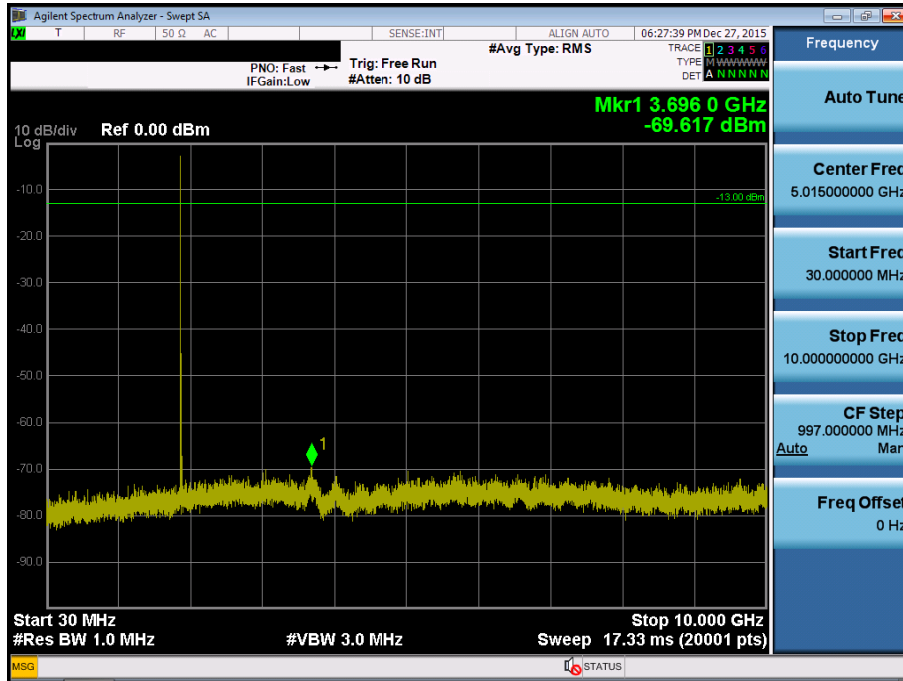

BAND 2. Conducted Spurious_2 (18900ch_3MHz_QPSK_RB 1_0)

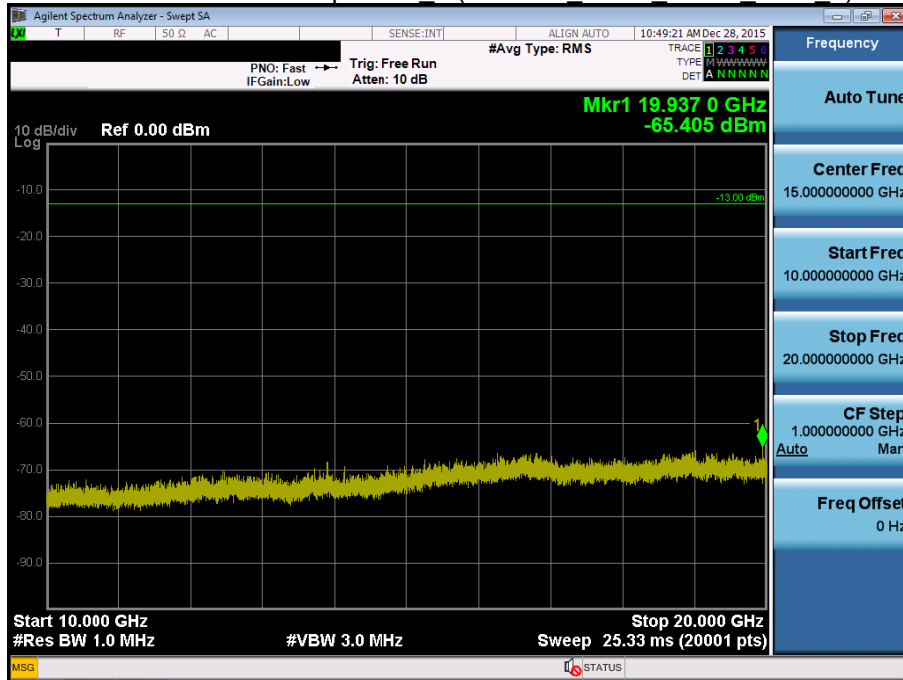

BAND 2. Conducted Spurious_1 (19185ch_3MHz_QPSK_RB 1_0)

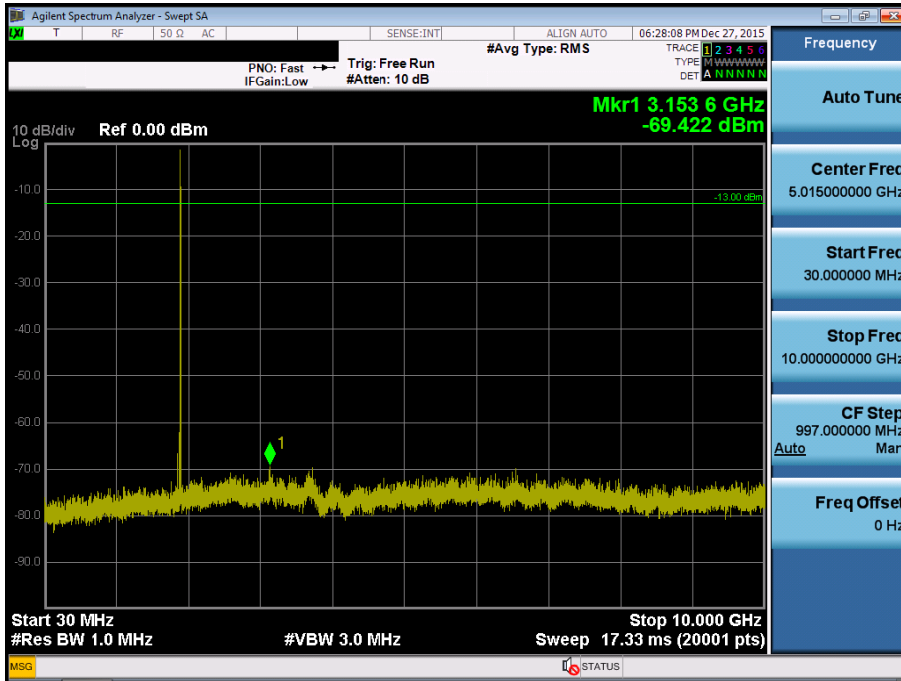

BAND 2. Conducted Spurious_2 (19185ch_3MHz_QPSK_RB 1_0)

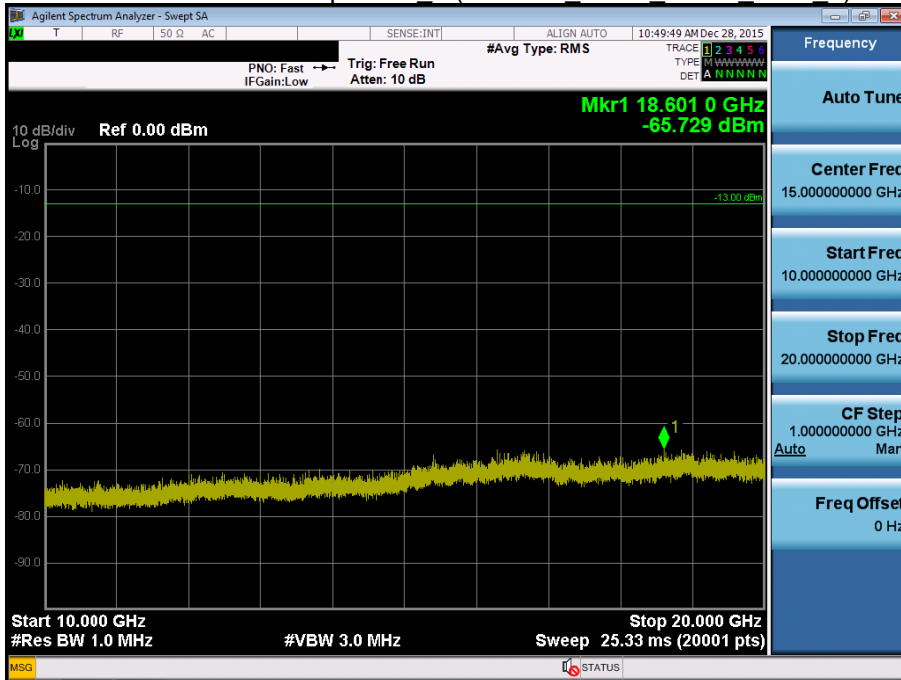

BAND 2. Conducted Spurious_1 (18625ch_5MHz_QPSK_RB 1_0)

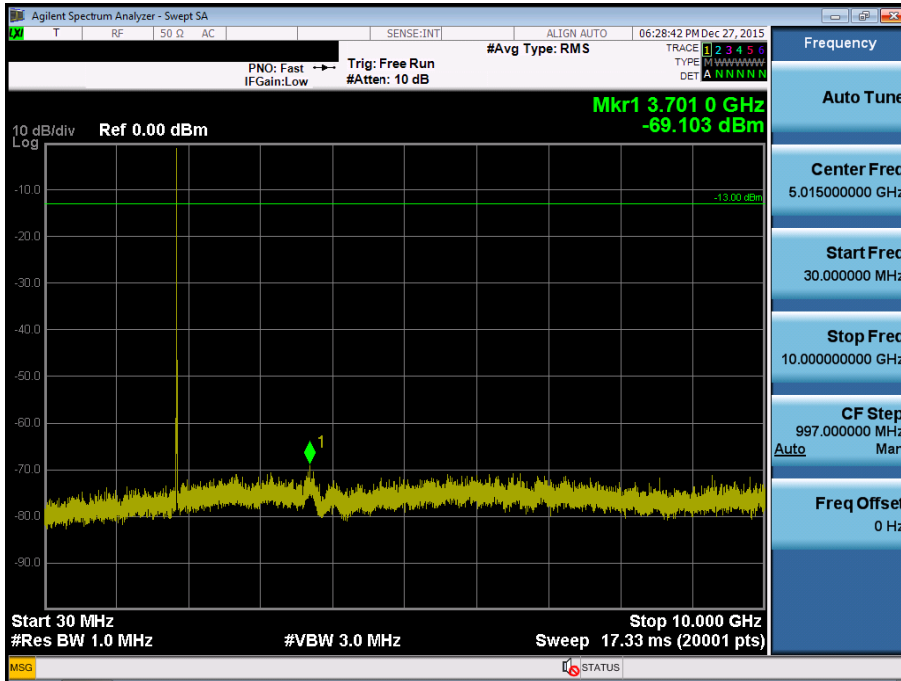

BAND 2. Conducted Spurious_2 (18625ch_5MHz_QPSK_RB 1_0)

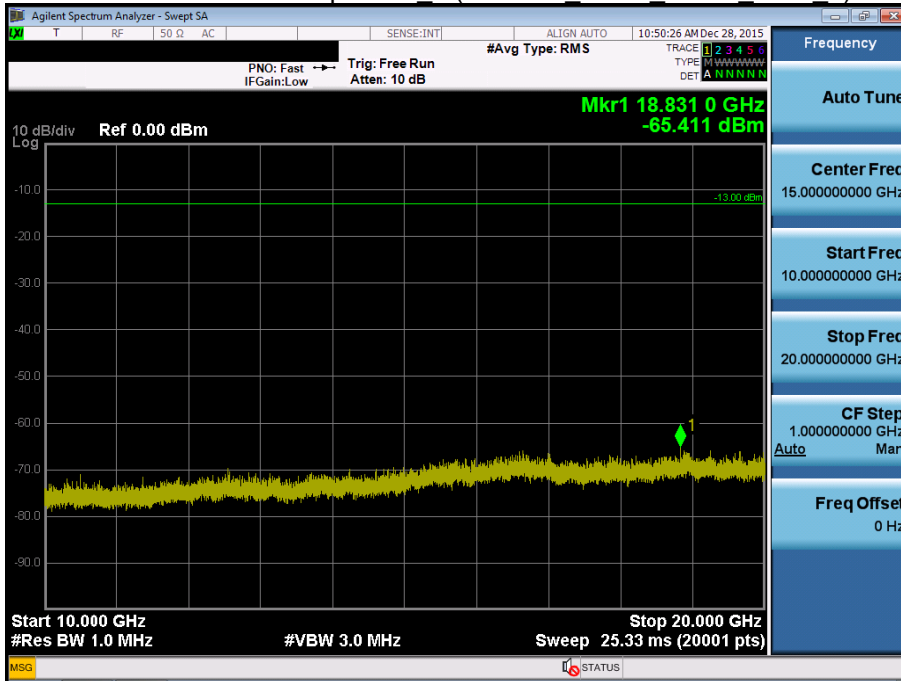

BAND 2. Conducted Spurious_1 (19175ch_5MHz_QPSK_RB 1_0)

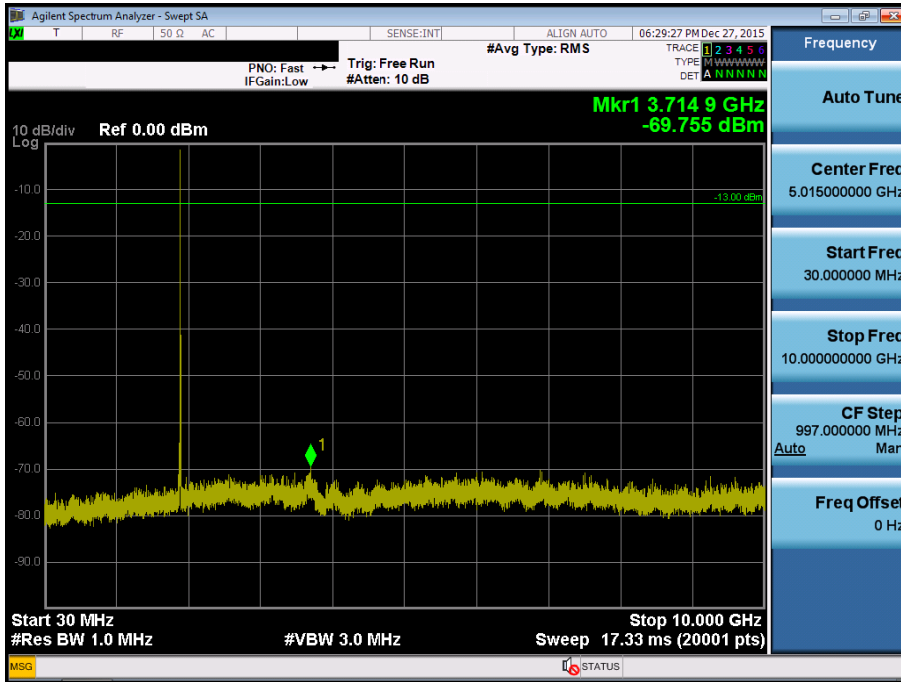

BAND 2. Conducted Spurious_2 (19175ch_5MHz_QPSK_RB 1_0)

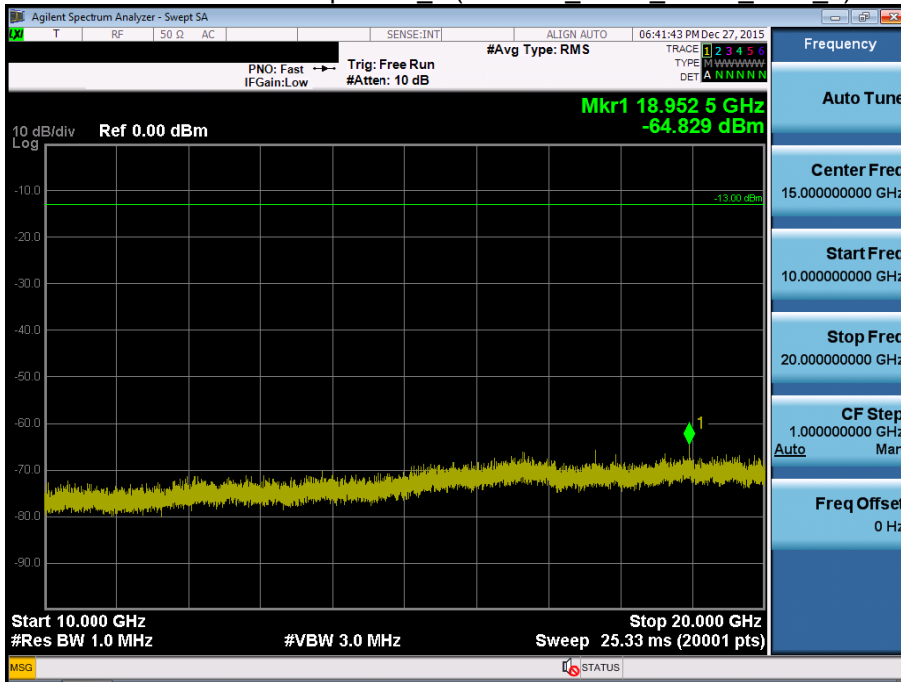

BAND 2. Conducted Spurious_1 (18650ch_10MHz_QPSK_RB 1_0)

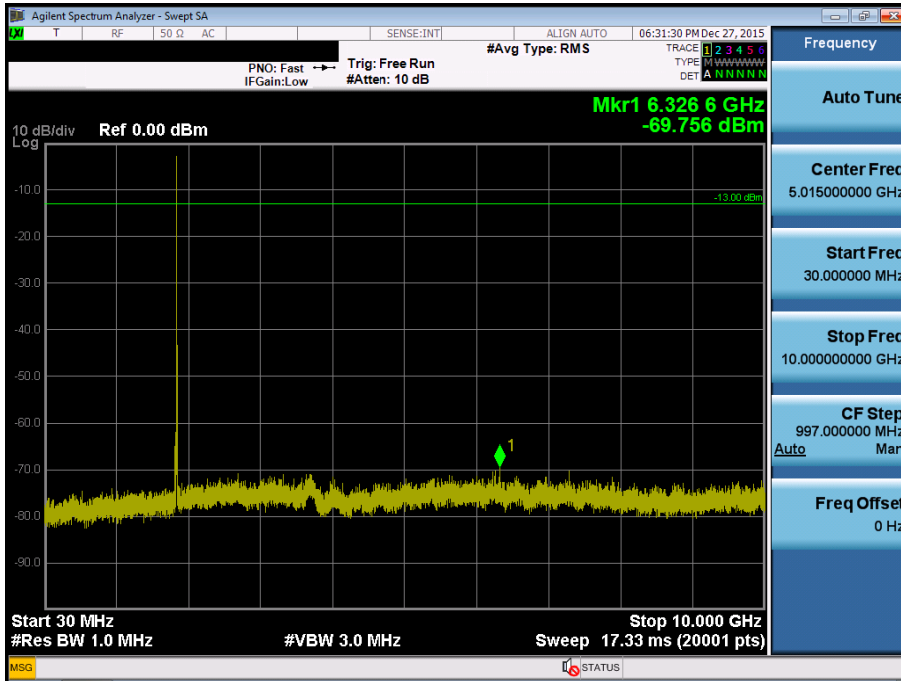

BAND 2. Conducted Spurious_2 (18650ch_10MHz_QPSK_RB 1_0)

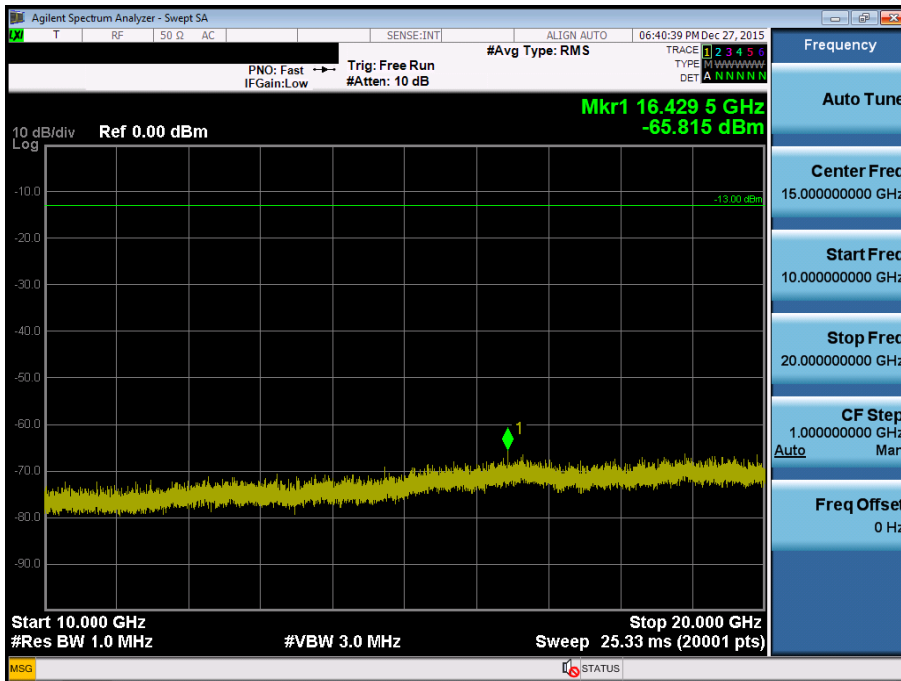

BAND 2. Conducted Spurious_1 (19150ch_10MHz_QPSK_RB 1_0)

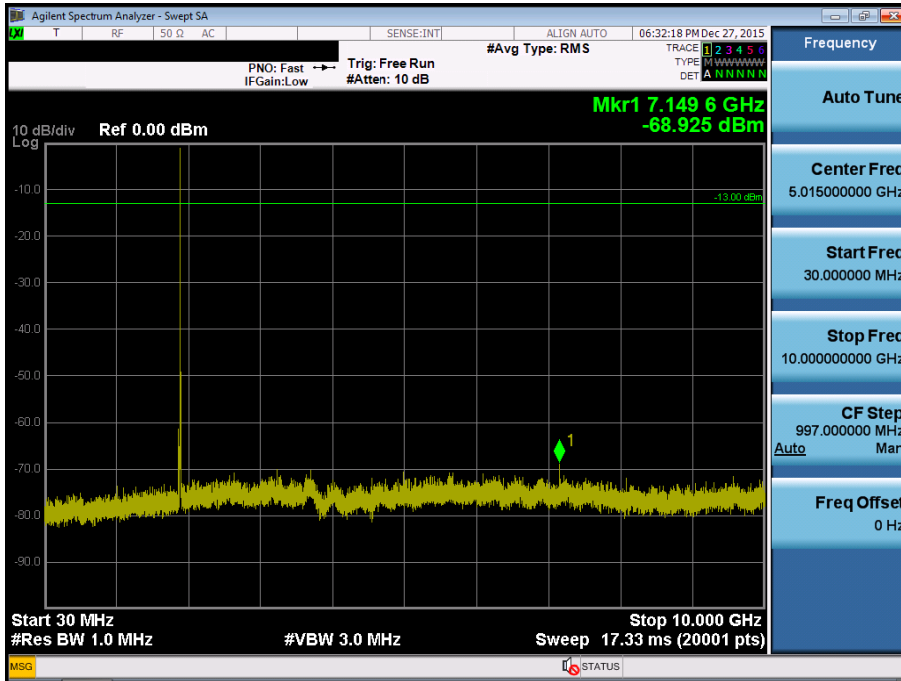

BAND 2. Conducted Spurious_2 (19150ch_10MHz_QPSK_RB 1_0)

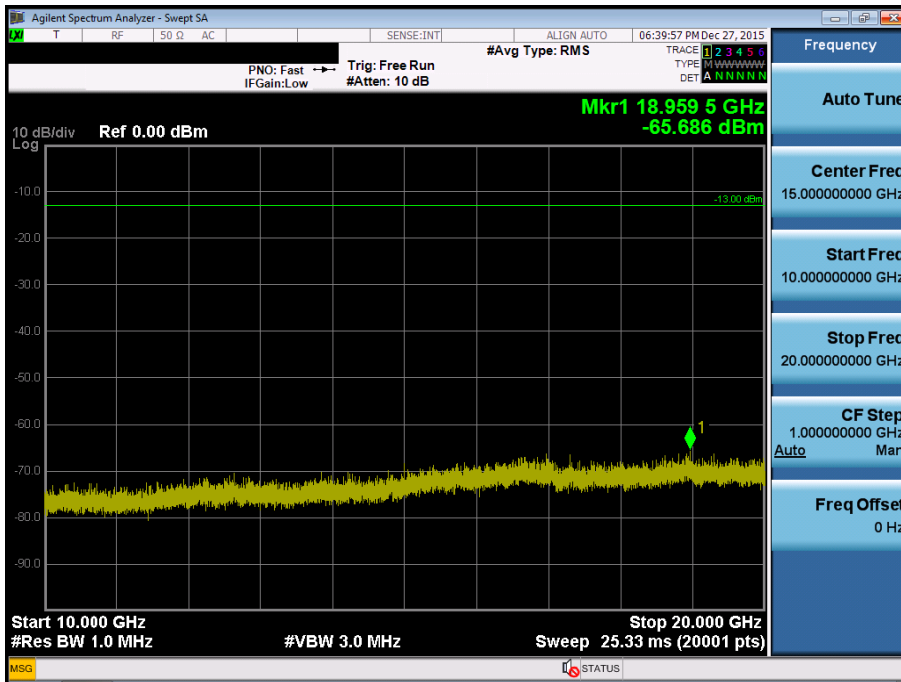

BAND 2. Conducted Spurious_1 (18675ch_15MHz_QPSK_RB 1_0)

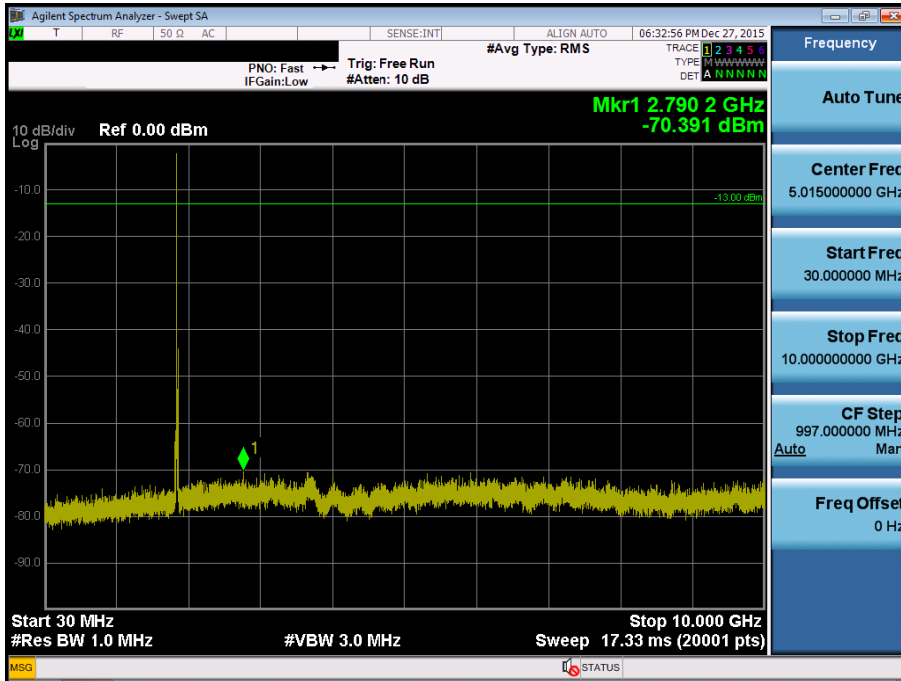

BAND 2. Conducted Spurious_2 (18675ch_15MHz_QPSK_RB 1_0)

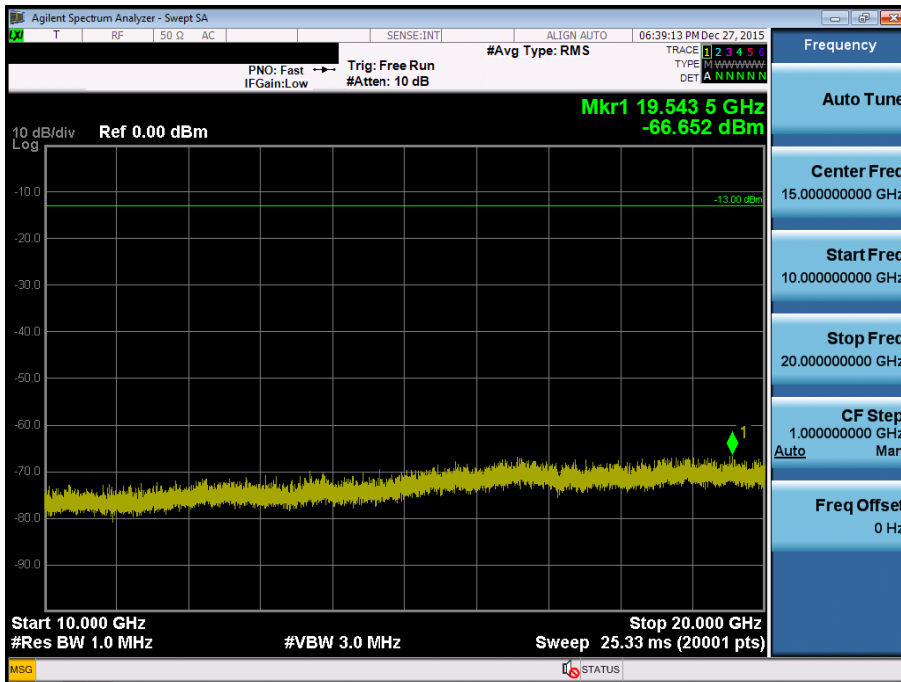

BAND 2. Conducted Spurious_1 (18900ch_15MHz_QPSK_RB 1_0)

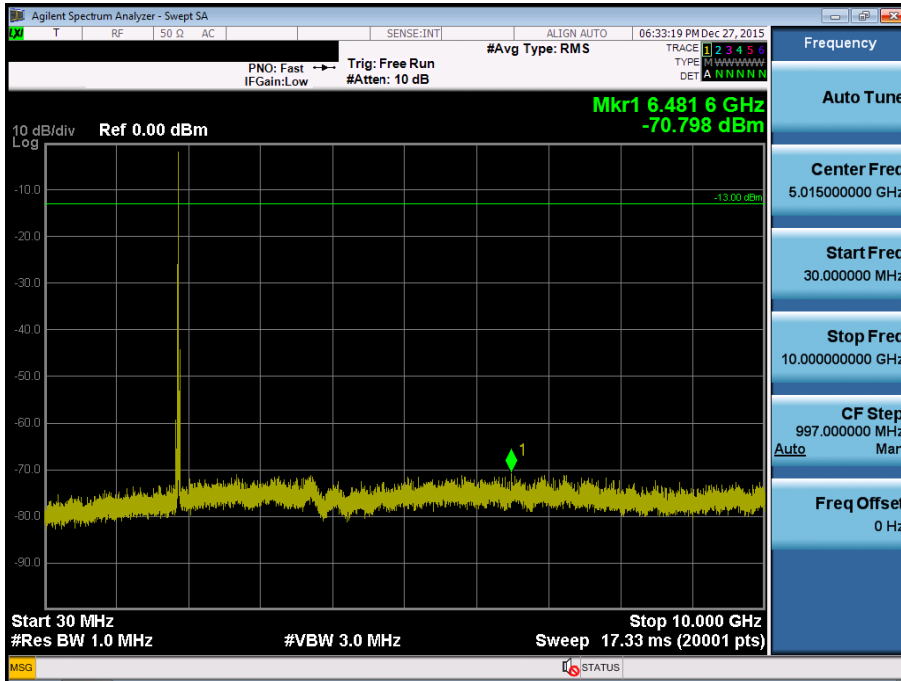

BAND 2. Conducted Spurious 2 (18900ch 15MHz_QPSK_RB 1_0)

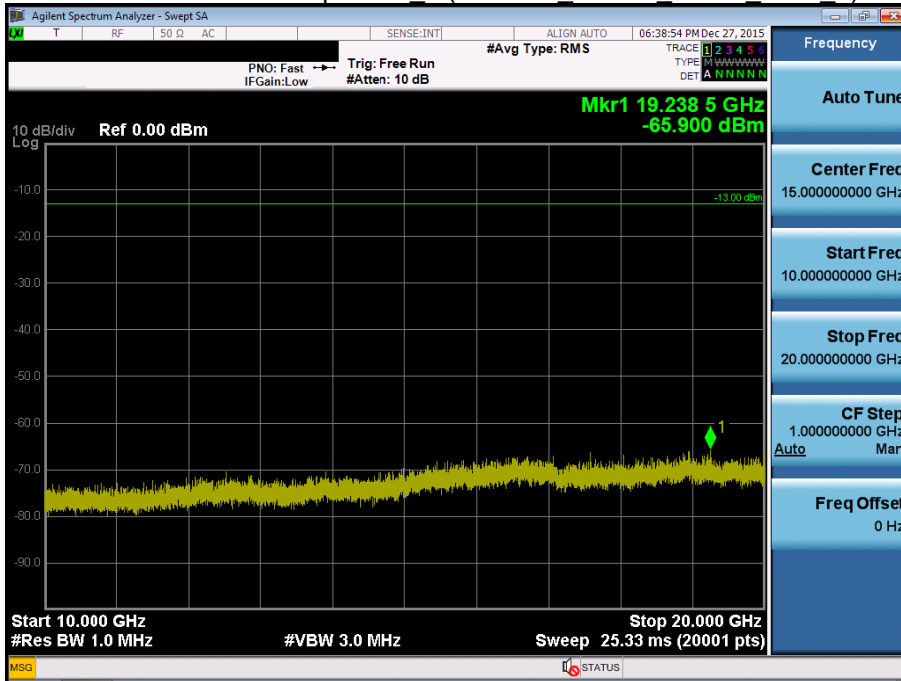

BAND 2. Conducted Spurious_1 (19125ch_15MHz_QPSK_RB 1_0)

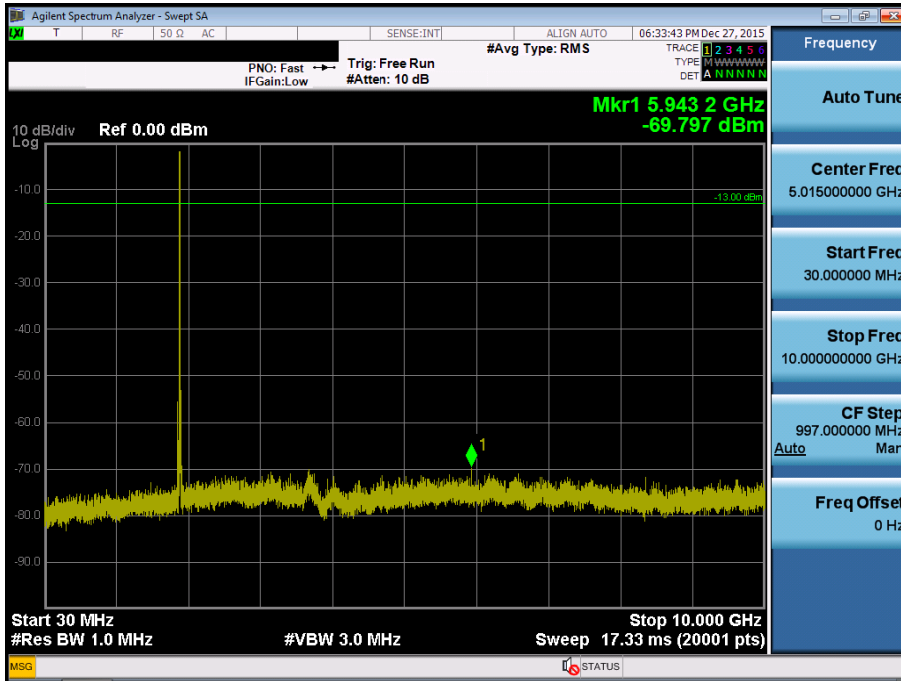

BAND 2. Conducted Spurious_2 (19125ch_15MHz_QPSK_RB 1_0)

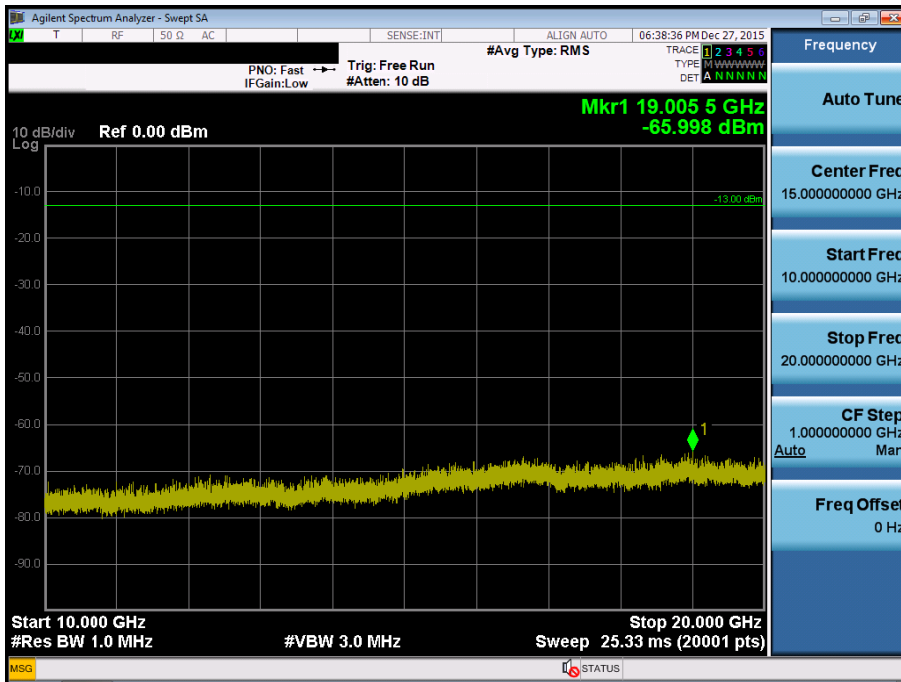

BAND 2. Conducted Spurious_1 (18900ch_20MHz_QPSK_RB 1_0)

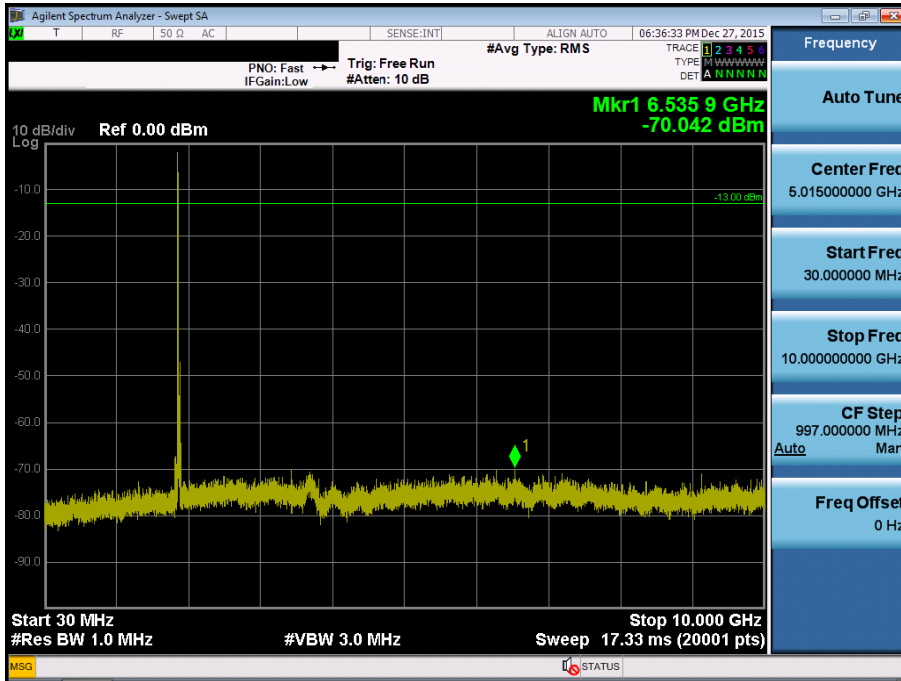

BAND 2. Conducted Spurious_2 (18900ch_20MHz_QPSK_RB 1_0)

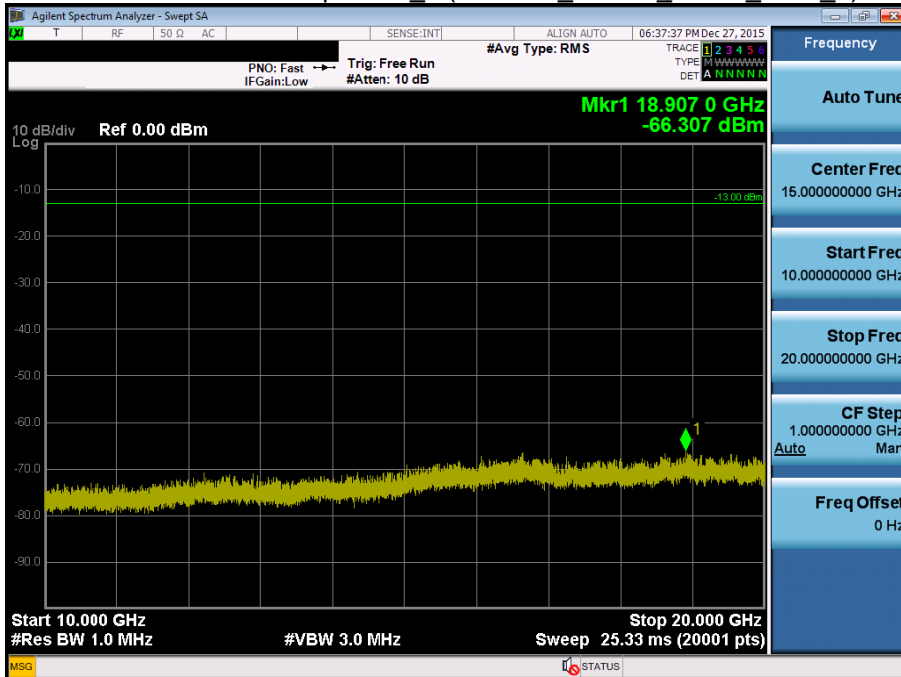

BAND 2. Conducted Spurious_1 (19100ch_20MHz_QPSK_RB 1_0)

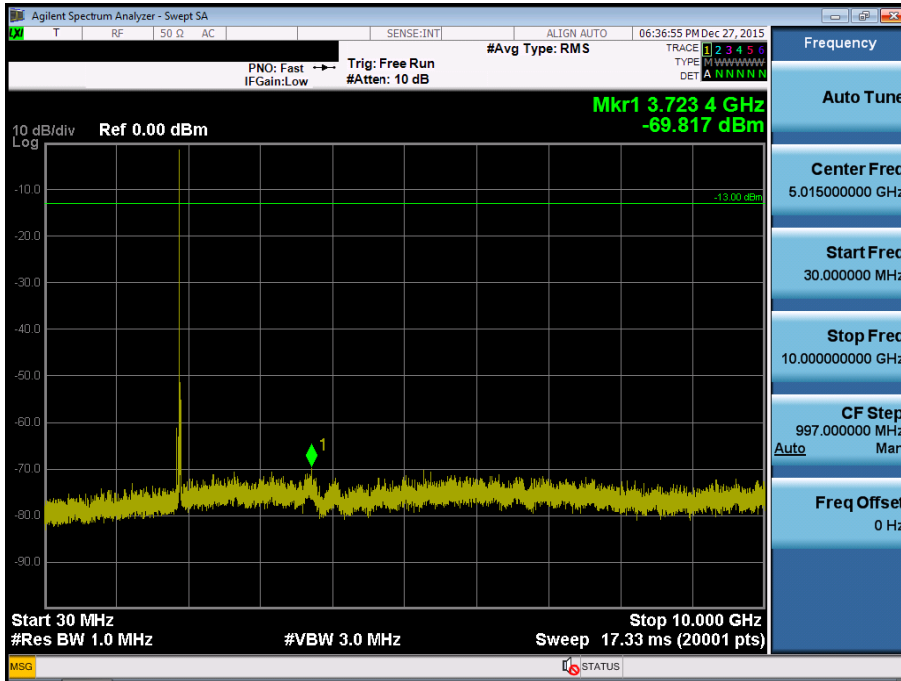

BAND 2. Conducted Spurious_2 (19100ch_20MHz_QPSK_RB 1_0)

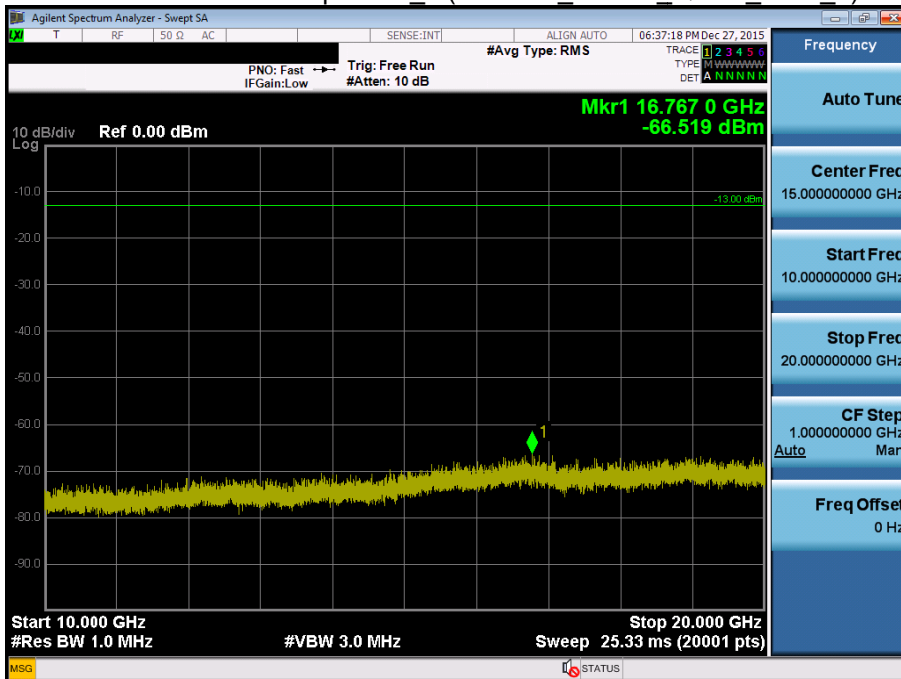

BAND 5. Conducted Spurious Plot _1 (20407ch_1.4MHz_QPSK_RB 1_0)

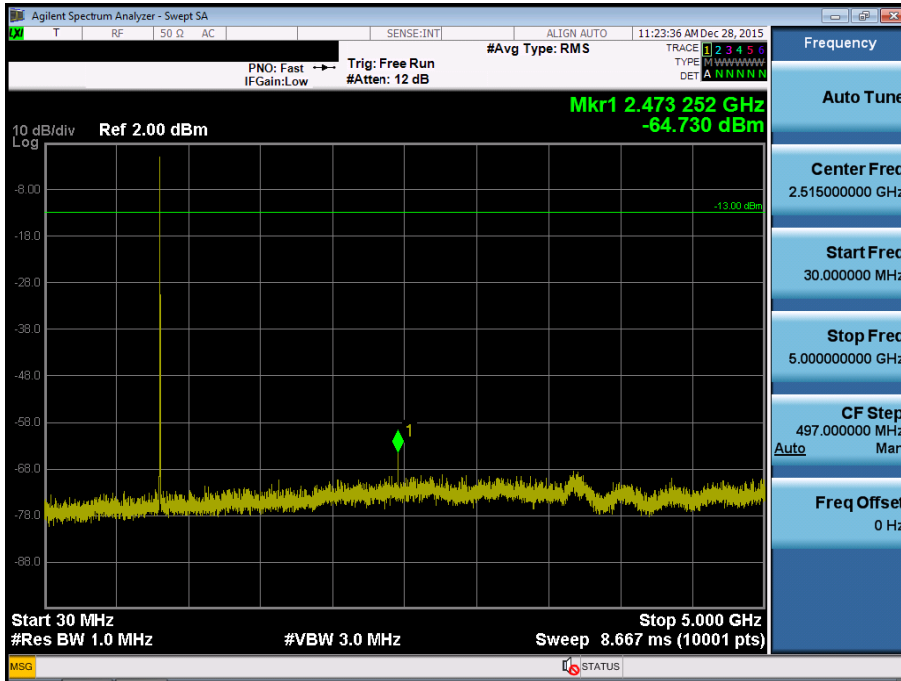

BAND 5. Conducted Spurious Plot _2 (20407ch_1.4MHz_QPSK_RB 1_0)

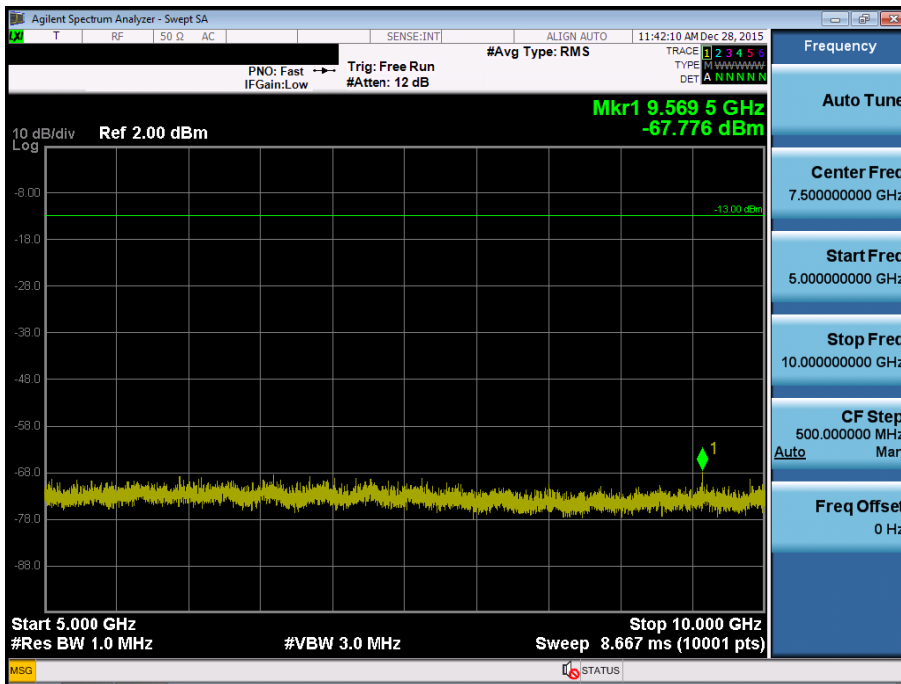

BAND 5. Conducted Spurious Plot _1 (20525ch_1.4MHz_QPSK_RB 1_0)

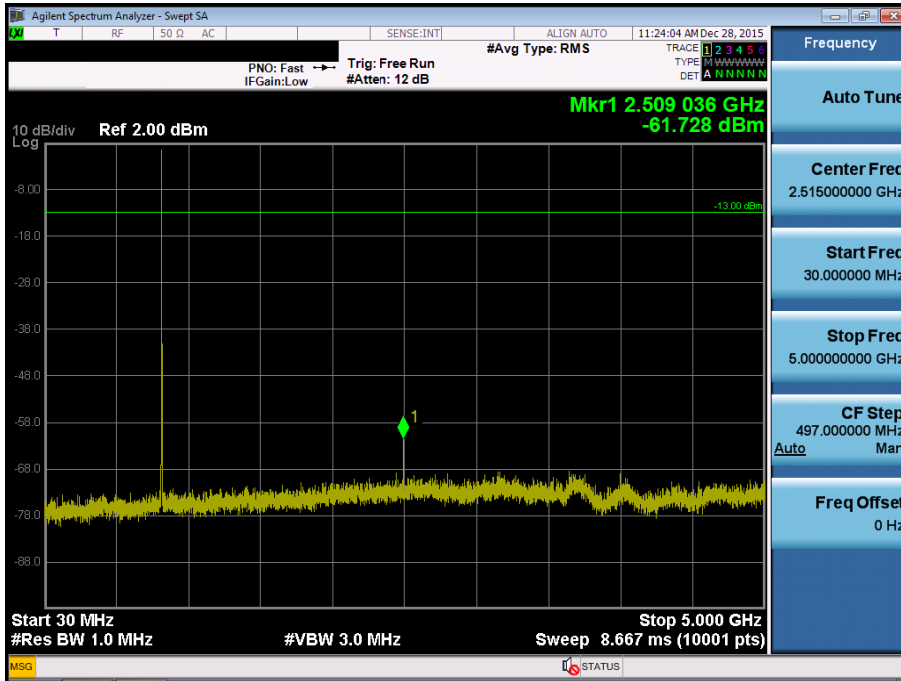

BAND 5. Conducted Spurious Plot _2 (20525ch_1.4MHz_QPSK_RB 1_0)

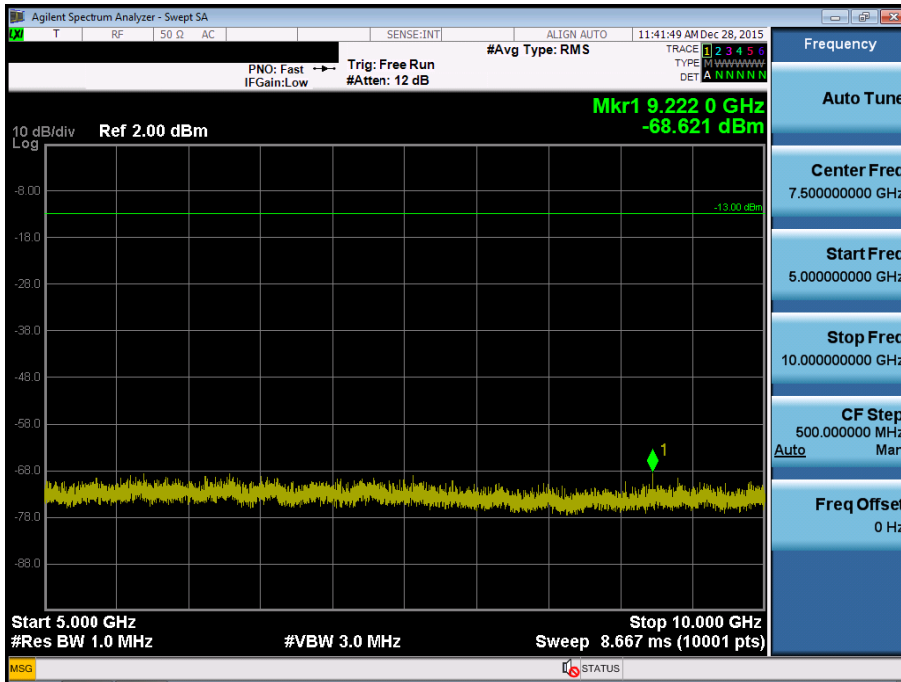

BAND 5. Conducted Spurious Plot _1 (20643ch_1.4MHz_QPSK_RB 1_0)

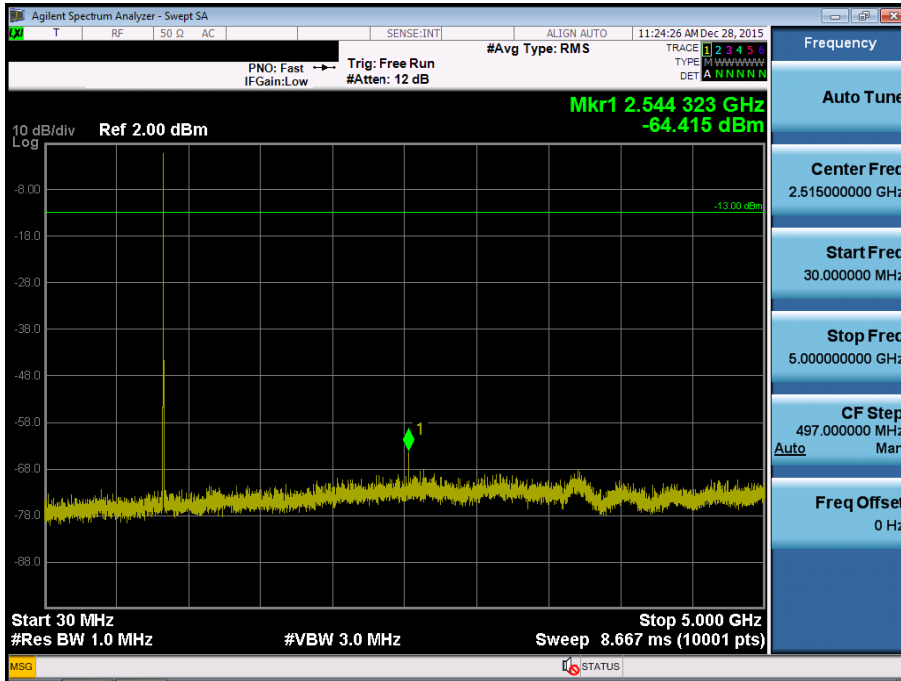

BAND 5. Conducted Spurious Plot _2 (20643ch_1.4MHz_QPSK_RB 1_0)

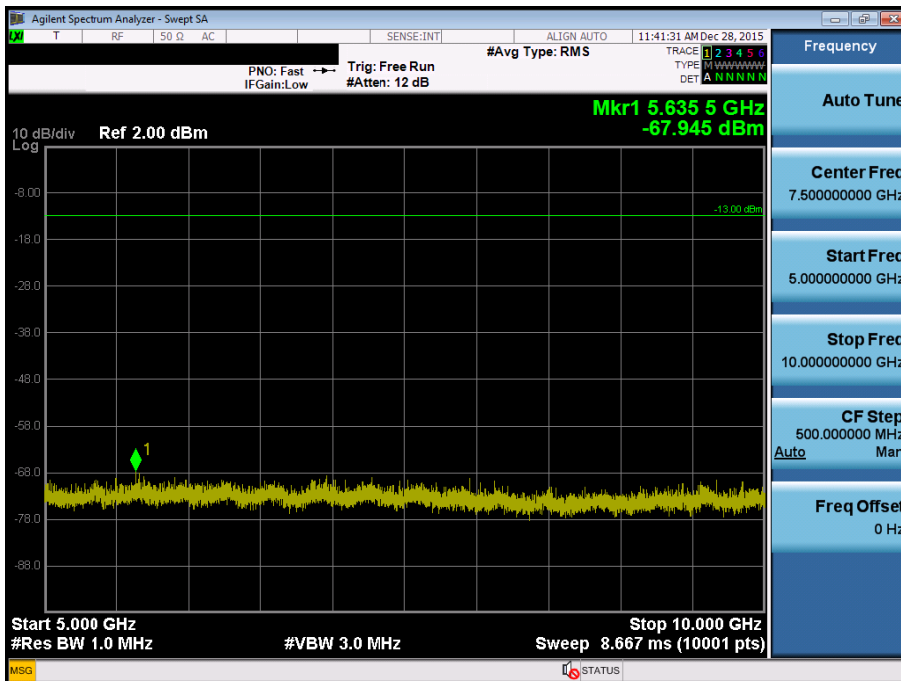

BAND 5. Conducted Spurious Plot _1 (20415ch_3MHz_QPSK_RB 1_0)

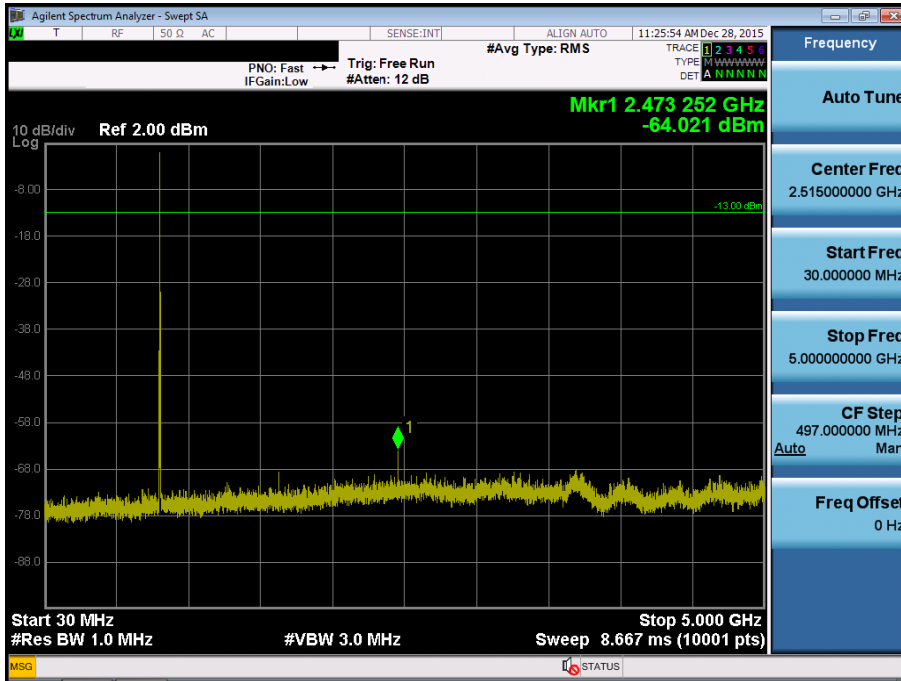

BAND 5. Conducted Spurious Plot _2 (20415ch_3MHz_QPSK_RB 1_0)

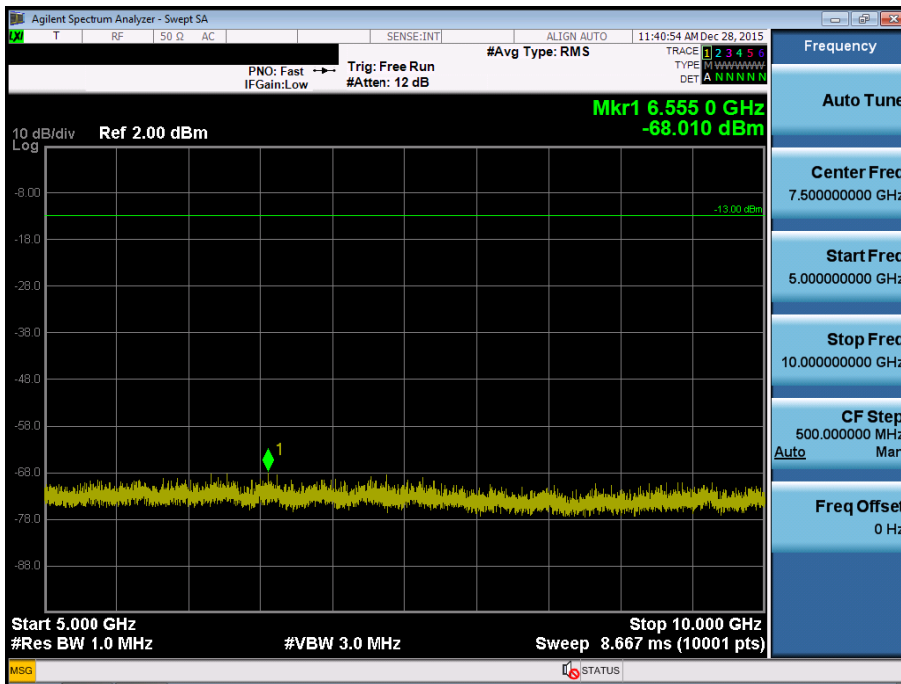

BAND 5. Conducted Spurious Plot _1 (20525ch_3MHz_QPSK_RB 1_0)

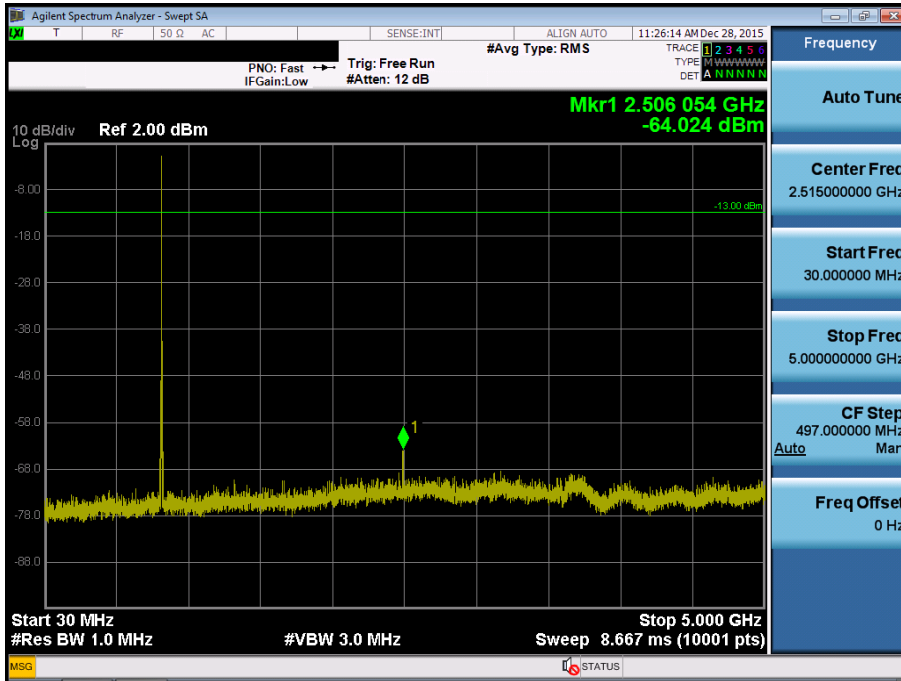

BAND 5. Conducted Spurious Plot _2 (20525ch_3MHz_QPSK_RB 1_0)

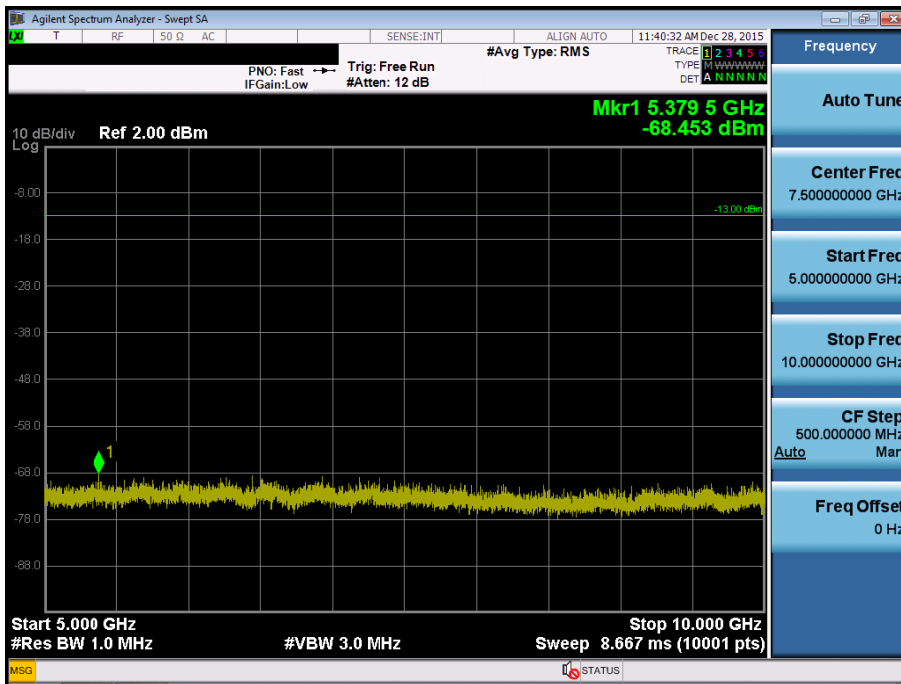

BAND 5. Conducted Spurious Plot _1 (20635ch_3MHz_QPSK_RB 1_0)

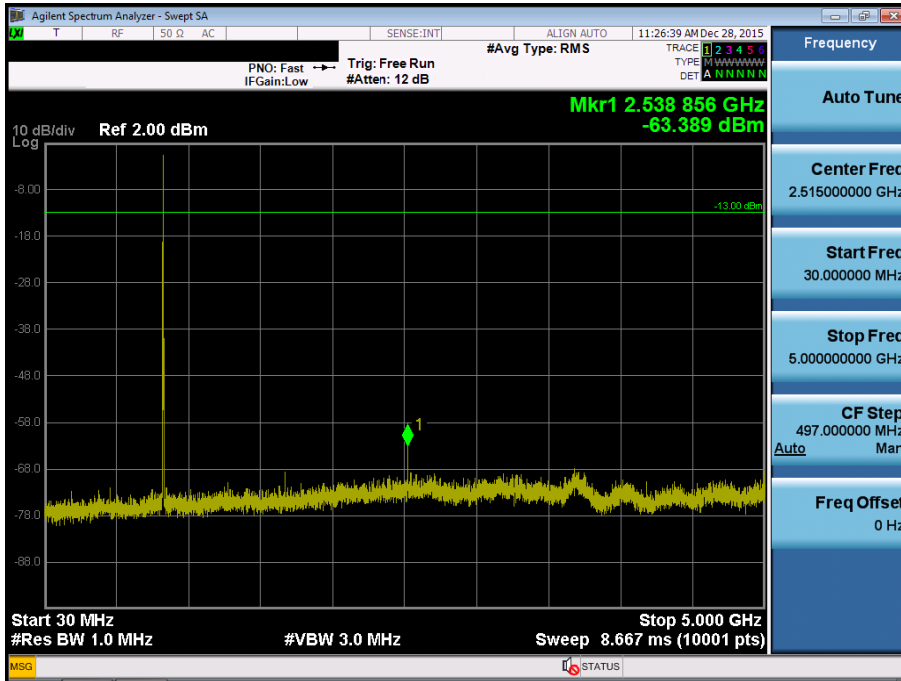

BAND 5. Conducted Spurious Plot _2 (20635ch_3MHz_QPSK_RB 1_0)

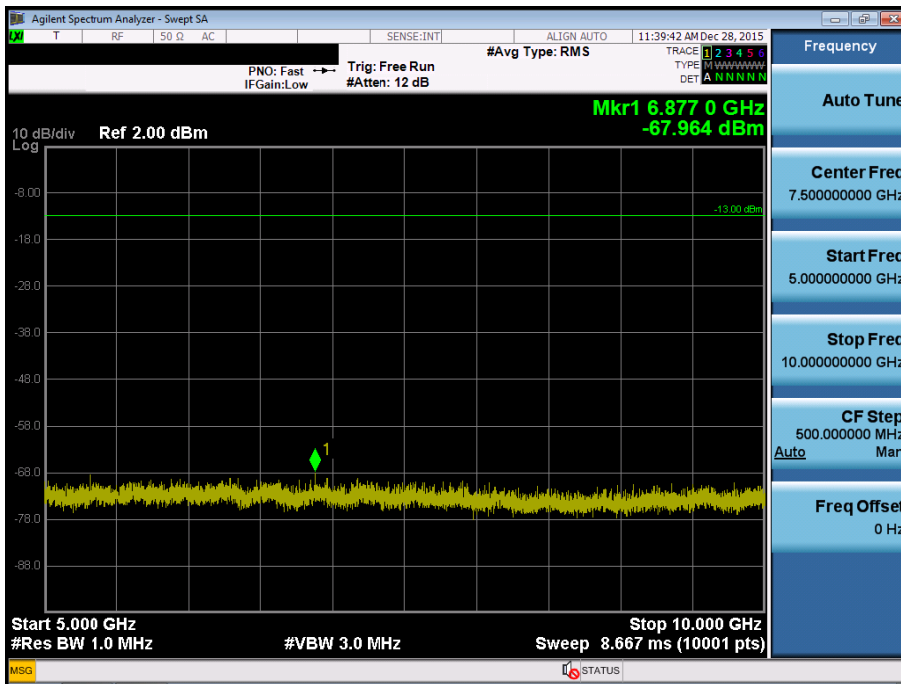

BAND 5. Conducted Spurious Plot _1 (20425ch_5MHz_QPSK_RB 1_0)

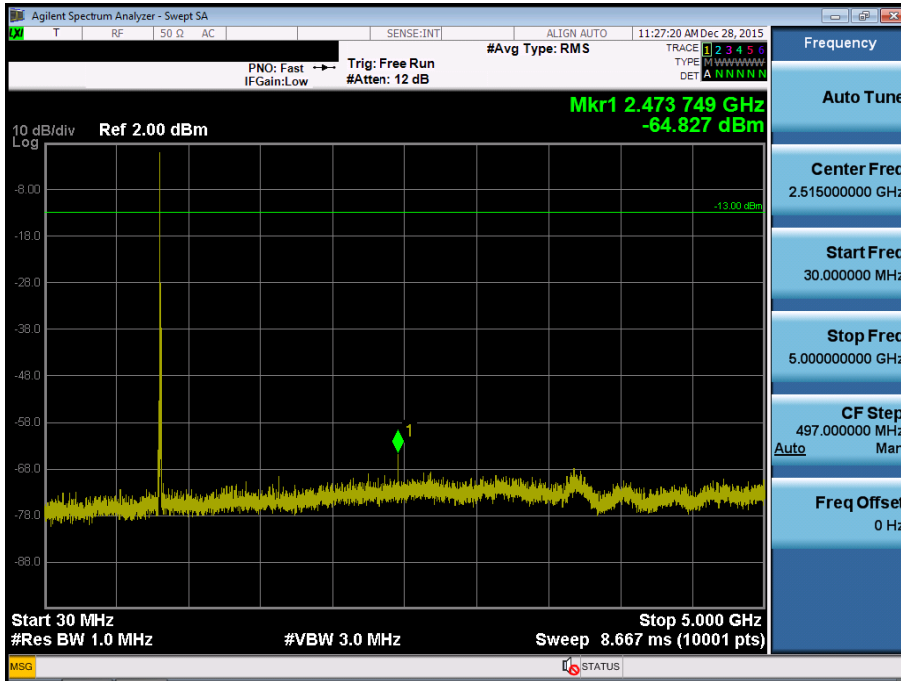

BAND 5. Conducted Spurious Plot _2 (20425ch_5MHz_QPSK_RB 1_0)

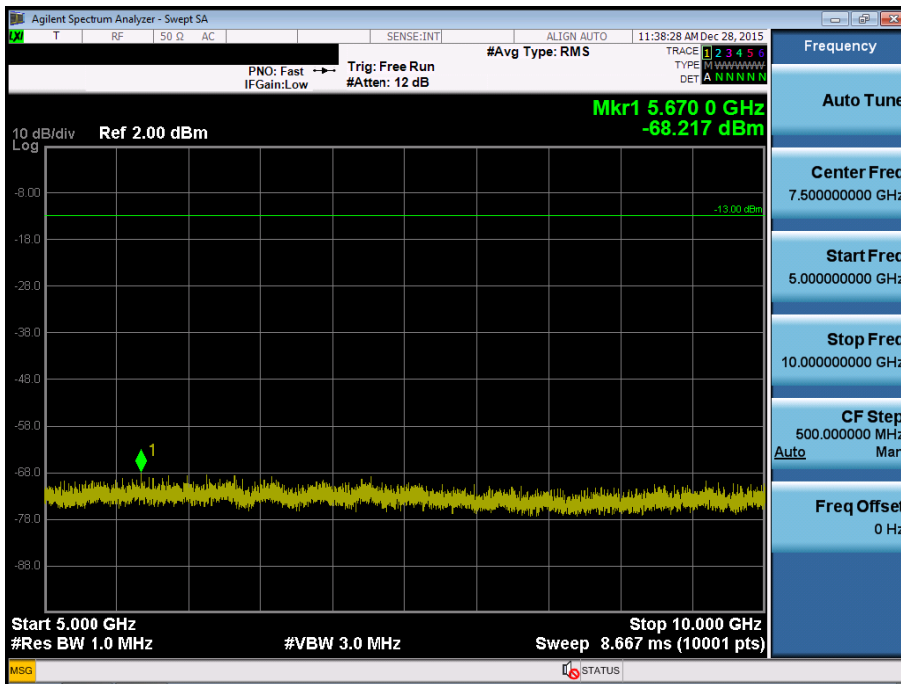

BAND 5. Conducted Spurious Plot _1 (20525ch_5MHz_QPSK_RB 1_0)

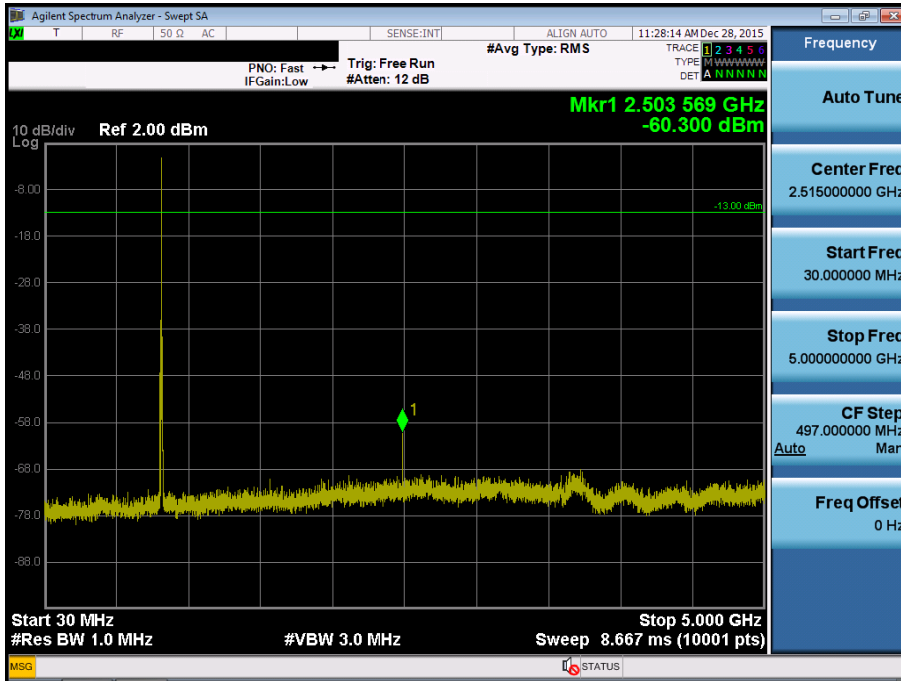

BAND 5. Conducted Spurious Plot _2 (20525ch_5MHz_QPSK_RB 1_0)

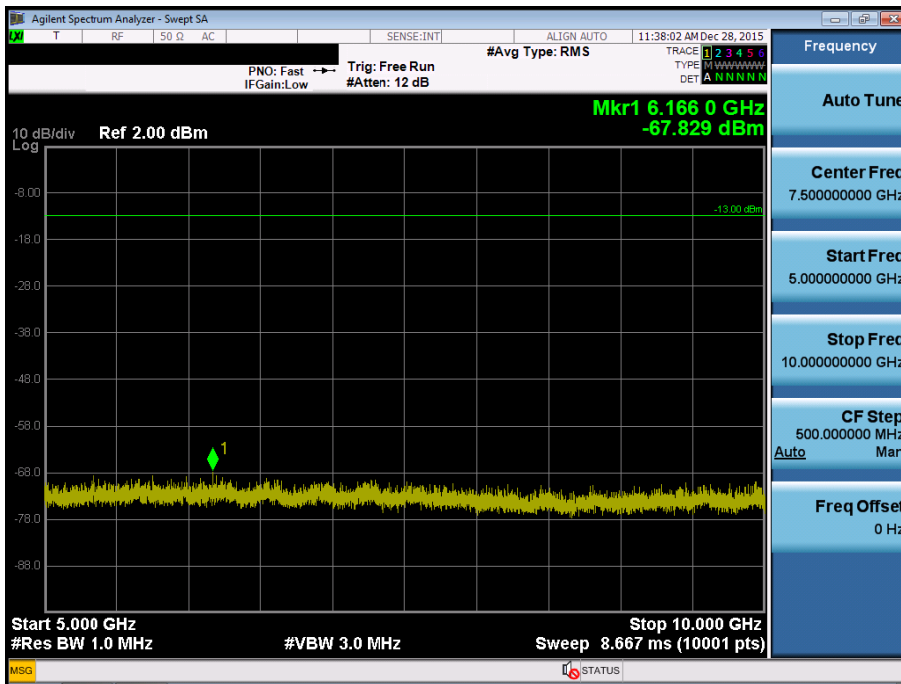

BAND 5. Conducted Spurious Plot _1 (20625ch_5MHz_QPSK_RB 1_0)

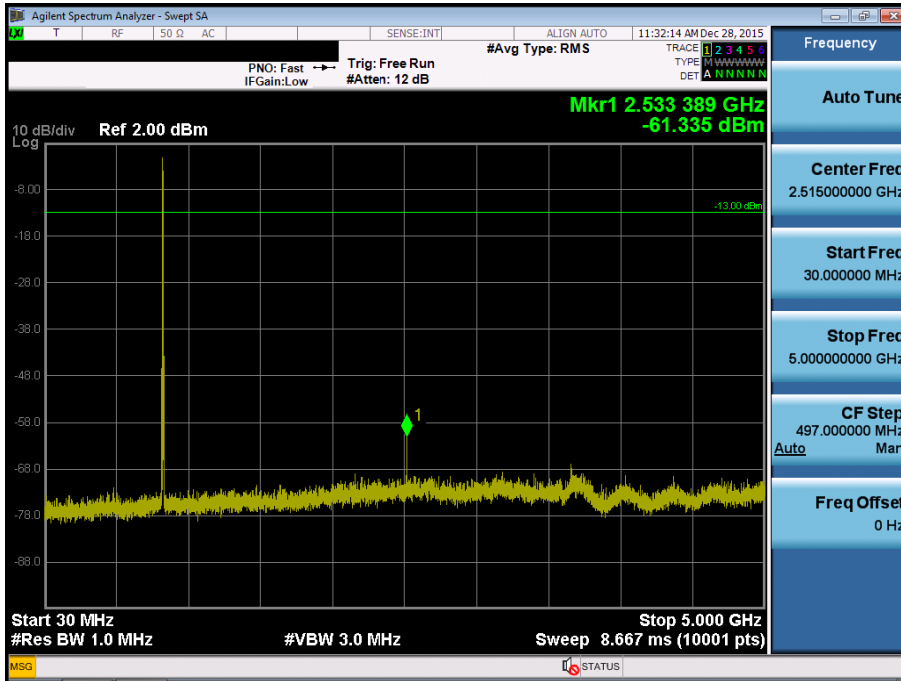

BAND 5. Conducted Spurious Plot _2 (20625ch_5MHz_QPSK_RB 1_0)

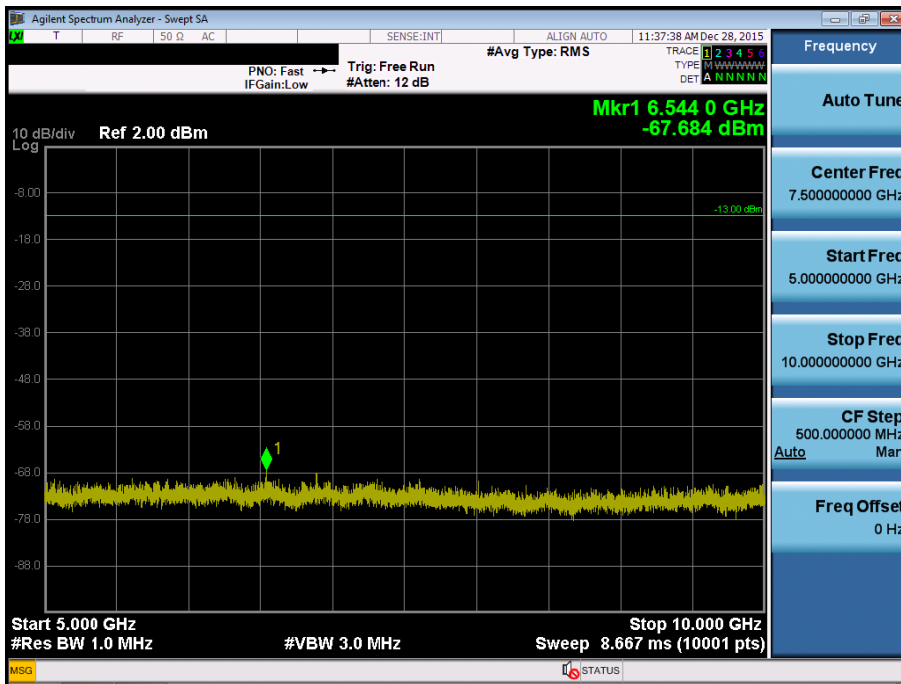

BAND 5. Conducted Spurious Plot _1 (20450ch_10MHz_QPSK_RB 1_0)

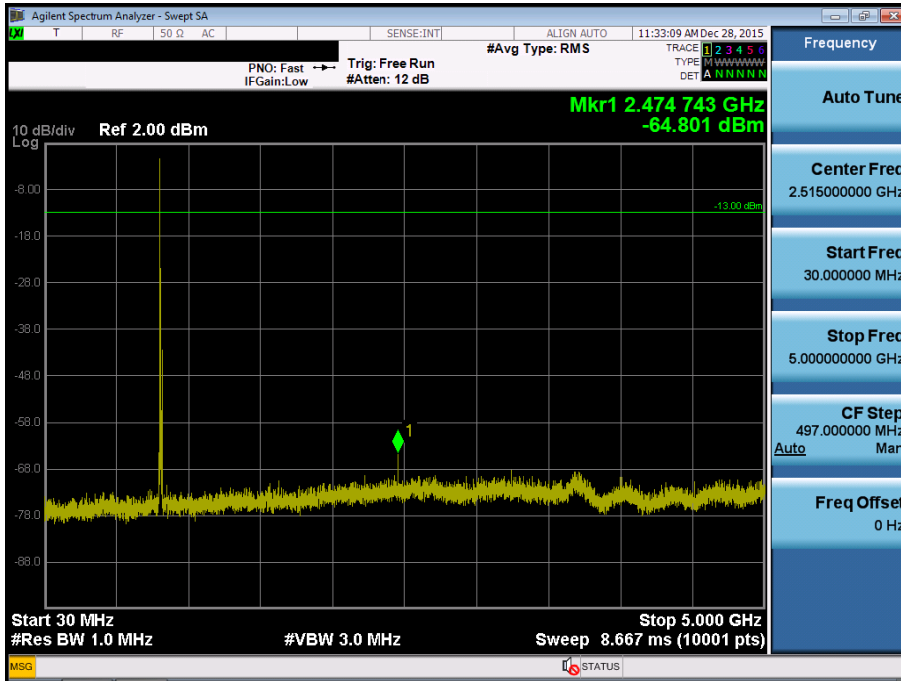

BAND 5. Conducted Spurious Plot _2 (20450ch_10MHz_QPSK_RB 1_0)

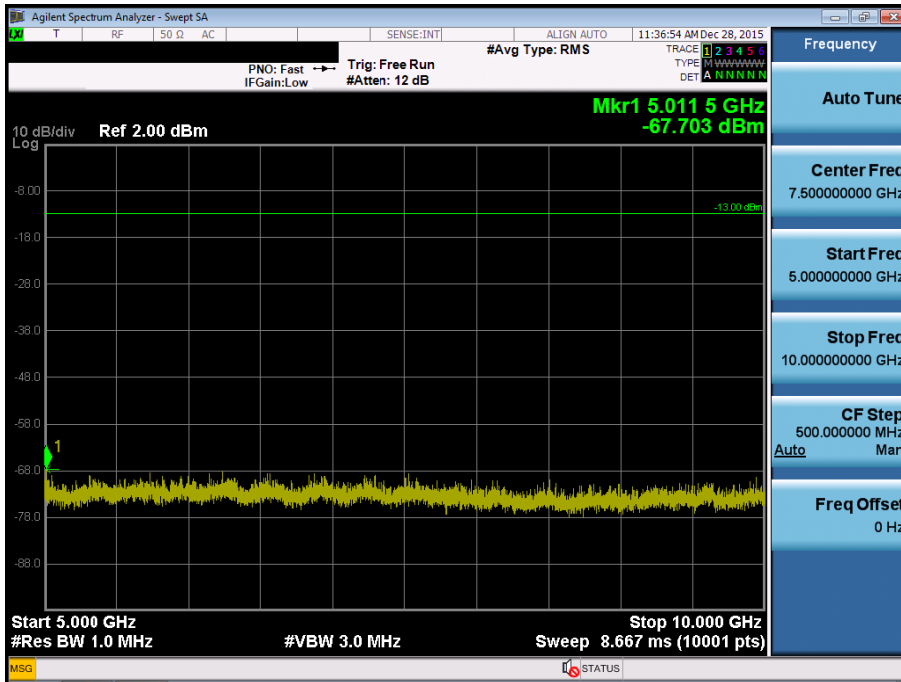

BAND 5. Conducted Spurious Plot _1 (20525ch_10MHz_QPSK_RB 1_0)

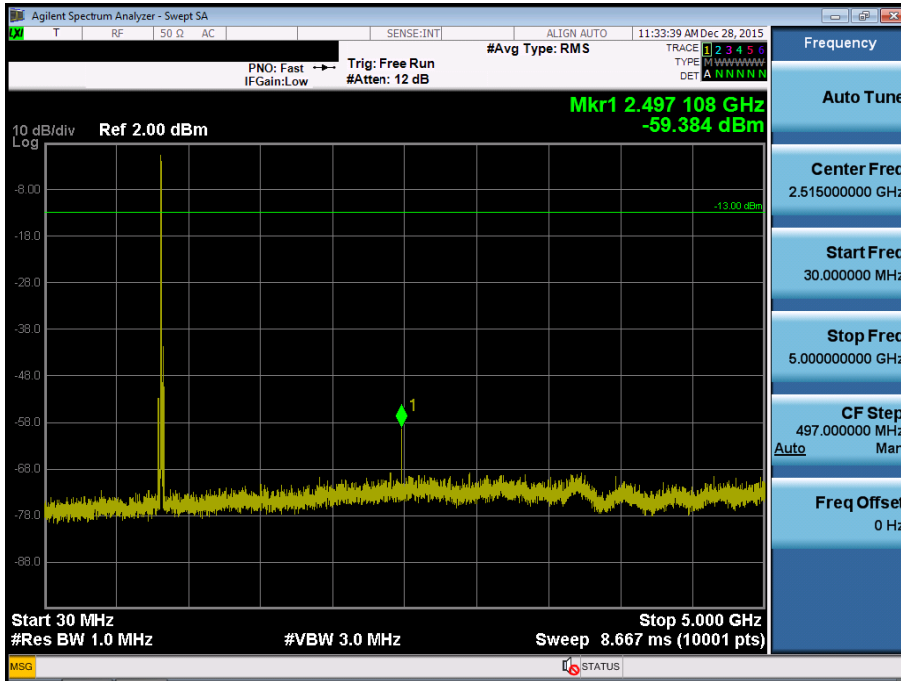

BAND 5. Conducted Spurious Plot _2 (20525ch_10MHz_QPSK_RB 1_0)

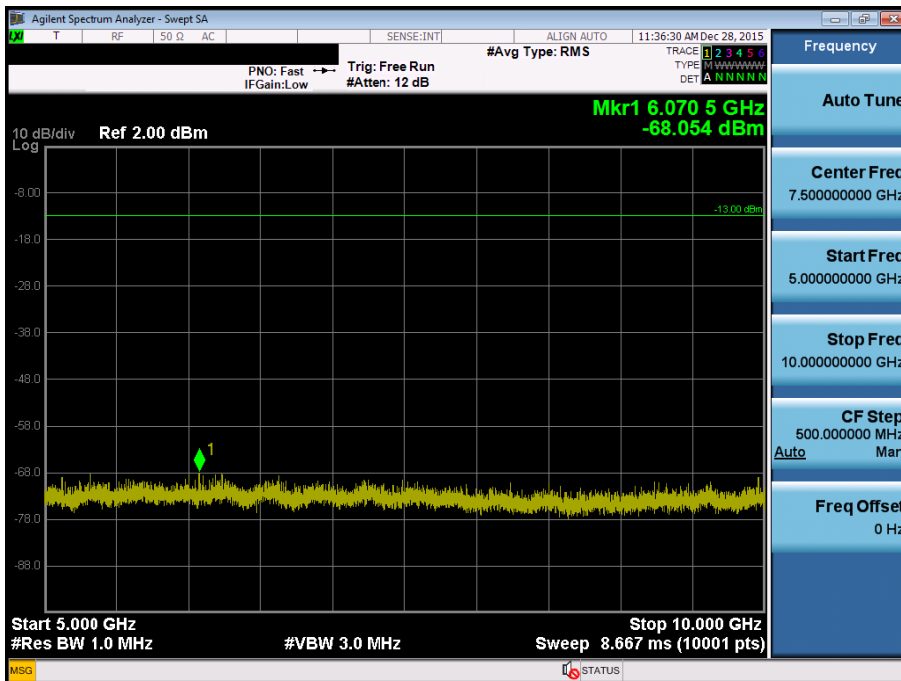

BAND 5. Conducted Spurious Plot _1 (20600ch_10MHz_QPSK_RB 1_0)

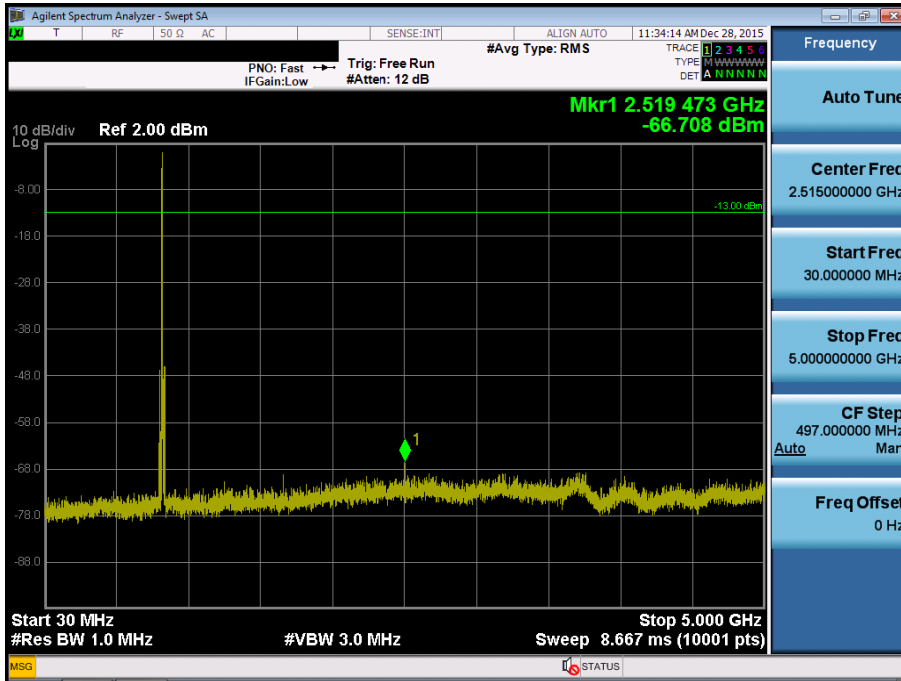

BAND 5. Conducted Spurious Plot _2 (20600ch_10MHz_QPSK_RB 1_0)

