

# FCC LTE REPORT

## FCC Certification

**Applicant Name:**  
 LG Electronics MobileComm U.S.A., Inc.

**Date of Issue:**  
 January 07, 2016

**Location:**

HCT CO., LTD.,

**Address:**  
 1000 Sylvan Avenue, Englewood Cliffs NJ 07632

74, Seoicheon-ro 578beon-gil, Majang-myeon,  
 Icheon-si, Gyeonggi-do, 17383, Rep. of KOREA

**Report No.:** HCT-R-1601-F009  
**HCT FRN:** 0005866421

<b>FCC ID:</b>	<b>ZNFK430T</b>
<b>APPLICANT:</b>	<b>LG Electronics MobileComm U.S.A., Inc.</b>

**FCC Model(s):** LG-K430T  
**Additional:** LGK430T, K430T  
**EUT Type:** GSM WCDMA LTE Phone with BT & WLAN  
**FCC Classification:** Licensed Portable Transmitter Held to Ear (PCE)  
**FCC Rule Part(s):** §27, §2

Mode (MHz)	Tx Frequency (MHz)	Emission Designator	Modulation	EIRP	
				Max. Power (W)	Max. Power (dBm)
LTE – Band4 (1.4)	1710.7 – 1754.3	1M09G7D	QPSK	0.121	20.82
		1M10W7D	16QAM	0.101	20.04
LTE – Band4 (3)	1711.5 – 1753.5	2M70G7D	QPSK	0.121	20.82
		2M70W7D	16QAM	0.101	20.02
LTE – Band4 (5)	1712.5 – 1752.5	4M51G7D	QPSK	0.122	20.85
		4M51W7D	16QAM	0.101	20.04
LTE – Band4 (10)	1715.0 – 1750.0	8M99G7D	QPSK	0.122	20.87
		8M97W7D	16QAM	0.102	20.09
LTE – Band4 (15)	1717.5 – 1747.5	13M5G7D	QPSK	0.123	20.91
		13M5W7D	16QAM	0.103	20.12
LTE – Band4 (20)	1720.0 – 1745.0	18M0G7D	QPSK	0.123	20.89
		18M0W7D	16QAM	0.103	20.11

The measurements shown in this report were made in accordance with the procedures specified in CFR47 section §2.947. I assume full responsibility for the accuracy and completeness of these measurements, and for the qualifications of all persons taking them.

**HCT CO., LTD.** Certifies that no party to this application has subject to a denial of Federal benefits that includes FCC benefits pursuant to section 5301 of the Anti-Drug Abuse Act of 1998, 21 U.S. C. 853(a)

  
 Report prepared by  
 : Ki Hyun Kim  
 Test engineer of RF Team

  
 Approved by  
 : Sang Jun Lee  
 Manager of RF Team

This report only responds to the tested sample and may not be reproduced, except in full, without written approval of the HCT Co., Ltd.

## Report Revision

TEST REPORT NO.	DATE	DESCRIPTION
HCT-R-1601-F009	January 07, 2016	- First Approval Report

---

# Table of Contents

1. GENERAL INFORMATION .....	4
2. INTRODUCTION .....	5
2.1. EUT DESCRIPTION.....	5
2.2. MEASURING INSTRUMENT CALIBRATION.....	5
2.3. TEST FACILITY .....	5
3. DESCRIPTION OF TESTS .....	6
3.1 EIRP RADIATED POWER AND RADIATED SPURIOUS EMISSIONS .....	6
3.2 AWS – MOBILE FREQUENCY BLOCKS (1710 – 1755 MHz).....	7
3.3 PEAK-AVERAGE RATIO. ....	8
3.4 OCCUPIED BANDWIDTH. ....	10
3.5 SPURIOUS AND HARMONIC EMISSIONS AT ANTENNA TERMINAL.....	11
3.6 FREQUENCY STABILITY / VARIATION OF AMBIENT TEMPERATURE .....	12
4. LIST OF TEST EQUIPMENT .....	13
5. SUMMARY OF TEST RESULTS .....	14
6. SAMPLE CALCULATION.....	15
7. TEST DATA .....	16
7.1 EQUIVALENT ISOTROPIC RADIATED POWER (Band 4) .....	16
7.2 RADIATED SPURIOUS EMISSIONS.....	20
7.2.1 RADIATED SPURIOUS EMISSIONS (1.4 MHz Band 4 LTE) .....	20
7.2.2 RADIATED SPURIOUS EMISSIONS (3 MHz Band 4 LTE) .....	21
7.2.3 RADIATED SPURIOUS EMISSIONS (5 MHz Band 4 LTE) .....	22
7.2.4 RADIATED SPURIOUS EMISSIONS (10 MHz Band 4 LTE) .....	23
7.2.5 RADIATED SPURIOUS EMISSIONS (15 MHz Band 4 LTE) .....	24
7.2.6 RADIATED SPURIOUS EMISSIONS (20 MHz Band 4 LTE) .....	25
7.3 PEAK-TO-AVERAGE RATIO .....	26
7.4 OCCUPIED BANDWIDTH .....	27
7.5 CONDUCTED SPURIOUS EMISSIONS .....	28
7.5.1 BAND EDGE.....	28
7.6 FREQUENCY STABILITY / VARIATION OF AMBIENT TEMPERATURE .....	29
7.6.1 FREQUENCY STABILITY (1.4 MHz Band 4 LTE).....	29
7.6.2 FREQUENCY STABILITY (3 MHz Band 4 LTE) .....	30
7.6.3 FREQUENCY STABILITY (5 MHz Band 4 LTE) .....	31
7.6.4 FREQUENCY STABILITY (10 MHz Band 4 LTE) .....	32
7.6.5 FREQUENCY STABILITY (15 MHz Band 4 LTE) .....	33
7.6.6 FREQUENCY STABILITY (20 MHz Band 4 LTE) .....	34
8. TEST PLOTS.....	35

# MEASUREMENT REPORT

## 1. GENERAL INFORMATION

**Applicant Name:** LG Electronics MobileComm U.S.A., Inc.

**Address:** 1000 Sylvan Avenue, Englewood Cliffs NJ 07632

**FCC ID:** ZNFK430T

**Application Type:** Certification

**FCC Classification:** Licensed Portable Transmitter Held to Ear (PCE)

**FCC Rule Part(s):** §27, §2

**EUT Type:** GSM WCDMA LTE Phone with BT & WLAN

**FCC Model(s):** LG-K430T

**Additional FCC Model(s):** LGK430T, K430T

**Tx Frequency:** 1710.7 MHz – 1754.3 MHz (LTE – Band 4 (1.4 MHz))  
1711.5 MHz – 1753.5 MHz (LTE – Band 4 (3 MHz))  
1712.5 MHz – 1752.5 MHz (LTE – Band 4 (5 MHz))  
1715.0 MHz – 1750.0 MHz (LTE – Band 4 (10 MHz))  
1717.5 MHz – 1747.5 MHz (LTE – Band 4 (15 MHz))  
1720.0 MHz – 1745.0 MHz (LTE – Band 4 (20 MHz))

**Max. RF Output Power:**

Band 4 (1.4 MHz):	0.121 W (QPSK) (20.82 dBm)
	0.101 W (16-QAM) (20.04 dBm)
Band 4 (3 MHz):	0.121 W (QPSK) (20.82 dBm)
	0.101 W (16-QAM) (20.02 dBm)
Band 4 (5 MHz):	0.122 W (QPSK) (20.85 dBm)
	0.101 W (16-QAM) (20.04 dBm)
Band 4 (10 MHz):	0.122 W (QPSK) (20.87 dBm)
	0.102 W (16-QAM) (20.09 dBm)
Band 4 (15 MHz):	0.123 W (QPSK) (20.91 dBm)
	0.103 W (16-QAM) (20.12 dBm)
Band 4 (20 MHz):	0.123 W (QPSK) (20.89 dBm)
	0.103 W (16-QAM) (20.11 dBm)

**Emission Designator(s):**

Band 4 (1.4 MHz):	1M09G7D (QPSK) / 1M10W7D (16-QAM)
Band 4 (3 MHz):	2M70G7D (QPSK) / 2M70W7D (16-QAM)
Band 4 (5 MHz):	4M51G7D (QPSK) / 4M51W7D (16-QAM)
Band 4 (10 MHz):	8M99G7D (QPSK) / 8M97W7D (16-QAM)
Band 4 (15 MHz):	13M5G7D (QPSK) / 13M5W7D (16-QAM)
Band 4 (20 MHz):	18M0G7D (QPSK) / 18M0W7D (16-QAM)

**Date(s) of Tests:** December 08, 2015 ~ January 05, 2016

**Antenna Specification:**

Manufacturer:	AT&C Co.LTD.
Antenna type:	Internal Antenna
Peak Gain:	Band 4: -5.71 dBi

## **2. INTRODUCTION**

### **2.1. EUT DESCRIPTION**

The LG Electronics MobileComm U.S.A., Inc. LG-K430T GSM WCDMA LTE Phone with BT & WLAN consists of LTE 4.

### **2.2. MEASURING INSTRUMENT CALIBRATION**

The measuring equipment, which was utilized in performing the tests documented herein, has been calibrated in accordance with the manufacturer's recommendations for utilizing calibration equipment, which is traceable to recognized national standards.

### **2.3. TEST FACILITY**

The Fully-anechoic chamber and conducted measurement facility used to collect the radiated data are located at the **74, Seoicheon-ro 578beon-gil, Majang-myeon, Icheon-si, Gyeonggi-do, 17383, Rep. of KOREA.**

## **3. DESCRIPTION OF TESTS**

### **3.1 EIRP RADIATED POWER AND RADIATED SPURIOUS EMISSIONS**

Note: EIRP(Effective Isotropic Radiated Power)

Test Procedure

Radiated emission measurements are performed in the Fully-anechoic chamber. The equipment under test is placed on a non-conductive table 3-meters away from the receive antenna in accordance with ANSI/TIA-603-D-2010 Clause 2.2.17. The turntable is rotated through 360 degrees, and the receiving antenna scans in order to determine the level of the maximized emission. The level and position of the maximized emission is recorded with the spectrum analyzer using a RMS detector.

A half wave dipole is then substituted in place of the EUT. For emissions above 1GHz, a horn antenna is substituted in place of the EUT. The substitute antenna is driven by a signal generator and the previously recorded signal was duplicated.

The power is calculated by the following formula;

$$P_{d(\text{dBm})} = P_{g(\text{dBm})} - \text{cable loss}_{(\text{dB})} + \text{antenna gain}_{(\text{dB})}$$

Where:  $P_d$  is the dipole equivalent power and  $P_g$  is the generator output power into the substitution antenna.

The maximum EIRP is calculated by adding the forward power to the calibrated source plus its appropriate gain value. These steps are repeated with the receiving antenna in both vertical and horizontal polarization. the difference between the gain of the horn and an isotropic antenna are taken into consideration

#### **Radiated spurious emissions**

: Frequency Range : 30 MHz ~ 10<sup>th</sup> Harmonics of highest channel fundamental frequency.

### 3.2 AWS – MOBILE FREQUENCY BLOCKS (1710 – 1755 MHz)

§27.5(h)

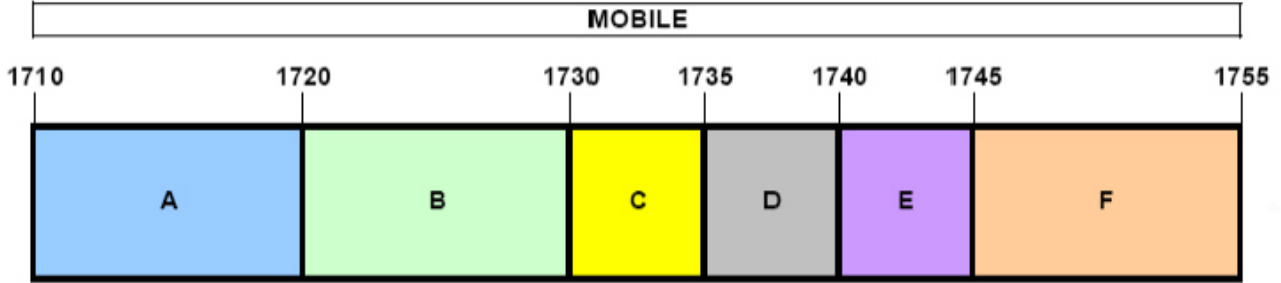

BLOCK 1: 1710 – 1720 MHz (A)

BLOCK 4: 1735 – 1740 MHz (D)

BLOCK 2: 1720 – 1730 MHz (B)

BLOCK 5: 1740 – 1745 MHz (E)

BLOCK 3: 1730 – 1735 MHz (C)

BLOCK 6: 1745 – 1755 MHz (F)

### 3.3 PEAK-AVERAGE RATIO.

#### Test Procedure

Peak to Average Power Ratio is tested in accordance with KDB971168 D01 Power Meas License Digital Systems v02r02, October 17, 2014, Section 5.7.

#### - Section 5.7.1 CCDF Procedure

- a) Set resolution/measurement bandwidth  $\geq$  signal's occupied bandwidth;
- b) Set the number of counts to a value that stabilizes the measured CCDF curve;
- c) Set the measurement interval as follows:
  - 1) for continuous transmissions, set to 1 ms,
  - 2) for burst transmissions, employ an external trigger that is synchronized with the EUT burst timing sequence, or use the internal burst trigger with a trigger level that allows the burst to stabilize and set the measurement interval to a time that is less than or equal to the burst duration.
- d) Record the maximum PAPR level associated with a probability of 0.1%.

#### - Section 5.7.2 Alternate Procedure

Use one of the procedures presented in 5.1 to measure the total peak power and record as  $P_{Pk}$ . Use one of the applicable procedures presented 5.2 to measure the total average power and record as  $P_{Avg}$ . Determine the P.A.R. from:  $P.A.R_{(dB)} = P_{Pk (dBm)} - P_{Avg (dBm)}$  ( $P_{Avg}$  = Average Power + Duty cycle Factor)

#### 5.1.1 Peak power measurements with a spectrum/signal analyzer or EMI receiver

The following procedure can be used to determine the total peak output power.

- a) Set the RBW  $\geq$  OBW.
- b) Set VBW  $\geq 3 \times$  RBW.
- c) Set span  $\geq 2 \times$  RBW
- d) Sweep time = auto couple.
- e) Detector = peak.
- f) Ensure that the number of measurement points  $\geq$  span/RBW.
- g) Trace mode = max hold.
- h) Allow trace to fully stabilize.
- i) Use the peak marker function to determine the peak amplitude level.



### **5.2.2 Procedures for use with a spectrum/signal analyzer when EUT cannot be configured to transmit continuously and sweep triggering/signal gating cannot be properly implemented**

If the EUT cannot be configured to transmit continuously (burst duty cycle < 98%), then one of the following procedures can be used. The selection of the applicable procedure will depend on the characteristics of the measured burst duty cycle.

Measure the burst duty cycle with a spectrum/signal analyzer or EMC receiver can be used in zero-span mode if the response time and spacing between bins on the sweep are sufficient to permit accurate measurement of the burst on/off time of the transmitted signal.

#### **5.2.2.2 Constant burst duty cycle**

If the measured burst duty cycle is constant (i.e., duty cycle variations are less than  $\pm 2$  percent), then:

- a) Set span to at least 1.5 times the OBW.
- b) Set RBW = 1-5% of the OBW, not to exceed 1 MHz.
- c) Set VBW  $\geq 3 \times$  RBW.
- d) Number of points in sweep  $\geq 2 \times$  span / RBW. (This gives bin-to-bin spacing  $\leq$  RBW/2, so that narrowband signals are not lost between frequency bins.)
- e) Sweep time = auto.
- f) Detector = RMS (power averaging).
- g) Set sweep trigger to "free run".
- h) Trace average at least 100 traces in power averaging (i.e., RMS) mode.
- i) Compute power by integrating the spectrum across the OBW of the signal using the instrument's band power measurement function with band limits set equal to the OBW band edges. If the instrument does not have a band power function, sum the spectrum levels (in power units) at intervals equal to the RBW extending across the entire OBW of the spectrum.
- j) Add  $10 \log (1/x)$ , where  $x$  is the duty cycle, to the measured power in order to compute the average power during the actual transmission times (because the measurement represents an average over both the on and off times of the transmission).

For example, add  $10 \log (1/0.25) = 6$  dB if the duty cycle is a constant 25%.

### 3.4 OCCUPIED BANDWIDTH.

Test set-up

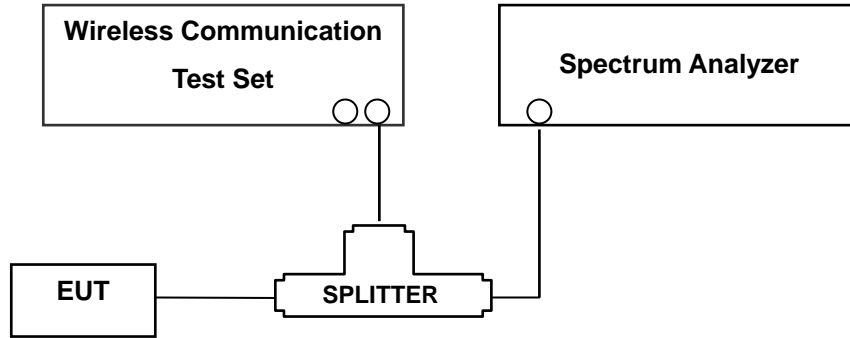

(Configuration of conducted Emission measurement)

The width of a frequency band such that, below the lower and above the upper frequency limits, the mean powers emitted are each equal to a specified percentage 0.5 % of the total mean power of a given emission.

#### Test Procedure

OBW is tested in accordance with KDB971168 D01 Power Meas License Digital Systems v02r02, October 17, 2014, Section 4.2.

The EUT makes a call to the communication simulator. The power was measured with R&S Spectrum Analyzer. All measurements were done at 3 channels(low, middle and high operational range.)

The conducted occupied bandwidth used the power splitter via EUT RF power connector between simulation base station and spectrum analyzer.

The communication simulator station system controlled a EUT to export maximum output power under transmission mode and specific channel frequency. Use OBW measurement function of Spectrum analyzer to measure 99 % occupied bandwidth

### 3.5 SPURIOUS AND HARMONIC EMISSIONS AT ANTENNA TERMINAL.

#### Test Procedure

Spurious and harmonic emissions at antenna terminal is tested in accordance with KDB971168 D01 Power Meas License Digital Systems v02r02, October 17, 2014, Section 6.0.

The level of the carrier and the various conducted spurious and harmonic frequencies is measured by means of a calibrated spectrum analyzer.

The spectrum is scanned from the lowest frequency generated in the equipment up to a frequency including its 10th harmonic. On any frequency outside a licensee's frequency block, the power of any emission shall be attenuated below the transmitter power (P) by at least  $43 + 10 \log(P)$  dB. Compliance with these provisions is based on the use of measurement instrumentation employing a resolution bandwidth of 1 MHz or greater. However, in the 100 kHz bands immediately outside and adjacent to the frequency block a resolution bandwidth of at least 30 kHz bandwidth may be employed. The emission bandwidth is defined as the width of the signal between two points, one below the carrier center frequency and one above the carrier center frequency

**NOTES:** The analyzer plot offsets were determined by below conditions.

- For LTE Band 4, total offset 27.6 dB = 20 dB attenuator + 6 dB Divider + 1.6 dB RF cables.

### 3.6 FREQUENCY STABILITY / VARIATION OF AMBIENT TEMPERATURE

#### Test Set-up

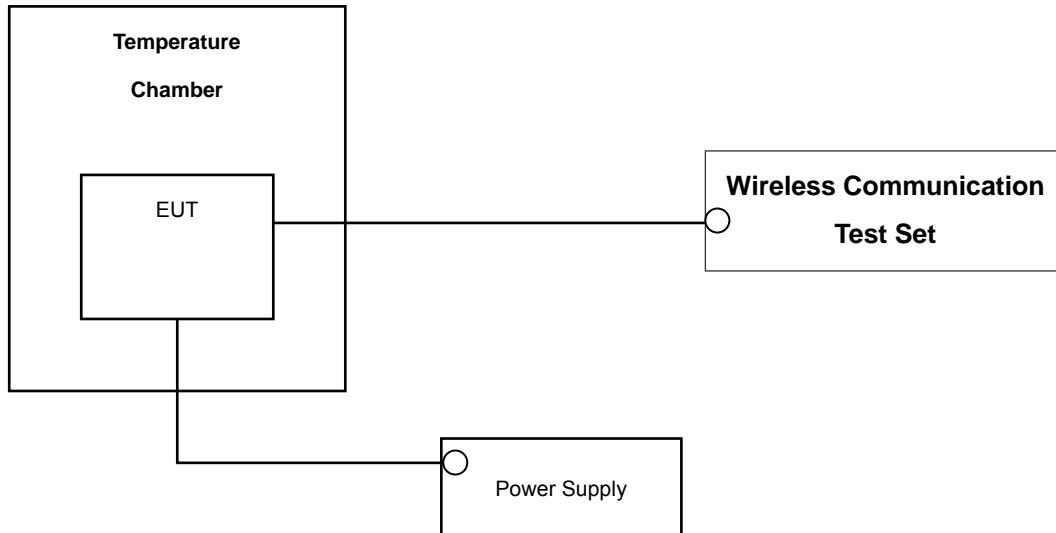

\* Nominal Operating Voltage

#### Test Procedure

Frequency stability is tested in accordance with ANSI/TIA-603-D-2010 section 2.2.2

The frequency stability of the transmitter is measured by:

- a.) **Temperature:** The temperature is varied from - 30 °C to + 50 °C using an environmental chamber.
- b.) **Primary Supply Voltage:** The primary supply voltage is varied from the end point to 100 % of the voltage normally at the input to the device or at the power supply terminals if cables are not normally supplied.

Specification — the frequency stability shall be sufficient to ensure that the fundamental emission stays within the authorized frequency block

#### Time Period and Procedure:

The carrier frequency of the transmitter is measured at room temperature (20°C to provide a reference).

1. The equipment is turned on in a “standby” condition for one minute before applying power to the transmitter. Measurement of the carrier frequency of the transmitter is made within one minute after applying power to the transmitter.
2. Frequency measurements are made at 10°C intervals ranging from -30°C to +50°C. A period of at least one half-hour is provided to allow stabilization of the equipment at each temperature level.

**NOTE: The EUT is tested down to the battery endpoint.**

## 4. LIST OF TEST EQUIPMENT

Manufacture	Model/ Equipment	Serial Number	Calibration Interval	Calibration Due
Agilent	N1921A/ Power Sensor	MY45241059	Annual	07/09/2016
Agilent	N1911A/ Power Meter	MY45100523	Annual	07/09/2016
MITEQ	AMF-6D-001180-35-20P/AMP	1081666	Annual	09/03/2016
Wainwright	WHK1.2/15G-10EF/H.P.F	4	Annual	04/27/2016
Wainwright	WHK3.3/18G-10EF/H.P.F	2	Annual	04/27/2016
Hewlett Packard	11667B / Power Splitter	10545	Annual	02/16/2016
Hewlett Packard	11667B / Power Splitter	11275	Annual	04/29/2016
ITECH	IT6720/ Power Supply	0100215626700119	Annual	11/02/2016
Schwarzbeck	UHAP/ Dipole Antenna	557	Biennial	03/23/2017
Schwarzbeck	UHAP/ Dipole Antenna	558	Biennial	03/23/2017
EXP	EX-TH400/ Chamber	None	Annual	05/29/2016
Schwarzbeck	BBHA 9120D/ Horn Antenna	147	Biennial	09/01/2016
Schwarzbeck	BBHA 9120D/ Horn Antenna	1299	Biennial	05/15/2017
Schwarzbeck	BBHA 9170/ Horn Antenna(15~40GHz)	BBHA9170342	Biennial	04/30/2017
Schwarzbeck	BBHA 9170/ Horn Antenna(15~35GHz)	BBHA9170124	Biennial	04/30/2017
Agilent	N9020A/Signal Analyzer	MY52090906	Annual	05/15/2016
Hewlett Packard	8493C/ATTENUATOR	17280	Annual	06/29/2016
REOHDE&SCHWARZ	FSV40/Spectrum Analyzer	1307.9002K40-100931-NK	Annual	06/04/2016
Agilent	8960 (E5515C)/ Base Station	MY48360800	Annual	10/30/2016
Anritsu Corp.	MT8820C/Wideband Radio Communication Tester	6201041449	Annual	07/28/2016

## 5. SUMMARY OF TEST RESULTS

FCC Part Section(s)	Test Description	Test Limit	Test Condition	Test Result
2.1049	Occupied Bandwidth	N/A	CONDUCTED	PASS
2.1051, 27.53(h)	Band Edge / Spurious and Harmonic Emissions at Antenna Terminal.	$< 43 + 10 \log_{10}(P[\text{Watts}])$ at Band Edge and for all-of-band emissions		PASS
27.50(d)(5)	Peak-Average Ratio	$< 13 \text{ dB}$		PASS
2.1046	*Conducted Output Power	N/A		PASS
2.1055, 27.54	Frequency stability / variation of ambient temperature	Emission must remain in band		PASS
27.50(d)(4)	Equivalent Isotropic Radiated Power	$< 1 \text{ Watts max. EIRP}$	RADIATED	PASS
				PASS
2.1053, 27.53(h)	Undesirable Out-of-Band Emissions	$< 43 + 10 \log_{10}(P[\text{Watts}])$ for all out-of-band emissions		PASS

\*: See SAR Report

## 6. SAMPLE CALCULATION

### A. EIRP Sample Calculation

Mode	Ch./ Freq.		Measured Level(dBm)	Substitute LEVEL(dBm)	Ant. Gain (dBi)	C.L	Pol.	EIRP	
	channel	Freq.(MHz)						W	dBm
LTE Band4	20175	1,732.50	-15.75	18.45	9.90	1.76	H	0.456	26.59

**EIRP = SubstituteLEVEL(dBm) + Ant. Gain – CL(Cable Loss)**

- 1) The EUT mounted on a wooden tripod is 2.5 meter above test site ground level.
- 2) During the test , the turn table is rotated and the antenna height is found.
- 3) Record the field strength meter's level.
- 4) Replace the EUT with dipole/Horn antenna that is connected to a calibrated signal generator.
- 5) Increase the signal generator output till the field strength meter's level is equal to the item (3).
- 6) The signal generator output level with Ant. Gain and cable loss are the rating of effective radiated power (EIRP).

### B. Emission Designator

#### QPSK Modulation

**Emission Designator = 4M48G7D**

LTE BW = 4.48 MHz

G = Phase Modulation

7 = Quantized/Digital Info

D = Data transmission; telemetry; telecommand

#### 16QAM Modulation

**Emission Designator = 4M48W7D**

LTE BW = 4.48 MHz

W = main carrier modulated in a combination of two

or more of the following modes;

amplitude, angle, pulse

7 = Quantized/Digital Info

D = Data transmission; telemetry; telecommand

## 7. TEST DATA

### 7.1 EQUIVALENT ISOTROPIC RADIATED POWER (Band 4)

Freq (MHz)	Bandwidth	Modulation	Measured Level (dBm)	Substitute Level (dBm)	Ant. Gain(dBi)	C.L	Pol	EIRP	
								W	dBm
1710.7	1.4 MHz	QPSK	-20.23	12.25	9.88	1.31	H	0.121	20.82
		16-QAM	-21.01	11.47	9.88	1.31	H	0.101	20.04
1732.5		QPSK	-20.36	12.12	9.96	1.32	H	0.119	20.76
		16-QAM	-21.14	11.34	9.96	1.32	H	0.100	19.98
1754.3		QPSK	-20.78	11.67	10.01	1.33	H	0.108	20.35
		16-QAM	-21.54	10.91	10.01	1.33	H	0.091	19.59

**Equivalent Isotropic Radiated Power Data (1.4 MHz Band 4 LTE)**

Note: All of RB size has been tested for emissions and EIRP, with the 1RB configuration observed as the worst case

Freq (MHz)	Bandwidth	Modulation	Measured Level (dBm)	Substitute Level (dBm)	Ant. Gain(dBi)	C.L	Pol	EIRP	
								W	dBm
1711.5	3 MHz	QPSK	-20.23	12.25	9.88	1.31	H	0.121	20.82
		16-QAM	-21.03	11.45	9.88	1.31	H	0.101	20.02
1732.5		QPSK	-20.37	12.11	9.95	1.32	H	0.119	20.74
		16-QAM	-21.14	11.34	9.95	1.32	H	0.099	19.97
1753.5		QPSK	-20.81	11.63	10.01	1.33	H	0.107	20.31
		16-QAM	-21.57	10.87	10.01	1.33	H	0.090	19.55

**Equivalent Isotropic Radiated Power Data (3 MHz Band 4 LTE)**

Note: All of RB size has been tested for emissions and EIRP, with the 1RB configuration observed as the worst case



Freq (MHz)	Bandwidth	Modulation	Measured Level (dBm)	Substitute Level (dBm)	Ant. Gain(dBi)	C.L	Pol	EIRP	
								W	dBm
1712.5	5 MHz	QPSK	-20.20	12.28	9.88	1.31	H	0.122	20.85
		16-QAM	-21.01	11.47	9.88	1.31	H	0.101	20.04
1732.5		QPSK	-20.30	12.17	9.95	1.32	H	0.120	20.80
		16-QAM	-21.06	11.41	9.95	1.32	H	0.101	20.04
1752.5		QPSK	-20.70	11.73	10.01	1.33	H	0.110	20.41
		16-QAM	-21.48	10.95	10.01	1.33	H	0.092	19.63

**Equivalent Isotropic Radiated Power Data (5 MHz Band 4 LTE)**

Note: All of RB size has been tested for emissions and EIRP, with the 1RB configuration observed as the worst case

Freq (MHz)	Bandwidth	Modulation	Measured Level (dBm)	Substitute Level (dBm)	Ant. Gain(dBi)	C.L	Pol	EIRP	
								W	dBm
1715.0	10 MHz	QPSK	-20.20	12.28	9.88	1.31	H	0.122	20.85
		16-QAM	-20.99	11.49	9.88	1.31	H	0.101	20.06
1732.5		QPSK	-20.22	12.25	9.94	1.32	H	0.122	20.87
		16-QAM	-21.00	11.47	9.94	1.32	H	0.102	20.09
1750.0		QPSK	-20.64	11.86	10.00	1.33	H	0.113	20.53
		16-QAM	-21.41	11.09	10.00	1.33	H	0.095	19.76

**Equivalent Isotropic Radiated Power Data (10 MHz Band 4 LTE)**

Note: All of RB size has been tested for emissions and EIRP, with the 1RB configuration observed as the worst case

Freq (MHz)	Bandwidth	Modulation	Measured Level (dBm)	Substitute Level (dBm)	Ant. Gain(dBi)	C.L	Pol	EIRP	
								W	dBm
1717.5	15 MHz	QPSK	-20.21	12.27	9.88	1.31	H	0.121	20.84
		16-QAM	-21.00	11.48	9.88	1.31	H	0.101	20.05
1732.5		QPSK	-20.17	12.30	9.93	1.32	H	0.123	20.91
		16-QAM	-20.96	11.51	9.93	1.32	H	0.103	20.12
1747.5		QPSK	-20.60	11.96	9.98	1.32	H	0.115	20.62
		16-QAM	-21.35	11.21	9.98	1.32	H	0.097	19.87

**Equivalent Isotropic Radiated Power Data (15 MHz Band 4 LTE)**

Note: All of RB size has been tested for emissions and EIRP, with the 1RB configuration observed as the worst case

Freq (MHz)	Bandwidth	Modulation	Measured Level (dBm)	Substitute Level (dBm)	Ant. Gain(dBi)	C.L	Pol	EIRP	
								W	dBm
1720.0	20 MHz	QPSK	-20.27	12.21	9.88	1.31	H	0.120	20.78
		16-QAM	-21.13	11.35	9.88	1.31	H	0.098	19.92
1732.5		QPSK	-20.18	12.28	9.92	1.31	H	0.123	20.89
		16-QAM	-20.96	11.50	9.92	1.31	H	0.103	20.11
1745.0		QPSK	-20.54	11.99	9.97	1.32	H	0.116	20.64
		16-QAM	-21.29	11.24	9.97	1.32	H	0.097	19.89

**Equivalent Isotropic Radiated Power Data (20 MHz Band 4 LTE)**

Note: All of RB size has been tested for emissions and EIRP, with the 1RB configuration observed as the worst case

**NOTES:**

Equivalent Isotropic Radiated Power Measurements by Substitution Method

according to ANSI/TIA/EIA-603-D-2010 June 24, 2010:

The EUT was placed on a non-conductive styrofoam resin table 3-meters from the receive antenna. The receive antenna height and turntable rotation was adjusted for the highest reading on the receive spectrum analyzer. For LTE signals, RBW = 1-5% of the OBW, not to exceed 1MHz, VBW  $\geq$  3 x RBW, Detector = RMS. A Horn antenna was substituted in place of the EUT. This Horn antenna was driven by a signal generator and the level of the signal generator was adjusted to obtain the same receive spectrum analyzer reading. The conducted power at the terminals of the Horn antenna is measured. The difference between the gain of the horn and an isotropic antenna is taken into consideration and the EIRP is recorded.

Also, we have done x, y, z planes in EUT and horizontal and vertical polarization in detecting antenna. The worst case of the EUT is x plane in LTE mode. Also worst case of detecting Antenna is horizontal polarization in LTE mode.

## 7.2 RADIATED SPURIOUS EMISSIONS

### 7.2.1 RADIATED SPURIOUS EMISSIONS (1.4 MHz Band 4 LTE)

- ▣ OPERATING FREQUENCY: 1710.70 MHz
- ▣ MEASURED OUTPUT POWER: 20.82 dBm = 0.121 W
- ▣ MODULATION SIGNAL: 1.4 MHz QPSK
- ▣ DISTANCE: 3 meters
- ▣ LIMIT:  $43 + 10 \log_{10}(W) =$  33.82 dBc

Ch	Freq (MHz)	Measured Level (dBm)	Ant. Gain (dBi)	Substitute Level (dBm)	C.L	Pol	EIRP (dBm)	dBc
19957 (1710.7)	3,421.40	-45.39	12.36	-50.47	1.94	V	-40.05	60.87
	5,132.10	-48.11	12.34	-46.19	2.37	V	-36.22	57.04
	6,842.80	-48.57	12.17	-42.07	2.81	V	-32.71	53.53
20175 (1732.5)	3,465.00	-45.32	12.27	-49.88	1.87	H	-39.48	60.30
	5,197.50	-50.01	12.63	-48.46	2.45	V	-38.28	59.10
	6,930.00	-52.94	11.87	-45.34	2.84	V	-36.31	57.13
20393 (1754.3)	3,508.60	-44.82	12.15	-48.94	2.00	H	-38.79	59.61
	5,262.90	-50.55	12.91	-49.75	2.41	V	-39.25	60.07
	7,017.20	-54.93	11.57	-47.31	2.90	V	-38.64	59.46

- NOTES:**
1. Radiated Spurious Emission Measurements at 3 meters by Substitution Method according to ANSI/TIA/EIA-603-D-2010 June 24, 2010:
  2. We are performed all frequency to 10<sup>th</sup> harmonics from 30 MHz. Measurements above show only up to 3 maximum emissions noted, or would be lesser if no specific emissions from the EUT are recorded (ie: margin > 20 dB from the applicable limit) and considered that's already beyond the background noise floor.
  3. We have done x, y, z planes in EUT and horizontal and vertical polarization in detecting antenna.
  4. All of RB size has been tested for emissions and EIRP, with the 1RB configuration observed as the worst case
  5. We are performed 16QAM and QPSK modulations. The worst case data are reported in the table above.

## 7.2.2 RADIATED SPURIOUS EMISSIONS (3 MHz Band 4 LTE)

- ▣ OPERATING FREQUENCY: 1711.50 MHz
- ▣ MEASURED OUTPUT POWER: 20.82 dBm = 0.121 W
- ▣ MODULATION SIGNAL: 3 MHz QPSK
- ▣ DISTANCE: 3 meters
- ▣ LIMIT:  $43 + 10 \log_{10}(W) =$  33.82 dBc

Ch	Freq (MHz)	Measured Level (dBm)	Ant. Gain (dBi)	Substitute Level (dBm)	C.L	Pol	EIRP (dBm)	dBc
19965 (1711.5)	3,423.00	-48.05	12.35	-53.15	1.94	H	-42.74	63.56
	5,134.50	-50.65	12.35	-48.66	2.37	V	-38.68	59.50
	6,846.00	-52.71	12.16	-46.22	2.80	V	-36.86	57.68
20175 (1732.5)	3,465.00	-48.16	12.27	-52.72	1.87	H	-42.32	63.14
	5,197.50	-50.21	12.63	-48.66	2.45	V	-38.48	59.30
	6,930.00	-55.57	11.87	-47.97	2.84	V	-38.94	59.76
20385 (1753.5)	3,507.00	-48.28	12.15	-52.40	1.99	H	-42.24	63.06
	5,260.50	-52.47	12.90	-51.64	2.42	V	-41.16	61.98
	7,014.00	-55.01	11.59	-47.54	2.91	V	-38.86	59.68

- NOTES:**
1. Radiated Spurious Emission Measurements at 3 meters by Substitution Method according to ANSI/TIA/EIA-603-D-2010 June 24, 2010:
  2. We are performed all frequency to 10<sup>th</sup> harmonics from 30 MHz. Measurements above show only up to 3 maximum emissions noted, or would be lesser if no specific emissions from the EUT are recorded (ie: margin > 20 dB from the applicable limit) and considered that's already beyond the background noise floor.
  3. We have done x, y, z planes in EUT and horizontal and vertical polarization in detecting antenna.
  4. All of RB size has been tested for emissions and EIRP, with the 1RB configuration observed as the worst case
  5. We are performed 16QAM and QPSK modulations. The worst case data are reported in the table above.

### 7.2.3 RADIATED SPURIOUS EMISSIONS (5 MHz Band 4 LTE)

- ▣ OPERATING FREQUENCY: 1712.50 MHz
- ▣ MEASURED OUTPUT POWER: 20.85 dBm = 0.122 W
- ▣ MODULATION SIGNAL: 5 MHz QPSK
- ▣ DISTANCE: 3 meters
- ▣ LIMIT:  $43 + 10 \log_{10}(W) =$  33.85 dBc

Ch	Freq (MHz)	Measured Level (dBm)	Ant. Gain (dBi)	Substitute Level (dBm)	C.L	Pol	EIRP (dBm)	dBc
19975 (1712.5)	3,425.00	-46.46	12.35	-51.60	1.95	H	-41.20	62.05
	5,137.50	-50.23	12.36	-48.15	2.38	V	-38.17	59.02
	6,850.00	-54.36	12.15	-47.88	2.80	V	-38.53	59.38
20175 (1732.5)	3,465.00	-46.39	12.27	-50.95	1.87	H	-40.55	61.40
	5,197.50	-49.95	12.63	-48.40	2.45	V	-38.22	59.07
	6,930.00	-55.77	11.87	-48.17	2.84	V	-39.14	59.99
20375 (1752.5)	3,505.00	-45.48	12.15	-49.61	1.98	H	-39.44	60.29
	5,257.50	-49.80	12.89	-48.97	2.41	V	-38.49	59.34
	7,010.00	-57.12	11.61	-49.84	2.91	V	-41.14	61.99

- NOTES:**
1. Radiated Spurious Emission Measurements at 3 meters by Substitution Method according to ANSI/TIA/EIA-603-D-2010 June 24, 2010:
  2. We are performed all frequency to 10<sup>th</sup> harmonics from 30 MHz. Measurements above show only up to 3 maximum emissions noted, or would be lesser if no specific emissions from the EUT are recorded (ie: margin > 20 dB from the applicable limit) and considered that's already beyond the background noise floor.
  3. We have done x, y, z planes in EUT and horizontal and vertical polarization in detecting antenna.
  4. All of RB size has been tested for emissions and EIRP, with the 1RB configuration observed as the worst case
  5. We are performed 16QAM and QPSK modulations. The worst case data are reported in the table above.

### 7.2.4 RADIATED SPURIOUS EMISSIONS (10 MHz Band 4 LTE)

- ▣ OPERATING FREQUENCY: 1732.50 MHz
- ▣ MEASURED OUTPUT POWER: 20.87 dBm = 0.122 W
- ▣ MODULATION SIGNAL: 10 MHz QPSK
- ▣ DISTANCE: 3 meters
- ▣ LIMIT:  $43 + 10 \log_{10}(W) =$  33.87 dBc

Ch	Freq (MHz)	Measured Level (dBm)	Ant. Gain (dBi)	Substitute Level (dBm)	C.L	Pol	EIRP (dBm)	dBc
20000 (1715.0)	3,430.00	-45.31	12.34	-50.54	1.95	H	-40.15	61.02
	5,145.00	-49.66	12.38	-47.62	2.39	V	-37.63	58.50
	6,860.00	-52.43	12.11	-45.99	2.81	V	-36.69	57.56
20175 (1732.5)	3,465.00	-45.22	12.27	-49.78	1.87	H	-39.38	60.25
	5,197.50	-49.81	12.63	-48.26	2.45	V	-38.08	58.95
	6,930.00	-55.76	11.87	-48.16	2.84	H	-39.13	60.00
20350 (1750.0)	3,500.00	-45.70	12.15	-49.85	1.95	H	-39.65	60.52
	5,250.00	-50.19	12.87	-49.35	2.39	V	-38.87	59.74
	7,000.00	-55.85	11.65	-49.18	2.85	V	-40.38	61.25

- NOTES:**
1. Radiated Spurious Emission Measurements at 3 meters by Substitution Method according to ANSI/TIA/EIA-603-D-2010 June 24, 2010:
  2. We are performed all frequency to 10<sup>th</sup> harmonics from 30 MHz. Measurements above show only up to 3 maximum emissions noted, or would be lesser if no specific emissions from the EUT are recorded (ie: margin > 20 dB from the applicable limit) and considered that's already beyond the background noise floor.
  3. We have done x, y, z planes in EUT and horizontal and vertical polarization in detecting antenna.
  4. All of RB size has been tested for emissions and EIRP, with the 1RB configuration observed as the worst case
  5. We are performed 16QAM and QPSK modulations. The worst case data are reported in the table above.

### 7.2.5 RADIATED SPURIOUS EMISSIONS (15 MHz Band 4 LTE)

- ▣ OPERATING FREQUENCY: 1732.50 MHz
- ▣ MEASURED OUTPUT POWER: 20.91 dBm = 0.123 W
- ▣ MODULATION SIGNAL: 15 MHz QPSK
- ▣ DISTANCE: 3 meters
- ▣ LIMIT:  $43 + 10 \log_{10}(W) =$  33.91 dBc

Ch	Freq (MHz)	Measured Level (dBm)	Ant. Gain (dBi)	Substitute Level (dBm)	C.L	Pol	EIRP (dBm)	dBc
20025 (1717.5)	3,435.00	-45.34	12.34	-50.32	1.92	H	-39.90	60.81
	5,152.50	-48.53	12.40	-46.64	2.39	V	-36.63	57.54
	6,870.00	-52.58	12.08	-46.32	2.79	V	-37.03	57.94
20175 (1732.5)	3,465.00	-45.05	12.27	-49.61	1.87	H	-39.21	60.12
	5,197.50	-50.32	12.63	-48.77	2.45	V	-38.59	59.50
	6,930.00	-51.68	11.87	-44.08	2.84	V	-35.05	55.96
20325 (1747.5)	3,495.00	-45.21	12.17	-49.48	1.93	H	-39.24	60.15
	5,242.50	-49.93	12.83	-48.94	2.41	V	-38.52	59.43
	6,990.00	-51.92	11.68	-44.01	2.80	V	-35.13	56.04

- NOTES:**
1. Radiated Spurious Emission Measurements at 3 meters by Substitution Method according to ANSI/TIA/EIA-603-D-2010 June 24, 2010:
  2. We are performed all frequency to 10<sup>th</sup> harmonics from 30 MHz. Measurements above show only up to 3 maximum emissions noted, or would be lesser if no specific emissions from the EUT are recorded (ie: margin > 20 dB from the applicable limit) and considered that's already beyond the background noise floor.
  3. We have done x, y, z planes in EUT and horizontal and vertical polarization in detecting antenna.
  4. All of RB size has been tested for emissions and EIRP, with the 1RB configuration observed as the worst case
  5. We are performed 16QAM and QPSK modulations. The worst case data are reported in the table above.



### 7.2.6 RADIATED SPURIOUS EMISSIONS (20 MHz Band 4 LTE)

- ▣ OPERATING FREQUENCY: 1732.50 MHz
- ▣ MEASURED OUTPUT POWER: 20.89 dBm = 0.123 W
- ▣ MODULATION SIGNAL: 20 MHz QPSK
- ▣ DISTANCE: 3 meters
- ▣ LIMIT:  $43 + 10 \log_{10}(W) =$  33.89 dBc

Ch	Freq (MHz)	Measured Level (dBm)	Ant. Gain (dBi)	Substitute Level (dBm)	C.L	Pol	EIRP (dBm)	dBc
20050 (1720.0)	3,440.00	-45.53	12.33	-50.24	1.89	H	-39.80	60.69
	5,160.00	-49.29	12.44	-47.50	2.40	V	-37.46	58.35
	6,880.00	-51.99	12.04	-45.28	2.78	H	-36.02	56.91
20175 (1732.5)	3,465.00	-45.08	12.27	-49.64	1.87	H	-39.24	60.13
	5,197.50	-49.36	12.63	-47.81	2.45	V	-37.63	58.52
	6,930.00	-53.62	11.87	-46.02	2.84	H	-36.99	57.88
20300 (1745.0)	3,490.00	-45.84	12.18	-50.24	1.90	H	-39.96	60.85
	5,235.00	-50.74	12.80	-49.55	2.42	V	-39.17	60.06
	6,980.00	-54.31	11.71	-46.15	2.79	V	-37.23	58.12

- NOTES:**
1. Radiated Spurious Emission Measurements at 3 meters by Substitution Method according to ANSI/TIA/EIA-603-D-2010 June 24, 2010:
  2. We are performed all frequency to 10<sup>th</sup> harmonics from 30 MHz. Measurements above show only up to 3 maximum emissions noted, or would be lesser if no specific emissions from the EUT are recorded (ie: margin > 20 dB from the applicable limit) and considered that's already beyond the background noise floor.
  3. We have done x, y, z planes in EUT and horizontal and vertical polarization in detecting antenna.
  4. All of RB size has been tested for emissions and EIRP, with the 1RB configuration observed as the worst case
  5. We are performed 16QAM and QPSK modulations. The worst case data are reported in the table above.

### 7.3 PEAK-TO-AVERAGE RATIO

Band	Band Width	Frequency (MHz)	Modulation	Resource Block Size	Resource Block Offset	Data (dB )
4	1.4 MHz	1732.5	QPSK	6	0	5.20
			16-QAM	6		5.97
	3 MHz		QPSK	15		5.53
			16-QAM	15		6.27
	5 MHz		QPSK	25		5.50
			16-QAM	25		6.16
	10 MHz		QPSK	50		5.51
			16-QAM	50		6.13
	15 MHz		QPSK	75		5.31
			16-QAM	75		5.99
	20 MHz		QPSK	100		5.40
			16-QAM	100		6.12

- Plots of the EUT's Peak- to- Average Ratio are shown Page 42 ~ 47.

### 7.4 OCCUPIED BANDWIDTH

Band	Band Width (MHz)	Frequency (MHz)	Modulation	Resource Block Size	Resource Block Offset	Data ( MHz )
4	1.4	1732.5	QPSK	6	0	1.0922
			16-QAM	6		1.0973
	3		QPSK	15		2.6956
			16-QAM	15		2.6962
	5		QPSK	25		4.5087
			16-QAM	25		4.5095
	10		QPSK	50		8.9942
			16-QAM	50		8.9692
	15		QPSK	75		13.4870
			16-QAM	75		13.4740
	20		QPSK	100		17.9540
			16-QAM	100		18.0180

- Plots of the EUT's Occupied Bandwidth are shown Page 36 ~ 41.

## 7.5 CONDUCTED SPURIOUS EMISSIONS

▣ FACTORS FOR FREQUENCY

Frequency Range (GHz)	Factor [dB]
0.03 – 1	27.145
1 – 5	26.960
5 – 10	27.542
10 – 15	28.439
15 – 20	29.144
Above 20	30.148

**NOTES:**

Factor(dB) = Cable Loss + Attenuator + Power Splitter

Band	Band Width (MHz)	Frequency (MHz)	Frequency of Maximum Harmonic (GHz)	Factor (dB)	Measurement Maximum Data (dBm)	Result (dBm)
4	1.4	1710.7	18.7735	29.144	-65.834	-36.690
		1732.5	19.4460	29.144	-65.717	-36.573
		1754.3	18.9140	29.144	-65.042	-35.898
	3	1711.5	18.9450	29.144	-66.248	-37.104
		1732.5	18.9050	29.144	-64.752	-35.608
		1753.5	19.1920	29.144	-66.118	-36.974
	5	1712.5	19.3065	29.144	-65.538	-36.394
		1732.5	16.6260	29.144	-66.143	-36.999
		1752.5	18.9305	29.144	-65.468	-36.324
	10	1715.0	18.6930	29.144	-65.238	-36.094
		1732.5	18.7160	29.144	-65.636	-36.492
		1750.0	18.9535	29.144	-66.254	-37.110
	15	1717.5	18.9060	29.144	-66.196	-37.052
		1732.5	19.5630	29.144	-65.348	-36.204
		1747.5	18.8905	29.144	-66.422	-37.278
	20	1720.0	3.4228	27.542	-65.618	-38.076
		1732.5	16.3965	29.144	-65.861	-36.717
		1745.0	19.8995	29.144	-65.662	-36.518

**NOTES:**

1. Conducted Spurious Emissions was Tested QPSK Modulation, Resource Block Size 1 and Resource Block Offset 0
2. Result (dBm) = Measurement Maximum Data (dBm) + Factor (dB)

- Plots of the EUT's Conducted Spurious Emissions are shown Page 66 ~ 83.

### 7.5.1 BAND EDGE

- Plots of the EUT's Band Edge are shown Page 48 ~ 65.

## 7.6 FREQUENCY STABILITY / VARIATION OF AMBIENT TEMPERATURE

### 7.6.1 FREQUENCY STABILITY (1.4 MHz Band 4 LTE)

- OPERATING FREQUENCY: 1732,500,000 Hz
- CHANNEL: 20175 (1.4 MHz)
- REFERENCE VOLTAGE: 3.8 VDC
- DEVIATION LIMIT: Emission must remain in band

Voltage (%)	Power (VDC)	Temp. (°C)	Frequency (Hz)	Frequency Error (Hz)	Deviation (%)	ppm
100%	3.8	+20(Ref)	1732 499 992	0.0	0.000 000	0.000
100%		-30	1732 499 986	-5.6	0.000 000	-0.003
100%		-20	1732 499 986	-6.2	0.000 000	-0.004
100%		-10	1732 499 988	-4.1	0.000 000	-0.002
100%		0	1732 499 986	-6.0	0.000 000	-0.003
100%		+10	1732 499 988	-4.3	0.000 000	-0.002
100%		+30	1732 499 984	-7.7	0.000 000	-0.004
100%		+40	1732 499 985	-7.2	0.000 000	-0.004
100%		+50	1732 499 985	-6.6	0.000 000	-0.004
Batt. Endpoint	3.6	+20	1732 499 985	-6.7	0.000 000	-0.004

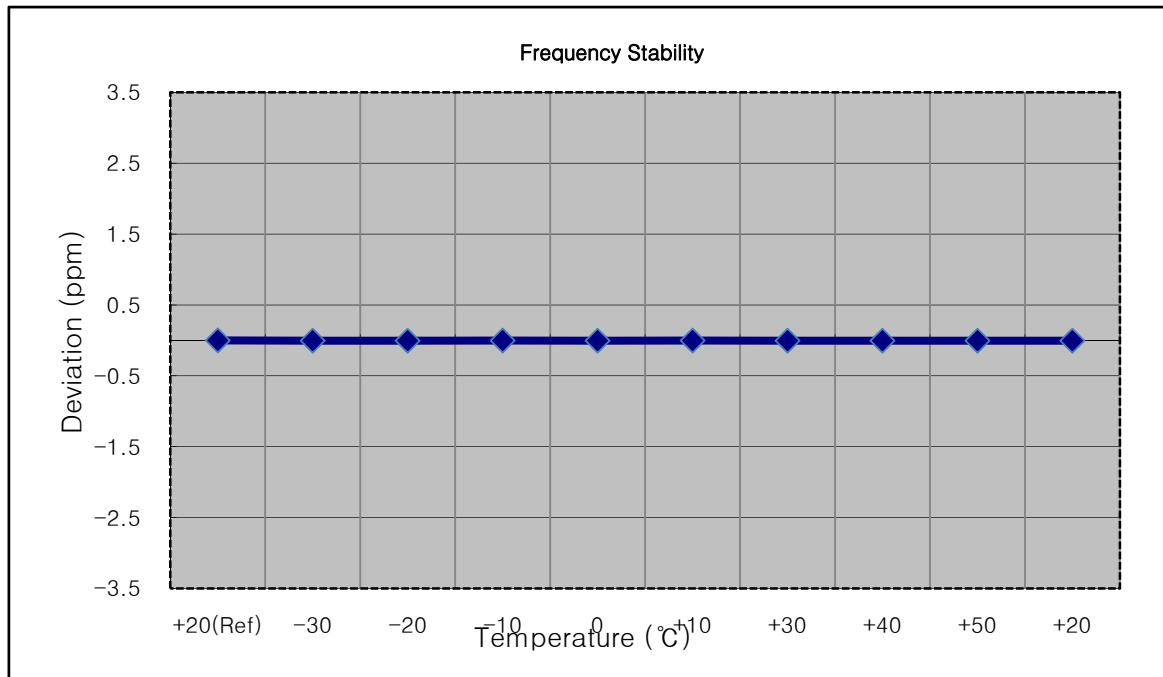

**7.6.2 FREQUENCY STABILITY (3 MHz Band 4 LTE)**

- OPERATING FREQUENCY: 1732,500,000 Hz
- CHANNEL: 20175 (3 MHz)
- REFERENCE VOLTAGE: 3.8 VDC
- DEVIATION LIMIT: Emission must remain in band

Voltage (%)	Power (VDC)	Temp. (°C)	Frequency (Hz)	Frequency Error (Hz)	Deviation (%)	ppm
100%	3.8	+20(Ref)	1732 499 996	0.0	0.000 000	0.000
100%		-30	1732 499 991	-5.6	0.000 000	-0.003
100%		-20	1732 499 988	-8.2	0.000 000	-0.005
100%		-10	1732 499 991	-4.8	0.000 000	-0.003
100%		0	1732 500 000	3.6	0.000 000	0.002
100%		+10	1732 499 989	-7.7	0.000 000	-0.004
100%		+30	1732 499 987	-8.8	-0.000 001	-0.005
100%		+40	1732 499 988	-8.4	0.000 000	-0.005
100%		+50	1732 499 989	-6.9	0.000 000	-0.004
Batt. Endpoint	3.6	+20	1732 499 991	-5.2	0.000 000	-0.003

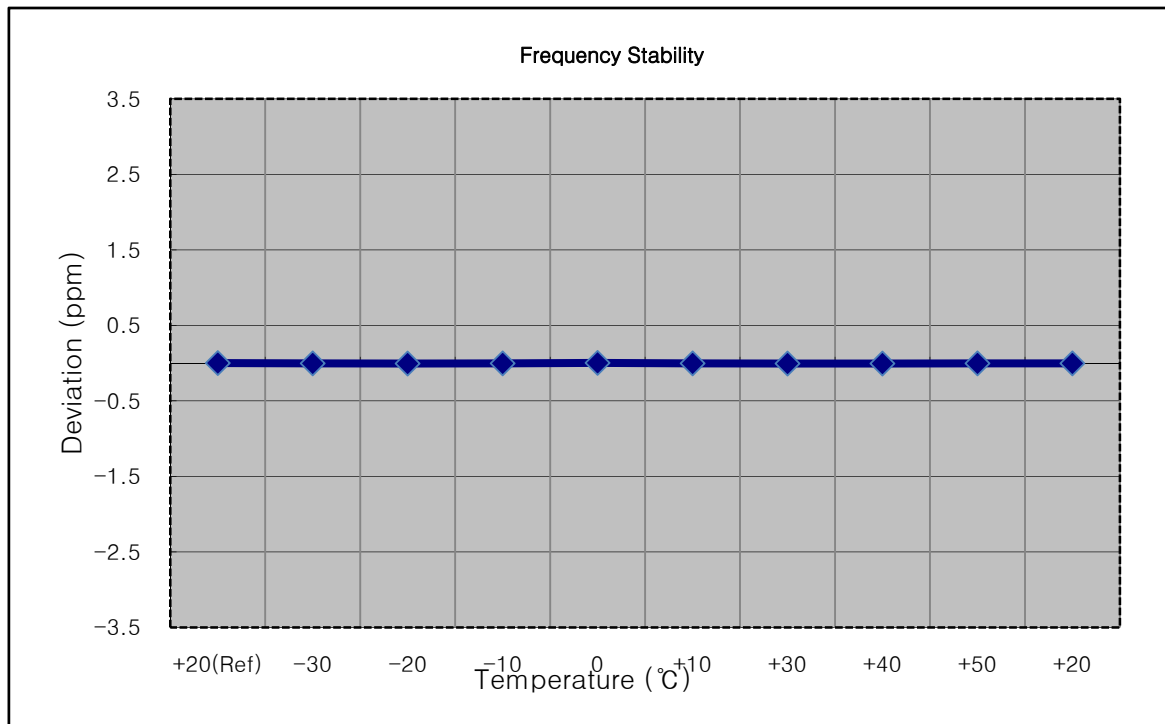

**7.6.3 FREQUENCY STABILITY (5 MHz Band 4 LTE)**

- OPERATING FREQUENCY: 1732,500,000 Hz
- CHANNEL: 20175 (5 MHz)
- REFERENCE VOLTAGE: 3.8 VDC
- DEVIATION LIMIT: Emission must remain in band

Voltage (%)	Power (VDC)	Temp. (°C)	Frequency (Hz)	Frequency Error (Hz)	Deviation (%)	ppm
100%	3.8	+20(Ref)	1732 499 995	0.0	0.000 000	0.000
100%		-30	1732 499 990	-4.9	0.000 000	-0.003
100%		-20	1732 499 990	-4.6	0.000 000	-0.003
100%		-10	1732 499 992	-3.0	0.000 000	-0.002
100%		0	1732 499 990	-5.1	0.000 000	-0.003
100%		+10	1732 499 988	-6.4	0.000 000	-0.004
100%		+30	1732 499 986	-8.9	-0.000 001	-0.005
100%		+40	1732 499 990	-4.6	0.000 000	-0.003
100%		+50	1732 499 993	-2.1	0.000 000	-0.001
Batt. Endpoint	3.6	+20	1732 499 989	-6.3	0.000 000	-0.004

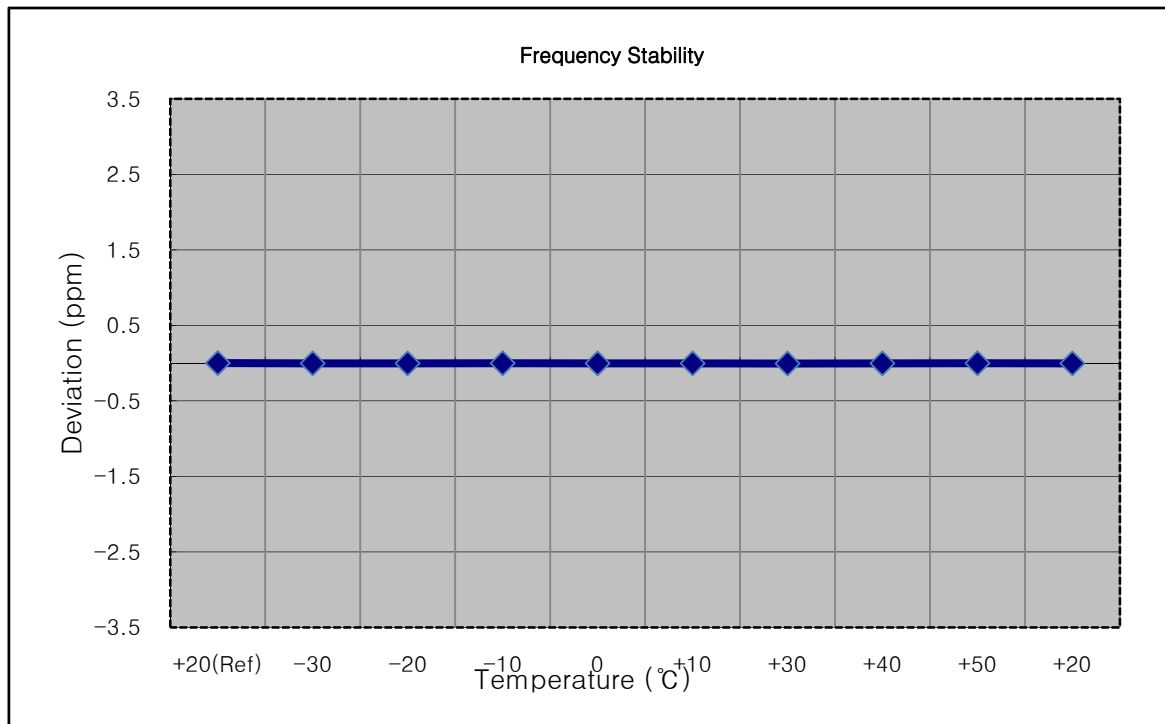

**7.6.4 FREQUENCY STABILITY (10 MHz Band 4 LTE)**

- OPERATING FREQUENCY: 1732,500,000 Hz
- CHANNEL: 20175 (10 MHz)
- REFERENCE VOLTAGE: 3.8 VDC
- DEVIATION LIMIT: Emission must remain in band

Voltage (%)	Power (VDC)	Temp. (°C)	Frequency (Hz)	Frequency Error (Hz)	Deviation (%)	ppm
100%	3.8	+20(Ref)	1732 500 008	0.0	0.000 000	0.000
100%		-30	1732 500 014	5.7	0.000 000	0.003
100%		-20	1732 500 015	7.2	0.000 000	0.004
100%		-10	1732 500 012	4.0	0.000 000	0.002
100%		0	1732 500 013	5.0	0.000 000	0.003
100%		+10	1732 500 015	6.7	0.000 000	0.004
100%		+30	1732 500 011	3.1	0.000 000	0.002
100%		+40	1732 500 014	6.0	0.000 000	0.003
100%		+50	1732 500 011	3.6	0.000 000	0.002
Batt. Endpoint	3.6	+20	1732 500 014	6.5	0.000 000	0.004

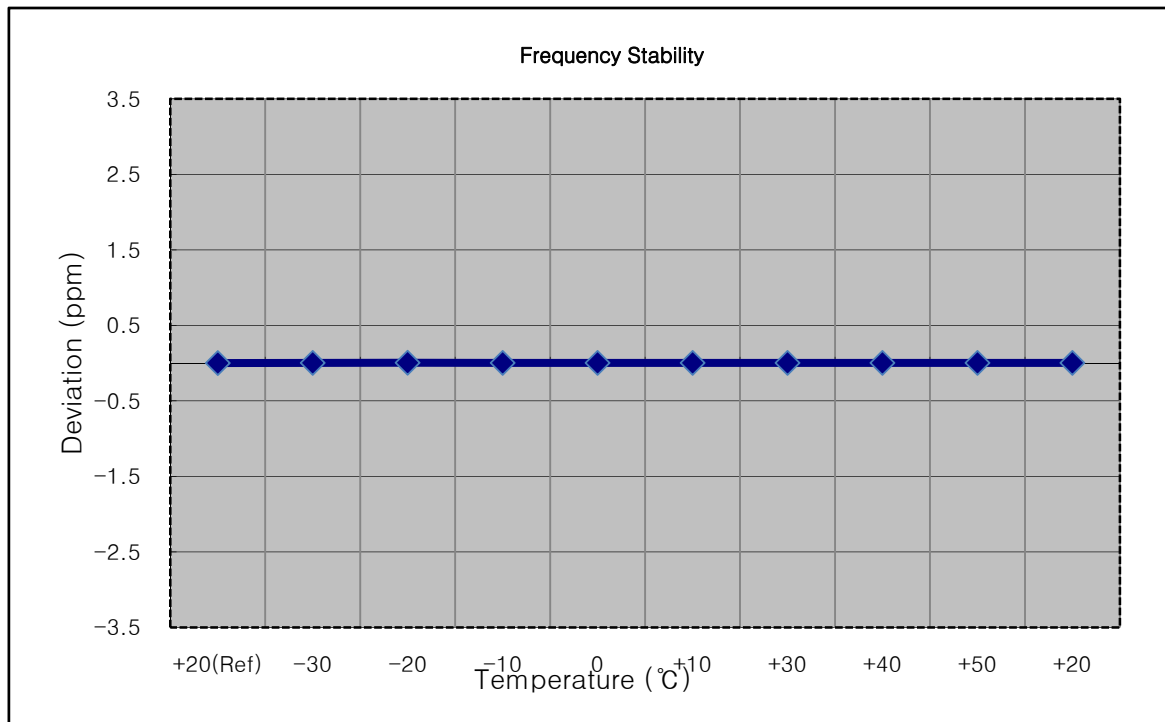



**7.6.5 FREQUENCY STABILITY (15 MHz Band 4 LTE)**

- OPERATING FREQUENCY: 1732,500,000 Hz
- CHANNEL: 20175 (15 MHz)
- REFERENCE VOLTAGE: 3.8 VDC
- DEVIATION LIMIT: Emission must remain in band

Voltage (%)	Power (VDC)	Temp. (°C)	Frequency (Hz)	Frequency Error (Hz)	Deviation (%)	ppm
100%	3.8	+20(Ref)	1732 499 993	0.0	0.000 000	0.000
100%		-30	1732 499 988	-4.8	0.000 000	-0.003
100%		-20	1732 499 984	-9.3	-0.000 001	-0.005
100%		-10	1732 499 985	-7.9	0.000 000	-0.005
100%		0	1732 499 984	-8.7	-0.000 001	-0.005
100%		+10	1732 499 987	-6.3	0.000 000	-0.004
100%		+30	1732 499 988	-5.1	0.000 000	-0.003
100%		+40	1732 499 987	-5.8	0.000 000	-0.003
100%		+50	1732 499 986	-7.4	0.000 000	-0.004
Batt. Endpoint	3.6	+20	1732 499 988	-5.4	0.000 000	-0.003

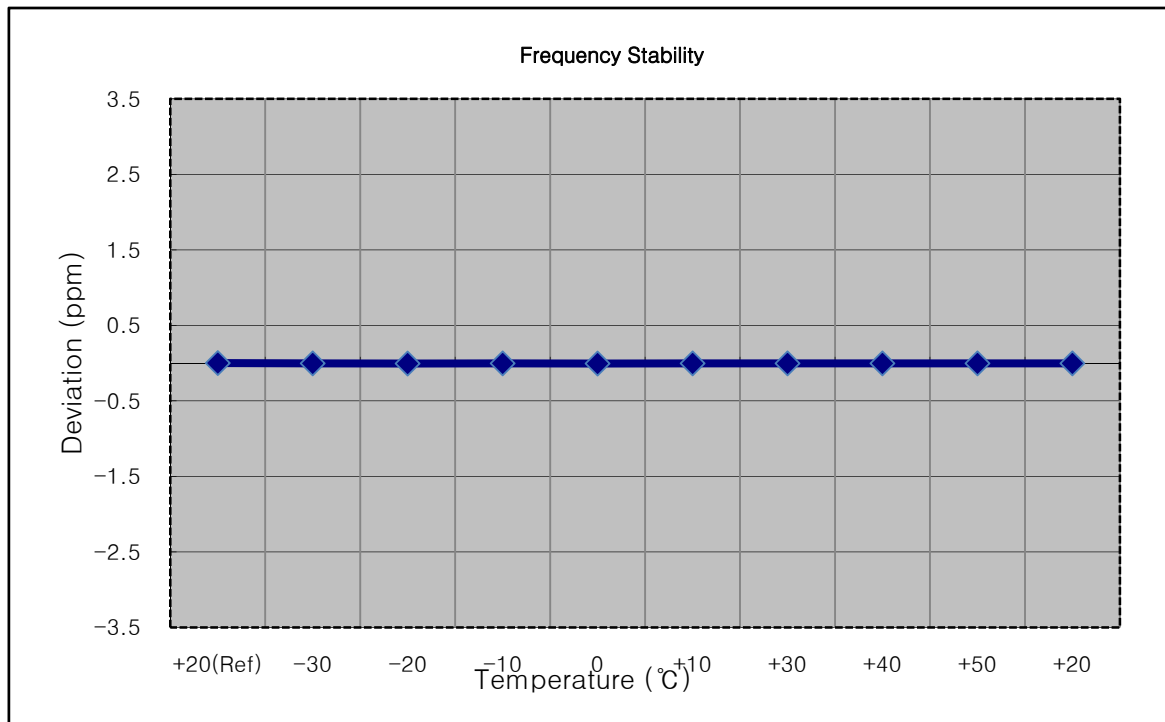

**7.6.6 FREQUENCY STABILITY (20 MHz Band 4 LTE)**

- OPERATING FREQUENCY: 1732,500,000 Hz
- CHANNEL: 20175 (20 MHz)
- REFERENCE VOLTAGE: 3.8 VDC
- DEVIATION LIMIT: Emission must remain in band

Voltage (%)	Power (VDC)	Temp. (°C)	Frequency (Hz)	Frequency Error (Hz)	Deviation (%)	ppm
100%	3.8	+20(Ref)	1732 499 996	0.0	0.000 000	0.000
100%		-30	1732 499 991	-5.0	0.000 000	-0.003
100%		-20	1732 500 002	5.5	0.000 000	0.003
100%		-10	1732 499 992	-4.2	0.000 000	-0.002
100%		0	1732 500 003	6.7	0.000 000	0.004
100%		+10	1732 499 991	-5.4	0.000 000	-0.003
100%		+30	1732 499 988	-7.8	0.000 000	-0.005
100%		+40	1732 500 000	3.7	0.000 000	0.002
100%		+50	1732 499 992	-4.1	0.000 000	-0.002
Batt. Endpoint	3.6	+20	1732 499 991	-5.7	0.000 000	-0.003

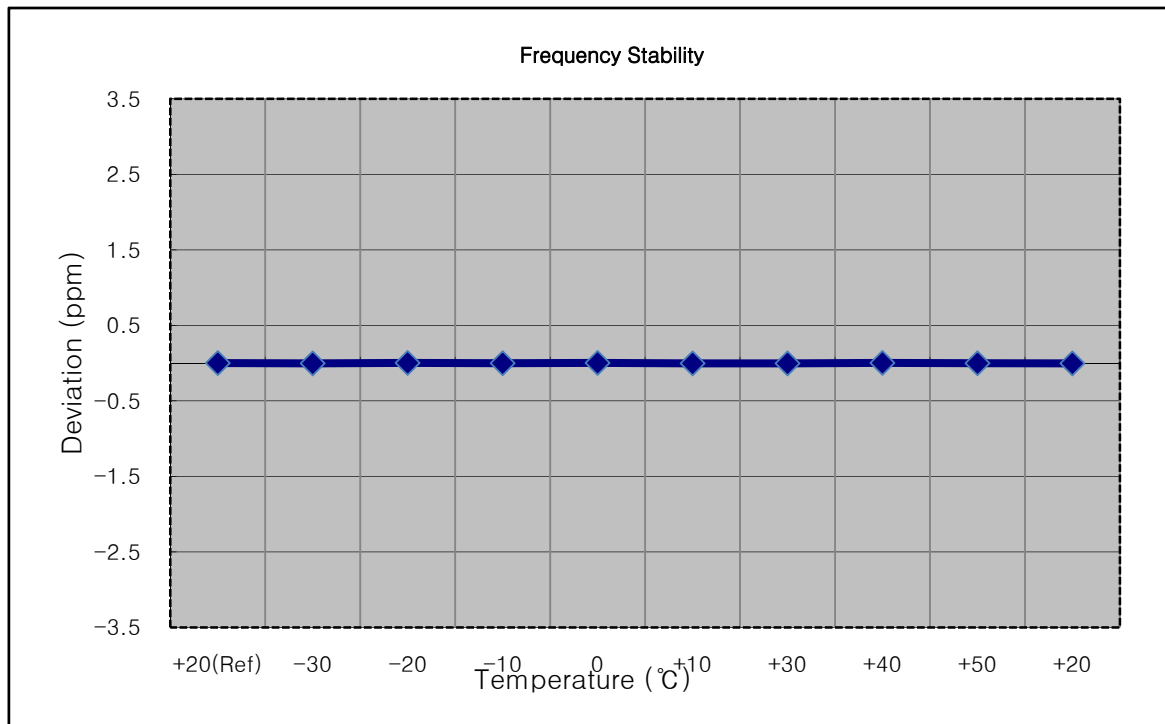

## **8. TEST PLOTS**

BAND 4. Occupied Bandwidth Plot (1.4M BW Ch.20175 QPSK RB 6)

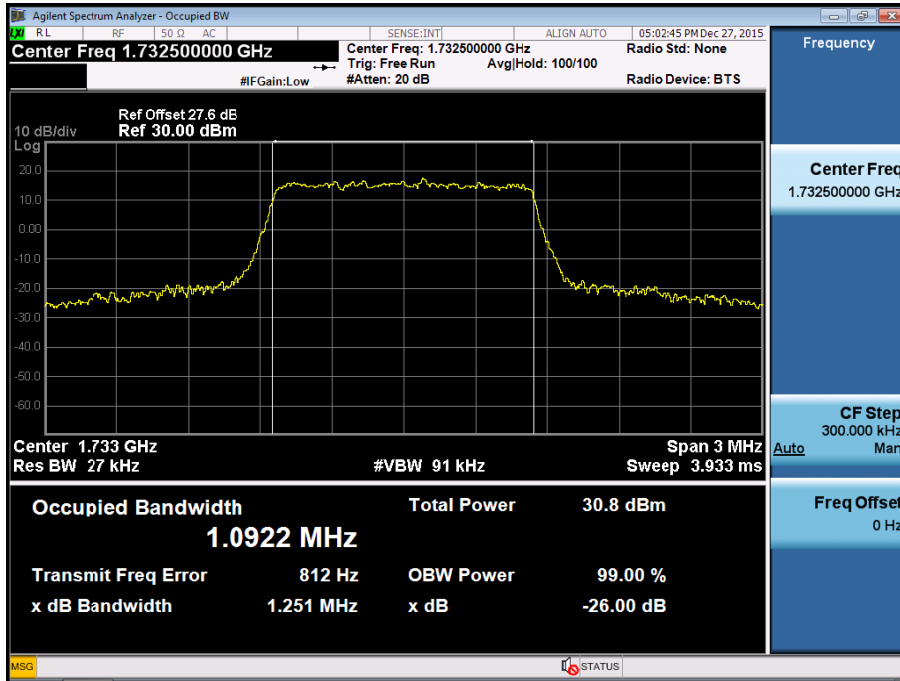

BAND 4. Occupied Bandwidth Plot (1.4M BW Ch.20175 16QAM RB 6)

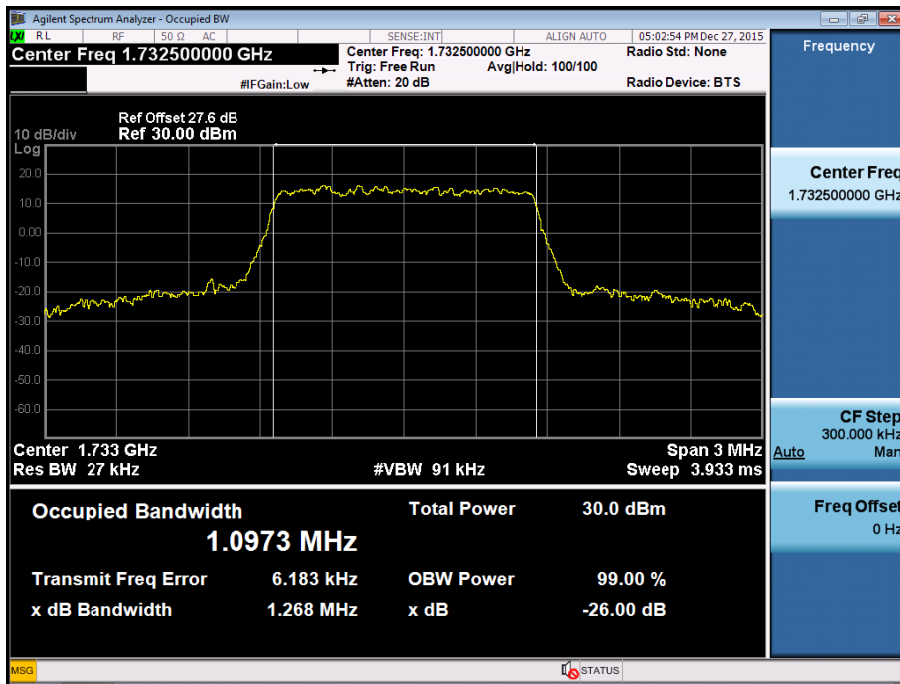

BAND 4. Occupied Bandwidth Plot (3M BW Ch.20175 QPSK RB 15)

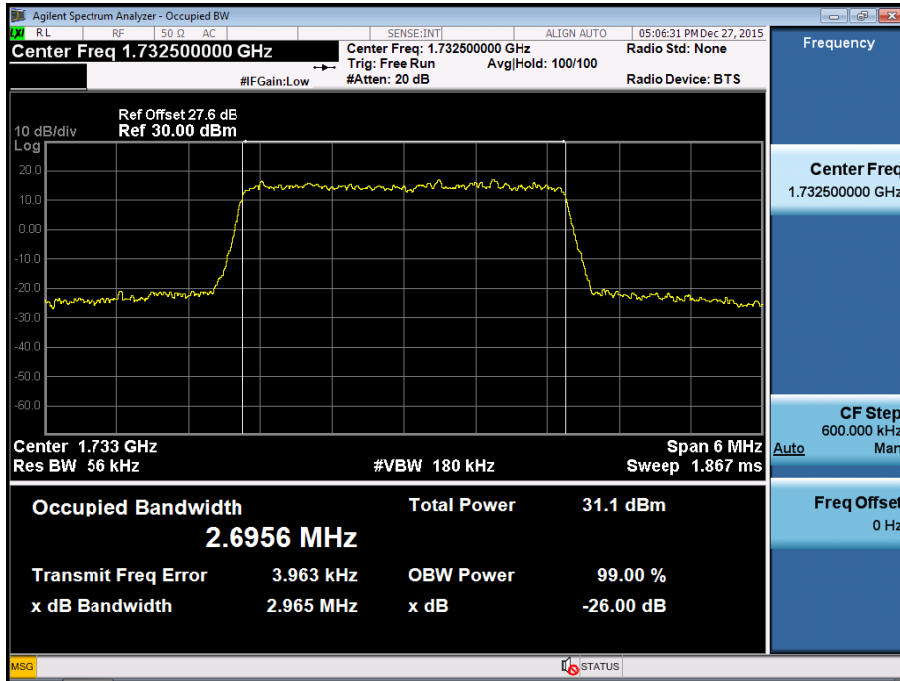

BAND 4. Occupied Bandwidth Plot (3M BW Ch.20175 16QAM RB 15)

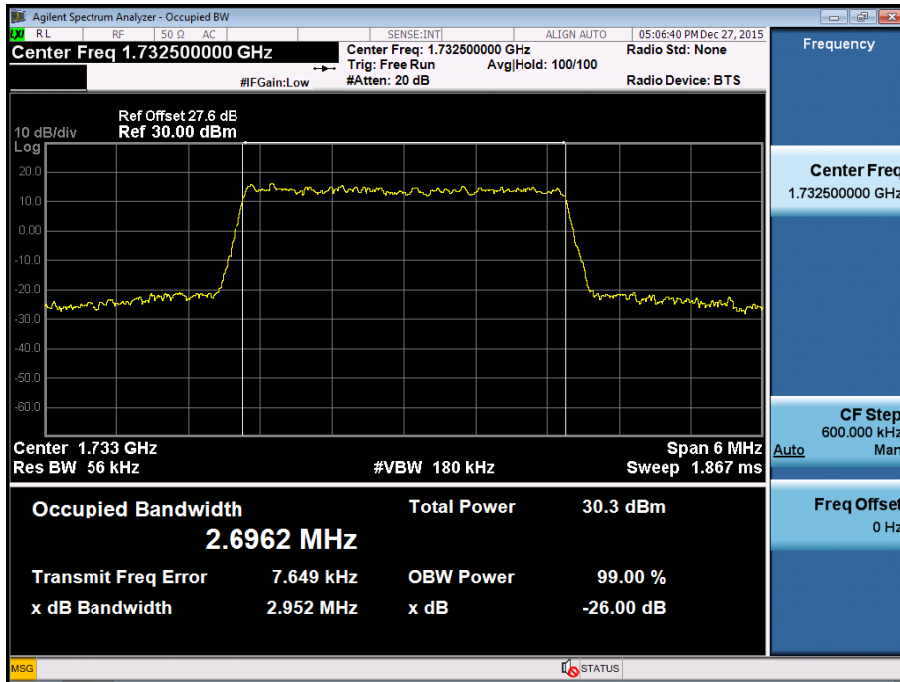

BAND 4. Occupied Bandwidth Plot (5M BW Ch.20175 QPSK RB 25)

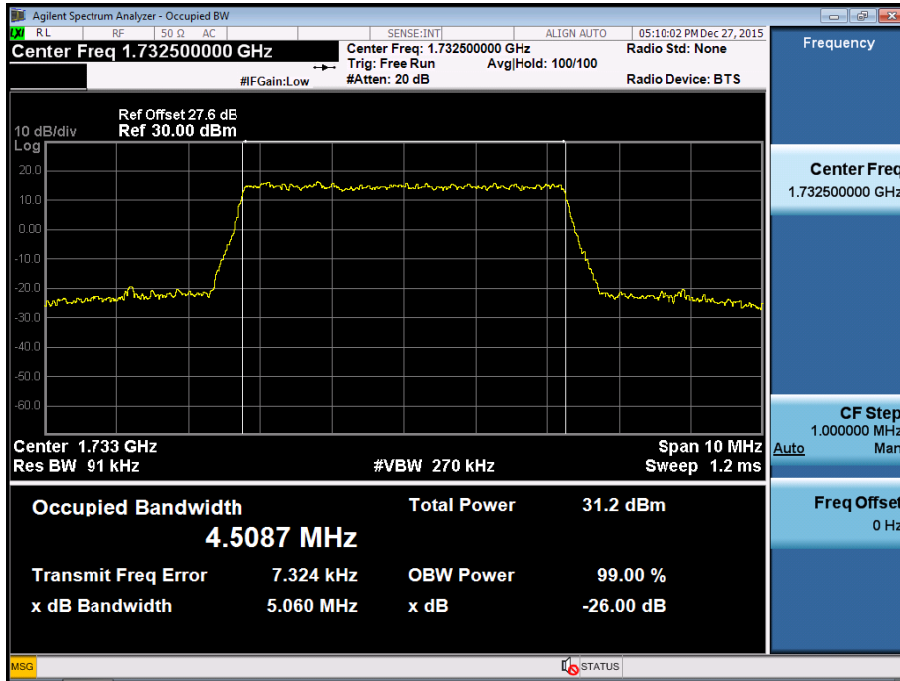

BAND 4. Occupied Bandwidth Plot (5M BW Ch.20175 16QAM RB 25)

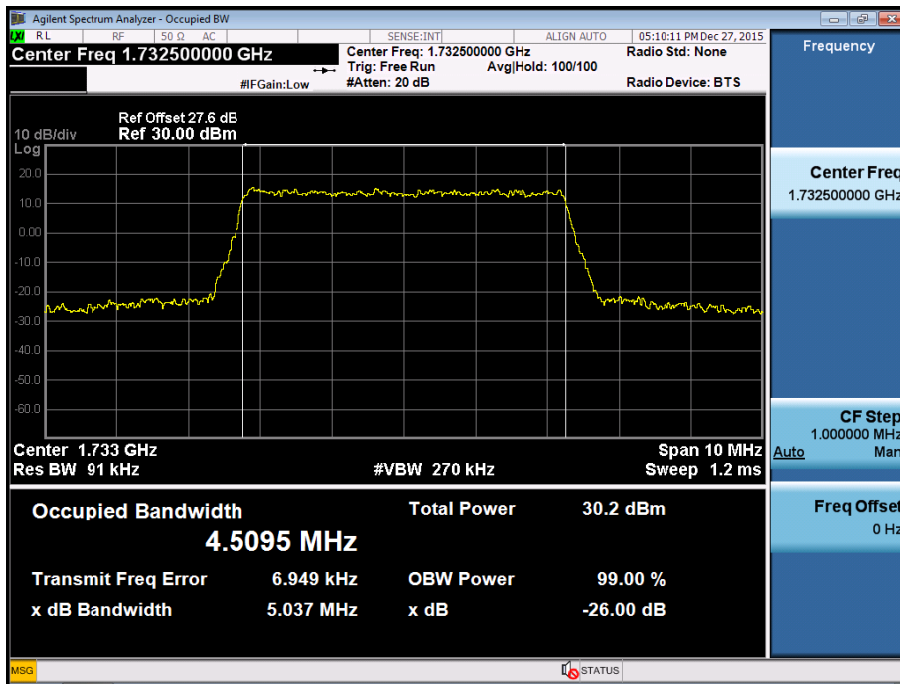

BAND 4. Occupied Bandwidth Plot (10M BW Ch.20175 QPSK RB 50)

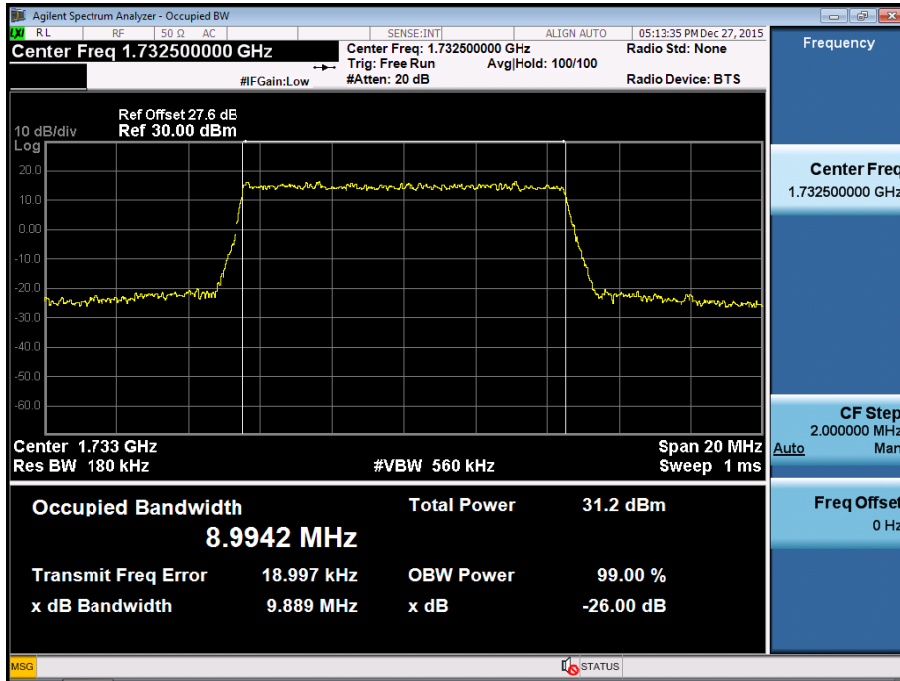

BAND 4. Occupied Bandwidth Plot (10M BW Ch.20175 16QAM RB 50)

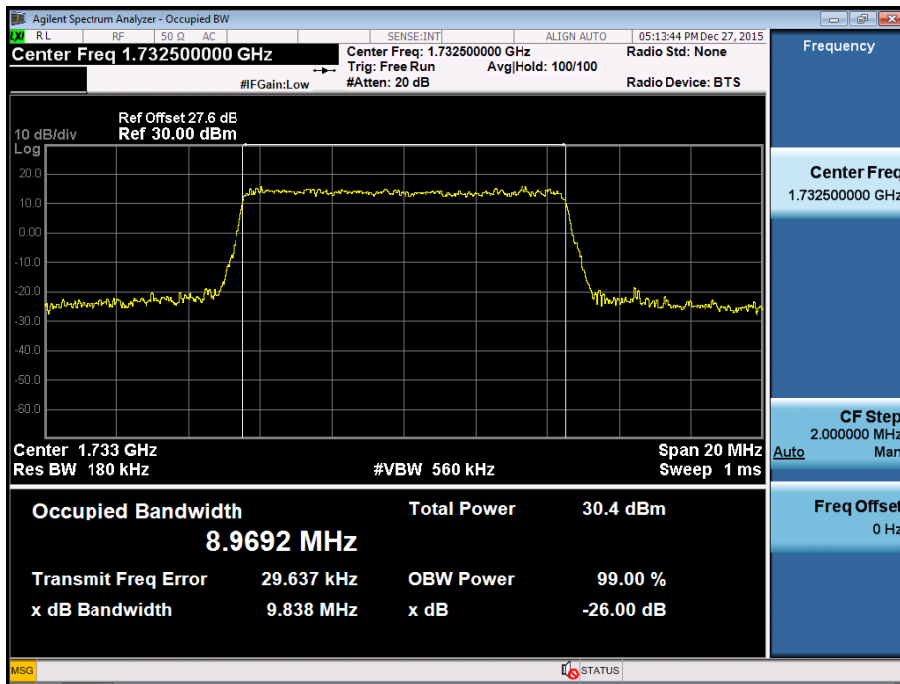

BAND 4. Occupied Bandwidth Plot (15M BW Ch.20175 QPSK RB 75)

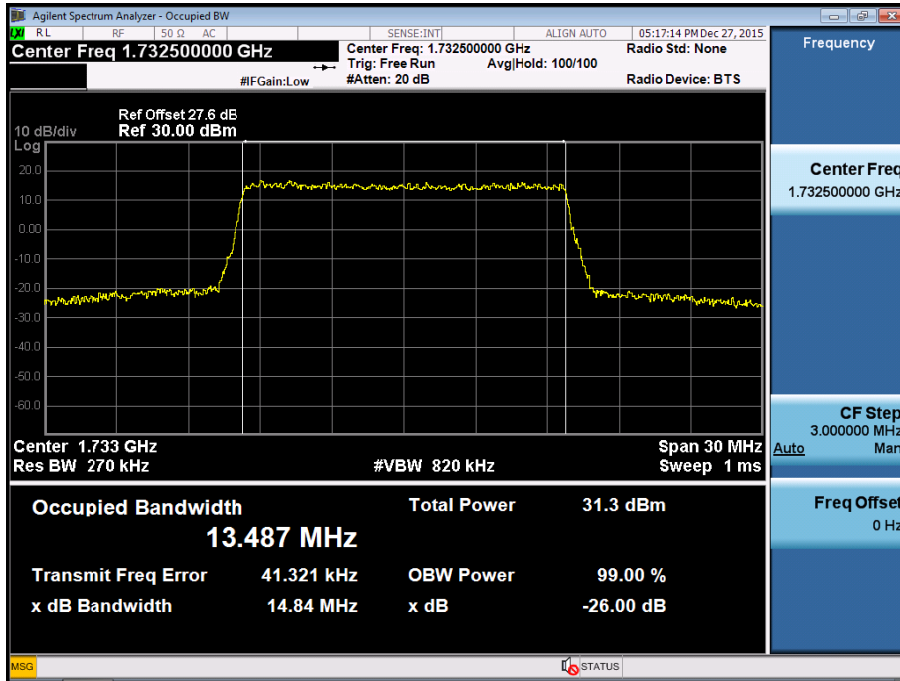

BAND 4. Occupied Bandwidth Plot (15M BW Ch.20175 16QAM RB 75)

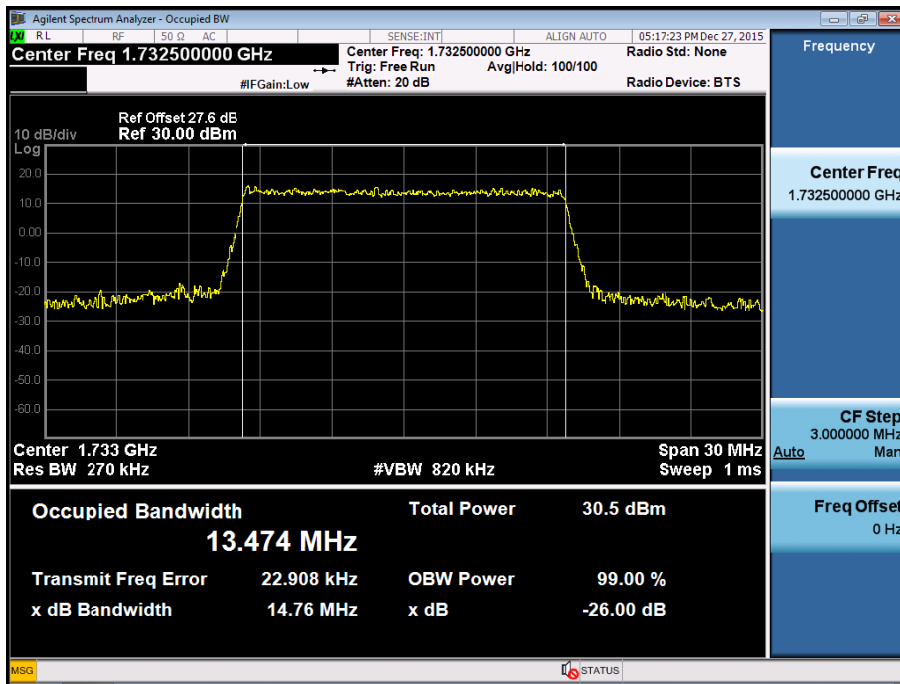



BAND 4. Occupied Bandwidth Plot (20M BW Ch.20175 QPSK RB 100)

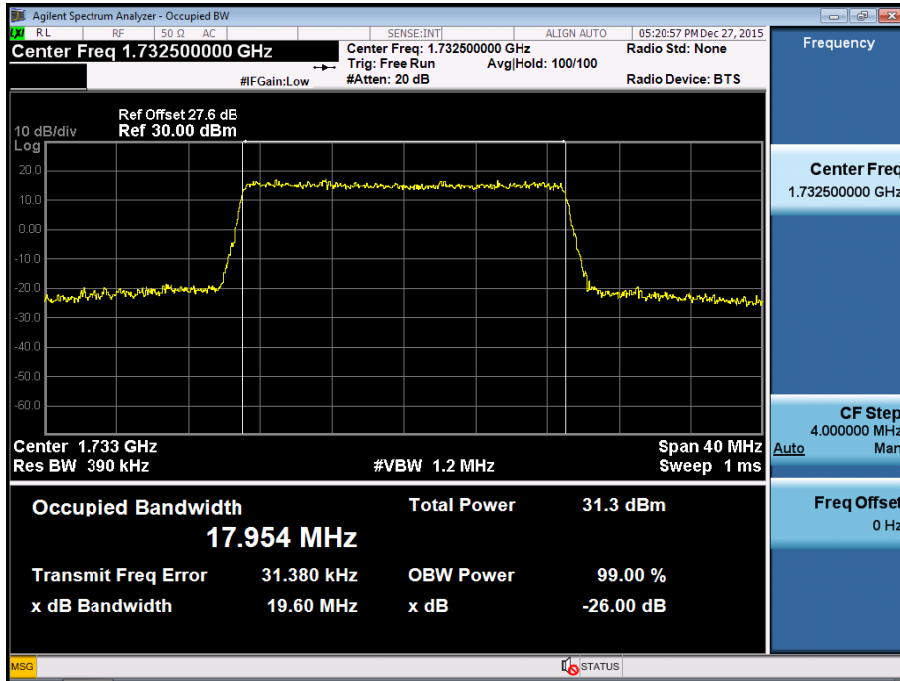

BAND 4. Occupied Bandwidth Plot (20M BW Ch.20175 16QAM RB 100)

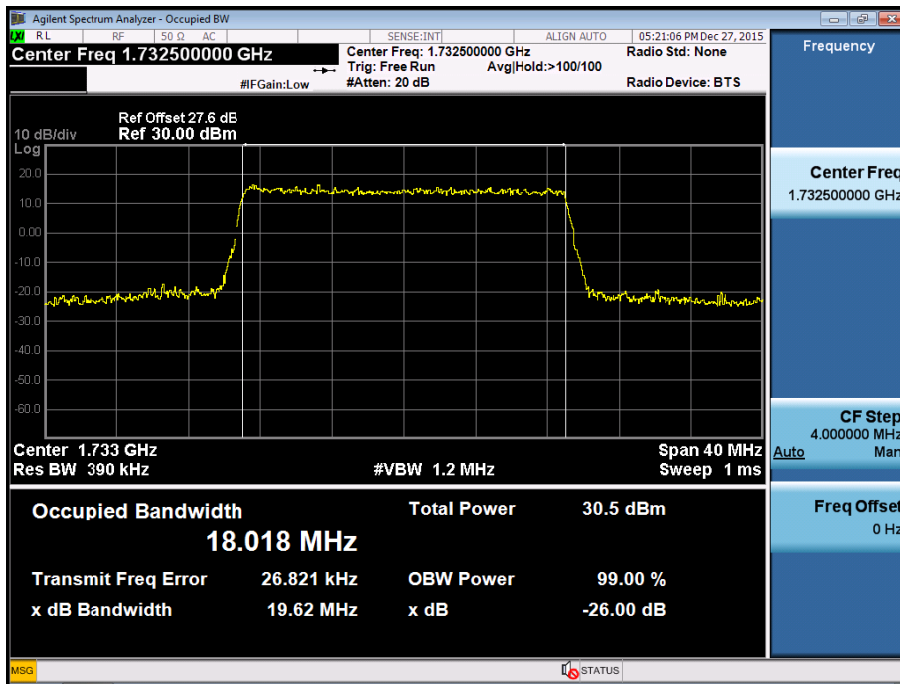

BAND 4. PAR Plot (1.4M BW\_Ch.20175\_QPSK\_RB6\_0)

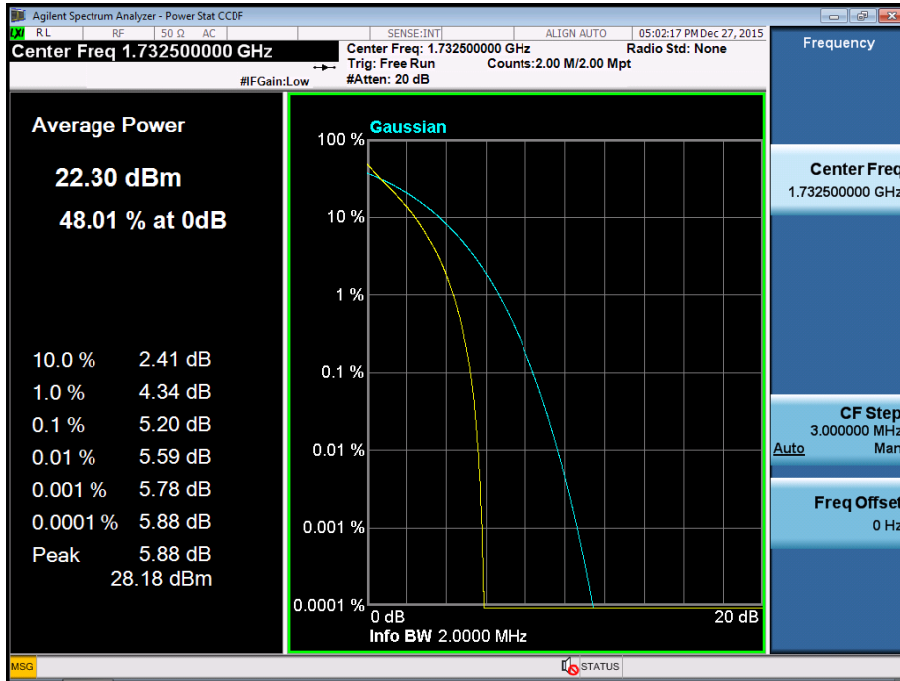

BAND 4. PAR Plot (1.4M BW\_Ch.20175\_16QAM\_RB6\_0)

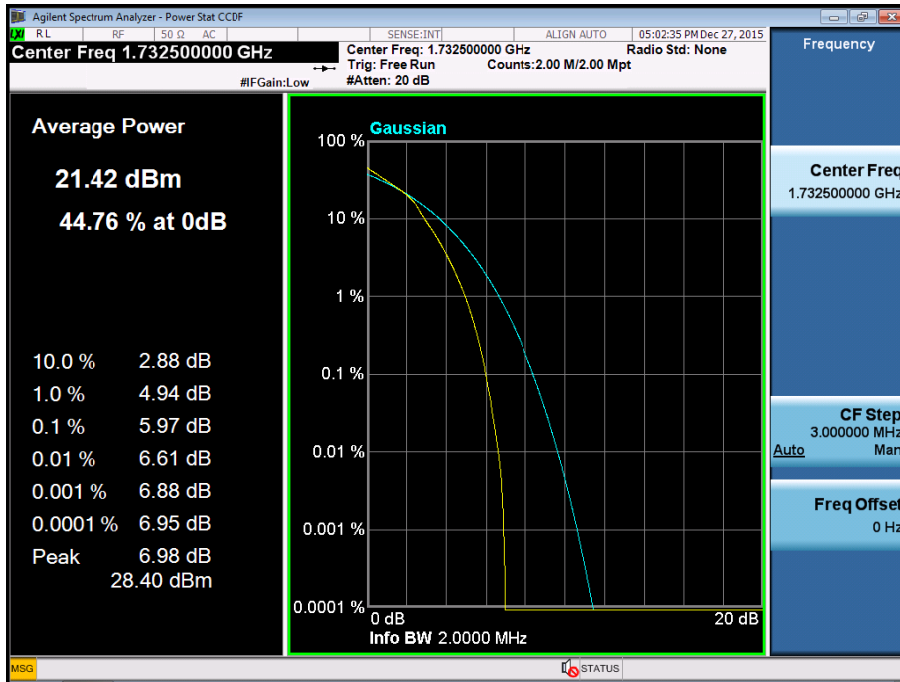

BAND 4. PAR Plot (3M BW\_Ch.20175\_QPSK\_RB15\_0)

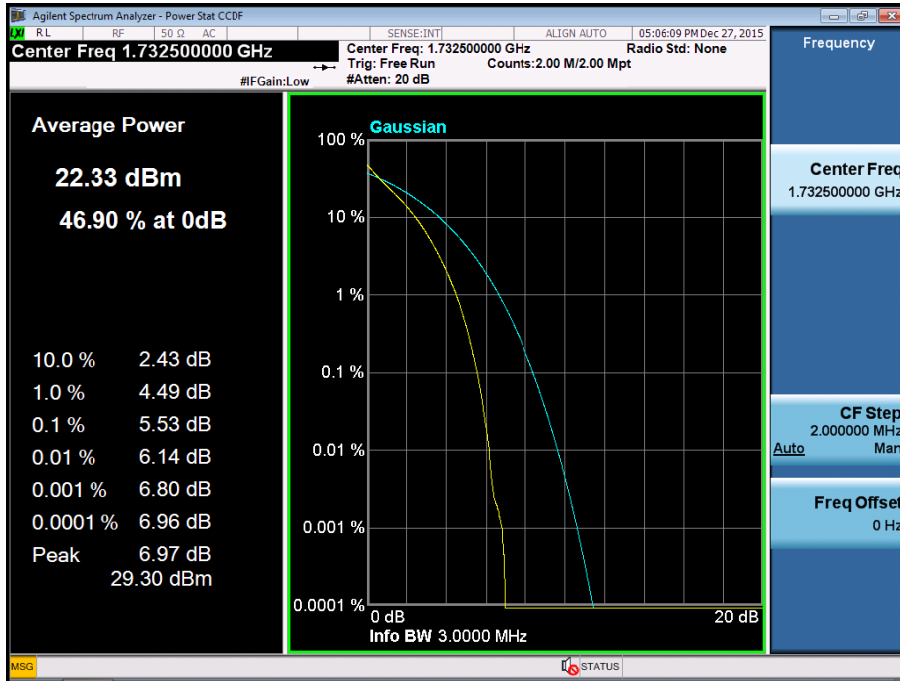

BAND 4. PAR Plot (3M BW\_Ch.20175\_16QAM\_RB15\_0)

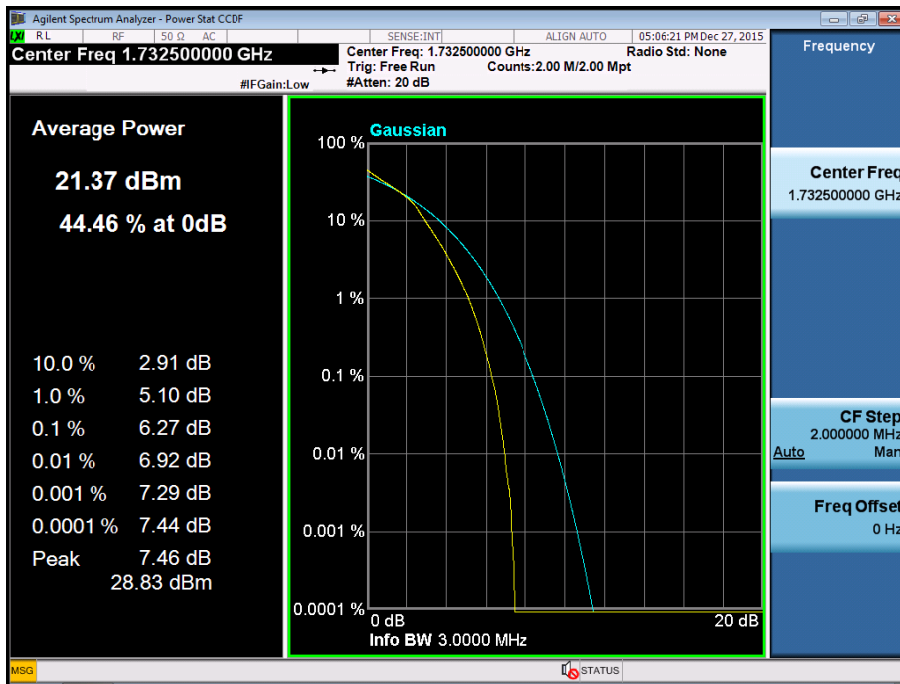

BAND 4. PAR Plot (5M BW\_Ch.20175\_QPSK\_RB25\_0)

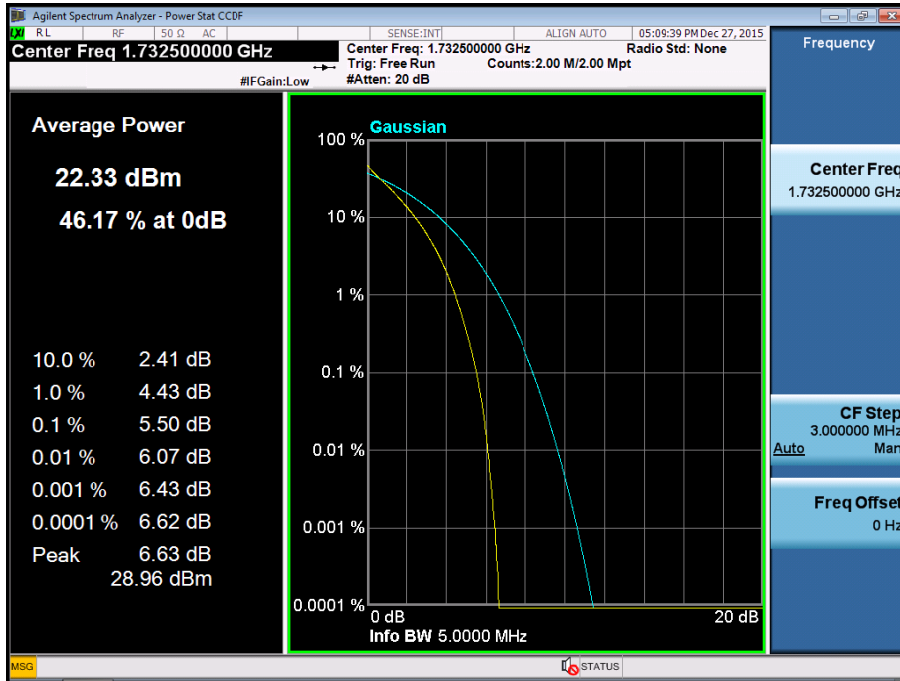

BAND 4. PAR Plot (5M BW\_Ch.20175\_16QAM\_RB25\_0)

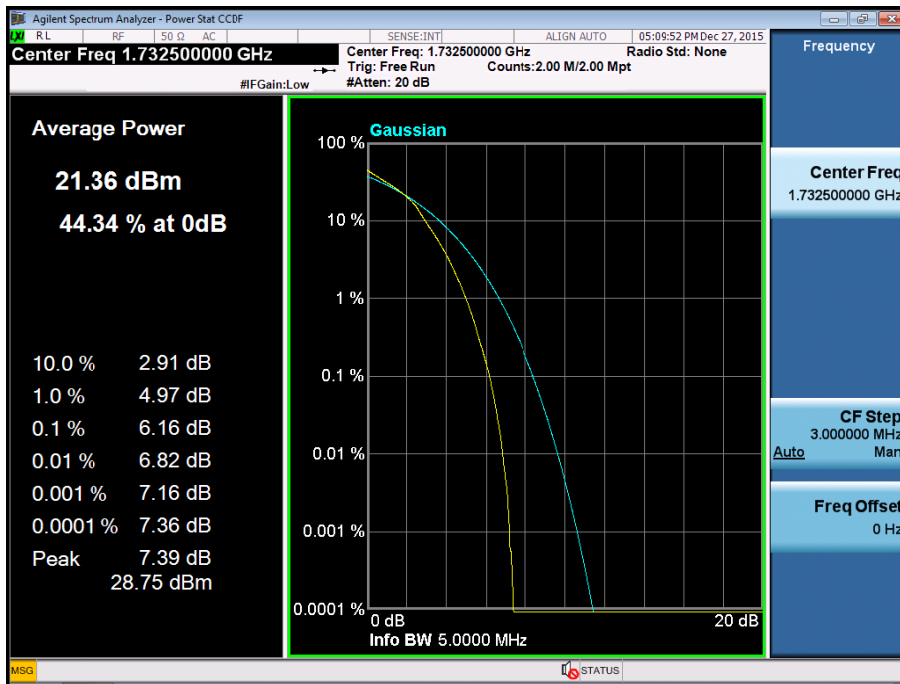

BAND 4. PAR Plot (10M BW\_Ch.20175\_QPSK\_RB50\_0)

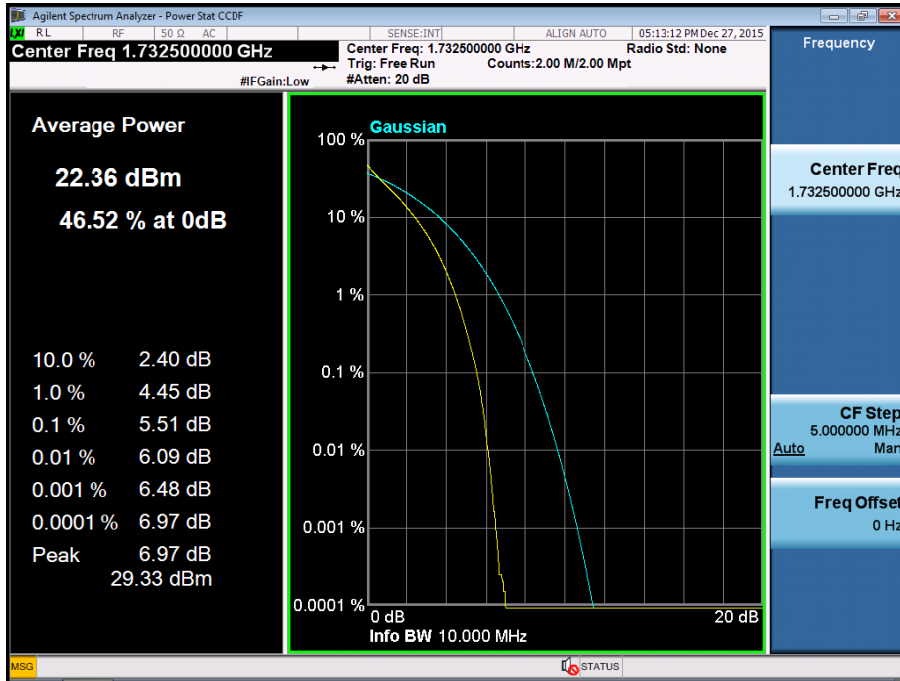

BAND 4. PAR Plot (10M BW\_Ch.20175\_16QAM\_RB50\_0)

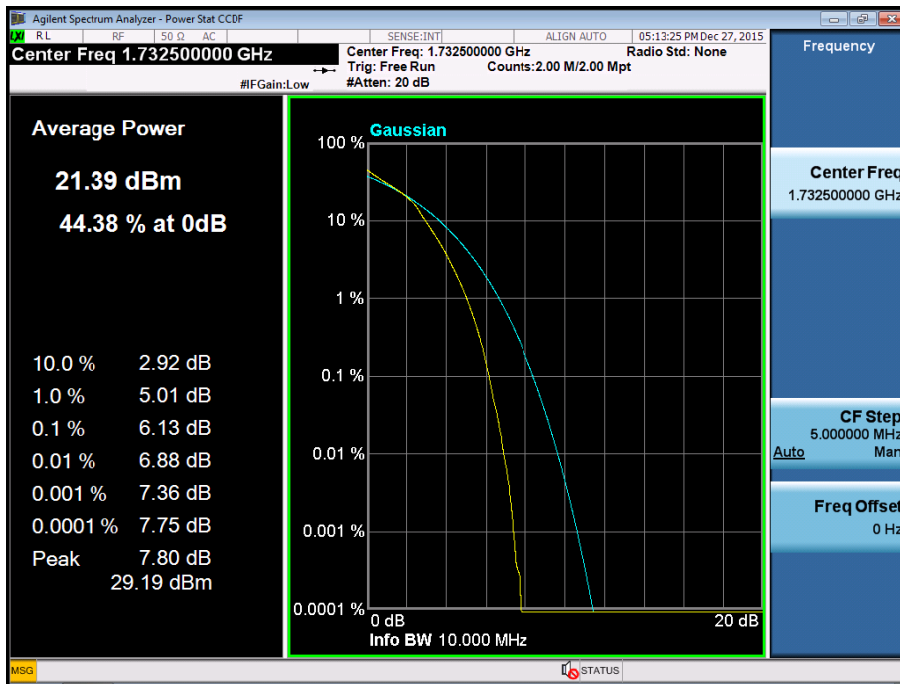

BAND 4. PAR Plot (15M BW\_Ch.20175\_QPSK\_RB75\_0)

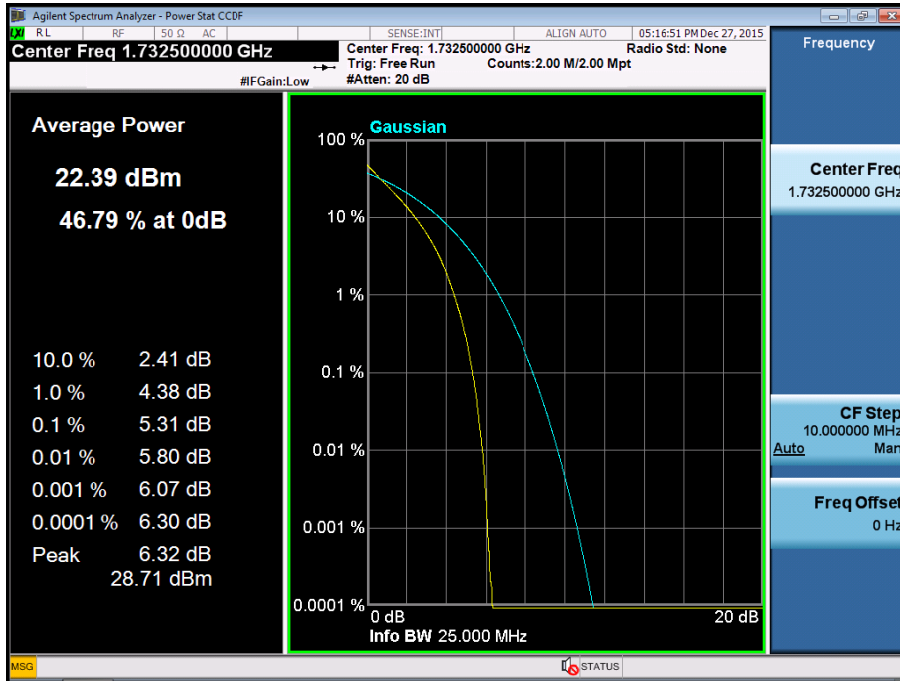

BAND 4. PAR Plot (15M BW\_Ch.20175\_16QAM\_RB75\_0)

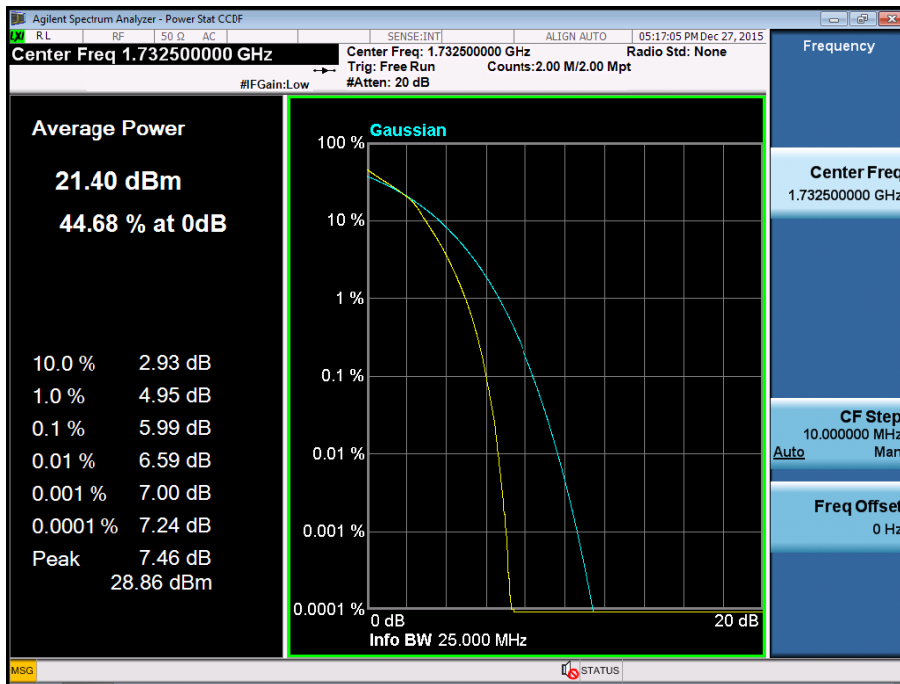

BAND 4. PAR Plot (20M BW\_Ch.20175\_QPSK\_RB100\_0)

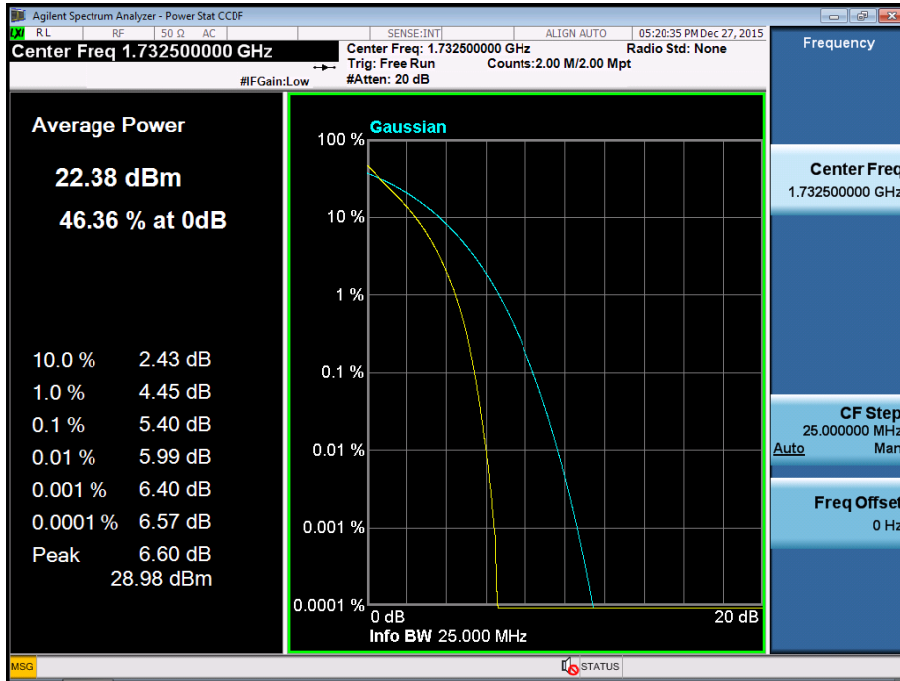

BAND 4. PAR Plot (20M BW\_Ch.20175\_16QAM\_RB100\_0)

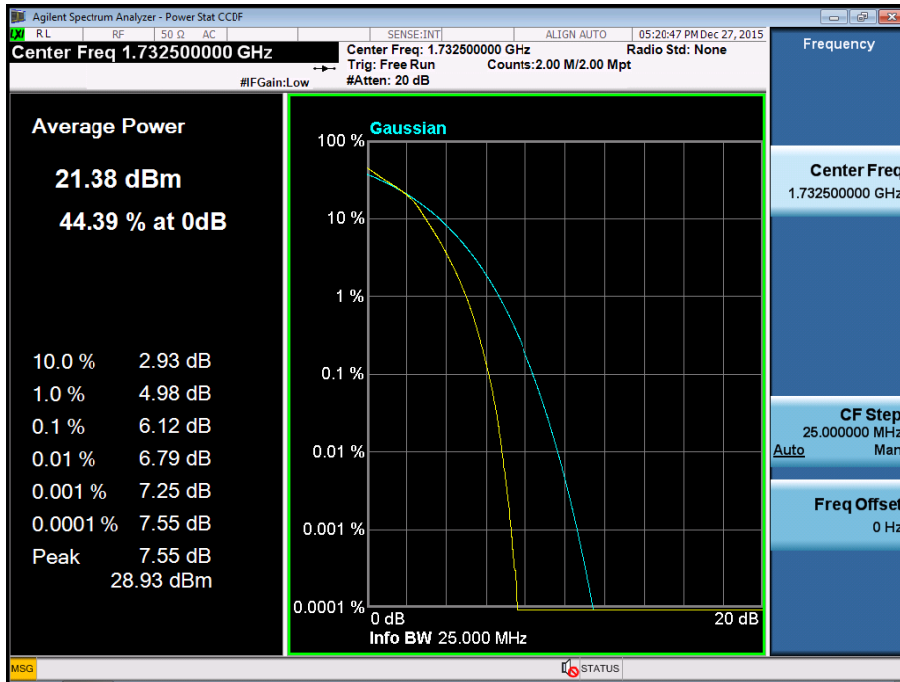

BAND 4. Lower Band Edge Plot (1.4M BW Ch.19957 QPSK RB 1, Offset 0) -1

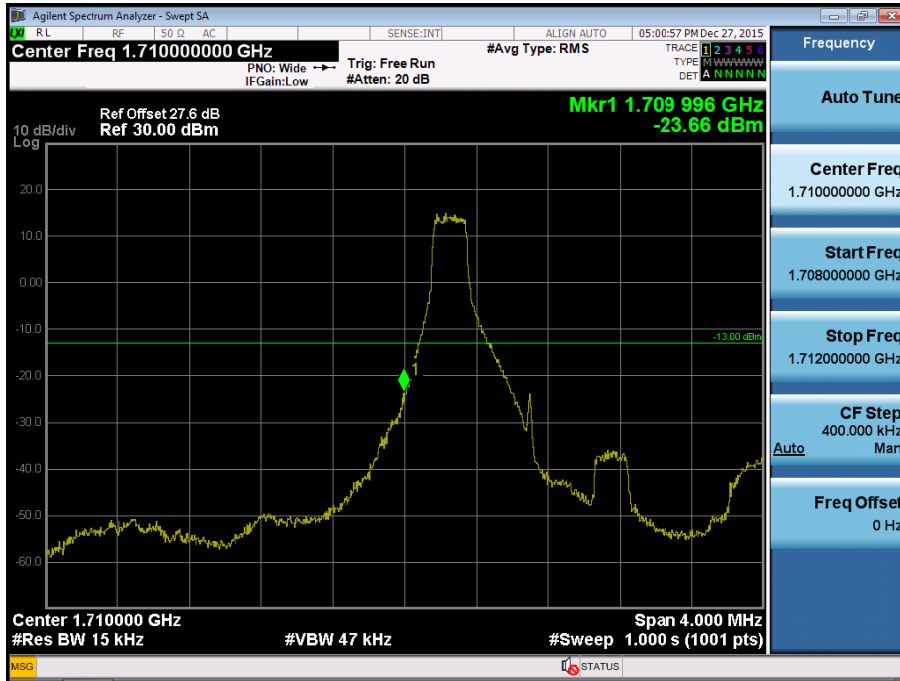

BAND 4. Lower Band Edge Plot (1.4M BW Ch.19957 QPSK RB 6) -2

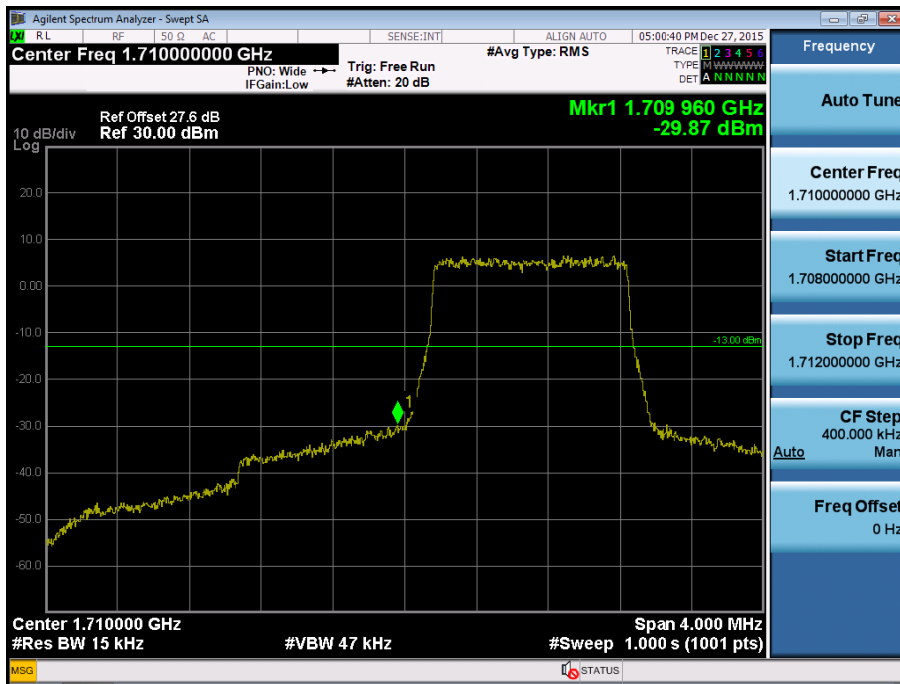



BAND 4. Lower Extended Band Edge Plot (1.4M BW Ch.19957 QPSK\_RB6\_0) -3

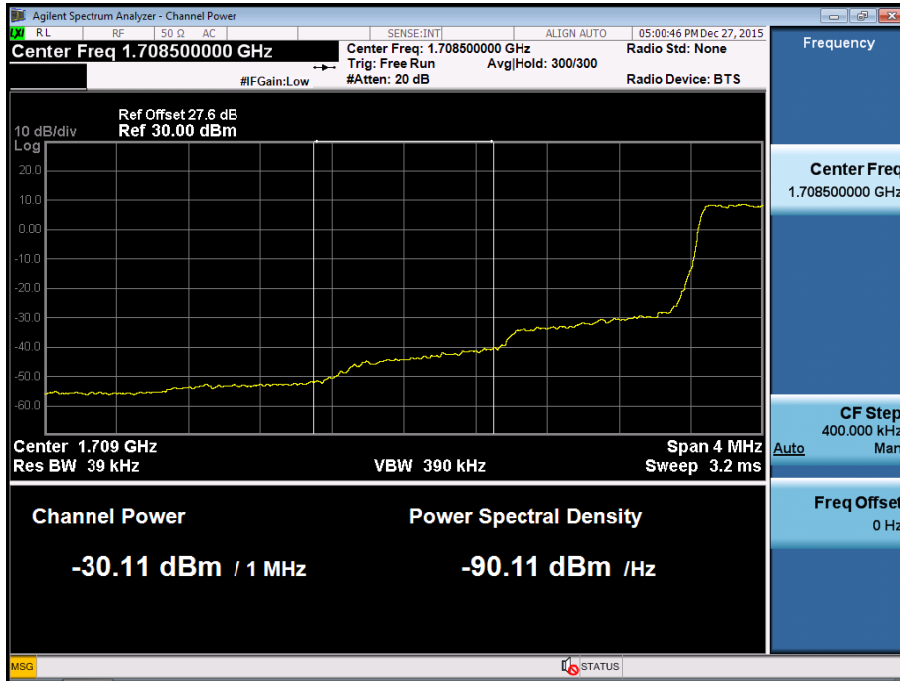

BAND 4. Lower Band Edge Plot (3M BW Ch.19965 QPSK RB 1, Offset 0) -1

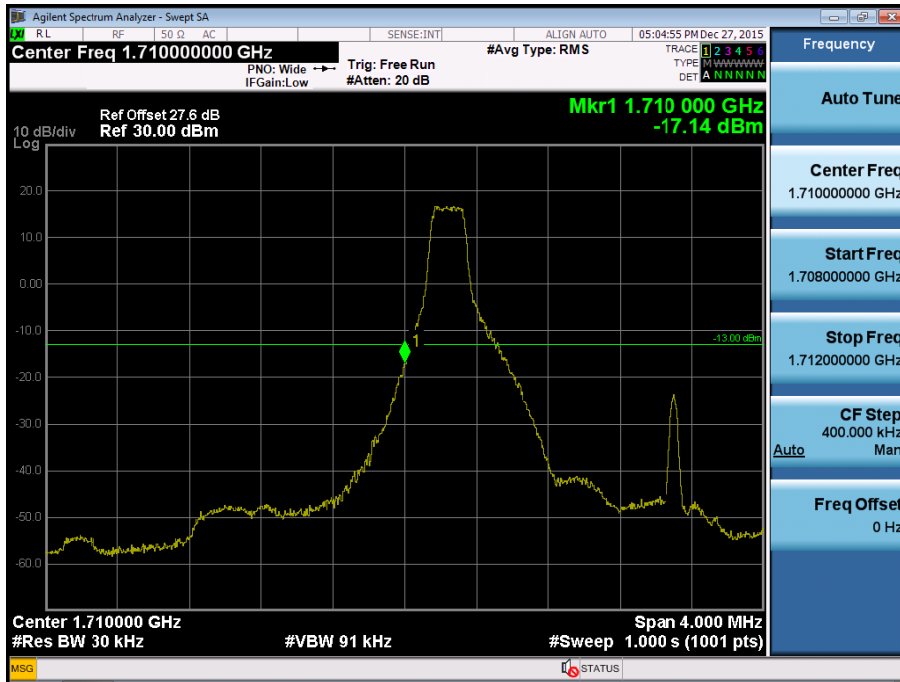

BAND 4. Lower Band Edge Plot (3M BW Ch.19965 QPSK RB 15) -2

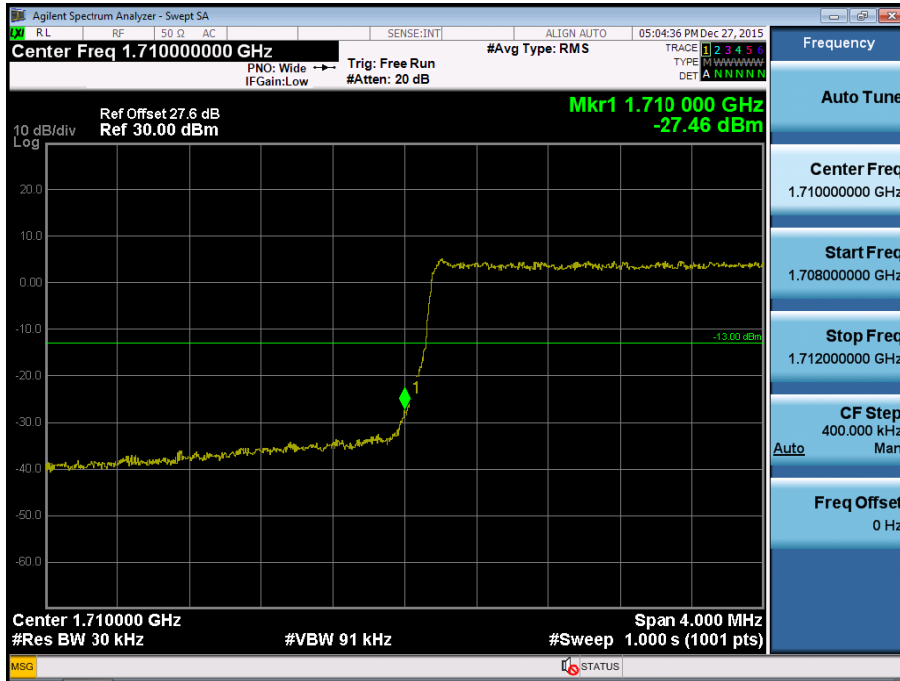

BAND 4. Lower Extended Band Edge Plot (3M BW Ch.19965 QPSK\_RB15\_0) -3

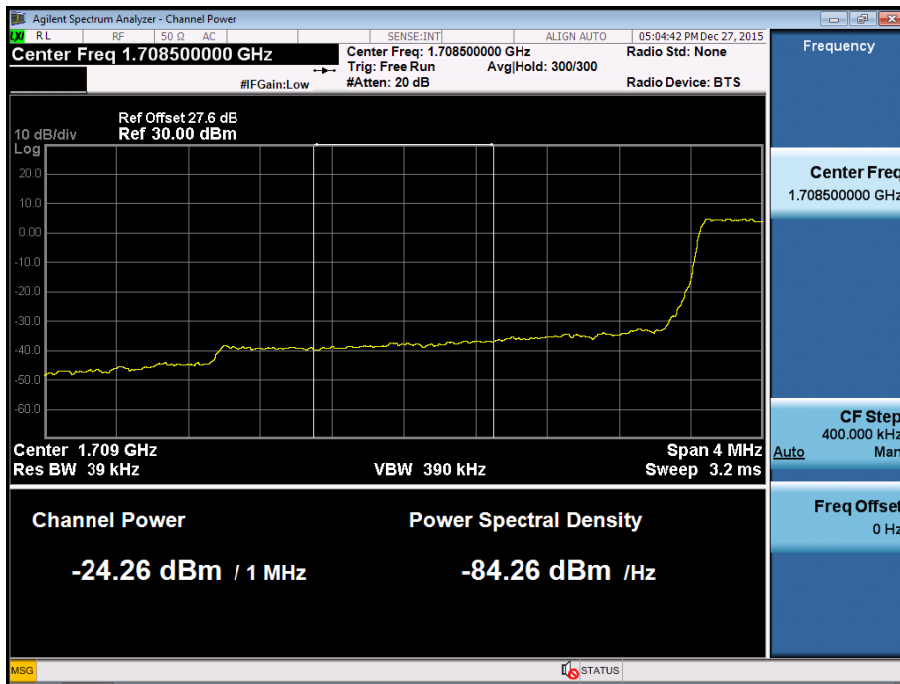

BAND 4. Lower Band Edge Plot (5M BW Ch.19975 QPSK RB 1, Offset 0) -1

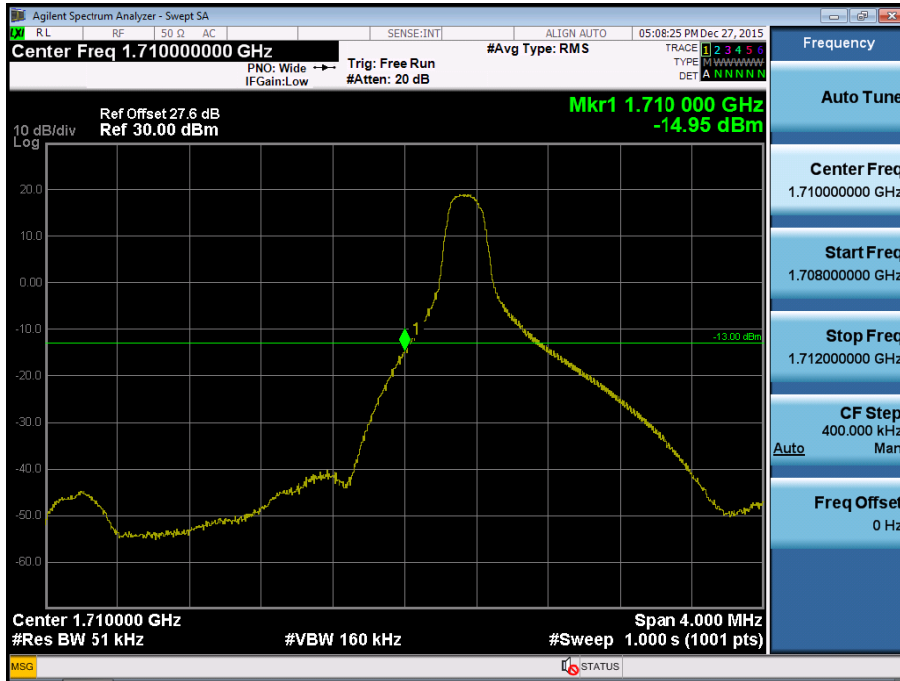

BAND 4. Lower Band Edge Plot (5M BW Ch.19975 QPSK RB 25) -2

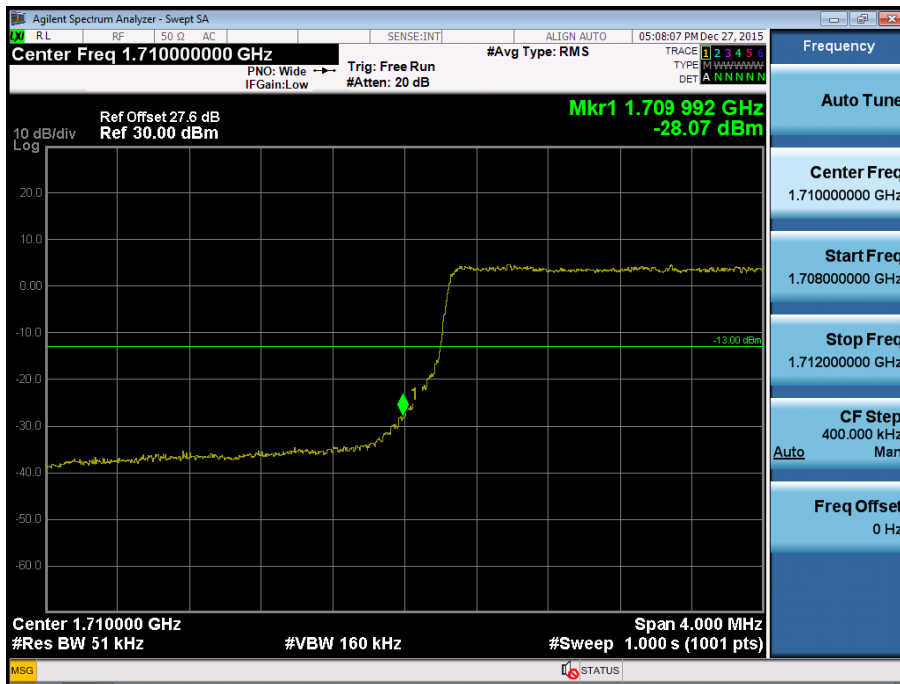

BAND 4. Lower Extended Band Edge Plot (5M BW Ch.19975 QPSK\_RB25\_0) -3

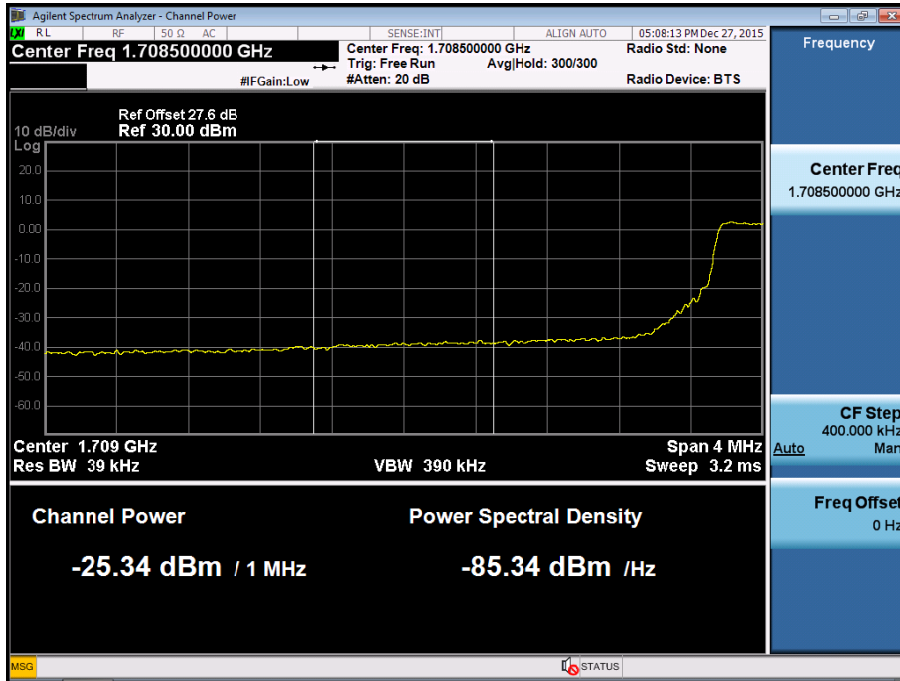

BAND 4. Lower Band Edge Plot (10M BW Ch.20000 QPSK RB 1, Offset 0) -1

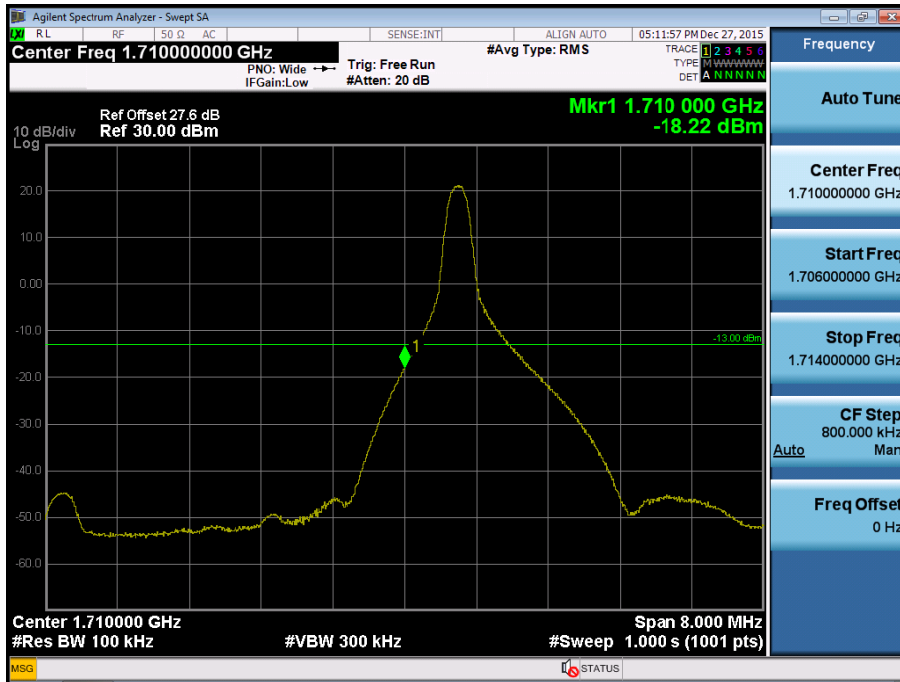

BAND 4. Lower Band Edge Plot (10M BW Ch.20000 QPSK RB 50) -2

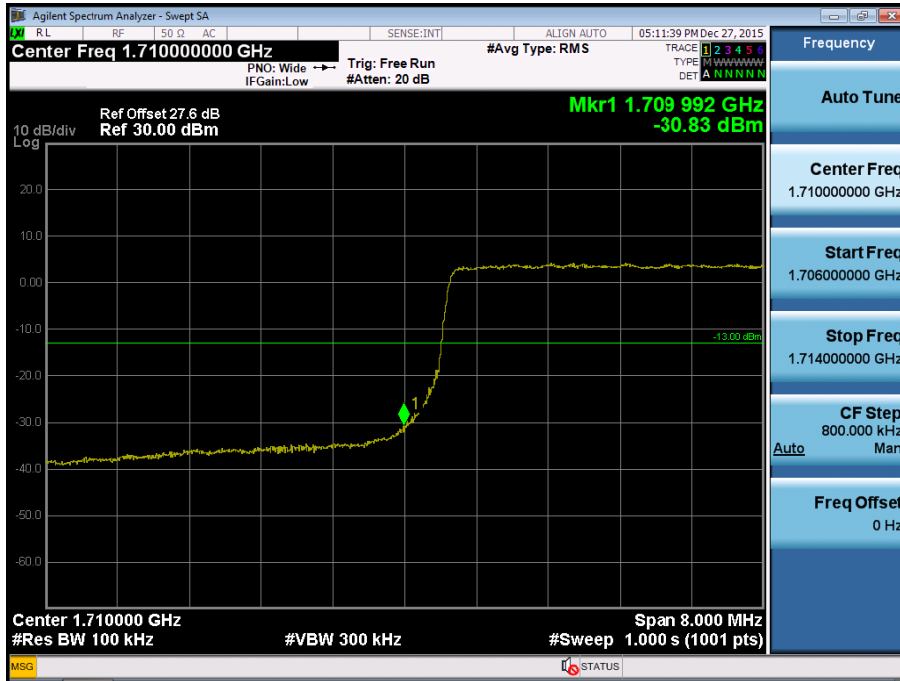

BAND 4. Lower Extended Band Edge Plot (10M BW Ch.20000 QPSK\_RB50\_0) -3

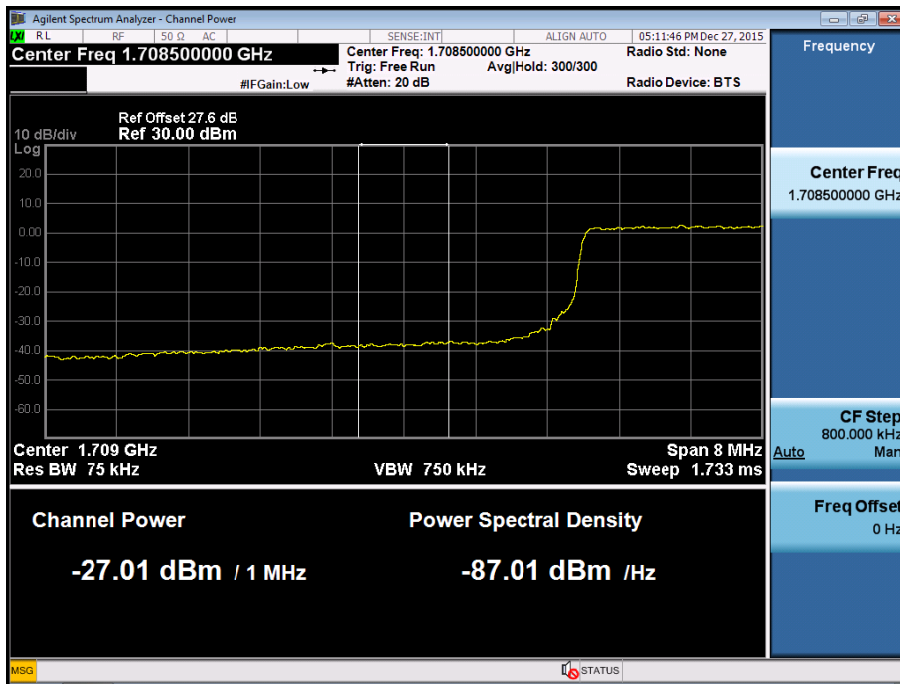

BAND 4. Lower Band Edge Plot (15M BW Ch.20025 QPSK RB 1, Offset 0) -1

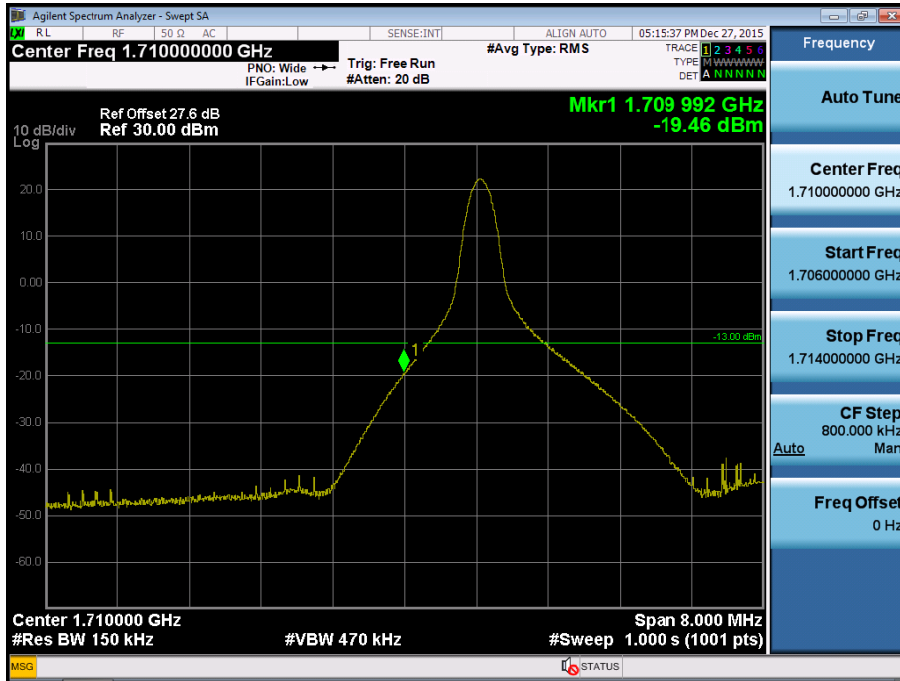

BAND 4. Lower Band Edge Plot (15M BW Ch.20025 QPSK RB 75) -2

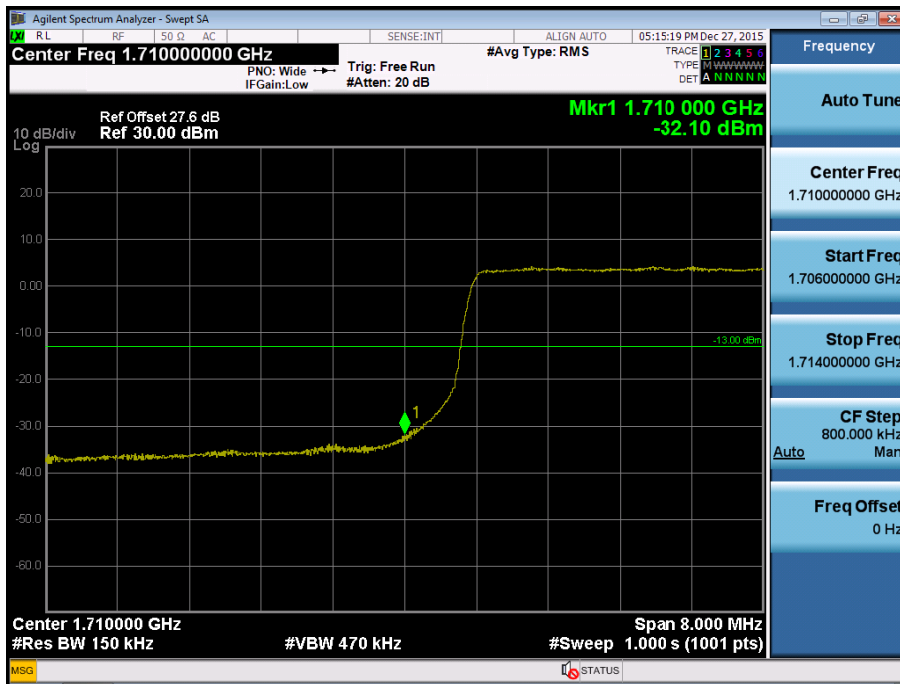

BAND 4. Lower Extended Band Edge Plot (15M BW Ch.20025 QPSK\_RB75\_0) -3

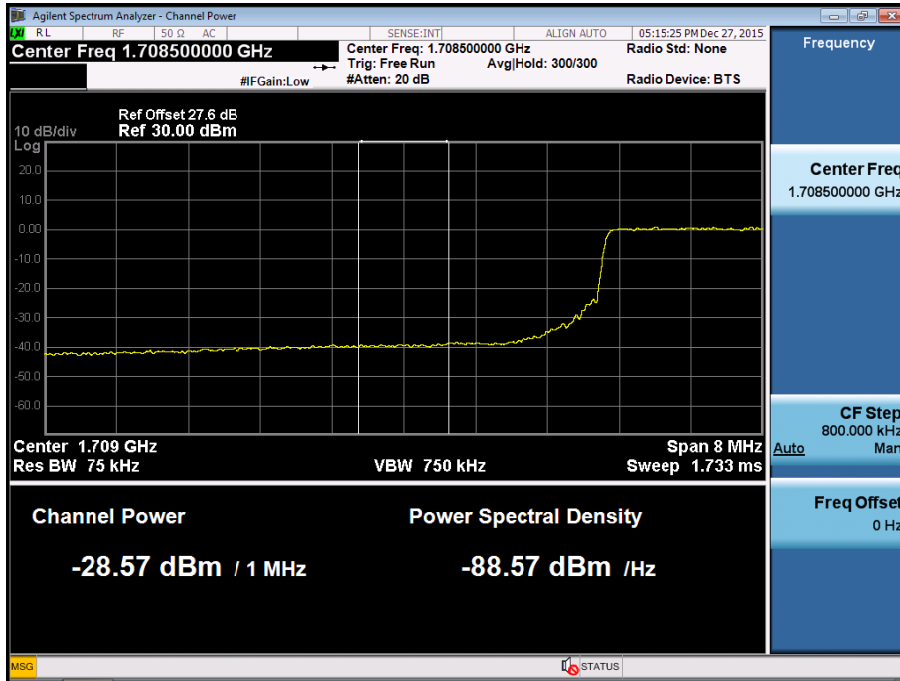

BAND 4. Lower Band Edge Plot (20M BW Ch.20050 QPSK RB 1, Offset 0) -1

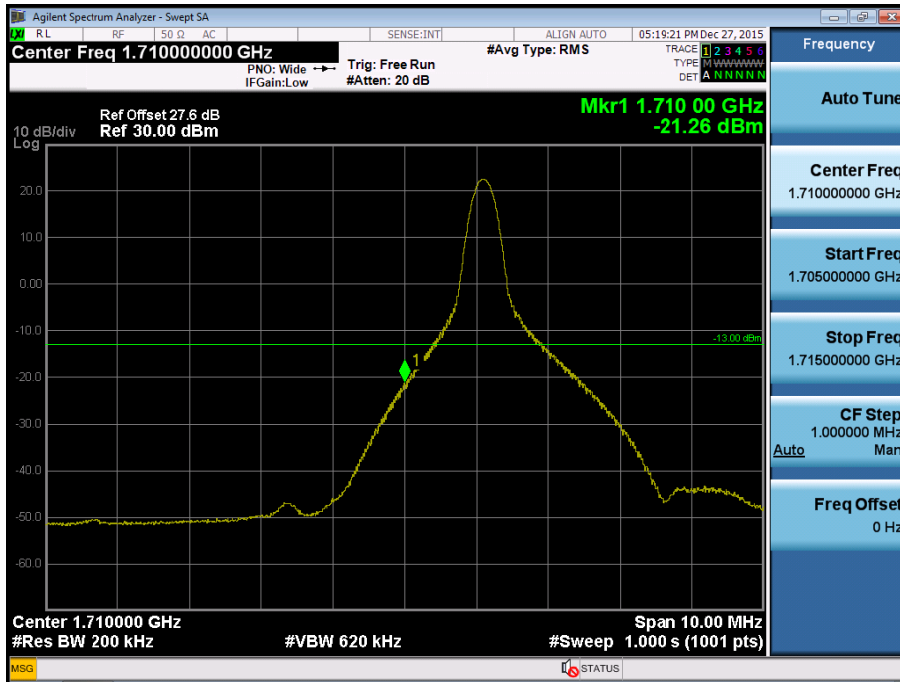

BAND 4. Lower Band Edge Plot (20M BW Ch.20050 QPSK RB 100) -2



BAND 4. Lower Extended Band Edge Plot (20M BW Ch.20050 QPSK\_RB100\_0) -3

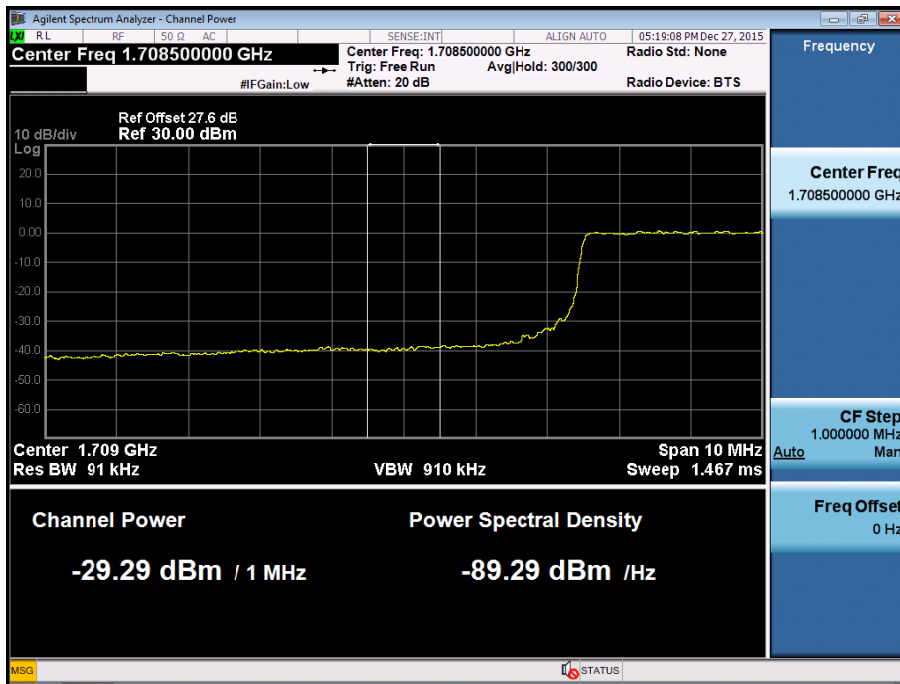



BAND 4. Upper Band Edge Plot (1.4M BW Ch.20393 QPSK\_RB1\_Offset 5) -1

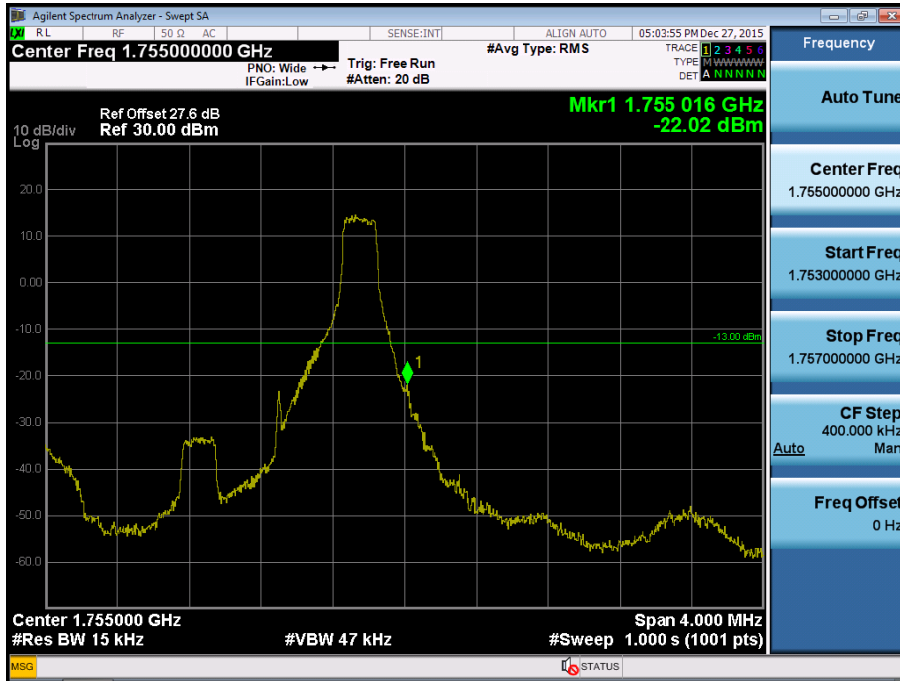

BAND 4. Upper Band Edge Plot (1.4M BW Ch.20393 QPSK\_RB6) -2



BAND 4. Upper Extended Band Edge Plot (1.4M BW Ch. 20393 QPSK\_RB6\_0) -3

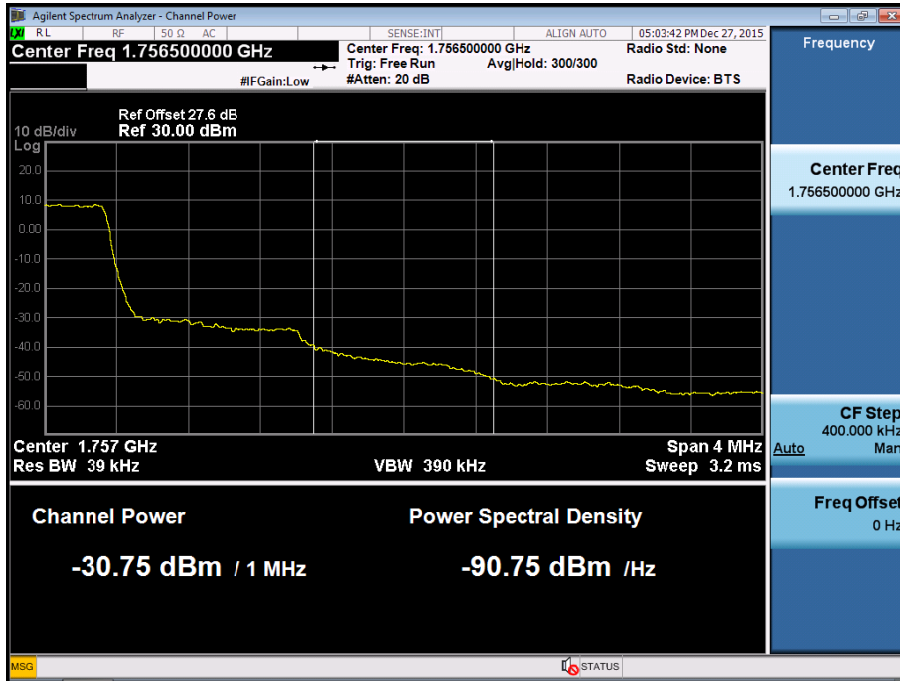

BAND 4. Upper Band Edge Plot (3M BW Ch.20385 QPSK\_RB1\_Offset 14) -1

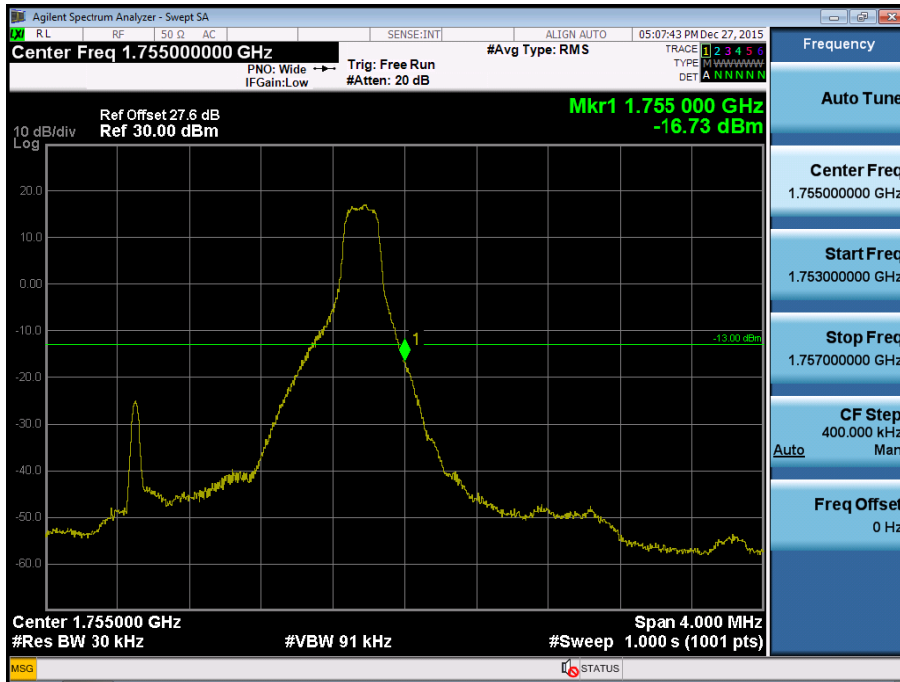

BAND 4. Upper Band Edge Plot (3M BW Ch.20385 QPSK\_RB15) -2



BAND 4. Upper Extended Band Edge Plot (3M BW Ch.20385 QPSK\_RB15\_0) -3

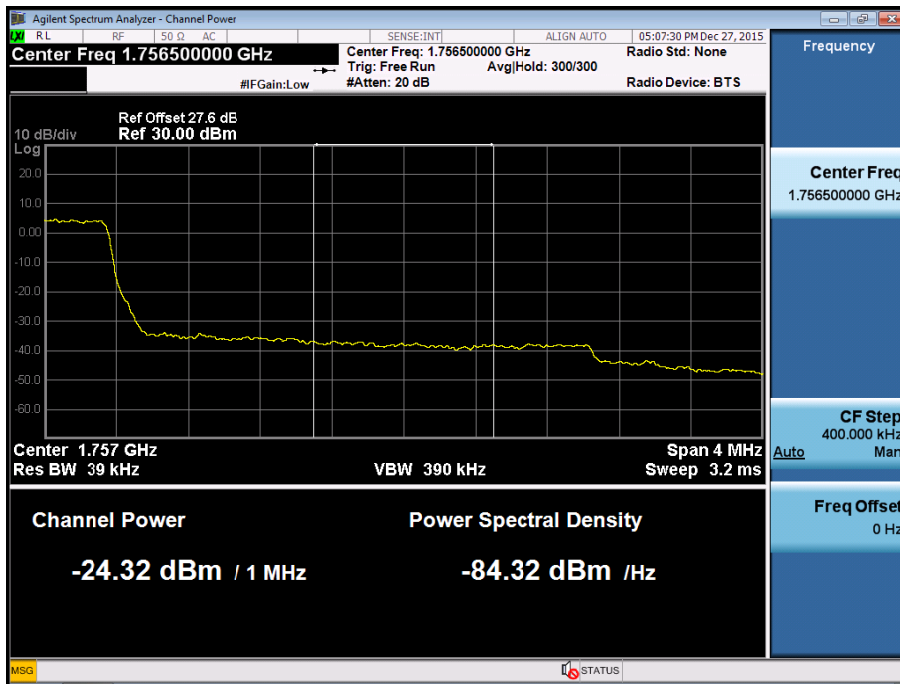

BAND 4. Upper Band Edge Plot (5M BW Ch.20375 QPSK\_RB1\_Offset 24) -1



BAND 4. Upper Band Edge Plot (5M BW Ch.20375 QPSK\_RB25) -2



BAND 4. Upper Extended Band Edge Plot (5M BW Ch.20375 QPSK\_RB25) -3

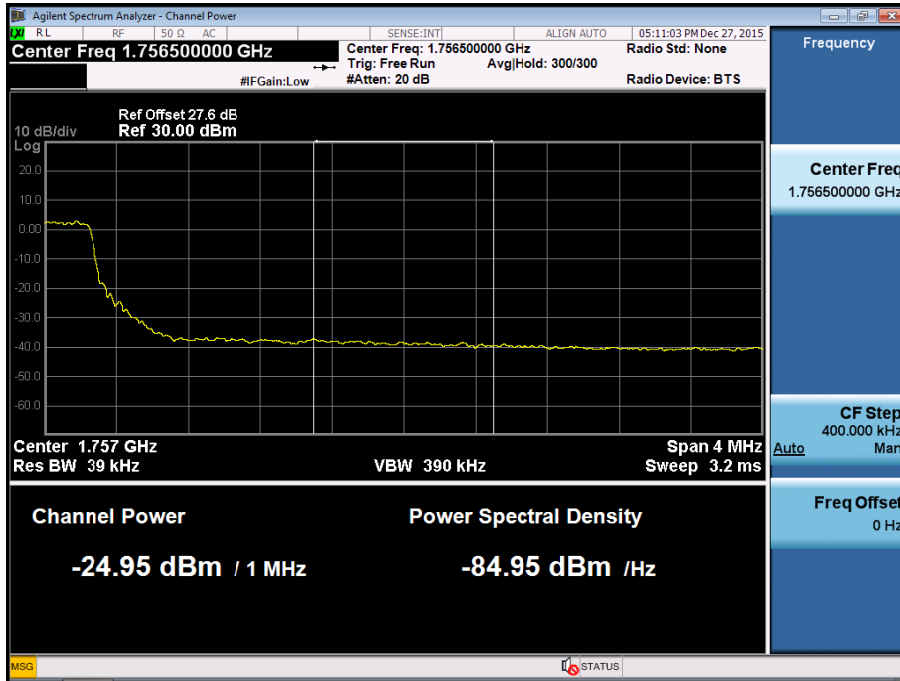

BAND 4. Upper Band Edge Plot (10M BW Ch.20350 QPSK\_RB1\_Offset 49) -1

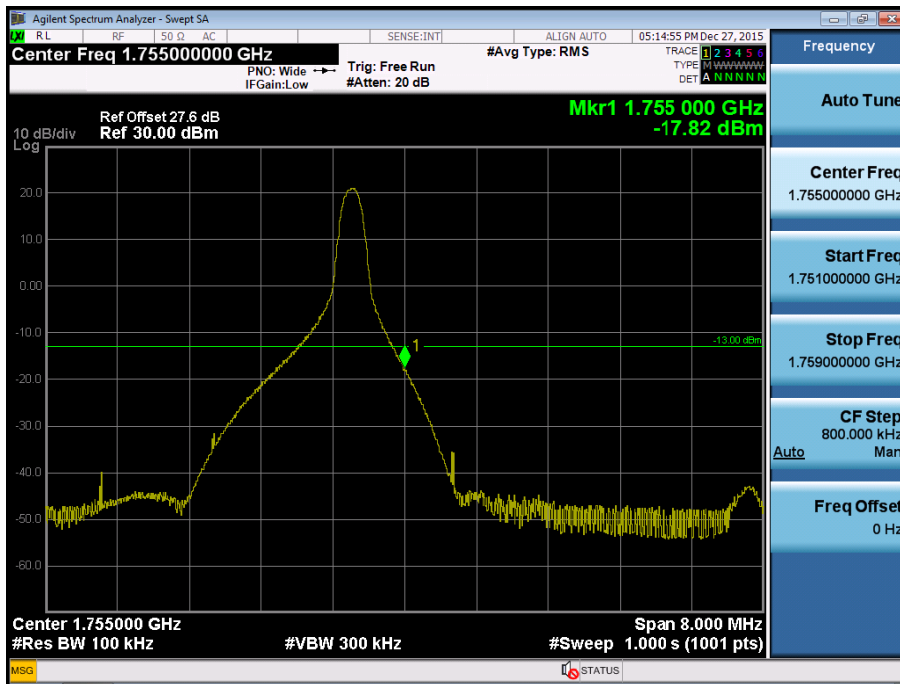

BAND 4. Upper Band Edge Plot (10M BW Ch.20350 QPSK\_RB50) -2



BAND 4. Upper Extended Band Edge Plot (10M BW Ch.20350 QPSK\_RB50) -3

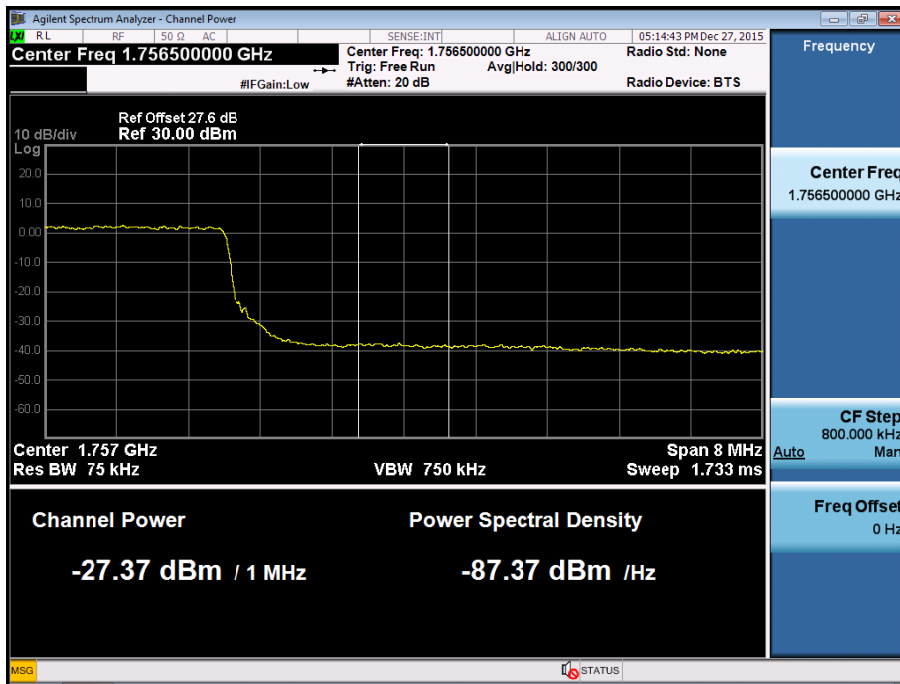

BAND 4. Upper Band Edge Plot (15M BW Ch.20325 QPSK\_RB1\_Offset 74) -1

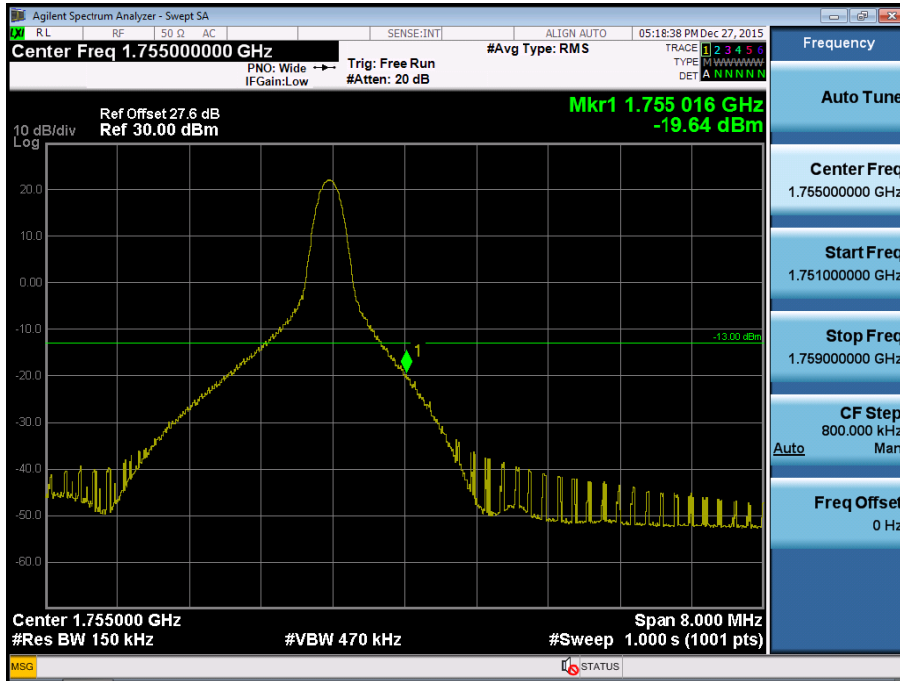

BAND 4. Upper Band Edge Plot (15M BW Ch.20325 QPSK\_RB75) -2

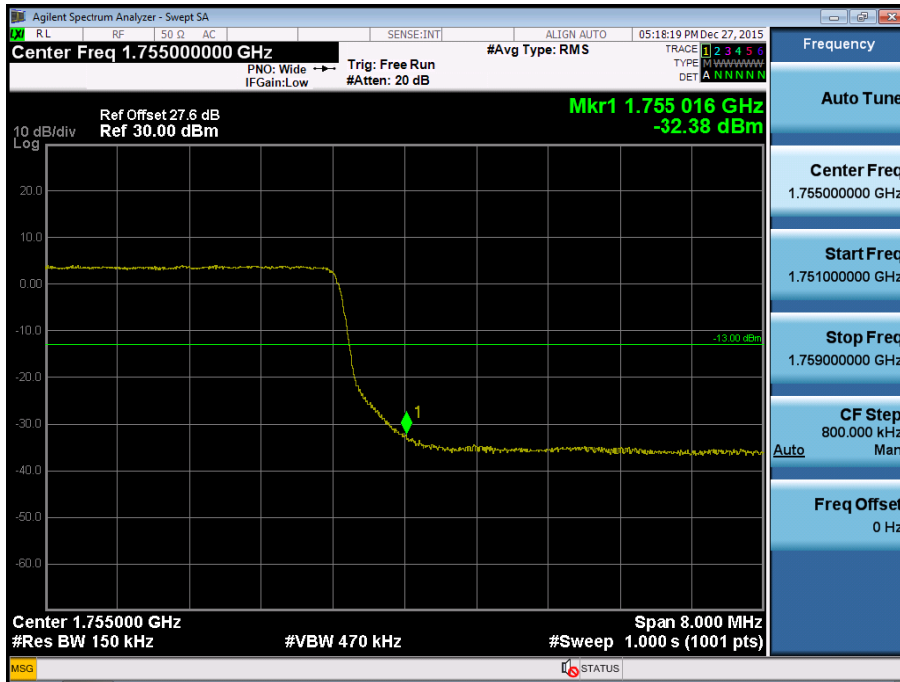

BAND 4. Upper Extended Band Edge Plot (15M BW Ch.20325 QPSK\_RB75) -3

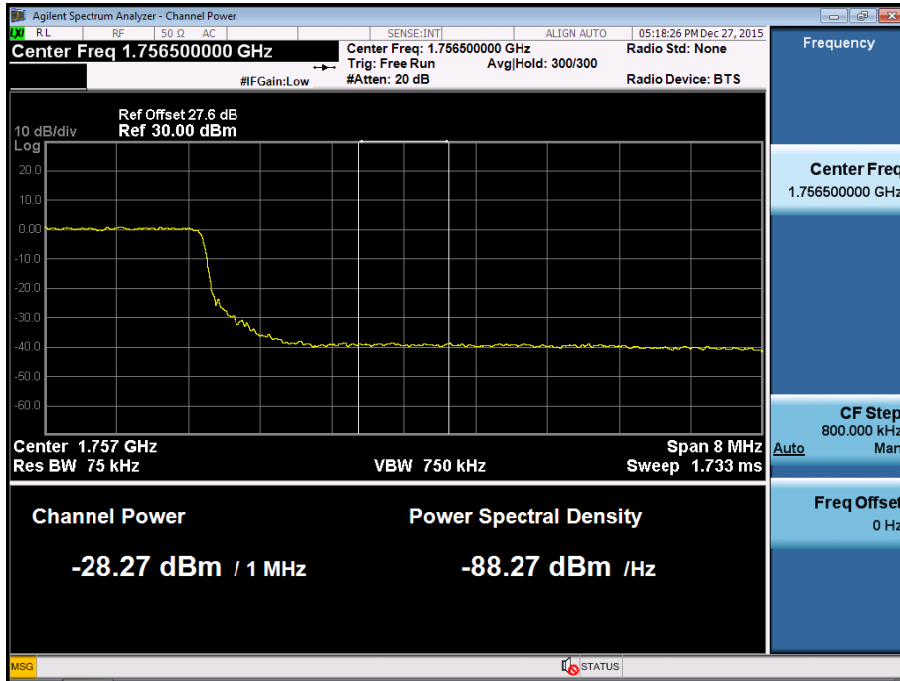

BAND 4. Upper Band Edge Plot (20M BW Ch.20300 QPSK\_RB1\_Offset 99) -1

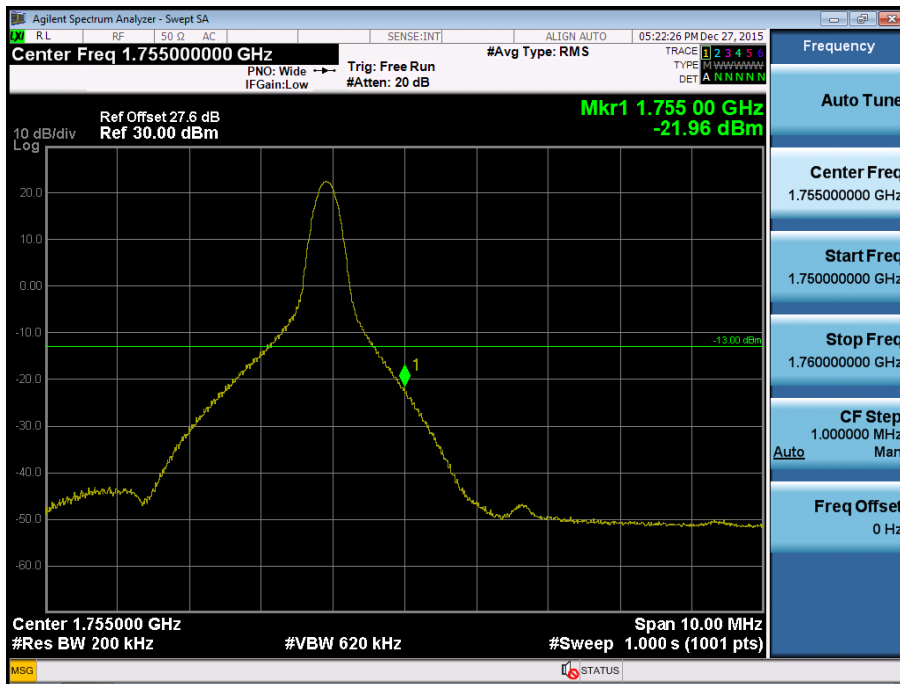



BAND 4. Upper Band Edge Plot (20M BW Ch.20300 QPSK\_RB100) -2



BAND 4. Upper Extended Band Edge Plot (20M BW Ch.20300 QPSK\_RB100) -3

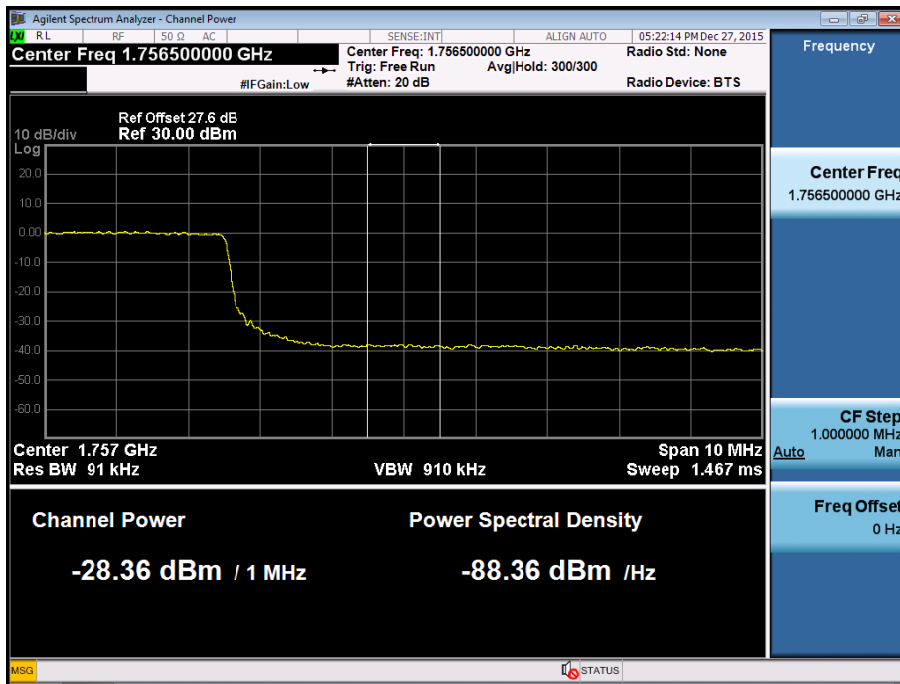

BAND 4. Conducted Spurious Plot\_1 (19957ch\_1.4MHz\_QPSK\_RB 1\_0)

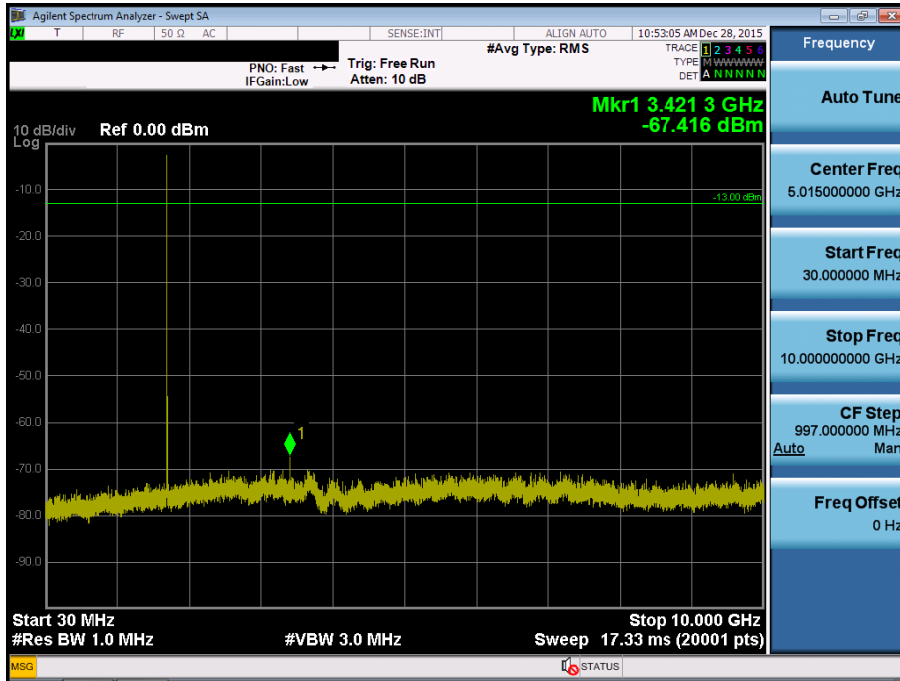

BAND 4. Conducted Spurious Plot\_2 (19957ch\_1.4MHz\_QPSK\_RB 1\_0)

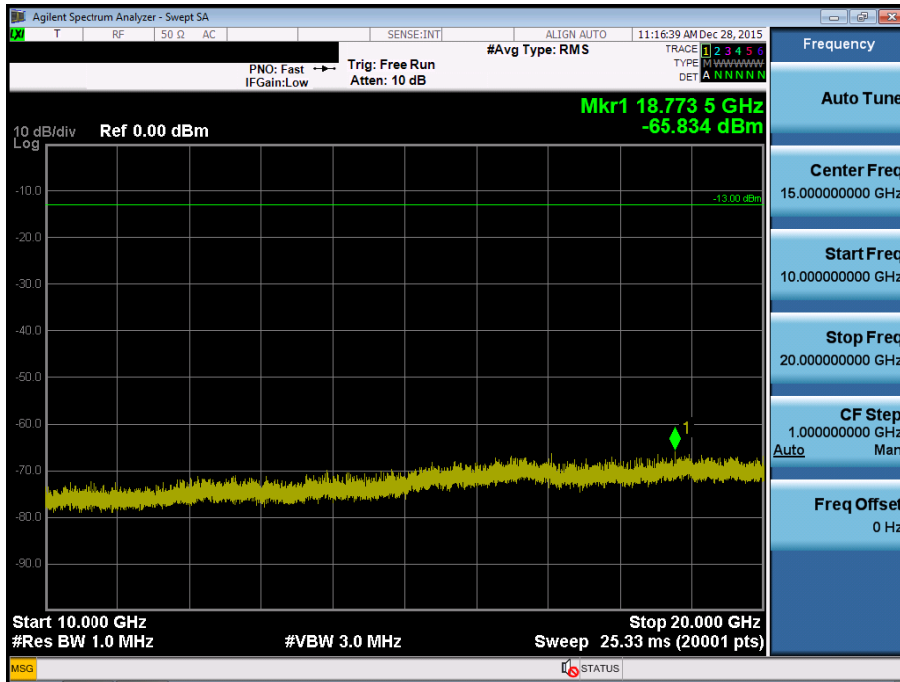

BAND 4. Conducted Spurious Plot\_1 (20175ch\_1.4MHz\_QPSK\_RB 1\_0)

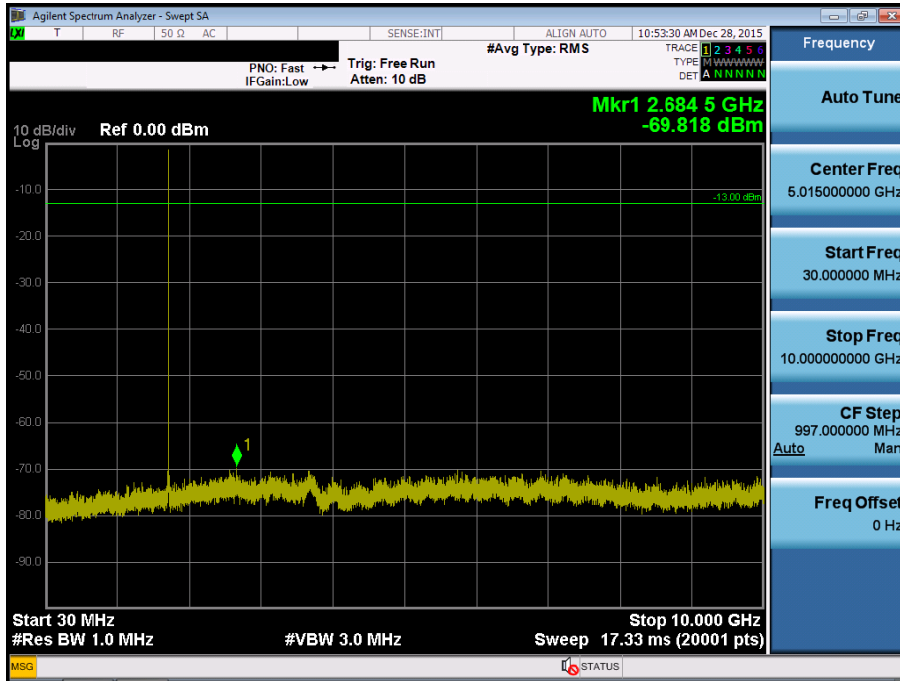

BAND 4. Conducted Spurious Plot\_2 (20175ch\_1.4MHz\_QPSK\_RB 1\_0)

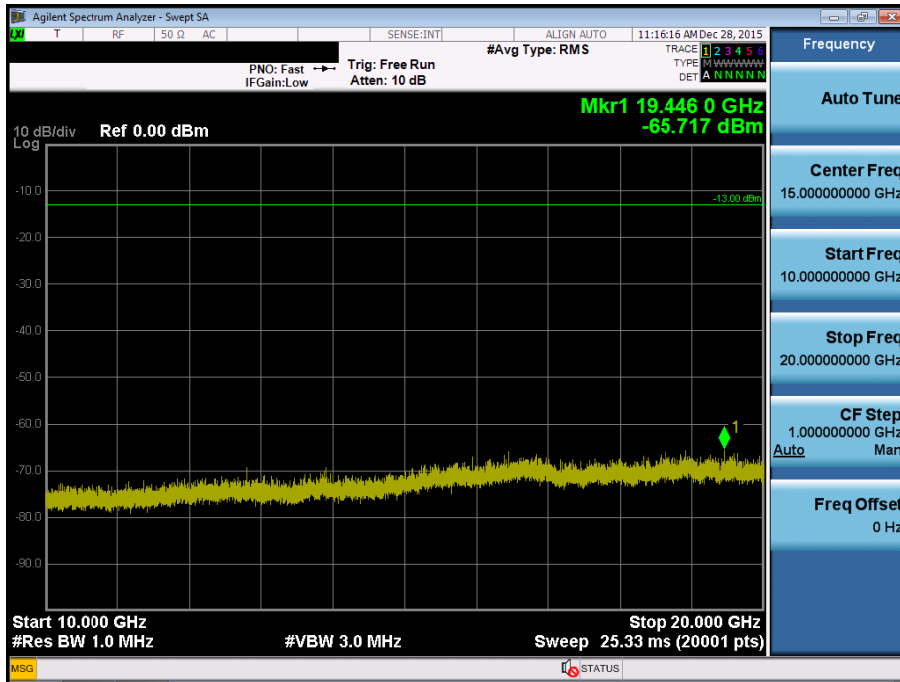

BAND 4. Conducted Spurious Plot\_1 (20393ch\_1.4MHz\_QPSK\_RB 1\_0)

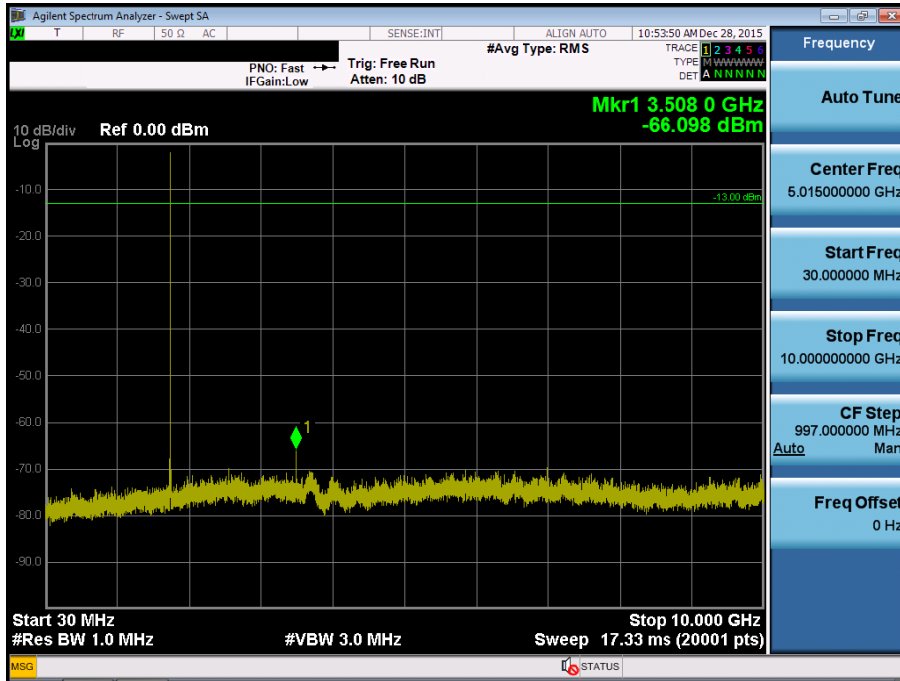

BAND 4. Conducted Spurious Plot\_2 (20393ch\_1.4MHz\_QPSK\_RB 1\_0)

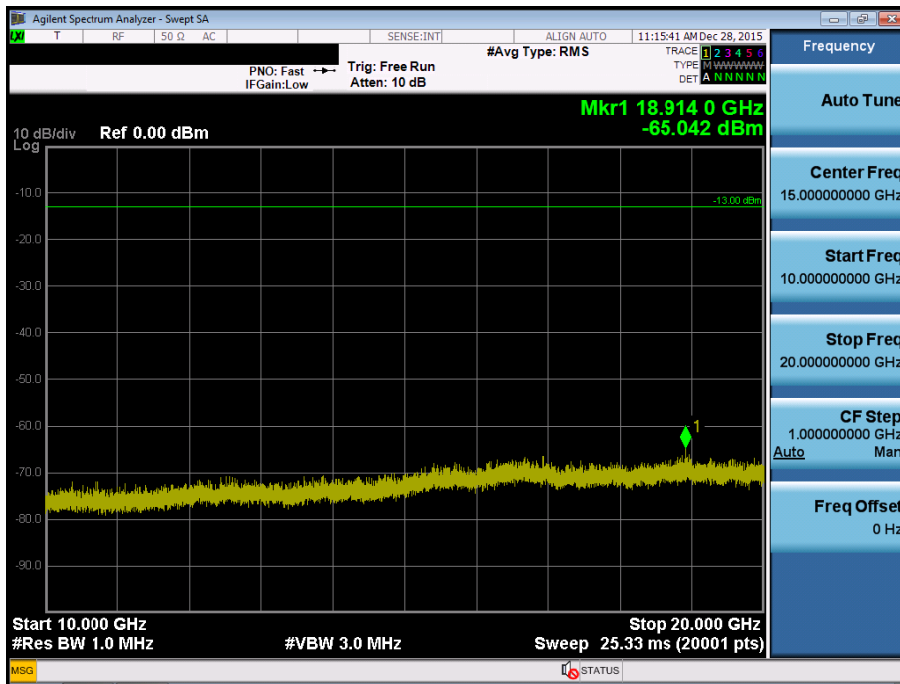

BAND 4. Conducted Spurious Plot\_1 (19965ch\_3MHz\_QPSK\_RB 1\_0)

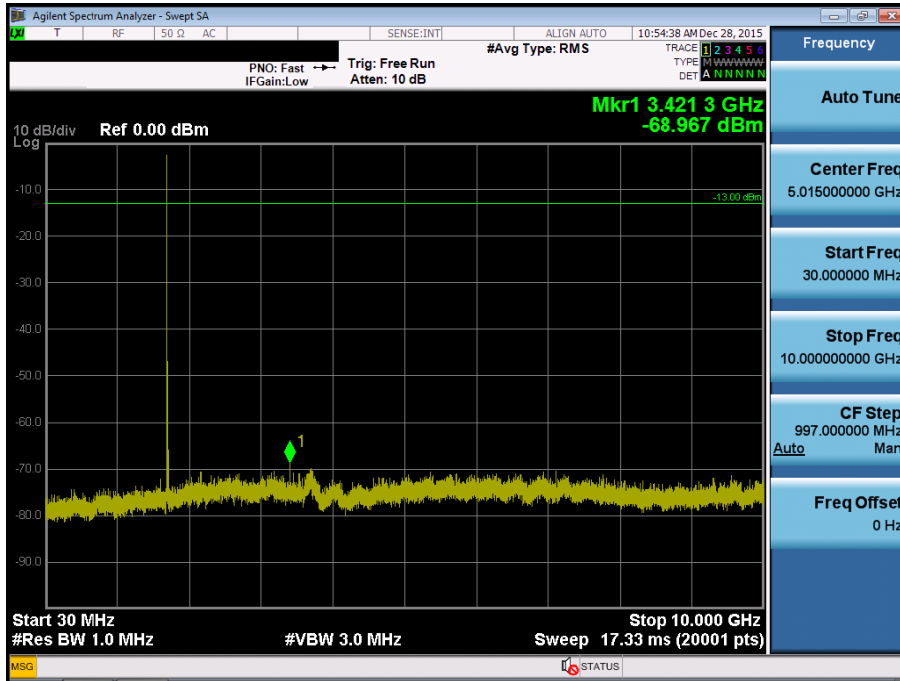

BAND 4. Conducted Spurious Plot\_2 (19965ch\_3MHz\_QPSK\_RB 1\_0)

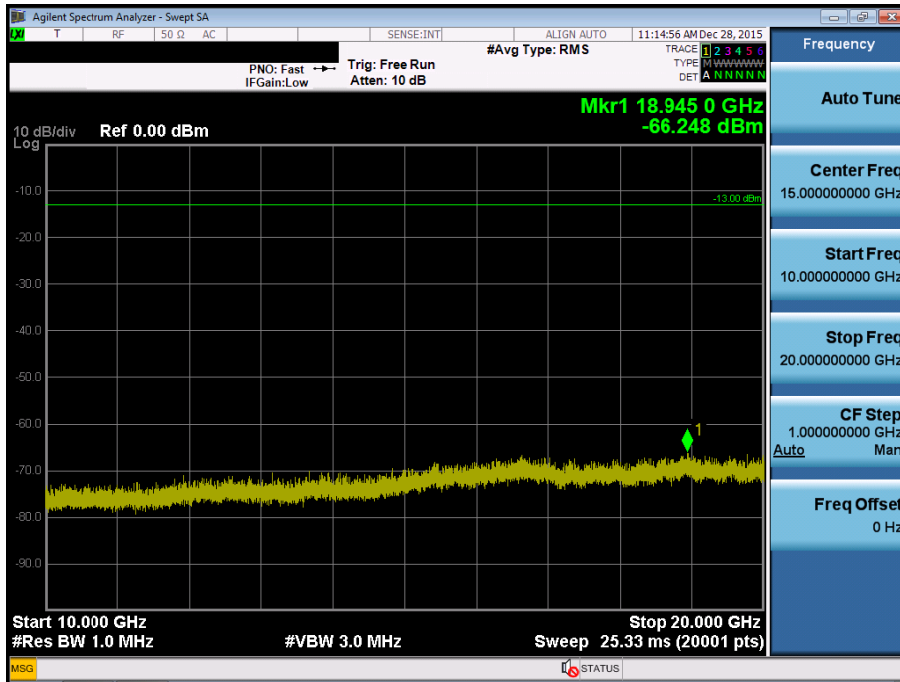

BAND 4. Conducted Spurious Plot\_1 (20175ch\_3MHz\_QPSK\_RB 1\_0)

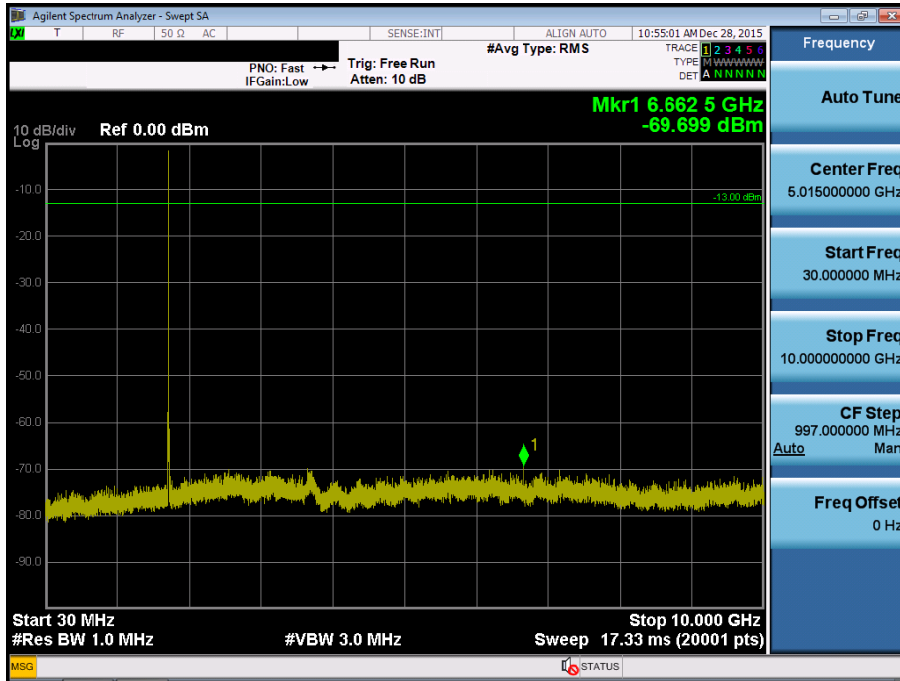

BAND 4. Conducted Spurious Plot\_2 (20175ch\_3MHz\_QPSK\_RB 1\_0)

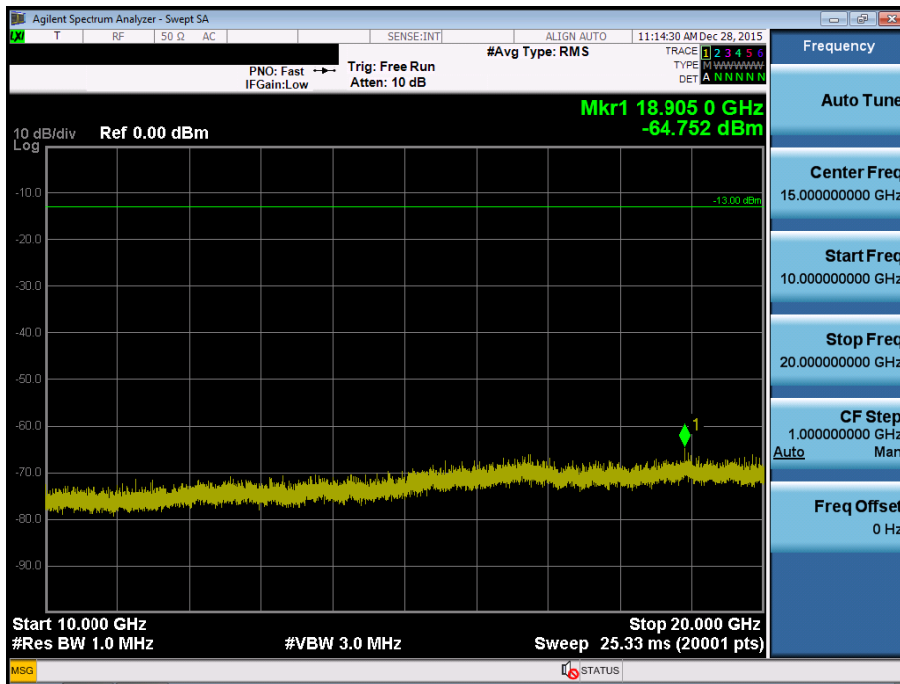

BAND 4. Conducted Spurious Plot\_1 (20385ch\_3MHz\_QPSK\_RB 1\_0)

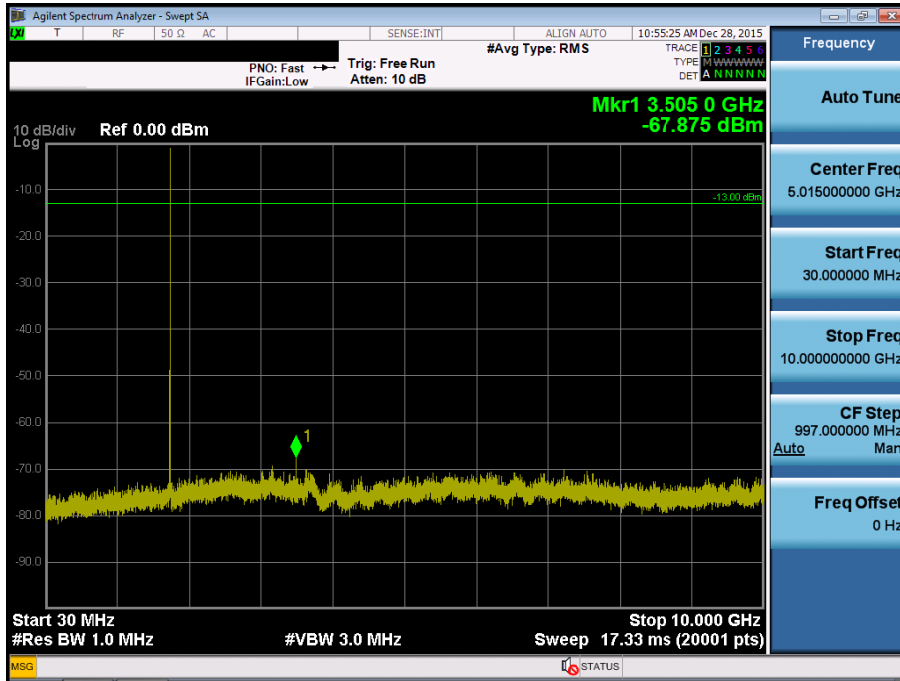

BAND 4. Conducted Spurious Plot\_2 (20385ch\_3MHz\_QPSK\_RB 1\_0)

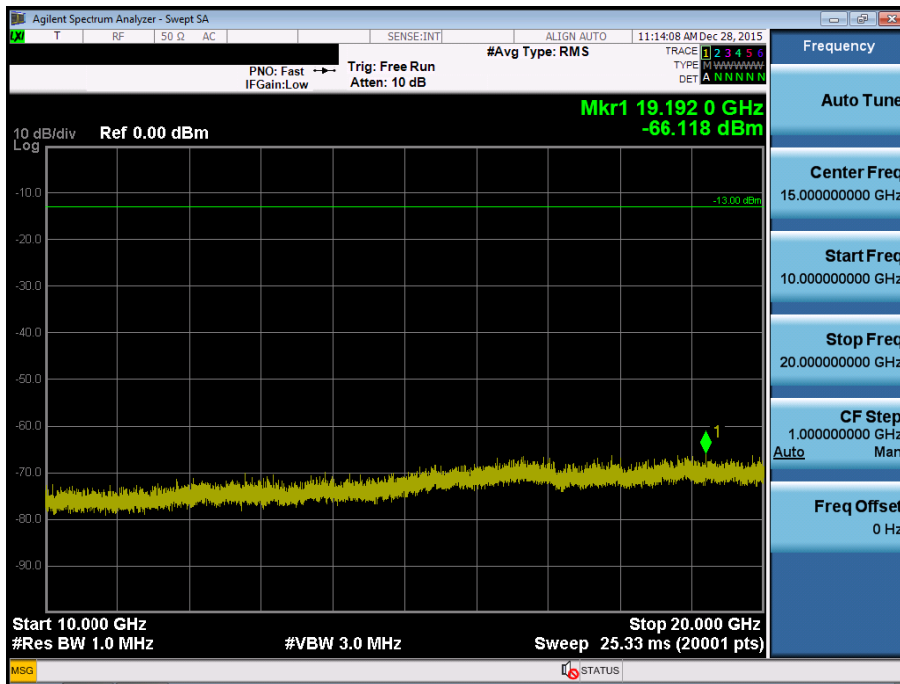

BAND 4. Conducted Spurious Plot\_1 (19975ch\_5MHz\_QPSK\_RB 1\_0)

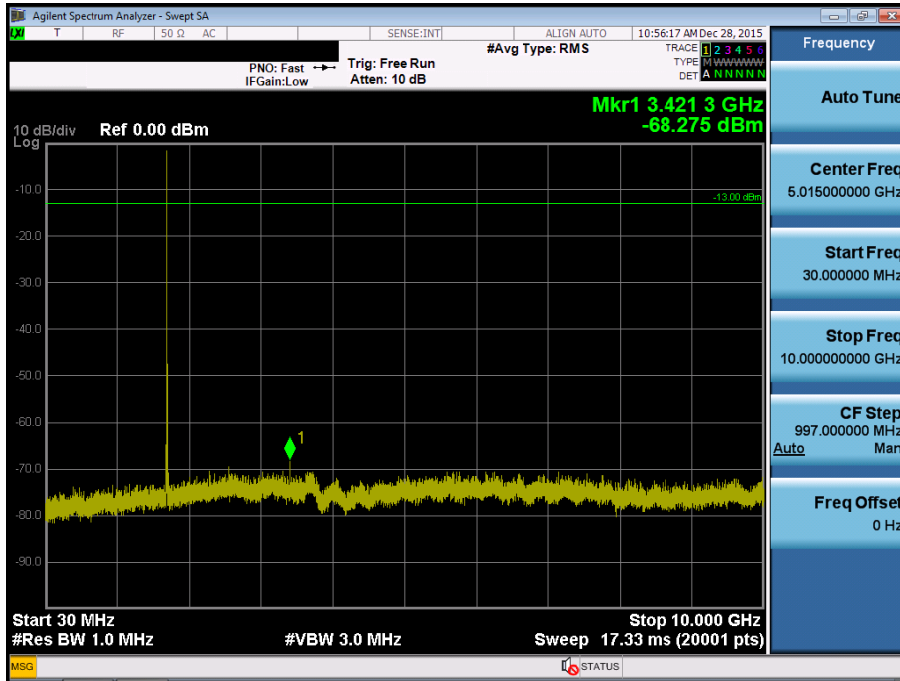

BAND 4. Conducted Spurious Plot\_2 (19975ch\_5MHz\_QPSK\_RB 1\_0)

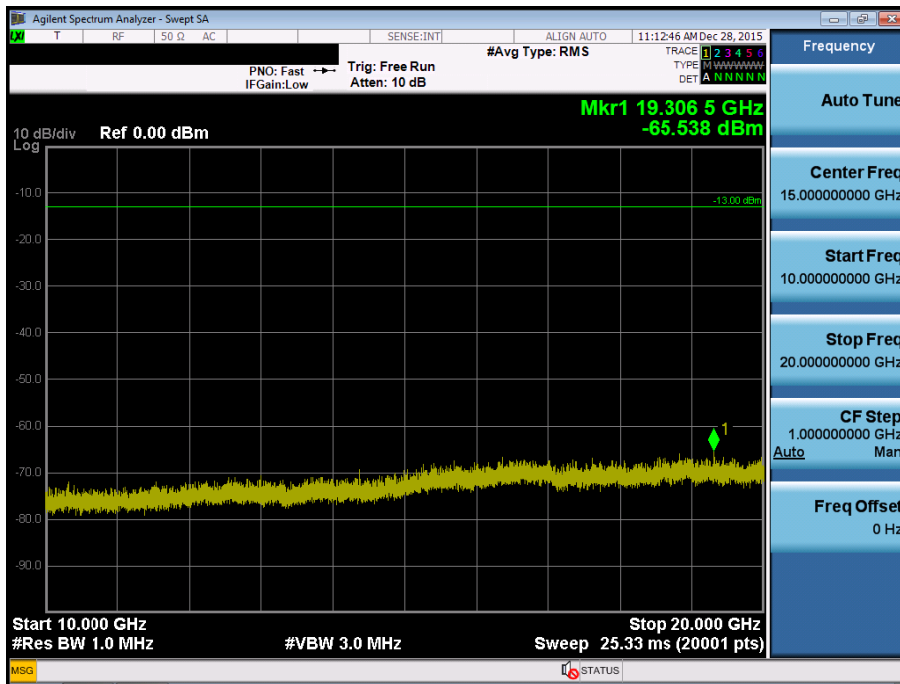



BAND 4. Conducted Spurious Plot\_1 (20175ch\_5MHz\_QPSK\_RB 1\_0)

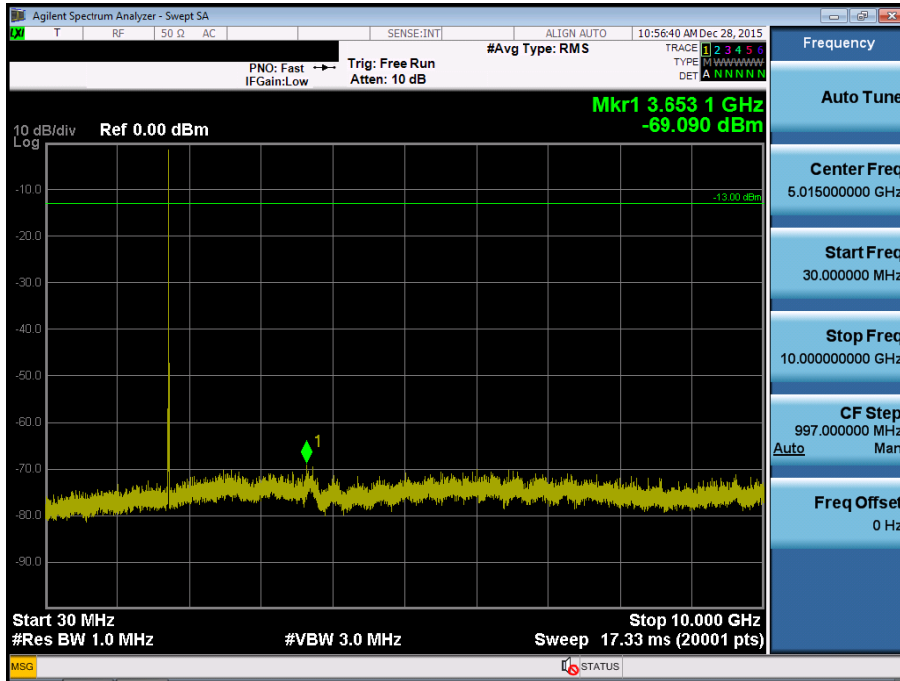

BAND 4. Conducted Spurious Plot\_2 (20175ch\_5MHz\_QPSK\_RB 1\_0)

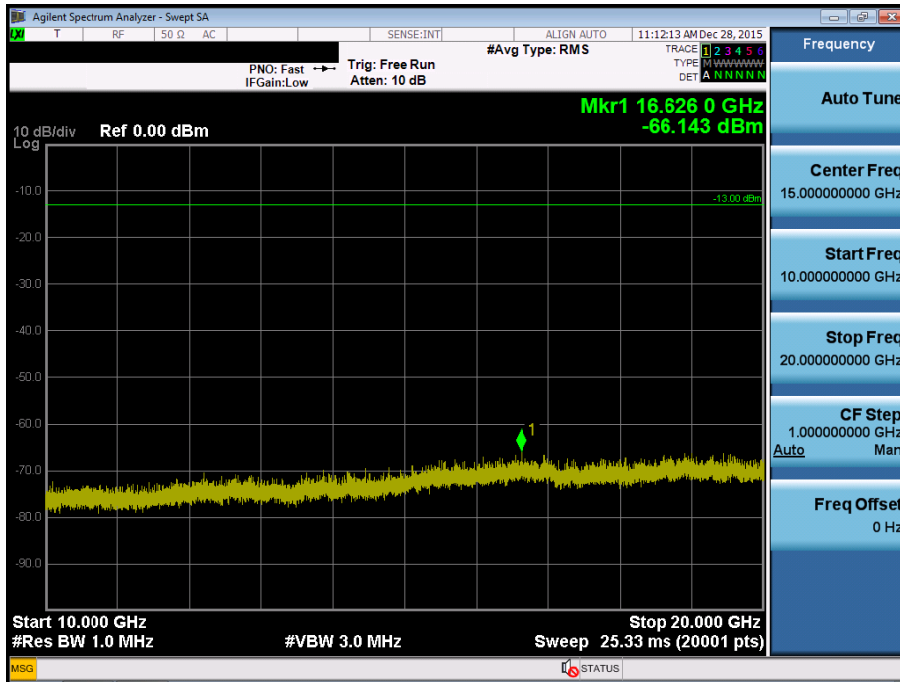

BAND 4. Conducted Spurious Plot\_1 (20375ch\_5MHz\_QPSK\_RB 1\_0)

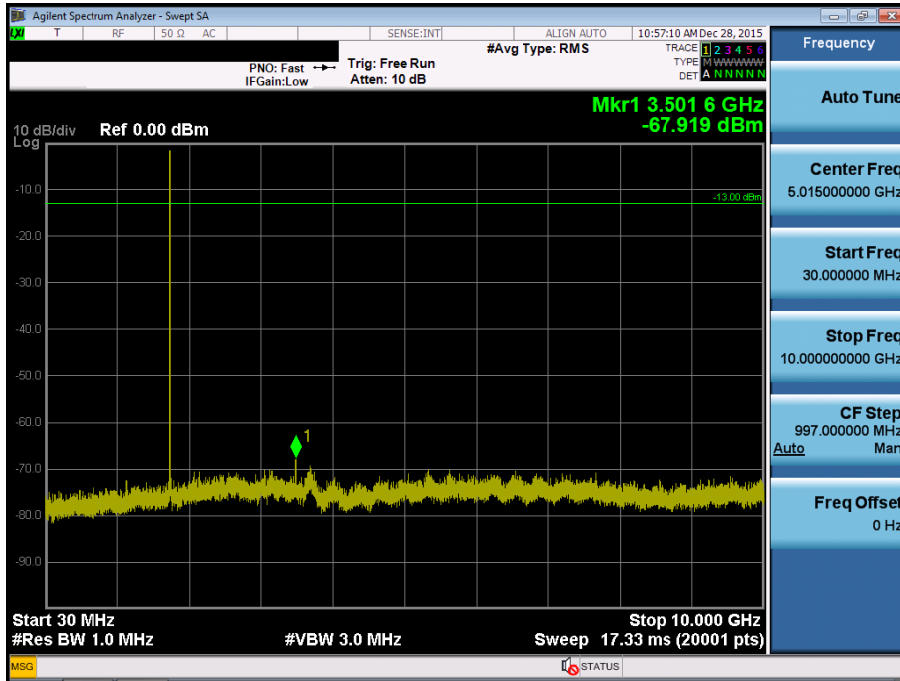

BAND 4. Conducted Spurious Plot\_2 (20375ch\_5MHz\_QPSK\_RB 1\_0)

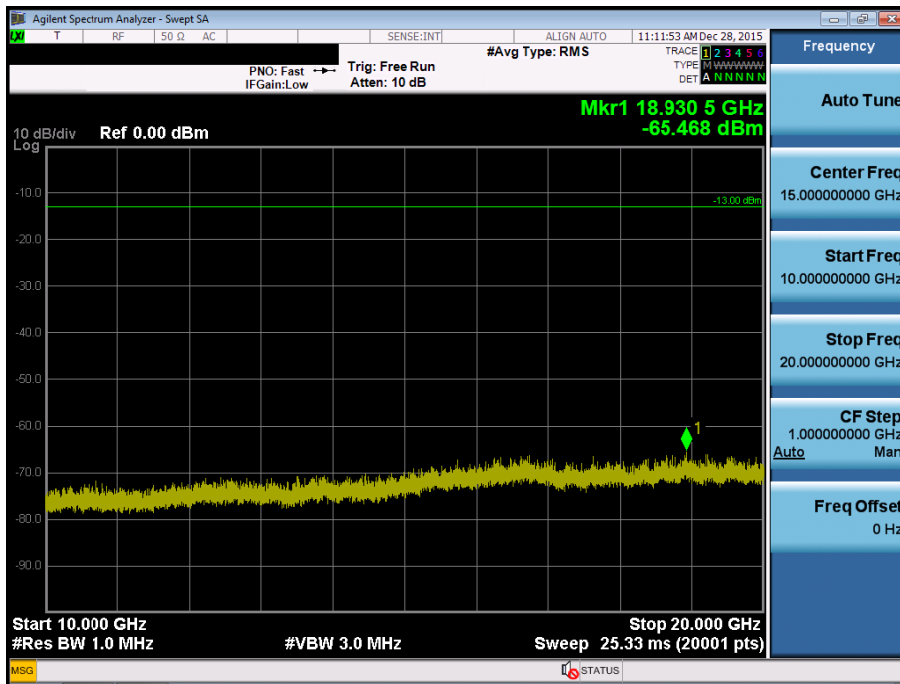

BAND 4. Conducted Spurious Plot\_1 (20000ch\_10MHz\_QPSK\_RB 1\_0)

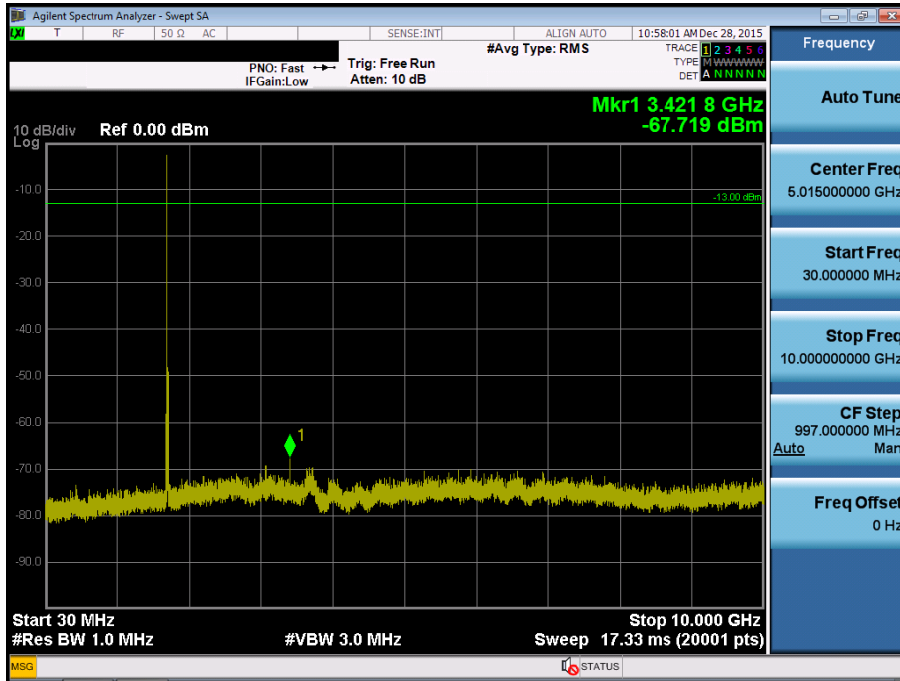

BAND 4. Conducted Spurious Plot\_2 (20000ch\_10MHz\_QPSK\_RB 1\_0)

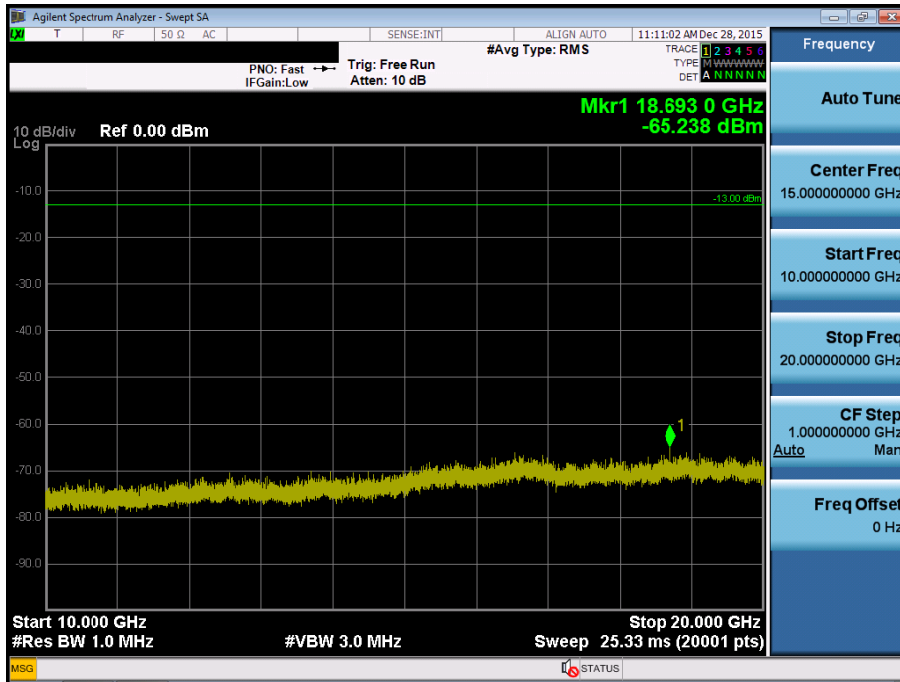

BAND 4. Conducted Spurious Plot\_1 (20175ch\_10MHz\_QPSK\_RB 1\_0)

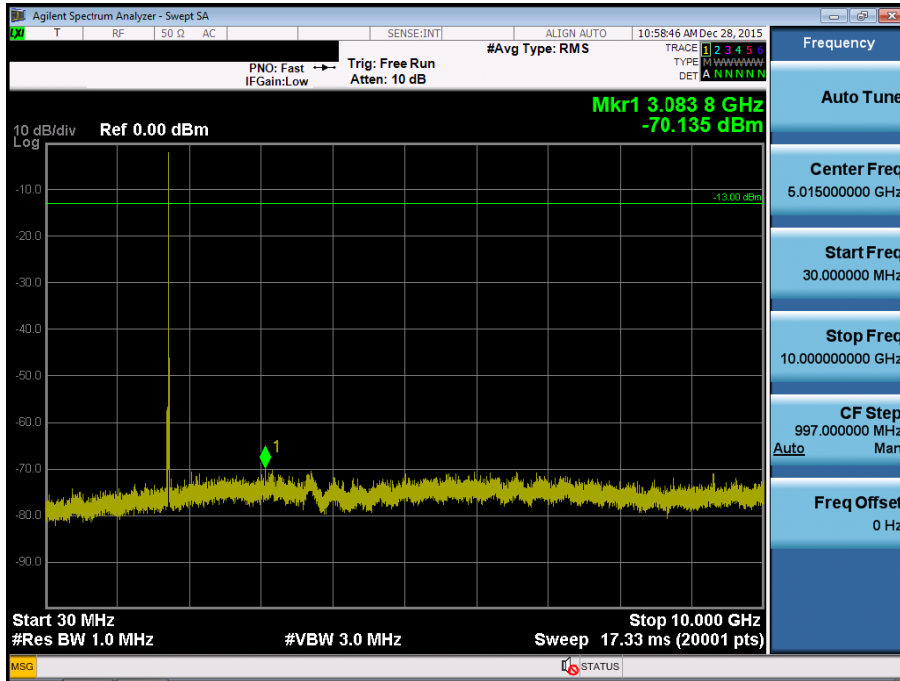

BAND 4. Conducted Spurious Plot\_2 (20175ch\_10MHz\_QPSK\_RB 1\_0)

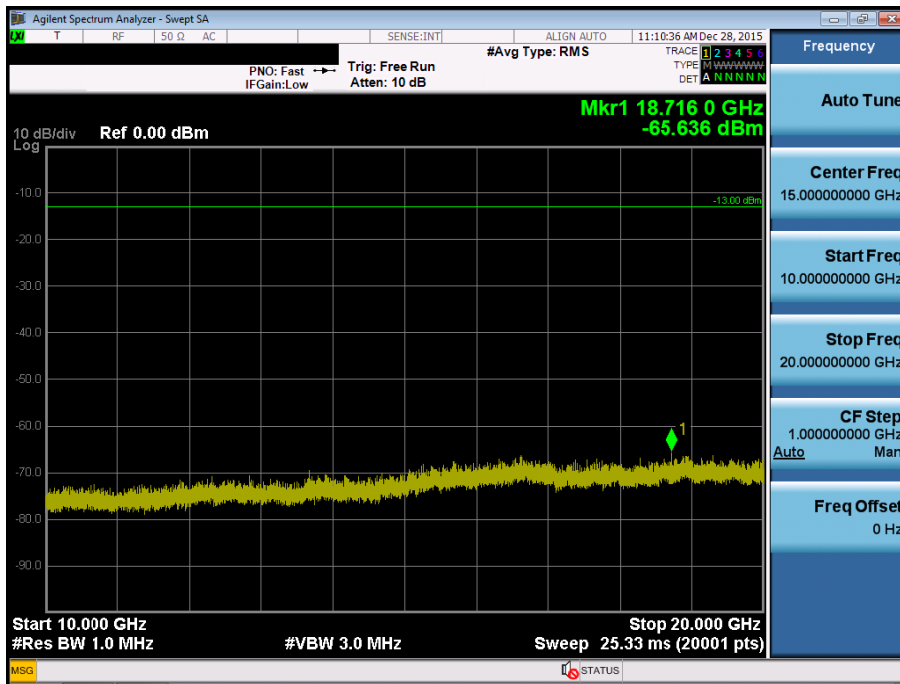

BAND 4. Conducted Spurious Plot\_1 (20350ch\_10MHz\_QPSK\_RB 1\_0)

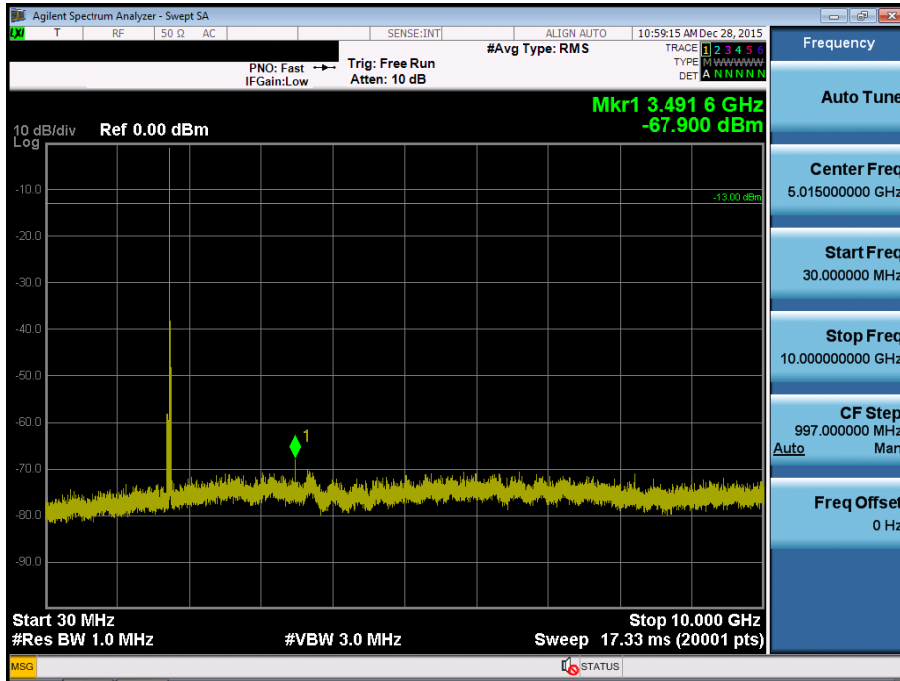

BAND 4. Conducted Spurious Plot\_2 (20350ch\_10MHz\_QPSK\_RB 1\_0)

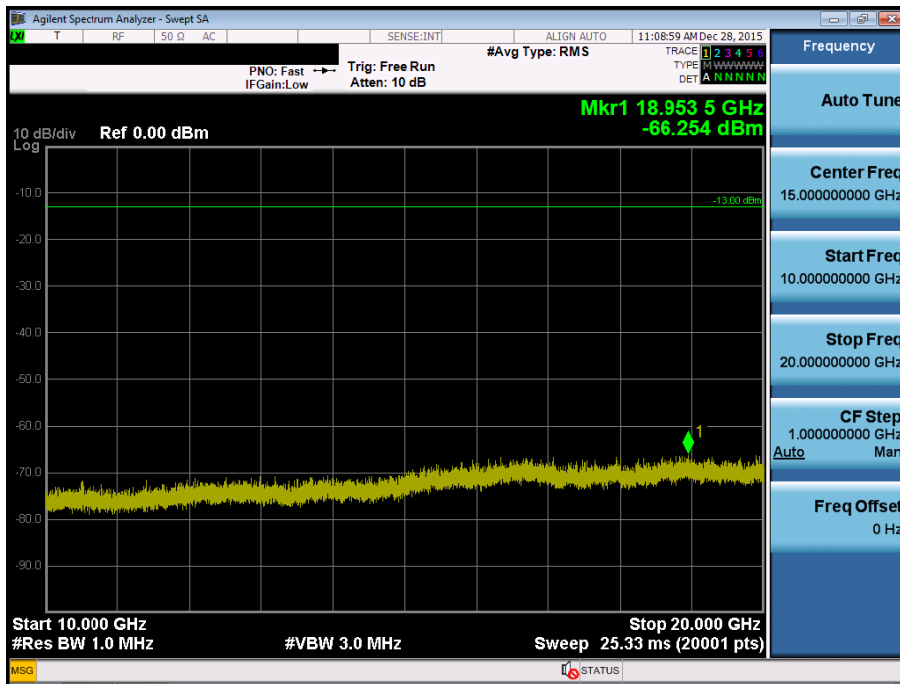

BAND 4. Conducted Spurious Plot\_1 (20025ch\_15MHz\_QPSK\_RB 1\_0)

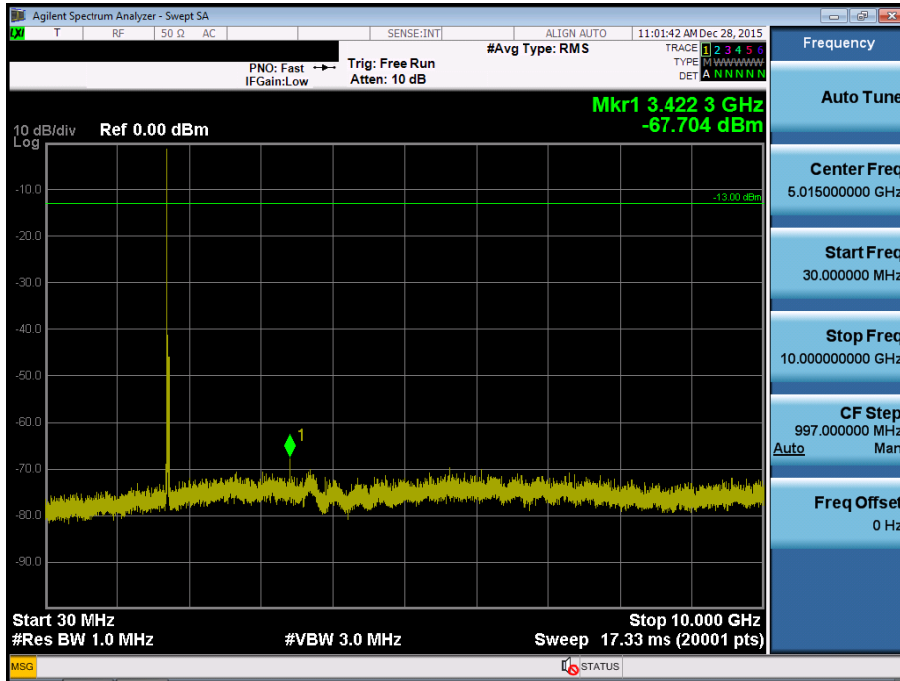

BAND 4. Conducted Spurious Plot\_2 (20025ch\_15MHz\_QPSK\_RB 1\_0)

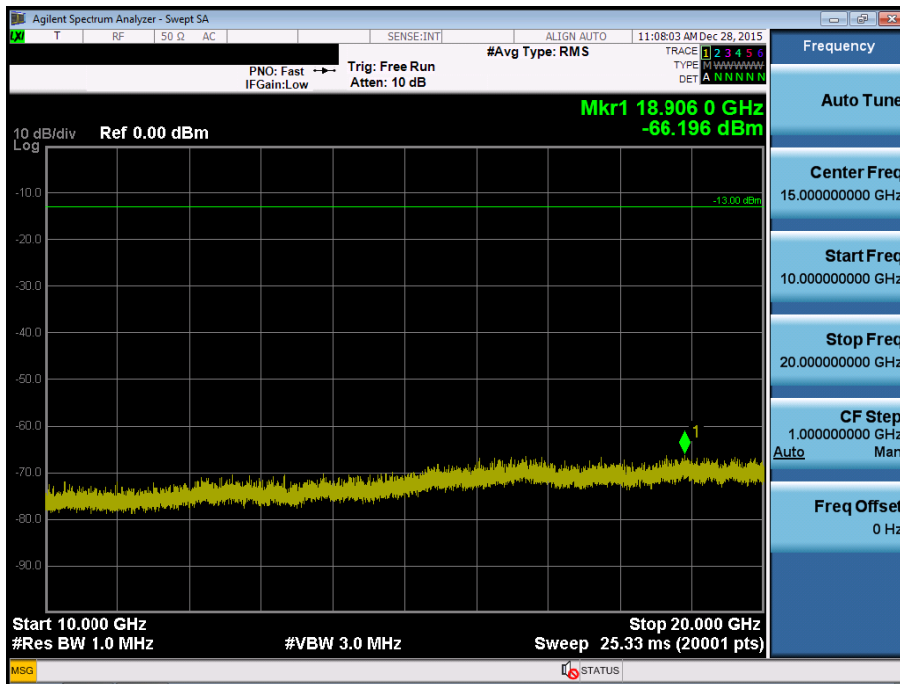

BAND 4. Conducted Spurious Plot\_1 (20175ch\_15MHz\_QPSK\_RB 1\_0)

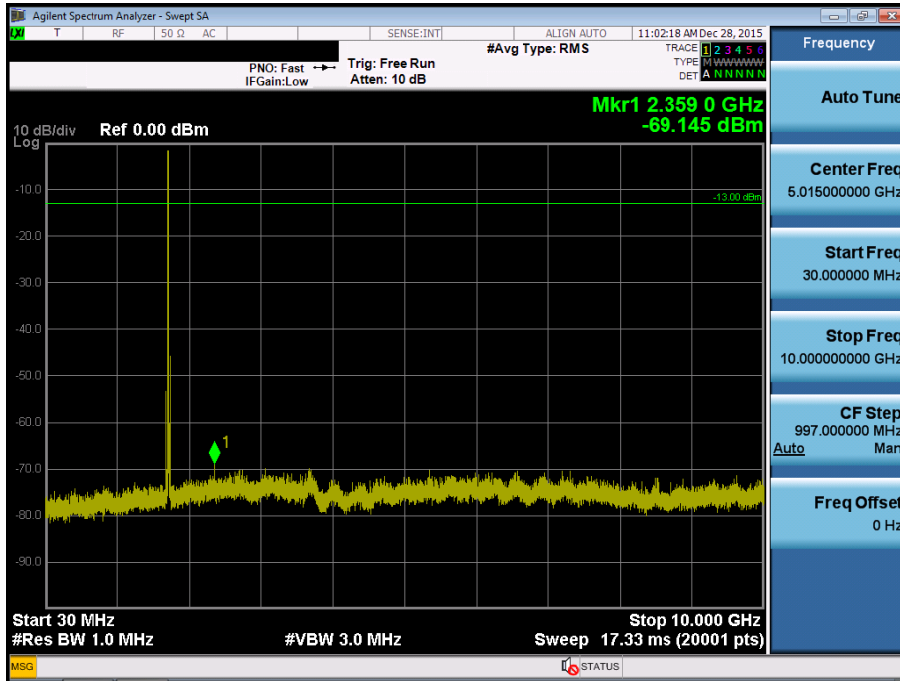

BAND 4. Conducted Spurious Plot\_2 (20175ch\_15MHz\_QPSK\_RB 1\_0)

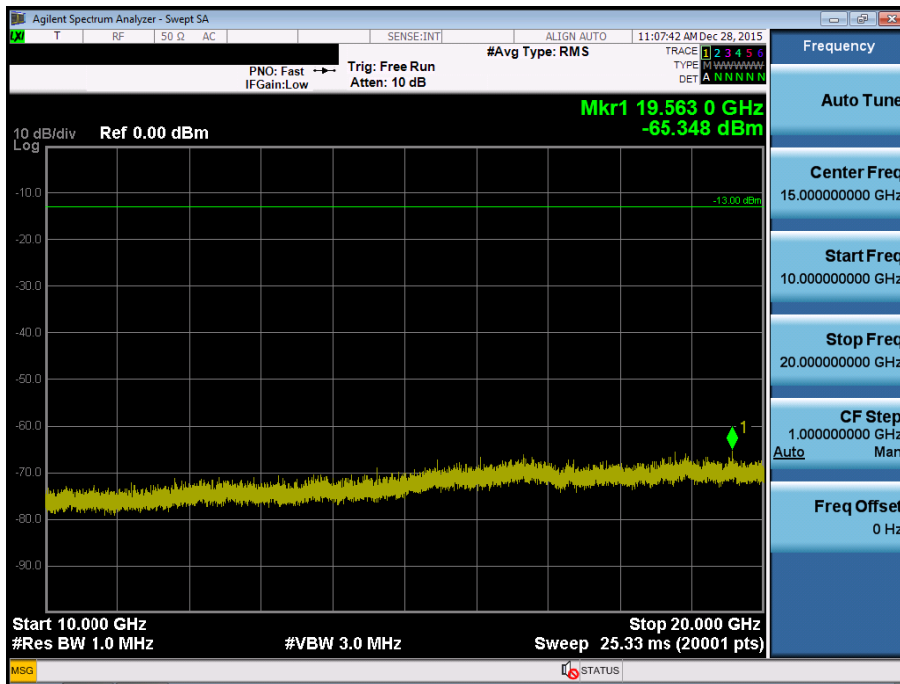

BAND 4. Conducted Spurious Plot\_1 (20325ch\_15MHz\_QPSK\_RB 1\_0)

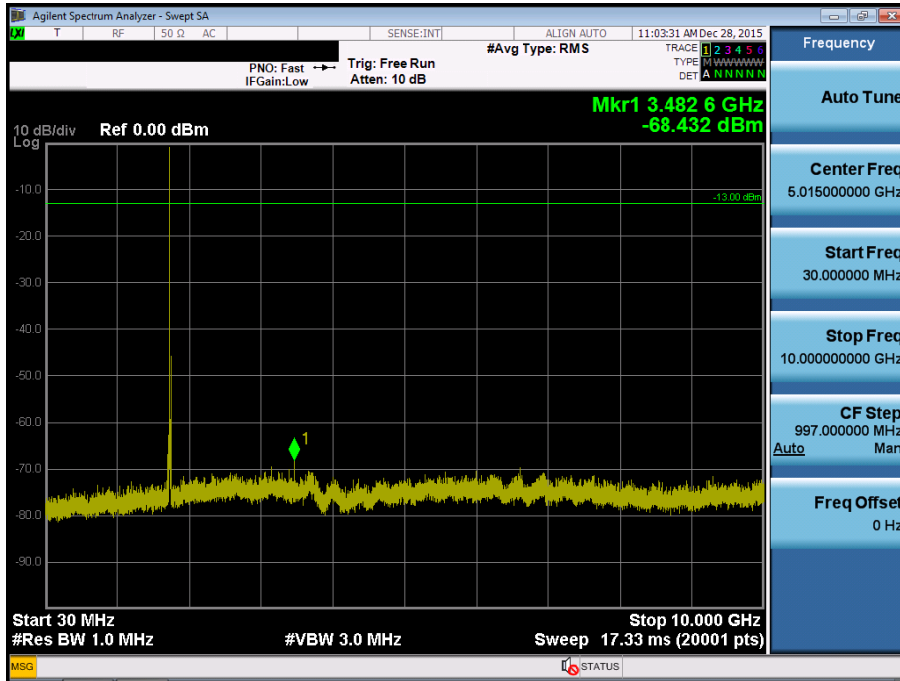

BAND 4. Conducted Spurious Plot\_2 (20325ch\_15MHz\_QPSK\_RB 1\_0)

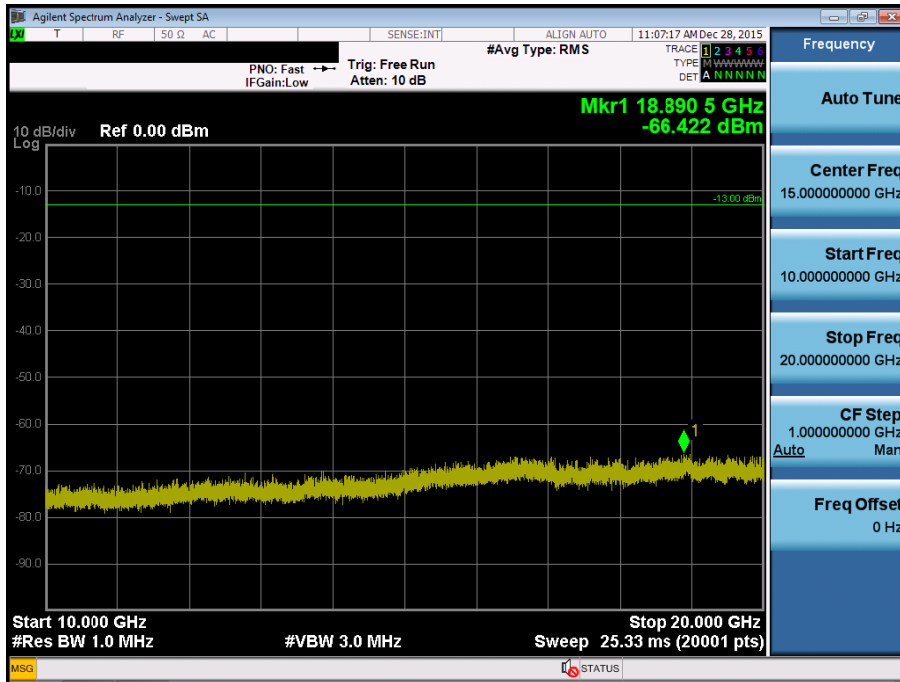



BAND 4. Conducted Spurious Plot\_1 (20050ch\_20MHz\_QPSK\_RB 1\_0)

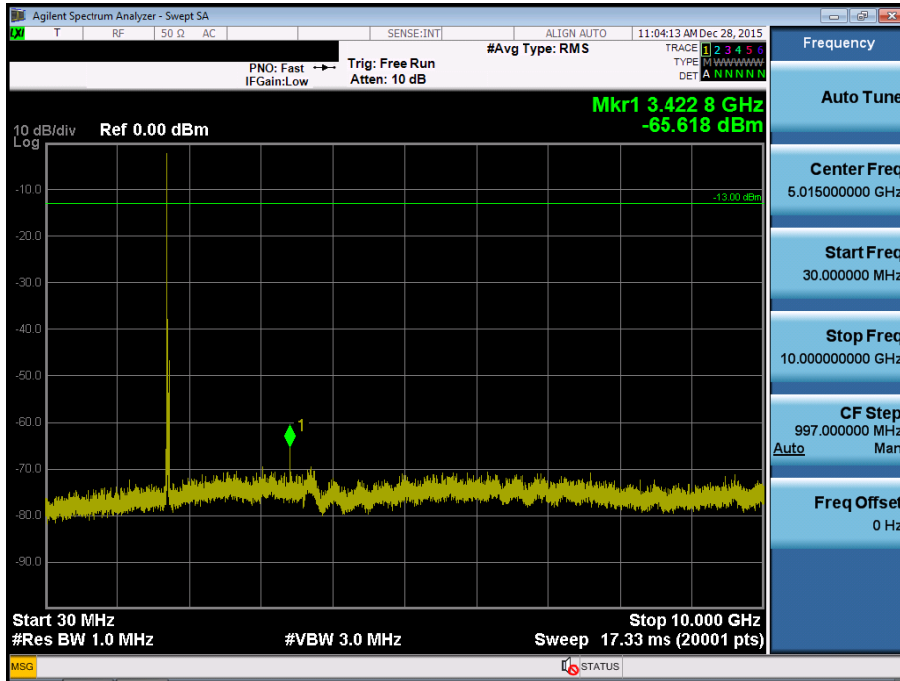

BAND 4. Conducted Spurious Plot\_2 (20050ch\_20MHz\_QPSK\_RB 1\_0)

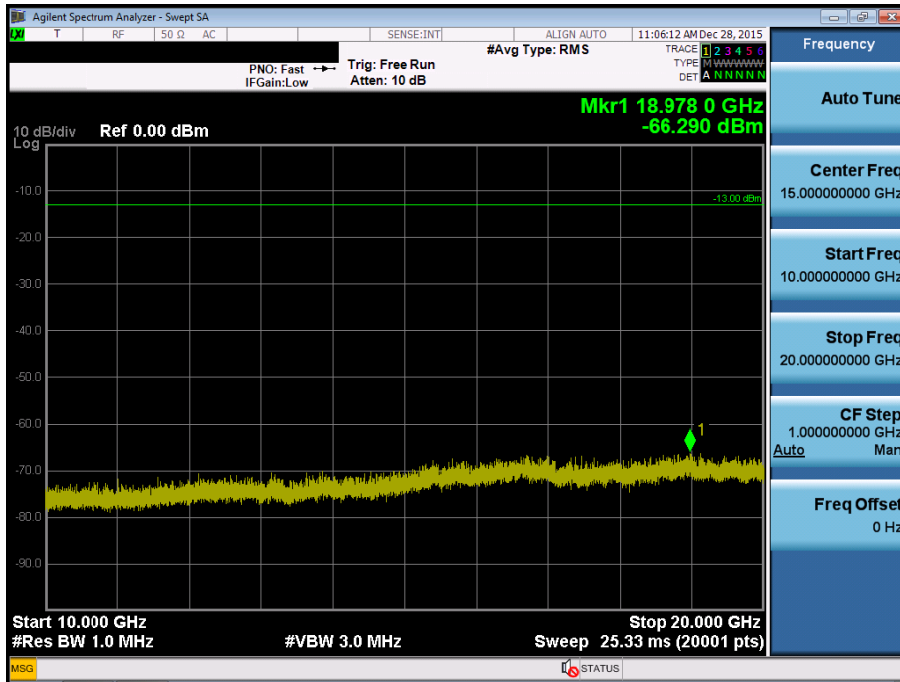

BAND 4. Conducted Spurious Plot\_1 (20175ch\_20MHz\_QPSK\_RB 1\_0)

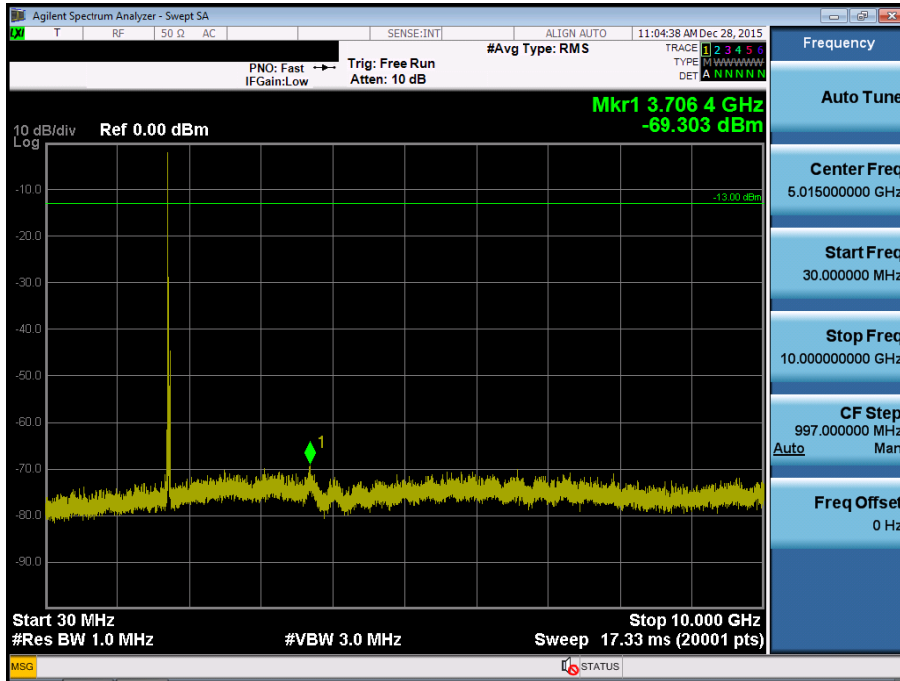

BAND 4. Conducted Spurious Plot\_2 (20175ch\_20MHz\_QPSK\_RB 1\_0)

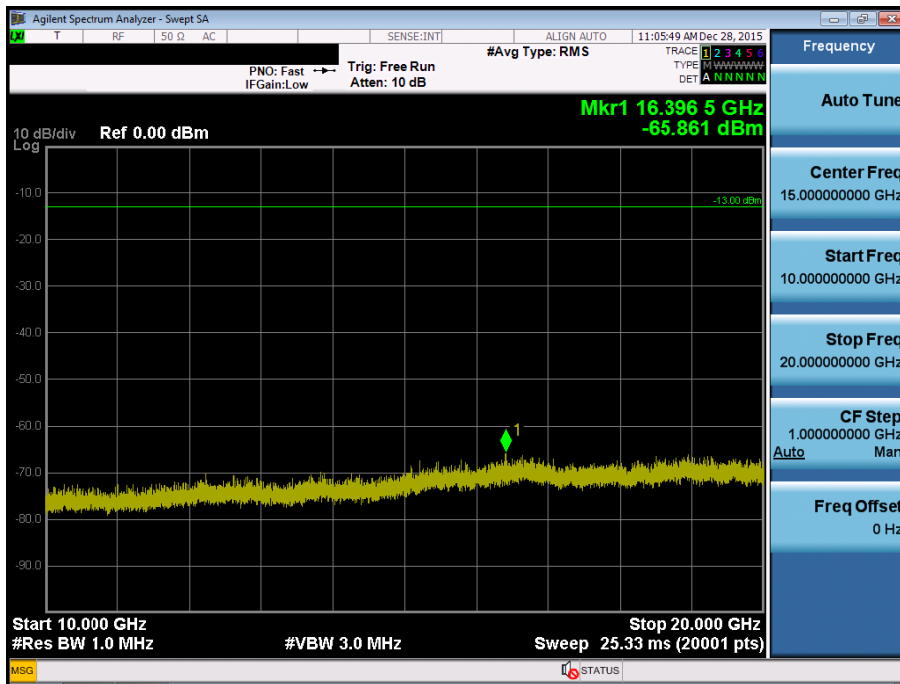

BAND 4. Conducted Spurious Plot\_1 (20300ch\_20MHz\_QPSK\_RB 1\_0)

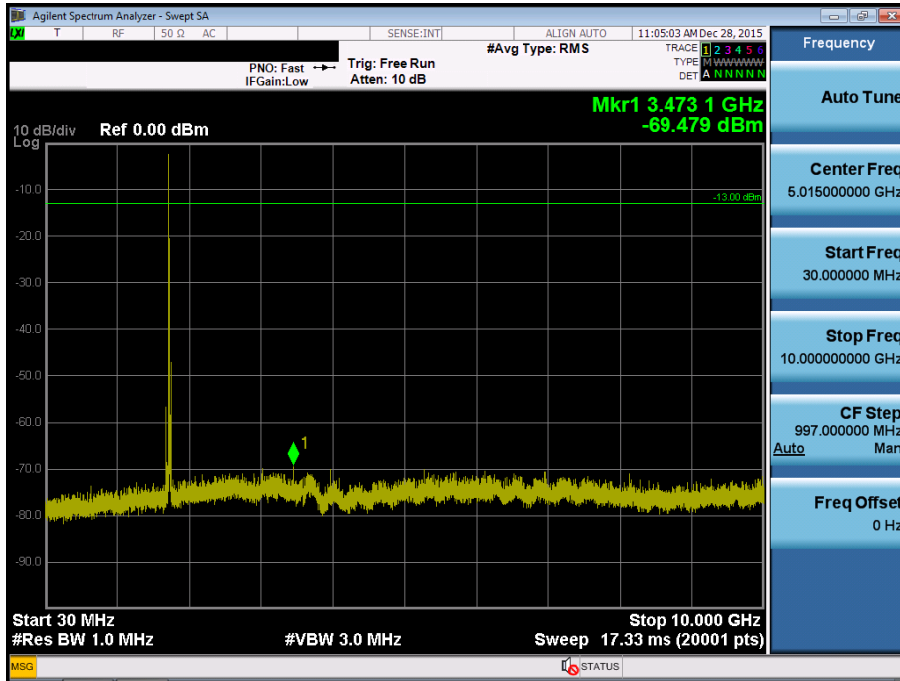

BAND 4. Conducted Spurious Plot\_2 (20300ch\_20MHz\_QPSK\_RB 1\_0)

