

USER GUIDE

LG-K350n

About this user guide

ENGLISH

Thank you for choosing LG. Please carefully read this user guide before using the device for the first time to ensure safe and proper use.

- Always use genuine LG accessories. The supplied items are designed only for this device and may not be compatible with other devices.
- This device is not suitable for people who have a visual impairment due to the touchscreen keyboard.
- Descriptions are based on the device default settings.
- Default apps on the device are subject to updates and support for these apps may be withdrawn without prior notice. If you have any questions about an app provided with the device, please contact a LG Service Centre. For user-installed apps, please contact the relevant service provider.
- Modifying the device's operating system or installing software from unofficial sources may damage the device and lead to data corruption or data loss. Such actions will violate your LG licence agreement and void your warranty.
- Some contents and illustrations may differ from your device depending on the region, service provider, software version, or OS version, and are subject to change without prior notice.
- Software, audio, wallpaper, images, and other media supplied with your device are licensed for limited use. If you extract and use these materials for commercial or other purposes, you may be infringing copyright laws. As a user, you are fully responsible for the illegal use of media.
- Additional charges may apply for data services, such as messaging, uploading, downloading, auto-syncing and location services. To avoid additional charges, select a data plan suitable to your needs. Contact your service provider to obtain additional details.

Instructional notices



 WARNING	Situations that could cause injury to yourself and others, or damage to device or other property.
 NOTE	Notices or additional information.







Table of contents







Guidelines for safe and efficient use.....	5	Changing the screen lock method.....	33
Special Features.....	16	Smart Lock.....	33
Capture+	17	Home screen	34
Viewing the saved memo.....	17	Getting to Know the Home Screen.....	34
Gesture shot	18	Returning to recently used applications.....	35
Taking the photos with a gesture.....	18	Customising the Home screen.....	36
Basics	19	Notifications panel	37
Accessories	20	Capturing a screenshot.....	39
Device layout.....	21	On-screen keyboard.....	39
Turning Your Device On and Off	23	Using the keypad and entering text.....	39
Installing the SIM card and battery.....	23	Entering special characters.....	40
Charging the battery	25	Transferring data between a PC and the device.....	41
Optimizing battery life.....	26	Transferring data using USB connection....	41
Inserting the memory card	27	LG Bridge.....	42
Removing the memory card	28	Features of LG Bridge	42
Touch screen tips	28	To download the LG Bridge software.....	42
Tap or touch.....	28	Apps	43
Touch and hold.....	29	Installing or uninstalling apps.....	44
Drag.....	29	To open the Play Store app.....	44
Swipe or slide	29	To open a screen with details about an app.....	44
Double-tap.....	30	To uninstall applications.....	44
Pinch-to-Zoom	30	Calls.....	44
Google account setup	31	Making a call	44
Creating your Google account.....	31	Calling your contacts.....	45
Signing into your Google account.....	31	Answering and rejecting a call	45
Locking and unlocking the device.....	32	Making a second call.....	45
KnockON.....	32	Viewing your call logs.....	45
Knock Code.....	32	Change your call settings	46
		Contacts.....	46





Searching for a contact.....	46	Calculator	59
Adding a new contact.....	46	Calendar	59
Favourites contacts.....	47	Tasks	60
Creating a group.....	47	Voice Recorder	60
Messaging	48	Recording a sound or voice.....	60
Sending a message.....	48	Downloads	60
Conversation view.....	48	FM Radio	61
Changing your messaging settings.....	48	LG Backup	61
Camera	49	About backing up and restoring	
Taking a photo.....	49	device data.....	61
Camera options on the viewfinder.....	49	To backup your device data.....	62
Once you have taken a photo.....	51	Google apps	62
Recording a video.....	51	Settings	64
After recording a video.....	52	Access the Settings menu	65
Gallery	52	Networks Settings	65
Viewing pictures.....	53	Wi-Fi.....	65
Editing photos.....	53	Wi-Fi Direct.....	66
Setting wallpaper.....	53	Bluetooth.....	66
Zooming in and out.....	53	Mobile data.....	67
Playing a video.....	54	Call.....	68
Deleting photos/videos.....	55	NFC.....	69
E-mail	55	Android Beam.....	69
Adding an account.....	55	Printing.....	70
Working with account folders.....	55	USB tethering.....	70
Composing and sending email.....	56	Wi-Fi hotspot.....	70
Changing an email general settings.....	56	Bluetooth tethering.....	70
Deleting an email account.....	56	Airplane mode.....	71
Music	56	Mobile networks.....	71
Playing a song.....	57	VPN.....	71
Music player options.....	57	Sound & notification settings	71
Clock	58	More settings.....	72
Alarms.....	58	Display settings	72
Timer.....	58		
World clock.....	59		
Stopwatch.....	59		

Home screen.....	72
Lock screen.....	73
Home touch buttons.....	73
More display settings.....	74
General settings.....	74
Language & keyboard.....	74
Location.....	75
Accounts & sync.....	75
Accessibility.....	76
Shortcut key.....	77
Google.....	77
Security.....	78
Date & time.....	78
Storage & USB.....	79
Battery & power saving.....	79
Memory.....	79
Apps.....	80
Default message app.....	80
Backup & reset.....	80
About phone.....	80
Appendix.....	81
Device software update.....	82
FAQ.....	83
Anti-Theft Guide.....	86
More information.....	87
Open source software notice information.....	87
Regulatory information (FCC ID number, etc.).....	87
Trademarks.....	87
Declaration of conformity.....	88
Contact office for compliance of this product.....	88

Guidelines for safe and efficient use

Symbol	Description
	Read these instructions for safe use of this wireless device.
	You must always exercise extreme caution when driving in order to reduce the risk of accidents. Do not use your wireless device while driving.
	<p>This device, moreover, has been tested for use at a distance of 5 mm between the back of the phone and the user's body.</p> <p>To comply with RF exposure requirements established by the FCC, you must maintain a minimum distance of 1 cm between the user's body and the back of the phone. See the user manual for more information.</p>
	Do not leave the device or its accessories within the reach of children and do not allow to play with. The device contains small parts with sharp edges that may cause injury or break off and give rise to danger of suffocation.
	This device may produce a loud sound.
	Pacemaker manufacturers recommend that you leave at least 15 cm of space between other devices and a pacemaker to avoid potential interference with the pacemaker.

Symbol	Description
	<p>Switch off your phone when prompted to do so in hospitals, clinics or health care facilities. These requests are designed to prevent possible interference with sensitive medical devices.</p>
	<p>Turn off your wireless device when prompted to do so by airport personnel or aircraft. For information on the use of wireless devices on board aircraft, contact the crew. If the device has a "flight mode", this must be activated before boarding an aircraft.</p>
	<p>Turn off the device or wireless device when in any area in which they occur explosions or areas where there are reports that indicate to "turn off two-way radio" or "electronic devices" to avoid interfering with the operation of trigger explosions.</p>
	<p>Among the areas with potentially explosive atmospheres include fueling areas are, the holds of ships, facilities for the transportation or storage of fuel and chemicals, areas where the air contains chemicals or particles such as grain, dust or metal powders.</p>
	<p>This device may produce a bright or flashing light.</p>
	<p>Do not expose your device or its accessories to open flames.</p>
	<p>Do not expose your device or its accessories to magnetic media (floppy disks, credit cards, etc).</p>

Symbol	Description
	Do not expose your device or its accessories to extreme temperatures.
	Do not expose your device or its accessories to liquid or moisture.
	Do not disassemble the device or its accessories, only authorized personnel can do it.
	This device, like any wireless device, operates using radio signals which, by their nature, are not able to guarantee connection in all conditions. Therefore, for emergency communications, never rely solely upon any wireless device.
	Only use approved accessories.

Please read these simple guidelines. Not following these guidelines may be dangerous or illegal.

Should a fault occur, a software tool is built into your device that will gather a fault log. This tool gathers only data specific to the fault, such as signal strength, cell ID position in sudden call drop and applications loaded. The log is used only to help determine the cause of the fault. These logs are encrypted and can only be accessed by an authorised LG Repair centre should you need to return your device for repair.

Exposure to radio frequency energy

Radio wave exposure and Specific Absorption Rate (SAR) information. This mobile phone model LG-K350n has been designed to comply with applicable safety requirements for exposure to radio waves. These requirements are based on scientific guidelines that include safety margins designed to assure the safety of all persons, regardless of age and health.

- The radio wave exposure guidelines employ a unit of measurement known as the Specific Absorption Rate, or SAR. Tests for SAR are conducted using standardised methods with the phone transmitting at its highest certified power level in all used frequency bands.
- While there may be differences between the SAR levels of various LG phone models, they are all designed to meet the relevant guidelines for exposure to radio waves.
- The SAR limit recommended by the International Commission on Non-Ionizing Radiation Protection (ICNIRP) is 2 W/kg averaged over 10 g of tissue.
- This device meets RF exposure guidelines when used either in the normal use position against the ear or when positioned at least 5 mm away from the body. When a carry case, belt clip or holder is used for body-worn operation, it should not contain metal and should position the product at least 5 mm away from your body. In order to transmit data files or messages, this device requires a quality connection to the network. In some cases, transmission of data files or messages may be delayed until such a connection is available. Ensure the above separation distance instructions are followed until the transmission is completed.
- The highest simultaneous SAR values are:
 - * Head: 0.844 W/kg
 - * Body: 1.657 W/Kg

FCC SAR information

Your mobile device is also designed to meet the requirements for exposure to radio waves established by the Federal Communications Commission (USA).

These requirements set a SAR limit of 1.6 W/kg averaged over 1 gram of tissue.

The highest simultaneous SAR values are:

* Head: 1.20 W/kg

* Body-worn/Hotspot: 0.72 W/kg

Additionally, this device was tested for typical body-worn operations with the back of the phone kept 1 cm (0.39 inches) between the users body and the back of the phone.

To comply with FCC RF exposure requirements, a minimum separation distance of 1 cm (0.39 inches) must be maintained between the user's body and the back of the phone.

Any beltclips, holsters, and similar accessories containing metallic components may not be used. Body-worn accessories that cannot maintain 0.39 inches (1 cm) separation distance between the user's body and the back of the phone, and have not been tested for typical body-worn operations may not comply with FCC/IC RF exposure limits and should be avoided.

* FCC Notice & Caution

Notice!

This device complies with part 15 of the FCC Rules. Operation is subject to the following two conditions:

- (1) This device may not cause harmful interference, and
- (2) this device must accept any interference received, including interference that may cause undesired operation.

Caution!

Changes or Modifications that are not specifically approved by the manufacturer could void the user's authority to operate the equipment.

Part 15.105 statement

This equipment has been tested and found to comply with the limits for a Class B digital device, pursuant to part 15 of the FCC Rules. These limits are designed to provide reasonable protection against harmful interference in a residential installation. This equipment generates, uses and can radiate radio frequency energy and, if not installed and used in accordance with the instructions, may cause harmful interference to radio communications. However, there is no guarantee that interference will not occur in a particular installation.

If this equipment does cause harmful interference to radio or television reception, which can be determined by turning the equipment off and on, the user is encouraged to try to correct the interference by one or more of the following measures:

- Reorient or relocate the receiving antenna.
- Increase the separation between the equipment and receiver.
- Connect the equipment into an outlet on a circuit different from that to which the receiver is connected.
- Consult the dealer or an experienced radio/TV technician for help.

Product care and maintenance

- Always use genuine LG batteries, chargers and accessories approved for use with this particular device model. The use of any other types may void any approval or warranty applying to the device and may be dangerous.
- Some contents and illustrations may differ from your device without prior notice.
- Do not disassemble this unit. Take it to a qualified service technician when repair work is required.
- Repairs under warranty, at LG's discretion, may include replacement parts or boards that are either new or reconditioned, provided that they have functionality equal to that of the parts being replaced.
- Keep away from electrical appliances such as TVs, radios and personal computers.

- The unit should be kept away from heat sources such as radiators or cookers.
- Do not drop.
- Do not subject this unit to mechanical vibration or shock.
- Switch off the phone in any area where you are required to by special regulations. For example, do not use your phone in hospitals as it may affect sensitive medical equipment.
- Do not handle the phone with wet hands while it is being charged. It may cause an electric shock and can seriously damage your phone.
- Do not charge a handset near flammable material as the handset can become hot and create a fire hazard.
- Use a dry cloth to clean the exterior of the unit (do not use solvents such as benzene, thinner or alcohol).
- Do not charge the phone when it is on soft furnishings.
- The phone should be charged in a well ventilated area.
- Do not subject this unit to excessive smoke or dust.
- Do not keep the phone next to credit cards or transport tickets; it can affect the information on the magnetic strips.
- Do not tap the screen with a sharp object as it may damage the phone.
- Do not expose the phone to liquid or moisture.
- Use accessories like earphones cautiously. Do not touch the antenna unnecessarily.
- Do not use, touch or attempt to remove or fix broken, chipped or cracked glass. Damage to the glass display due to abuse or misuse is not covered under the warranty.
- Your phone is an electronic device that generates heat during normal operation. Extremely prolonged, direct skin contact in the absence of adequate ventilation may result in discomfort or minor burns. Therefore, use care when handling your phone during or immediately after operation.

- If your phone gets wet, immediately unplug it to dry off completely. Do not attempt to accelerate the drying process with an external heating source, such as an oven, microwave or hair dryer.
- The liquid in your wet phone, changes the colour of the product label inside your phone. Damage to your device as a result of exposure to liquid is not covered under your warranty.

Efficient phone operation

Electronics devices

All mobile phones may receive interference, which could affect performance.

- Do not use your mobile phone near medical equipment without requesting permission. Please consult your doctor to determine if operation of your phone may interfere with the operation of your medical device.
- Some hearing aids might be disturbed by mobile phones.
- Minor interference may affect TVs, radios, PCs etc.
- Use your phone in temperatures between 0 °C and 40 °C, if possible. Exposing your phone to extremely low or high temperatures may result in damage, malfunction, or even explosion.

Pacemakers

Pacemaker manufacturers recommend that a minimum separation of 15 cm be maintained between a mobile phone and a pacemaker to avoid potential interference with the pacemaker. To achieve this use the phone on the opposite ear to your pacemaker and do not carry it in a breast pocket.

Hospitals

Switch off your wireless device when requested to do so in hospitals, clinics or health care facilities. These requests are designed to prevent possible interference with sensitive medical equipment.

Road safety

Check the laws and regulations on the use of mobile phones in the area when you drive.

- Do not use a hand-held phone while driving.
- Give full attention to driving.
- Pull off the road and park before making or answering a call if driving conditions so require.
- RF energy may affect some electronic systems in your vehicle such as car stereos and safety equipment.
- When your vehicle is equipped with an air bag, do not obstruct with installed or portable wireless equipment. It can cause the air bag to fail or cause serious injury due to improper performance.
- If you are listening to music whilst out and about, please ensure that the volume is at a reasonable level so that you are aware of your surroundings. This is of particular importance when near roads.

Avoid damage to your hearing



To prevent possible hearing damage, do not listen at high volume levels for long periods.

Damage to your hearing can occur if you are exposed to loud sound for long periods of time. We therefore recommend that you do not turn on or off the handset close to your ear. We also recommend that music and call volumes are set to a reasonable level.

- When using headphones, turn the volume down if you cannot hear the people speaking near you, or if the person sitting next to you can hear what you are listening to.

NOTE

- Excessive sound pressure from earphones and headphones can cause hearing loss.

Glass Parts

Some parts of your mobile device are made of glass. This glass could break if your mobile device is dropped on a hard surface or receives a substantial impact. If the glass breaks, do not touch or attempt to remove it. Stop using your mobile device until the glass is replaced by an authorised service provider.

Blasting area

Do not use the phone where blasting is in progress. Observe restrictions and follow any regulations or rules.

Potentially explosive atmospheres

- Do not use your phone at a refueling point.
- Do not use near fuel or chemicals.
- Do not transport or store flammable gas, liquid or explosives in the same compartment of your vehicle as your mobile phone or accessories.

In aircraft

Wireless devices can cause interference in aircraft.

- Turn your mobile phone off before boarding any aircraft.
- Do not use it on the ground without permission from the crew.

Children

Keep the phone in a safe place out of the reach of small children. It includes small parts which may cause a choking hazard if detached.

Emergency calls

Emergency calls may not be available on all mobile networks. Therefore you should never depend solely on your phone for emergency calls. Check with your local service provider.

Battery information and care



- You do not need to completely discharge the battery before recharging. Unlike other battery systems, there is no memory effect that could compromise the battery's performance.
- Use only LG batteries and chargers. LG chargers are designed to maximise the battery life.
- Do not disassemble or short-circuit the battery.
- Keep the metal contacts of the battery clean.
- Replace the battery when it no longer provides acceptable performance. The battery pack may be recharged hundreds of times before it needs replacing.
- Recharge the battery if it has not been used for a long time to maximise usability.
- Do not expose the battery charger to direct sunlight or use it in high humidity, such as in the bathroom.
- Do not leave the battery in hot or cold places, as this may deteriorate battery performance.
- Risk of explosion if battery is replaced by an incorrect type. Dispose of used batteries according to the instructions.
- If you need to replace the battery, take it to the nearest authorised LG Electronics service point or dealer for assistance.
- Always unplug the charger from the wall socket after the phone is fully charged to save unnecessary power consumption of the charger.
- Actual battery life will depend on network configuration, product settings, usage patterns, battery and environmental conditions.
- Make sure that no sharp-edged items such as animal's teeth or nails, come into contact with the battery. This could cause a fire.











Special Features

Capture+

You can use Capture+ function to easily and efficiently create memos during a call, with a saved picture or on the current screen.

- 1 Touch and slide the status bar downward and tap .
If you can not see , tap  > checkmark **Capture+** to enable.
- 2 Create a memo using the following options:

	Tap to save the memo you've created.
	Tap to undo the most recent action.
	Tap to redo the most recently deleted action.
	Tap to insert text into your memo.
	Tap to select the pen type and colour.
	Tap to use the eraser to erase the pen marks on the memo.
	Tap to crop the image of memo.
	Tap to select the share or paper style.
	Tap to hide or display the toolbar.

NOTE

- While using the Capture+, use your fingertip, not the fingernail.

- 3 Tap  to save the current memo to  or .

Viewing the saved memo

Tap  >  >  and select the **Capture+** album.

Gesture shot

The Gesture shot feature allows you to take a picture with a hand gesture using the front camera.

Taking the photos with a gesture

There are two methods for using the Gesture shot feature.

- Raise your hand, with an open palm, until the front camera detects it and a box appears on the screen. Then close your hand into a fist to start the timer, allowing you time to get ready.

OR

- Raise your hand, in a clenched fist, until the front camera detects it and a box appears on the screen. Then unclench your fist to start the timer, allowing you time to get ready.

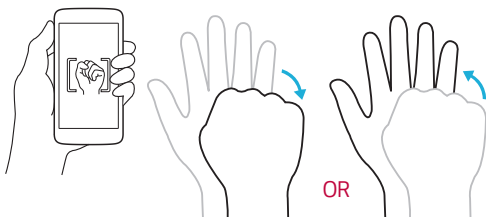



Basics

Accessories

These accessories are available for use with the your device.

- Travel Adaptor
- Quick Start Guide
- Stereo Headset
- USB Cable
- Battery

NOTE

- Items described above may be optional.
- Always use genuine LG accessories. The supplied items are designed only for this device and may not be compatible with other devices.
- The items supplied with the device and any available accessories may vary depending on the region or service provider.

Device layout

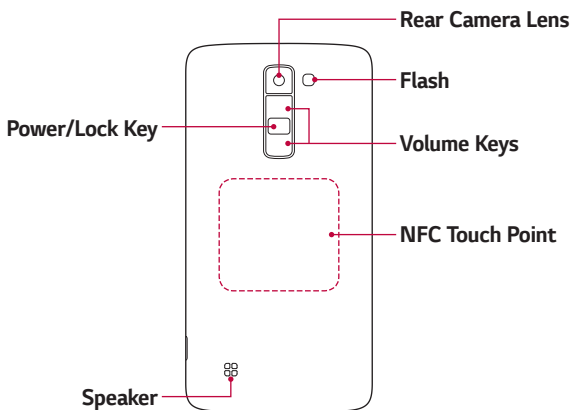
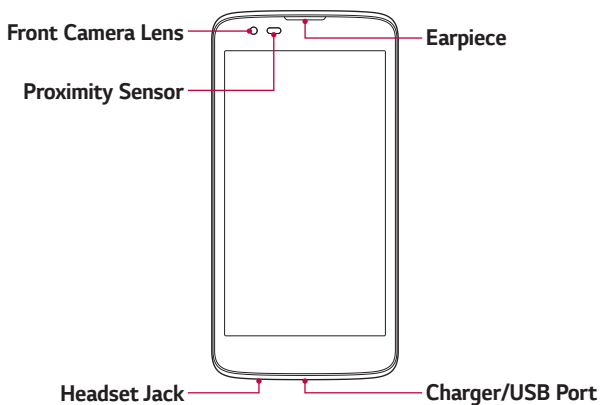

Power/Lock Key	<ul style="list-style-type: none">· Turn your device on/off by pressing and holding this key.· Short press to turn on/off the screen.
Volume Keys	<p>While screen is off:</p> <ul style="list-style-type: none">· Press Volume Up Key twice to launch Capture+.· Press Volume Down Key twice to launch Camera. <p>On the Home screen:</p> <ul style="list-style-type: none">· Control ringer volume. <p>During a call:</p> <ul style="list-style-type: none">· Control your earpiece volume when playing audio/video.· Control volume continuously.

 **NOTE: Proximity Sensor**

- When receiving and making calls, the proximity sensor automatically turns the backlight off and locks the touch screen by sensing when the phone is near your ear. This extends battery life and prevents you from unintentionally activating the touch screen during calls.

 **WARNING**

- Placing a heavy object on the device or sitting on it can damage the display and touch screen functions. Do not cover the proximity sensor with screen protectors or any other type of protective film. This could cause the sensor to malfunction.

 **WARNING**

- The NFC antenna for this model is on the back cover.
- Be careful not to damage the NFC touch point on the phone, which is part of the NFC antenna.

Turning Your Device On and Off

Turning your device on

Press and hold the **Power/Lock Key** on the back of the device for a couple of seconds until the screen turns on.

Turning your device off

- 1 Press and hold the **Power/Lock Key** on the back of the device until the device options menu appears.
- 2 Tap **Power off** > **OK** to confirm that you want to turn off the device.

Installing the SIM card and battery

Insert the SIM card provided by the device service provider, and the included battery.

WARNING

- Do not insert a memory card into the SIM card slot. If a memory card happens to be lodged in the SIM card slot, take the device to a LG Service Centre to remove the memory card.

NOTE

- Only the Nano SIM cards work with the device.

- 1 To remove the back cover, hold the device firmly in one hand. With your other hand, lift off the back cover with your thumbnail as shown in the figure.

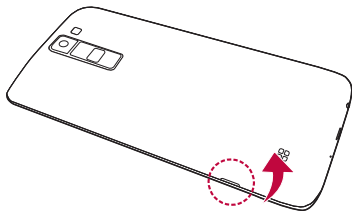

- 2 Slide the SIM card into the SIM card slot as shown in the figure. Make sure the gold contact area on the card is facing downward.

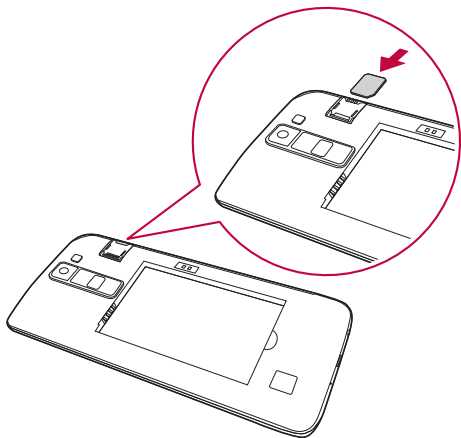

- 3 Insert the battery.

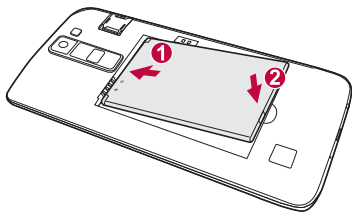

- 4 To replace the cover onto the device, align the back cover over the battery compartment and press it down until it clicks into place.

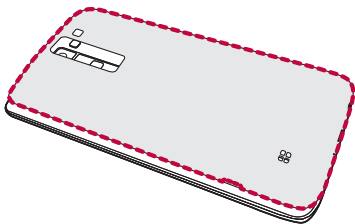

Charging the battery

Charge the battery before using it for first time. Use the charger to charge the battery. A computer can also be used to charge the battery by connecting the device to it using the USB cable.

WARNING

- Use only LG-approved chargers, batteries and cables. If you use unapproved chargers, batteries or cables, it may cause battery charging delay. Or this can cause the battery to explode or damage the device, which are not covered by the warranty.

The charger connector is located at the bottom of the device. Insert the charger and plug it into a power outlet.

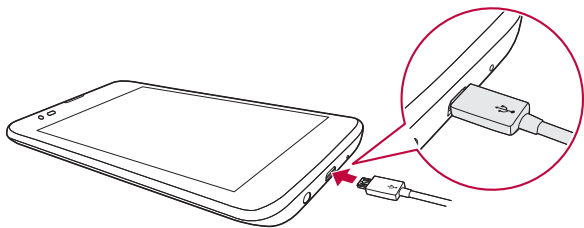

**NOTE**

- Do not open the back cover while your device is charging.

Optimizing battery life

Extend your battery's power by turning off features that you do not need to run constantly in the background. You can monitor how applications and system resources consume battery power.

Extending your device battery life

- Turn off radio communications when you are not using. If you are not using Wi-Fi, Bluetooth® or GPS, turn them off.
- Reduce screen brightness and set a shorter screen timeout.
- Turn off automatic syncing for Gmail, Calendar, Contacts and other applications.
- Some applications you download may consume battery power.
- While using downloaded applications, check the battery charge level.

Inserting the memory card

Your device supports up to a 32GB microSD card. Depending on the memory card manufacturer and type, some memory cards may not be compatible with your device.

WARNING

- Some memory cards may not be fully compatible with the device. If you use an incompatible card, it may damage the device or the memory card, or corrupt the data stored in it.

NOTE

- If you write and erase data too frequently, it will shorten the lifespan of memory cards.



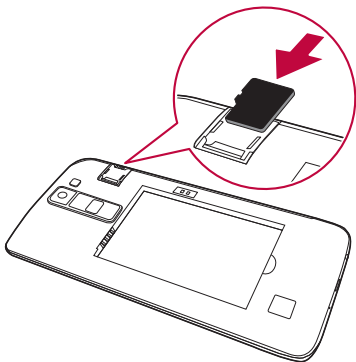

- 1 Remove the back cover.
- 2 Insert a memory card with the gold-coloured contacts facing downwards.



- 3 Replace the back cover.

Removing the memory card

Before removing the memory card, unmount it for safety.

- 1 Tap  >  >  > **General tab** > **Storage & USB** > .
- 2 Remove the back cover and pull out the memory card.

WARNING

- Do not remove the memory card while the device is transferring or accessing information. This behavior can cause data to be lost or corrupted or can damage the memory card or the device. LG is not responsible for losses that result from the abuse or improper use of memory cards, including the loss of data.

Touch screen tips

Here are some tips on how to navigate on your device.

NOTE

- Do not press too hard; the touch screen is sensitive enough to pick up a light, yet firm tap.
- Use the tip of your finger to tap the option you want. Be careful not to tap any other buttons.

Tap or touch

Tap or touch to activate your chosen item, link, shortcut, or letter on the on-screen keyboard.

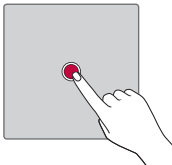

Touch and hold

Touch and hold an item on the screen by tapping it and not lifting your finger until an action occurs.

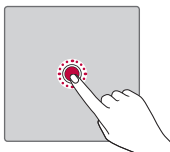

Drag

Touch and hold an item for a moment and then, without lifting your finger, move your finger on the screen until you reach the target position. You can drag items on the Home screen to reposition them.

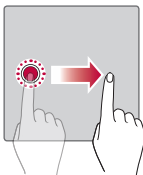

Swipe or slide

To swipe or slide, quickly move your finger across the surface of the screen, without pausing when you first tap it (so you don't drag an item instead).

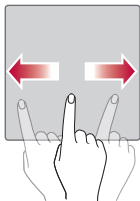

Double-tap

Double-tap to zoom on a webpage or a map.

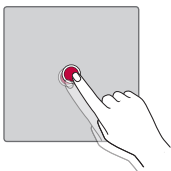

Pinch-to-Zoom

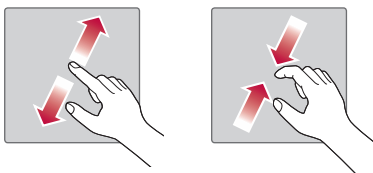

Use your index finger and thumb in a pinching or spreading motion to zoom in or out when using the browser, Maps, or when viewing pictures.





Google account setup

The first time you open a Google application on your device, you will be required to sign in with your existing Google account. If you do not have a Google account, you will be prompted to create one.

Creating your Google account

- 1 Tap  >  >  > **General tab** > **Accounts & sync**.
- 2 Tap **ADD ACCOUNT** > **Google** > **Or create a new account**.
- 3 Enter your first and last name, then tap **NEXT**.
- 4 Enter a username and tap **NEXT**. Your device will communicate with Google servers and check for username availability.
- 5 Enter your password and tap **NEXT**.
- 6 Follow the instructions and enter the required and optional information about the account. Wait while the server creates your account.

Signing into your Google account

- 1 Tap  >  >  > **General tab** > **Accounts & sync**.
- 2 Tap **ADD ACCOUNT** > **Google**.
- 3 Enter your email address and tap **NEXT**.
- 4 Enter your password and tap **NEXT**.
- 5 After signing in, you can use Gmail and take advantage of Google services.

After signing in, your device will sync with your Google services, such as Gmail, Contacts, and Google Calendar. You can also use Maps, download applications from Play Store, back up your settings to Google servers, and take advantage of other Google services on your device.

Locking and unlocking the device

Pressing the Power/Lock Key turns off the screen and puts the device into lock mode. The device automatically gets locked if it is not used for a specified period. This helps to prevent accidental taps and saves battery power.

To unlock the device, press the Power/Lock Key and swipe the screen in any direction.

KnockON

The KnockON feature allows you to double-tap the screen to easily turn it on or off.

Turning the screen on

- 1 Double-tap the centre of the Lock screen to turn the screen on.
- 2 Unlock the screen or access any of the available shortcuts or widgets.

Turning the screen off

- 1 Double-tap an empty area of the Home screen or the status bar.
- 2 The screen will turn off.

NOTE

- For better recognition performance, tap on the centre of the screen, but not on the bottom or on the top of the screen.
- Use the fingertip instead of fingernail to tap the screen for turning it on or off.



Knock Code

The Knock Code feature allows you to create your own unlock code using a combination of knocks on the screen. You can access the Home screen directly when the screen is off by tapping the same sequence on the screen.

NOTE

- If you enter the wrong Knock Code 6 times, it will compulsorily take you to your Google account log in/backup PIN.

Setting up the Knock Code feature



- 1 Tap  >  >  > **Display** tab > **Lock screen** > **Select screen lock** > **Knock Code**.
- 2 Tap the squares in a pattern to set your Knock Code. Your Knock Code pattern can be 6 to 8 taps.

Unlocking the screen using the Knock Code

You can unlock the screen by tapping the Knock Code pattern you already set, when the screen turns off.

Changing the screen lock method

You can change the way that you lock the screen to prevent others accessing your personal information.

- 1 Tap  >  >  > **Display** tab > **Lock screen** > **Select screen lock**.
- 2 Select a desired screen lock from None, Swipe, Knock Code, Pattern, PIN and Password.



NOTE

- Create a Google account before setting an unlock pattern and remember the Backup PIN you created when creating your pattern lock.

Smart Lock

You can use Smart Lock to make unlocking your device easier. You can set it to keep your device unlocked when you have a trusted Bluetooth device connected to it, when it's in a familiar location like your home or work, or when it recognises your face.

Setting up Smart Lock feature

- 1 Tap  >  >  > **Display** tab > **Lock screen** > **Smart Lock**.
- 2 Before you add any trusted devices, trusted places, or trusted face, you need to set up a screen lock (Knock Code, Pattern, PIN or Password).

Home screen

The Home screen is the starting point for many applications and functions. It allows you to add items like app shortcuts and Google widgets to give you instant access to information and applications. This is the default canvas and accessible from any menu by tapping .

Getting to Know the Home Screen



1 **Status Bar**

2 **Widget**

3 **Application Icons**



4 **Location Indicator**

5 **Quick Button Area**

6 **Home Touch Buttons**

- 1 **Status Bar** – Shows the device status information, including the time, signal strength, battery status and notification icons.
- 2 **Widget** – Widgets are self-contained applications that can be accessed through the Apps drawer or on the Home screen. Unlike a shortcut, a Widget can function as an on-screen application.
- 3 **Application Icons** – Tap an icon (application, folder, etc.) to open and use it.
- 4 **Location Indicator** – Indicates which Home screen canvas you are currently viewing.
- 5 **Quick Button Area** – Provides one-touch access to the function in any Home screen canvas.

6 Home Touch Buttons

 Back Button	Returns to the previous screen. Also closes pop-up items, such as menus, dialog boxes and the on-screen keyboard.
 Home Button	Return to the Home screen from any screen.
 Overview Button	Displays recently used applications. If you touch and hold this button, it opens a menu of available options.

Viewing other Home screen panels

The operating system provides multiple Home screen canvases to provide more space for adding icons, widgets and more.

- Slide your finger left or right across the Home screen to access additional canvases.

Returning to recently used applications

Multitasking is easy with Android; you can keep more than one application running at the same time. There is no need to quit an application before opening another. Use and switch between several open applications.

Android manages each application, stopping and starting them as needed to make sure that idle applications don't consume resources unnecessarily.

- 1 Tap . A list of recently used applications will be displayed.
- 2 Tap the application you want to access. This does not stop the previous app from running in the background. Make sure to tap to back out of an app after using it.
 - To close an app from the recent apps list, swipe the app preview to the left or right. To clear all apps, tap **Clear all**.

Customising the Home screen

You can customise your Home screen by adding apps and widgets and changing wallpapers.

Adding items on your Home screen

- 1 Touch and hold the empty part of the Home screen.
- 2 In the Add Mode menu, select the item you want to add. You then see this added item on the Home screen.
- 3 Drag it to the desired location and lift your finger.

NOTE

- To add an application icon to the Home screen from the Apps screen, touch and hold the application you want to add.

Removing an item from the Home screen

While on the Home screen, touch and hold the icon you want to remove, and drag it to .

Adding an app to the Quick Button Area

From the Apps screen or on the Home screen, touch and hold an application icon and drag it to the Quick Button Area. Then release it in the desired location.

Removing an app from the Quick Button Area

Touch and hold the desired Quick Button, drag it to .

NOTE

- The **Apps Button**  cannot be removed.

Customising app icons on the Home screen

- 1 Touch and hold an application icon until it unlocks from its current position, then release it. The editing icon  appears in the upper-right corner of the application.
- 2 Tap the application icon again and select the desired icon design and size.
- 3 Tap **OK** to save the change.

Notifications panel

Notifications alert you to the arrival of new messages, calendar events and alarms, as well as ongoing events, such as when you are on a call.

Opening the notifications panel

Swipe down from the status bar to open the notifications panel. To close the notifications panel, swipe the screen upwards or tap .

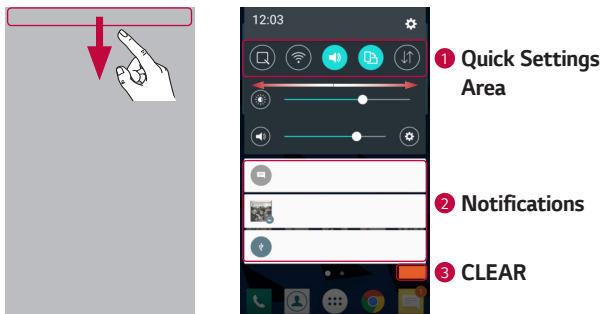

- 1 Tap each quick setting button to toggle it on/off. Touch and hold the desired button to directly access the settings menu for the function. To see more toggle buttons, swipe left or right. Tap  to remove, add or rearrange quick setting buttons.
- 2 Current notifications are listed, each with a brief description. Tap a notification to view it.
- 3 Tap to clear all the notifications.

When a notification arrives, its icon appears at the top of the screen. Icons for pending notifications appear on the left, and system icons, such as Wi-Fi and battery strength are shown on the right.

Indicator icons on the Status Bar

Indicator icons appear on the status bar at the top of the screen to report missed calls, new messages, calendar events, device status and more.

Notification icons

Status icons



The icons displayed at the top of the screen provide information about the status of the device. The icons listed in the table below are some of the most common ones.



Icon	Description
	No SIM card inserted
	No network signal available
	Airplane mode is on
	Connected to a Wi-Fi network
	Wired headset connected
	Call in progress
	Missed call
	Bluetooth is on
	System warning
	An alarm is set
	New voicemail available
	New text or multimedia message

Icon	Description
	A song is currently playing
	Silent mode is on
	Vibrate mode is on
	Battery fully charged
	Battery is charging
	The device is connected to a PC via a USB cable
	Downloading data
	Uploading data
	GPS is on
	Data is synchronizing
	Choose input method
	Wi-Fi hotspot is active

NOTE

- The icon's location in the status bar may differ according to the function or service.
- The available options may vary depending on the region or service provider.





Capturing a screenshot

Press and hold the **Volume Down Key** and the **Power/Lock Key** at the same time for 2 seconds to capture a screenshot of the current screen. To view the captured image, tap  >  >  > **Screenshots** folder.

On-screen keyboard

You can enter text by using the on-screen keyboard. The on-screen keyboard appears on the screen when you tap an available text entry field.

Using the keypad and entering text

Icon	Description
	Tap once to capitalise the next letter you type. Double-tap for all caps.
	Tap to go to the keyboard settings. Touch and hold to enter text by voice or access the clip tray.
	Tap to enter a space.
	Tap to create a new line.
	Tap to delete the previous character.

Entering special characters

The on-screen keyboard allows you to enter special characters.

For example, to input "á", touch and hold the "a" button until the pop-up appears and displays related special characters. Without lifting the finger, drag your finger to the desired special character. Once it's highlighted, lift your finger.



NOTE

- A symbol at the top right corner of a key indicates that additional characters are available for that key.

Transferring data between a PC and the device

You can copy or move data between a PC and the device.

Transferring data using USB connection

- 1 Connect your device to a PC using the USB cable that came with your device.
- 2 Open the Notifications panel, tap the current connection type, and select **Media device (MTP)**.
- 3 A window will pop-up on your PC, allowing you to transfer the desired data.

NOTE

- The LG Android Platform Driver must be installed on your PC to be able to detect the device.
- Check the requirements for using **Media device (MTP)**.

Items	Requirement
OS	Microsoft Windows XP SP3, Vista or higher
Window Media Player version	Windows Media Player 10 or higher

LG Bridge

LG Bridge is an application that helps you conveniently manage images, music, videos, documents, etc. saved on a LG device on your PC. Also, you can back up your files such as contacts and images to your PC or update software of a device.

NOTE

- You can see detailed instructions on how to use LG Bridge in Help menu after installing and opening the program.
- Supported features may vary depending on the device.
- The LG unified USB driver is a program required to connect an LG device to a PC. It is automatically installed when installing LG Bridge.

Features of LG Bridge

- Manage contents from your device on PC via Wi-Fi or data.
- Back up and restore the data of your device via USB.
- Update software of a device on your PC via USB.

To download the LG Bridge software

- 1 Go to www.lg.com.
- 2 Tap the Search button and enter the model name to search for the model.
- 3 Select the model information and click **GO**.
- 4 Scroll down, select the **PC SYNC** tab > **Windows** or **Mac OS** > **DOWNLOAD** to download LG Bridge.

Apps

Installing or uninstalling apps

Play Store allows you to browse and search for free and paid applications.

To open the Play Store app



Tap  >  > .

To open a screen with details about an app

At any time while browsing in Play Store, tap an app to open its details screen.

The App details screen includes a description, ratings, comments, and related information about the app. From this screen, you can download, install, uninstall, rate the app, and more.





To uninstall applications

- 1 Tap  >  >  > **General** tab > **Apps**.
- 2 Once all applications appear, scroll to and select the application you want to uninstall.
- 3 Tap **Uninstall**.

Calls

You can enjoy clear calling across the region.



Making a call

- 1 Tap  > .
- 2 Enter the number by using the dialer. To delete a digit, tap .
- 3 After entering the desired number, tap  to place the call.
- 4 To end the call, tap .



NOTE

- To enter "+" to make international calls, touch and hold .

Calling your contacts

- 1 Tap  > .
- 2 Scroll through the contact list. You can also enter the contact's name in the Search field or scroll along the alphabet letters on the right edge of the screen.
- 3 In the list that is displayed, tap  you want to call.





Answering and rejecting a call

- Swipe  in any direction to answer an incoming call.
- Swipe  in any direction to decline an incoming call.

NOTE

- Swipe  if you want to decline a call and send a message to the caller.



Making a second call

- 1 During your first call, tap  > **Add call** and enter the number.
- 2 Tap . Both calls are displayed on the call screen. Your initial call is locked and put on hold.
- 3 Tap the displayed number to toggle between calls. Or tap  to start a conference call.
- 4 To end all calls, tap .

NOTE

- You are charged for each call you make.

Viewing your call logs



- 1 Tap  >  > **Call logs** tab.
- 2 View a list of all dialed, received and missed calls.

NOTE

- Tap any call log entry to view the date, time and duration of the call.
- Tap  > **Delete all** to delete all of the recorded items.

Change your call settings



You can configure call settings, such as call forwarding, as well as other special features offered by your carrier.

- 1 Tap  > .
- 2 Tap  > **Call settings** and configure the desired options.



Contacts

You can add contacts on your device and synchronise them with the contacts in your Google Account or other accounts that support syncing contacts.

Searching for a contact

- 1 Tap  > .
- 2 Tap **Search contacts** and enter the contact name using the keyboard. Matches are displayed as you begin to type.



Adding a new contact

- 1 Tap  > .
- 2 Enter the new contact's number.
- 3 Tap  > **Add to Contacts** > **New contact**.
- 4 If you want to add a picture to the new contact, tap the image icon. Choose **Take photo** or **Select from Gallery**.
- 5 Enter the desired information for the contact.
- 6 Tap **SAVE**.



Favourites contacts

You can classify frequently called contacts as favourites.



Adding a contact to your favourites

- 1 Tap  > .
- 2 Tap a contact to view its details.
- 3 Tap the star at the top right of the screen. The star turns yellow.

Removing a contact from your favourites list

- 1 Tap  >  > **Favourites** tab.
- 2 Choose a contact to view its details.
- 3 Tap the yellow star at the top right of the screen. The star turns a dark colour and the contact is removed from your favourites.

Creating a group

- 1 Tap  >  > **Groups** tab.
- 2 Tap  > **New group**.
- 3 Enter a name for the new group. You can also set a distinct ringtone for the newly created group.
- 4 Tap **Add members** to add contacts to the group and tap **ADD**.
- 5 Tap **SAVE** to save the group.

NOTE

- If you delete a group, the contacts assigned to that group will not be lost. They will remain in your contact list.

Messaging

Your device combines text and multimedia messaging into one intuitive, easy to use menu.

NOTE

- You may be charged for each message you send. Please consult with your service provider.

Sending a message

1 Tap  >  > .

2 Tap , then select one or more entries from your Contacts list.

OR

Enter a contact name or contact number into the **To** field. As you enter the contact name, matching contacts appear. You can tap a suggested recipient and add more than one contact.

3 Tap the text field and start entering your message.

4 Tap  to open the options menu. Choose from any of the available options.

5 Tap  to attach the file that you want to share with message.

6 Tap **Send** to send your message.

Conversation view

Messages exchanged with another party are displayed in chronological order so that you can conveniently see and find your conversations.



Changing your messaging settings

The messaging settings of your device are predefined to allow you to send messages immediately. You can change the settings based on your preferences.

- Tap  >  >  > **Settings**.

Camera

You can use the camera or camcorder to take and share pictures and videos.







- Tap  >  > .

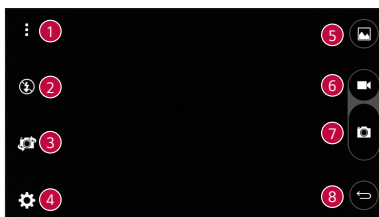

Taking a photo

- 1 Frame your subject on the screen.
- 2 A square around the subject indicates that the camera has focused.
- 3 Tap  to take a photo. Your picture will be automatically saved to the Gallery.

Camera options on the viewfinder



1		Tap to hide/display the camera options on the viewfinder.
2		Tap to manage the camera's flash.
3		Tap to swap between the rear camera lens and the front camera lens.
4		Tap to open the camera settings menu.
5		Tap to view the last photo or video you recorded.
6		Tap to start recording.







7		Tap to take a photo.
8		Tap to exit the camera.

NOTE

- Be sure to clean the protective lens cover with a microfiber cloth before taking pictures. A lens cover with smudges from fingers can cause blurry pictures with a "halo" effect.







Using the advanced settings

In the camera viewfinder, tap  to show the advanced options. Tap each icon to adjust the following camera settings.





	Tap to set the ratio of your picture and the quality of video.
	Tap to activate the camera shutter by voice command. When on, you just say " Cheese ", " Smile ", " LG ", etc. to take a picture.
	Tap to set your camera's timer. This is ideal if you want to be a part of the picture or video.
	Tap to take better pictures and record better videos by displaying a grid line for help with alignment.
	Tap to set the storage location for your pictures and videos. Choose from IN (internal memory) and SD (memory card). This menu appears only when the SD card is inserted.
	Tap to learn how a function works. This icon will provide you with a help guide.

Once you have taken a photo

Tap the image thumbnail on the screen to view the last photo you took.



	Tap to edit the photo.
	Tap to take another photo immediately.
	Tap to open the available sharing options.
	Tap to delete the photo.
	Tap to access additional options.
	Tap to add the photo to your favourites.

Recording a video

- 1 Tap  >  > .
- 2 Frame your subject on the screen.
- 3 Tap  to start recording the video. The length of the recording is displayed on the top of the screen.

NOTE

- Tap  to take pictures while recording video.





- 4 Tap  to pause recording video. You can resume recording by tapping .

OR

Tap  to stop recording. Your video will be automatically saved to the Gallery.



After recording a video

Tap the video thumbnail on the screen to view the last video you recorded.

	Tap to record another video immediately.
	Tap to open the available sharing options to share.
	Tap to delete the video.
	Tap to access additional options.
	Tap to add the video to your favourites

Gallery

The Gallery application presents the pictures and videos in your storage, including those you've taken with the Camera application and those you downloaded from the web or other locations.

- 1 Tap  >  > .
- 2 Tap an album to open it and view its contents. The pictures and videos in the album are displayed in chronological order.
- 3 Tap a picture in an album to view it.

NOTE

- Depending on the software installed, some file formats may not be supported.
- Some files may not play properly due to their encoding.
- If the file size exceeds the available memory, an error can occur when you open files.

Viewing pictures

The Gallery displays your pictures in folders. When an application, such as E-mail, saves a picture, the download folder is automatically created to contain the picture. Likewise, capturing a screenshot automatically creates the Screenshots folder.

Pictures are displayed by the date they were created. Select a picture to view it full screen. Scroll left or right to view the next or previous image.

Editing photos

While viewing a photo, tap .

Setting wallpaper



While viewing a photo, tap  > **Set image as** to set the image as wallpaper or assign it to a contact.

Zooming in and out

Use one of the following methods to zoom in on an image:





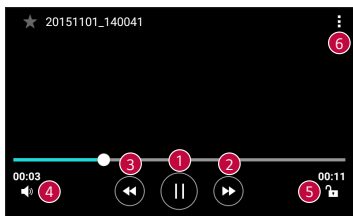

- Double-tap anywhere to zoom in.
- Spread two fingers apart on any place in the picture zoom in. Pinch in or double-tap the image to zoom out.

Playing a video

- 1 Tap  >  > .
- 2 Select the video you want to watch.

Video options





1		Tap to pause/resume video playback.
2		Touch and hold to fast-forward incrementally. Tap to fast-forward 10 seconds.
3		Touch and hold to rewind incrementally. Tap to rewind 10 seconds.
4		Tap to adjust the video volume.
5		Tap to lock/unlock the screen.
6		Tap to access additional options.

NOTE

- While playing a video, slide the right side of the screen up or down to adjust the sound.
- While playing a video, slide the left side of the screen up or down to adjust the brightness.
- While playing a video, slide your finger from left to right (or vice versa) to fast-forward and rewind.



Deleting photos/videos

Use one of the following methods:

- While in a folder, tap , select the photos/videos and then tap **DELETE**.
- While viewing a photo, tap .



E-mail

You can use the Email application to read email from providers other than Gmail. The Email application supports the following account types: POP3, IMAP, Microsoft Exchange (for Enterprise users) and other accounts.

- Tap  >  > .

Adding an account

The first time you open the Email application, a setup wizard opens to help you add an email account. You can also add your email account using the **Settings** app.



- Tap  >  >  > **General** tab > **Accounts & sync** > **ADD ACCOUNT** > **E-mail**.

Working with account folders

- Tap  > **Show all folders**.

Each account has Inbox, Sent, Drafts and Show all folders. Depending on the features supported by your account's service provider, you may have additional folders.



Composing and sending email

- 1 Tap .
- 2 Enter an address for the message's intended recipient. As you enter text, matching addresses will be offered from your contacts. Separate multiple addresses with semicolons.
- 3 Tap the **Cc/Bcc** field to copy or blind copy to other contacts/email addresses.
- 4 Tap the text field and enter your message.
- 5 Longpress the text field to edit selected words (Bold/Italic/Underline/Colour).
- 6 Tap  to attach the file you want to send with your message.
- 7 Tap  to send the message.

Changing an email general settings

- Tap  > **Settings** > **General settings**.

Deleting an email account

- Tap  > **Settings** >  > **Remove account** > Select the account to delete > **REMOVE** > **YES**.



Music

Your device has a music player that lets you play all your favourite tracks.

NOTE







- Depending on the software installed, some file formats may not be supported.
- If the file size exceeds the available memory, an error can occur when you open files.
- Music file copyrights may be protected by international treaties and national copyright laws. Therefore, it may be necessary to obtain permission or a licence to reproduce or copy music. In some countries, national laws prohibit private copying of copyrighted material. Before downloading or copying the file, please check the national laws of the relevant country concerning the use of such material.

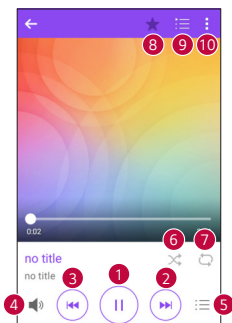



Playing a song

- 1 Tap  >  > .
- 2 Select a music category tab at the top of the screen.
- 3 Tap the song you want to play.

Music player options





1		Tap to pause playback.
		Tap to resume playback.
2		Tap to skip to the next track in the album, playlist or shuffle list. Touch and hold to fast-forward.
3		Tap to restart the current track or skip to the previous track in the album, playlist or shuffle list. Touch and hold to rewind.
4		Tap to adjust the volume.
5		Tap to open the music library.
6		Tap to play the current playlist in shuffle mode (tracks are played in random order).

7		Tap to toggle through repeat all songs, repeat current song and repeat off.
8		Tap to add the song to your favourites.
9		Tap to open the current playlist.
10		Tap to access additional options.

Clock

The Clock app gives you access to the Alarms, Timer, World clock and Stopwatch functions. Access these functions by tapping the tabs across the top of the screen or swiping horizontally across the screen.

- Tap  >  > .

Alarms

The Alarms tab allows you to set alarms.

- 1 Tap **Alarms** tab.
- 2 Tap  to add a new alarm.
- 3 Adjust the settings as necessary and tap **SAVE**.

NOTE

- You can also tap an existing alarm to edit it.

Timer

The Timer tab can alert you with an audible signal when a set amount of time has passed.

- 1 Tap **Timer** tab.
- 2 Set the desired time on the timer.
- 3 Tap **Start** to start the timer.
- 4 Tap **Stop** to stop the timer.

World clock

The World clock tab allows you to easily check the current time in other cities around the world.

- 1 Tap **World clock** tab.
- 2 Tap  and select the desired city.



Stopwatch

The Stopwatch tab allows you to use your device as a stopwatch.

- 1 Tap **Stopwatch** tab.
- 2 Tap **Start** to initiate the stopwatch.
 - Tap **Lap** to record lap times.
- 3 Tap **Stop** to stop stopwatch.

Calculator

The Calculator app allows you to perform mathematical calculations using a basic or scientific calculator.





- 1 Tap  >  > .
- 2 Tap the number buttons to enter numbers.
- 3 For simple calculations, tap the function you want to perform (+, -, x or ÷) followed by =.

NOTE

- For more complex calculations, tap .



Calendar

The Calendar app allows you to track your schedule of events.

- 1 Tap  >  > .
- 2 Select a data and then tap .
- 3 Enter event details and tap **SAVE**.

Tasks







You can register tasks to your device to easily manage schedules.

- 1 Tap  >  > **Tasks**.
- 2 Tap  to add a task.
- 3 Enter task details and then tap **SAVE**.

Voice Recorder

The Voice Recorder app records audible files for you to use in a variety of ways.

Recording a sound or voice



- 1 Tap  >  > .
- 2 Tap  to begin recording.
- 3 Tap  to end the recording.
- 4 Tap  to listen to the recording.

NOTE

- Tap  to access your recordings. You can listen to your saved recordings.



Downloads

Use this application to see what files have been downloaded through the applications.

- Tap  >  > .

FM Radio

Your device has a built-in FM Radio so you can tune in to your favourite stations and listen on the go.

- Tap  >  > .

NOTE

- You must plug in your earphones in order to use them as an antenna.

LG Backup

About backing up and restoring device data

It is recommended that you regularly create and save a backup file on the internal storage, especially before updating any software. Maintaining a current backup file in storage memory may allow you to recover device data if your device is lost, stolen, or corrupted by an unforeseen issue.

This LG Backup application is supported LG device, other software or operating system versions. As a result, when you buy the new LG device, you can backup the current device data to your new device.

If you have the LG Backup application preloaded on your device, you can backup and restore most of your data, including downloaded and pre-installed applications, bookmarks, calendar entries, contacts, home screen settings, and system settings.

WARNING

- To protect against an unexpected power off during backup or restore operations, due to insufficient battery power, you should always keep your battery fully charged.

NOTE

- All files that are stored on your device are deleted before the backup file is restored. Make sure to copy the backup file to another location.
- Please note that your device data will be overwritten with the content of your backup.

To backup your device data

1 Tap  >  > .

2 Select the desired options.

- **Copy data between devices** – Copy data from old device to new device.
- **Back up & restore** – Back up data or restore from backup.

Google apps

Google provides entertainment, social network, and business apps. You may require a Google account to access some apps.

To view more app information, access each app's help menu.

NOTE

- Some apps may not be available depending on the region or service provider.

Google

Search quickly for items on the Internet or your device.

Chrome

Search for information and browse webpages.

Gmail

Send or receive emails via the Google Mail service.

Maps

Find your location on the map, search for locations, and view location information for various places.

YouTube

Watch or create videos and share them with others.

Drive

Store your content on the cloud, access it from anywhere, and share it with others.

Play Music

Discover, listen to, and share music on your device.

Play Movies & TV

Watch videos stored on your device and download various content to watch from the Play Store.

Hangouts

Chat with your friends individually or in groups and use images, emoticons, and video calls while you are chatting.

Photos

Manage photos, albums, and videos that you have saved on the device and uploaded to Google+.

Voice Search

Search quickly for items by saying a keyword or phrase.

Settings



Access the Settings menu

The Settings app allows you to customise and personalise your device.

Opening the settings app

- Tap  > touch and hold  > **System settings**.

OR

- Tap  >  > .

Viewing settings

Tap  to switch the view mode.

- **List view** – Scroll up and down through the list.
- **Tab view** – Swipe left and right or tap the tab you want.

NOTE

- The instructions to perform tasks in this guide are based on the default view setting.

Networks Settings

Wi-Fi

You can use high-speed Internet access while within the coverage of the wireless access point (AP).

On the **Settings** screen, tap **Networks** tab > **Wi-Fi**.

- 1 Tap  to turn Wi-Fi on and start scanning for available Wi-Fi networks.
- 2 Tap a network to connect to it.
 - If the network is secured with a lock icon, you will need to enter a security key or password.
 - The status bar displays icons that indicate Wi-Fi status.

NOTE

- If you are out of the Wi-Fi zone or have set Wi-Fi to Off, the device may automatically connect to the Web using data, which may incur data charges.

Wi-Fi Direct

Wi-Fi Direct provides a direct connection between Wi-Fi enabled devices without requiring an access point.

- Tap  > **Advanced Wi-Fi** > **Wi-Fi Direct**.

NOTE

- When in this menu, your device is visible to other visible Wi-Fi Direct devices nearby.

Bluetooth

Bluetooth is a short-range communications technology that allows you to connect wirelessly to a number of Bluetooth devices, such as headsets and hands-free car kits, and Bluetooth-enabled handhelds, computers, printers, and wireless devices.

NOTE

- LG is not responsible for the loss, interception or misuse of data sent or received via the Bluetooth feature.
- Always make sure that you share and receive data with devices that are trusted and properly secured.
- If there are obstacles between the devices, the operating distance may be reduced.
- Some devices, especially those that are not tested or approved by Bluetooth SIG, may be incompatible with your device.

Pairing your device with another Bluetooth device

- 1 On the **Settings** screen, tap **Networks** tab > **Bluetooth**.
- 2 Tap  to turn Bluetooth on and start scanning for available Bluetooth devices.
 - If you want to detect the visible devices in range additionally, tap **SEARCH**.
- 3 Choose the device you want to pair with from the list. Once the pairing is successful, your device connects to the other device.

NOTE

- Pairing between two Bluetooth devices is a one-time process. Once a pairing has been created, the devices will continue to recognise their partnership and exchange information.
- Please consult documentation included with Bluetooth device for information on pairing mode and passcode (typically 0 0 0 0 – four zeroes).

Sending data via Bluetooth

- 1 Select a file or item such as a contact or media file.
- 2 Select the option for sending data via Bluetooth.
- 3 Search for and pair with a Bluetooth-enabled device.

NOTE

- Due to different specifications and features of other Bluetooth-compatible devices, display and operations may be different, and functions such as transfer or exchange may not be possible with all Bluetooth compatible devices.

Receiving data via Bluetooth

- 1 On the **Settings** screen, tap **Networks** tab > **Bluetooth**.
- 2 Tap  to turn Bluetooth on.
- 3 You will receive a request to accept a pairing attempt from the sending device. Be sure to select **ACCEPT**.

Mobile data

Displays the data usage and device data usage limit.

- Tap  to toggle your device data connection On or Off. This allows you to manage your device data usage. You can use a Wi-Fi network connection for data instead.

Call

Allows you to configure various call settings.

On the **Settings** screen, tap **Networks** tab > **Call**.

- **Voicemail** – Allows you to select your carrier's voicemail service.
- **Fixed dialing numbers** – Allows you to manage and compile a list of numbers that can be called from your device. You need your PIN2, which is available from your operator. If activated, only numbers in the fixed dial list can be called from your device.
- **Incoming voice call pop-up** – Displays a pop-up for an incoming call when an app is in use.
- **Call reject** – Allows you to set the call decline function.
- **Decline with message** – When you want to decline a call, you can send a quick message using this function. This is useful if you need to decline a call during a meeting.
- **Call forwarding** – Allows you to choose when to forward calls.
- **Auto answer** – Set the time before a connected hands-free device automatically answers an incoming call.
- **Connection vibration** – Vibrates your device when the other party answers the call.
- **Save unknown numbers** – Allows you to add unknown numbers to contacts after a call.
- **Power key ends call** – Allows you to use the Power key to end calls.
- **Silence incoming calls** – Enable to allow you to flip the device to silence incoming calls.
- **Call barring** – Locks incoming, outgoing or international calls.
- **Call duration** – Allows you to view the call duration for various types of calls.
- **Additional settings** – Allows you to change the following settings such as **Caller ID** or **Call waiting**, etc.

NFC

Your phone is an NFC-enabled cell mobile phone. NFC (Near Field Communication) is a wireless connectivity technology that enables two-way communication between electronic devices. It operates over a distance of a few centimetres. You can share your content with an NFC tag or another NFC support device by simply tapping it with your device. If you tap an NFC tag with your device, it displays the tag content on your device.

On the **Settings** screen, tap **Networks** tab > **Share & connect** > **NFC**.

- 1 Tap  to turn NFC on.
- 2 Allows you to send or receive files simply by bringing your phone and another data compatible device together (typically within 20mm of each other) at the NFC touchpoint.
 - **Tap & pay** – When NFC is turned on, you can use the Tap & pay feature to pay for items just by touching your phone to a reader at a register. If your phone doesn't have a default app, you can browse Google Play Store for other payment apps.

Android Beam

When this feature is turned on, you can transfer app content to another NFC-capable device by holding the devices close together. Just bring the device together (typically back to back) and then tap your screen. The app determines what gets beamed.

On the **Settings** screen, tap **Networks** tab > **Share & connect** > **Android Beam**.

- 1 Tap  to turn Android Beam on (Turn on Android Beam on each device).
- 2 Select the screen or files to share (e.g. images from Gallery).
- 3 Hold devices together.
- 4 Tap the screen that you want to send after shrinking the screen (Each app determines what is sent or received).

Printing

Allows you to print the content of certain screens (such as web pages displayed in Chrome) to a printer connected to the same Wi-Fi network as your Android device.

On the **Settings** screen, tap **Networks** tab > **Share & connect** > **Printing**.

Printing via wireless printer

- 1 Select the content such as images or documents.
- 2 Tap  > **Print** >  > **All printers...**, and then select a printer.

USB tethering

Allows you to share the internet connection with your computer via a USB cable.

- 1 Connect your device to your PC with a USB cable.
- 2 On the **Settings** screen, tap **Networks** tab > **Tethering**.
- 3 Tap  to turn USB tethering on.

Wi-Fi hotspot

You can also use your device to provide a device broadband connection. Create a hotspot and share your connection.

On the **Settings** screen, tap **Networks** tab > **Tethering**.

- 1 Tap  to turn Wi-Fi hotspot on.
- 2 Tap Set up Wi-Fi hotspot to change the SSID, security type, password, and other hotspot options.

Bluetooth tethering

Allows you to connect to other devices via Bluetooth.

- On the **Settings** screen, tap **Networks** tab > **Tethering**.
- Tap  to turn Bluetooth tethering on to share your connection via Bluetooth tethering.

Airplane mode

Allows you to use many of your device features, such as games, and music, when you are in an area where making or receiving calls or data use is prohibited. When you set your device to Airplane Mode, it cannot send or receive any calls or access online data.

On the **Settings** screen, tap **Networks** tab > **More** > **Airplane mode**.

Mobile networks

This menu allows you to configure various device network settings.

On the **Settings** screen, tap **Networks** tab > **More** > **Mobile networks**.

VPN

From your device, you can add, set up, and manage virtual private networks (VPNs) that allow you to connect and access resources inside a secured local network, such as your corporate network.

On the **Settings** screen, tap **Networks** tab > **More** > **VPN**.

Sound & notification settings

Allows you to change settings for various sounds on the device.

On the **Settings** screen, tap **Sound & notification** tab.

- **Sound profile** – Allows you to set your device sound profile.
- **Volume** – Adjust the device volume settings to suit your needs and environment.
- **Ringtone** – Allows you to set the ringtones for calls. You can also add and delete ringtones.
- **Ringtone ID** – Allows you to compose ringtones based on phone number of incoming call.
- **Sound with vibration** – Enable to set the device to vibrate in addition to the ringtone when you receive calls.
- **Vibration type** – Allows you to choose the type of vibration.

- **Do not disturb** – Allows you to set a schedule when to prevent interruptions from notifications. You can set to allow certain features to interrupt when Priority only is set.
- **Lock screen** – Allows you to choose if you want to show or hide notifications on the lock screen.
- **Apps** – Allows you to set notifications for individual apps including setting as priority and preventing them from displaying notifications.

More settings

Allows you to set other sound & notification settings.

On the **Settings** screen, tap **Sound & notification** tab > **More**.

- **Notification sound** – Allows you to set the notification sound. You can also add and delete notification sounds.
- **Vibrate on tap** – Enable to vibrate when tapping the Home touch buttons and during other UI interactions.
- **Sound effects** – This menu lets you select whether you hear tones when tapping numbers on the dial pad, selecting on-screen options, and more.
- **Message/call voice notifications** – Allows your device to read out incoming calls and message events automatically.

Display settings

Home screen

Allows you to set your home screen settings.

On the **Settings** screen, tap **Display** tab > **Home screen**.

- **Select Home** – Select the desired Home theme.
- **Theme** – Sets the screen theme for your device. You can download new themes from LG SmartWorld.
- **Wallpaper** – Sets the wallpaper to use on your Home screen.

- **Screen swipe effect** – Choose the desired type of effect to display when you swipe from one Home screen canvas to the next.
- **Allow Home screen looping** – Enable to allow continuous Home screen scrolling (loop back to first screen after last screen).
- **Help** – Displays help information for the Home screen.

Lock screen

Allows you to set your lock screen settings.

On the **Settings** screen, tap **Display** tab > **Lock screen**.

- **Select screen lock** – Allows you to set a screen lock type to secure your device.
- **Smart Lock** – Sets to keep your device unlocked with trusted device or a place. If you need more information, please refer to **Smart Lock** section in **Locking and unlocking the device**.
- **Wallpaper** – Select the wallpaper to display for your lock screen.
- **Shortcuts** – Allows you to choose the shortcuts available on the lock screen.
- **Contact info for lost phone** – Allows you to display the owner information on the lock screen in case the device is lost.
- **Lock timer** – Allows you to set the amount of time before the screen automatically locks after the screen has timed-out.
- **Power key instantly locks** – Checkmark to instantly lock the screen when the Power/Lock Key is pressed. This setting overrides the lock timer setting.

Home touch buttons

Set the Home touch buttons displayed at the bottom of all screens. Set which buttons are displayed, their position on the bar and what they look like.

On the **Settings** screen, tap **Display** tab > **Home touch buttons**.

More display settings

Allows you to set other display settings.

On the **Settings** screen, tap **Display** tab.

- **Font type** – Select the desired font type.
- **Font size** – Select the desired font size.
- **Brightness** – Adjust the screen brightness by using the slider.
- **Auto-rotate screen** – Set to switch orientation automatically when you rotate the device.
- **Screen timeout** – Set the time delay before the screen automatically turns off.
- **Daydream** – Select the screen saver to be displayed when the device is sleeping while docked and/or charging.
- **Motion sensor calibration** – Allows you to improve the accuracy of the tilt and speed of the sensor.

General settings

Language & keyboard

Allows you to change the text input settings.

Select the language for the text on your device and for configuring the on-screen keyboard, including words that you've added to its dictionary.

On the **Settings** screen, tap **General** tab > **Language & keyboard**.

- **Language** – Choose a language to use on your device.
- **Current keyboard** – Allows you to select the current keyboard type.
- **LG Keyboard** – Change the LG Keyboard settings.
- **Google voice typing** – Change the voice input settings.
- **Text-to-speech output** – Tap to set the preferred engine or general settings for text-to-speech output.
- **Pointer speed** – Adjust the pointer speed.
- **Reverse buttons** – Reverse the mouse buttons to use primary button on right.

Location

Turn on location service, your device determines your approximate location using Wi-Fi and device networks. When you select this option, you're asked whether you consent to allowing Google to use your location when providing these services.

On the **Settings** screen, tap **General** tab > **Location**.

- **Mode** – Sets the how your current location information is determined.
- **Camera** – Enable to tag photos or videos with their locations.
- **Google Location History** – Allows you to choose your location information settings as accessed by Google and its products.

Accounts & sync

Use this menu to add, remove, and manage your Google and other supported accounts. You also use these settings to control how and whether all applications send, receive, and sync data on their own schedules and whether all applications can synchronise user data automatically.

Gmail™, Calendar, and other applications may also have their own settings to control how they synchronise data; see the sections on those applications for details.

On the **Settings** screen, tap **General** tab > **Accounts & sync**.

- **Auto-sync data** – Enable this option to automatically sync all accounts you've added on your device.
- **ACCOUNTS** – Displays all of your added accounts. Tap one to view and/or manage it.
- **ADD ACCOUNT** – Tap to add new account.

Accessibility

Use the Accessibility settings to configure accessibility plug-ins you have installed on your device.

On the **Settings** screen, tap **General** tab > **Accessibility**.

- **Vision** – Sets options for people with impaired sight.
 - **TalkBack** – Allows you to set up the TalkBack function which assists people with impaired vision by providing verbal feedback.
 - **Message/call voice notifications** – Enable to allows you to hear automatic spoken alerts for incoming calls and messages.
 - **Screen shade** – Enable to set the screen to a darker contrast.
 - **Font size** – Sets the font size.
 - **Touch zoom** – Allows you to zoom in and out by triple-tapping the screen.
 - **Screen colour inversion** – Enable to invert the colours of the screen and content.
 - **Screen colour filter** – Allows you to change the colours of screen and content.
 - **Power key ends call** – Enable so that you can end voice calls by pressing the Power/Lock Key.
- **Hearing** – Sets options for people with impaired hearing.
 - **Captions** – Allows you to customise caption settings for those with hearing impairments.
 - **Flash alerts** – Enable to set the flash to blink for incoming calls and notifications.
 - **Turn off all sounds** – Enable to turn off all device sounds.
 - **Audio type** – Sets the audio type.
 - **Sound balance** – Sets the audio route. Move the slider on the slide bar to set it.

- **Motor & cognition** – Sets options for people with impaired motor skills.
 - **Touch feedback time** – Sets the touch feedback time.
 - **Touch assistant** – Show a touch board with easy access to common actions.
 - **Screen timeout** – Sets the amount of time before the backlight turns off automatically.
 - **Touch control areas** – Allows you to select an area of the screen to limit touch activation to just that area of the screen.
- **Accessibility features shortcut** – Allow you to access selected features quickly when triple-tapping the Home button.
- **Auto-rotate screen** – Enable to allow the device to rotate the screen depending on the physical device orientation (portrait or landscape).
- **Switch Access** – Allows you to interact with your device using one or more switches that work like keyboard keys. This menu can be helpful for users with mobility limitations that prevent them from interacting directly with your device.

Shortcut key

Get quick access to apps by pressing the **Volume Keys** when the screen is off or locked.

On the **Settings** screen, tap **General** tab > **Shortcut key**.

- Press **Volume Up Key** twice to launch Capture+.
- Press **Volume Down Key** twice to launch Camera and take a picture.

Google

Use Google Settings to manage your Google apps and account settings.

On the **Settings** screen, tap **General** tab > **Google**.

Security

Use this menu to configure how to help secure your device and its data.

On the **Settings** screen, tap **General** tab > **Security**.

- **Content lock** – Select lock types to lock memos for QuickMemo+.
- **Encrypt phone** – Allows you to encrypt data on the device for security. You will be required to enter a PIN or password to decrypt your device each time you power it on.
- **Encrypt SD card storage** – Encrypt SD card storage and keep data unavailable for other devices.
- **Set up SIM card lock** – Sets the PIN to lock your SIM card and allows you to change the PIN.
- **Password typing visible** – Enable to briefly show each character of passwords as you enter them so that you can see what you enter.
- **Phone administrators** – View or deactivate device administrators.
- **Unknown sources** – Allow installation of non-Play Store applications.
- **Verify apps** – Disallow or warn before installation of apps that may cause harm.
- **Storage type** – Displays the current storage type.
- **Certificate management** – Allows you to manage your security certificates.
- **Trust agents** – Select apps to use without unlocking screen.
- **Screen pin** – You can enable your device to only show a certain app's screen using screen pin.
- **Usage access for apps** – Allows you to view usage information of apps on your device.

Date & time

Set your preferences for how the date and time is displayed.

On the **Settings** screen, tap **General** tab > **Date & time**.

Storage & USB

You can monitor the used and available internal memory in the device. On the **Settings** screen, tap **General** tab > **Storage & USB**.

DEVICE STORAGE

- **Internal storage** – Displays the total amount of space and the used space in your device internal memory in text and with a bar graph (unused space is gray). Tap to view the corresponding apps and the amount of space they use.

PORTABLE STORAGE

Displays the total amount of space and the used space in your memory card.

Battery & power saving

Displays the current battery status including the percentage of remaining charge and charging state.

On the **Settings** screen, tap **General** tab > **Battery & power saving**.

- **Battery usage** – Displays the battery usage level and battery use details. Tap one of the items to see more detailed information.
- **Battery percentage on status bar** – Checkmark to display the battery level percentage on the status bar next to the Battery icon.
- **Battery saver** – Tap the Battery Saver switch to toggle it on or off. Sets the battery charge percent level that automatically turns on Battery Saver.

Memory

You can monitor the memory used averagely and the memory used by apps in the device.

On the **Settings** screen, tap **General** tab > **Memory**.

Apps

Allows you to view details about the apps installed on your device, manage their data, and force them to stop.

On the **Settings** screen, tap **General** tab > **Apps**.

Default message app

This menu allows you to choose what messaging app to use as your default messaging app.

On the **Settings** screen, tap **General** tab > **Default message app**.

Backup & reset

Change the settings for managing your settings and data.

On the **Settings** screen, tap **General** tab > **Backup & reset**.

- **LG Backup** – Backs up all information on the device and restores it in the event of data loss or replacement. If you need more information, please refer to **LG Backup** section in **Apps**.
- **Back up my data** – Back up app data, Wi-Fi passwords, and other settings to Google servers.
- **Backup account** – Displays the account that is currently being used to back up information.
- **Automatic restore** – When reinstalling an app, restore backed up settings and data.
- **Network settings reset** – Reset all network settings.
- **Factory data reset** – Reset your settings to the factory default values and delete all your data. If you reset the device this way, you are prompted to re-enter the same information as when you first started Android.

About phone

View legal information, check device status and software versions, and perform a software update.

On the **Settings** screen, tap **General** tab > **About phone**.



Appendix

Device software update

LG device software update from the Internet

For more information about using this function, please visit <http://www.lg.com/common/index.jsp> → select your country and language.

This feature allows you to conveniently update the firmware on your device to a newer version from the Internet without needing to visit a service centre. This feature will only be available if and when LG makes a newer firmware version available for your device.

Because the device firmware update requires the user's full attention for the duration of the update process, please make sure you check all instructions and notes that appear at each step before proceeding. Please note that removing the USB data cable during the upgrade may seriously damage your device.

NOTE

- LG reserves the right to make firmware updates available only for selected models at its own discretion and does not guarantee the availability of the newer version of the firmware for all handset models.

LG device software update via Over-the-Air (OTA)

This feature allows you to conveniently update your device software to a newer version via OTA, without connecting using a USB data cable. This feature will only be available if and when LG makes a newer firmware version available for your device.

You should first check the software version on your device:

Settings > General tab > About phone > Update Center > Software Update > Check now for update.



 **NOTE**

- Your personal data from internal device storage—including information about your Google account and any other accounts, your system/application data and settings, any downloaded applications and your DRM licence—might be lost in the process of updating your device software. Therefore, LG recommends that you backup your personal data before updating your device software. LG does not take responsibility for any loss of personal data.
- This feature depends on your network service provider, region and country.

FAQ

This chapter lists some problems you might encounter when using your device. Some problems require you to call your service provider, but most are easy to fix yourself.

Message	Possible causes	Possible corrective measures
SIM card error	There is no SIM card in the device or it is inserted incorrectly.	Make sure that the SIM card is correctly inserted.
No network connection/ Dropped network	Signal is weak or you are outside the carrier network.	Move toward a window or into an open area. Check the network operator coverage map.
	Operator applied new services.	Check whether the SIM card is more than 6~12 months old. If so, change your SIM card at your network provider's nearest branch. Contact your service provider.

Message	Possible causes	Possible corrective measures
Codes do not match	To change a security code, must need to confirm the new code by re-entering it.	If you forget the code, contact your service provider.
	The two codes you entered do not match.	
No applications can be set	Not supported by service provider or registration required.	Contact your service provider.
Downloaded application causes a lot of errors.	Remove the application.	<ol style="list-style-type: none"> 1 Tap  >  > . 2 Tap General tab > Apps. 3 Tap the app > Uninstall.
Calls not available	Dialing error	New network not authorised.
	New SIM card inserted.	Check for new restrictions.
	Pre-paid charge limit reached.	Contact service provider or reset limit with PIN2.
Device cannot be turned on	On/Off key pressed too briefly.	Press the On/Off key for at least two seconds.
	Battery is not charged.	Charge battery. Check the charging indicator on the display.

Message	Possible causes	Possible corrective measures
Charging error	Battery is not charged.	Charge battery.
	Outside temperature is too hot or cold.	Make sure device is charging at a normal temperature.
	Contact problem	Check the charger and its connection to the device.
	No voltage	Plug the charger into a different outlet.
	Charger defective	Replace the charger.
	Wrong charger	Use only original LG accessories.
Number not allowed.	The Fixed dialling number function is on.	Check the Settings menu and turn the function off.
Impossible to receive/send SMS & photos	Memory full	Delete some data, such as applications or messages from your device to make more memory available.
Files do not open	Unsupported file format	Check the supported file formats.
No sound	Vibration mode	Check the settings status in the sound menu to make sure you are not in vibration or silent mode.

Message	Possible causes	Possible corrective measures
Hangs up or freezes	Intermittent software problem	If the screen freezes or the device does not respond when you try to operate it, remove the battery and reinsert it. Then power the device back on. OR Try to perform a software update through the website.

Anti-Theft Guide

You can set up your device to prevent other people from using it if it's been reset to factory settings without your permission. For example, if your device is lost, stolen, or wiped, only someone with your Google account or screen lock information can use the device.

All you need to make sure your device is protected is:

- **Set a screen lock:** If your device is lost or stolen but you have a screen lock set, the device can't be erased using the Settings menu unless your screen is unlocked.
- **Add your Google account on your device:** If your device is wiped but you have your Google account on it, the device can't finish the setup process until your Google account information is entered again.

After your device is protected, you'll need to either unlock your screen or enter your Google account password if you need to do a factory reset.

This ensures that you or someone you trust is doing the reset.

NOTE

- Do not forget your Google account and password you had added to your device prior to performing a factory reset. If you can't provide the account information during the setup process, you won't be able to use the device at all after performing the factory reset.

More information

Open source software notice information

To obtain the source code under GPL, LGPL, MPL, and other open source licenses, that is contained in this product, please visit

<http://opensource.lge.com>.

In addition to the source code, all referred license terms, warranty disclaimers and copyright notices are available for download.

LG Electronics will also provide open source code to you on CD-ROM for a charge covering the cost of performing such distribution (such as the cost of media, shipping, and handling) upon email request to opensource@lge.com. This offer is valid for three (3) years from the date on which you purchased the product.

Regulatory information (FCC ID number, etc.)

For regulatory details, go to **Settings (General tab) > About phone > Regulatory and safety** on your phone.

Trademarks

- Copyright ©2016 LG Electronics, Inc. All rights reserved. LG and the LG logo are registered trademarks of LG Group and its related entities. All other trademarks are the property of their respective owners.
- Google™, Google Maps™, Gmail™, YouTube™, Hangouts™ and Play Store™ are trademarks of Google, Inc.
- Bluetooth® is a registered trademark of Bluetooth SIG, Inc. worldwide.
- Wi-Fi® and the Wi-Fi logo are registered trademarks of the Wi-Fi Alliance.
- All other trademarks and copyrights are the property of their respective owners.

Declaration of conformity

Hereby, **LG Electronics** declares that this **LG-K350n** product is in compliance with the essential requirements and other relevant provisions of Directive **1999/5/EC**. A copy of the Declaration of Conformity can be found at **<http://www.lg.com/global/declaration>**

Contact office for compliance of this product

LG Electronics European Shared Service Center B.V.
Krijgsman 1, 1186 DM Amstelveen, The Netherlands



Disposal of your old appliance

- 1 This crossed-out wheeled bin symbol indicates that waste electrical and electronic products (WEEE) should be disposed of separately from the municipal waste stream.
- 2 Old electrical products can contain hazardous substances so correct disposal of your old appliance will help prevent potential negative consequences for the environment and human health. Your old appliance may contain reusable parts that could be used to repair other products, and other valuable materials that can be recycled to conserve limited resources.
- 3 You can take your appliance either to the shop where you purchased the product, or contact your local government waste office for details of your nearest authorised WEEE collection point. For the most up to date information for your country please see www.lg.com/global/recycling



Disposal of waste batteries/accumulators

- 1 This symbol may be combined with chemical symbols for mercury (Hg), cadmium (Cd) or lead (Pb) if the battery contains more than 0.0005% of mercury, 0.002% of cadmium or 0.004% of lead.
- 2 All batteries/accumulators should be disposed separately from the municipal waste stream via designated collection facilities appointed by the government or the local authorities.
- 3 The correct disposal of your old batteries/accumulators will help to prevent potential negative consequences for the environment, animal and human health.
- 4 For more detailed information about disposal of your old batteries/accumulators, please contact your city office, waste disposal service or the shop where you purchased the product.



General Inquiries

<LG Customer Information Centre>

UK: 0344-847-5454 or +44-344-847-5454

IE: 01-686-9454 or +353-1-686-9454

* Make sure the number is correct before making a call.

CE0168