

FCC LTE REPORT

FCC Certification

Applicant Name:
 LG Electronics MobileComm U.S.A., Inc.

Date of Issue:
 May 23, 2016

Location:

Address:
 1000 Sylvan Avenue, Englewood Cliffs NJ 07632

HCT CO., LTD.,
 74, Seoicheon-ro 578beon-gil, Majang-myeon,
 Icheon-si, Gyeonggi-do, 17383, Rep. of KOREA

Report No.: HCT-R-1605-F025
HCT FRN: 0005866421

FCC ID: ZNFK220H

APPLICANT: LG Electronics MobileComm U.S.A., Inc.

FCC Model(s): LG-K220H
Additional FCC Model(s): LGK220H, K220H
EUT Type: GSM WCDMA LTE Phone with BT & WLAN
FCC Classification: Licensed Portable Transmitter Held to Ear (PCE)
FCC Rule Part(s): §27, §2

Mode (MHz)	Tx Frequency (MHz)	Emission Designator	Modulation	EIRP	
				Max. Power (W)	Max. Power (dBm)
LTE – Band4 (1.4)	1710.7 – 1754.3	1M10G7D	QPSK	0.266	24.25
		1M10W7D	16QAM	0.210	23.23
LTE – Band4 (3)	1711.5 – 1753.5	2M70G7D	QPSK	0.259	24.14
		2M70W7D	16QAM	0.209	23.20
LTE – Band4 (5)	1712.5 – 1752.5	4M51G7D	QPSK	0.260	24.15
		4M51W7D	16QAM	0.211	23.25
LTE – Band4 (10)	1715.0 – 1750.0	8M99G7D	QPSK	0.257	24.10
		8M96W7D	16QAM	0.202	23.04
LTE – Band4 (15)	1717.5 – 1747.5	13M5G7D	QPSK	0.258	24.12
		13M5W7D	16QAM	0.204	23.09
LTE – Band4 (20)	1720.0 – 1745.0	17M9G7D	QPSK	0.262	24.19
		18M0W7D	16QAM	0.210	23.23

Mode (MHz)	Tx Frequency (MHz)	Emission Designator	Modulation	ERP	
				Max. Power (W)	Max. Power (dBm)
LTE – Band17 (5)	706.5 – 713.5	4M53G7D	QPSK	0.067	18.26
		4M50W7D	16QAM	0.058	17.66
LTE – Band17 (10)	709.0 – 711.0	8M99G7D	QPSK	0.059	17.70
		9M00W7D	16QAM	0.049	16.91

The measurements shown in this report were made in accordance with the procedures specified in CFR47 section §2.947. I assume full responsibility for the accuracy and completeness of these measurements, and for the qualifications of all persons taking them.

HCT CO., LTD. Certifies that no party to this application has subject to a denial of Federal benefits that includes FCC benefits pursuant to section 5301 of the Anti-Drug Abuse Act of 1998, 21 U.S. C.853(a)



Report prepared by
: Ki Hyun Kim
Test engineer of RF Team



Approved by
: Kyoung Houn Seo
Manager of RF Team

This report only responds to the tested sample and may not be reproduced, except in full, without written approval of the HCT Co., Ltd.

Version

TEST REPORT NO.	DATE	DESCRIPTION
HCT-R-1605-F025	May 23, 2016	- First Approval Report

Table of Contents

1. GENERAL INFORMATION	6
2. INTRODUCTION	8
2.1. EUT DESCRIPTION.....	8
2.2. MEASURING INSTRUMENT CALIBRATION.....	8
2.3. TEST FACILITY	8
3. DESCRIPTION OF TESTS	9
3.1 ERP/EIRP RADIATED POWER AND RADIATED SPURIOUS EMISSIONS.....	9
3.2 AWS – MOBILE FREQUENCY BLOCKS (1710 – 1755 MHz)	10
3.3 BLOCK B FREQUENCY RANGE (704 – 710 and 734 – 740 MHz, 777 – 792 MHz)	10
3.4 PEAK-AVERAGE RATIO.	11
3.5 OCCUPIED BANDWIDTH.	13
3.6 SPURIOUS AND HARMONIC EMISSIONS AT ANTENNA TERMINAL.....	14
3.7 FREQUENCY STABILITY / VARIATION OF AMBIENT TEMPERATURE	15
4. LIST OF TEST EQUIPMENT	16
5. MEASUREMENT UNCERTAINTY.....	17
6. SUMMARY OF TEST RESULTS	18
7. SAMPLE CALCULATION.....	19
8. TEST DATA	20
8.1 EQUIVALENT ISOTROPIC RADIATED POWER (Band 4)	20
8.2 EFFECTIVE RADIATED POWER (Band 17).....	24
8.3 RADIATED SPURIOUS EMISSIONS.....	26
8.3.1 RADIATED SPURIOUS EMISSIONS (1.4 MHz Band 4 LTE)	26
8.3.2 RADIATED SPURIOUS EMISSIONS (3 MHz Band 4 LTE)	27
8.3.3 RADIATED SPURIOUS EMISSIONS (5 MHz Band 4 LTE)	28
8.3.4 RADIATED SPURIOUS EMISSIONS (10 MHz Band 4 LTE)	29
8.3.5 RADIATED SPURIOUS EMISSIONS (15 MHz Band 4 LTE)	30
8.3.6 RADIATED SPURIOUS EMISSIONS (20 MHz Band 4 LTE)	31
8.3.7 RADIATED SPURIOUS EMISSIONS (5 MHz Band 17 LTE).....	32
8.3.8 RADIATED SPURIOUS EMISSIONS (10 MHz Band 17 LTE).....	33
8.4 PEAK-TO-AVERAGE RATIO	34
8.5 OCCUPIED BANDWIDTH	35
8.6 CONDUCTED SPURIOUS EMISSIONS	36
8.6.1 BAND EDGE.....	37
8.7 FREQUENCY STABILITY / VARIATION OF AMBIENT TEMPERATURE	38
8.7.1 FREQUENCY STABILITY (1.4 MHz Band 4 LTE)	38

8.7.2 FREQUENCY STABILITY (3 MHz Band 4 LTE)	39
8.7.3 FREQUENCY STABILITY (5 MHz Band 4 LTE)	40
8.7.4 FREQUENCY STABILITY (10 MHz Band 4 LTE)	41
8.7.5 FREQUENCY STABILITY (15 MHz Band 4 LTE)	42
8.7.6 FREQUENCY STABILITY (20 MHz Band 4 LTE)	43
8.7.7FREQUENCY STABILITY (5 MHz Band 17 LTE)	44
8.7.8 FREQUENCY STABILITY (10 MHz Band 17 LTE)	45
9. TEST PLOTS.....	46

MEASUREMENT REPORT

1. GENERAL INFORMATION

Applicant Name: LG Electronics MobileComm U.S.A., Inc.

Address: 1000 Sylvan Avenue, Englewood Cliffs NJ 07632

FCC ID: ZNFK220H

Application Type: Certification

FCC Classification: Licensed Portable Transmitter Held to Ear (PCE)

FCC Rule Part(s): §27, §2

EUT Type: GSM WCDMA LTE Phone with BT & WLAN

FCC Model(s): LG-K220H

Additional FCC Model(s): LGK220H, K220H

Tx Frequency: 1710.7 MHz – 1754.3 MHz (LTE – Band 4 (1.4 MHz))
1711.5 MHz – 1753.5 MHz (LTE – Band 4 (3 MHz))
1712.5 MHz – 1752.5 MHz (LTE – Band 4 (5 MHz))
1715.0 MHz – 1750.0 MHz (LTE – Band 4 (10 MHz))
1717.5 MHz – 1747.5 MHz (LTE – Band 4 (15 MHz))
1720.0 MHz – 1745.0 MHz (LTE – Band 4 (20 MHz))

706.5 MHz – 713.5 MHz (LTE – Band 17 (5 MHz))
709.0 MHz – 711.0 MHz (LTE – Band 17 (10 MHz))

Max. RF Output Power:

Band 4 (1.4 MHz):	0.266 W (QPSK) (24.25 dBm)
	0.210 W (16-QAM) (23.23 dBm)
Band 4 (3 MHz):	0.259 W (QPSK) (24.14 dBm)
	0.209 W (16-QAM) (23.20 dBm)
Band 4 (5 MHz):	0.260 W (QPSK) (24.15 dBm)
	0.211 W (16-QAM) (23.25 dBm)
Band 4 (10 MHz):	0.257 W (QPSK) (24.10 dBm)
	0.202 W (16-QAM) (23.04 dBm)
Band 4 (15 MHz):	0.258 W (QPSK) (24.12 dBm)
	0.204 W (16-QAM) (23.09 dBm)
Band 4 (20 MHz):	0.262 W (QPSK) (24.19 dBm)
	0.210 W (16-QAM) (23.23 dBm)
Band 17 (5 MHz) :	0.067 W (QPSK) (18.26 dBm)
	0.058 W (16-QAM) (17.66 dBm)
Band 17 (10 MHz) :	0.059 W (QPSK) (17.70 dBm)
	0.049 W (16-QAM) (16.91 dBm)

Emission Designator(s):

Band 4 (1.4 MHz):	1M10G7D (QPSK) / 1M10W7D (16-QAM)
Band 4 (3 MHz):	2M70G7D (QPSK) / 2M70W7D (16-QAM)
Band 4 (5 MHz):	4M51G7D (QPSK) / 4M51W7D (16-QAM)
Band 4 (10 MHz):	8M99G7D (QPSK) / 8M96W7D (16-QAM)
Band 4 (15 MHz):	13M5G7D (QPSK) / 13M5W7D (16-QAM)
Band 4 (20 MHz):	17M9G7D (QPSK) / 18M0W7D (16-QAM)

Band 17 (5 MHz) :	4M53G7D (QPSK) / 4M50W7D (16-QAM)
Band 17 (10 MHz) :	8M99G7D (QPSK) / 9M00W7D (16-QAM)

Date(s) of Tests: April 20, 2016 ~ May 19, 2016

Antenna Specification:

Manufacturer:	LS Mtron Co., Ltd.
Antenna type:	PIFA Antenna (Planar Inverted F)
Peak Gain:	Band 4: -1.03 dBi
	Band 17: -5.09 dBi

2. INTRODUCTION

2.1. EUT DESCRIPTION

The LG Electronics MobileComm U.S.A., Inc. LG-K220H GSM WCDMA LTE Phone with BT & WLAN consists of LTE 4 and 17.

2.2. MEASURING INSTRUMENT CALIBRATION

The measuring equipment, which was utilized in performing the tests documented herein, has been calibrated in accordance with the manufacturer's recommendations for utilizing calibration equipment, which is traceable to recognized national standards.

2.3. TEST FACILITY

The Fully-anechoic chamber and conducted measurement facility used to collect the radiated data are located at the **74, Seoicheon-ro 578beon-gil, Majang-myeon, Icheon-si, Gyeonggi-do, 17383, Rep. of KOREA.**

3. DESCRIPTION OF TESTS

3.1 ERP/EIRP RADIATED POWER AND RADIATED SPURIOUS EMISSIONS

Note: ERP(Effective Radiated Power), EIRP(Effective Isotropic Radiated Power)

Test Procedure

Radiated emission measurements are performed in the Fully-anechoic chamber. The equipment under test is placed on a non-conductive table 3-meters away from the receive antenna in accordance with ANSI/TIA-603-D-2010 Clause 2.2.17. The turntable is rotated through 360 degrees, and the receiving antenna scans in order to determine the level of the maximized emission. The level and position of the maximized emission is recorded with the spectrum analyzer using a RMS detector.

A half wave dipole is then substituted in place of the EUT. For emissions above 1GHz, a horn antenna is substituted in place of the EUT. The substitute antenna is driven by a signal generator and the previously recorded signal was duplicated.

The power is calculated by the following formula;

$$P_{d(dBm)} = P_{g(dBm)} - \text{cable loss}_{(dB)} + \text{antenna gain}_{(dB)}$$

Where: P_d is the dipole equivalent power and P_g is the generator output power into the substitution antenna.

The maximum EIRP is calculated by adding the forward power to the calibrated source plus its appropriate gain value. These steps are repeated with the receiving antenna in both vertical and horizontal polarization. the difference between the gain of the horn and an isotropic antenna are taken into consideration

Radiated spurious emissions

: Frequency Range : 30 MHz ~ 10th Harmonics of highest channel fundamental frequency.

3.2 AWS – MOBILE FREQUENCY BLOCKS (1710 – 1755 MHz)

§27.5(h)

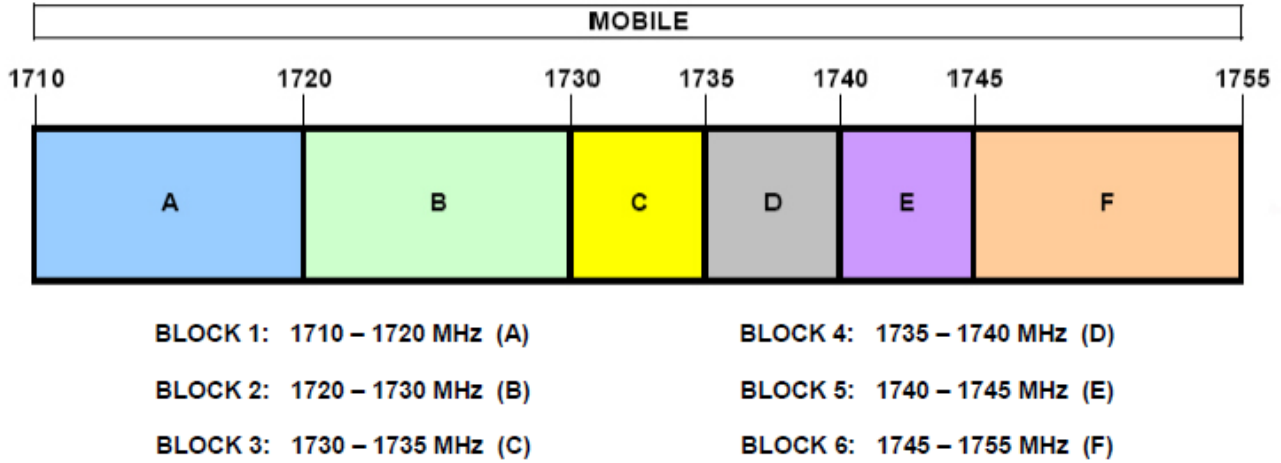

3.3 BLOCK B FREQUENCY RANGE (704 – 710 and 734 – 740 MHz, 777 – 792 MHz)

§27.5(c)

698-746 MHz Band. The following frequencies are available for licensing pursuant to this part in the 698–746 MHz band: (1) Three paired channel blocks of 12 MHz each are available for assignment as follows :

Block A : 698 – 704 MHz and 728 – 734 MHz ;

Block B : 704 – 710 MHz and 734 – 740 MHz ; and

Block C : 710 – 716 MHz and 740 – 746 MHz.

The EUT is only being authorized for operation in Blocks B and C.

3.4 PEAK-AVERAGE RATIO.

Test Procedure

Peak to Average Power Ratio is tested in accordance with KDB971168 D01 Power Meas License Digital Systems v02r02, October 17, 2014, Section 5.7.

- Section 5.7.1 CCDF Procedure

- a) Set resolution/measurement bandwidth \geq signal's occupied bandwidth;
- b) Set the number of counts to a value that stabilizes the measured CCDF curve;
- c) Set the measurement interval as follows:
 - 1) for continuous transmissions, set to 1 ms,
 - 2) for burst transmissions, employ an external trigger that is synchronized with the EUT burst timing sequence, or use the internal burst trigger with a trigger level that allows the burst to stabilize and set the measurement interval to a time that is less than or equal to the burst duration.
- d) Record the maximum PAPR level associated with a probability of 0.1%.

- Section 5.7.2 Alternate Procedure

Use one of the procedures presented in 5.1 to measure the total peak power and record as P_{Pk} . Use one of the applicable procedures presented 5.2 to measure the total average power and record as P_{Avg} . Determine the P.A.R. from: $P.A.R_{(dB)} = P_{Pk (dBm)} - P_{Avg (dBm)}$ (P_{Avg} = Average Power + Duty cycle Factor)

5.1.1 Peak power measurements with a spectrum/signal analyzer or EMI receiver

The following procedure can be used to determine the total peak output power.

- a) Set the RBW \geq OBW.
- b) Set VBW $\geq 3 \times$ RBW.
- c) Set span $\geq 2 \times$ RBW
- d) Sweep time = auto couple.
- e) Detector = peak.
- f) Ensure that the number of measurement points \geq span/RBW.
- g) Trace mode = max hold.
- h) Allow trace to fully stabilize.
- i) Use the peak marker function to determine the peak amplitude level.

5.2.2 Procedures for use with a spectrum/signal analyzer when EUT cannot be configured to transmit continuously and sweep triggering/signal gating cannot be properly implemented

If the EUT cannot be configured to transmit continuously (burst duty cycle < 98%), then one of the following procedures can be used. The selection of the applicable procedure will depend on the characteristics of the measured burst duty cycle.

Measure the burst duty cycle with a spectrum/signal analyzer or EMC receiver can be used in zero-span mode if the response time and spacing between bins on the sweep are sufficient to permit accurate measurement of the burst on/off time of the transmitted signal.

5.2.2.2 Constant burst duty cycle

If the measured burst duty cycle is constant (i.e., duty cycle variations are less than ± 2 percent), then:

- a) Set span to at least 1.5 times the OBW.
- b) Set RBW = 1-5% of the OBW, not to exceed 1 MHz.
- c) Set VBW $\geq 3 \times$ RBW.
- d) Number of points in sweep $\geq 2 \times$ span / RBW. (This gives bin-to-bin spacing \leq RBW/2, so that narrowband signals are not lost between frequency bins.)
- e) Sweep time = auto.
- f) Detector = RMS (power averaging).
- g) Set sweep trigger to "free run".
- h) Trace average at least 100 traces in power averaging (i.e., RMS) mode.
- i) Compute power by integrating the spectrum across the OBW of the signal using the instrument's band power measurement function with band limits set equal to the OBW band edges. If the instrument does not have a band power function, sum the spectrum levels (in power units) at intervals equal to the RBW extending across the entire OBW of the spectrum.
- j) Add $10 \log (1/x)$, where x is the duty cycle, to the measured power in order to compute the average power during the actual transmission times (because the measurement represents an average over both the on and off times of the transmission).

For example, add $10 \log (1/0.25) = 6$ dB if the duty cycle is a constant 25%.

3.5 OCCUPIED BANDWIDTH.

Test set-up

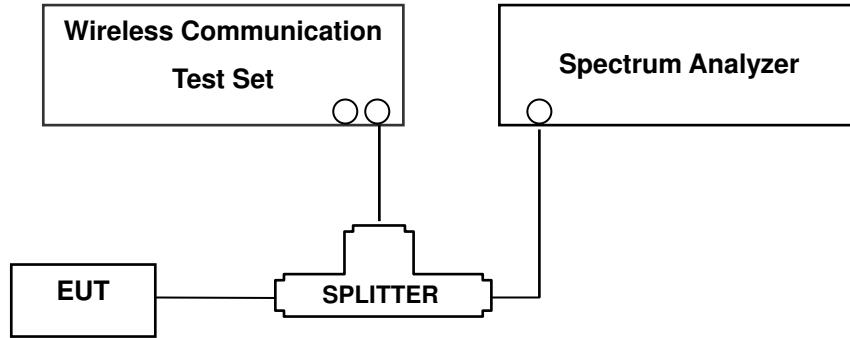

(Configuration of conducted Emission measurement)

The width of a frequency band such that, below the lower and above the upper frequency limits, the mean powers emitted are each equal to a specified percentage 0.5 % of the total mean power of a given emission.

Test Procedure

OBW is tested in accordance with KDB971168 D01 Power Meas License Digital Systems v02r02, October 17, 2014, Section 4.2.

The EUT makes a call to the communication simulator. The power was measured with R&S Spectrum Analyzer. All measurements were done at 3 channels(low, middle and high operational range.)

The conducted occupied bandwidth used the power splitter via EUT RF power connector between simulation base station and spectrum analyzer.

The communication simulator station system controlled a EUT to export maximum output power under transmission mode and specific channel frequency. Use OBW measurement function of Spectrum analyzer to measure 99 % occupied bandwidth

3.6 SPURIOUS AND HARMONIC EMISSIONS AT ANTENNA TERMINAL.

Test Procedure

Spurious and harmonic emissions at antenna terminal is tested in accordance with KDB971168 D01 Power Meas License Digital Systems v02r02, October 17, 2014, Section 6.0.

The level of the carrier and the various conducted spurious and harmonic frequencies is measured by means of a calibrated spectrum analyzer.

The spectrum is scanned from the lowest frequency generated in the equipment up to a frequency including its 10th harmonic. On any frequency outside a licensee's frequency block, the power of any emission shall be attenuated below the transmitter power (P) by at least $43 + 10 \log(P)$ dB. Compliance with these provisions is based on the use of measurement instrumentation employing a resolution bandwidth of 1 MHz or greater. However, in the 100 kHz bands immediately outside and adjacent to the frequency block a resolution bandwidth of at least 30kHz bandwidth may be employed. The emission bandwidth is defined as the width of the signal between two points, one below the carrier center frequency and one above the carrier center frequency

NOTES: The analyzer plot offsets were determined by below conditions.

- For LTE Band 4, total offset 27.4 dB = 20 dB attenuator + 6 dB Divider + 1.4 dB RF cables.
- For LTE Band 17 total offset 27.1 dB = 20 dB attenuator + 6 dB Divider + 1.1 dB RF cables.

3.7 FREQUENCY STABILITY / VARIATION OF AMBIENT TEMPERATURE

Test Set-up

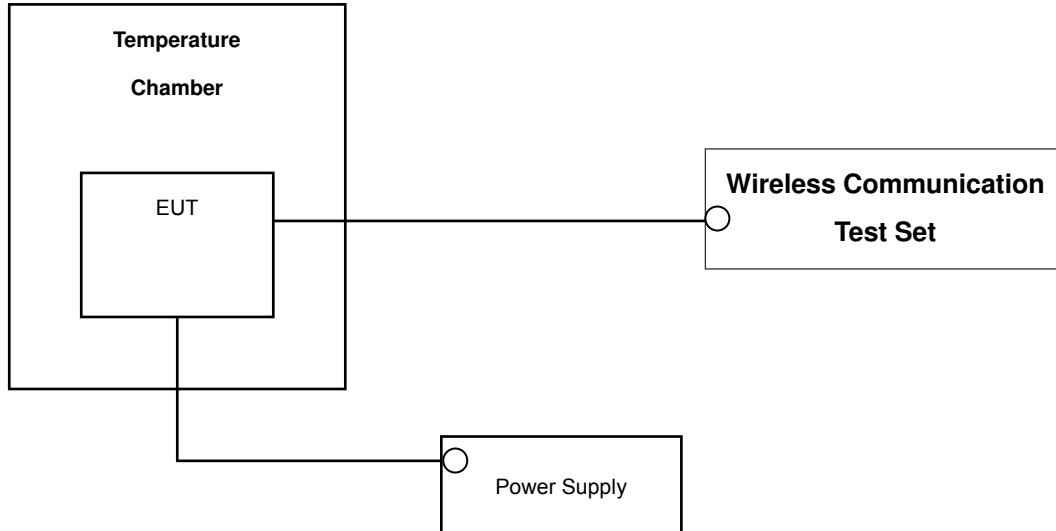

* Nominal Operating Voltage

Test Procedure

Frequency stability is tested in accordance with ANSI/TIA-603-D-2010 section 2.2.2

The frequency stability of the transmitter is measured by:

- a.) **Temperature:** The temperature is varied from - 30 °C to + 50 °C using an environmental chamber.
- b.) **Primary Supply Voltage:** The primary supply voltage is varied from the end point to 100 % of the voltage normally at the input to the device or at the power supply terminals if cables are not normally supplied.

Specification — the frequency stability shall be sufficient to ensure that the fundamental emission stays within the authorized frequency block

Time Period and Procedure:

The carrier frequency of the transmitter is measured at room temperature (20°C to provide a reference).

1. The equipment is turned on in a “standby” condition for one minute before applying power to the transmitter. Measurement of the carrier frequency of the transmitter is made within one minute after applying power to the transmitter.
2. Frequency measurements are made at 10°C intervals ranging from -30°C to +50°C. A period of at least one half-hour is provided to allow stabilization of the equipment at each temperature level.

NOTE: The EUT is tested down to the battery endpoint.

4. LIST OF TEST EQUIPMENT

Manufacture	Model/ Equipment	Serial Number	Calibration Interval	Calibration Due
MITEQ	AMF-6D-001180-35-20P/AMP	1081666	Annual	09/03/2016
Wainwright	WHK1.2/15G-10EF/H.P.F	4	Annual	04/11/2017
Wainwright	WHK3.3/18G-10EF/H.P.F	2	Annual	04/11/2017
Hewlett Packard	11667B / Power Splitter	10545	Annual	02/15/2017
Hewlett Packard	11667B / Power Splitter	11275	Annual	04/29/2017
ITECH	IT6720/ Power Supply	0100215626700119	Annual	11/02/2016
Schwarzbeck	UHAP/ Dipole Antenna	557	Biennial	03/23/2017
Schwarzbeck	UHAP/ Dipole Antenna	558	Biennial	03/23/2017
EXP	EX-TH400/ Chamber	None	Annual	05/29/2016
Schwarzbeck	BBHA 9120D/ Horn Antenna	147	Biennial	09/01/2016
Schwarzbeck	BBHA 9120D/ Horn Antenna	1299	Biennial	05/15/2017
Schwarzbeck	BBHA 9170/ Horn Antenna(15~40GHz)	BBHA9170342	Biennial	04/30/2017
Schwarzbeck	BBHA 9170/ Horn Antenna(15~35GHz)	BBHA9170124	Biennial	04/30/2017
Agilent	N9020A/Signal Analyzer	MY52090906	Annual	05/13/2017
Hewlett Packard	8493C/ATTENUATOR	17280	Annual	06/29/2016
REOHDE&SCHWARZ	FSV40/Spectrum Analyzer	1307.9002K40-100931-NK	Annual	06/04/2016
Agilent	8960 (E5515C)/ Base Station	MY48360800	Annual	10/30/2016
Anritsu Corp.	MT8820C/Wideband Radio Communication Tester	6200863156	Annual	02/26/2017
Anritsu Corp.	MT8820C/Wideband Radio Communication Tester	6201026545	Annual	02/16/2017
Schwarzbeck	VULB9160/ Bilog Antenna	3150	Biennial	11/17/2016
Schwarzbeck	VULB9160/ Bilog Antenna	3368	Biennial	10/10/2016

5. MEASUREMENT UNCERTAINTY

The measurement uncertainties shown below were calculated in accordance with the requirements of ANSI C63.4:2014.

All measurement uncertainty values are shown with a coverage factor of $k = 2$ to indicate a 95 % level of confidence. The measurement data shown herein meets or exceeds the U_{CISPR} measurement uncertainty values specified in CISPR 16-4-2 and, thus, can be compared directly to specified limits to determine compliance.

Parameter	Expanded Uncertainty (\pm dB)
Conducted Disturbance (150 kHz ~ 30 MHz)	1.82
Radiated Disturbance (9 kHz ~ 30 MHz)	3.40
Radiated Disturbance (30 MHz ~ 1 GHz)	4.80
Radiated Disturbance (1 GHz ~ 18 GHz)	6.07

6. SUMMARY OF TEST RESULTS

FCC Part Section(s)	Test Description	Test Limit	Test Condition	Test Result
2.1049	Occupied Bandwidth	N/A	CONDUCTED	PASS
2.1051, 27.53(g), 27.53(h)	Band Edge / Spurious and Harmonic Emissions at Antenna Terminal.	$< 43 + 10 \log_{10}(P[\text{Watts}])$ at Band Edge and for all-of-band emissions		PASS
27.50(d)(5)	Peak-Average Ratio	$< 13 \text{ dB}$		PASS
2.1046	*Conducted Output Power	N/A		PASS
2.1055, 27.54	Frequency stability / variation of ambient temperature	Emission must remain in band		PASS
27.50(c)(10)	Effective Radiated Power (Band 17)	$< 3 \text{ Watts max. ERP}$	RADIATED	PASS
27.50(d)(4)	Equivalent Isotropic Radiated Power (Band 4)	$< 1 \text{ Watts max. EIRP}$		PASS
2.1053, 27.53(g), 27.53(h)	Undesirable Out-of-Band Emissions	$< 43 + 10 \log_{10}(P[\text{Watts}])$ for all out-of-band emissions		PASS

*: See SAR Report

7. SAMPLE CALCULATION

A. EIRP Sample Calculation

Mode	Ch./ Freq.		Measured Level(dBm)	Substitute LEVEL(dBm)	Ant. Gain (dBi)	C.L	Pol.	Limit	EIRP	
	channel	Freq.(MHz)						W	W	dBm
LTE Band4	20175	1,732.50	-15.75	18.45	9.90	1.76	H	< 1.00	0.456	26.59

EIRP = Substitute LEVEL(dBm) + Ant. Gain – CL(Cable Loss)

- 1) The EUT mounted on a wooden tripod is 2.5 meter above test site ground level.
- 2) During the test , the turn table is rotated and the antenna height is found.
- 3) Record the field strength meter's level.
- 4) Replace the EUT with dipole/Horn antenna that is connected to a calibrated signal generator.
- 5) Increase the signal generator output till the field strength meter's level is equal to the item (3).
- 6) The signal generator output level with Ant. Gain and cable loss are the rating of effective radiated power (**EIRP**).

B. Emission Designator

QPSK Modulation

Emission Designator = 4M48G7D

LTE BW = 4.48 MHz

G = Phase Modulation

7 = Quantized/Digital Info

D = Data transmission; telemetry; telecommand

16QAM Modulation

Emission Designator = 4M48W7D

LTE BW = 4.48 MHz

W = main carrier modulated in a combination of two

or more of the following modes;

amplitude, angle, pulse

7 = Quantized/Digital Info

D = Data transmission; telemetry; telecommand

8. TEST DATA

8.1 EQUIVALENT ISOTROPIC RADIATED POWER (Band 4)

Freq (MHz)	Bandwidth	Modulation	Measured Level (dBm)	Substitute Level (dBm)	Ant. Gain(dBi)	C.L	Pol	Limit	EIRP	
								W	W	dBm
1710.7	1.4 MHz	QPSK	-16.41	16.93	9.37	2.45	H	< 1.00	0.243	23.85
		16-QAM	-17.41	15.93	9.37	2.45	H		0.193	22.85
1732.5		QPSK	-16.37	16.95	9.44	2.47	H		0.246	23.92
		16-QAM	-17.37	15.95	9.44	2.47	H		0.196	22.92
1754.3		QPSK	-16.13	17.19	9.53	2.47	H		0.266	24.25
		16-QAM	-17.15	16.17	9.53	2.47	H		0.210	23.23

Equivalent Isotropic Radiated Power Data (1.4 MHz Band4 LTE)

Note: All of RB size has been tested for emissions and EIRP, with the 1RB configuration observed as the worst case

Freq (MHz)	Bandwidth	Modulation	Measured Level (dBm)	Substitute Level (dBm)	Ant. Gain(dBi)	C.L	Pol	Limit	EIRP	
								W	W	dBm
1711.5	3 MHz	QPSK	-16.42	16.92	9.37	2.45	H	< 1.00	0.242	23.84
		16-QAM	-17.34	16.00	9.37	2.45	H		0.196	22.92
1732.5		QPSK	-16.39	16.93	9.44	2.47	H		0.245	23.90
		16-QAM	-17.41	15.91	9.44	2.47	H		0.194	22.88
1753.5		QPSK	-16.24	17.08	9.53	2.47	H		0.259	24.14
		16-QAM	-17.18	16.14	9.53	2.47	H		0.209	23.20

Equivalent Isotropic Radiated Power Data (3 MHz Band4 LTE)

Note: All of RB size has been tested for emissions and EIRP, with the 1RB configuration observed as the worst case

Freq (MHz)	Bandwidth	Modulation	Measured Level (dBm)	Substitute Level (dBm)	Ant. Gain(dBi)	C.L	Pol	Limit	EIRP	
								W	W	dBm
1712.5	5 MHz	QPSK	-16.38	16.96	9.37	2.45	H	< 1.00	0.244	23.88
		16-QAM	-17.34	16.00	9.37	2.45	H		0.196	22.92
1732.5		QPSK	-16.33	16.99	9.44	2.47	H		0.249	23.96
		16-QAM	-17.17	16.15	9.44	2.47	H		0.205	23.12
1752.5		QPSK	-16.21	17.11	9.51	2.47	H		0.260	24.15
		16-QAM	-17.11	16.21	9.51	2.47	H		0.211	23.25

Equivalent Isotropic Radiated Power Data (5 MHz Band4 LTE)

Note: All of RB size has been tested for emissions and EIRP, with the 1RB configuration observed as the worst case

Freq (MHz)	Bandwidth	Modulation	Measured Level (dBm)	Substitute Level (dBm)	Ant. Gain(dBi)	C.L	Pol	Limit	EIRP	
								W	W	dBm
1715.0	10 MHz	QPSK	-16.40	16.94	9.39	2.46	H	< 1.00	0.244	23.87
		16-QAM	-17.26	16.08	9.39	2.46	H		0.200	23.01
1732.5		QPSK	-16.27	17.05	9.44	2.47	H		0.252	24.02
		16-QAM	-17.27	16.05	9.44	2.47	H		0.200	23.02
1750.0		QPSK	-16.26	17.06	9.51	2.47	H		0.257	24.10
		16-QAM	-17.32	16.00	9.51	2.47	H		0.202	23.04

Equivalent Isotropic Radiated Power Data (10 MHz Band4 LTE)

Note: All of RB size has been tested for emissions and EIRP, with the 1RB configuration observed as the worst case

Freq (MHz)	Bandwidth	Modulation	Measured Level (dBm)	Substitute Level (dBm)	Ant. Gain(dBi)	C.L	Pol	Limit	EIRP	
								W	W	dBm
1717.5	15 MHz	QPSK	-16.40	16.94	9.40	2.47	H	< 1.00	0.244	23.87
		16-QAM	-17.30	16.04	9.40	2.47	H		0.198	22.97
1732.5		QPSK	-16.33	16.99	9.44	2.47	H		0.249	23.96
		16-QAM	-17.20	16.12	9.44	2.47	H		0.204	23.09
1747.5		QPSK	-16.24	17.08	9.51	2.47	H		0.258	24.12
		16-QAM	-17.30	16.02	9.51	2.47	H		0.202	23.06

Equivalent Isotropic Radiated Power Data (15 MHz Band4 LTE)

Note: All of RB size has been tested for emissions and EIRP, with the 1RB configuration observed as the worst case

Freq (MHz)	Bandwidth	Modulation	Measured Level (dBm)	Substitute Level (dBm)	Ant. Gain(dBi)	C.L	Pol	Limit	EIRP	
								W	W	dBm
1720.0	20 MHz	QPSK	-16.34	17.00	9.40	2.47	H	< 1.00	0.247	23.93
		16-QAM	-17.36	15.98	9.40	2.47	H		0.196	22.91
1732.5		QPSK	-16.23	17.09	9.44	2.47	H		0.255	24.06
		16-QAM	-17.06	16.26	9.44	2.47	H		0.210	23.23
1745.0		QPSK	-16.19	17.17	9.49	2.47	H		0.262	24.19
		16-QAM	-17.18	16.18	9.49	2.47	H		0.209	23.20

Equivalent Isotropic Radiated Power Data (20 MHz Band4 LTE)

Note: All of RB size has been tested for emissions and EIRP, with the 1RB configuration observed as the worst case

NOTES:

Equivalent Isotropic Radiated Power Measurements by Substitution Method

according to ANSI/TIA/EIA-603-D-2010 June 24, 2010:

The EUT was placed on a non-conductive styrofoam resin table 3-meters from the receive antenna. The receive antenna height and turntable rotation was adjusted for the highest reading on the receive spectrum analyzer. For LTE signals, RBW = 1-5% of the OBW, not to exceed 1MHz, VBW \geq 3 x RBW, Detector = RMS. A Horn antenna was substituted in place of the EUT. This Horn antenna was driven by a signal generator and the level of the signal generator was adjusted to obtain the same receive spectrum analyzer reading. The conducted power at the terminals of the Horn antenna is measured. The difference between the gain of the horn and an isotropic antenna is taken into consideration and the EIRP is recorded.

Also, we have done x, y, z planes in EUT and horizontal and vertical polarization in detecting antenna. The worst case of the EUT is x plane in LTE mode. Also worst case of detecting Antenna is horizontal polarization in LTE mode.

8.2 EFFECTIVE RADIATED POWER (Band 17)

Freq (MHz)	Bandwidth	Modulation	Measured Level (dBm)	Substitute Level (dBm)	Ant. Gain(dBd)	C.L	Pol	Limit	ERP	
								W	W	dBm
706.5	5 MHz	QPSK	-32.29	29.53	-10.20	1.54	V	< 3.00	0.060	17.79
		16-QAM	-33.05	28.77	-10.20	1.54	V		0.051	17.03
710.0		QPSK	-31.85	29.75	-10.22	1.55	V		0.063	17.98
		16-QAM	-32.64	28.96	-10.22	1.55	V		0.052	17.19
713.5		QPSK	-31.39	30.05	-10.24	1.55	V		0.067	18.26
		16-QAM	-31.99	29.45	-10.24	1.55	V		0.058	17.66

Effective Radiated Power Data (5 MHz Band 17 LTE)

Note: All of RB size has been tested for emissions and ERP, with the 1RB configuration observed as the worst case

Freq (MHz)	Bandwidth	Modulation	Measured Level (dBm)	Substitute Level (dBm)	Ant. Gain(dBd)	C.L	Pol	Limit	ERP	
								W	W	dBm
709.0	10 MHz	QPSK	-32.30	29.38	-10.22	1.54	V	< 3.00	0.058	17.62
		16-QAM	-33.15	28.53	-10.22	1.54	V		0.048	16.77
710.0		QPSK	-32.13	29.47	-10.22	1.55	V		0.059	17.70
		16-QAM	-32.92	28.68	-10.22	1.55	V		0.049	16.91
711.0		QPSK	-32.13	29.36	-10.23	1.55	V		0.057	17.58
		16-QAM	-32.89	28.60	-10.23	1.55	V		0.048	16.82

Effective Radiated Power Data (10 MHz Band 17 LTE)

Note: All of RB size has been tested for emissions and ERP, with the 1RB configuration observed as the worst case

NOTES:

Effective Radiated Power Output Measurements by Substitution Method

according to ANSI/TIA/EIA-603-D-2010 June 24, 2010:

The EUT was placed on a non-conductive styrofoam resin table 3-meters from the receive antenna. The receive antenna height and turntable rotation was adjusted for the highest reading on the receive spectrum analyzer. For LTE signals, RBW = 1-5% of the OBW, not to exceed 1MHz, VBW $\geq 3 \times$ RBW, Detector = RMS. A half-wave dipole was substituted in place of the EUT. This dipole antenna was driven by a signal generator and the level of the signal generator was adjusted to obtain the same receive spectrum analyzer reading. The conducted power at the terminals of the dipole is measured. The ERP is recorded.

Also, we have done x, y, z planes in EUT and horizontal and vertical polarization in detecting antenna. The worst case of the EUT is y plane in LTE mode. Also worst case of detecting Antenna is vertical polarization in LTE mode.

8.3 RADIATED SPURIOUS EMISSIONS

8.3.1 RADIATED SPURIOUS EMISSIONS (1.4 MHz Band 4 LTE)

- ▣ OPERATING FREQUENCY: 1754.30 MHz
- ▣ MEASURED OUTPUT POWER: 24.25 dBm = 0.266 W
- ▣ MODULATION SIGNAL: 1.4 MHz QPSK
- ▣ DISTANCE: 3 meters
- ▣ LIMIT: $43 + 10 \log_{10}(W) =$ 37.25 dBc

Ch	Freq (MHz)	Measured Level (dBm)	Ant. Gain (dBi)	Substitute Level (dBm)	C.L	Pol	EIRP (dBm)	dBc
19957 (1710.7)	3,421.40	-53.37	12.19	-53.04	3.58	V	-44.43	68.68
	5,132.10	-49.13	12.76	-41.82	4.52	V	-33.58	57.83
	6,842.80	-57.99	12.06	-43.86	5.44	V	-37.24	61.49
20175 (1732.5)	3,465.00	-56.03	12.28	-55.14	3.52	V	-46.38	70.63
	5,197.50	-46.75	12.86	-39.61	4.74	V	-31.49	55.74
	6,930.00	-57.40	11.87	-42.00	5.57	V	-35.70	59.95
20393 (1754.3)	3,508.60	-57.31	12.36	-55.83	3.69	V	-47.16	71.41
	5,262.90	-46.23	12.95	-39.55	4.72	V	-31.32	55.57
	7,017.20	-58.01	11.73	-43.44	5.48	V	-37.19	61.44

- NOTES:**
1. Radiated Spurious Emission Measurements at 3 meters by Substitution Method according to ANSI/TIA/EIA-603-D-2010 June 24, 2010:
 2. We are performed all frequency to 10th harmonics from 30 MHz. Measurements above show only up to 3 maximum emissions noted, or would be lesser if no specific emissions from the EUT are recorded (ie: margin > 20 dB from the applicable limit) and considered that's already beyond the background noise floor.
 3. We have done x, y, z planes in EUT and horizontal and vertical polarization in detecting antenna.
 4. All of RB size has been tested for emissions and EIRP, with the 1RB configuration observed as the worst case
 5. We are performed 16QAM and QPSK modulations. The worst case data are reported in the table above.

8.3.2 RADIATED SPURIOUS EMISSIONS (3 MHz Band 4 LTE)

- ▣ OPERATING FREQUENCY: 1753.50 MHz
- ▣ MEASURED OUTPUT POWER: 24.14 dBm = 0.259 W
- ▣ MODULATION SIGNAL: 3 MHz QPSK
- ▣ DISTANCE: 3 meters
- ▣ LIMIT: $43 + 10 \log_{10}(W) =$ 37.14 dBc

Ch	Freq (MHz)	Measured Level (dBm)	Ant. Gain (dBi)	Substitute Level (dBm)	C.L	Pol	EIRP (dBm)	dBc
19965 (1711.5)	3,423.00	-53.27	12.20	-52.91	3.58	V	-44.29	68.43
	5,134.50	-50.63	12.76	-43.18	4.57	V	-34.99	59.13
	6,846.00	-57.75	12.05	-43.76	5.47	H	-37.18	61.32
20175 (1732.5)	3,465.00	-54.57	12.28	-53.68	3.52	V	-44.92	69.06
	5,197.50	-45.75	12.86	-38.61	4.74	V	-30.49	54.63
	6,930.00	-58.69	11.87	-43.29	5.57	V	-36.99	61.13
20385 (1753.5)	3,507.00	-56.54	12.36	-55.06	3.69	V	-46.39	70.53
	5,260.50	-47.24	12.95	-40.56	4.72	V	-32.33	56.47
	7,014.00	-57.36	11.73	-42.71	5.47	H	-36.45	60.59

- NOTES:**
1. Radiated Spurious Emission Measurements at 3 meters by Substitution Method according to ANSI/TIA/EIA-603-D-2010 June 24, 2010:
 2. We are performed all frequency to 10th harmonics from 30 MHz. Measurements above show only up to 3 maximum emissions noted, or would be lesser if no specific emissions from the EUT are recorded (ie: margin > 20 dB from the applicable limit) and considered that's already beyond the background noise floor.
 3. We have done x, y, z planes in EUT and horizontal and vertical polarization in detecting antenna.
 4. All of RB size has been tested for emissions and EIRP, with the 1RB configuration observed as the worst case
 5. We are performed 16QAM and QPSK modulations. The worst case data are reported in the table above.

8.3.3 RADIATED SPURIOUS EMISSIONS (5 MHz Band 4 LTE)

- ▣ OPERATING FREQUENCY: 1752.50 MHz
- ▣ MEASURED OUTPUT POWER: 24.15 dBm = 0.260 W
- ▣ MODULATION SIGNAL: 5 MHz QPSK
- ▣ DISTANCE: 3 meters
- ▣ LIMIT: $43 + 10 \log_{10}(W) =$ 37.15 dBc

Ch	Freq (MHz)	Measured Level (dBm)	Ant. Gain (dBi)	Substitute Level (dBm)	C.L	Pol	EIRP (dBm)	dBc
19975 (1712.5)	3,425.00	-57.73	12.20	-57.37	3.58	H	-48.75	72.90
	5,137.50	-47.63	12.77	-40.00	4.61	V	-31.84	55.99
	6,850.00	-57.17	12.04	-43.32	5.50	V	-36.78	60.93
20175 (1732.5)	3,465.00	-56.24	12.28	-55.35	3.52	V	-46.59	70.74
	5,197.50	-47.38	12.86	-40.24	4.74	V	-32.12	56.27
	6,930.00	-58.25	11.87	-42.85	5.57	V	-36.55	60.70
20375 (1752.5)	3,505.00	-56.35	12.35	-54.86	3.70	V	-46.21	70.36
	5,257.50	-47.40	12.95	-40.72	4.72	V	-32.49	56.64
	7,010.00	-56.87	11.73	-42.71	5.47	V	-36.45	60.60

- NOTES:**
1. Radiated Spurious Emission Measurements at 3 meters by Substitution Method according to ANSI/TIA/EIA-603-D-2010 June 24, 2010:
 2. We are performed all frequency to 10th harmonics from 30 MHz. Measurements above show only up to 3 maximum emissions noted, or would be lesser if no specific emissions from the EUT are recorded (ie: margin > 20 dB from the applicable limit) and considered that's already beyond the background noise floor.
 3. We have done x, y, z planes in EUT and horizontal and vertical polarization in detecting antenna.
 4. All of RB size has been tested for emissions and EIRP, with the 1RB configuration observed as the worst case
 5. We are performed 16QAM and QPSK modulations. The worst case data are reported in the table above.

8.3.4 RADIATED SPURIOUS EMISSIONS (10 MHz Band 4 LTE)

- ▣ OPERATING FREQUENCY: 1750.00 MHz
- ▣ MEASURED OUTPUT POWER: 24.10 dBm = 0.257 W
- ▣ MODULATION SIGNAL: 10 MHz QPSK
- ▣ DISTANCE: 3 meters
- ▣ LIMIT: $43 + 10 \log_{10}(W) =$ 37.10 dBc

Ch	Freq (MHz)	Measured Level (dBm)	Ant. Gain (dBi)	Substitute Level (dBm)	C.L	Pol	EIRP (dBm)	dBc
20000 (1715.0)	3,430.00	-55.40	12.21	-55.01	3.58	V	-46.38	70.48
	5,145.00	-49.48	12.78	-42.00	4.60	V	-33.82	57.92
	6,860.00	-57.45	12.01	-43.63	5.49	H	-37.11	61.21
20175 (1732.5)	3,465.00	-56.61	12.28	-55.72	3.52	V	-46.96	71.06
	5,197.50	-45.62	12.86	-38.48	4.74	V	-30.36	54.46
	6,930.00	-57.89	11.87	-42.49	5.57	V	-36.19	60.29
20350 (1750.0)	3,500.00	-54.20	12.35	-52.72	3.70	V	-44.07	68.17
	5,250.00	-47.90	12.93	-40.97	4.65	V	-32.69	56.79
	7,000.00	-57.38	11.73	-43.63	5.45	V	-37.35	61.45

- NOTES:**
1. Radiated Spurious Emission Measurements at 3 meters by Substitution Method according to ANSI/TIA/EIA-603-D-2010 June 24, 2010:
 2. We are performed all frequency to 10th harmonics from 30 MHz. Measurements above show only up to 3 maximum emissions noted, or would be lesser if no specific emissions from the EUT are recorded (ie: margin > 20 dB from the applicable limit) and considered that's already beyond the background noise floor.
 3. We have done x, y, z planes in EUT and horizontal and vertical polarization in detecting antenna.
 4. All of RB size has been tested for emissions and EIRP, with the 1RB configuration observed as the worst case
 5. We are performed 16QAM and QPSK modulations. The worst case data are reported in the table above.

8.3.5 RADIATED SPURIOUS EMISSIONS (15 MHz Band 4 LTE)

- ▣ OPERATING FREQUENCY: 1747.50 MHz
- ▣ MEASURED OUTPUT POWER: 24.12 dBm = 0.258 W
- ▣ MODULATION SIGNAL: 15 MHz QPSK
- ▣ DISTANCE: 3 meters
- ▣ LIMIT: $43 + 10 \log_{10}(W) =$ 37.12 dBc

Ch	Freq (MHz)	Measured Level (dBm)	Ant. Gain (dBi)	Substitute Level (dBm)	C.L	Pol	EIRP (dBm)	dBc
20025 (1717.5)	3,435.00	-54.67	12.22	-54.14	3.57	V	-45.48	69.60
	5,152.50	-48.75	12.79	-41.42	4.59	V	-33.22	57.34
	6,870.00	-57.53	11.99	-43.35	5.47	V	-36.83	60.95
20175 (1732.5)	3,465.00	-54.35	12.28	-53.46	3.52	V	-44.70	68.82
	5,197.50	-46.59	12.86	-39.45	4.74	V	-31.33	55.45
	6,930.00	-57.06	11.87	-41.66	5.57	V	-35.36	59.48
20325 (1747.5)	3,495.00	-54.16	12.34	-52.81	3.65	V	-44.12	68.24
	5,242.50	-47.50	12.92	-40.71	4.61	V	-32.40	56.52
	6,990.00	-57.19	11.75	-41.71	5.44	H	-35.40	59.52

- NOTES:**
1. Radiated Spurious Emission Measurements at 3 meters by Substitution Method according to ANSI/TIA/EIA-603-D-2010 June 24, 2010:
 2. We are performed all frequency to 10th harmonics from 30 MHz. Measurements above show only up to 3 maximum emissions noted, or would be lesser if no specific emissions from the EUT are recorded (ie: margin > 20 dB from the applicable limit) and considered that's already beyond the background noise floor.
 3. We have done x, y, z planes in EUT and horizontal and vertical polarization in detecting antenna.
 4. All of RB size has been tested for emissions and EIRP, with the 1RB configuration observed as the worst case
 5. We are performed 16QAM and QPSK modulations. The worst case data are reported in the table above.

7.3.6 RADIATED SPURIOUS EMISSIONS (20 MHz Band 4 LTE)

- ▣ OPERATING FREQUENCY: 1745.00 MHz
- ▣ MEASURED OUTPUT POWER: 24.19 dBm = 0.262 W
- ▣ MODULATION SIGNAL: 20 MHz QPSK
- ▣ DISTANCE: 3 meters
- ▣ LIMIT: $43 + 10 \log_{10}(W) =$ 37.19 dBc

Ch	Freq (MHz)	Measured Level (dBm)	Ant. Gain (dBi)	Substitute Level (dBm)	C.L	Pol	EIRP (dBm)	dBc
20050 (1720.0)	3,440.00	-55.76	12.23	-55.09	3.55	V	-46.41	70.60
	5,160.00	-45.74	12.80	-38.53	4.65	V	-30.38	54.57
	6,880.00	-57.22	11.97	-42.73	5.42	H	-36.18	60.37
20175 (1732.5)	3,465.00	-57.16	12.28	-56.27	3.52	V	-47.51	71.70
	5,197.50	-45.28	12.86	-38.14	4.74	V	-30.02	54.21
	6,930.00	-57.10	11.87	-41.70	5.57	V	-35.40	59.59
20300 (1745.0)	3,490.00	-56.03	12.33	-54.82	3.59	V	-46.08	70.27
	5,235.00	-47.24	12.91	-40.30	4.62	V	-32.01	56.20
	6,980.00	-56.91	11.77	-41.19	5.58	V	-35.00	59.19

- NOTES:**
1. Radiated Spurious Emission Measurements at 3 meters by Substitution Method according to ANSI/TIA/EIA-603-D-2010 June 24, 2010:
 2. We are performed all frequency to 10th harmonics from 30 MHz. Measurements above show only up to 3 maximum emissions noted, or would be lesser if no specific emissions from the EUT are recorded (ie: margin > 20 dB from the applicable limit) and considered that's already beyond the background noise floor.
 3. We have done x, y, z planes in EUT and horizontal and vertical polarization in detecting antenna.
 4. All of RB size has been tested for emissions and EIRP, with the 1RB configuration observed as the worst case
 5. We are performed 16QAM and QPSK modulations. The worst case data are reported in the table above.

8.3.7 RADIATED SPURIOUS EMISSIONS (5 MHz Band 17 LTE)

- ▣ OPERATING FREQUENCY: 713.50 MHz
- ▣ MEASURED OUTPUT POWER: 18.26 dBm = 0.067 W
- ▣ MODULATION SIGNAL: 5 MHz QPSK
- ▣ DISTANCE: 3 meters
- ▣ LIMIT: $43 + 10 \log_{10}(W) =$ 31.26 dBc

Ch	Freq (MHz)	Measured Level (dBm)	Ant. Gain (dBd)	Substitute Level (dBm)	C.L	Pol	ERP (dBm)	dBc
23755 (706.50)	1,413.00	-58.14	8.03	-57.81	2.21	H	-51.99	70.25
	2,119.50	-56.73	10.46	-55.77	2.73	H	-48.04	66.30
	2,826.00	-59.44	11.18	-57.04	3.15	V	-49.01	67.27
23790 (710.00)	1,420.00	-57.29	8.09	-57.18	2.24	H	-51.33	69.59
	2,130.00	-56.57	10.47	-55.15	2.72	H	-47.40	65.66
	2,840.00	-58.88	11.19	-56.48	3.13	V	-48.42	66.68
23825 (713.50)	1,427.00	-53.57	8.15	-53.79	2.22	H	-47.86	66.12
	2,140.50	-58.20	10.49	-56.72	2.74	H	-48.97	67.23
	2,854.00	-59.81	11.20	-57.40	3.13	V	-49.33	67.59

- NOTES:**
1. Radiated Spurious Emission Measurements at 3 meters by Substitution Method according to ANSI/TIA/EIA-603-D-2010 June 24, 2010:
 2. We are performed all frequency to 10th harmonics from 30 MHz. Measurements above show only up to 3 maximum emissions noted, or would be lesser if no specific emissions from the EUT are recorded (ie: margin > 20 dB from the applicable limit) and considered that's already beyond the background noise floor.
 3. We have done x, y, z planes in EUT and horizontal and vertical polarization in detecting antenna.
 4. All of RB size has been tested for emissions and ERP, with the 1RB configuration observed as the worst case
 5. We are performed 16QAM and QPSK modulations. The worst case data are reported in the table above.

8.3.8 RADIATED SPURIOUS EMISSIONS (10 MHz Band 17 LTE)

- ▣ OPERATING FREQUENCY: 710.00 MHz
- ▣ MEASURED OUTPUT POWER: 17.70 dBm = 0.059 W
- ▣ MODULATION SIGNAL: 10 MHz QPSK
- ▣ DISTANCE: 3 meters
- ▣ LIMIT: $43 + 10 \log_{10}(W) =$ 30.70 dBc

Ch	Freq (MHz)	Measured Level (dBm)	Ant. Gain (dBd)	Substitute Level (dBm)	C.L	Pol	ERP (dBm)	dBc
23780 (709.00)	1,418.00	-57.32	8.09	-57.21	2.24	H	-51.36	69.06
	2,127.00	-53.41	10.47	-51.99	2.72	H	-44.24	61.94
	2,836.00	-58.65	11.19	-56.21	3.14	V	-48.16	65.86
23790 (710.00)	1,420.00	-57.43	8.09	-57.32	2.24	H	-51.47	69.17
	2,130.00	-52.88	10.47	-51.46	2.72	H	-43.71	61.41
	2,840.00	-58.90	11.19	-56.50	3.13	V	-48.44	66.14
23800 (711.00)	1,422.00	-57.19	8.09	-57.08	2.24	H	-51.23	68.93
	2,133.00	-53.13	10.47	-51.71	2.72	H	-43.96	61.66
	2,844.00	-59.19	11.19	-56.77	3.13	V	-48.71	66.41

- NOTES:**
1. Radiated Spurious Emission Measurements at 3 meters by Substitution Method according to ANSI/TIA/EIA-603-D-2010 June 24, 2010:
 2. We are performed all frequency to 10th harmonics from 30 MHz. Measurements above show only up to 3 maximum emissions noted, or would be lesser if no specific emissions from the EUT are recorded (ie: margin > 20 dB from the applicable limit) and considered that's already beyond the background noise floor.
 3. We have done x, y, z planes in EUT and horizontal and vertical polarization in detecting antenna.
 4. All of RB size has been tested for emissions and ERP, with the 1RB configuration observed as the worst case
 5. We are performed 16QAM and QPSK modulations. The worst case data are reported in the table above.

8.4 PEAK-TO-AVERAGE RATIO

Band	Band Width	Frequency (MHz)	Modulation	Resource Block Size	Resource Block Offset	Data (dB)
4	1.4 MHz	1732.5	QPSK	6	0	5.00
			16-QAM	6		5.80
	3 MHz		QPSK	15		5.38
			16-QAM	15		6.14
	5 MHz		QPSK	25		5.35
			16-QAM	25		6.03
	10 MHz		QPSK	50		5.36
			16-QAM	50		5.99
	15 MHz		QPSK	75		5.40
			16-QAM	75		6.05
	20 MHz		QPSK	100		5.36
			16-QAM	100		6.06

- Plots of the EUT's Peak- to- Average Ratio are shown Page 55~ 60.

8.5 OCCUPIED BANDWIDTH

Band	Band Width (MHz)	Frequency (MHz)	Modulation	Resource Block Size	Resource Block Offset	Data (MHz)
4	1.4	1732.5	QPSK	6	0	1.0950
			16-QAM	6		1.0954
	3		QPSK	15		2.6964
			16-QAM	15		2.6974
	5		QPSK	25		4.5066
			16-QAM	25		4.5092
	10		QPSK	50		8.9882
			16-QAM	50		8.9592
	15		QPSK	75		13.4790
			16-QAM	75		13.4800
	20		QPSK	100		17.9450
			16-QAM	100		17.9900

Band	Band Width (MHz)	Frequency (MHz)	Modulation	Resource Block Size	Resource Block Offset	Data (MHz)
17	5	710.0	QPSK	25	0	4.5301
			16-QAM	25		4.5043
	10		QPSK	50		8.9917
			16-QAM	50		9.0025

- Plots of the EUT's Occupied Bandwidth are shown Page 47 ~ 54.

8.6 CONDUCTED SPURIOUS EMISSIONS

■FACTORS FOR FREQUENCY

Frequency Range (GHz)	Factor [dB]
0.03 – 1	27.145
1 – 5	26.960
5 – 10	27.542
10 – 15	28.439
15 – 20	29.144
Above 20	30.148

NOTES:

Factor(dB) = Cable Loss + Attenuator +Power Splitter

Band	Band Width (MHz)	Frequency (MHz)	Frequency of Maximum Harmonic (GHz)	Factor (dB)	Measurement Maximum Data (dBm)	Result (dBm)	Limit (dBm)
4	1.4	1710.7	18.6375	29.144	-56.05	-26.906	-13.00
		1732.5	19.6020	29.144	-55.51	-26.366	
		1754.3	16.6595	29.144	-55.96	-26.816	
	3	1711.5	18.6350	29.144	-55.88	-26.736	
		1732.5	16.8185	29.144	-55.54	-26.396	
		1753.5	18.6185	29.144	-56.12	-26.976	
	5	1712.5	19.8485	29.144	-55.24	-26.096	
		1732.5	18.8545	29.144	-55.59	-26.446	
		1752.5	16.6515	29.144	-56.06	-26.916	
	10	1715.0	18.9495	29.144	-55.41	-26.266	
		1732.5	16.8155	29.144	-55.59	-26.446	
		1750.0	19.5590	29.144	-55.53	-26.386	
	15	1717.5	17.4030	29.144	-56.24	-27.096	
		1732.5	19.2330	29.144	-55.60	-26.456	
		1747.5	16.4950	29.144	-55.83	-26.686	
	20	1720.0	18.5895	29.144	-55.83	-26.686	
		1732.5	18.8835	29.144	-55.72	-26.576	
		1745.0	18.8360	29.144	-55.87	-26.726	

Band	Band Width (MHz)	Frequency (MHz)	Frequency of Maximum Harmonic (GHz)	Factor (dB)	Measurement Maximum Data (dBm)	Result (dBm)	Limit (dBm)
17	5	706.5	3.7324	26.960	-60.748	-33.788	-13.00
		710.0	3.1506	26.960	-60.255	-33.295	
		713.5	3.7139	26.960	-60.062	-33.102	
	10	709.0	2.7284	26.960	-59.432	-32.472	
		710.0	6.3081	27.542	-59.380	-31.838	
		711.0	5.9203	27.542	-58.800	-31.258	

NOTES:

1. Conducted Spurious Emissions was Tested QPSK Modulation, Resource Block Size 1 and Resource Block Offset 0
2. Result (dBm) = Measurement Maximum Data (dBm) + Factor (dB)

- Plots of the EUT's Conducted Spurious Emissions are shown Page 84 ~ 104.

8.6.1 BAND EDGE

- Plots of the EUT's Band Edge are shown Page 61 ~ 83.

8.7 FREQUENCY STABILITY / VARIATION OF AMBIENT TEMPERATURE

8.7.1 FREQUENCY STABILITY (1.4 MHz Band 4 LTE)

- ▣ OPERATING FREQUENCY: 1732,500,000 Hz
- ▣ CHANNEL: 20175 (1.4 MHz)
- ▣ REFERENCE VOLTAGE: 3.85 VDC
- ▣ DEVIATION LIMIT: Emission must remain in band

Voltage (%)	Power (VDC)	Temp. (°C)	Frequency (Hz)	Frequency Error (Hz)	Deviation (%)	ppm
100%	3.85	+20(Ref)	1732 500 005	0.0	0.000 000	0.000
100%		-30	1732 500 010	4.8	0.000 000	0.003
100%		-20	1732 500 009	3.6	0.000 000	0.002
100%		-10	1732 500 008	3.0	0.000 000	0.002
100%		0	1732 500 010	4.7	0.000 000	0.003
100%		+10	1732 500 010	4.7	0.000 000	0.003
100%		+30	1732 500 009	4.4	0.000 000	0.003
100%		+40	1732 500 010	5.1	0.000 000	0.003
100%		+50	1732 500 009	3.7	0.000 000	0.002
Batt. Endpoint	3.60	+20	1732 500 001	-4.4	0.000 000	-0.003

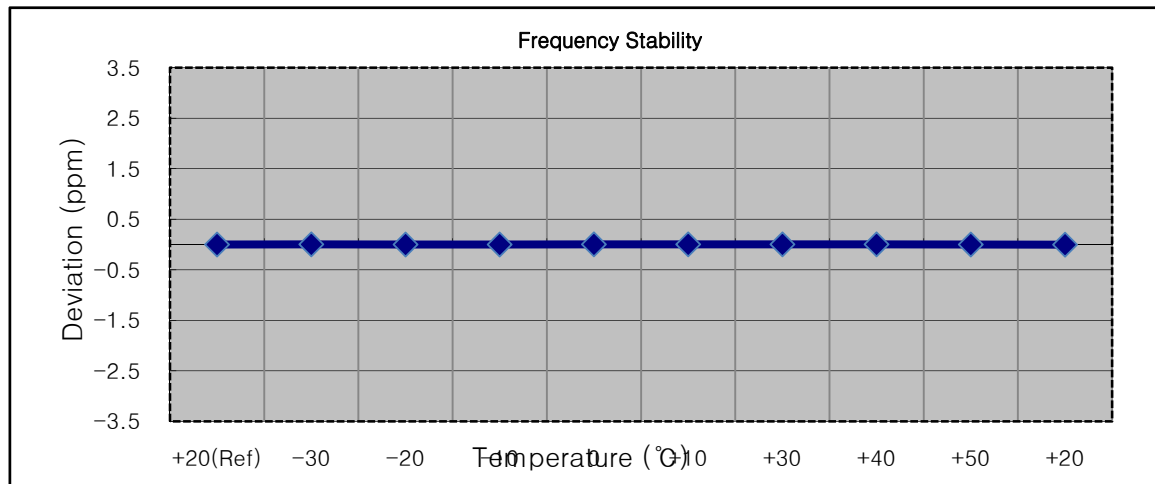

8.7.2 FREQUENCY STABILITY (3 MHz Band 4 LTE)

- ▣ OPERATING FREQUENCY: 1732,500,000 Hz
- ▣ CHANNEL: 20175 (3 MHz)
- ▣ REFERENCE VOLTAGE: 3.85 VDC
- ▣ DEVIATION LIMIT: Emission must remain in band

Voltage (%)	Power (VDC)	Temp. (°C)	Frequency (Hz)	Frequency Error (Hz)	Deviation (%)	ppm
100%	3.85	+20(Ref)	1732 500 005	0.0	0.000 000	0.000
100%		-30	1732 499 999	-5.8	0.000 000	-0.003
100%		-20	1732 500 009	4.2	0.000 000	0.002
100%		-10	1732 500 000	-4.8	0.000 000	-0.003
100%		0	1732 500 012	6.9	0.000 000	0.004
100%		+10	1732 499 999	-5.2	0.000 000	-0.003
100%		+30	1732 500 010	5.1	0.000 000	0.003
100%		+40	1732 500 013	8.5	0.000 000	0.005
100%		+50	1732 500 001	-3.3	0.000 000	-0.002
Batt. Endpoint	3.60	+20	1732 500 010	5.4	0.000 000	0.003

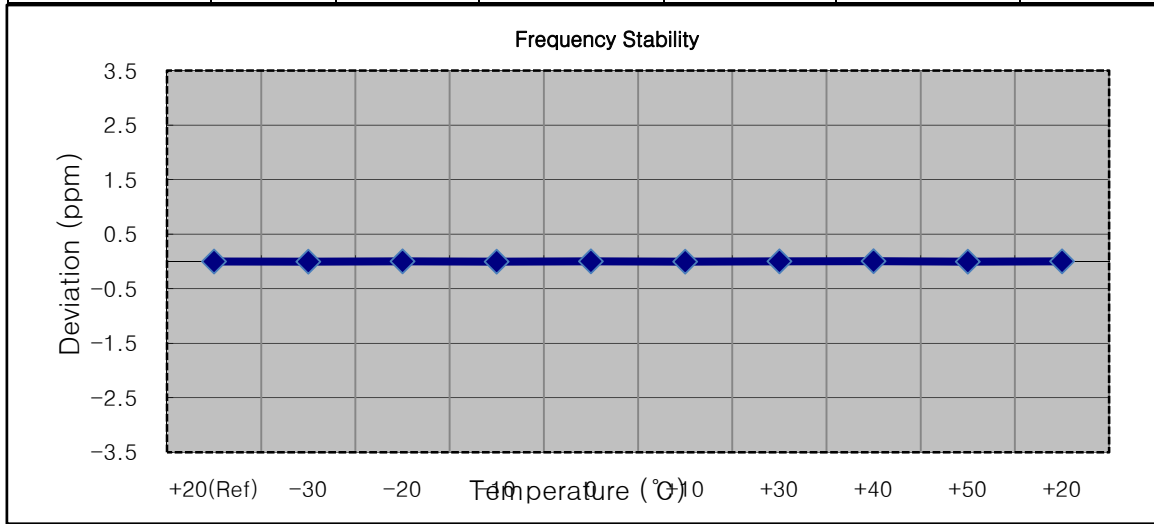

8.7.3 FREQUENCY STABILITY (5 MHz Band 4 LTE)

- ▣ OPERATING FREQUENCY: 1732,500,000 Hz
- ▣ CHANNEL: 20175 (5 MHz)
- ▣ REFERENCE VOLTAGE: 3.85 VDC
- ▣ DEVIATION LIMIT: Emission must remain in band

Voltage (%)	Power (VDC)	Temp. (°C)	Frequency (Hz)	Frequency Error (Hz)	Deviation (%)	ppm
100%	3.85	+20(Ref)	1732 499 994	0.0	0.000 000	0.000
100%		-30	1732 499 989	-5.3	0.000 000	-0.003
100%		-20	1732 499 987	-7.3	0.000 000	-0.004
100%		-10	1732 499 990	-4.5	0.000 000	-0.003
100%		0	1732 499 999	4.7	0.000 000	0.003
100%		+10	1732 499 998	3.8	0.000 000	0.002
100%		+30	1732 499 990	-4.0	0.000 000	-0.002
100%		+40	1732 499 988	-6.7	0.000 000	-0.004
100%		+50	1732 499 990	-4.6	0.000 000	-0.003
Batt. Endpoint	3.60	+20	1732 499 990	-4.5	0.000 000	-0.003

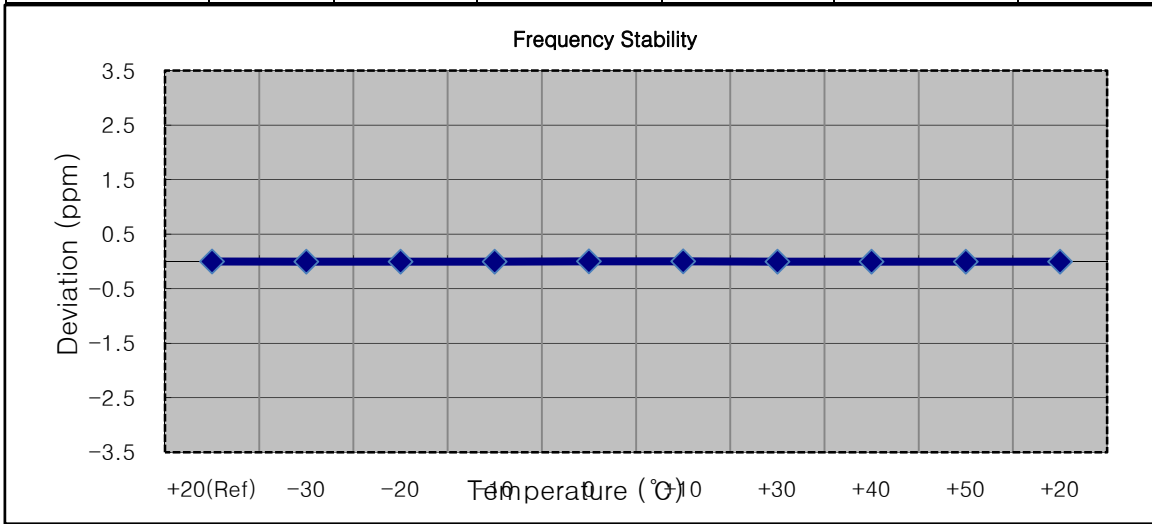

8.7.4 FREQUENCY STABILITY (10 MHz Band 4 LTE)

- ▣ OPERATING FREQUENCY: 1732,500,000 Hz
- ▣ CHANNEL: 20175 (10 MHz)
- ▣ REFERENCE VOLTAGE: 3.85 VDC
- ▣ DEVIATION LIMIT: Emission must remain in band

Voltage (%)	Power (VDC)	Temp. (°C)	Frequency (Hz)	Frequency Error (Hz)	Deviation (%)	ppm
100%	3.85	+20(Ref)	1732 500 005	0.0	0.000 000	0.000
100%		-30	1732 499 999	-5.8	0.000 000	-0.003
100%		-20	1732 499 996	-8.4	0.000 000	-0.005
100%		-10	1732 500 011	6.0	0.000 000	0.003
100%		0	1732 500 009	4.2	0.000 000	0.002
100%		+10	1732 499 999	-5.9	0.000 000	-0.003
100%		+30	1732 500 001	-3.1	0.000 000	-0.002
100%		+40	1732 500 000	-4.1	0.000 000	-0.002
100%		+50	1732 500 000	-4.6	0.000 000	-0.003
Batt. Endpoint		3.60	+20	1732 500 010	5.6	0.000 000

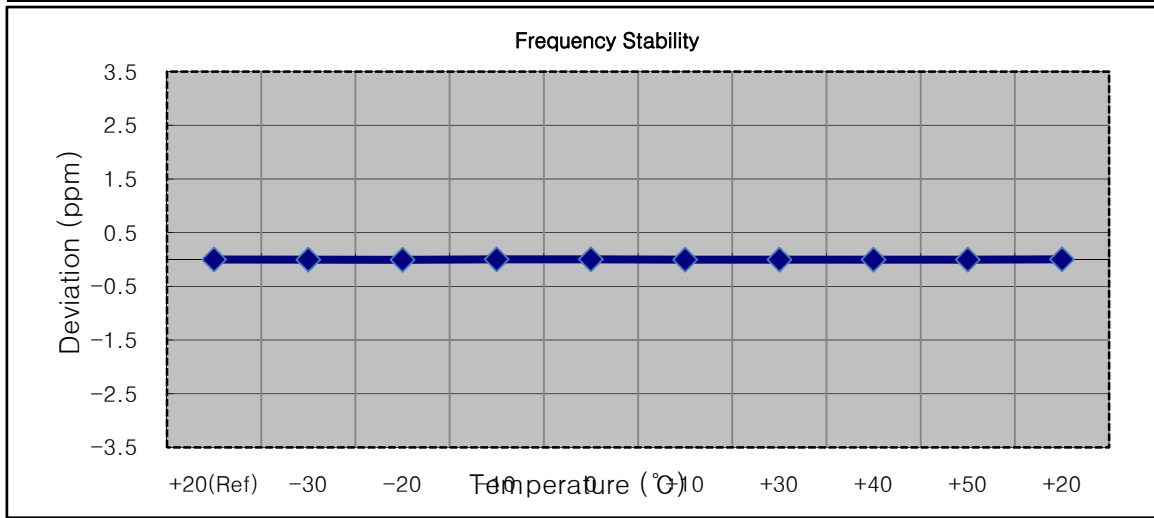

8.7.5 FREQUENCY STABILITY (15 MHz Band 4 LTE)

- ▣ OPERATING FREQUENCY: 1732,500,000 Hz
- ▣ CHANNEL: 20175 (15 MHz)
- ▣ REFERENCE VOLTAGE: 3.85 VDC
- ▣ DEVIATION LIMIT: Emission must remain in band

Voltage (%)	Power (VDC)	Temp. (°C)	Frequency (Hz)	Frequency Error (Hz)	Deviation (%)	ppm
100%	3.85	+20(Ref)	1732 500 005	0.0	0.000 000	0.000
100%		-30	1732 499 998	-7.2	0.000 000	-0.004
100%		-20	1732 500 000	-4.8	0.000 000	-0.003
100%		-10	1732 500 001	-3.7	0.000 000	-0.002
100%		0	1732 500 002	-3.4	0.000 000	-0.002
100%		+10	1732 500 002	-2.9	0.000 000	-0.002
100%		+30	1732 500 010	4.7	0.000 000	0.003
100%		+40	1732 500 001	-4.0	0.000 000	-0.002
100%		+50	1732 499 999	-6.4	0.000 000	-0.004
Batt. Endpoint		3.60	+20	1732 499 999	-5.8	0.000 000

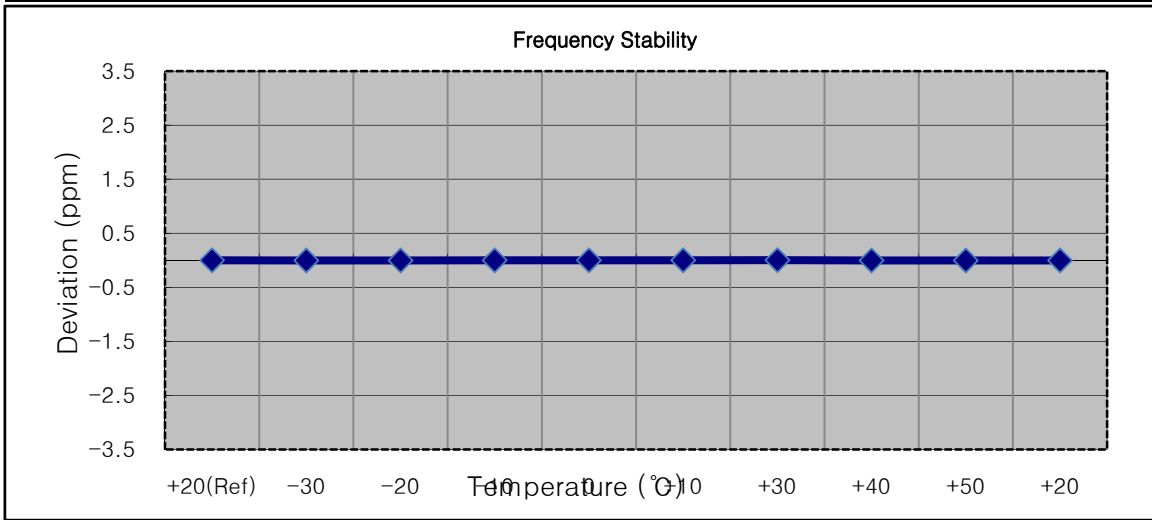

8.7.6 FREQUENCY STABILITY (20 MHz Band 4 LTE)

- ▣ OPERATING FREQUENCY: 1732,500,000 Hz
- ▣ CHANNEL: 20175 (20 MHz)
- ▣ REFERENCE VOLTAGE: 3.85 VDC
- ▣ DEVIATION LIMIT: Emission must remain in band

Voltage (%)	Power (VDC)	Temp. (°C)	Frequency (Hz)	Frequency Error (Hz)	Deviation (%)	ppm
100%	3.85	+20(Ref)	1732 500 003	0.0	0.000 000	0.000
100%		-30	1732 500 007	3.7	0.000 000	0.002
100%		-20	1732 500 011	8.0	0.000 000	0.005
100%		-10	1732 500 009	6.4	0.000 000	0.004
100%		0	1732 500 009	5.9	0.000 000	0.003
100%		+10	1732 500 010	6.8	0.000 000	0.004
100%		+30	1732 500 009	6.1	0.000 000	0.004
100%		+40	1732 499 998	-4.6	0.000 000	-0.003
100%		+50	1732 499 997	-5.9	0.000 000	-0.003
Batt. Endpoint	3.60	+20	1732 499 999	-4.2	0.000 000	-0.002

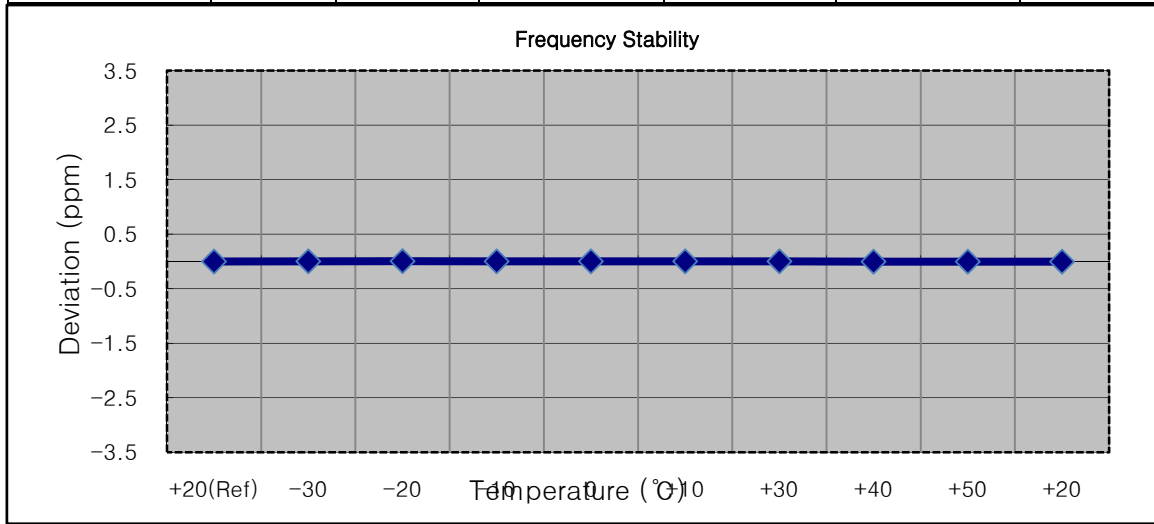

8.7.7 FREQUENCY STABILITY (5 MHz Band 17 LTE)

- ▣ OPERATING FREQUENCY: 710,000,000 Hz
- ▣ CHANNEL: 23790 (5 MHz)
- ▣ REFERENCE VOLTAGE: 3.85 VDC
- ▣ DEVIATION LIMIT: Emission must remain in band

Voltage (%)	Power (VDC)	Temp. (°C)	Frequency (Hz)	Frequency Error (Hz)	Deviation (%)	ppm
100%	3.85	+20(Ref)	710 000 004	0.0	0.000 000	0.0000
100%		-30	710 000 000	-4.7	-0.000 001	-0.0066
100%		-20	710 000 000	-4.5	-0.000 001	-0.0063
100%		-10	710 000 000	-4.4	-0.000 001	-0.0062
100%		0	710 000 000	-4.4	-0.000 001	-0.0062
100%		+10	710 000 008	3.3	0.000 000	0.0046
100%		+30	710 000 000	-4.1	-0.000 001	-0.0058
100%		+40	710 000 001	-3.6	-0.000 001	-0.0051
100%		+50	710 000 001	-3.3	0.000 000	-0.0046
Batt. Endpoint	3.60	+20	710 000 010	5.2	0.000 001	0.0073

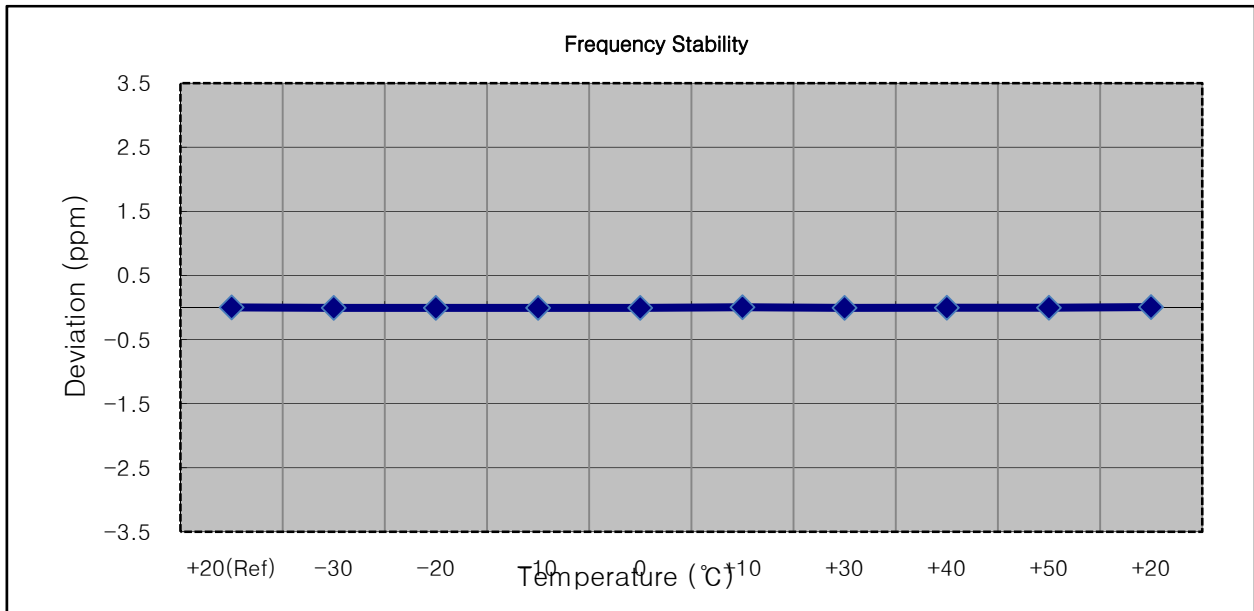

8.7.8 FREQUENCY STABILITY (10 MHz Band 17 LTE)

- ▣ OPERATING FREQUENCY: 710,000,000 Hz
- ▣ CHANNEL: 23790 (10 MHz)
- ▣ REFERENCE VOLTAGE: 3.85 VDC
- ▣ DEVIATION LIMIT: Emission must remain in band

Voltage (%)	Power (VDC)	Temp. (°C)	Frequency (Hz)	Frequency Error (Hz)	Deviation (%)	ppm
100%	3.85	+20(Ref)	709 999 994	0.0	0.000 000	0.0000
100%		-30	709 999 997	3.0	0.000 000	0.0042
100%		-20	709 999 998	4.2	0.000 001	0.0059
100%		-10	709 999 996	2.3	0.000 000	0.0032
100%		0	709 999 999	5.4	0.000 001	0.0076
100%		+10	709 999 998	4.2	0.000 001	0.0059
100%		+30	709 999 990	-4.5	-0.000 001	-0.0063
100%		+40	709 999 999	5.4	0.000 001	0.0076
100%		+50	709 999 997	3.2	0.000 000	0.0045
Batt. Endpoint	3.60	+20	709 999 990	-4.4	-0.000 001	-0.0062

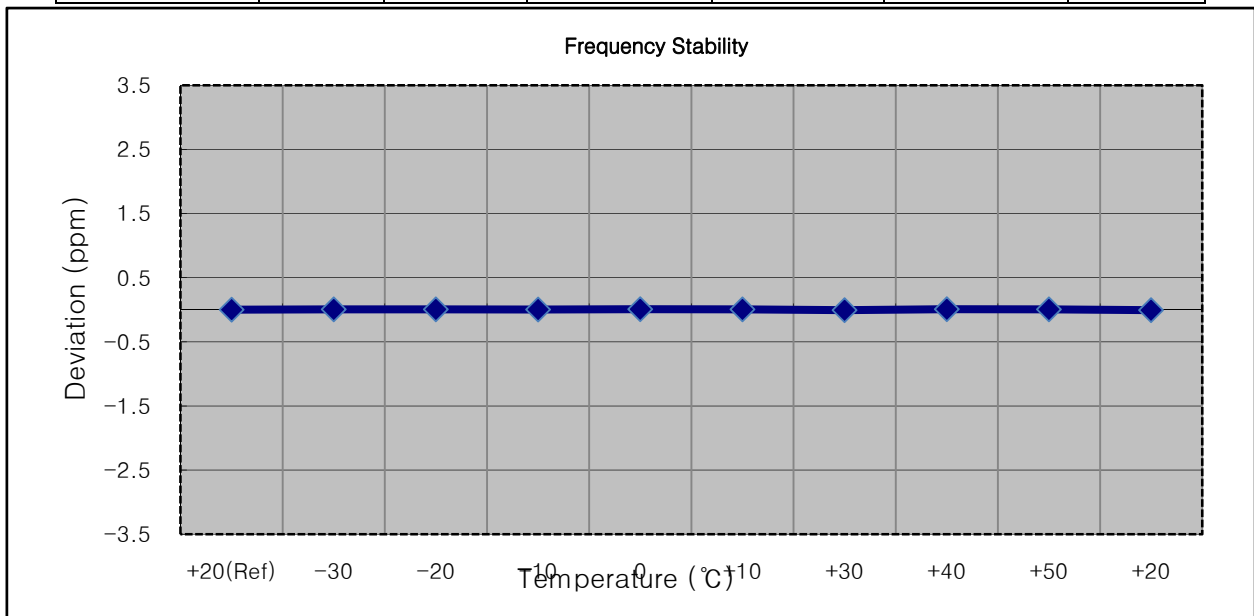

9. TEST PLOTS

BAND 4. Occupied Bandwidth Plot (1.4M BW Ch.20175 QPSK RB 6)

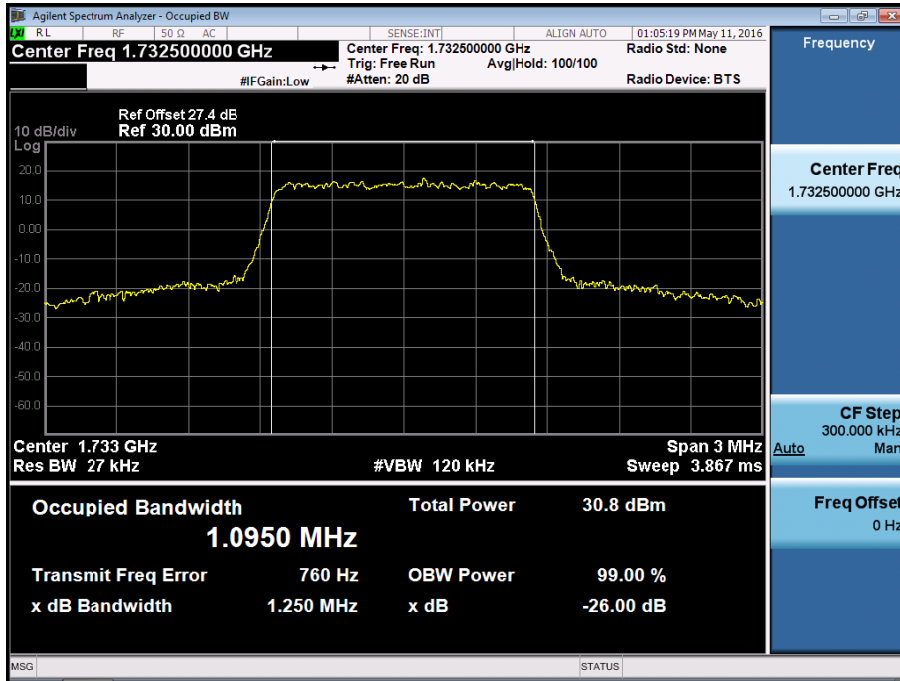

BAND 4. Occupied Bandwidth Plot (1.4M BW Ch.20175 16QAM RB 6)

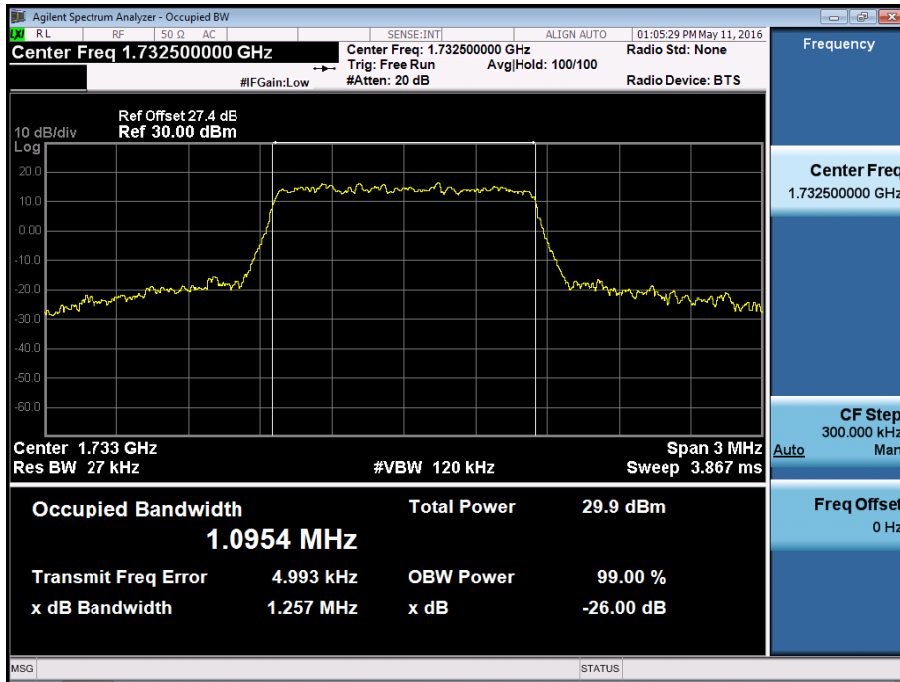

BAND 4. Occupied Bandwidth Plot (3M BW Ch.20175 QPSK RB 15)

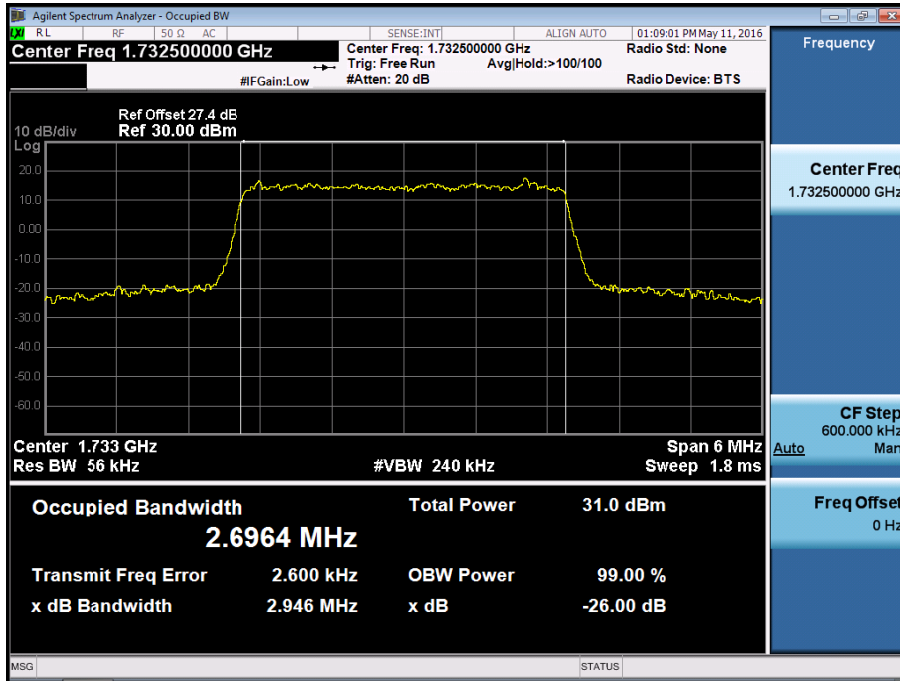

BAND 4. Occupied Bandwidth Plot (3M BW Ch.20175 16QAM RB 15)

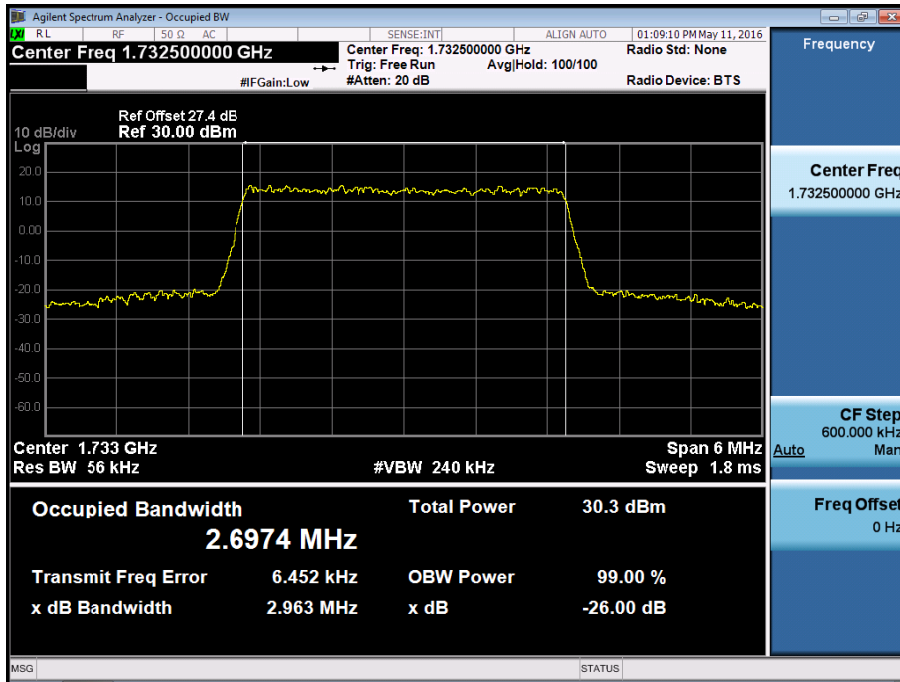

BAND 4. Occupied Bandwidth Plot (5M BW Ch.20175 QPSK RB 25)

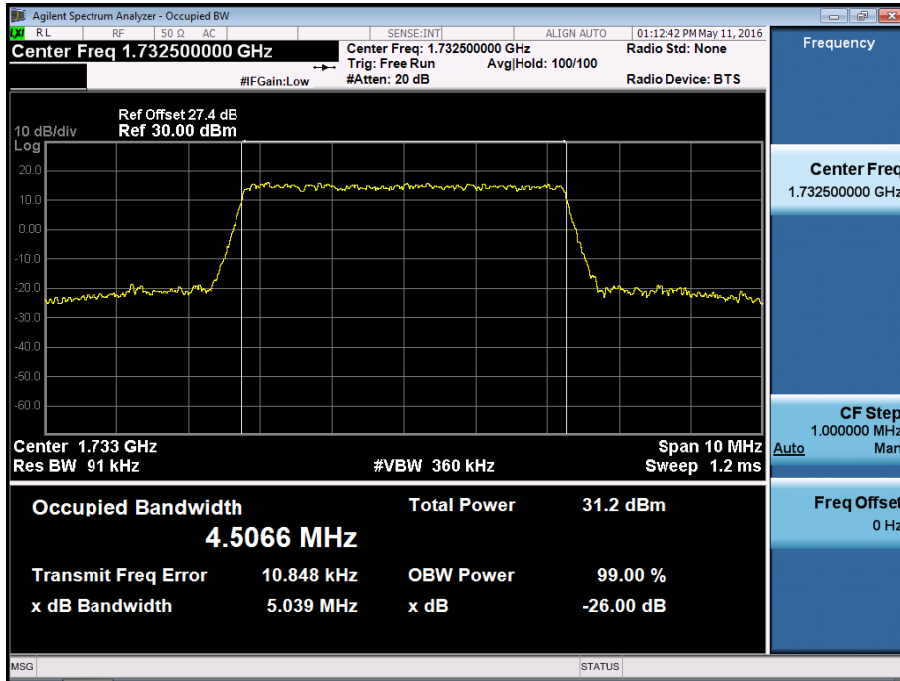

BAND 4. Occupied Bandwidth Plot (5M BW Ch.20175 16QAM RB 25)

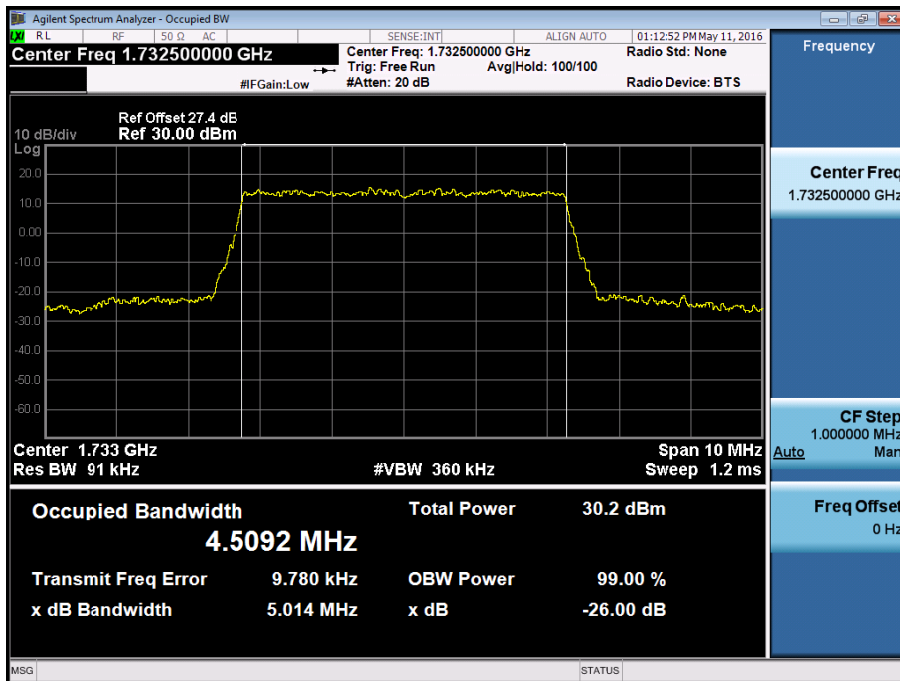

BAND 4. Occupied Bandwidth Plot (10M BW Ch.20175 QPSK RB 50)

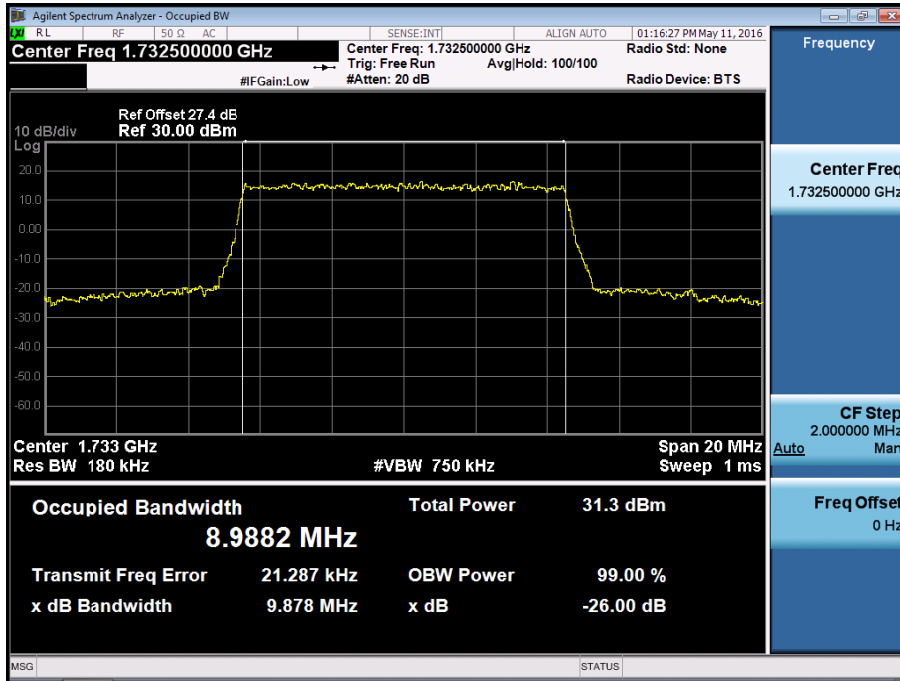

BAND 4. Occupied Bandwidth Plot (10M BW Ch.20175 16QAM RB 50)

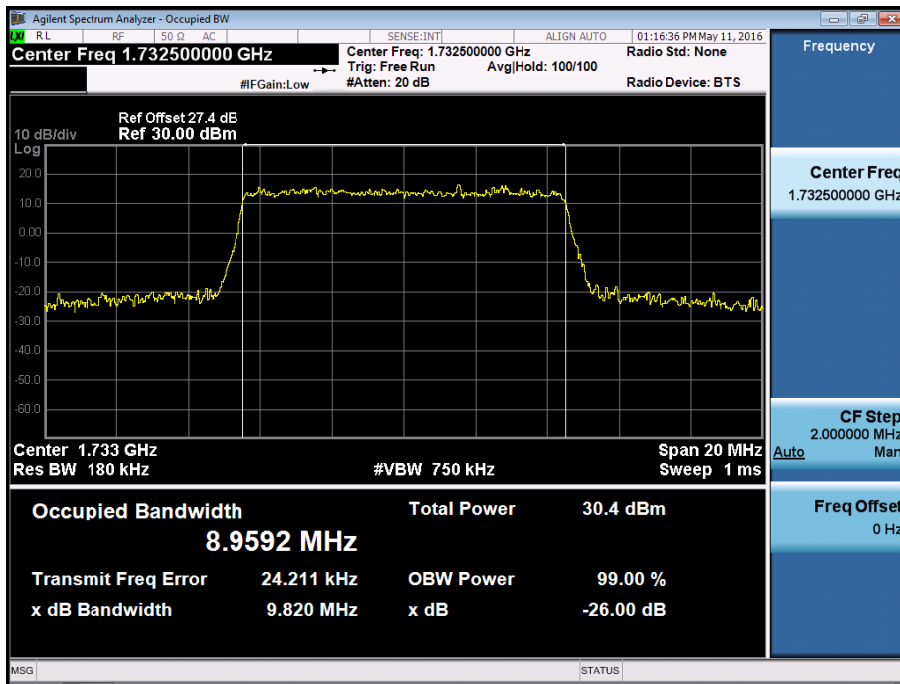

BAND 4. Occupied Bandwidth Plot (15M BW Ch.20175 QPSK RB 75)

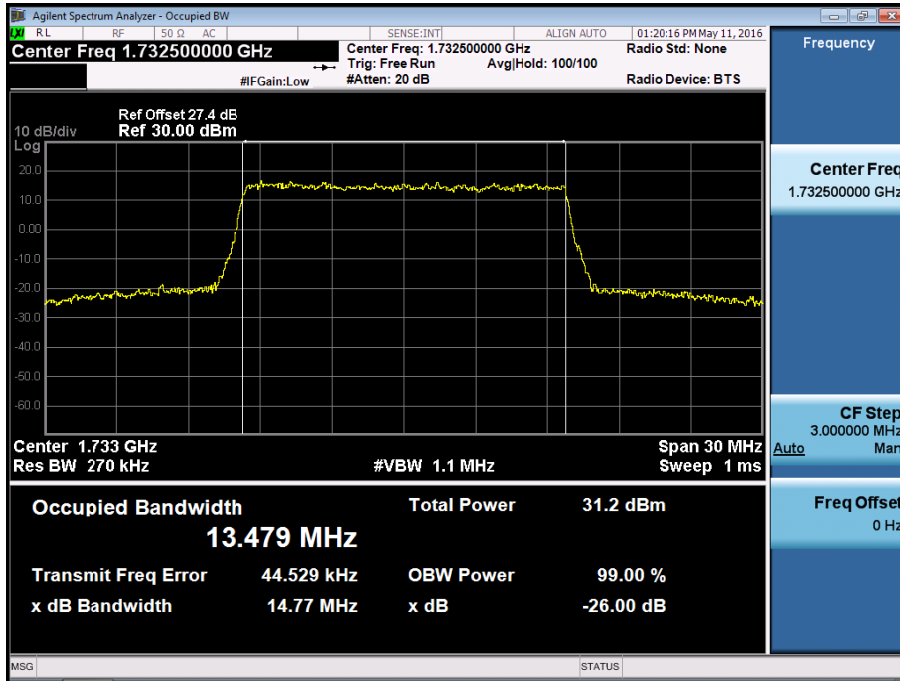

BAND 4. Occupied Bandwidth Plot (15M BW Ch.20175 16QAM RB 75)

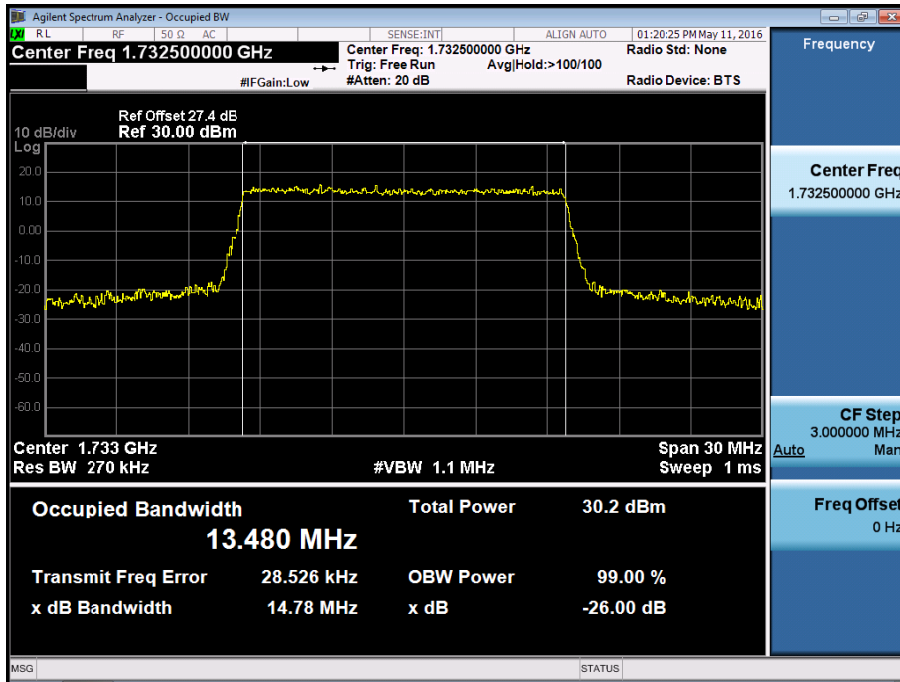

BAND 4. Occupied Bandwidth Plot (20M BW Ch.20175 QPSK RB 100)

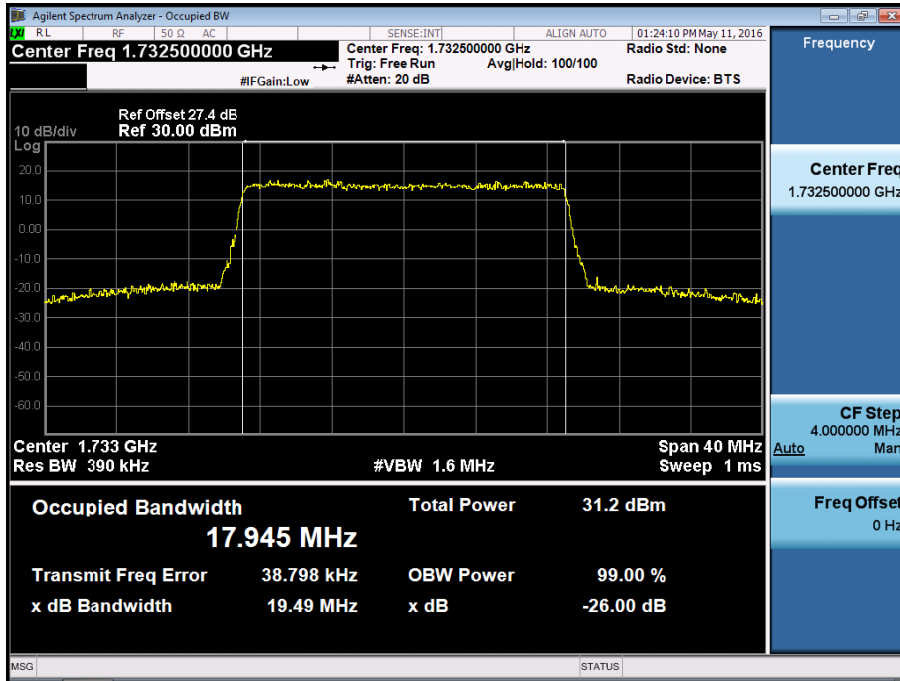

BAND 4. Occupied Bandwidth Plot (20M BW Ch.20175 16QAM RB 100)

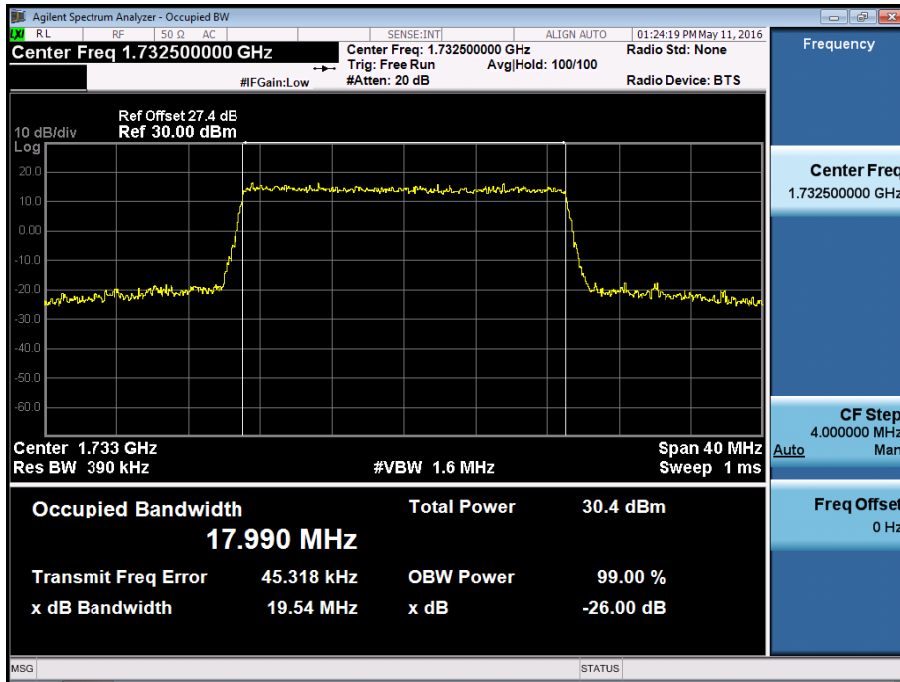

BAND 17. Occupied Bandwidth Plot (5M BW Ch.23790 QPSK RB 25)

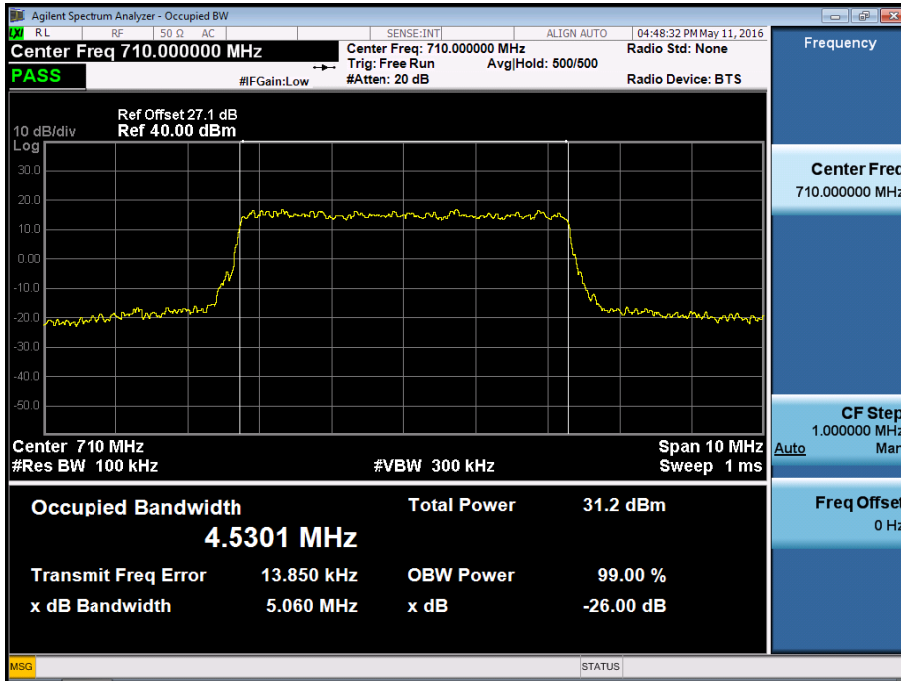

BAND 17. Occupied Bandwidth Plot (5M BW Ch.23790 16QAM RB 25)

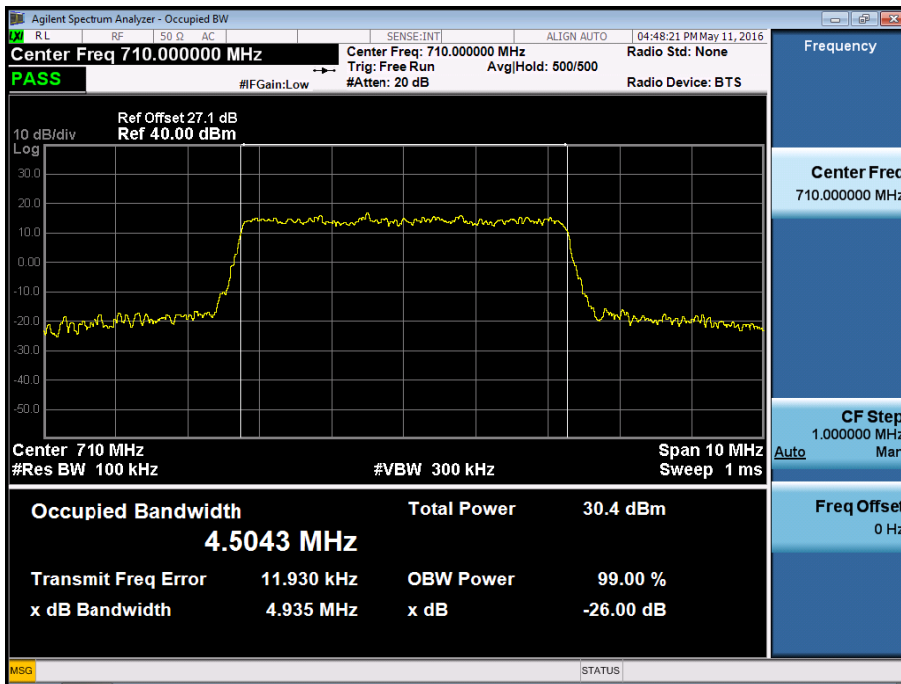

BAND 17. Occupied Bandwidth Plot (10M BW Ch.23790 QPSK RB 50)

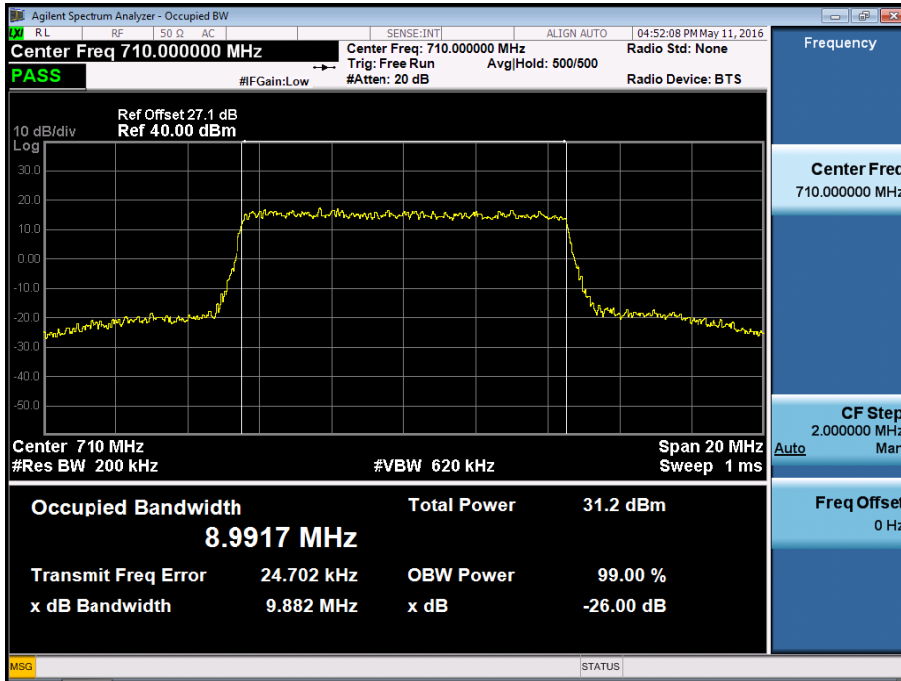

BAND 17. Occupied Bandwidth Plot (10M BW Ch.23790 16QAMRB 50)

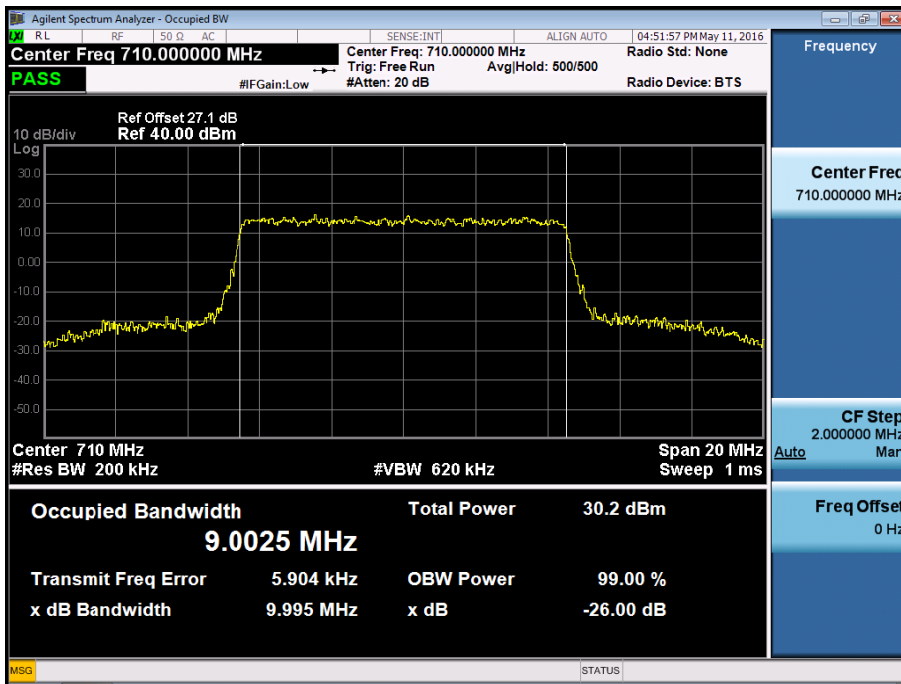

BAND 4. PAR Plot (1.4M BW_Ch.20175_QPSK_RB6_0)

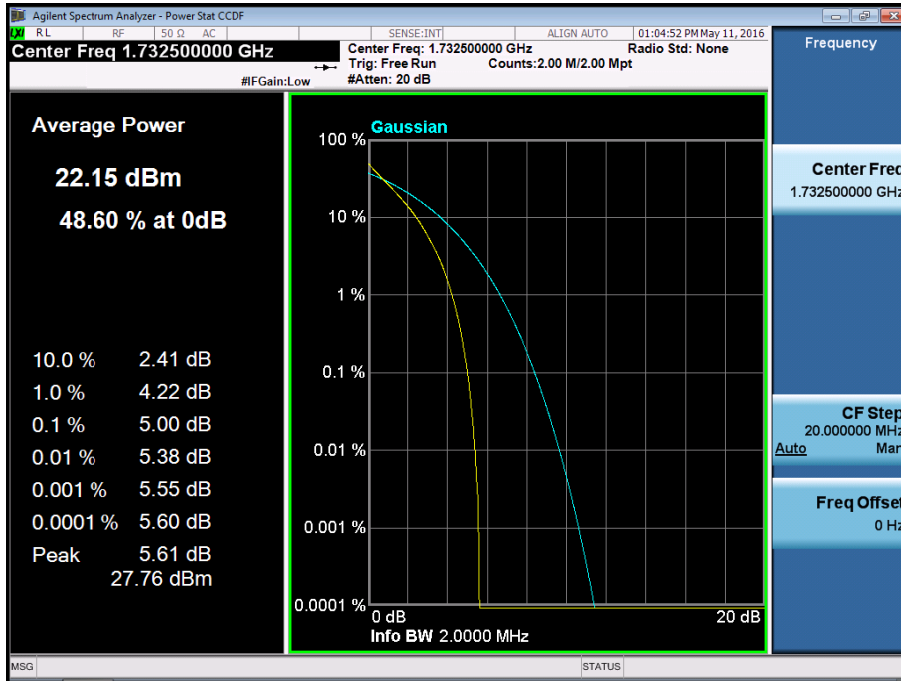

BAND 4. PAR Plot (1.4M BW_Ch.20175_16QAM_RB6_0)

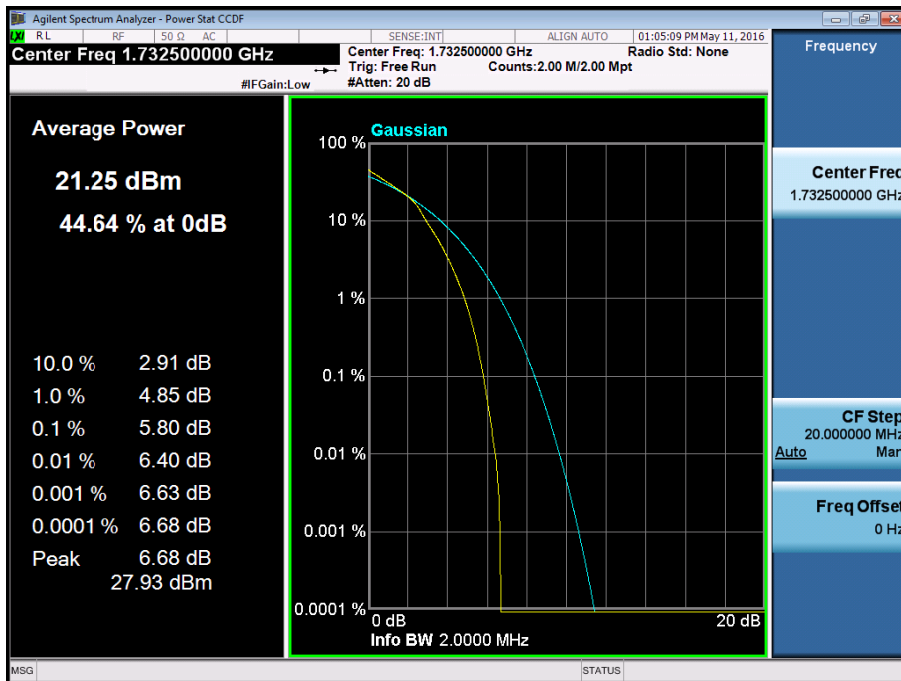

BAND 4. PAR Plot (3M BW_Ch.20175_QPSK_RB15_0)

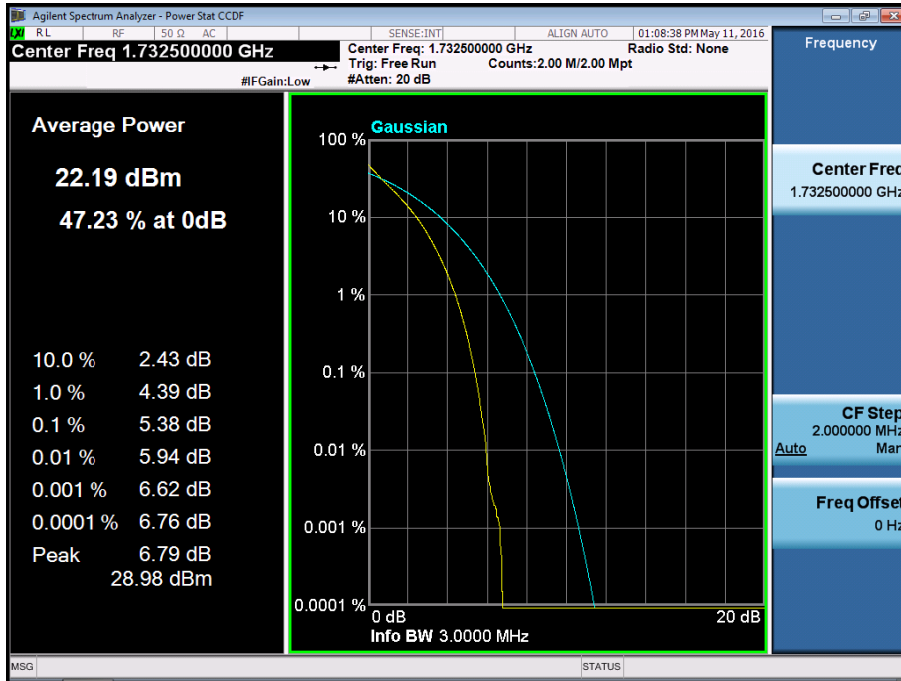

BAND 4. PAR Plot (3M BW_Ch.20175_16QAM_RB15_0)

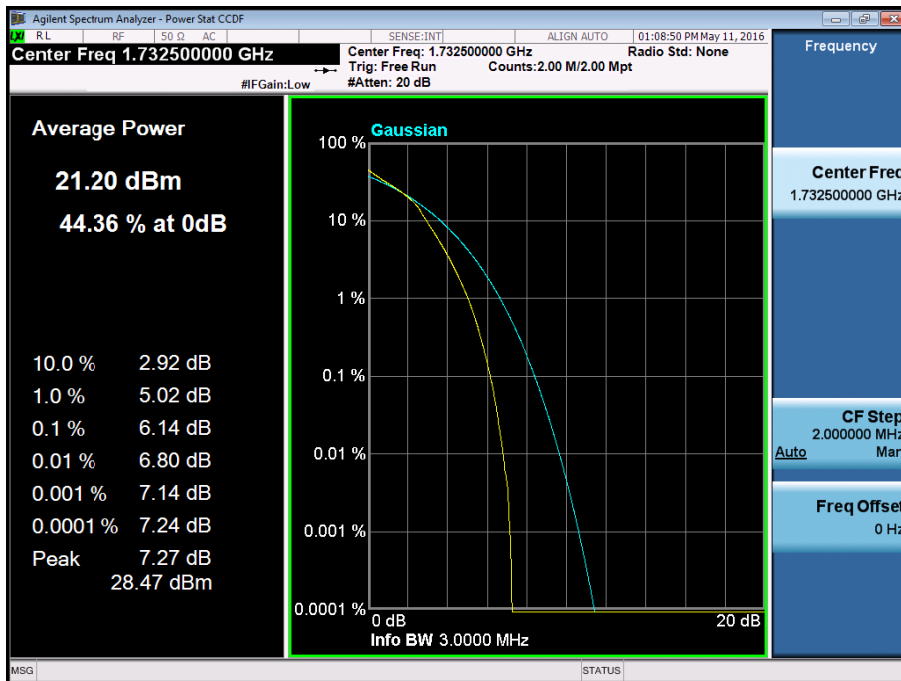

BAND 4. PAR Plot (5M BW_Ch.20175_QPSK_RB25_0)

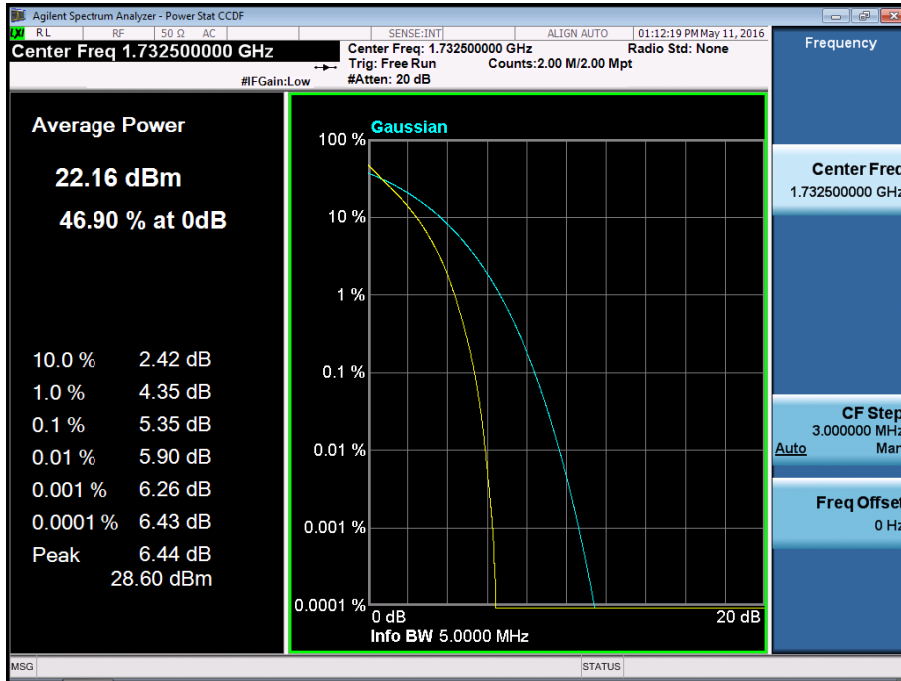

BAND 4. PAR Plot (5M BW_Ch.20175_16QAM_RB25_0)

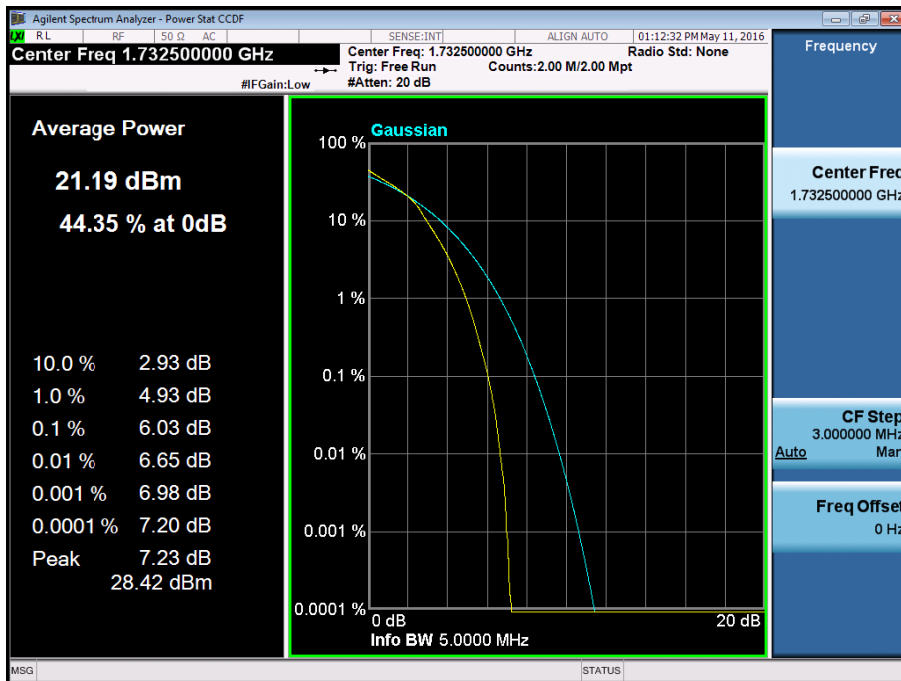

BAND 4. PAR Plot (10M BW_Ch.20175_QPSK_RB50_0)

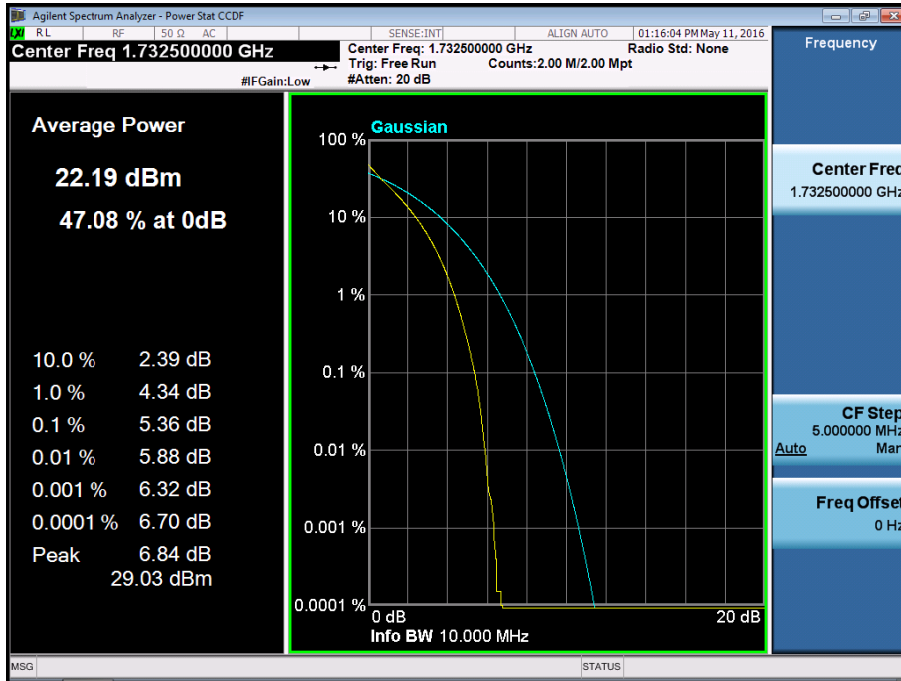

BAND 4. PAR Plot (10M BW_Ch.20175_16QAM_RB50_0)

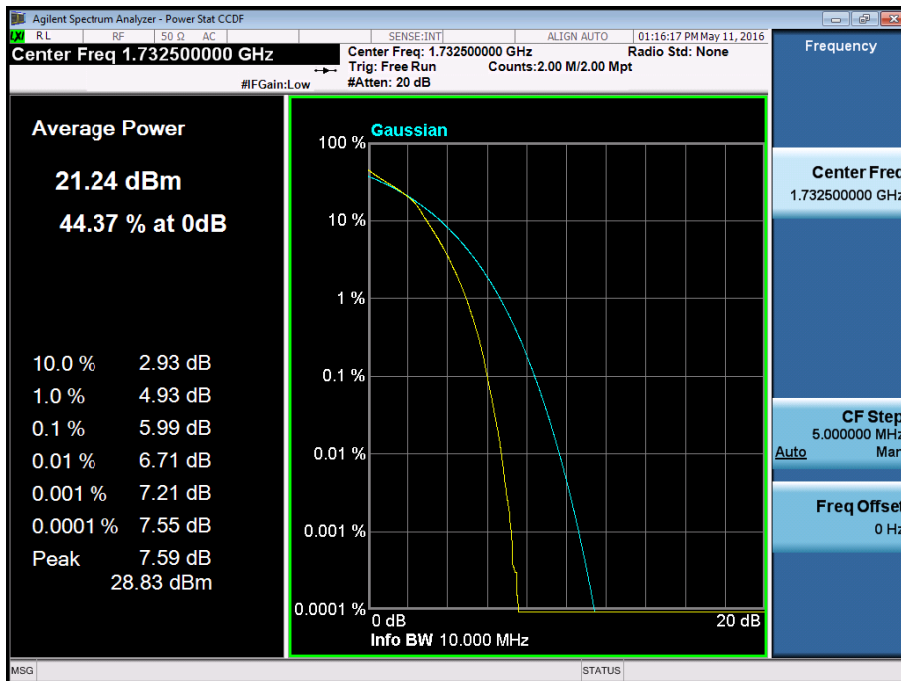

BAND 4. PAR Plot (15M BW_Ch.20175_QPSK_RB75_0)

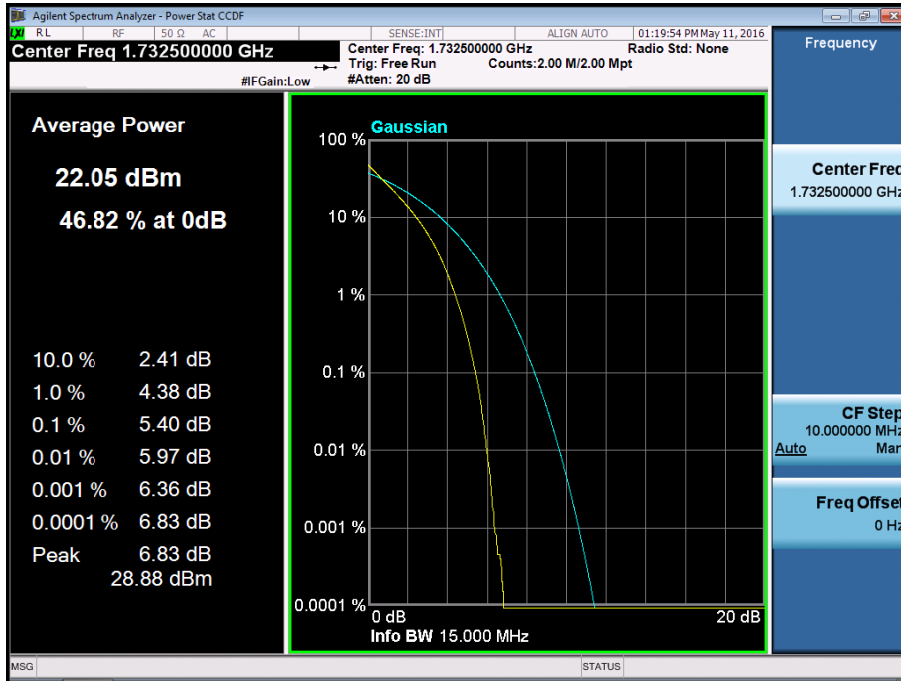

BAND 4. PAR Plot (15M BW_Ch.20175_16QAM_RB75_0)

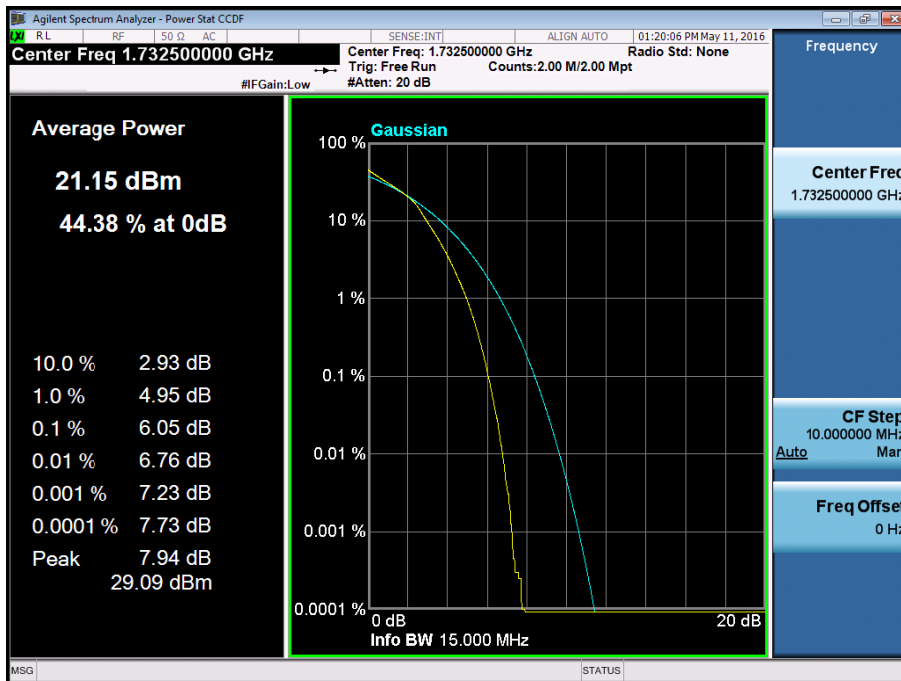

BAND 4. PAR Plot (20M BW_Ch.20175_QPSK_RB100_0)

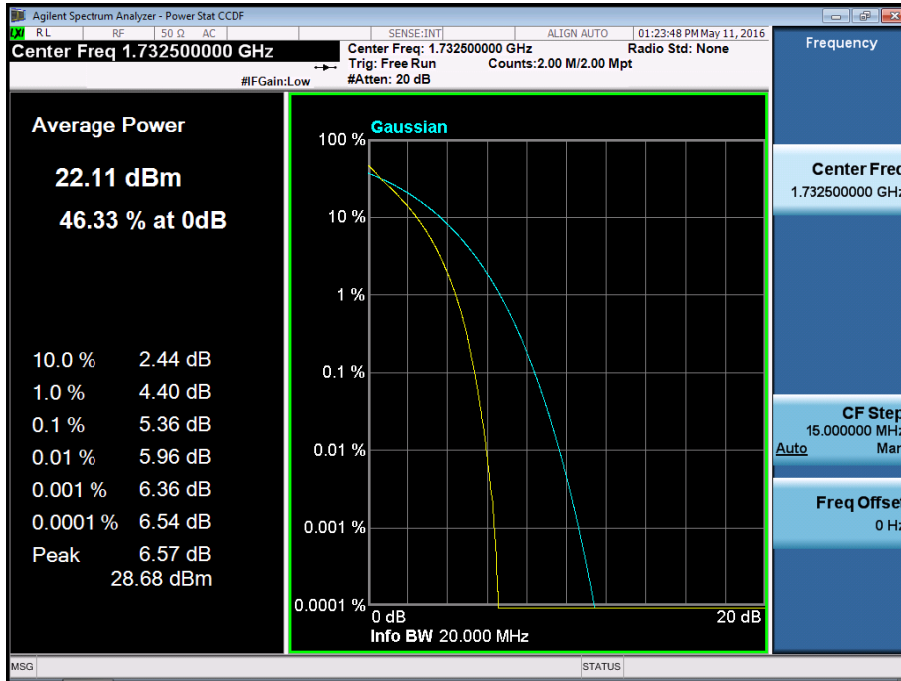

BAND 4. PAR Plot (20M BW_Ch.20175_16QAM_RB100_0)

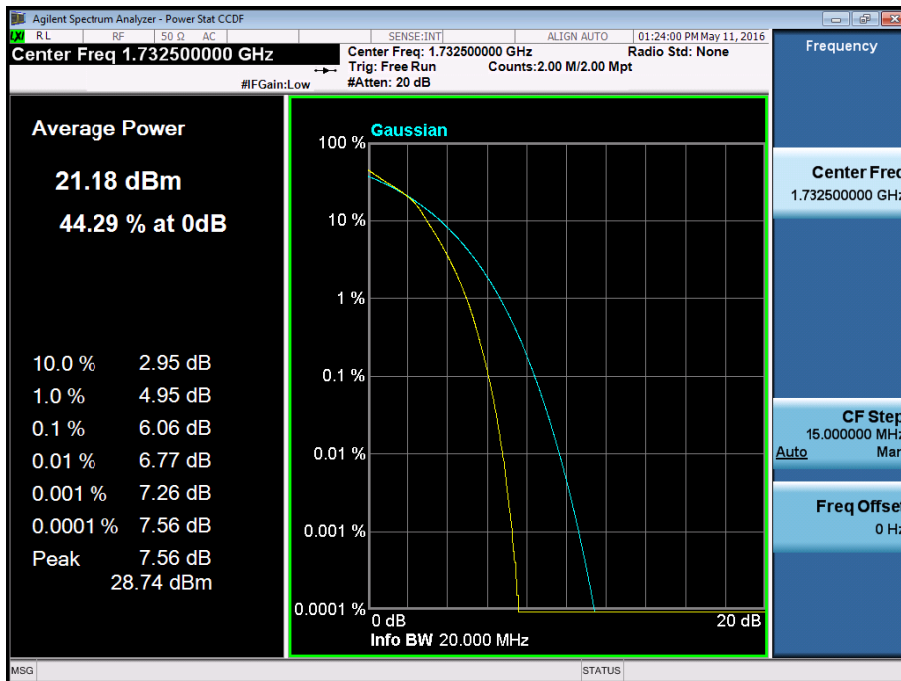

BAND 4. Lower Band Edge Plot (1.4M BW Ch.19957 QPSK RB 1, Offset 0) -1

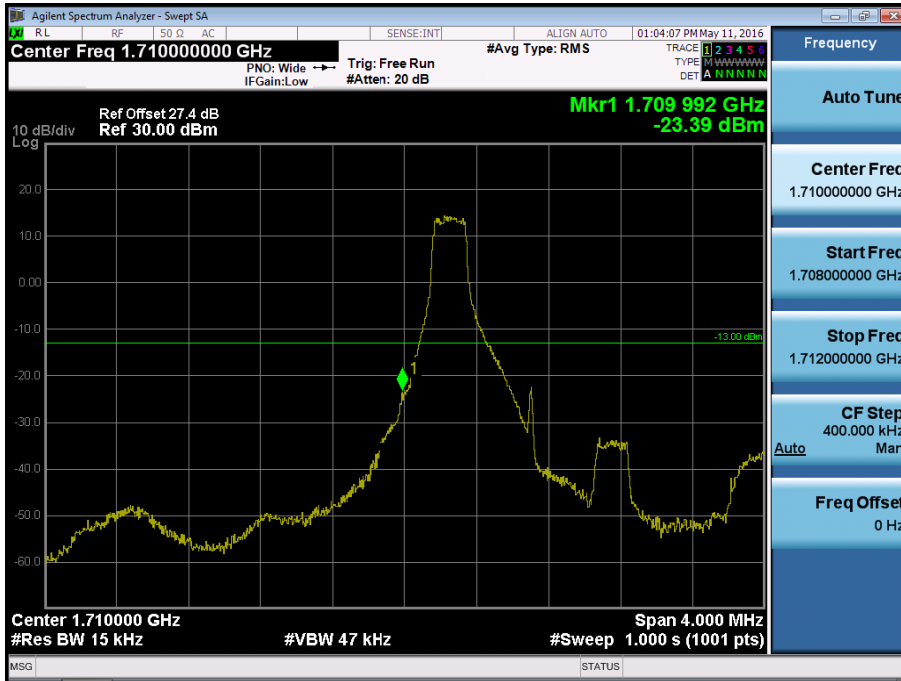

BAND 4. Lower Band Edge Plot (1.4M BW Ch.19957 QPSK RB 6) -2

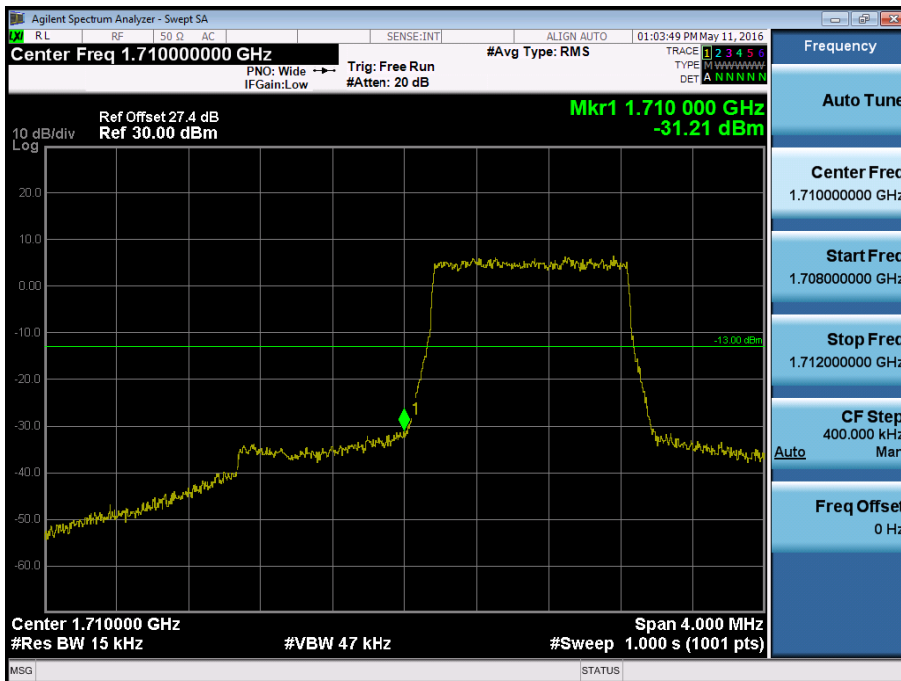

BAND 4. Lower Extended Band Edge Plot (1.4M BW Ch.19957 QPSK_RB6_0) -3

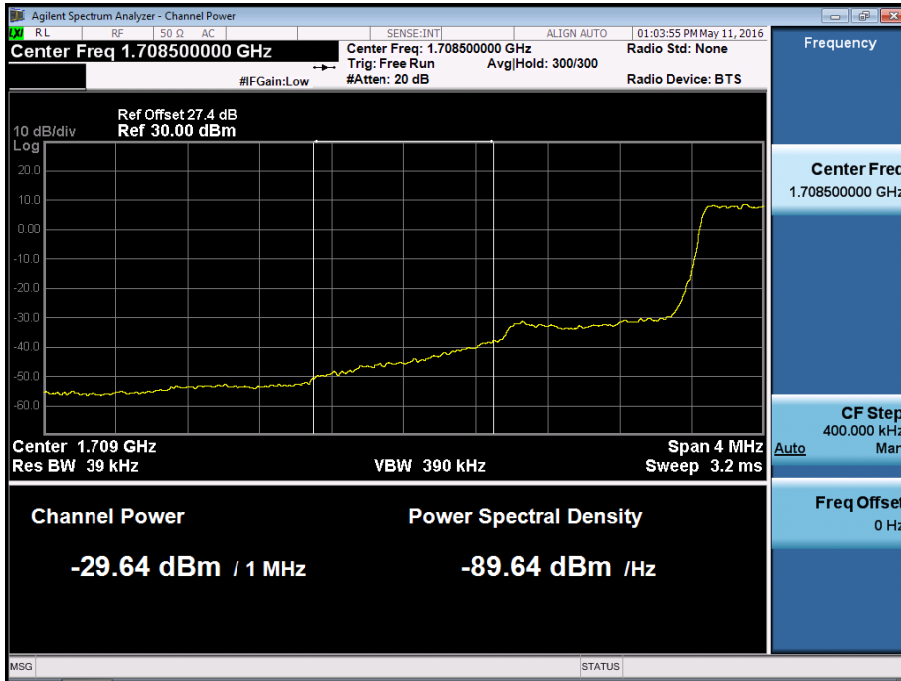

BAND 4. Lower Band Edge Plot (3M BW Ch.19965 QPSK RB 1, Offset 0) -1

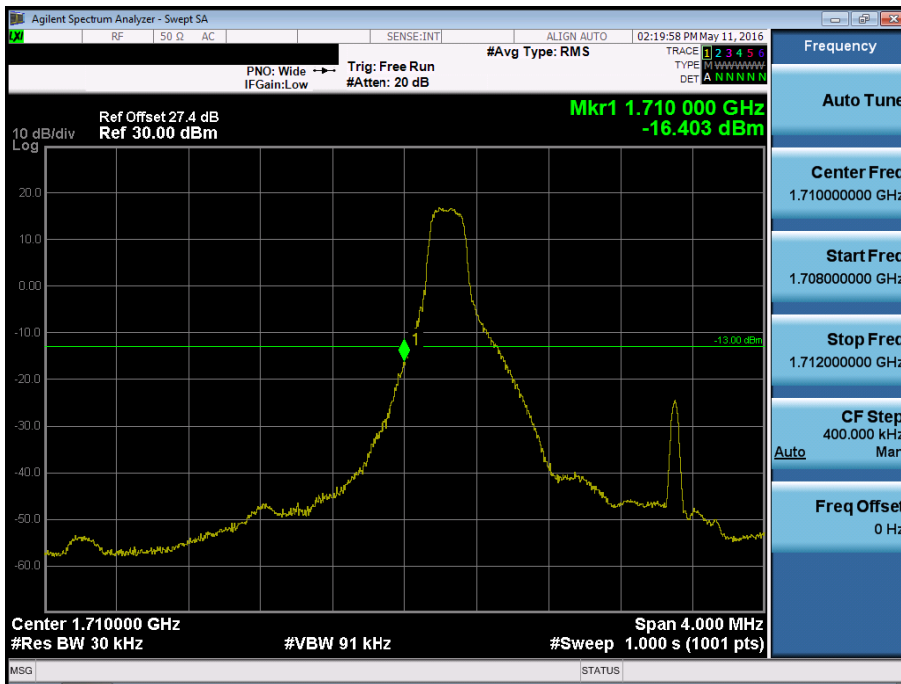

BAND 4. Lower Band Edge Plot (3M BW Ch.19965 QPSK RB 15) -2

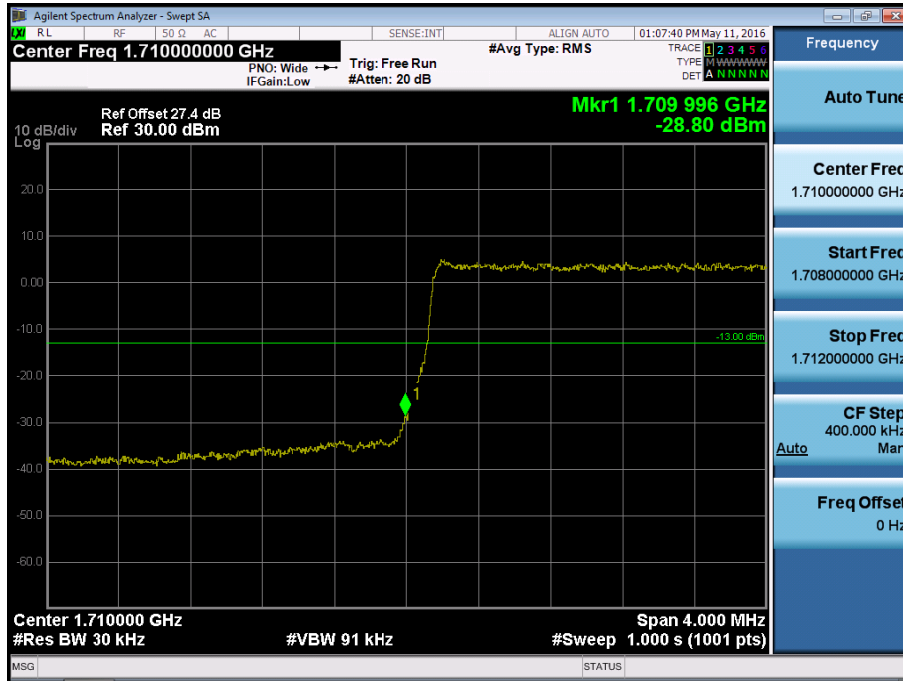

BAND 4. Lower Extended Band Edge Plot (3M BW Ch.19965 QPSK_RB15_0) -3

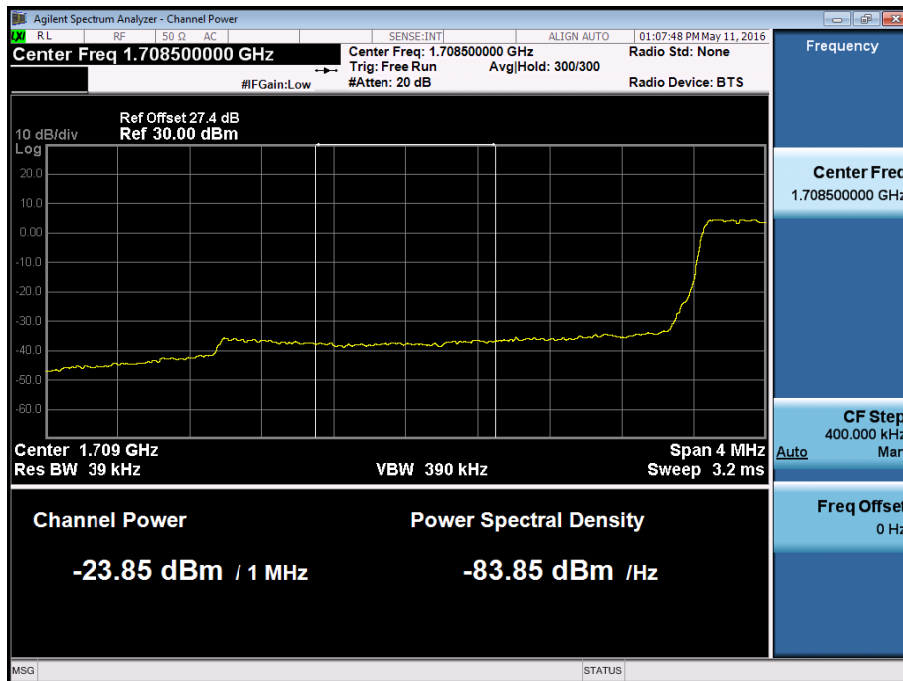

BAND 4. Lower Band Edge Plot (5M BW Ch.19975 QPSK RB 1, Offset 0) -1

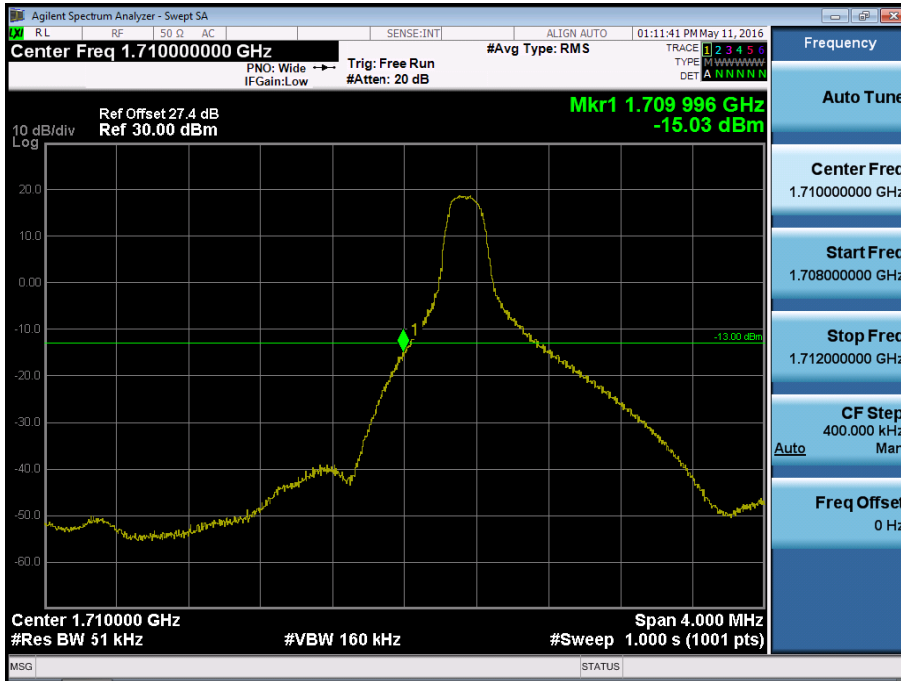

BAND 4. Lower Band Edge Plot (5M BW Ch.19975 QPSK RB 25) -2

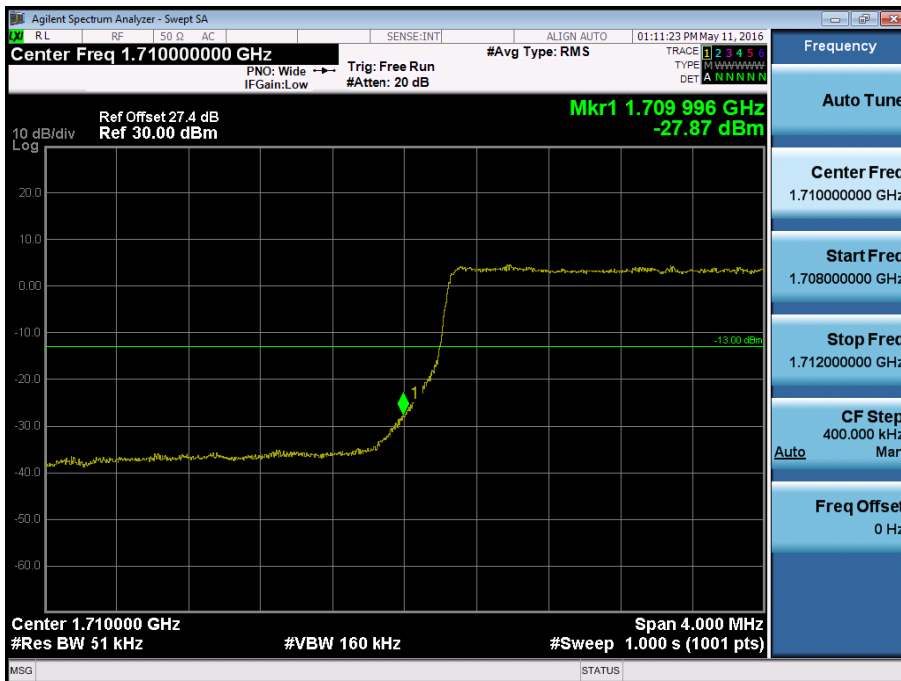

BAND 4. Lower Extended Band Edge Plot (5M BW Ch.19975 QPSK_RB25_0) -3

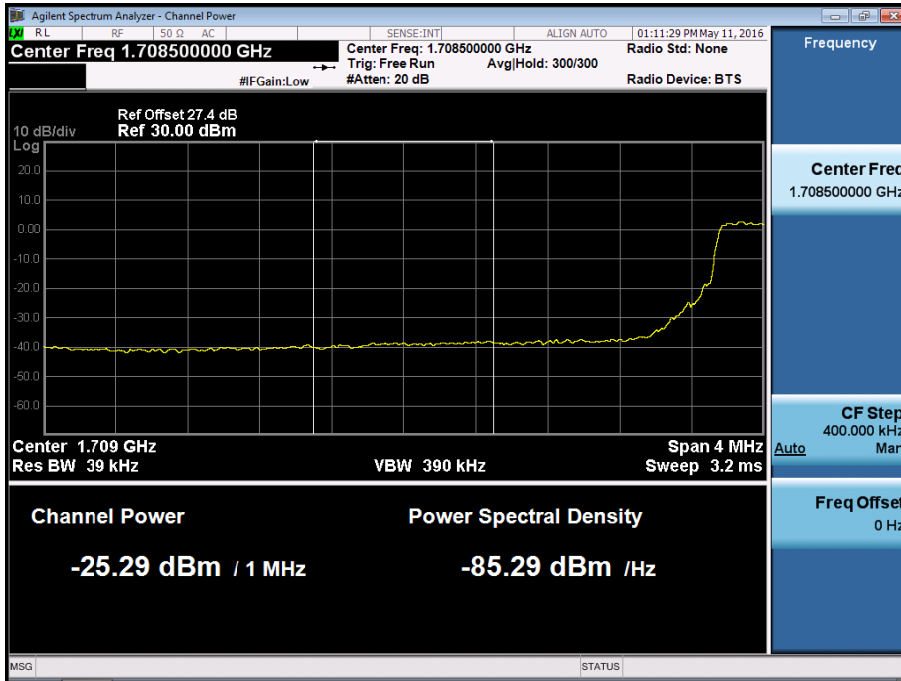

BAND 4. Lower Band Edge Plot (10M BW Ch.20000 QPSK RB 1, Offset 0) -1

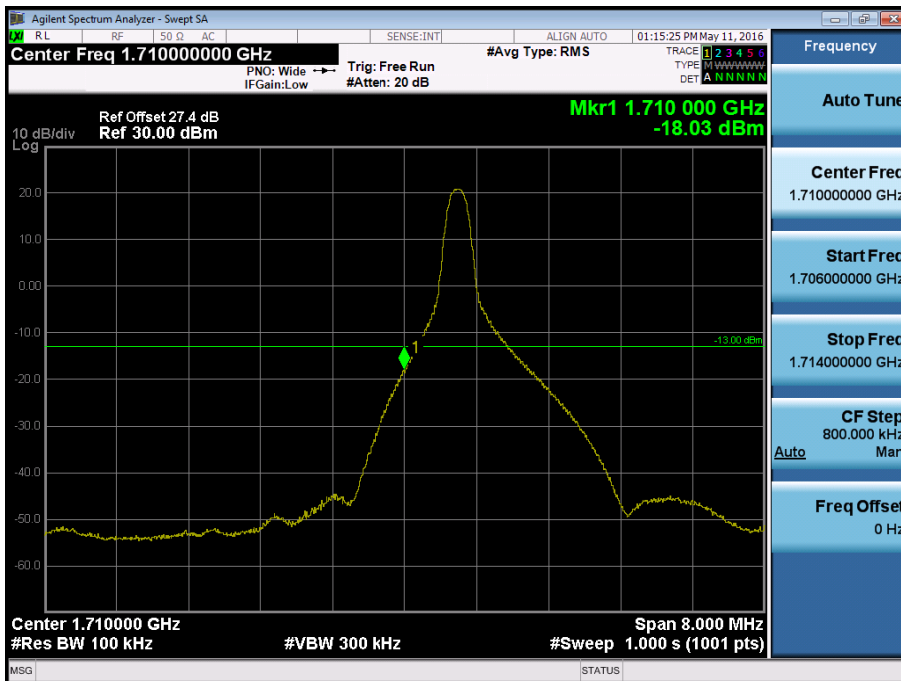

BAND 4. Lower Band Edge Plot (10M BW Ch.20000 QPSK RB 50) -2

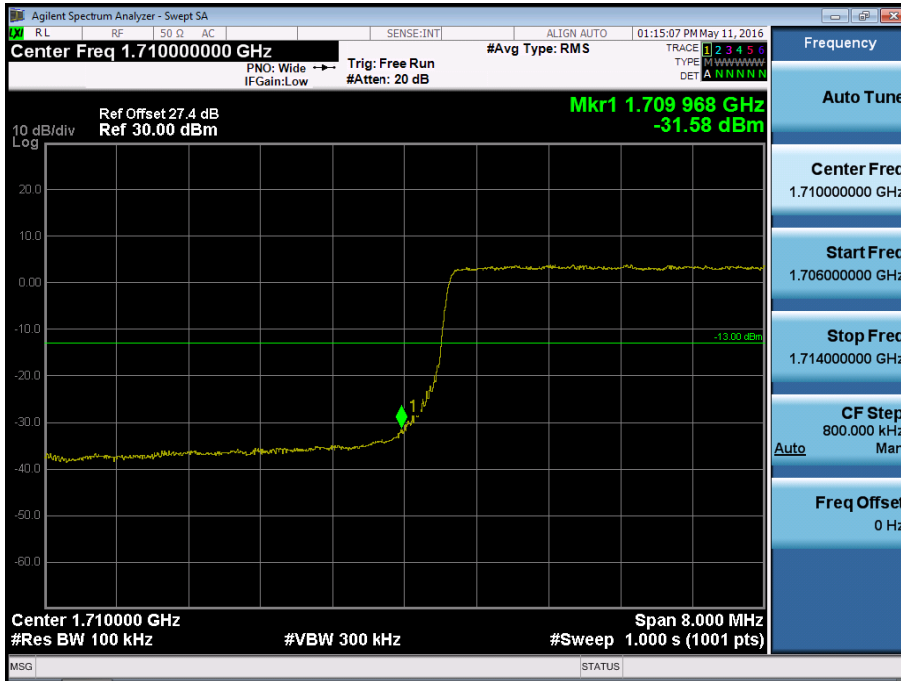

BAND 4. Lower Extended Band Edge Plot (10M BW Ch.20000 QPSK_RB50_0) -3

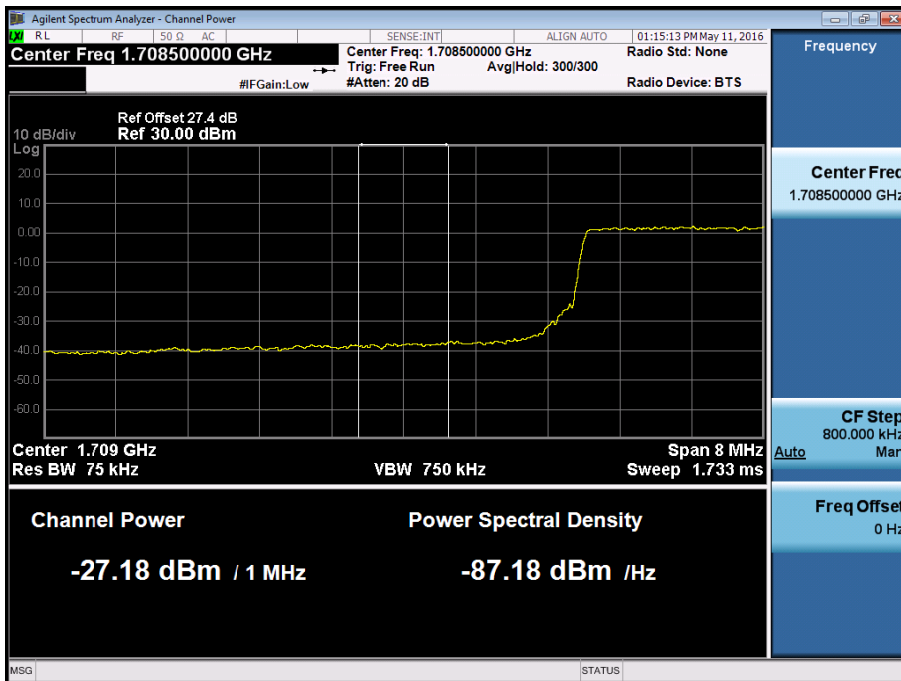

BAND 4. Lower Band Edge Plot (15M BW Ch.20025 QPSK RB 1, Offset 0) -1

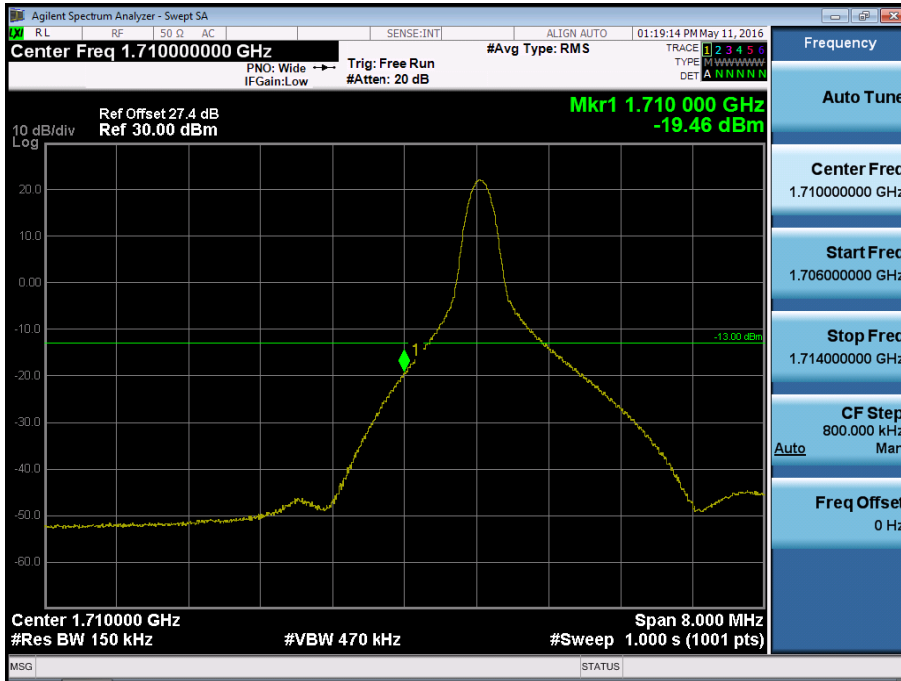

BAND 4. Lower Band Edge Plot (15M BW Ch.20025 QPSK RB 75) -2

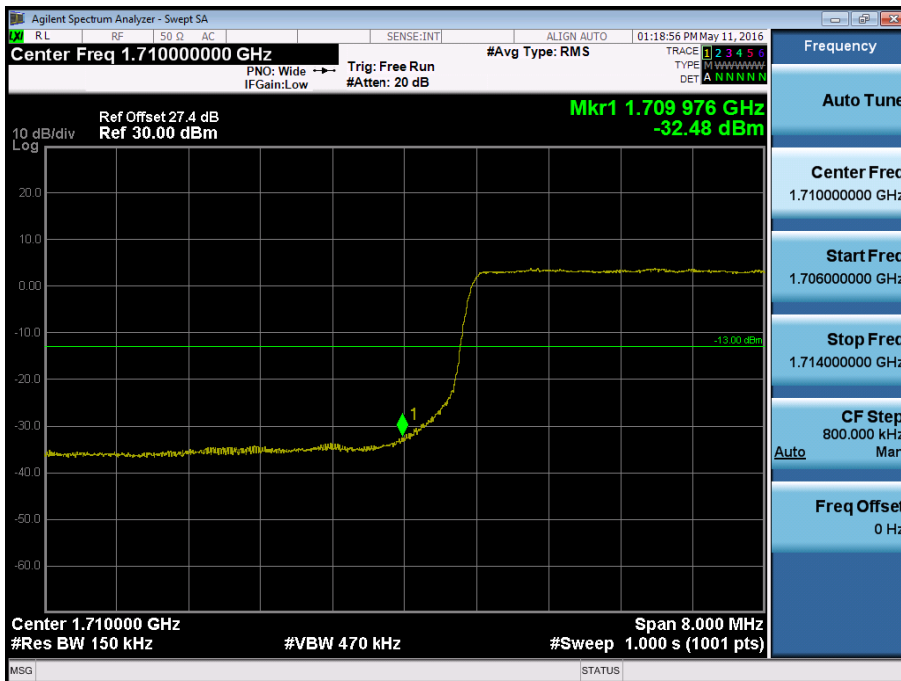

BAND 4. Lower Extended Band Edge Plot (15M BW Ch.20025 QPSK_RB75_0) -3

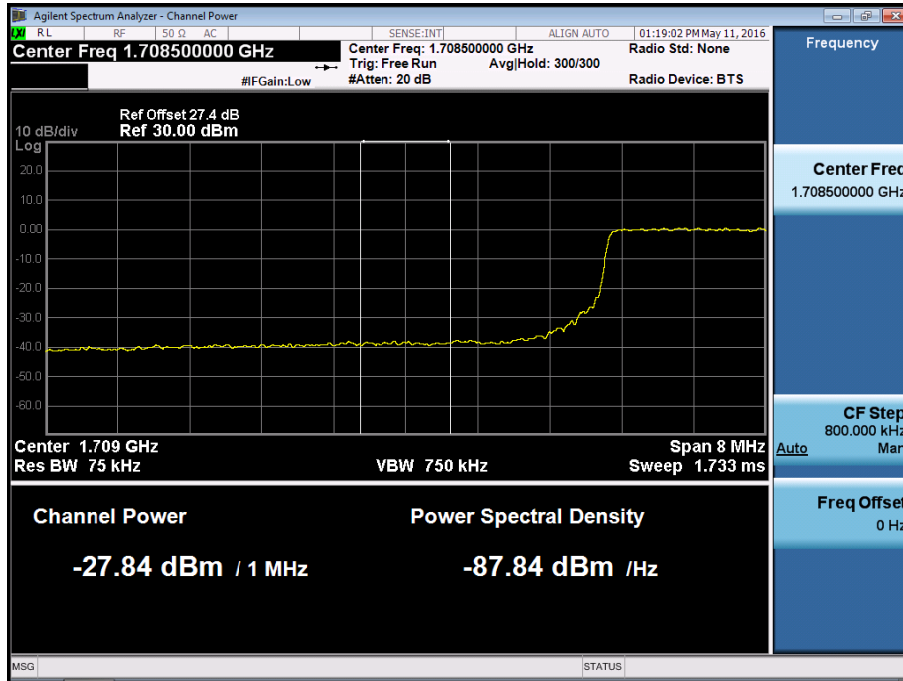

BAND 4. Lower Band Edge Plot (20M BW Ch.20050 QPSK RB 1, Offset 0) -1

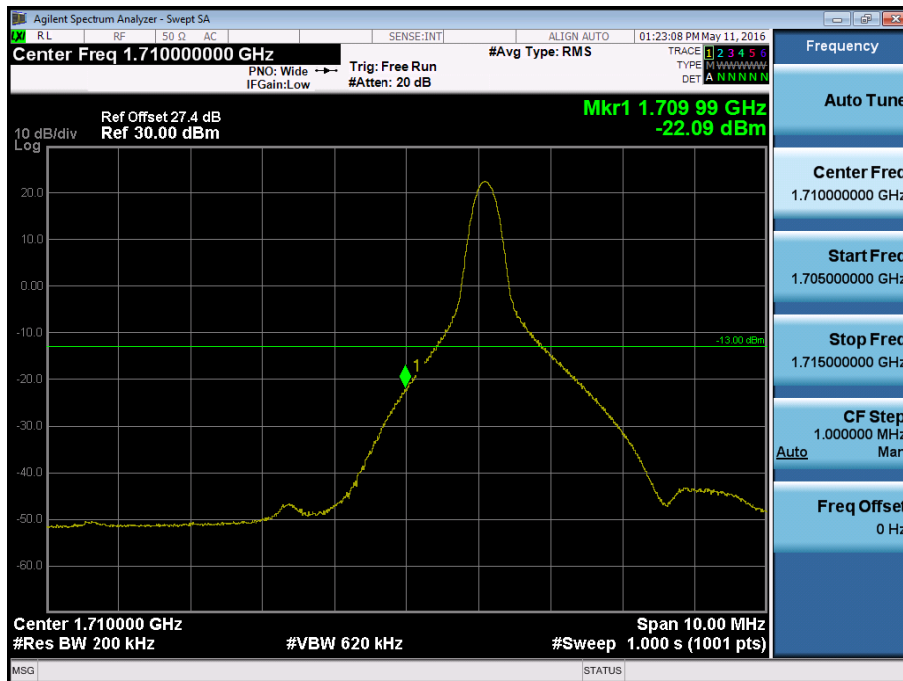

BAND 4. Lower Band Edge Plot (20M BW Ch.20050 QPSK RB 100) -2

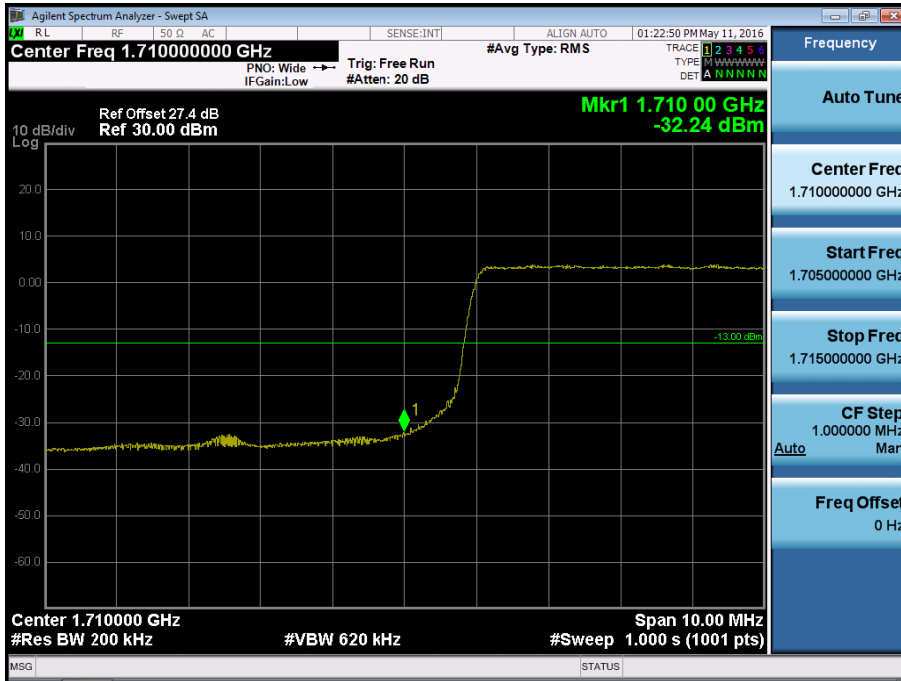

BAND 4. Lower Extended Band Edge Plot (20M BW Ch.20050 QPSK_RB100_0) -3

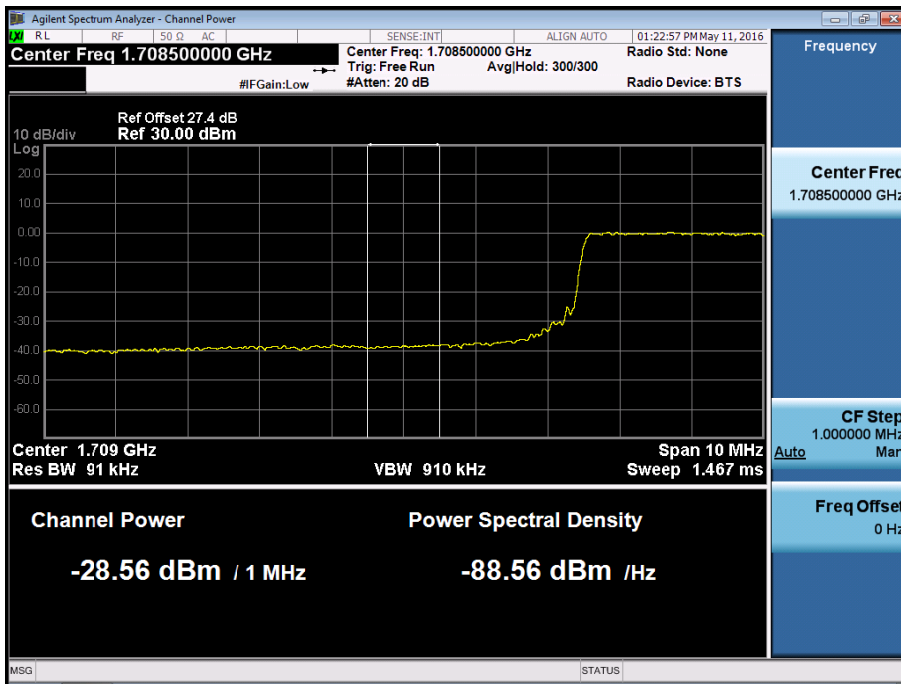

BAND 4. Upper Band Edge Plot (1.4M BW Ch.20393 QPSK_RB1_Offset 5) -1



BAND 4. Upper Band Edge Plot (1.4M BW Ch.20393 QPSK_RB6) -2



BAND 4. Upper Extended Band Edge Plot (1.4M BW Ch. 20393 QPSK_RB6_0) -3

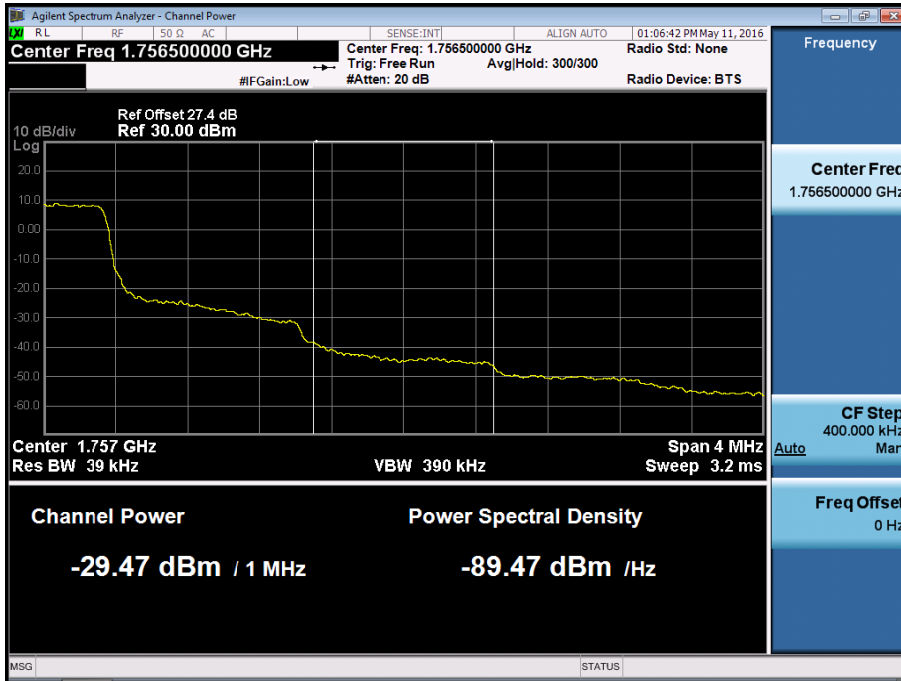

BAND 4. Upper Band Edge Plot (3M BW Ch.20385 QPSK_RB1_Offset 14) -1

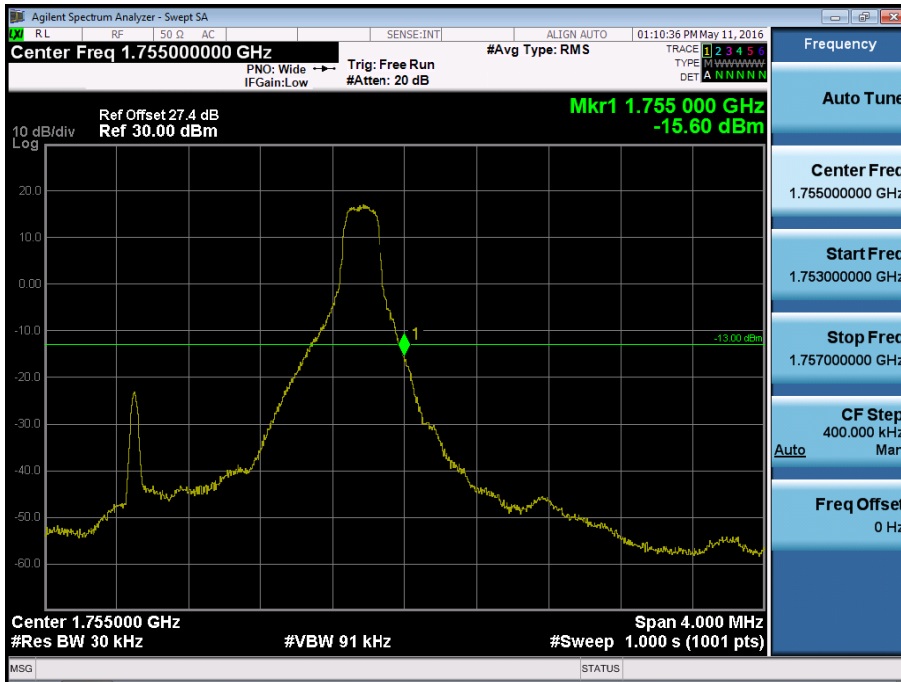

BAND 4. Upper Band Edge Plot (3M BW Ch.20385 QPSK_RB15) -2



BAND 4. Upper Extended Band Edge Plot (3M BW Ch.20385 QPSK_RB15_0) -3

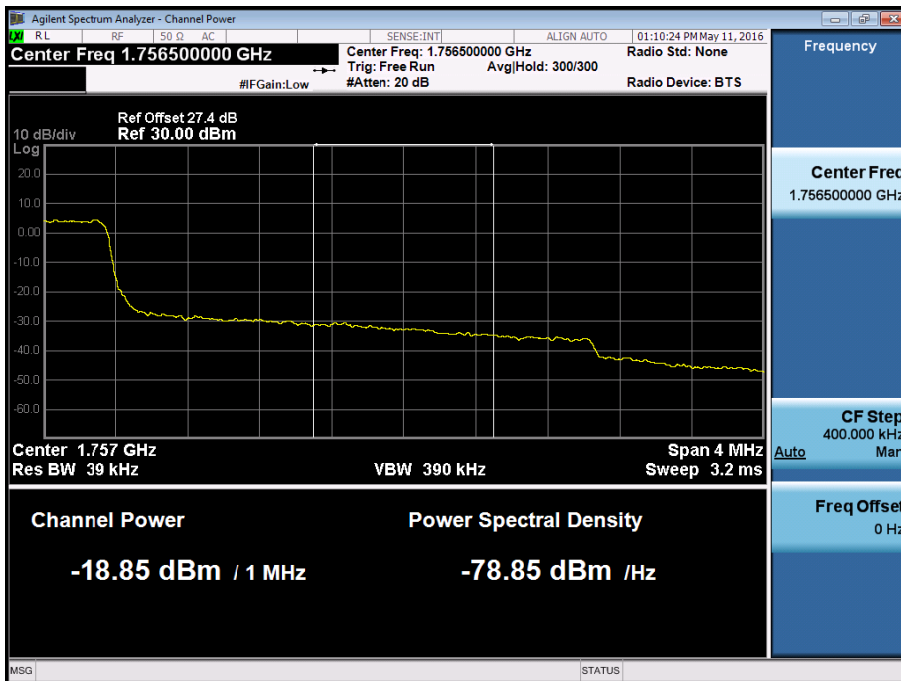

BAND 4. Upper Band Edge Plot (5M BW Ch.20375 QPSK_RB1_Offset 24) -1

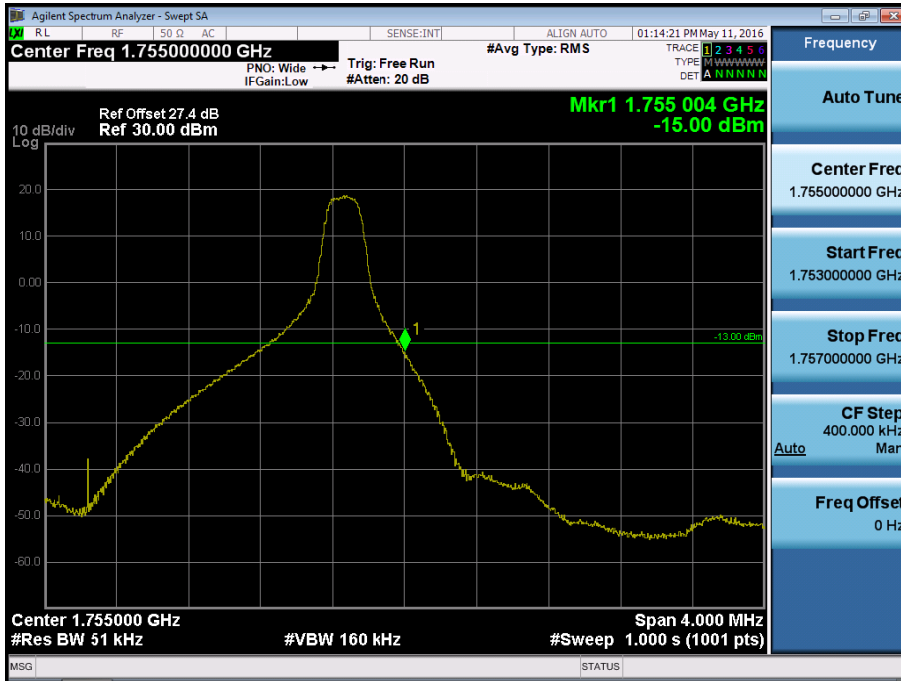

BAND 4. Upper Band Edge Plot (5M BW Ch.20375 QPSK_RB25) -2

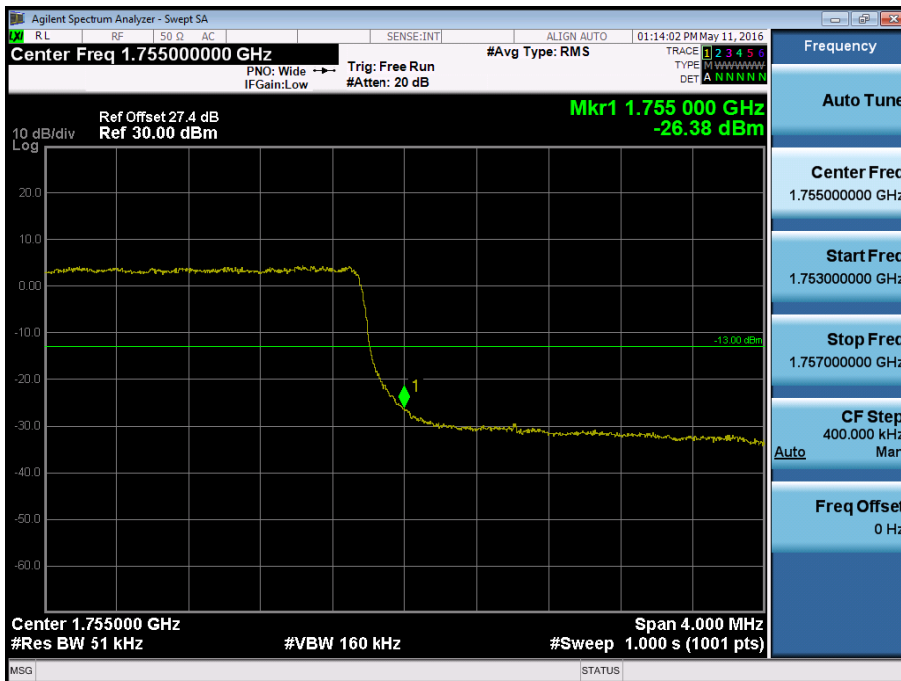

BAND 4. Upper Extended Band Edge Plot (5M BW Ch.20375 QPSK_RB25) -3

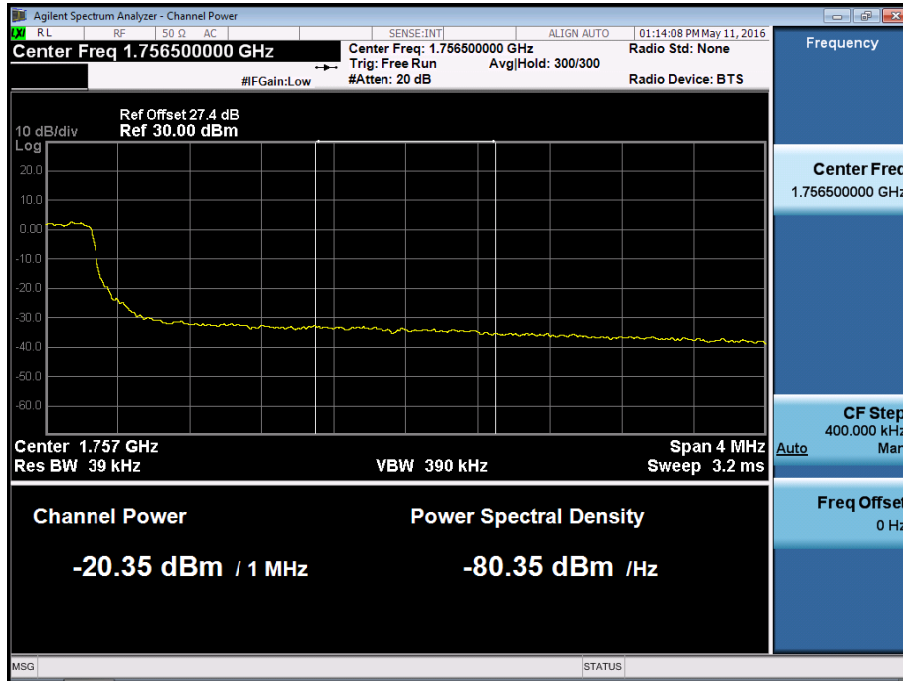

BAND 4. Upper Band Edge Plot (10M BW Ch.20350 QPSK_RB1_Offset 49) -1

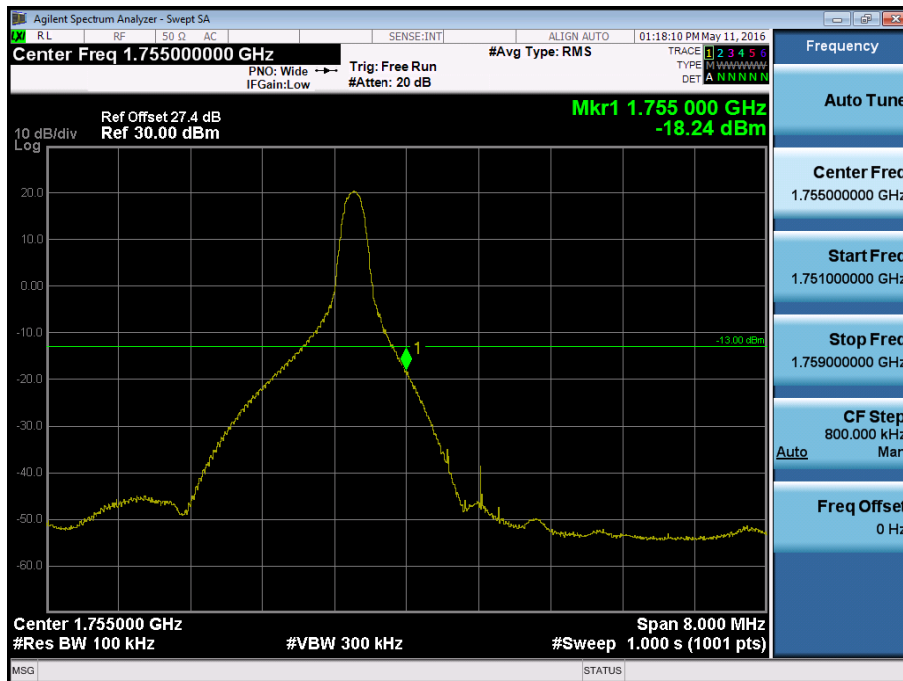

BAND 4. Upper Band Edge Plot (10M BW Ch.20350 QPSK_RB50) -2



BAND 4. Upper Extended Band Edge Plot (10M BW Ch.20350 QPSK_RB50) -3

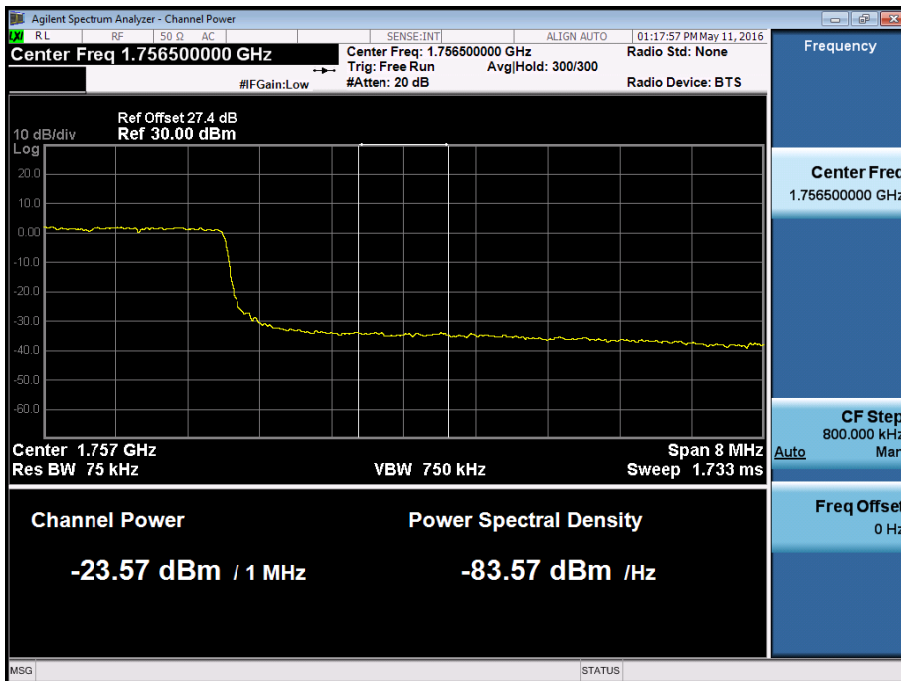

BAND 4. Upper Band Edge Plot (15M BW Ch.20325 QPSK_RB1_Offset 74) -1

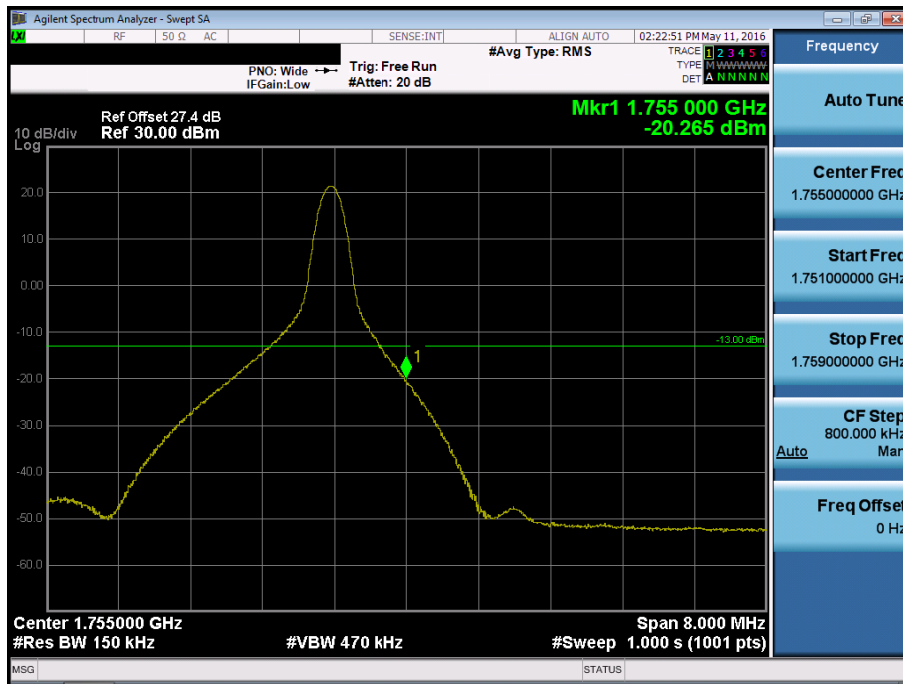

BAND 4. Upper Band Edge Plot (15M BW Ch.20325 QPSK_RB75) -2

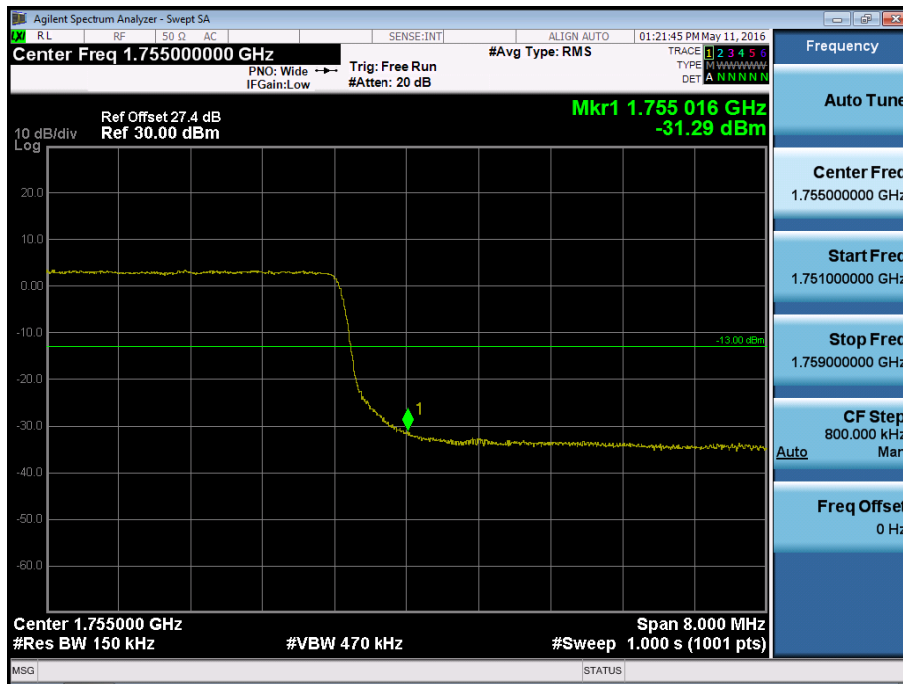

BAND 4. Upper Extended Band Edge Plot (15M BW Ch.20325 QPSK_RB75) -3

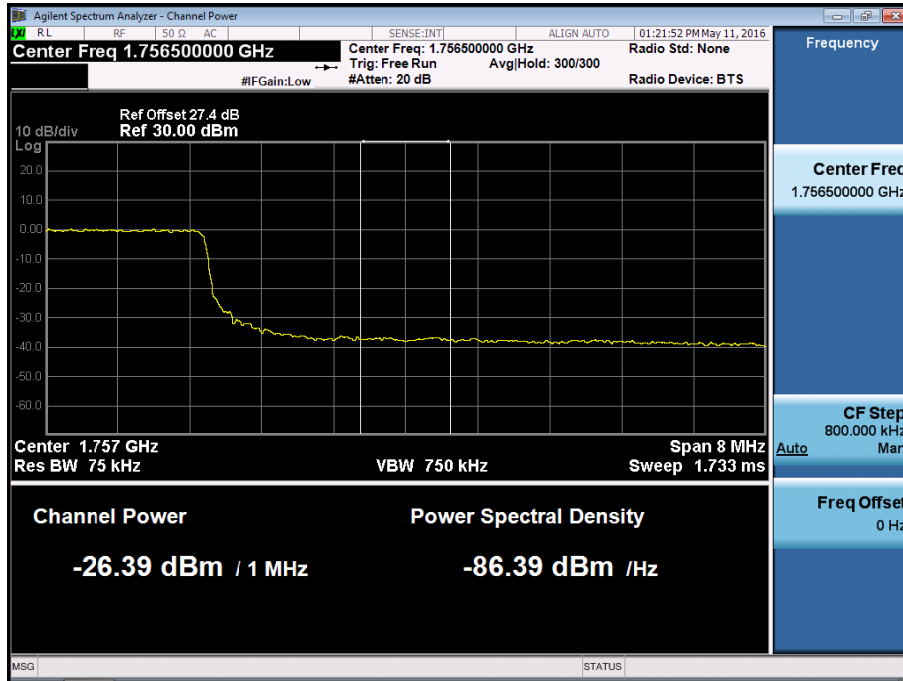

BAND 4. Upper Band Edge Plot (20M BW Ch.20300 QPSK_RB1_Offset 99) -1

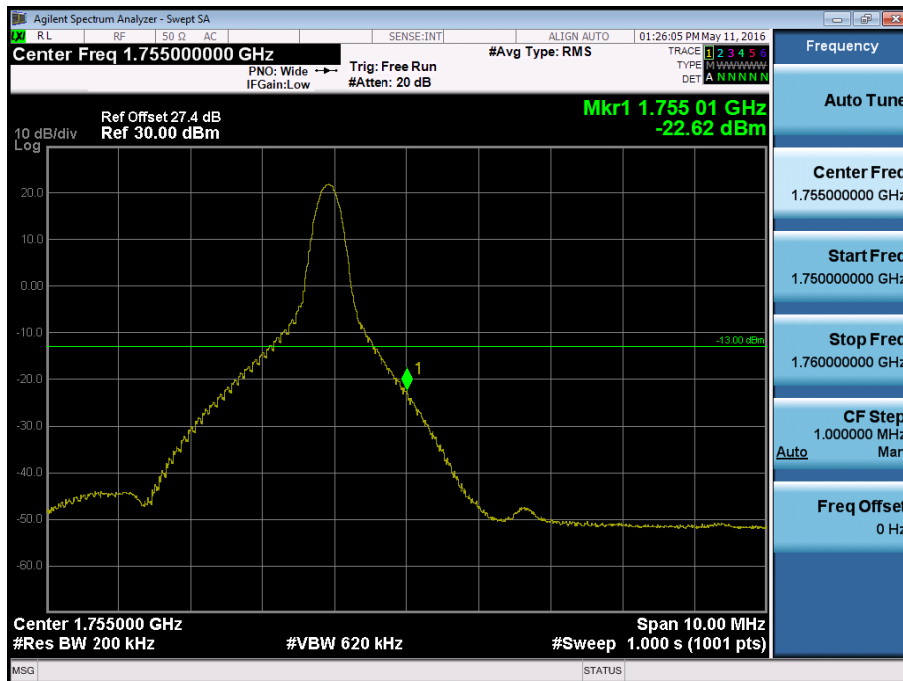

BAND 4. Upper Band Edge Plot (20M BW Ch.20300 QPSK_RB100) -2

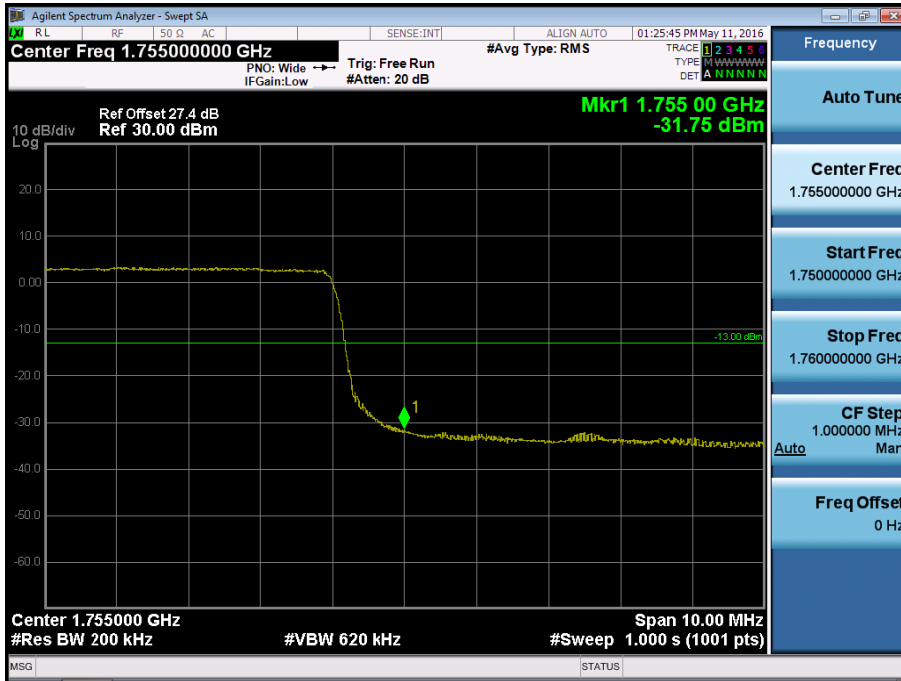

BAND 4. Upper Extended Band Edge Plot (20M BW Ch.20300 QPSK_RB100) -3

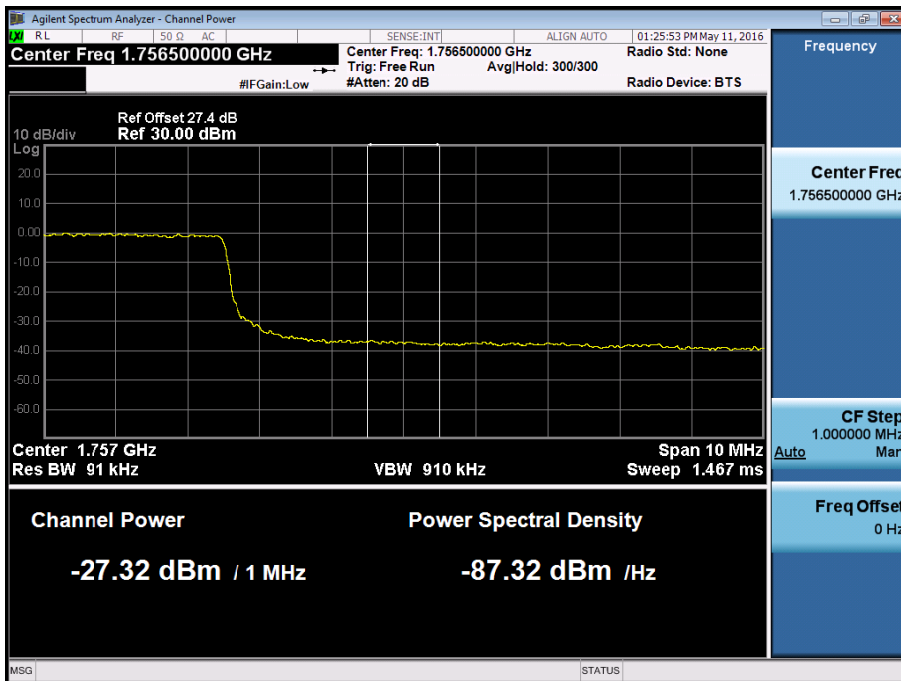

Band 17 Lower Band Edge Plot (5M BW Ch.23755 QPSK_RB1 OFFSET0)

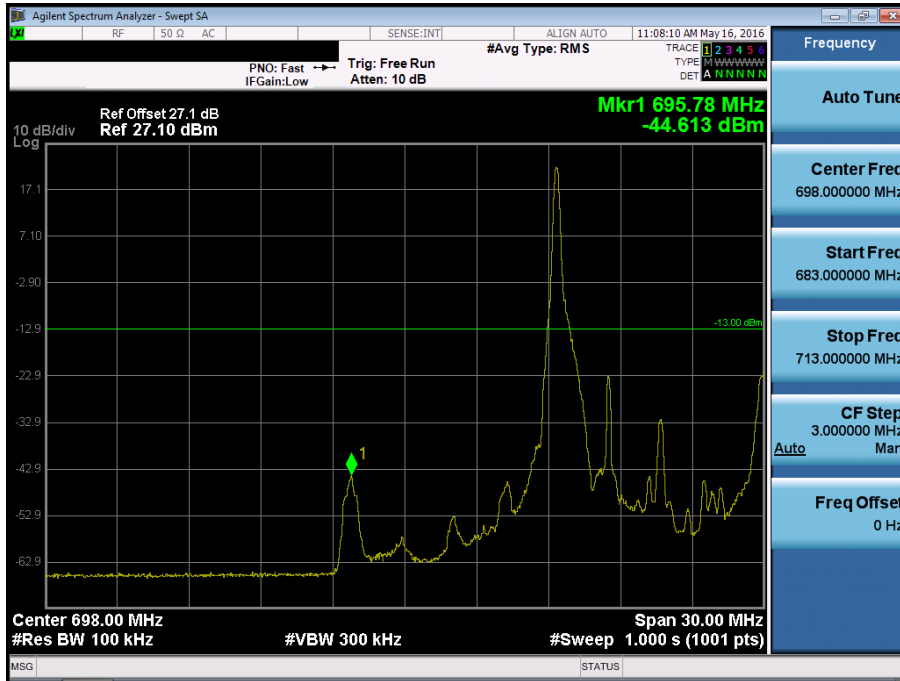

Band 17 Lower Band Edge Plot (5M BW Ch.23755 QPSK_RB25)

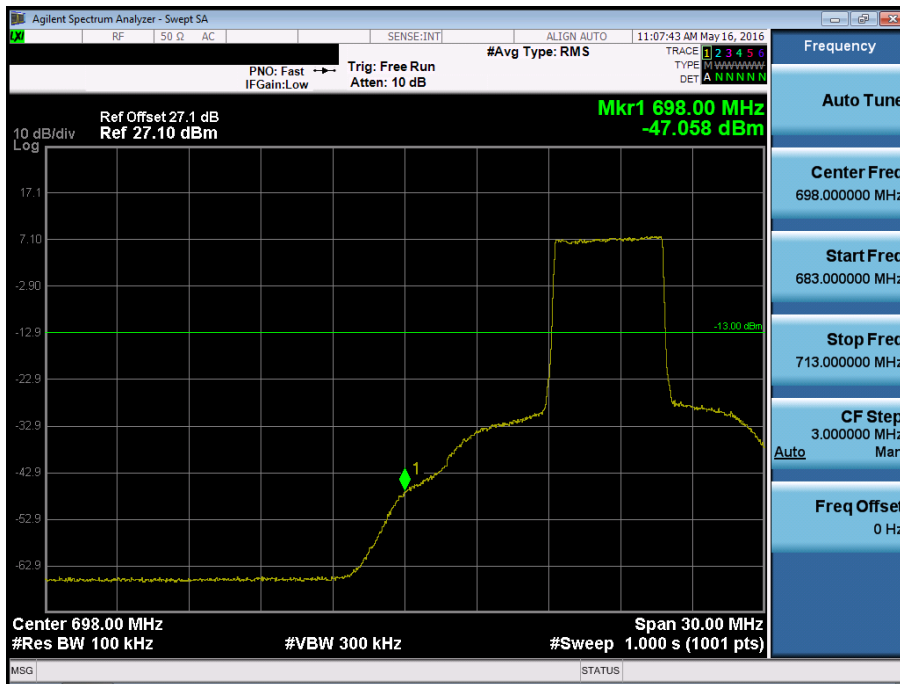

Band 17 Lower Band Edge Plot (10M BW Ch.23780 QPSK_RB1 OFFSET0)

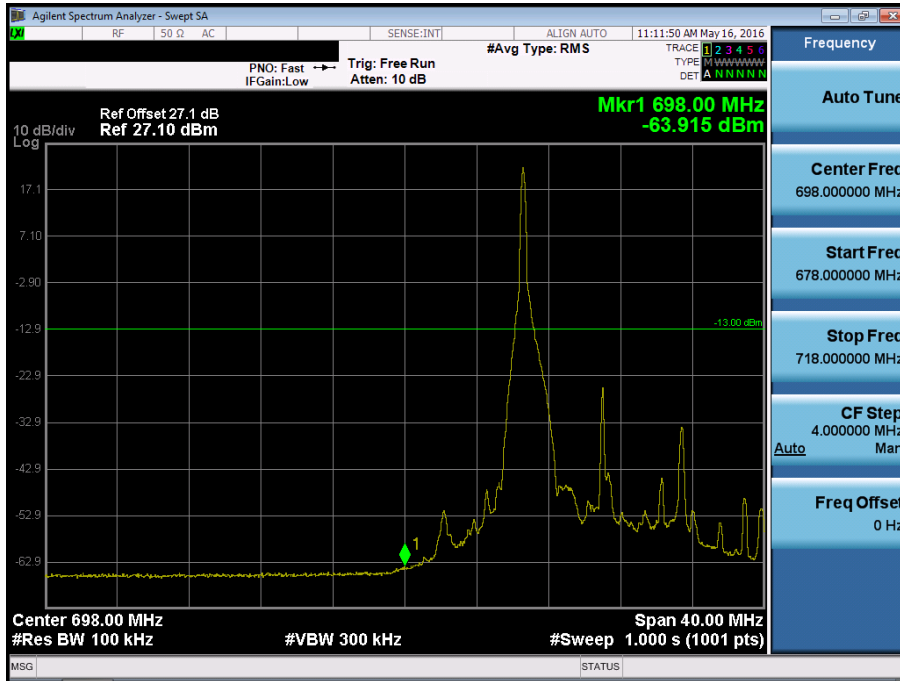

Band 17 Lower Band Edge Plot (10M BW Ch.23780 QPSK_RB50_0)

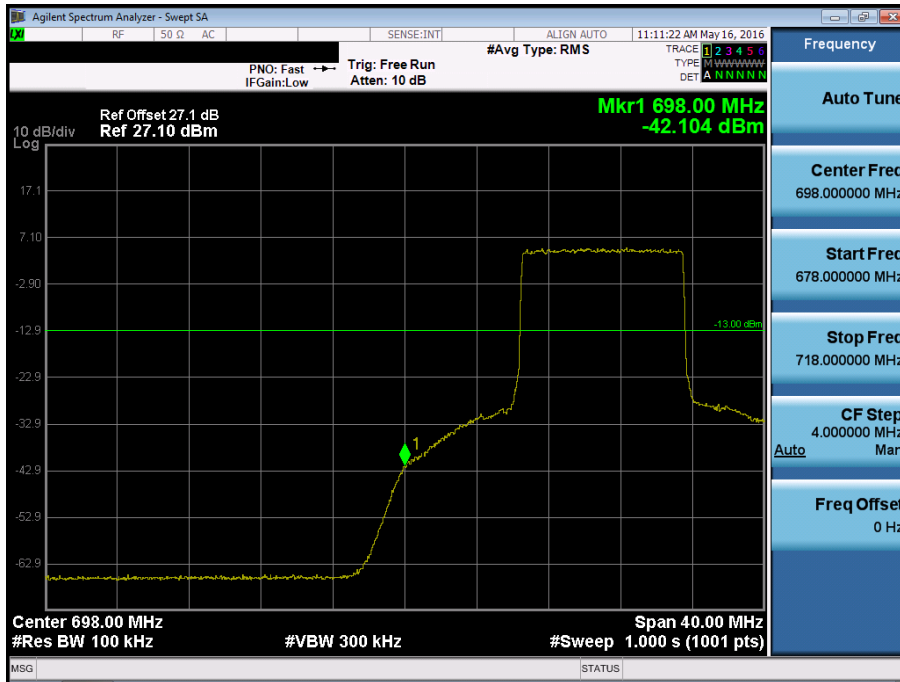

Band 17 Upper Band Edge Plot (5M BW Ch.23825 QPSK_RB1_Offset 24)



Band 17 Upper Band Edge Plot (5M BW Ch.23825 QPSK_RB25)

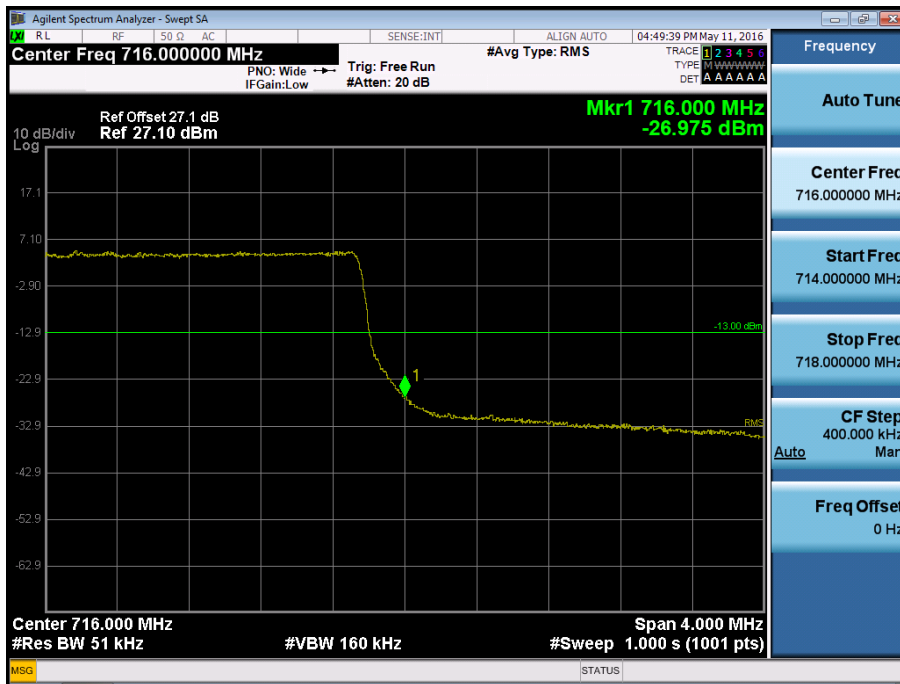

Band 17 Upper Extended Band Edge Plot (5M BW Ch.23825 QPSK_RB25_0)



Band 17 Upper Band Edge Plot (10M BW Ch.23800 QPSK_RB1_Offset 49)



Band 17 Upper Band Edge Plot (10M BW Ch.23800 QPSK_RB50)



Band 17 Upper Extended Band Edge Plot (10M BW Ch.23800 QPSK_RB50_0)



BAND 4. Conducted Spurious Plot_1 (19957ch_1.4MHz_QPSK_RB 1_0)

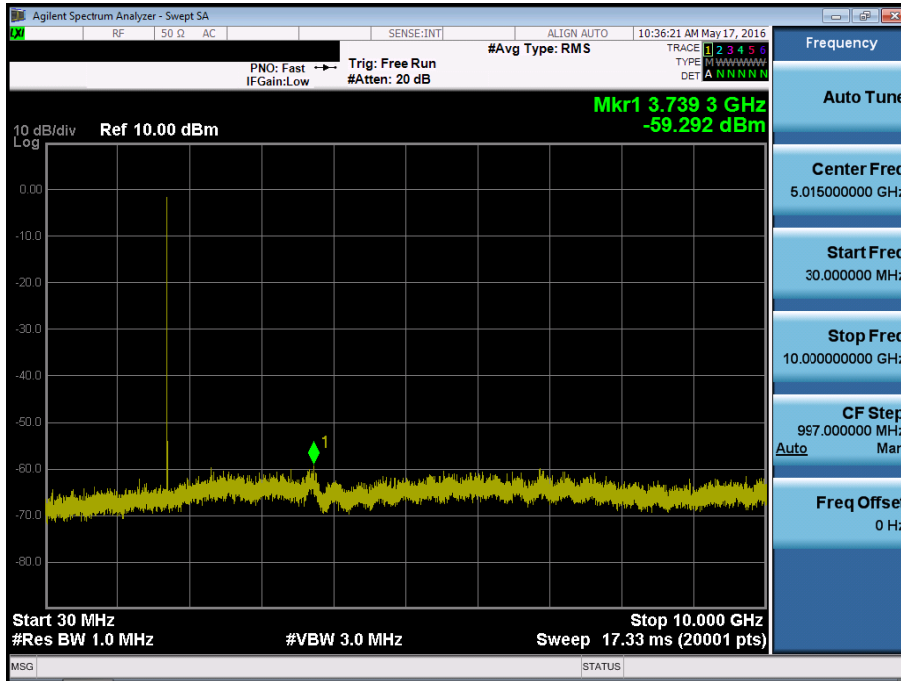

BAND 4. Conducted Spurious Plot_2 (19957ch_1.4MHz_QPSK_RB 1_0)

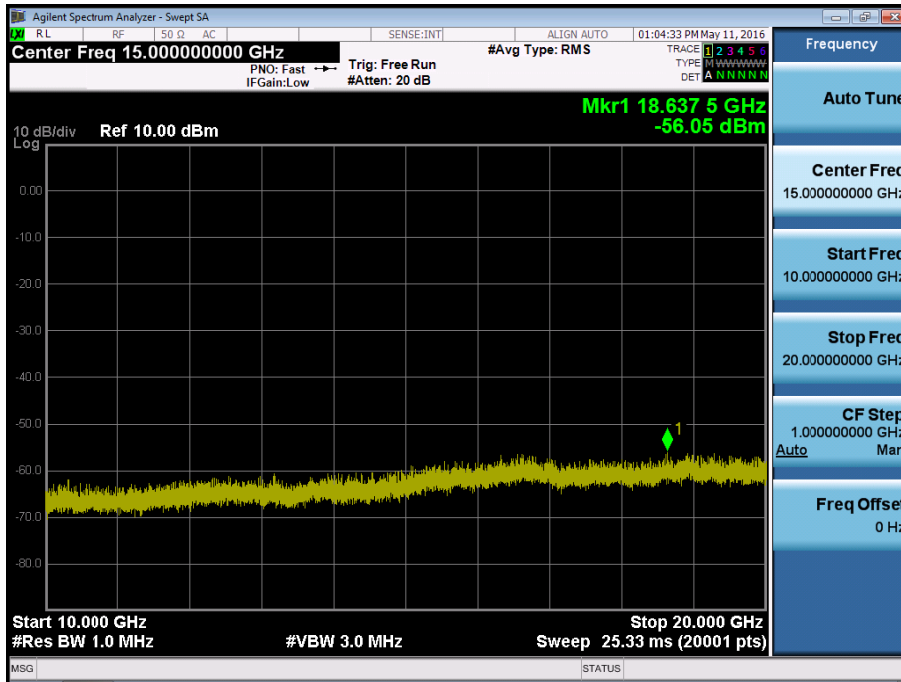

BAND 4. Conducted Spurious Plot_1 (20175ch_1.4MHz_QPSK_RB 1_0)

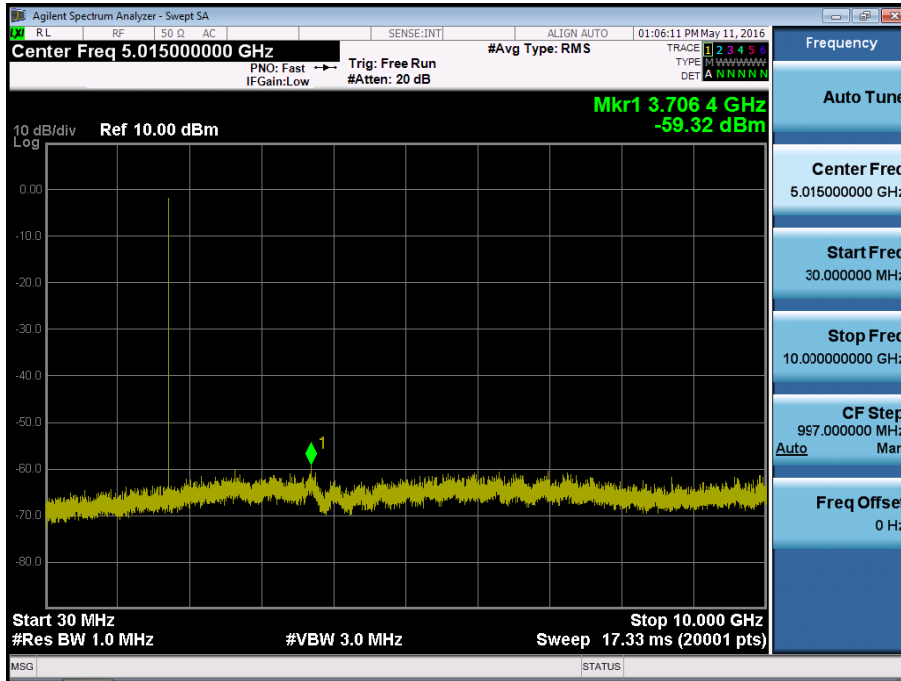

BAND 4. Conducted Spurious Plot_2 (20175ch_1.4MHz_QPSK_RB 1_0)

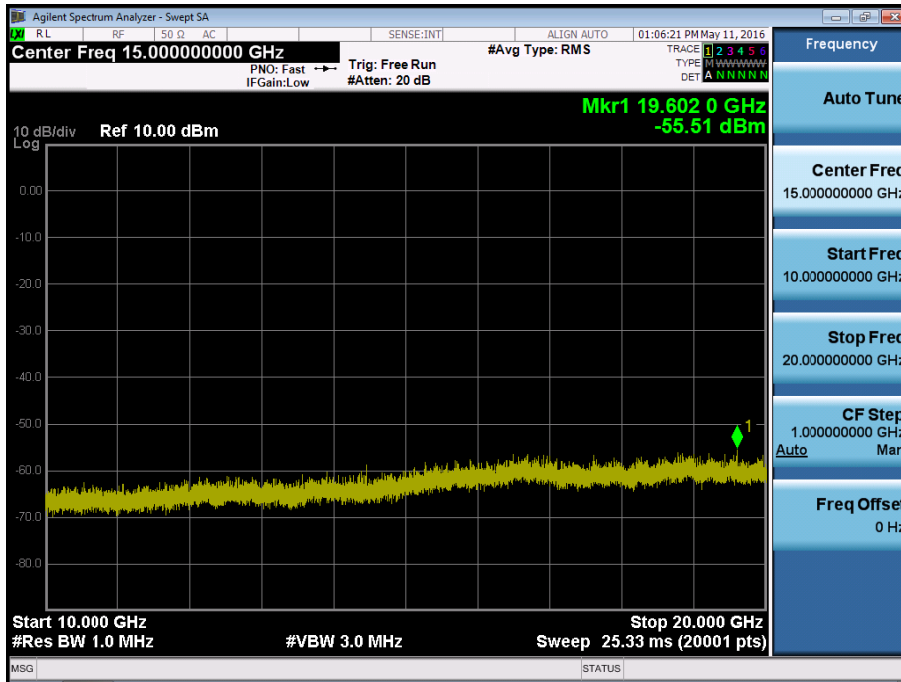

BAND 4. Conducted Spurious Plot_1 (20393ch_1.4MHz_QPSK_RB 1_0)

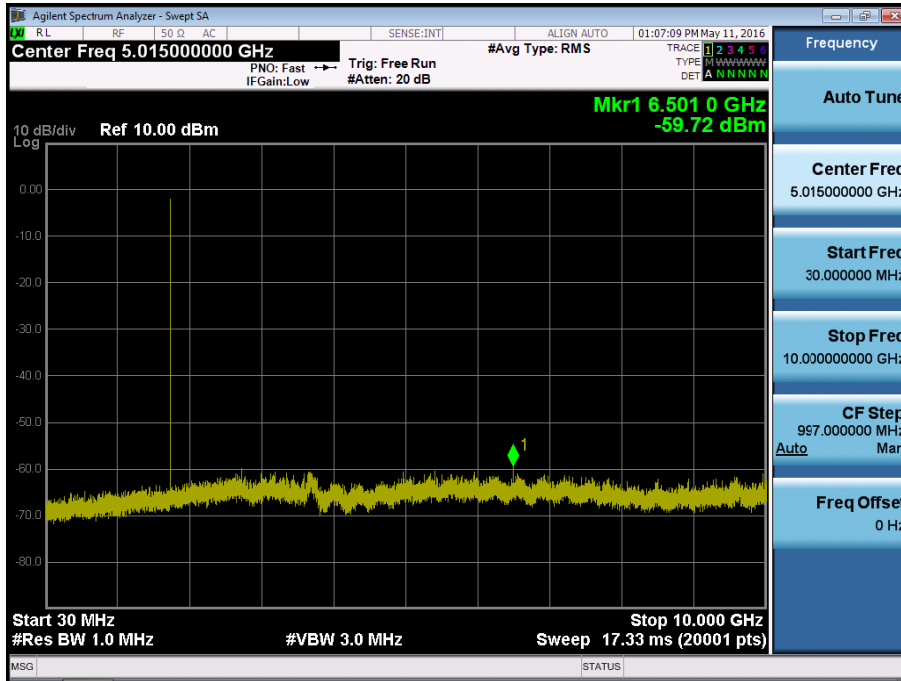

BAND 4. Conducted Spurious Plot_2 (20393ch_1.4MHz_QPSK_RB 1_0)

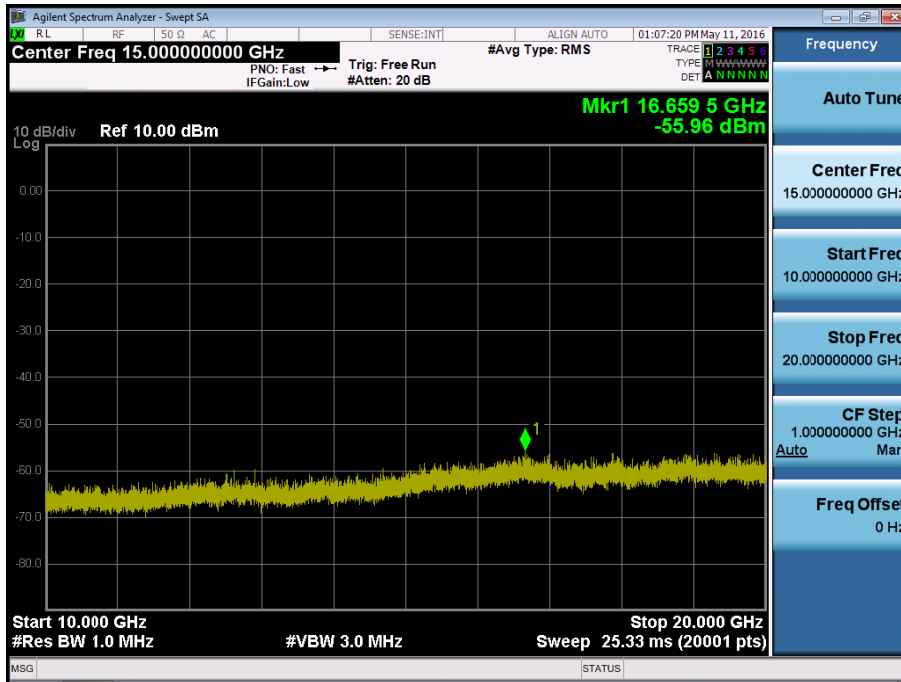

BAND 4. Conducted Spurious Plot_1 (19965ch_3MHz_QPSK_RB 1_0)

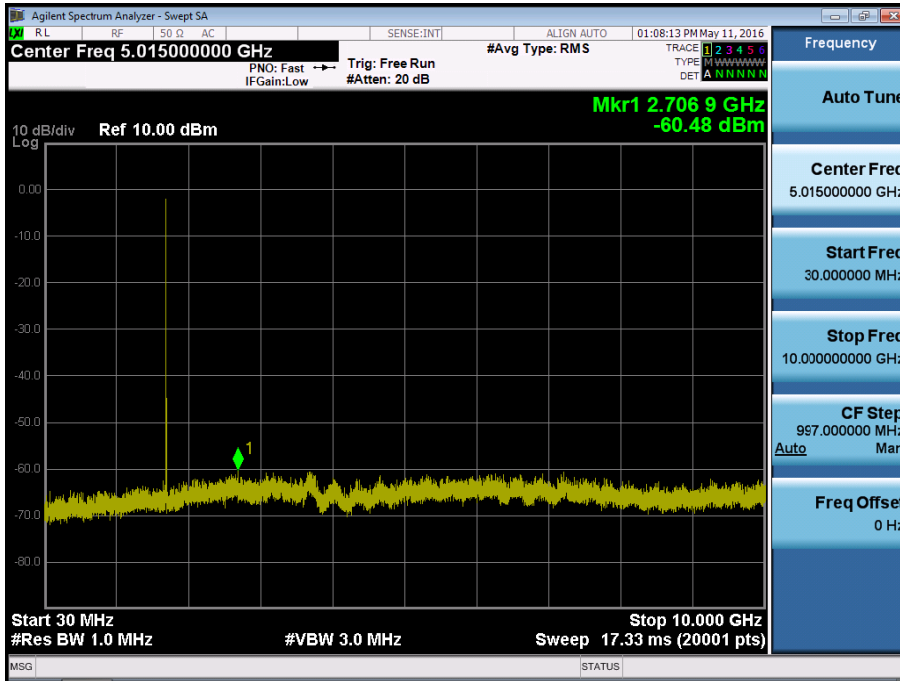

BAND 4. Conducted Spurious Plot_2 (19965ch_3MHz_QPSK_RB 1_0)

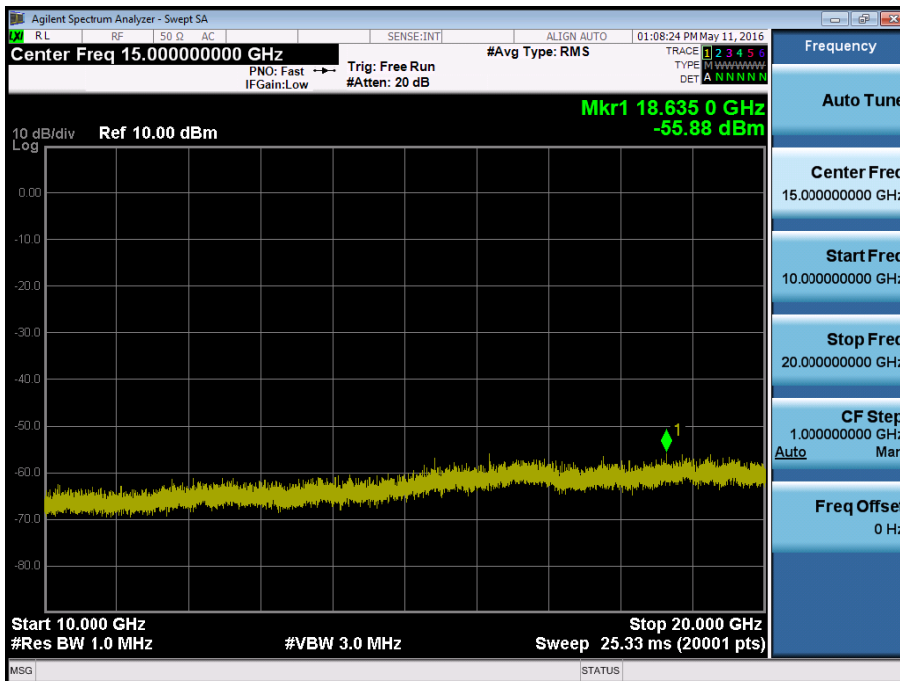

BAND 4. Conducted Spurious Plot_1 (20175ch_3MHz_QPSK_RB 1_0)

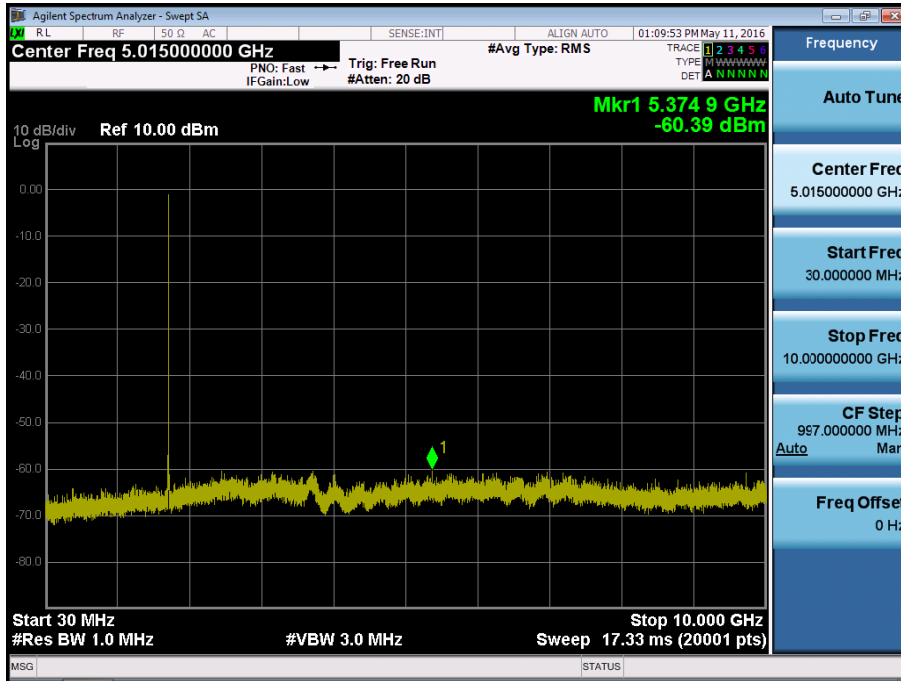

BAND 4. Conducted Spurious Plot_2 (20175ch_3MHz_QPSK_RB 1_0)

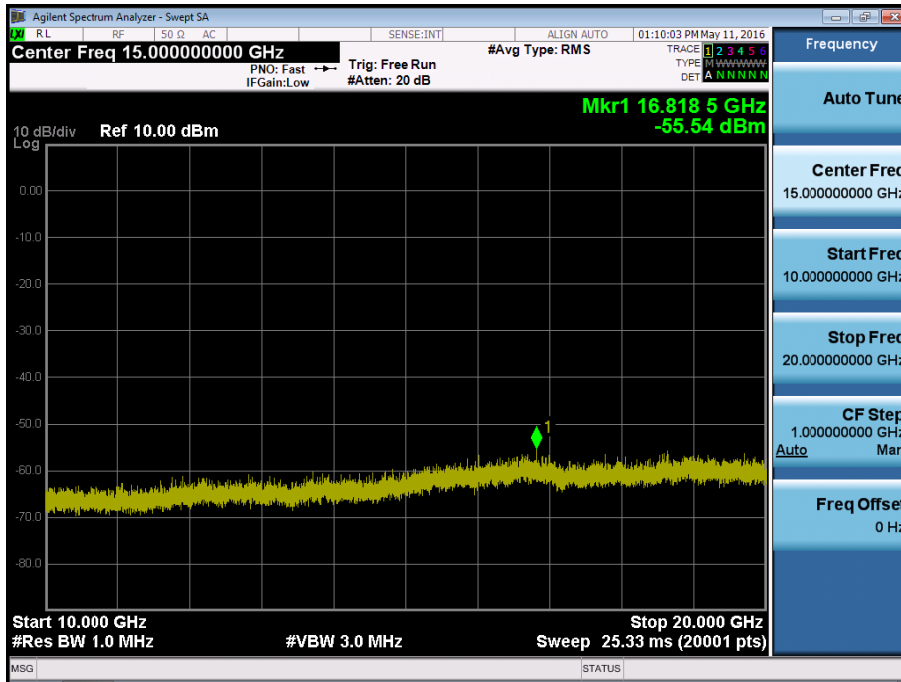

BAND 4. Conducted Spurious Plot_1 (20385ch_3MHz_QPSK_RB 1_0)

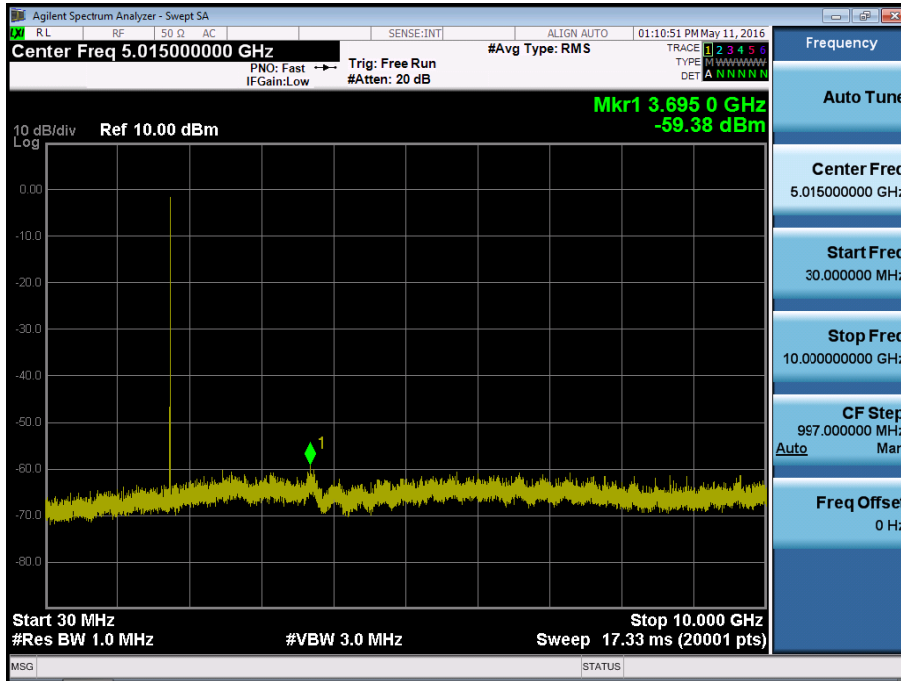

BAND 4. Conducted Spurious Plot_2 (20385ch_3MHz_QPSK_RB 1_0)

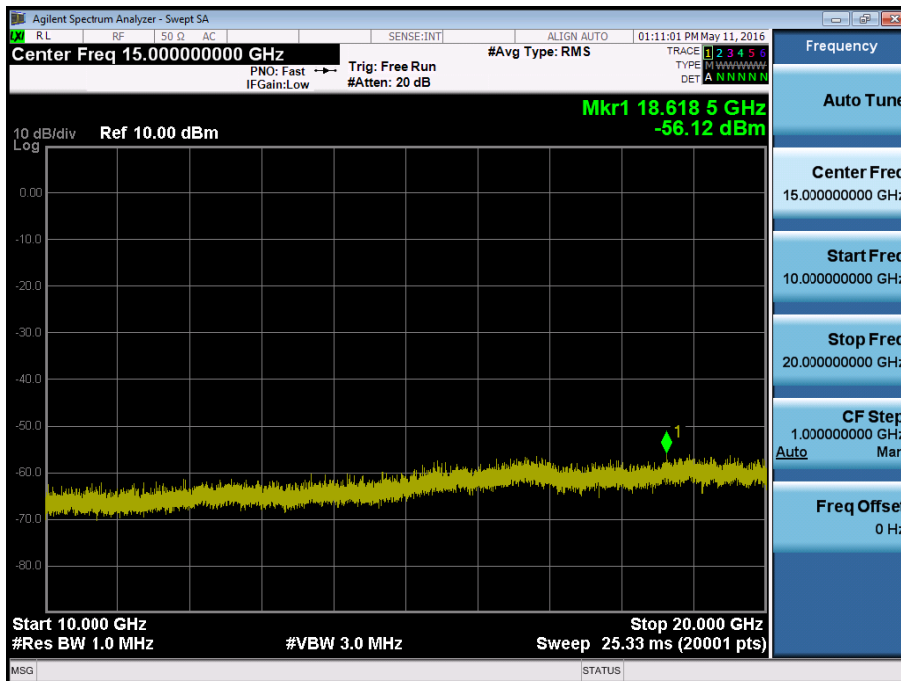

BAND 4. Conducted Spurious Plot_1 (19975ch_5MHz_QPSK_RB 1_0)

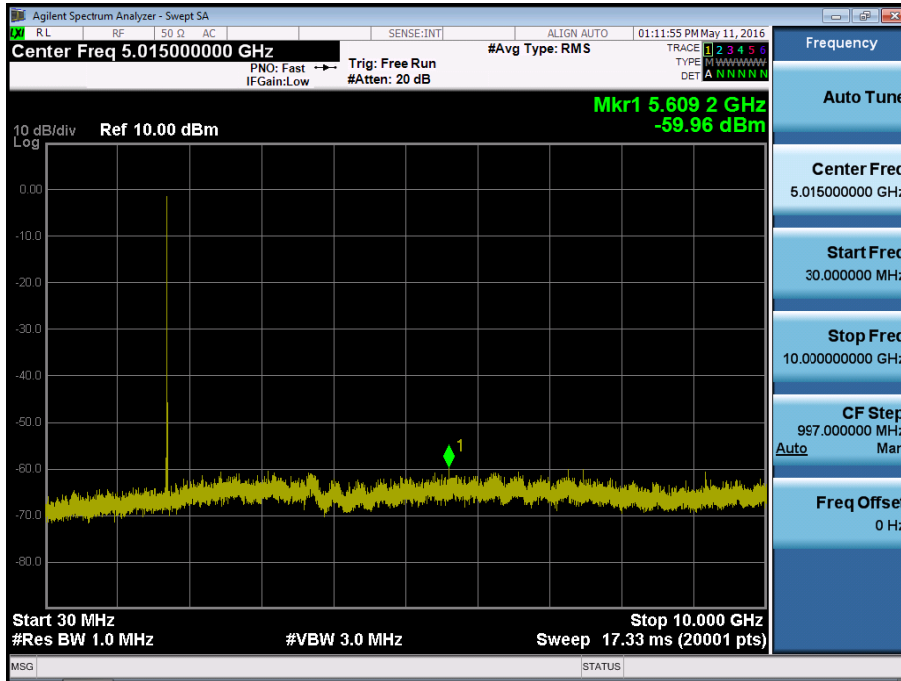

BAND 4. Conducted Spurious Plot_2 (19975ch_5MHz_QPSK_RB 1_0)

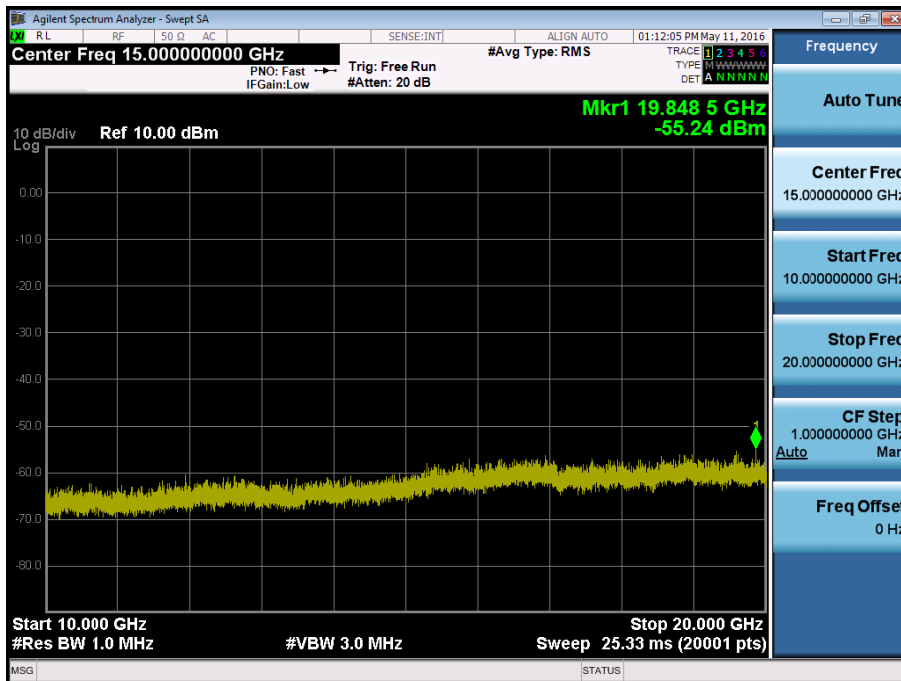

BAND 4. Conducted Spurious Plot_1 (20175ch_5MHz_QPSK_RB 1_0)

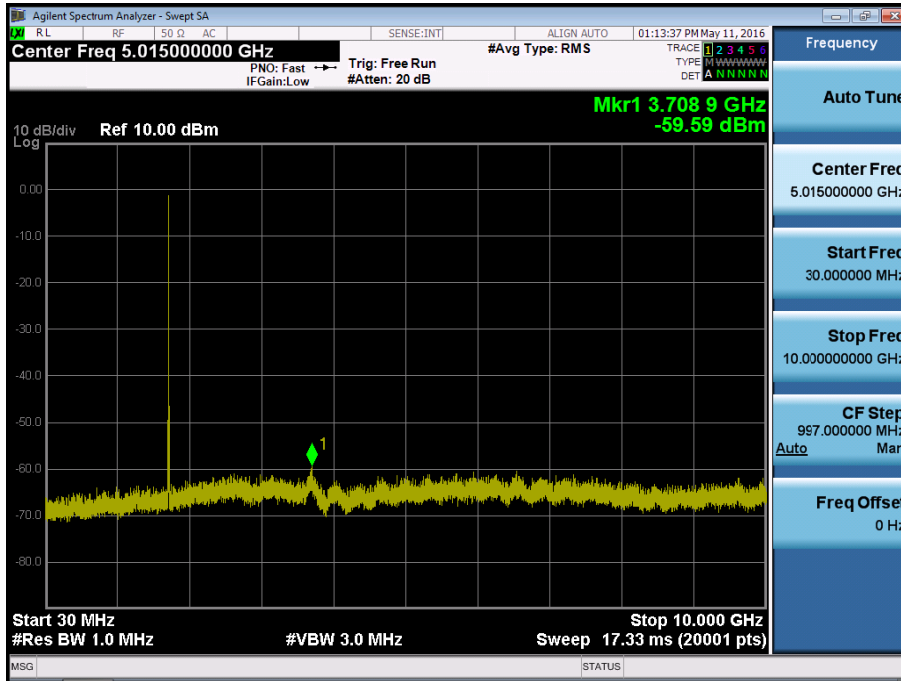

BAND 4. Conducted Spurious Plot_2 (20175ch_5MHz_QPSK_RB 1_0)

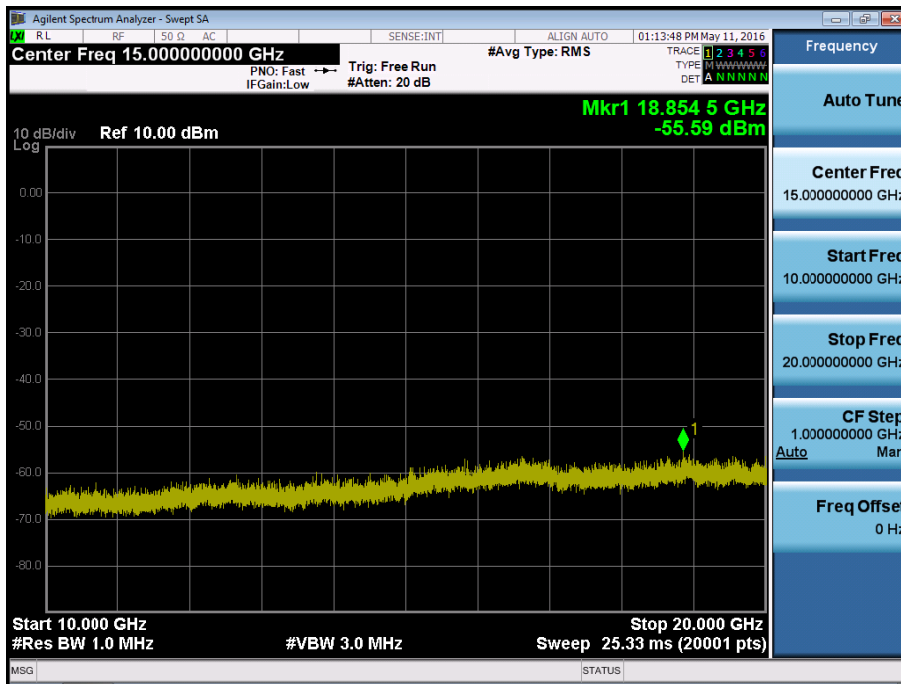

BAND 4. Conducted Spurious Plot_1 (20375ch_5MHz_QPSK_RB 1_0)

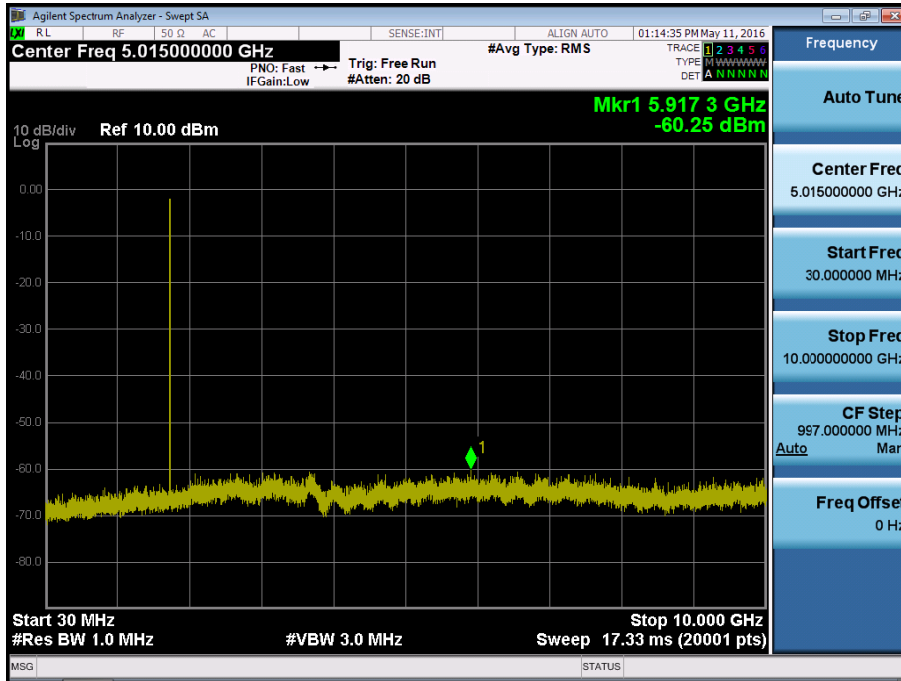

BAND 4. Conducted Spurious Plot_2 (20375ch_5MHz_QPSK_RB 1_0)

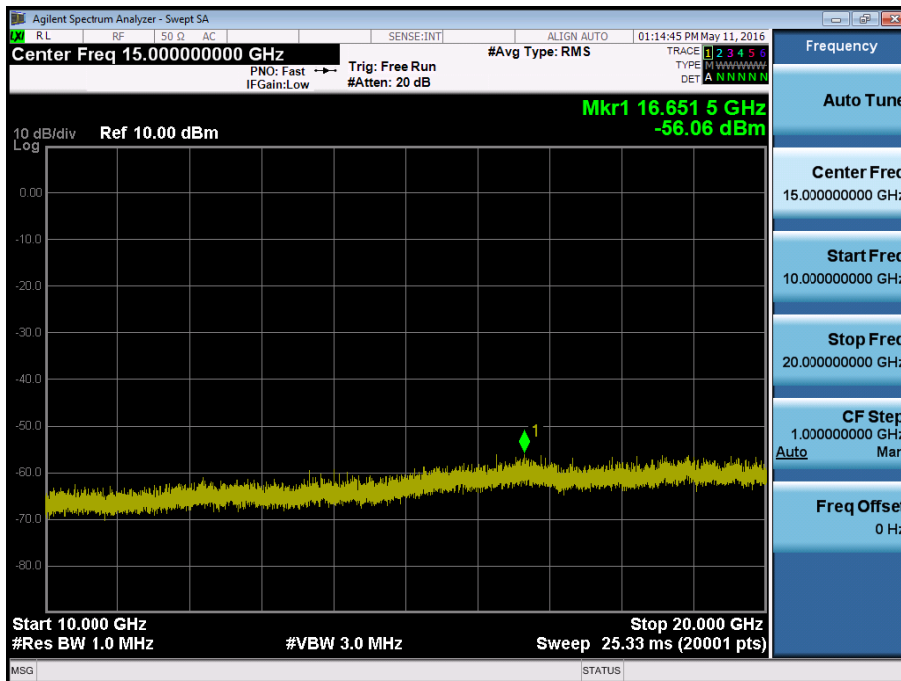

BAND 4. Conducted Spurious Plot_1 (20175ch_10MHz_QPSK_RB 1_0)

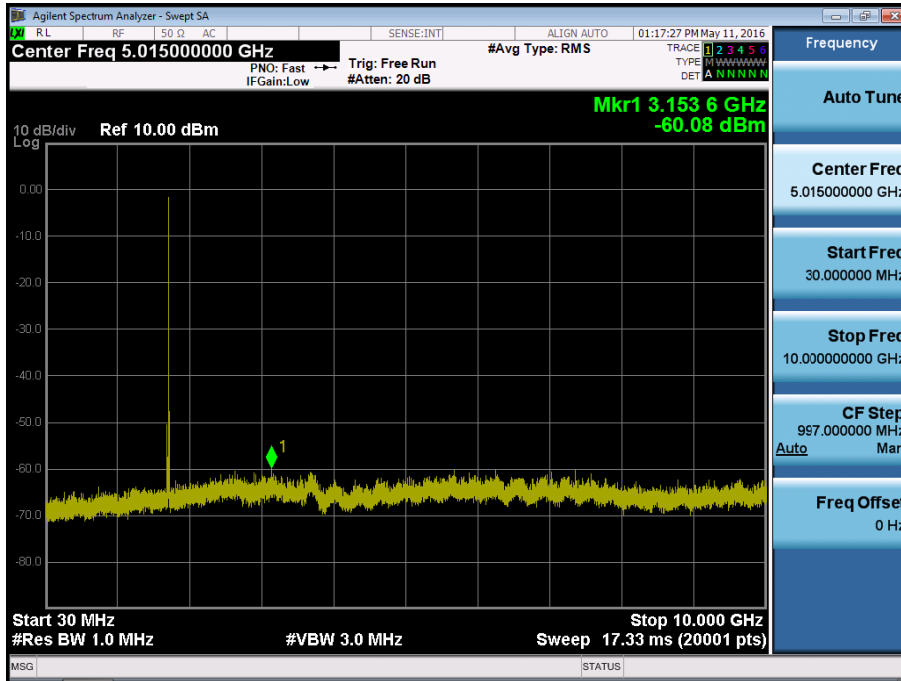

BAND 4. Conducted Spurious Plot_2 (20175ch_10MHz_QPSK_RB 1_0)

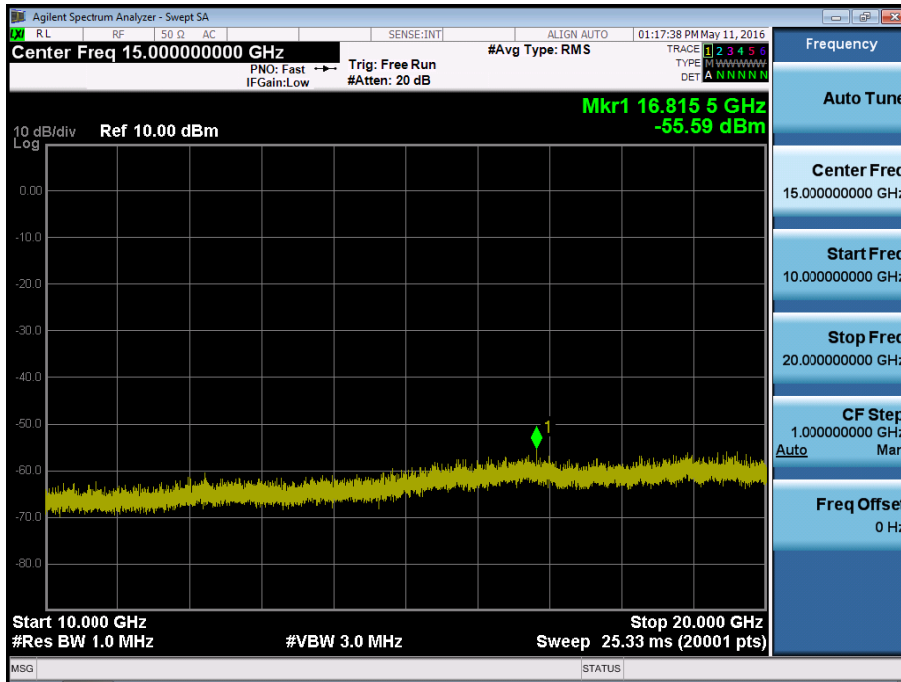

BAND 4. Conducted Spurious Plot_1 (20350ch_10MHz_QPSK_RB 1_0)

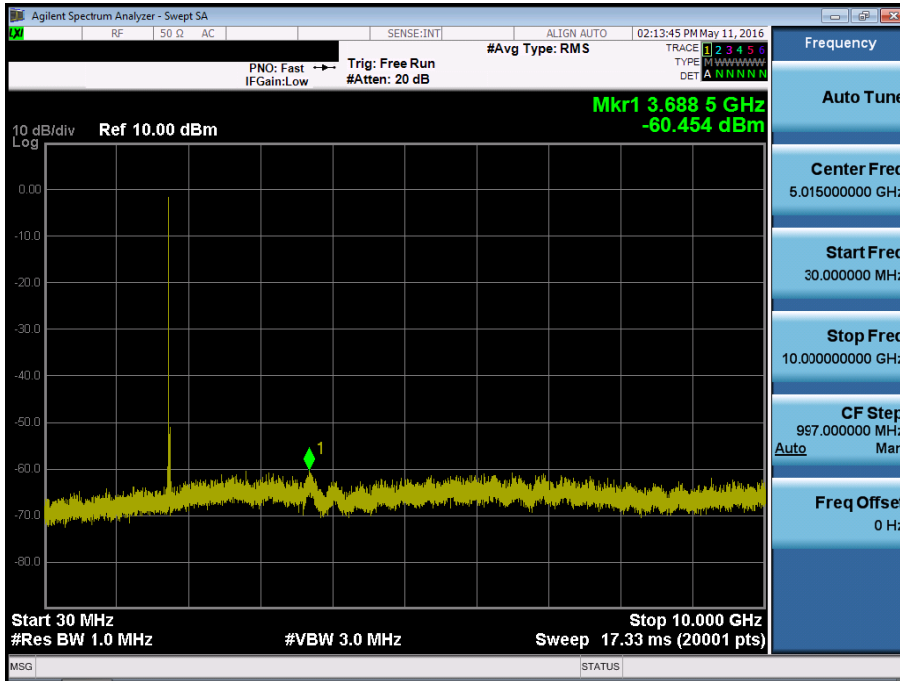

BAND 4. Conducted Spurious Plot_2 (20350ch_10MHz_QPSK_RB 1_0)

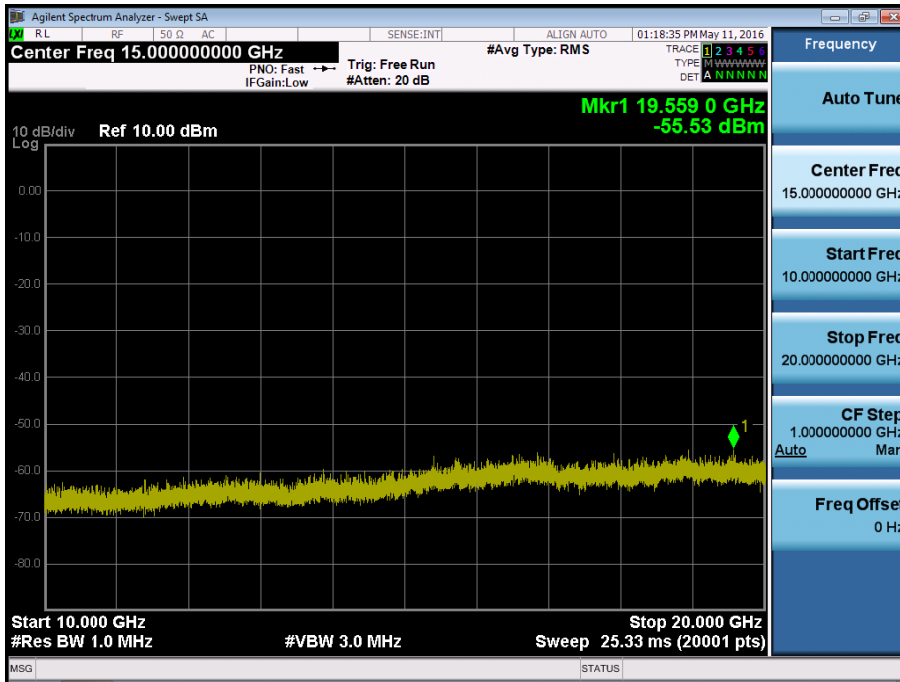

BAND 4. Conducted Spurious Plot_1 (20025ch_15MHz_QPSK_RB 1_0)

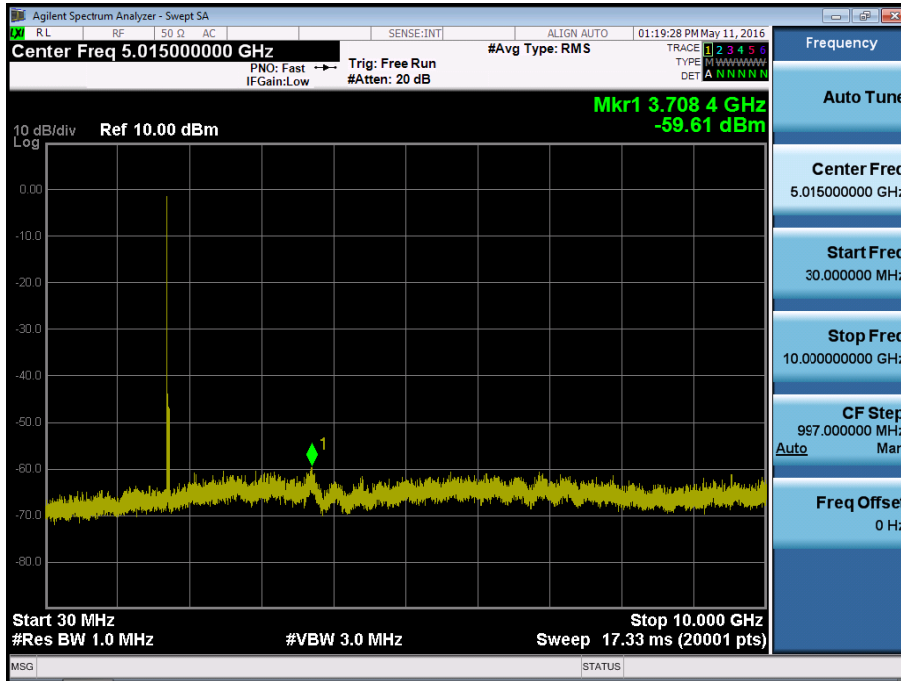

BAND 4. Conducted Spurious Plot_2 (20025ch_15MHz_QPSK_RB 1_0)

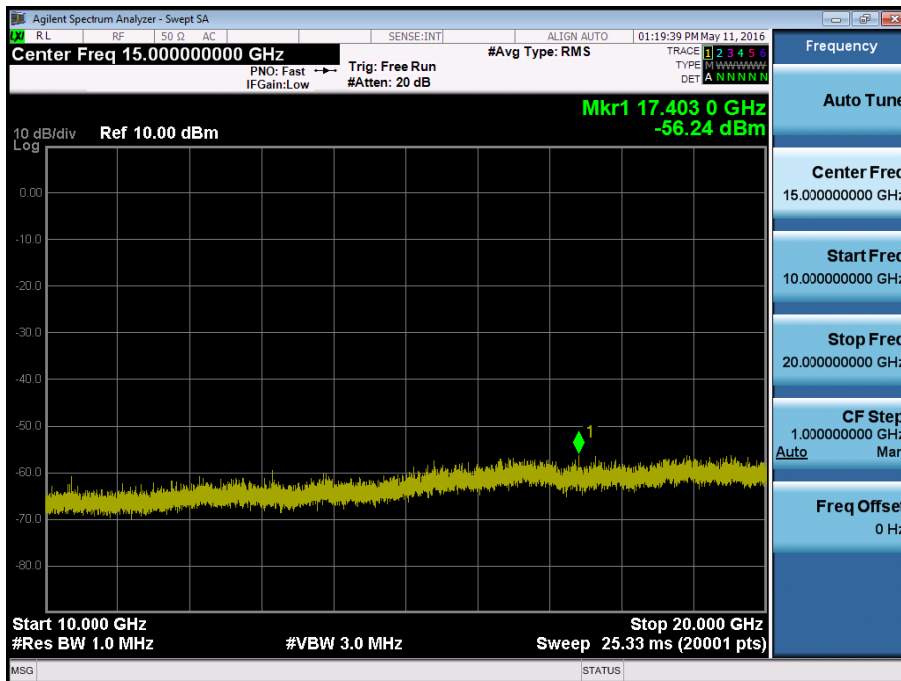

BAND 4. Conducted Spurious Plot_1 (20175ch_15MHz_QPSK_RB 1_0)

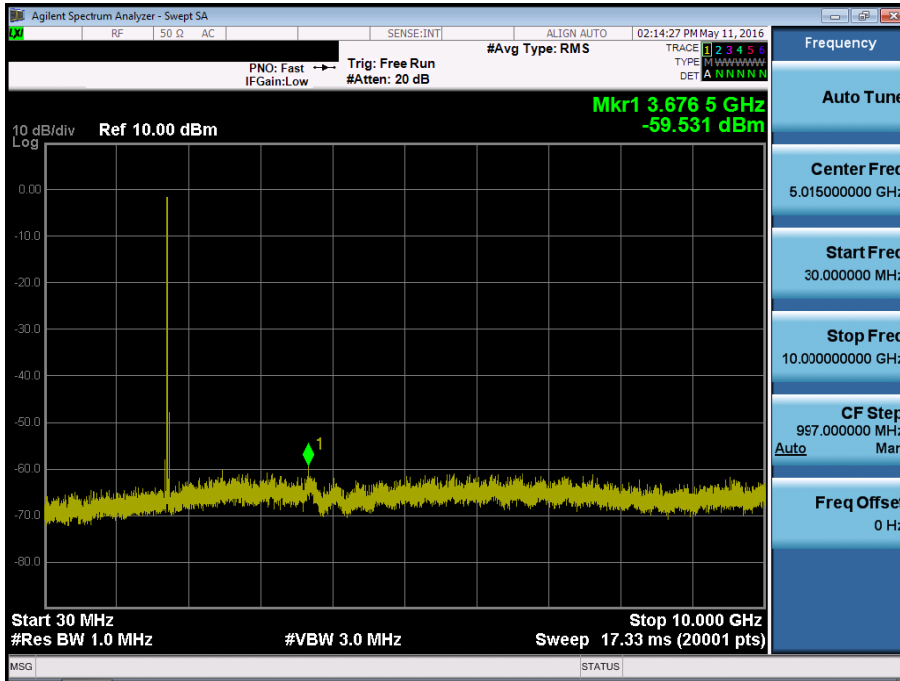

BAND 4. Conducted Spurious Plot_2 (20175ch_15MHz_QPSK_RB 1_0)

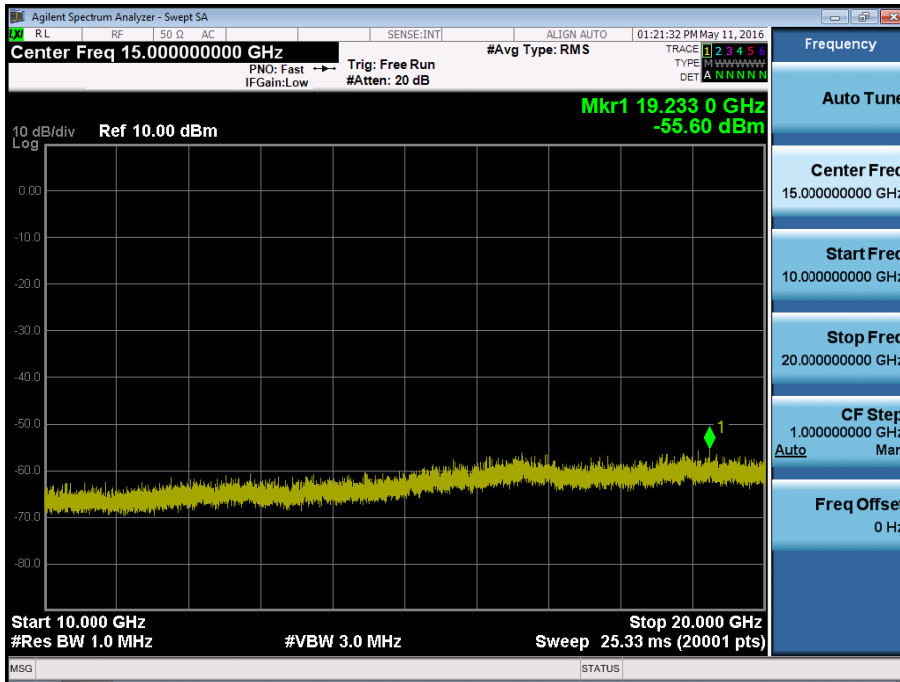

BAND 4. Conducted Spurious Plot_1 (20325ch_15MHz_QPSK_RB 1_0)

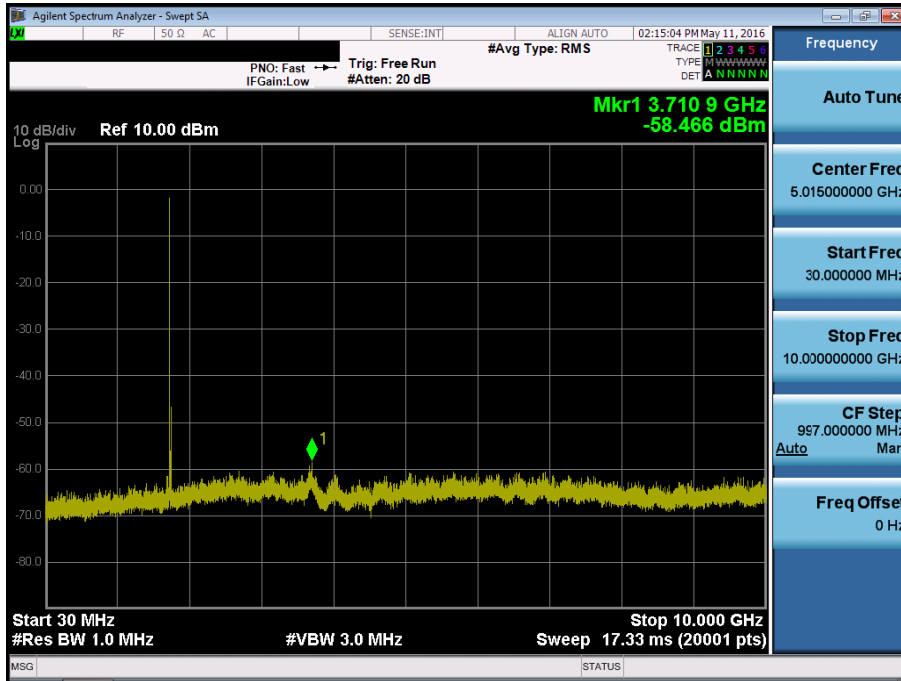

BAND 4. Conducted Spurious Plot_2 (20325ch_15MHz_QPSK_RB 1_0)

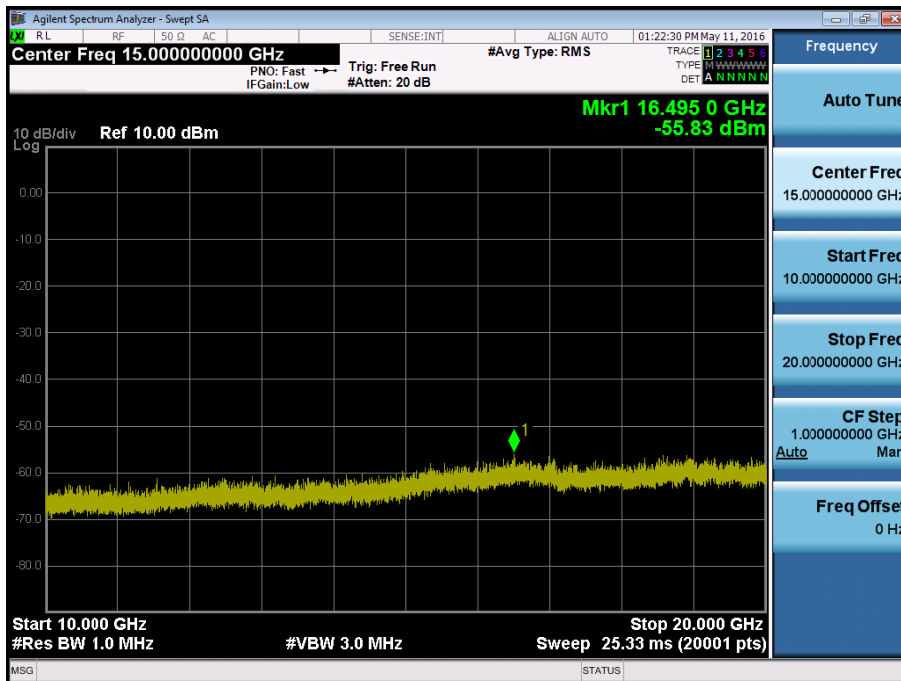

BAND 4. Conducted Spurious Plot_1 (20050ch_20MHz_QPSK_RB 1_0)

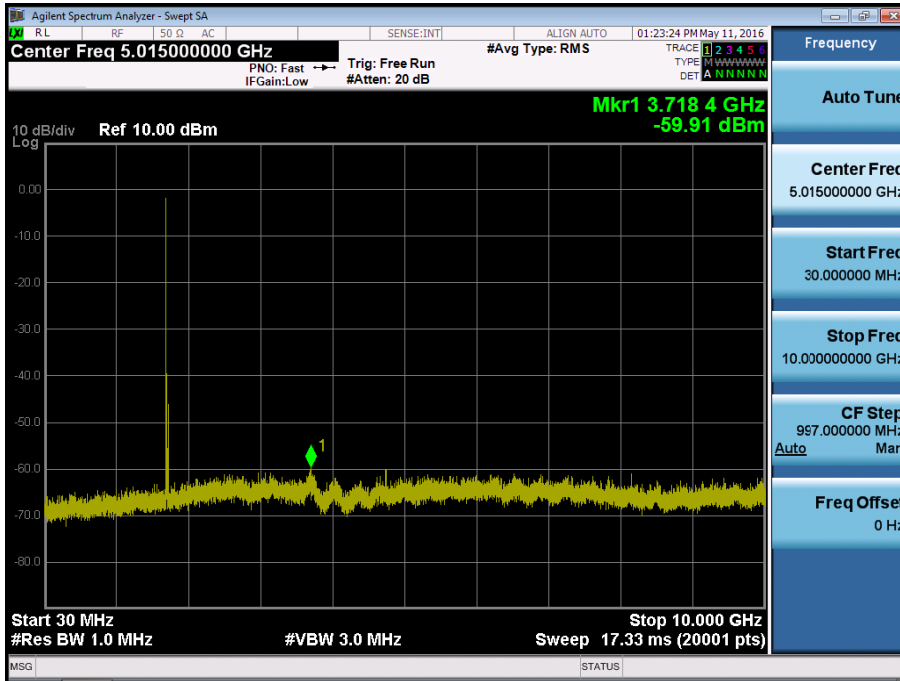

BAND 4. Conducted Spurious Plot_2 (20050ch_20MHz_QPSK_RB 1_0)

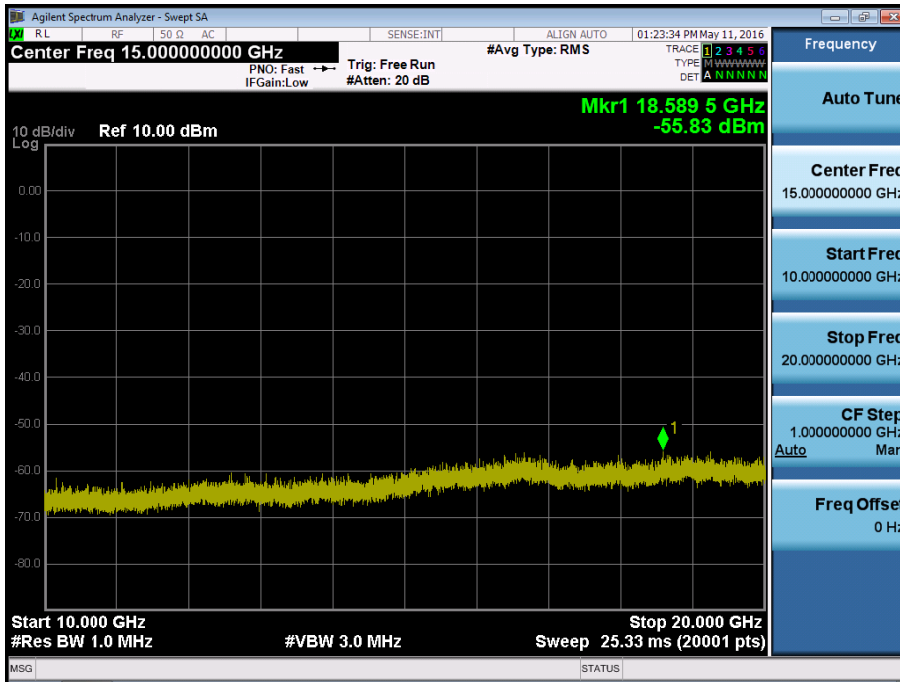

BAND 4. Conducted Spurious Plot_1 (20175ch_20MHz_QPSK_RB 1_0)

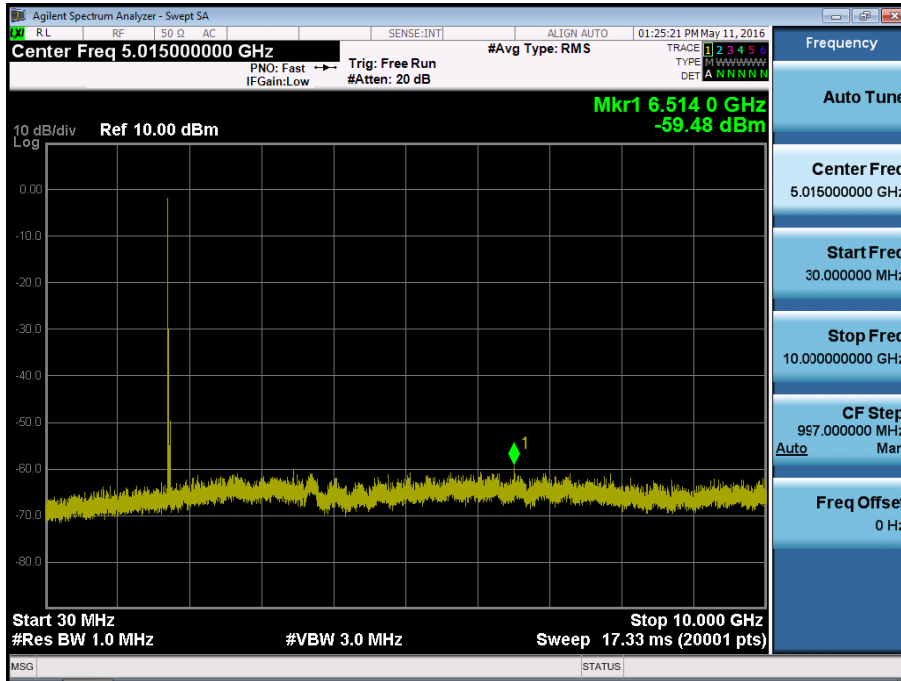

BAND 4. Conducted Spurious Plot_2 (20175ch_20MHz_QPSK_RB 1_0)

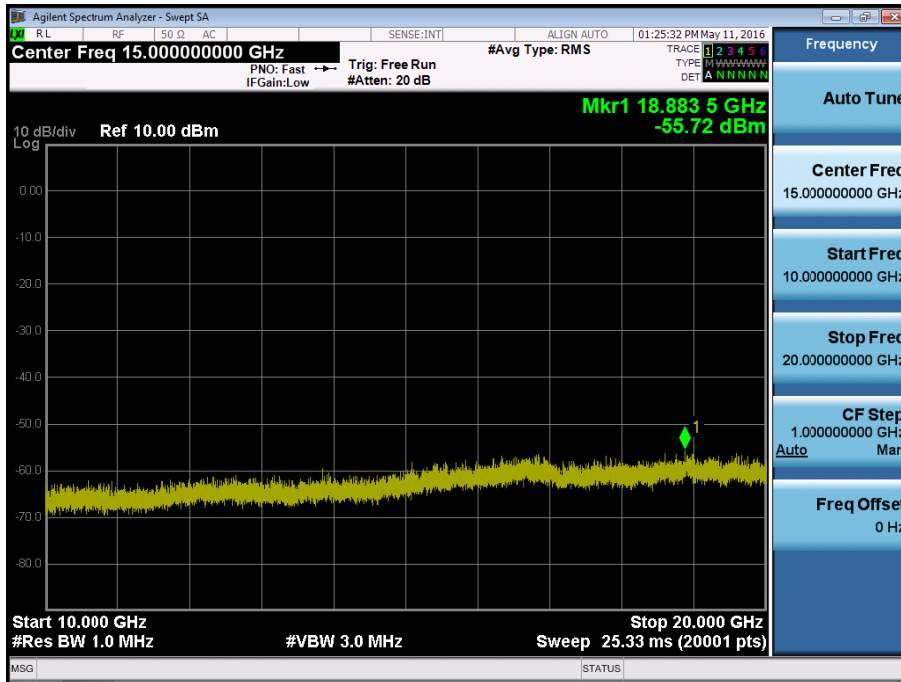

BAND 17. Conducted Spurious Plot_ (23755ch_5MHz_QPSK_RB 1_0)

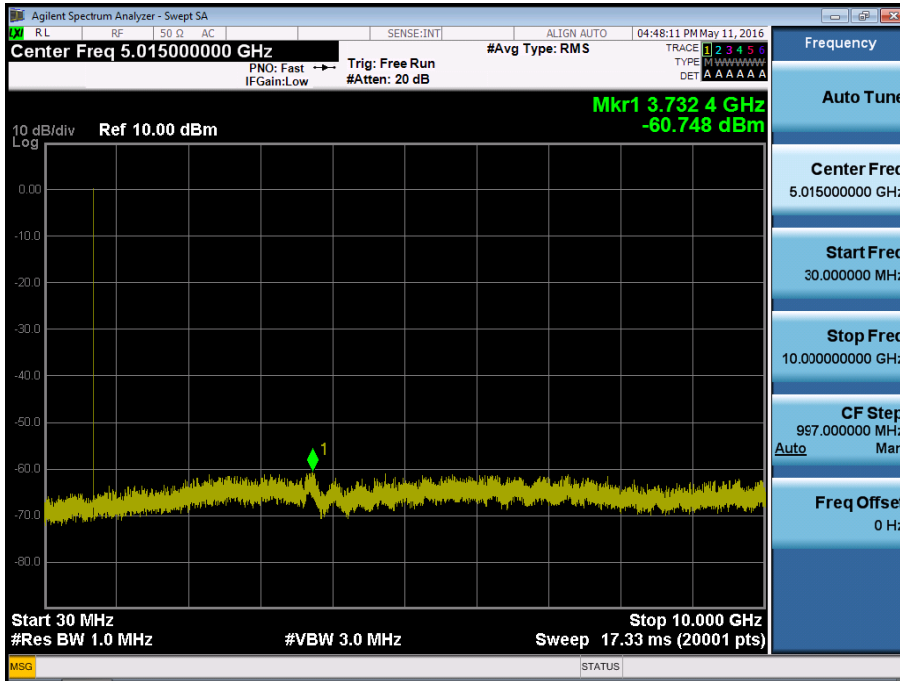

BAND 17. Conducted Spurious Plot_ (23790ch_5MHz_QPSK_RB 1_0)

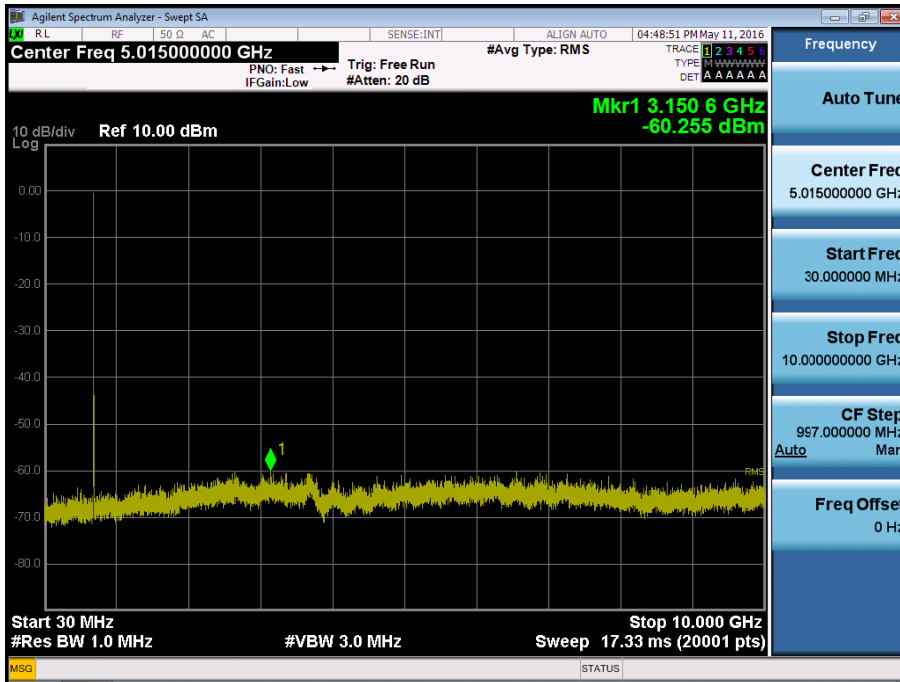

BAND 17. Conducted Spurious Plot_ (23790ch_10MHz_QPSK_RB 1_0)

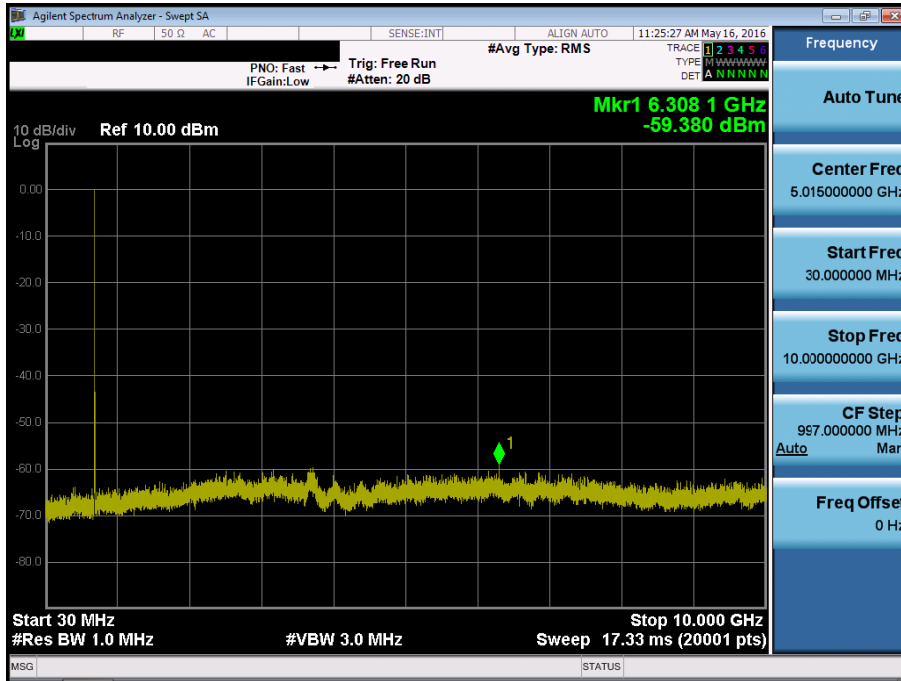

BAND 17. Conducted Spurious Plot_ (23800ch_10MHz_QPSK_RB 1_0)

