

FCC LTE REPORT

FCC Certification

Applicant Name:
 LG Electronics MobileComm U.S.A., Inc.

Date of Issue:
 May 23, 2016

Location:
 HCT CO., LTD.,

Address:
 1000 Sylvan Avenue, Englewood Cliffs NJ 07632

74, Seoicheon-ro 578beon-gil, Majang-myeon,
 Icheon-si, Gyeonggi-do, 17383, Rep. of KOREA

Report No.: HCT-R-1605-F024
HCT FRN: 0005866421

FCC ID: ZNFK220H

APPLICANT: LG Electronics MobileComm U.S.A., Inc.

FCC Model(s): LG-K220H
Additional FCC Model(s): LGK220H, K220H
EUT Type: GSM WCDMA LTE Phone with BT & WLAN
FCC Classification: Licensed Portable Transmitter Held to Ear (PCE)
FCC Rule Part(s): §22, §24, §2

Mode (MHz)	Tx Frequency (MHz)	Emission Designator	Modulation	EIRP	
				Max. Power (W)	Max. Power (dBm)
LTE – Band2 (1.4)	1850.7 - 1909.3	1M09G7D	QPSK	0.221	23.44
		1M09W7D	16QAM	0.179	22.52
LTE – Band2 (3)	1851.5 - 1908.5	2M69G7D	QPSK	0.222	23.47
		2M69W7D	16QAM	0.180	22.56
LTE – Band2 (5)	1852.5 - 1907.5	4M52G7D	QPSK	0.225	23.52
		4M51W7D	16QAM	0.185	22.66
LTE – Band2 (10)	1855.0 - 1905.0	8M97G7D	QPSK	0.218	23.39
		8M95W7D	16QAM	0.179	22.52
LTE – Band2 (15)	1857.5 - 1902.5	13M5G7D	QPSK	0.225	23.53
		13M5W7D	16QAM	0.182	22.59
LTE – Band2 (20)	1860.0 - 1900.0	18M0G7D	QPSK	0.230	23.61
		18M0W7D	16QAM	0.183	22.62

Mode (MHz)	Tx Frequency (MHz)	Emission Designator	Modulation	ERP	
				Max. Power (W)	Max. Power (dBm)
LTE – Band5 (1.4)	824.7 – 848.3	1M10G7D	QPSK	0.058	17.63
		1M09W7D	16QAM	0.047	16.71
LTE – Band5 (3)	825.5 – 847.5	2M70G7D	QPSK	0.058	17.65
		2M69W7D	16QAM	0.048	16.83
LTE – Band5 (5)	826.5 – 846.5	4M52G7D	QPSK	0.058	17.64
		4M51W7D	16QAM	0.049	16.89
LTE – Band5 (10)	829.0 – 844.0	8M98G7D	QPSK	0.062	17.93
		8M97W7D	16QAM	0.051	17.08

The measurements shown in this report were made in accordance with the procedures specified in CFR47 section §2.947. I assume full responsibility for the accuracy and completeness of these measurements, and for the qualifications of all persons taking them.

HCT CO., LTD. Certifies that no party to this application has subject to a denial of Federal benefits that includes FCC benefits pursuant to section 5301 of the Anti-Drug Abuse Act of 1998, 21 U.S. C.853(a)



Report prepared by
: Ki Hyun Kim
Test engineer of RF Team



Approved by
: Kyoung Houn Seo
Manager of RF Team

This report only responds to the tested sample and may not be reproduced, except in full, without written approval of the HCT Co., Ltd.

Version

TEST REPORT NO.	DATE	DESCRIPTION
HCT-R-1605-F024	May 23, 2016	- First Approval Report

Table of Contents

1. GENERAL INFORMATION	6
2. INTRODUCTION	8
2.1. EUT DESCRIPTION.....	8
2.2. MEASURING INSTRUMENT CALIBRATION.....	8
2.3. TEST FACILITY	8
3. DESCRIPTION OF TESTS	9
3.1 ERP/ EIRP RADIATED POWER AND RADIATED SPURIOUS EMISSIONS.....	9
3.2 FREQUENCY RANGE.....	10
3.3 PEAK-AVERAGE RATIO.	11
3.4 OCCUPIED BANDWIDTH.	13
3.5 SPURIOUS AND HARMONIC EMISSIONS AT ANTENNA TERMINAL.....	14
3.6 FREQUENCY STABILITY / VARIATION OF AMBIENT TEMPERATURE	15
4. LIST OF TEST EQUIPMENT	16
5. MEASUREMENT UNCERTAINTY.....	17
6. SUMMARY OF TEST RESULTS	18
7. SAMPLE CALCULATION.....	19
8. TEST DATA	20
8.1 EQUIVALENT ISOTROPIC RADIATED POWER (Band 2)	20
8.2EFFECTIVE RADIATED POWER (Band 5).....	24
8.3RADIATED SPURIOUS EMISSIONS.....	26
8.3.1 RADIATED SPURIOUS EMISSIONS (1.4 MHz Band 2 LTE).....	26
8.3.2 RADIATED SPURIOUS EMISSIONS (3 MHz Band 2 LTE).....	27
8.3.3 RADIATED SPURIOUS EMISSIONS (5 MHz Band 2 LTE).....	28
8.3.4 RADIATED SPURIOUS EMISSIONS (10 MHz Band 2 LTE).....	29
8.3.5 RADIATED SPURIOUS EMISSIONS (15 MHz Band 2 LTE).....	30
8.3.6 RADIATED SPURIOUS EMISSIONS (20 MHz Band 2 LTE).....	31
8.3.7RADIATED SPURIOUS EMISSIONS (1.4 MHz Band 5 LTE).....	32
8.3.8 RADIATED SPURIOUS EMISSIONS (3 MHz Band 5 LTE).....	33
8.3.9 RADIATED SPURIOUS EMISSIONS (5 MHz Band 5 LTE).....	34
8.3.10 RADIATED SPURIOUS EMISSIONS (10 MHz Band 5 LTE).....	35
8.4PEAK-TO-AVERAGE RATIO	36
8.5OCCUPIED BANDWIDTH	37
8.6CONDUCTED SPURIOUS EMISSIONS	38
8.6.1 BAND EDGE.....	39
8.7 FREQUENCY STABILITY / VARIATION OF AMBIENT TEMPERATURE	40

8.7.1 FREQUENCY STABILITY (1.4 MHz Band 2 LTE)	40
8.7.2 FREQUENCY STABILITY (3 MHz Band 2 LTE)	41
8.7.3 FREQUENCY STABILITY (5 MHz Band 2 LTE)	42
8.7.4 FREQUENCY STABILITY (10 MHz Band 2 LTE)	43
8.7.5 FREQUENCY STABILITY (15 MHz Band 2 LTE)	44
8.7.6 FREQUENCY STABILITY (20 MHz Band 2 LTE)	45
8.7.7FREQUENCY STABILITY (1.4 MHz Band 5 LTE)	46
8.7.8 FREQUENCY STABILITY (3 MHz Band 5 LTE)	47
8.7.9 FREQUENCY STABILITY (5 MHz Band 5 LTE)	48
8.7.10 FREQUENCY STABILITY (10 MHz Band 5 LTE)	49
9. TEST PLOTS.....	50

MEASUREMENT REPORT

1. GENERAL INFORMATION

Applicant Name: LG Electronics MobileComm U.S.A., Inc.
Address: 1000 Sylvan Avenue, Englewood Cliffs NJ 07632
FCC ID: ZNFK220H
Application Type: Certification
FCC Classification: Licensed Portable Transmitter Held to Ear (PCE)
FCC Rule Part(s): §22,§24, §2
EUT Type: GSM WCDMA LTE Phone with BT & WLAN
FCC Model(s): LG-K220H
Additional FCC Model(s): LGK220H, K220H
Tx Frequency: 1850.7 MHz – 1909.3 MHz (LTE – Band2 (1.4 MHz))
1851.5 MHz – 1908.5 MHz (LTE – Band2 (3 MHz))
1852.5 MHz – 1907.5 MHz (LTE – Band2 (5 MHz))
1855.0 MHz – 1905.0 MHz (LTE – Band2 (10 MHz))
1857.5 MHz – 1902.5 MHz (LTE – Band2 (15 MHz))
1860.0 MHz – 1900.0 MHz (LTE – Band2 (20 MHz))

824.7 MHz – 848.3 MHz (LTE – Band 5 (1.4 MHz))
825.5 MHz – 847.5 MHz (LTE – Band 5 (3 MHz))
826.5 MHz – 846.5 MHz (LTE – Band 5 (5 MHz))
829.0 MHz – 844.0 MHz (LTE – Band 5 (10 MHz))

Max. RF Output Power:

Band 2 (1.4 MHz) :	0.221 W (QPSK) (23.44 dBm)
	0.179 W (16-QAM) (22.52 dBm)
Band 2 (3 MHz) :	0.222 W (QPSK) (23.47 dBm)
	0.180 W (16-QAM) (22.56 dBm)
Band 2 (5 MHz) :	0.225 W (QPSK) (23.52 dBm)
	0.185 W (16-QAM) (22.66 dBm)
Band 2 (10 MHz) :	0.218 W (QPSK) (23.39 dBm)
	0.179 W (16-QAM) (22.52 dBm)
Band 2 (15 MHz) :	0.225 W (QPSK) (23.53 dBm)
	0.182 W (16-QAM) (22.59 dBm)
Band 2 (20 MHz) :	0.230 W (QPSK) (23.61 dBm)
	0.183 W (16-QAM) (22.62 dBm)
Band 5 (1.4 MHz) :	0.058 W (QPSK) (17.63 dBm)
	0.047W (16-QAM) (16.71 dBm)
Band 5 (3 MHz) :	0.058 W (QPSK) (17.65 dBm)
	0.048 W (16-QAM) (16.83 dBm)
Band 5 (5 MHz) :	0.058 W (QPSK) (17.64 dBm)
	0.049 W (16-QAM) (16.89 dBm)
Band 5 (10 MHz) :	0.062 W (QPSK) (17.93 dBm)
	0.051 W (16-QAM) (17.08 dBm)

Emission Designator(s):	Band 2 (1.4 MHz) :	1M09G7D (QPSK) / 1M09W7D (16-QAM)	
	Band 2 (3 MHz)	2M69G7D (QPSK) / 2M69W7D (16-QAM)	
	Band 2 (5 MHz) :	4M52G7D (QPSK) / 4M51W7D (16-QAM)	
	Band 2 (10 MHz)	8M97G7D (QPSK) / 8M95W7D (16-QAM)	
	Band 2 (15 MHz) :	13M5G7D (QPSK) / 13M5W7D (16-QAM)	
	Band 2 (20 MHz)	18M0G7D (QPSK) / 18M0W7D (16-QAM)	
	Band 5 (1.4 MHz) :	1M10G7D (QPSK) / 1M09W7D (16-QAM)	
	Band 5 (3 MHz) :	2M70G7D (QPSK) / 2M69W7D (16-QAM)	
	Band 5 (5 MHz) :	4M52G7D (QPSK) / 4M51W7D (16-QAM)	
	Band 5 (10 MHz) :	8M98G7D (QPSK) / 8M97W7D (16-QAM)	

Date(s) of Tests: April 20, 2016 ~ May 19, 2016

Antenna Specification:
Manufacturer: LS Mtron Co., Ltd.
Antenna type: PIFA Antenna (Planar Inverted F)
Peak Gain: Band 2 : -1.03 dBi
Band 5 : -3.99 dBi

2. INTRODUCTION

2.1. EUT DESCRIPTION

The LG Electronics MobileComm U.S.A., Inc.LG-K220H GSM WCDMA LTE Phone with BT & WLAN consists of LTE 2 and 5.

2.2. MEASURING INSTRUMENT CALIBRATION

The measuring equipment, which was utilized in performing the tests documented herein, has been calibrated in accordance with the manufacturer's recommendations for utilizing calibration equipment, which is traceable to recognized national standards.

2.3. TEST FACILITY

The Fully-anechoic chamber and conducted measurement facility used to collect the radiated data are located at the **74, Seoicheon-ro 578beon-gil, Majang-myeon, Icheon-si, Gyeonggi-do, 17383, Rep. of KOREA.**

3. DESCRIPTION OF TESTS

3.1 ERP/ EIRP RADIATED POWER AND RADIATED SPURIOUS EMISSIONS

Note: ERP(Effective Radiated Power), EIRP(Effective Isotropic Radiated Power)

Test Procedure

Radiated emission measurements are performed in the Fully-anechoic chamber. The equipment under test is placed on a non-conductive table 3-meters away from the receive antenna in accordance with ANSI/TIA-603-D-2010 Clause 2.2.17. The turntable is rotated through 360 degrees, and the receiving antenna scans in order to determine the level of the maximized emission. The level and position of the maximized emission is recorded with the spectrum analyzer using a RMS detector.

A half wave dipole is then substituted in place of the EUT. For emissions above 1GHz, a horn antenna is substituted in place of the EUT. The substitute antenna is driven by a signal generator and the previously recorded signal was duplicated.

The power is calculated by the following formula;

$$P_{d(dBm)} = P_{g(dBm)} - \text{cable loss}_{(dB)} + \text{antenna gain}_{(dB)}$$

Where: P_d is the dipole equivalent power and P_g is the generator output power into the substitution antenna.

The maximum EIRP is calculated by adding the forward power to the calibrated source plus its appropriate gain value. These steps are repeated with the receiving antenna in both vertical and horizontal polarization. the difference between the gain of the horn and an isotropic antenna are taken into consideration

Radiated spurious emissions

: Frequency Range : 30 MHz ~ 10th Harmonics of highest channel fundamental frequency.

3.3 PEAK-AVERAGE RATIO.

Test Procedure

Peak to Average Power Ratio is tested in accordance with KDB971168 D01 Power Meas License Digital Systems v02r02, October 17, 2014, Section 5.7.

- Section 5.7.1 CCDF Procedure

- a) Set resolution/measurement bandwidth \geq signal's occupied bandwidth;
- b) Set the number of counts to a value that stabilizes the measured CCDF curve;
- c) Set the measurement interval as follows:
 - 1) for continuous transmissions, set to 1 ms,
 - 2) for burst transmissions, employ an external trigger that is synchronized with the EUT burst timing sequence, or use the internal burst trigger with a trigger level that allows the burst to stabilize and set the measurement interval to a time that is less than or equal to the burst duration.
- d) Record the maximum PAPR level associated with a probability of 0.1%.

- Section 5.7.2 Alternate Procedure

Use one of the procedures presented in 5.1 to measure the total peak power and record as P_{Pk} . Use one of the applicable procedures presented 5.2 to measure the total average power and record as P_{Avg} . Determine the P.A.R. from: $P.A.R_{(dB)} = P_{Pk (dBm)} - P_{Avg (dBm)}$ (P_{Avg} = Average Power + Duty cycle Factor)

5.1.1 Peak power measurements with a spectrum/signal analyzer or EMI receiver

The following procedure can be used to determine the total peak output power.

- a) Set the RBW \geq OBW.
- b) Set VBW $\geq 3 \times$ RBW.
- c) Set span $\geq 2 \times$ RBW
- d) Sweep time = auto couple.
- e) Detector = peak.
- f) Ensure that the number of measurement points \geq span/RBW.
- g) Trace mode = max hold.
- h) Allow trace to fully stabilize.
- i) Use the peak marker function to determine the peak amplitude level.

5.2.2 Procedures for use with a spectrum/signal analyzer when EUT cannot be configured to transmit continuously and sweep triggering/signal gating cannot be properly implemented

If the EUT cannot be configured to transmit continuously (burst duty cycle < 98%), then one of the following procedures can be used. The selection of the applicable procedure will depend on the characteristics of the measured burst duty cycle.

Measure the burst duty cycle with a spectrum/signal analyzer or EMC receiver can be used in zero-span mode if the response time and spacing between bins on the sweep are sufficient to permit accurate measurement of the burst on/off time of the transmitted signal.

5.2.2.2 Constant burst duty cycle

If the measured burst duty cycle is constant (i.e., duty cycle variations are less than ± 2 percent), then:

- a) Set span to at least 1.5 times the OBW.
- b) Set RBW = 1-5% of the OBW, not to exceed 1 MHz.
- c) Set VBW $\geq 3 \times$ RBW.
- d) Number of points in sweep $\geq 2 \times$ span / RBW. (This gives bin-to-bin spacing \leq RBW/2, so that narrowband signals are not lost between frequency bins.)
- e) Sweep time = auto.
- f) Detector = RMS (power averaging).
- g) Set sweep trigger to "free run".
- h) Trace average at least 100 traces in power averaging (i.e., RMS) mode.
- i) Compute power by integrating the spectrum across the OBW of the signal using the instrument's band power measurement function with band limits set equal to the OBW band edges. If the instrument does not have a band power function, sum the spectrum levels (in power units) at intervals equal to the RBW extending across the entire OBW of the spectrum.
- j) Add $10 \log (1/x)$, where x is the duty cycle, to the measured power in order to compute the average power during the actual transmission times (because the measurement represents an average over both the on and off times of the transmission).

For example, add $10 \log (1/0.25) = 6$ dB if the duty cycle is a constant 25%.

3.4 OCCUPIED BANDWIDTH.

Test set-up

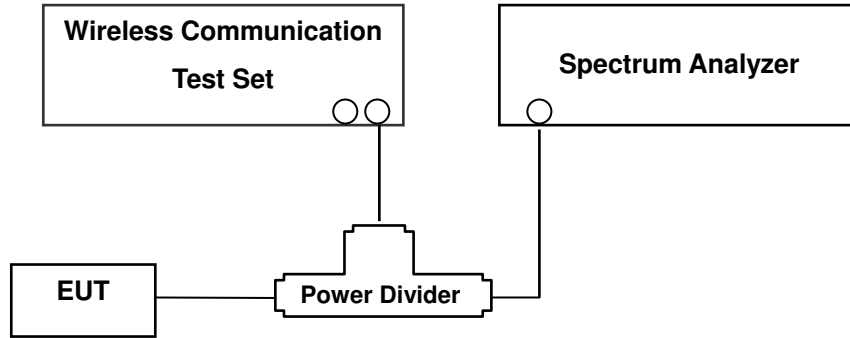

(Configuration of conducted Emission measurement)

The width of a frequency band such that, below the lower and above the upper frequency limits, the mean powers emitted are each equal to a specified percentage 0.5 % of the total mean power of a given emission.

Test Procedure

OBW is tested in accordance with KDB971168 D01 Power Meas License Digital Systems v02r02, October 17, 2014, Section 4.2.

The EUT makes a call to the communication simulator. The power was measured with R&S Spectrum Analyzer. All measurements were done at 3 channels(low, middle and high operational range.)

The conducted occupied bandwidth used the power splitter via EUT RF power connector between simulation base station and spectrum analyzer.

The communication simulator station system controlled a EUT to export maximum output power under transmission mode and specific channel frequency. Use OBW measurement function of Spectrum analyzer to measure 99 % occupied bandwidth

3.5 SPURIOUS AND HARMONIC EMISSIONS AT ANTENNA TERMINAL.

Test Procedure

Spurious and harmonic emissions at antenna terminal is tested in accordance with KDB971168 D01 Power Meas License Digital Systems v02r02, October 17, 2014, Section 6.0.

The level of the carrier and the various conducted spurious and harmonic frequencies is measured by means of a calibrated spectrum analyzer.

The EUT was setup to maximum output power at its lowest channel. The Resolution BW of the analyzer is set to 1 % of the emission bandwidth to show compliance with the -13 dBm limit, in the 1 MHz bands immediately outside and adjacent to the edge of the frequency block. The 1 MHz RBW was used to scan from 30 MHz to 10th Harmonics. A display line was placed at -13 dBm to show compliance. The high, lowest and a middle channel were tested for out of band measurements.

- Band Edge Requirement : In the 1MHz bands immediately outside and adjacent to the frequency block, a resolution bandwidth of at least 1 percent of the emission bandwidth of the fundamental emission of the transmitter may be employed to measure the out of band Emissions. Limit, -13dBm.

NOTES: The analyzer plot offsets were determined by below conditions.

- For LTE Band 2, total offset 27.5 dBm = 20 dBm attenuator + 6 dBm Divider + 1.5 dBm RF cables.
- For LTE Band 5, total offset 27.1 dBm = 20 dBm attenuator + 6 dBm Divider + 1.1 dBm RF cables.

3.6 FREQUENCY STABILITY / VARIATION OF AMBIENT TEMPERATURE

Test Set-up

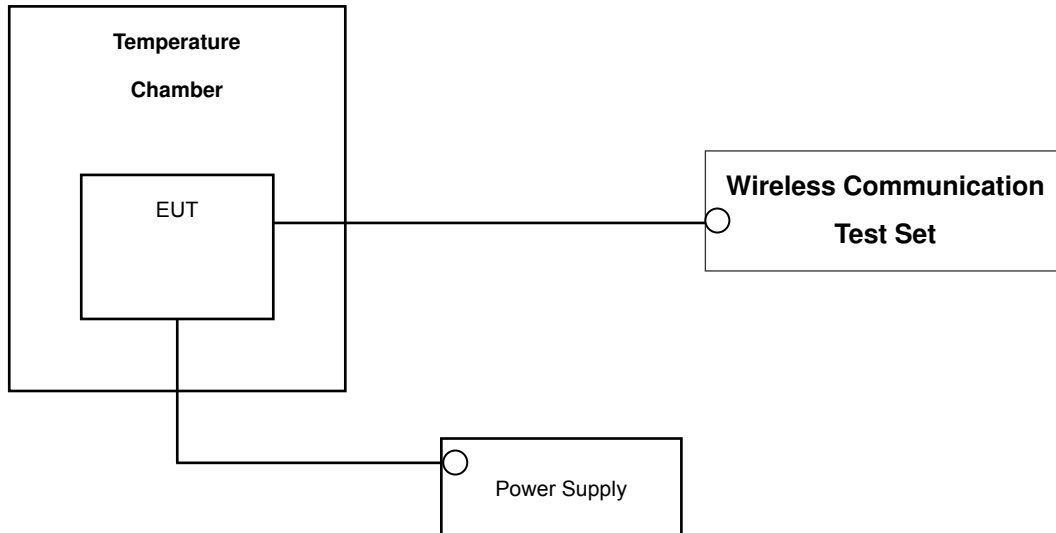

* Nominal Operating Voltage

Test Procedure

Frequency stability is tested in accordance with ANSI/TIA-603-D-2010 section 2.2.2

The frequency stability of the transmitter is measured by:

- a.) **Temperature:** The temperature is varied from - 30 °C to + 50 °C using an environmental chamber.
- b.) **Primary Supply Voltage:** The primary supply voltage is varied from the end point to 100 % of the voltage normally at the input to the device or at the power supply terminals if cables are not normally supplied.

Specification — the frequency stability shall be sufficient to ensure that the fundamental emission stays within the authorized frequency block(LTE Band2).The frequency stability of the transmitter shall be maintained within $\pm 0.00025\%$ (± 2.5 ppm) of the center frequency. (LTE Band5).

Time Period and Procedure:

The carrier frequency of the transmitter is measured at room temperature (20°C to provide a reference).

1. The equipment is turned on in a “standby” condition for one minute before applying power to the transmitter. Measurement of the carrier frequency of the transmitter is made within one minute after applying power to the transmitter.
2. Frequency measurements are made at 10°C intervals ranging from -30°C to +50°C. A period of at least one half-hour is provided to allow stabilization of the equipment at each temperature level.

NOTE: The EUT is tested down to the battery endpoint.

4. LIST OF TEST EQUIPMENT

Manufacture	Model/ Equipment	Serial Number	Calibration Interval	Calibration Due
MITEQ	AMF-6D-001180-35-20P/AMP	1081666	Annual	09/03/2016
Wainwright	WHK1.2/15G-10EF/H.P.F	4	Annual	04/11/2017
Wainwright	WHK3.3/18G-10EF/H.P.F	2	Annual	04/11/2017
Hewlett Packard	11667B / Power Splitter	10545	Annual	02/15/2017
Hewlett Packard	11667B / Power Splitter	11275	Annual	04/29/2017
ITECH	IT6720/ Power Supply	0100215626700119	Annual	11/02/2016
Schwarzbeck	UHAP/ Dipole Antenna	557	Biennial	03/23/2017
Schwarzbeck	UHAP/ Dipole Antenna	558	Biennial	03/23/2017
EXP	EX-TH400/ Chamber	None	Annual	05/29/2016
Schwarzbeck	BBHA 9120D/ Horn Antenna	147	Biennial	09/01/2016
Schwarzbeck	BBHA 9120D/ Horn Antenna	1299	Biennial	05/15/2017
Schwarzbeck	BBHA 9170/ Horn Antenna(15~40GHz)	BBHA9170342	Biennial	04/30/2017
Schwarzbeck	BBHA 9170/ Horn Antenna(15~35GHz)	BBHA9170124	Biennial	04/30/2017
Agilent	N9020A/Signal Analyzer	MY52090906	Annual	05/13/2017
Hewlett Packard	8493C/ATTENUATOR	17280	Annual	06/29/2016
REOHDE&SCHWARZ	FSV40/Spectrum Analyzer	1307.9002K40-100931-NK	Annual	06/04/2016
Agilent	8960 (E5515C)/ Base Station	MY48360800	Annual	10/30/2016
Anritsu Corp.	MT8820C/Wideband Radio Communication Tester	6200863156	Annual	02/26/2017
Anritsu Corp.	MT8820C/Wideband Radio Communication Tester	6201026545	Annual	02/16/2017
Schwarzbeck	VULB9160/ Bilog Antenna	3150	Biennial	11/17/2016
Schwarzbeck	VULB9160/ Bilog Antenna	3368	Biennial	10/10/2016

5. MEASUREMENT UNCERTAINTY

The measurement uncertainties shown below were calculated in accordance with the requirements of ANSI C63.4:2014.

All measurement uncertainty values are shown with a coverage factor of $k = 2$ to indicate a 95 % level of confidence. The measurement data shown herein meets or exceeds the U_{CISPR} measurement uncertainty values specified in CISPR 16-4-2 and, thus, can be compared directly to specified limits to determine compliance.

Parameter	Expanded Uncertainty (\pm dB)
Conducted Disturbance (150 kHz ~ 30 MHz)	1.82
Radiated Disturbance (9 kHz ~ 30 MHz)	3.40
Radiated Disturbance (30 MHz ~ 1 GHz)	4.80
Radiated Disturbance (1 GHz ~ 18 GHz)	6.07

6. SUMMARY OF TEST RESULTS

FCC Part Section(s)	Test Description	Test Limit	Test Condition	Test Result
2.1049	Occupied Bandwidth	N/A	CONDUCTED	PASS
2.1051, 22.917(a), 24.238(a)	Band Edge / Spurious and Harmonic Emissions at Antenna Terminal.	< 43 + 10log ₁₀ (P[Watts]) at Band Edge and for all out-of-band emissions		PASS
2.1046	*Conducted Output Power	N/A		PASS
24.232(d)	Peak- to- Average Ratio	< 13 dB		PASS
2.1055, 22.355	Frequency stability / variation of ambient temperature	< 2.5 ppm (Part22)		PASS
24.235		Emission must remain in band (Part24)		
22.913(a)(2)	Effective Radiated Power (Band 5)	< 7 Watts max. ERP	RADIATED	PASS
24.232(c)	Equivalent Isotropic Radiated Power (Band 2)	< 2 Watts max. EIRP		PASS
2.1053, 22.917(a), 24.238(a)	Radiated Spurious and Harmonic Emissions	< 43 + 10log ₁₀ (P[Watts]) for all out-of band emissions		PASS

*See SAR Report

7. SAMPLE CALCULATION

A. ERP Sample Calculation

Mode	Ch./ Freq.		Measured Level(dBm)	Substitute LEVEL(dBm)	Ant. Gain (dBd)	C.L	Pol.	Limit W	ERP	
	channel	Freq.(MHz)							W	dBm
LTE Band5	20525	836.50	-6.73	40.89	-10.54	0.96	V	<7.00	0.869	29.39

ERP = SubstituteLEVEL(dBm) + Ant. Gain – CL(Cable Loss)

- 1) The EUT mounted on a wooden tripod is 2.5 meter above test site ground level.
- 2) During the test , the turn table is rotated until the maximum signal is found.
- 3) Record the field strength meter's level.
- 4) Replace the EUT with dipole/Horn antenna that is connected to a calibrated signal generator.
- 5) Increase the signal generator output till the field strength meter's level is equal to the item (3).
- 6) The signal generator output level with Ant. Gain and cable loss are the rating of equivalent isotropic radiated power(ERP).

B. Emission Designator

QPSK Modulation

5MHz Bandwidth

Emission Designator = 4M48G7D

LTE BW = 4.48 MHz

G = Phase Modulation

7 = Quantized/Digital Info

D = Data transmission; telemetry; telecommand

10MHz Bandwidth

Emission Designator = 8M95G7D

LTE BW = 8.95 MHz

G = Phase Modulation

7 = Quantized/Digital Info

D = Data transmission; telemetry; telecommand

16QAM Modulation

5MHz Bandwidth

Emission Designator = 4M48W7D

LTE BW = 4.48 MHz

W = main carrier modulated in a combination of two or more of the following modes;
amplitude, angle, pulse

7 = Quantized/Digital Info

D = Data transmission; telemetry; telecommand

10MHz Bandwidth

Emission Designator = 8M95W7D

LTE BW = 8.95 MHz

W = main carrier modulated in a combination of two or more of the following modes;
amplitude, angle, pulse

7 = Quantized/Digital Info

D = Data transmission; telemetry; telecommand

8. TEST DATA

8.1 EQUIVALENT ISOTROPIC RADIATED POWER (Band 2)

Freq (MHz)	Bandwidth	Modulation	Measured Level (dBm)	Substitute Level (dBm)	Ant. Gain(dBi)	C.L	Pol	Limit	EIRP	
								W	W	dBm
1850.7	1.4 MHz	QPSK	-17.45	16.16	9.82	2.54	V	< 2.00	0.221	23.44
		16-QAM	-18.37	15.24	9.82	2.54	V		0.179	22.52
1880.0		QPSK	-17.82	16.06	9.91	2.57	V		0.219	23.40
		16-QAM	-18.94	14.94	9.91	2.57	V		0.169	22.28
1909.3		QPSK	-19.25	14.99	10	2.6	V		0.173	22.39
		16-QAM	-20.17	14.12	10	2.6	V		0.142	21.52

Equivalent Isotropic Radiated Power Data (1.4 MHz Band 2 LTE)

Note: All of RB size has been tested for emissions and EIRP, with the 1RB configuration observed as the worst case

Freq (MHz)	Bandwidth	Modulation	Measured Level (dBm)	Substitute Level (dBm)	Ant. Gain(dBi)	C.L	Pol	Limit	EIRP	
								W	W	dBm
1851.5	3 MHz	QPSK	-17.48	16.13	9.82	2.54	V	< 2.00	0.219	23.41
		16-QAM	-18.33	15.28	9.82	2.54	V		0.180	22.56
1880.0		QPSK	-17.75	16.13	9.91	2.57	V		0.222	23.47
		16-QAM	-18.81	15.07	9.91	2.57	V		0.174	22.41
1908.5		QPSK	-19.14	14.87	10	2.6	V		0.169	22.27
		16-QAM	-20.14	13.87	10	2.6	V		0.134	21.27

Equivalent Isotropic Radiated Power Data (3 MHz Band 2 LTE)

Note: All of RB size has been tested for emissions and EIRP, with the 1RB configuration observed as the worst case

Freq (MHz)	Bandwidth	Modulation	Measured Level (dBm)	Substitute Level (dBm)	Ant. Gain(dBi)	C.L	Pol	Limit	EIRP	
								W	W	dBm
1852.5	5 MHz	QPSK	-17.44	16.17	9.82	2.54	V	< 2.00	0.221	23.45
		16-QAM	-18.23	15.38	9.82	2.54	V		0.185	22.66
1880.0		QPSK	-17.70	16.18	9.91	2.57	V		0.225	23.52
		16-QAM	-18.78	15.10	9.91	2.57	V		0.175	22.44
1907.5		QPSK	-18.97	15.04	10	2.6	V		0.175	22.44
		16-QAM	-19.87	14.14	10	2.6	V		0.142	21.54

Equivalent Isotropic Radiated Power Data (5 MHz Band 2 LTE)

Note: All of RB size has been tested for emissions and EIRP, with the 1RB configuration observed as the worst case

Freq (MHz)	Bandwidth	Modulation	Measured Level (dBm)	Substitute Level (dBm)	Ant. Gain(dBi)	C.L	Pol	Limit	EIRP	
								W	W	dBm
1855.0	10 MHz	QPSK	-17.71	15.94	9.83	2.54	V	< 2.00	0.210	23.23
		16-QAM	-18.42	15.23	9.83	2.54	V		0.179	22.52
1880.0		QPSK	-17.83	16.05	9.91	2.57	V		0.218	23.39
		16-QAM	-18.92	14.96	9.91	2.57	V		0.170	22.30
1905.0		QPSK	-18.60	15.53	9.98	2.59	V		0.196	22.92
		16-QAM	-19.67	14.46	9.98	2.59	V		0.153	21.85

Equivalent Isotropic Radiated Power Data (10 MHz Band 2 LTE)

Note: All of RB size has been tested for emissions and EIRP, with the 1RB configuration observed as the worst case

Freq (MHz)	Bandwidth	Modulation	Measured Level (dBm)	Substitute Level (dBm)	Ant. Gain(dBi)	C.L	Pol	Limit	EIRP	
								W	W	dBm
1857.5	15 MHz	QPSK	-17.56	16.13	9.85	2.55	V	< 2.00	0.220	23.43
		16-QAM	-18.40	15.29	9.85	2.55	V		0.182	22.59
1880.0		QPSK	-17.69	16.19	9.91	2.57	V		0.225	23.53
		16-QAM	-18.72	15.16	9.91	2.57	V		0.178	22.50
1902.5		QPSK	-18.52	15.51	9.97	2.59	V		0.194	22.89
		16-QAM	-19.53	14.50	9.97	2.59	V		0.154	21.88

Equivalent Isotropic Radiated Power Data (15 MHz Band 2 LTE)

Note: All of RB size has been tested for emissions and EIRP, with the 1RB configuration observed as the worst case

Freq (MHz)	Bandwidth	Modulation	Measured Level (dBm)	Substitute Level (dBm)	Ant. Gain(dBi)	C.L	Pol	Limit	EIRP	
								W	W	dBm
1860.0	20 MHz	QPSK	-17.38	16.31	9.85	2.55	V	< 2.00	0.230	23.61
		16-QAM	-18.37	15.32	9.85	2.55	V		0.183	22.62
1880.0		QPSK	-17.64	16.24	9.91	2.57	V		0.228	23.58
		16-QAM	-18.61	15.27	9.91	2.57	V		0.182	22.61
1900.0		QPSK	-18.12	15.91	9.97	2.59	V		0.213	23.29
		16-QAM	-19.11	14.92	9.97	2.59	V		0.170	22.30

Equivalent Isotropic Radiated Power Data (20 MHz Band 2 LTE)

Note: All of RB size has been tested for emissions and EIRP, with the 1RB configuration observed as the worst case

NOTES:

Equivalent Isotropic Radiated Power Measurements by Substitution Method
according to ANSI/TIA/EIA-603-D-2010 June 24, 2010:

The EUT was placed on a non-conductive styrofoam resin table 3-meters from the receive antenna. Turntable rotation was adjusted for the highest reading on the receive spectrum analyzer. For LTE signals, RBW = 1-5% of the OBW, not to exceed 1MHz, VBW $\geq 3 \times$ RBW, Detector = RMS. A Horn antenna was substituted in place of the EUT. This Horn antenna was driven by a signal generator and the level of the signal generator was adjusted to obtain the same receive spectrum analyzer reading. The conducted power at the terminals of the Horn antenna is measured. The difference between the gain of the horn and an isotropic antenna is taken into consideration and the EIRP is recorded.

Also, we have done x, y, z planes in EUT and horizontal and vertical polarization in detecting antenna. The worst case of the EUT is z plane in LTE mode. Also worst case of detecting Antenna is vertical polarization in LTE mode.

8.2EFFECTIVE RADIATED POWER (Band 5)

Freq (MHz)	Bandwidth	Modulation	Measured Level (dBm)	Substitute Level (dBm)	Ant. Gain(dBd)	C.L	Pol	Limit	ERP	
									W	W
824.7	1.4 MHz	QPSK	-32.77	29.85	-10.59	1.67	V	< 7.00	0.057	17.59
		16-QAM	-33.69	28.93	-10.59	1.67	V		0.046	16.67
836.5		QPSK	-33.71	29.85	-10.54	1.68	V		0.058	17.63
		16-QAM	-34.63	28.93	-10.54	1.68	V		0.047	16.71
848.3		QPSK	-33.53	29.56	-10.49	1.69	V		0.055	17.38
		16-QAM	-34.45	28.64	-10.49	1.69	V		0.044	16.46

Effective Radiated Power Data (1.4 MHz Band 5 LTE)

Note: All of RB size has been tested for emissions and ERP, with the 1RB configuration observed as the worst case

Freq (MHz)	Bandwidth	Modulation	Measured Level (dBm)	Substitute Level (dBm)	Ant. Gain(dBd)	C.L	Pol	Limit	ERP	
									W	W
825.5	3 MHz	QPSK	-32.81	29.89	-10.59	1.67	V	< 7.00	0.058	17.63
		16-QAM	-33.65	29.05	-10.59	1.67	V		0.048	16.79
836.5		QPSK	-33.69	29.87	-10.54	1.68	V		0.058	17.65
		16-QAM	-34.51	29.05	-10.54	1.68	V		0.048	16.83
847.5		QPSK	-33.57	29.52	-10.49	1.69	V		0.054	17.34
		16-QAM	-34.44	28.65	-10.49	1.69	V		0.044	16.47

Effective Radiated Power Data (3 MHz Band 5 LTE)

Note: All of RB size has been tested for emissions and ERP, with the 1RB configuration observed as the worst case

Freq (MHz)	Bandwidth	Modulation	Measured Level (dBm)	Substitute Level (dBm)	Ant. Gain(dBd)	C.L	Pol	Limit		
								W	W	dBm
826.5	5 MHz	QPSK	-32.93	29.89	-10.58	1.67	V	< 7.00	0.058	17.64
		16-QAM	-33.76	29.06	-10.58	1.67	V		0.048	16.81
836.5		QPSK	-33.79	29.77	-10.54	1.68	V		0.057	17.55
		16-QAM	-34.45	29.11	-10.54	1.68	V		0.049	16.89
846.5		QPSK	-33.66	29.51	-10.50	1.69	V		0.054	17.32
		16-QAM	-34.42	28.75	-10.50	1.69	V		0.045	16.56

Effective Radiated Power Data (5 MHz Band 5 LTE)

Note: All of RB size has been tested for emissions and ERP, with the 1RB configuration observed as the worst case

Freq (MHz)	Bandwidth	Modulation	Measured Level (dBm)	Substitute Level (dBm)	Ant. Gain(dBd)	C.L	Pol	Limit		
								W	W	dBm
829.0	10 MHz	QPSK	-32.93	30.17	-10.57	1.67	V	< 7.00	0.062	17.93
		16-QAM	-33.81	29.29	-10.57	1.67	V		0.051	17.05
836.5		QPSK	-33.60	29.96	-10.54	1.68	V		0.059	17.74
		16-QAM	-34.26	29.30	-10.54	1.68	V		0.051	17.08
844.0		QPSK	-33.94	29.42	-10.51	1.69	V		0.053	17.22
		16-QAM	-34.87	28.49	-10.51	1.69	V		0.043	16.29

Effective Radiated Power Data (10 MHz Band 5 LTE)

Note: All of RB size has been tested for emissions and ERP, with the 1RB configuration observed as the worst case

NOTES:

Effective Radiated Power Output Measurements by Substitution Method

according to ANSI/TIA/EIA-603-D-2010 June 24, 2010:

The EUT was placed on a non-conductive styrofoam resin table 3-meters from the receive antenna. The receive antenna height and turntable rotation was adjusted for the highest reading on the receive spectrum analyzer. For LTE signals, RBW = 1-5% of the OBW, not to exceed 1MHz, VBW ≥ 3 x RBW, Detector = RMS.

A half-wave dipole was substituted in place of the EUT. This dipole antenna was driven by a signal generator and the level of the signal generator was adjusted to obtain the same receive spectrum analyzer reading. The conducted power at the terminals of the dipole is measured. The ERP is recorded.

Also, we have done x, y, z planes in EUT and horizontal and vertical polarization in detecting antenna. The worst case of the EUT is y plane in LTE mode. Also worst case of detecting Antenna is vertical polarization in LTE mode.

8.3 RADIATED SPURIOUS EMISSIONS

8.3.1 RADIATED SPURIOUS EMISSIONS (1.4 MHz Band 2 LTE)

- OPERATING FREQUENCY: 1850.70 MHz
- MEASURED OUTPUT POWER: 23.44 dBm = 0.221 W
- MODULATION SIGNAL: 1.4 MHz QPSK
- DISTANCE: 3 meters
- LIMIT: $43 + 10 \log_{10}(W) =$ 36.44 dBc

Ch	Freq (MHz)	Measured Level (dBm)	Ant. Gain (dBi)	Substitute Level (dBm)	C.L	Pol	EIRP (dBm)	dBc
18607 (1850.7)	3,701.40	-55.51	12.52	-53.71	3.74	V	-44.93	68.37
	5,552.10	-47.64	13.29	-39.93	4.82	V	-31.46	54.90
	7,402.80	-56.96	11.72	-40.10	5.69	H	-34.07	57.51
18900 (1880.0)	3,760.00	-56.62	12.56	-54.98	3.71	H	-46.13	69.57
	5,640.00	-48.43	13.30	-40.93	4.96	V	-32.59	56.03
	7,520.00	-56.60	11.70	-40.41	5.70	H	-34.41	57.85
19193 (1909.3)	3,818.60	-55.31	12.60	-52.74	3.89	V	-44.03	67.47
	5,727.90	-46.75	13.31	-38.64	5.12	V	-30.45	53.89
	7,637.20	-56.86	11.61	-40.32	5.60	H	-34.31	57.75

- NOTES:**
1. Radiated Spurious Emission Measurements at 3 meters by Substitution Method according to ANSI/TIA/EIA-603-D-2010 June 24, 2010:
 2. We are performed all frequency to 10th harmonics from 30 MHz. Measurements above show only up to 3 maximum emissions noted, or would be lesser if no specific emissions from the EUT are recorded (ie: margin > 20 dB from the applicable limit) and considered that's already beyond the background noise floor.
 3. We have done x, y, z planes in EUT and horizontal and vertical polarization in detecting antenna.
 4. All of RB size has been tested for emissions and EIRP, with the 1RB configuration observed as the worst case
 5. We are performed 16QAM and QPSK modulations. The worst case data are reported in the table above.

8.3.2 RADIATED SPURIOUS EMISSIONS (3 MHz Band 2 LTE)

- ▣ OPERATING FREQUENCY: 1880.00 MHz
- ▣ MEASURED OUTPUT POWER: 23.47 dBm = 0.222 W
- ▣ MODULATION SIGNAL: 3 MHz QPSK
- ▣ DISTANCE: 3 meters
- ▣ LIMIT: $43 + 10 \log_{10}(W) =$ 36.47dBc

Ch	Freq (MHz)	Measured Level (dBm)	Ant. Gain (dBi)	Substitute Level (dBm)	C.L	Pol	EIRP (dBm)	dBc
18615 (1851.5)	3,703.00	-55.82	12.52	-54.07	3.74	V	-45.29	68.76
	5,554.50	-46.38	13.29	-38.80	4.84	V	-30.35	53.82
	7,406.00	-56.50	11.72	-39.64	5.65	H	-33.57	57.04
18900 (1880.0)	3,760.00	-56.08	12.56	-54.44	3.71	H	-45.59	69.06
	5,640.00	-48.68	13.30	-41.18	4.96	V	-32.84	56.31
	7,520.00	-56.55	11.70	-40.36	5.70	H	-34.36	57.83
19185 (1908.5)	3,817.00	-56.49	12.60	-53.92	3.89	V	-45.21	68.68
	5,725.50	-46.19	13.31	-38.32	5.11	V	-30.12	53.59
	7,634.00	-55.92	11.62	-39.27	5.62	H	-33.27	56.74

- NOTES:**
1. Radiated Spurious Emission Measurements at 3 meters by Substitution Method according to ANSI/TIA/EIA-603-D-2010 June 24, 2010:
 2. We are performed all frequency to 10th harmonics from 30 MHz. Measurements above show only up to 3 maximum emissions noted, or would be lesser if no specific emissions from the EUT are recorded (ie: margin > 20 dB from the applicable limit) and considered that's already beyond the background noise floor.
 3. We have done x, y, z planes in EUT and horizontal and vertical polarization in detecting antenna.
 4. All of RB size has been tested for emissions and EIRP, with the 1RB configuration observed as the worst case
 5. We are performed 16QAM and QPSK modulations. The worst case data are reported in the table above.

8.3.3 RADIATED SPURIOUS EMISSIONS (5 MHz Band 2 LTE)

- ▣ OPERATING FREQUENCY: 1880.00 MHz
- ▣ MEASURED OUTPUT POWER: 23.52 dBm = 0.225 W
- ▣ MODULATION SIGNAL: 5 MHz QPSK
- ▣ DISTANCE: 3 meters
- ▣ LIMIT: $43 + 10 \log_{10}(W) =$ 36.52dBc

Ch	Freq (MHz)	Measured Level (dBm)	Ant. Gain (dBi)	Substitute Level (dBm)	C.L	Pol	EIRP (dBm)	dBc
18625 (1852.5)	3,705.00	-56.77	12.52	-55.02	3.74	H	-46.24	69.76
	5,557.50	-45.47	13.29	-38.02	4.86	V	-29.59	53.11
	7,410.00	-57.45	11.72	-40.59	5.61	V	-34.48	58.00
18900 (1880.0)	3,760.00	-55.98	12.56	-54.34	3.71	V	-45.49	69.01
	5,640.00	-48.52	13.30	-41.02	4.96	V	-32.68	56.20
	7,520.00	-56.65	11.70	-40.46	5.70	V	-34.46	57.98
19175 (1907.5)	3,815.00	-57.16	12.60	-54.89	3.82	V	-46.11	69.63
	5,722.50	-46.94	13.31	-39.32	5.10	V	-31.11	54.63
	7,630.00	-56.86	11.62	-40.09	5.64	V	-34.11	57.63

- NOTES:**
1. Radiated Spurious Emission Measurements at 3 meters by Substitution Method according to ANSI/TIA/EIA-603-D-2010 June 24, 2010:
 2. We are performed all frequency to 10th harmonics from 30 MHz. Measurements above show only up to 3 maximum emissions noted, or would be lesser if no specific emissions from the EUT are recorded (ie: margin > 20 dB from the applicable limit) and considered that's already beyond the background noise floor.
 3. We have done x, y, z planes in EUT and horizontal and vertical polarization in detecting antenna.
 4. All of RB size has been tested for emissions and EIRP, with the 1RB configuration observed as the worst case
 5. We are performed 16QAM and QPSK modulations. The worst case data are reported in the table above.

8.3.4 RADIATED SPURIOUS EMISSIONS (10 MHz Band 2 LTE)

- ▣ OPERATING FREQUENCY: 1880.00 MHz
- ▣ MEASURED OUTPUT POWER: 23.39 dBm = 0.218 W
- ▣ MODULATION SIGNAL: 10 MHz QPSK
- ▣ DISTANCE: 3 meters
- ▣ LIMIT: $43 + 10 \log_{10}(W) =$ 36.39dBc

Ch	Freq (MHz)	Measured Level (dBm)	Ant. Gain (dBi)	Substitute Level (dBm)	C.L	Pol	EIRP (dBm)	dBc
18650 (1855.0)	3,710.00	-55.85	12.52	-54.11	3.78	V	-45.37	68.76
	5,565.00	-47.77	13.29	-40.05	4.86	V	-31.62	55.01
	7,420.00	-55.13	11.72	-38.39	5.58	V	-32.25	55.64
18900 (1880.0)	3,760.00	-56.69	12.56	-55.05	3.71	H	-46.20	69.59
	5,640.00	-50.05	13.30	-42.55	4.96	V	-34.21	57.60
	7,520.00	-55.65	11.70	-39.46	5.70	H	-33.46	56.85
19150 (1905.0)	3,810.00	-57.28	12.60	-55.24	3.82	V	-46.46	69.85
	5,715.00	-47.83	13.31	-39.97	5.19	V	-31.85	55.24
	7,620.00	-56.87	11.62	-40.22	5.72	V	-34.32	57.71

- NOTES:**
1. Radiated Spurious Emission Measurements at 3 meters by Substitution Method according to ANSI/TIA/EIA-603-D-2010 June 24, 2010:
 2. We are performed all frequency to 10th harmonics from 30 MHz. Measurements above show only up to 3 maximum emissions noted, or would be lesser if no specific emissions from the EUT are recorded (ie: margin > 20 dB from the applicable limit) and considered that's already beyond the background noise floor.
 3. We have done x, y, z planes in EUT and horizontal and vertical polarization in detecting antenna.
 4. All of RB size has been tested for emissions and EIRP, with the 1RB configuration observed as the worst case
 5. We are performed 16QAM and QPSK modulations. The worst case data are reported in the table above.

8.3.5 RADIATED SPURIOUS EMISSIONS (15 MHz Band 2 LTE)

- ▣ OPERATING FREQUENCY: 1880.00 MHz
- ▣ MEASURED OUTPUT POWER: 23.53 dBm = 0.225 W
- ▣ MODULATION SIGNAL: 15 MHz QPSK
- ▣ DISTANCE: 3 meters
- ▣ LIMIT: $43 + 10 \log_{10}(W) =$ 36.53dBc

Ch	Freq (MHz)	Measured Level (dBm)	Ant. Gain (dBi)	Substitute Level (dBm)	C.L	Pol	EIRP (dBm)	dBc
18675 (1857.5)	3,715.00	-55.07	12.52	-53.39	3.72	V	-44.59	68.12
	5,572.50	-47.14	13.29	-39.15	4.86	V	-30.72	54.25
	7,430.00	-56.36	11.72	-39.86	5.58	V	-33.72	57.25
18900 (1880.0)	3,760.00	-56.95	12.56	-55.31	3.71	V	-46.46	69.99
	5,640.00	-49.84	13.30	-42.34	4.96	V	-34.00	57.53
	7,520.00	-56.12	11.70	-39.93	5.70	V	-33.93	57.46
19125 (1902.5)	3,805.00	-56.31	12.59	-54.22	3.80	V	-45.43	68.96
	5,707.50	-46.75	13.31	-38.74	5.19	H	-30.62	54.15
	7,610.00	-56.38	11.63	-39.79	5.67	H	-33.83	57.36

- NOTES:**
1. Radiated Spurious Emission Measurements at 3 meters by Substitution Method according to ANSI/TIA/EIA-603-D-2010 June 24, 2010:
 2. We are performed all frequency to 10th harmonics from 30 MHz. Measurements above show only up to 3 maximum emissions noted, or would be lesser if no specific emissions from the EUT are recorded (ie: margin > 20 dB from the applicable limit) and considered that's already beyond the background noise floor.
 3. We have done x, y, z planes in EUT and horizontal and vertical polarization in detecting antenna.
 4. All of RB size has been tested for emissions and EIRP, with the 1RB configuration observed as the worst case
 5. We are performed 16QAM and QPSK modulations. The worst case data are reported in the table above.

8.3.6 RADIATED SPURIOUS EMISSIONS (20 MHz Band 2 LTE)

- ▣ OPERATING FREQUENCY: 1860.00 MHz
- ▣ MEASURED OUTPUT POWER: 23.61 dBm = 0.230 W
- ▣ MODULATION SIGNAL: 20 MHz QPSK
- ▣ DISTANCE: 3 meters
- ▣ LIMIT: $43 + 10 \log_{10}(W) =$ 36.61dBc

Ch	Freq (MHz)	Measured Level (dBm)	Ant. Gain (dBi)	Substitute Level (dBm)	C.L	Pol	EIRP (dBm)	dBc
18700 (1860.0)	3,720.00	-55.93	12.53	-54.29	3.72	H	-45.48	69.09
	5,580.00	-46.93	13.29	-39.47	4.99	V	-31.17	54.78
	7,440.00	-56.37	11.72	-39.39	5.56	H	-33.23	56.84
18900 (1880.0)	3,760.00	-56.39	12.56	-54.75	3.71	V	-45.90	69.51
	5,640.00	-50.95	13.30	-43.45	4.96	V	-35.11	58.72
	7,520.00	-56.39	11.70	-40.20	5.70	V	-34.20	57.81
19100 (1900.0)	3,800.00	-56.56	12.59	-54.43	3.78	H	-45.62	69.23
	5,700.00	-46.35	13.31	-38.36	5.07	V	-30.12	53.73
	7,600.00	-55.78	11.64	-39.31	5.67	H	-33.34	56.95

- NOTES:**
1. Radiated Spurious Emission Measurements at 3 meters by Substitution Method according to ANSI/TIA/EIA-603-D-2010 June 24, 2010:
 2. We are performed all frequency to 10th harmonics from 30 MHz. Measurements above show only up to 3 maximum emissions noted, or would be lesser if no specific emissions from the EUT are recorded (ie: margin > 20 dB from the applicable limit) and considered that's already beyond the background noise floor.
 3. We have done x, y, z planes in EUT and horizontal and vertical polarization in detecting antenna.
 4. All of RB size has been tested for emissions and EIRP, with the 1RB configuration observed as the worst case
 5. We are performed 16QAM and QPSK modulations. The worst case data are reported in the table above.

8.3.7 RADIATED SPURIOUS EMISSIONS (1.4 MHz Band 5 LTE)

- ▣ OPERATING FREQUENCY: 836.50 MHz
- ▣ MEASURED OUTPUT POWER: 17.63 dBm = 0.058 W
- ▣ MODULATION SIGNAL: 1.4 MHz QPSK
- ▣ DISTANCE: 3 meters
- ▣ LIMIT: $43 + 10 \log_{10}(W) =$ 30.63dBc

Ch	Freq (MHz)	Measured Level (dBm)	Ant. Gain (dBd)	Substitute Level (dBm)	C.L	Pol	ERP (dBm)	dBc
20407 (824.7)	1,649.40	-59.09	9.16	-61.19	2.40	H	-54.43	72.06
	2,474.10	-46.44	10.92	-45.46	2.99	H	-37.53	55.16
	3,298.80	-57.58	11.94	-57.01	3.45	H	-48.52	66.15
20525 (836.5)	1,673.00	-59.56	9.23	-61.58	2.42	H	-54.77	72.40
	2,509.50	-47.97	10.96	-46.93	2.89	H	-38.86	56.49
	3,346.00	-57.62	10.03	-55.49	3.47	H	-48.93	66.56
20643 (848.3)	1,696.60	-59.55	9.32	-61.67	2.43	H	-54.78	72.41
	2,544.90	-50.54	10.98	-49.62	2.96	H	-41.60	59.23
	3,393.20	-58.93	12.14	-58.96	3.58	H	-50.40	68.03

- NOTES:**
1. Radiated Spurious Emission Measurements at 3 meters by Substitution Method according to ANSI/TIA/EIA-603-D-2010 June 24, 2010:
 2. We are performed all frequency to 10th harmonics from 30 MHz. Measurements above show only up to 3 maximum emissions noted, or would be lesser if no specific emissions from the EUT are recorded (ie: margin > 20 dB from the applicable limit) and considered that's already beyond the background noise floor.
 3. We have done x, y, z planes in EUT and horizontal and vertical polarization in detecting antenna.
 4. All of RB size has been tested for emissions and ERP, with the 1RB configuration observed as the worst case
 5. We are performed 16QAM and QPSK modulations. The worst case data are reported in the table above.

8.3.8 RADIATED SPURIOUS EMISSIONS (3 MHz Band 5 LTE)

- ▣ OPERATING FREQUENCY: 836.50 MHz
- ▣ MEASURED OUTPUT POWER: 17.65 dBm = 0.058 W
- ▣ MODULATION SIGNAL: 3 MHz QPSK
- ▣ DISTANCE: 3 meters
- ▣ LIMIT: $43 + 10 \log_{10}(W) =$ 30.65dBc

Ch	Freq (MHz)	Measured Level (dBm)	Ant. Gain (dBd)	Substitute Level (dBm)	C.L	Pol	ERP (dBm)	dBc
20415 (825.5)	1,651.00	-59.15	9.16	-61.25	2.40	H	-54.49	72.14
	2,476.50	-45.41	10.92	-44.43	2.99	H	-36.50	54.15
	3,302.00	-57.25	11.94	-56.68	3.45	H	-48.19	65.84
20525 (836.5)	1,673.00	-59.40	9.23	-61.42	2.42	H	-54.61	72.26
	2,509.50	-46.46	10.96	-45.42	2.89	H	-37.35	55.00
	3,346.00	-56.45	10.03	-54.32	3.47	H	-47.76	65.41
20635 (847.5)	1,695.00	-58.73	9.32	-60.85	2.43	H	-53.96	71.61
	2,542.50	-47.68	10.98	-46.46	2.96	H	-38.44	56.09
	3,390.00	-58.20	12.13	-58.16	3.60	H	-49.63	67.28

- NOTES:**
1. Radiated Spurious Emission Measurements at 3 meters by Substitution Method according to ANSI/TIA/EIA-603-D-2010 June 24, 2010:
 2. We are performed all frequency to 10th harmonics from 30 MHz. Measurements above show only up to 3 maximum emissions noted, or would be lesser if no specific emissions from the EUT are recorded (ie: margin > 20 dB from the applicable limit) and considered that's already beyond the background noise floor.
 3. We have done x, y, z planes in EUT and horizontal and vertical polarization in detecting antenna.
 4. All of RB size has been tested for emissions and ERP, with the 1RB configuration observed as the worst case
 5. We are performed 16QAM and QPSK modulations. The worst case data are reported in the table above.

8.3.9 RADIATED SPURIOUS EMISSIONS (5 MHz Band 5 LTE)

- ▣ OPERATING FREQUENCY: 826.50 MHz
- ▣ MEASURED OUTPUT POWER: 17.64 dBm = 0.058 W
- ▣ MODULATION SIGNAL: 5 MHz QPSK
- ▣ DISTANCE: 3 meters
- ▣ LIMIT: $43 + 10 \log_{10}(W) =$ 30.64dBc

Ch	Freq (MHz)	Measured Level (dBm)	Ant. Gain (dBd)	Substitute Level (dBm)	C.L	Pol	ERP (dBm)	dBc
20425 (826.5)	1,653.00	-58.36	9.18	-60.55	2.40	H	-53.77	71.41
	2,479.50	-45.16	10.93	-44.43	2.98	H	-36.48	54.12
	3,306.00	-57.94	11.95	-57.51	3.45	H	-49.01	66.65
20525 (836.5)	1,673.00	-58.81	9.23	-60.83	2.42	H	-54.02	71.66
	2,509.50	-45.66	10.96	-44.62	2.89	H	-36.55	54.19
	3,346.00	-58.80	10.03	-56.67	3.47	H	-50.11	67.75
20625 (846.5)	1,693.00	-58.42	9.32	-60.54	2.43	H	-53.65	71.29
	2,539.50	-45.46	10.98	-44.24	2.96	H	-36.22	53.86
	3,386.00	-57.43	12.12	-57.46	3.54	H	-48.87	66.51

- NOTES:**
1. Radiated Spurious Emission Measurements at 3 meters by Substitution Method according to ANSI/TIA/EIA-603-D-2010 June 24, 2010:
 2. We are performed all frequency to 10th harmonics from 30 MHz. Measurements above show only up to 3 maximum emissions noted, or would be lesser if no specific emissions from the EUT are recorded (ie: margin > 20 dB from the applicable limit) and considered that's already beyond the background noise floor.
 3. We have done x, y, z planes in EUT and horizontal and vertical polarization in detecting antenna.
 4. All of RB size has been tested for emissions and ERP, with the 1RB configuration observed as the worst case
 5. We are performed 16QAM and QPSK modulations. The worst case data are reported in the table above.

8.3.10 RADIATED SPURIOUS EMISSIONS (10 MHz Band 5 LTE)

- ▣ OPERATING FREQUENCY: 829.00 MHz
- ▣ MEASURED OUTPUT POWER: 17.93 dBm = 0.062 W
- ▣ MODULATION SIGNAL: 10 MHz QPSK
- ▣ DISTANCE: 3 meters
- ▣ LIMIT: $43 + 10 \log_{10}(W) =$ 30.93dBc

Ch	Freq (MHz)	Measured Level (dBm)	Ant. Gain (dBd)	Substitute Level (dBm)	C.L	Pol	ERP (dBm)	dBc
20450 (829.0)	1,658.00	-58.75	9.20	-61.03	2.40	H	-54.23	72.16
	2,487.00	-44.99	10.94	-43.74	2.98	H	-35.78	53.71
	3,316.00	-57.36	11.97	-57.07	3.54	H	-48.64	66.57
20525 (836.5)	1,673.00	-58.64	9.23	-60.66	2.42	H	-53.85	71.78
	2,509.50	-39.77	10.96	-38.73	2.89	V	-30.66	48.59
	3,346.00	-57.22	10.03	-55.09	3.47	V	-48.53	66.46
20600 (844.0)	1,688.00	-58.40	9.30	-60.47	2.42	H	-53.59	71.52
	2,532.00	-46.39	10.98	-45.65	2.90	H	-37.57	55.50
	3,376.00	-57.86	12.10	-57.91	3.46	H	-49.27	67.20

- NOTES:**
1. Radiated Spurious Emission Measurements at 3 meters by Substitution Method according to ANSI/TIA/EIA-603-D-2010 June 24, 2010:
 2. We are performed all frequency to 10th harmonics from 30 MHz. Measurements above show only up to 3 maximum emissions noted, or would be lesser if no specific emissions from the EUT are recorded (ie: margin > 20 dB from the applicable limit) and considered that's already beyond the background noise floor.
 3. We have done x, y, z planes in EUT and horizontal and vertical polarization in detecting antenna.
 4. All of RB size has been tested for emissions and ERP, with the 1RB configuration observed as the worst case
 5. We are performed 16QAM and QPSK modulations. The worst case data are reported in the table above.

8.4PEAK-TO-AVERAGE RATIO

Band	Band Width	Frequency (MHz)	Modulation	Resource Block Size	Resource Block Offset	Data (dB)
2	1.4 MHz	1880.0	QPSK	6	0	5.06
			16-QAM	6	0	5.84
	3 MHz		QPSK	15	0	5.40
			16-QAM	15	0	6.15
	5 MHz		QPSK	25	0	5.36
			16-QAM	25	0	6.05
	10 MHz		QPSK	50	0	5.37
			16-QAM	50	0	6.00
	15 MHz		QPSK	75	0	5.37
			16-QAM	75	0	6.04
	20 MHz		QPSK	100	0	5.34
			16-QAM	100	0	6.06

- Plots of the EUT's Peak- to- Average Ratio are shown Page 61 ~ 66.

8.5OCCUPIED BANDWIDTH

Band	Band Width	Frequency (MHz)	Modulation	Resource Block Size	Resource Block Offset	Data (MHz)
2	1.4 MHz	1880.0	QPSK	6	0	1.0925
			16-QAM	6	0	1.0938
	3 MHz		QPSK	15	0	2.6941
			16-QAM	15	0	2.6928
	5 MHz		QPSK	25	0	4.5162
			16-QAM	25	0	4.5084
	10 MHz		QPSK	50	0	8.9747
			16-QAM	50	0	8.9466
	15 MHz		QPSK	75	0	13.495
			16-QAM	75	0	13.469
	20 MHz		QPSK	100	0	17.972
			16-QAM	100	0	17.977

Band	Band Width	Frequency (MHz)	Modulation	Resource Block Size	Resource Block Offset	Data (MHz)
5	1.4 MHz	836.5	QPSK	6	0	1.0963
			16-QAM	6	0	1.0944
	3 MHz		QPSK	15	0	2.7031
			16-QAM	15	0	2.6937
	5 MHz		QPSK	25	0	4.5151
			16-QAM	25	0	4.5122
	10 MHz		QPSK	50	0	8.9756
			16-QAM	50	0	8.9667

- Plots of the EUT's Occupied Bandwidth are shown Page 51 ~ 60.

8.6 CONDUCTED SPURIOUS EMISSIONS

■ FACTORS FOR FREQUENCY

Frequency Range (GHz)	Factor [dB]
0.03 – 1	27.145
1 – 5	26.960
5 – 10	27.542
10 – 15	28.439
15 – 20	29.144
Above 20	30.148

NOTES:

Factor(dB) = Cable Loss + Attenuator +Power Splitter

Band	Band Width (MHz)	Frequency (MHz)	Frequency of Maximum Harmonic (GHz)	Factor (dB)	Measurement Maximum Data (dBm)	Result (dBm)	Limit (dBm)
2	1.4	1850.7	18.5495	29.144	-55.78	-26.64	-13.00
		1880.0	19.1980	29.144	-55.92	-26.78	
		1909.3	18.5810	29.144	-56.38	-27.24	
	3	1851.5	19.6130	29.144	-55.99	-26.85	
		1880.0	18.8120	29.144	-56.55	-27.41	
		1908.5	18.6995	29.144	-56.11	-26.97	
	5	1852.5	19.3135	29.144	-55.65	-26.51	
		1880.0	19.0290	29.144	-55.53	-26.39	
		1907.5	18.9380	29.144	-55.74	-26.60	
	10	1855.0	18.9530	29.144	-54.73	-25.59	
		1880.0	18.8790	29.144	-54.52	-25.38	
		1905.0	18.9460	29.144	-55.44	-26.30	
	15	1857.5	17.6145	29.144	-55.91	-26.77	
		1880.0	16.2885	29.144	-55.18	-26.04	
		1902.5	18.6525	29.144	-56.00	-26.86	
	20	1860.0	18.9100	29.144	-56.14	-27.00	
		1880.0	17.0965	29.144	-56.34	-27.20	
		1900.0	19.3200	29.144	-55.67	-26.53	

Band	Band Width (MHz)	Frequency (MHz)	Frequency of Maximum Harmonic (GHz)	Factor (dB)	Measurement Maximum Data (dBm)	Result (dBm)	Limit (dBm)
5	1.4	824.7	5.92825	27.542	-58.90	-31.36	-13.00
		836.5	6.95475	27.542	-59.06	-31.52	
		848.3	2.44517	26.95	-58.56	-31.61	
	3	825.5	4.86134	26.95	-59.31	-32.36	
		836.5	3.66083	26.95	-58.56	-31.61	
		847.5	2.67305	26.95	-58.70	-31.75	
	5	826.5	3.70705	26.95	-58.76	-31.81	
		836.5	2.53413	26.95	-58.62	-31.67	
		846.5	3.17427	26.95	-58.54	-31.59	
	10	829.0	3.33803	26.95	-59.15	-32.20	
		836.5	3.71923	26.95	-58.95	-32.00	
		844.0	3.71426	26.95	-59.02	-32.07	

NOTES:

1. Conducted Spurious Emissions was Tested QPSK Modulation, Resource Block Size 1 and Resource Block Offset 0
2. Result (dBm) = Measurement Maximum Data (dBm) + Factor (dB)

- Plots of the EUT's Conducted Spurious Emissions are shown Page 97 ~ 126.

8.6.1 BAND EDGE

- Plots of the EUT's Band Edge are shown Page 67 ~ 96.

8.7 FREQUENCY STABILITY / VARIATION OF AMBIENT TEMPERATURE

8.7.1 FREQUENCY STABILITY (1.4 MHz Band 2 LTE)

- ▣ OPERATING FREQUENCY: 1880,000,000 Hz
- ▣ CHANNEL: 18900 (1.4 MHz)
- ▣ REFERENCE VOLTAGE: 3.85 VDC
- ▣ DEVIATION LIMIT: Emission must remain in band

Voltage (%)	Power (VDC)	Temp. (°C)	Frequency (Hz)	Frequency Error (Hz)	Deviation (%)	ppm
100%	3.85	+20(Ref)	1879 999 987	0.0	0.000 000	0.000
100%		-30	1879 999 980	-7.1	0.000 000	-0.004
100%		-20	1879 999 977	-10.4	-0.000 001	-0.006
100%		-10	1879 999 982	-5.5	0.000 000	-0.003
100%		0	1879 999 993	5.4	0.000 000	0.003
100%		+10	1879 999 976	-11.3	-0.000 001	-0.006
100%		+30	1879 999 983	-4.2	0.000 000	-0.002
100%		+40	1879 999 983	-4.6	0.000 000	-0.002
100%		+50	1879 999 980	-6.9	0.000 000	-0.004
Batt. Endpoint	3.60	+20	1879 999 980	-7.1	0.000 000	-0.004

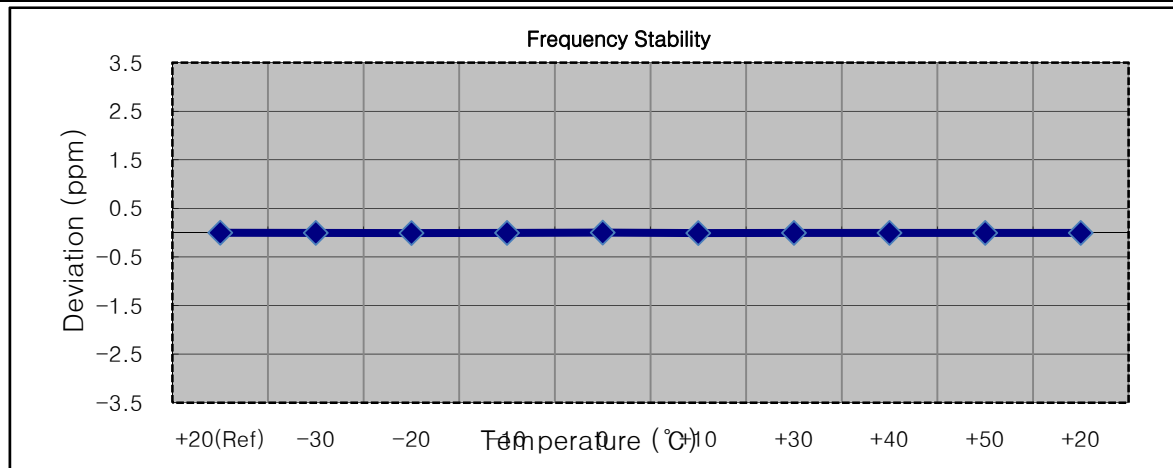

8.7.4 FREQUENCY STABILITY (10 MHz Band 2 LTE)

- ▣ OPERATING FREQUENCY: 1880,000,000 Hz
- ▣ CHANNEL: 18900 (10 MHz)
- ▣ REFERENCE VOLTAGE: 3.85 VDC
- ▣ DEVIATION LIMIT: Emission must remain in band

Voltage (%)	Power (VDC)	Temp. (°C)	Frequency (Hz)	Frequency Error (Hz)	Deviation (%)	ppm
100%	3.85	+20(Ref)	1879 999 994	0.0	0.000 000	0.000
100%		-30	1879 999 990	-4.3	0.000 000	-0.002
100%		-20	1879 999 988	-6.1	0.000 000	-0.003
100%		-10	1879 999 987	-7.1	0.000 000	-0.004
100%		0	1879 999 986	-7.8	0.000 000	-0.004
100%		+10	1879 999 987	-6.9	0.000 000	-0.004
100%		+30	1879 999 985	-8.6	0.000 000	-0.005
100%		+40	1879 999 991	-2.8	0.000 000	-0.001
100%		+50	1879 999 985	-8.9	0.000 000	-0.005
Batt. Endpoint	3.60	+20	1879 999 991	-2.9	0.000 000	-0.002

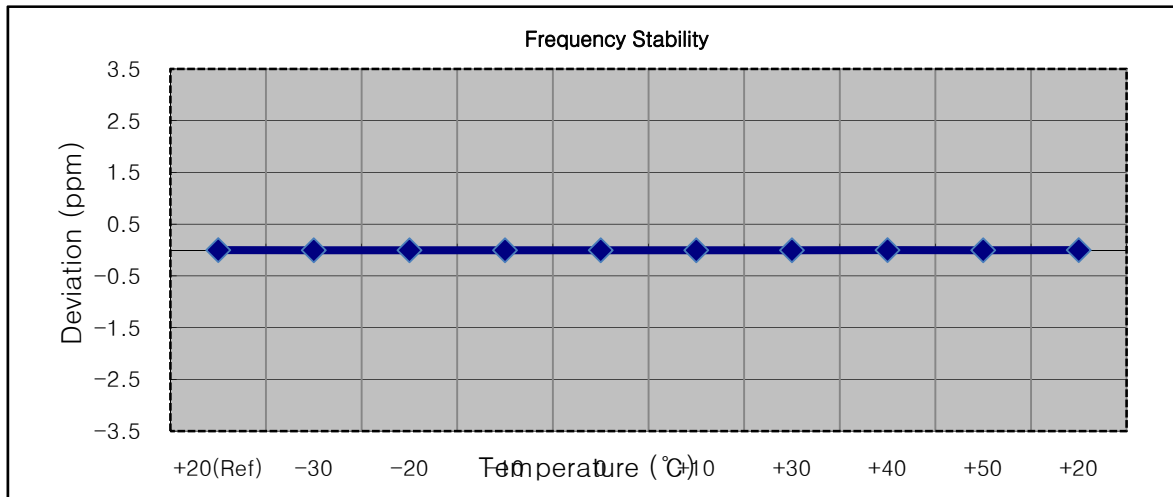

8.7.5 FREQUENCY STABILITY (15 MHz Band 2 LTE)

- ▣ OPERATING FREQUENCY: 1880,000,000 Hz
- ▣ CHANNEL: 18900 (15 MHz)
- ▣ REFERENCE VOLTAGE: 3.85 VDC
- ▣ DEVIATION LIMIT: Emission must remain in band

Voltage (%)	Power (VDC)	Temp. (°C)	Frequency (Hz)	Frequency Error (Hz)	Deviation (%)	ppm
100%	3.85	+20(Ref)	1879 999 991	0.0	0.000 000	0.000
100%		-30	1879 999 983	-7.8	0.000 000	-0.004
100%		-20	1879 999 979	-12.0	-0.000 001	-0.006
100%		-10	1879 999 985	-6.4	0.000 000	-0.003
100%		0	1879 999 983	-7.8	0.000 000	-0.004
100%		+10	1879 999 984	-7.5	0.000 000	-0.004
100%		+30	1879 999 981	-10.1	-0.000 001	-0.005
100%		+40	1879 999 985	-6.0	0.000 000	-0.003
100%		+50	1879 999 981	-10.1	-0.000 001	-0.005
Batt. Endpoint	3.60	+20	1879 999 983	-7.6	0.000 000	-0.004

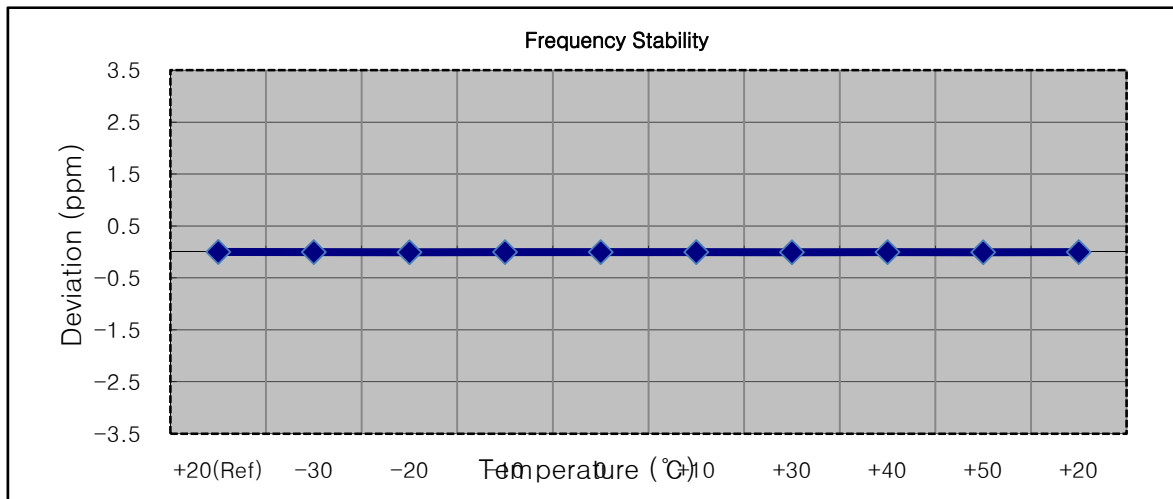

8.7.6 FREQUENCY STABILITY (20 MHz Band 2 LTE)

- ▣ OPERATING FREQUENCY: 1880,000,000 Hz
- ▣ CHANNEL: 18900 (20 MHz)
- ▣ REFERENCE VOLTAGE: 3.85 VDC
- ▣ DEVIATION LIMIT: Emission must remain in band

Voltage (%)	Power (VDC)	Temp. (°C)	Frequency (Hz)	Frequency Error (Hz)	Deviation (%)	ppm
100%	3.85	+20(Ref)	1879 999 990	0.0	0.000 000	0.000
100%		-30	1879 999 983	-6.4	0.000 000	-0.003
100%		-20	1879 999 984	-6.1	0.000 000	-0.003
100%		-10	1879 999 979	-10.6	-0.000 001	-0.006
100%		0	1879 999 981	-8.7	0.000 000	-0.005
100%		+10	1879 999 980	-9.4	-0.000 001	-0.005
100%		+30	1879 999 985	-4.6	0.000 000	-0.002
100%		+40	1879 999 977	-12.7	-0.000 001	-0.007
100%		+50	1879 999 982	-8.1	0.000 000	-0.004
Batt. Endpoint	3.60	+20	1879 999 985	-5.1	0.000 000	-0.003

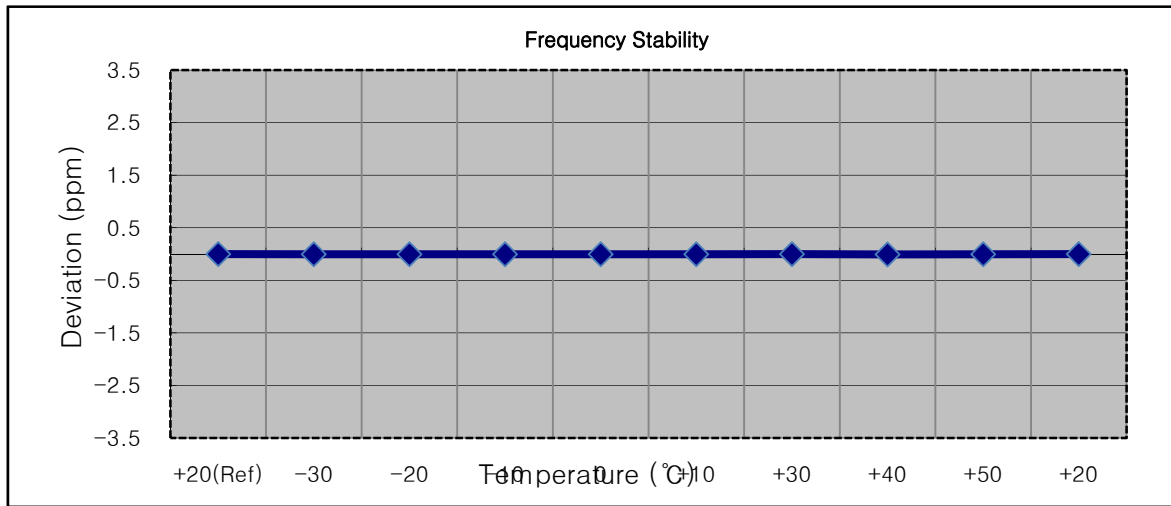

8.7.7 FREQUENCY STABILITY (1.4 MHz Band 5 LTE)

- ▣ OPERATING FREQUENCY: 836,500,000 Hz
- ▣ CHANNEL: 20525 (1.4 MHz)
- ▣ REFERENCE VOLTAGE: 3.85 VDC
- ▣ DEVIATION LIMIT: ± 0.000 25 % or 2.5 ppm

Voltage (%)	Power (VDC)	Temp. (°C)	Frequency (Hz)	Frequency Error (Hz)	Deviation (%)	ppm
100%	3.85	+20(Ref)	836 499 993	0.0	0.000 000	0.000
100%		-30	836 499 991	-2.1	0.000 000	-0.003
100%		-20	836 499 990	-3.1	0.000 000	-0.004
100%		-10	836 499 990	-3.2	0.000 000	-0.004
100%		0	836 499 998	5.0	0.000 001	0.006
100%		+10	836 499 991	-2.4	0.000 000	-0.003
100%		+30	836 499 991	-2.4	0.000 000	-0.003
100%		+40	836 499 997	3.7	0.000 000	0.004
100%		+50	836 499 997	4.0	0.000 000	0.005
Batt. Endpoint	3.60	+20	836 499 989	-4.1	0.000 000	-0.005

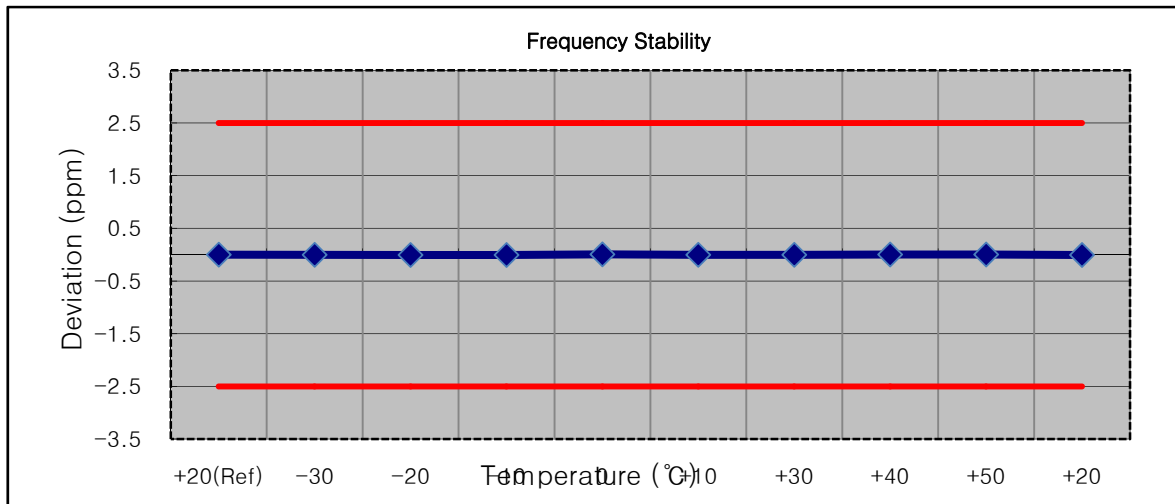

8.7.8 FREQUENCY STABILITY (3 MHz Band 5 LTE)

- ▣ OPERATING FREQUENCY: 836,500,000 Hz
- ▣ CHANNEL: 20525 (3 MHz)
- ▣ REFERENCE VOLTAGE: 3.85 VDC
- ▣ DEVIATION LIMIT: ± 0.000 25 % or 2.5 ppm

Voltage (%)	Power (VDC)	Temp. (°C)	Frequency (Hz)	Frequency Error (Hz)	Deviation (%)	ppm
100%	3.85	+20(Ref)	836 499 996	0.0	0.000 000	0.000
100%		-30	836 499 993	-3.1	0.000 000	-0.004
100%		-20	836 500 000	3.8	0.000 000	0.005
100%		-10	836 499 993	-2.8	0.000 000	-0.003
100%		0	836 499 993	-3.2	0.000 000	-0.004
100%		+10	836 499 993	-3.1	0.000 000	-0.004
100%		+30	836 499 992	-4.2	-0.000 001	-0.005
100%		+40	836 499 993	-3.2	0.000 000	-0.004
100%		+50	836 499 994	-2.6	0.000 000	-0.003
Batt. Endpoint	3.60	+20	836 499 999	2.8	0.000 000	0.003

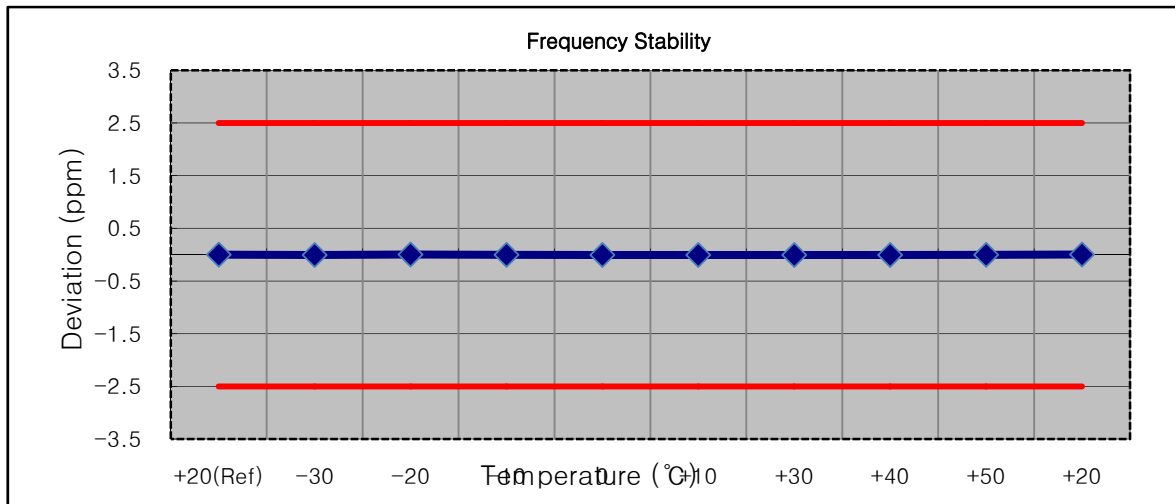

8.7.9 FREQUENCY STABILITY (5 MHz Band 5 LTE)

- ▣ OPERATING FREQUENCY: 836,500,000 Hz
- ▣ CHANNEL: 20525 (5 MHz)
- ▣ REFERENCE VOLTAGE: 3.85 VDC
- ▣ DEVIATION LIMIT: ± 0.000 25 % or 2.5 ppm

Voltage (%)	Power (VDC)	Temp. (°C)	Frequency (Hz)	Frequency Error (Hz)	Deviation (%)	ppm
100%	3.85	+20(Ref)	836 499 996	0.0	0.000 000	0.000
100%		-30	836 499 998	1.8	0.000 000	0.002
100%		-20	836 500 001	4.7	0.000 001	0.006
100%		-10	836 500 000	3.3	0.000 000	0.004
100%		0	836 500 000	3.9	0.000 000	0.005
100%		+10	836 500 000	3.4	0.000 000	0.004
100%		+30	836 499 993	-3	0.000 000	-0.004
100%		+40	836 500 000	3.4	0.000 000	0.004
100%		+50	836 500 001	4.3	0.000 001	0.005
Batt. Endpoint		3.60	+20	836 499 993	-3.4	0.000 000

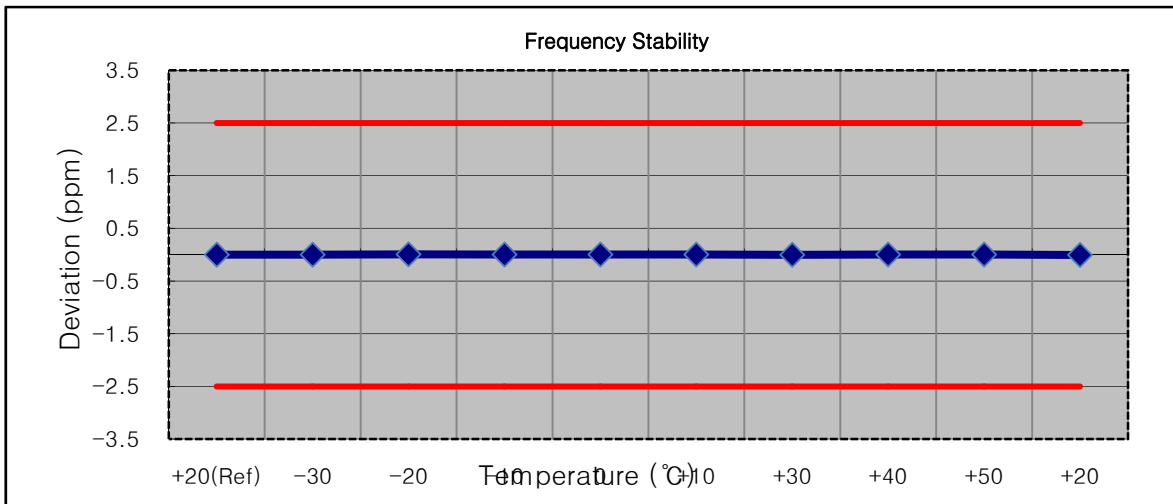

8.7.10 FREQUENCY STABILITY (10 MHz Band 5 LTE)

- ▣ OPERATING FREQUENCY: 836,500,000 Hz
- ▣ CHANNEL: 20525 (10 MHz)
- ▣ REFERENCE VOLTAGE: 3.85 VDC
- ▣ DEVIATION LIMIT: ± 0.000 25 % or 2.5 ppm

Voltage (%)	Power (VDC)	Temp. (°C)	Frequency (Hz)	Frequency Error (Hz)	Deviation (%)	ppm
100%	3.85	+20(Ref)	836 500 003	0.0	0.000 000	0.000
100%		-30	836 500 006	3.2	0.000 000	0.004
100%		-20	836 499 999	-3.2	0.000 000	-0.004
100%		-10	836 499 999	-3.7	0.000 000	-0.004
100%		0	836 500 005	2.7	0.000 000	0.003
100%		+10	836 499 999	-3.9	0.000 000	-0.005
100%		+30	836 500 000	-2.4	0.000 000	-0.003
100%		+40	836 500 007	4.0	0.000 000	0.005
100%		+50	836 500 000	-2.8	0.000 000	-0.003
Batt. Endpoint		3.60	+20	836 499 997	-5.3	-0.000 001

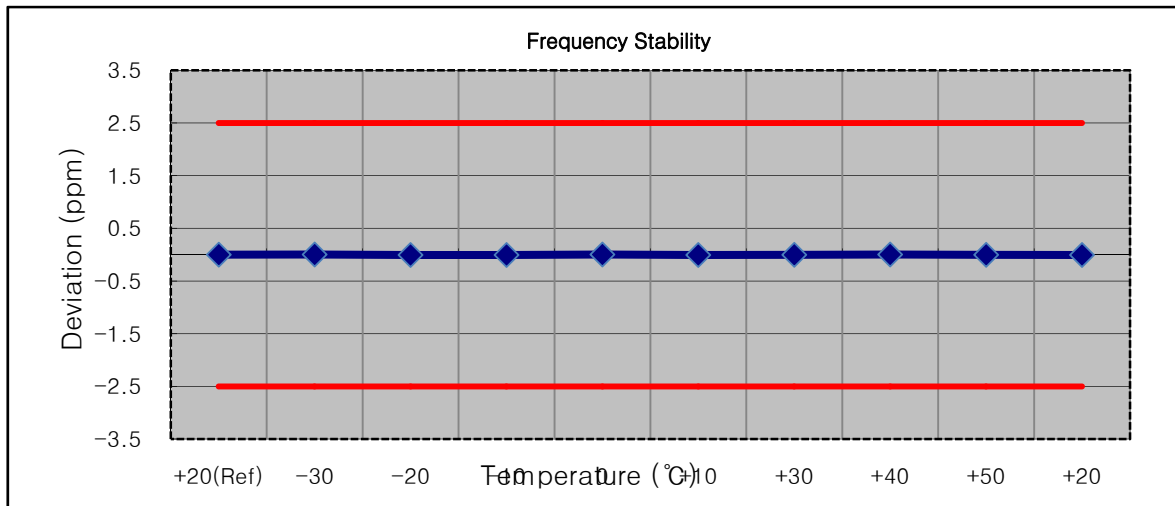

9. TEST PLOTS

BAND 2. Occupied Bandwidth Plot (1.4M BW Ch.18900 QPSK RB 6_0)

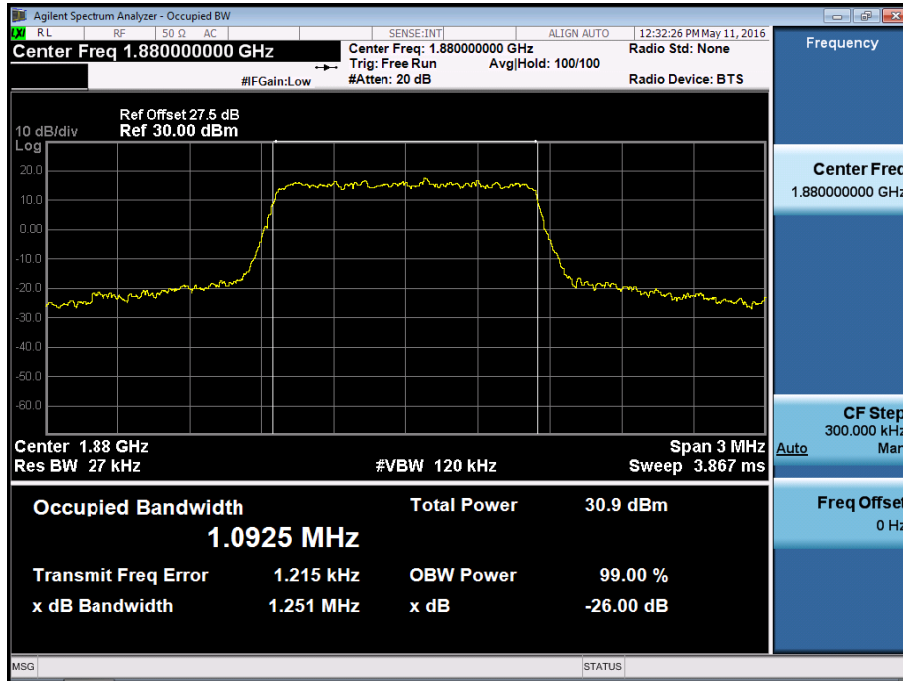

BAND 2. Occupied Bandwidth Plot (1.4M BW Ch.18900 16QAM RB 6_0)

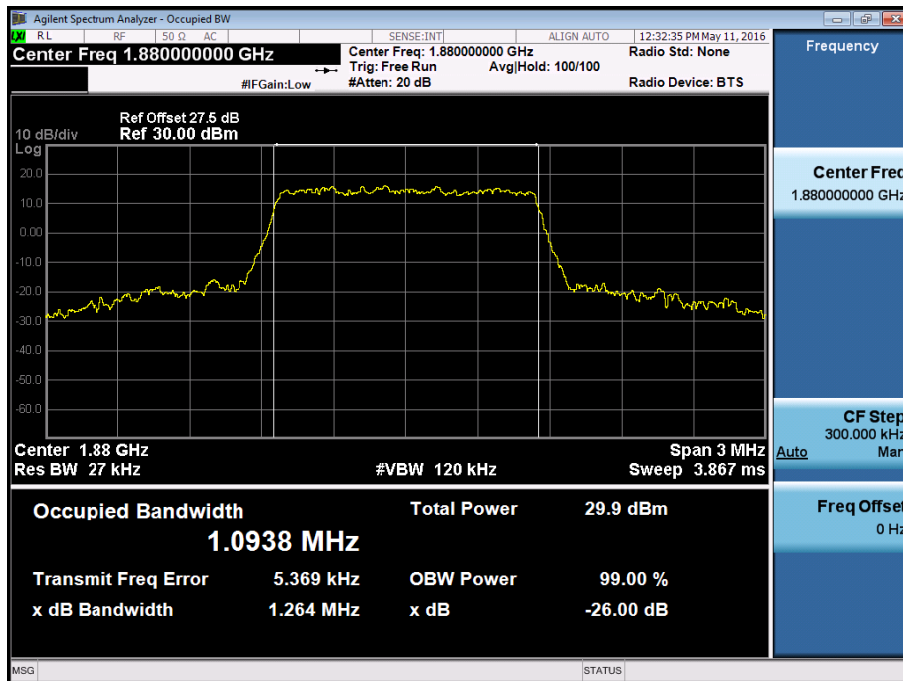

BAND 2. Occupied Bandwidth Plot (3M BW Ch.18900 QPSK RB 15_0)

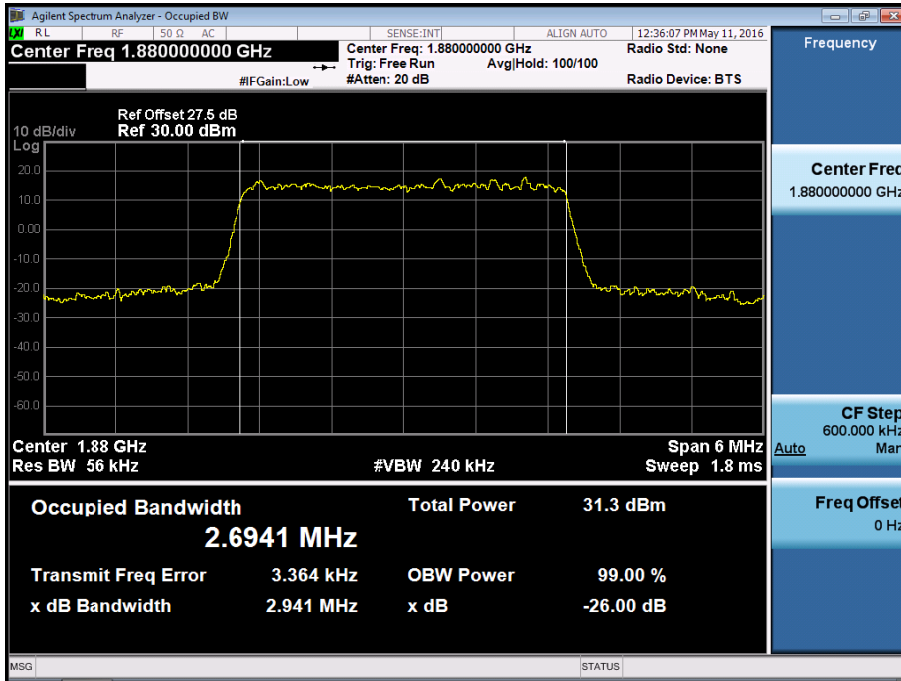

BAND 2. Occupied Bandwidth Plot (3M BW Ch.18900 16QAM RB 15_0)

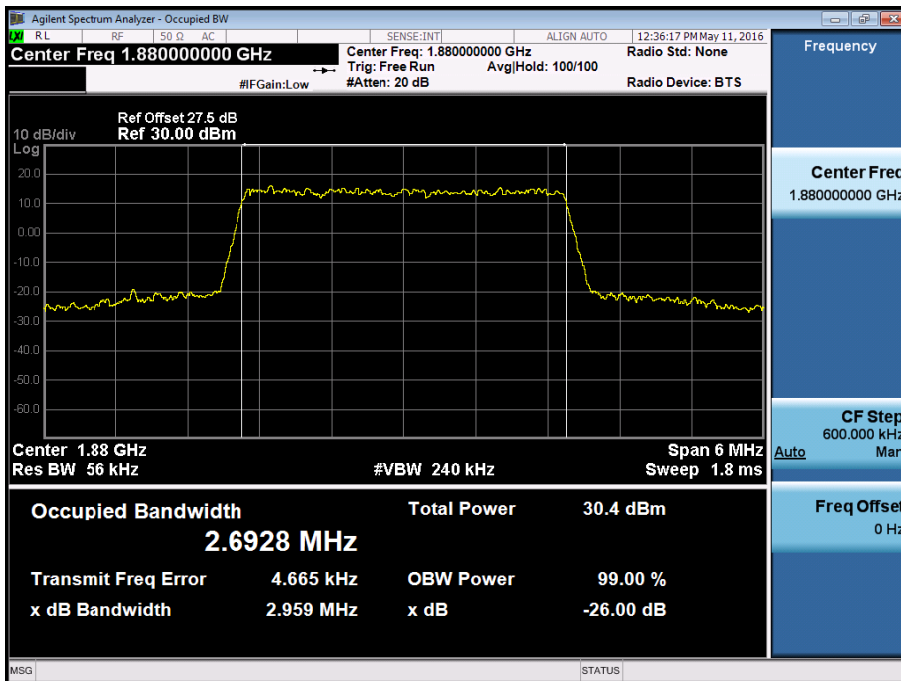

BAND 2. Occupied Bandwidth Plot (5M BW Ch.18900 QPSK RB 25_0)

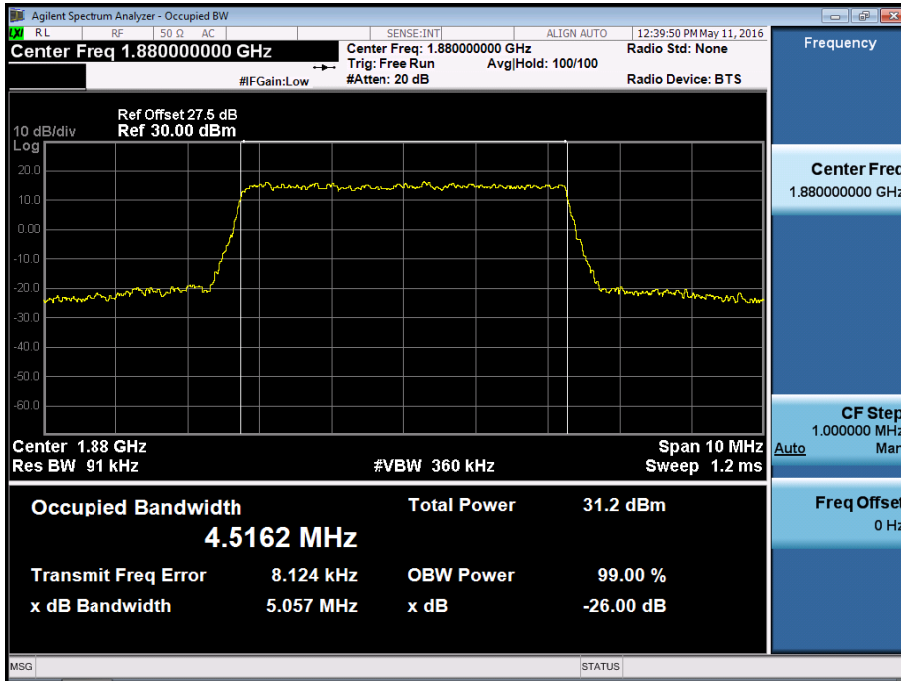

BAND 2. Occupied Bandwidth Plot (5M BW Ch.18900 16QAM RB 25_0)

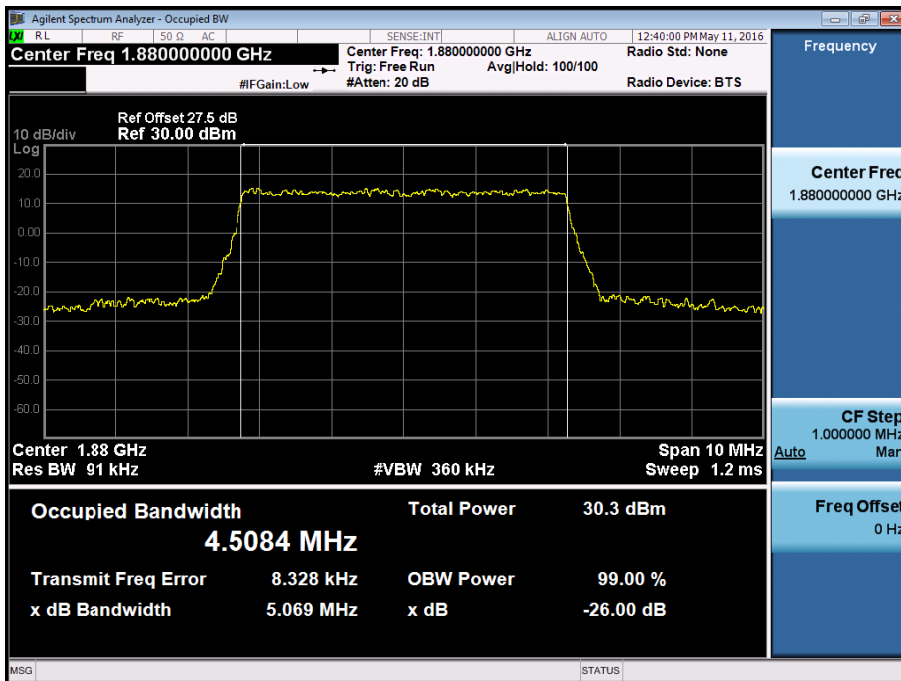

BAND 2. Occupied Bandwidth Plot (10M BW Ch.18900 QPSK RB 50_0)

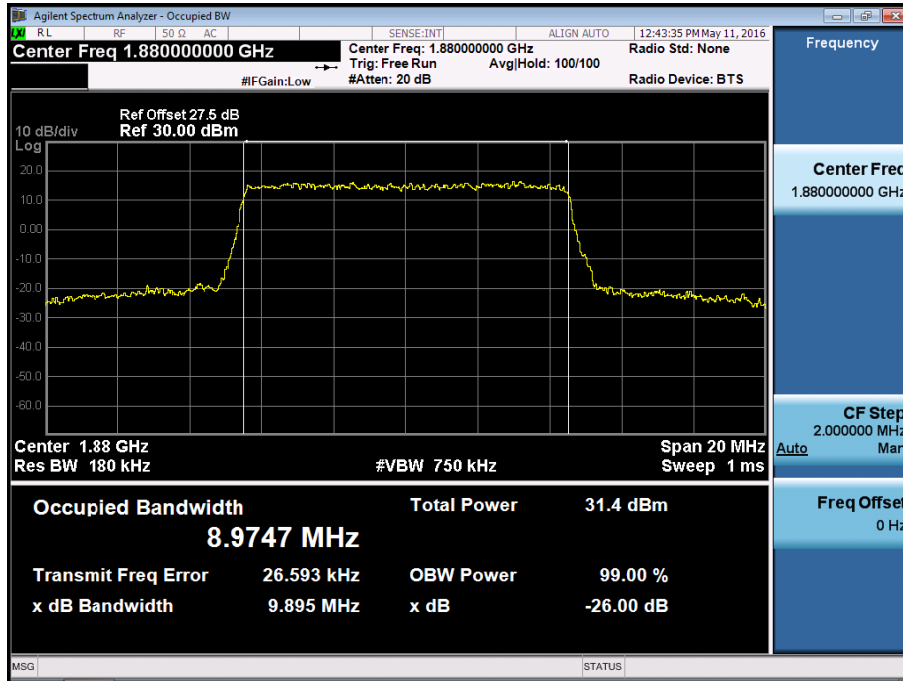

BAND 2. Occupied Bandwidth Plot (10M BW Ch.18900 16QAM RB 50_0)

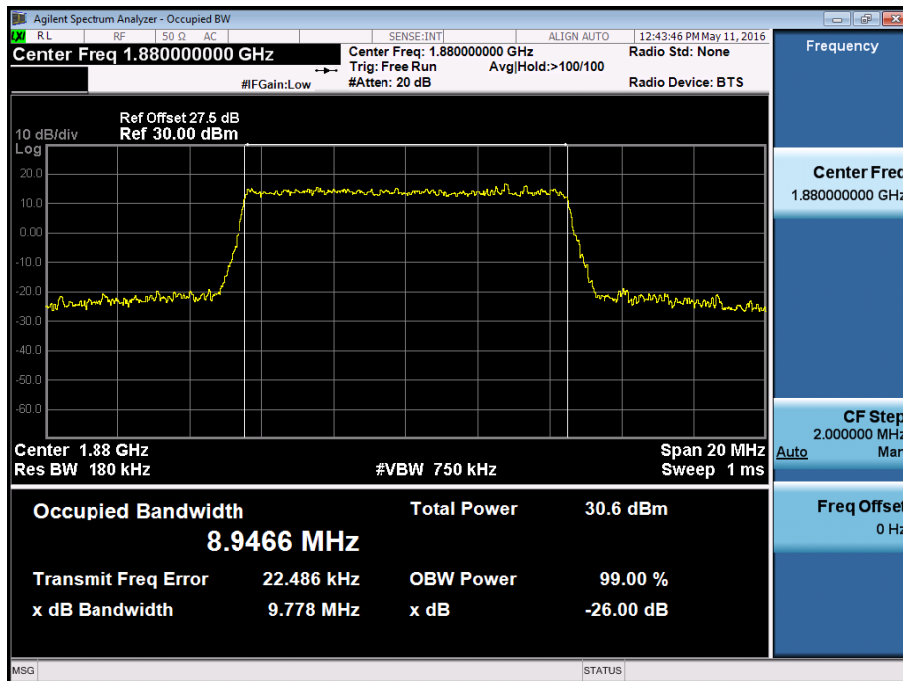

BAND 2. Occupied Bandwidth Plot (15M BW Ch.18900 QPSK RB 75_0)

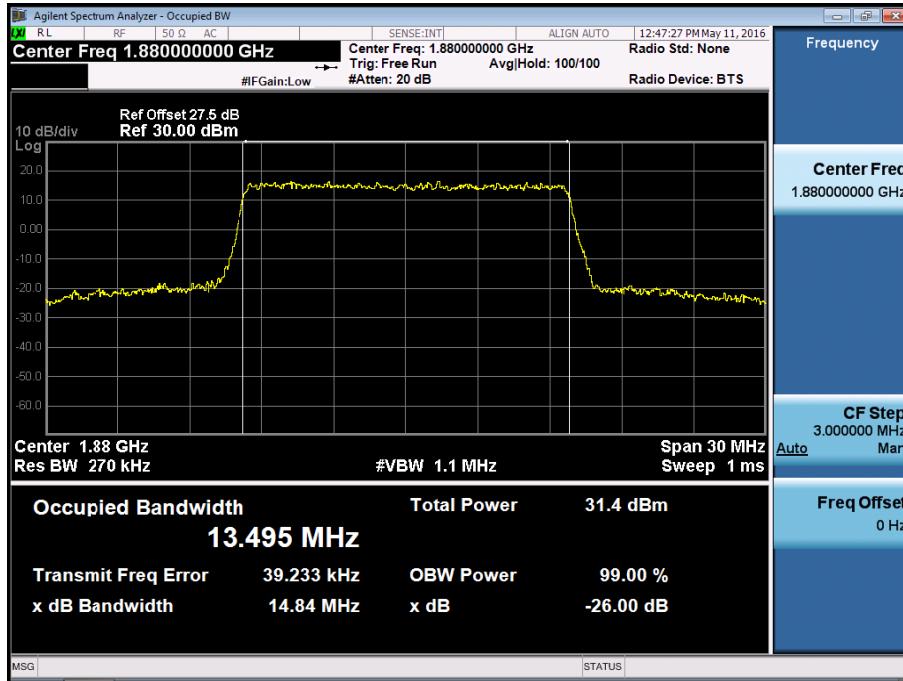

BAND 2. Occupied Bandwidth Plot (15M BW Ch.18900 16QAM RB 75_0)

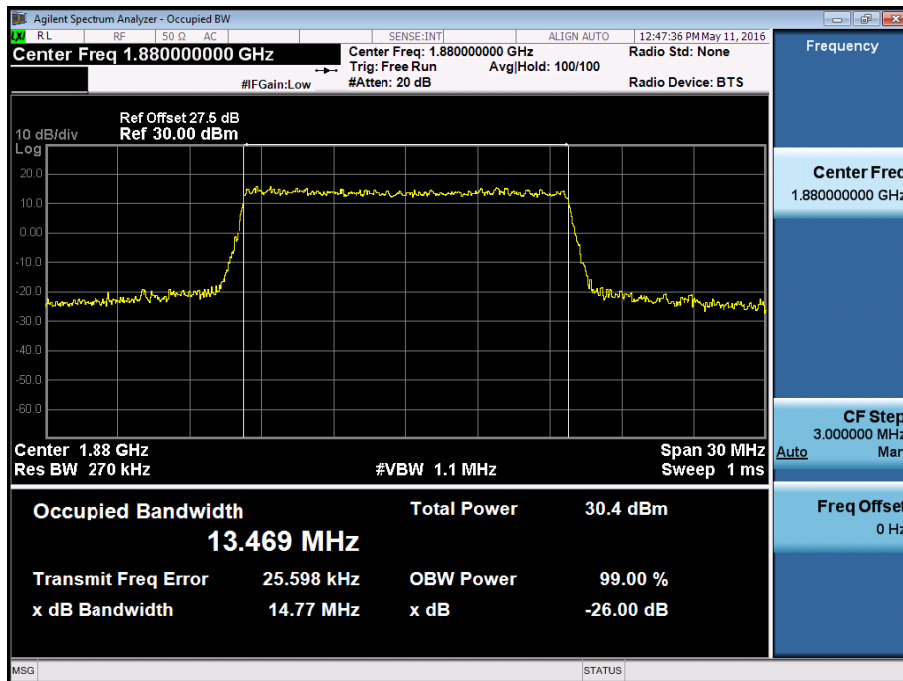

BAND 2. Occupied Bandwidth Plot (20M BW Ch.18900 QPSK RB 100_0)

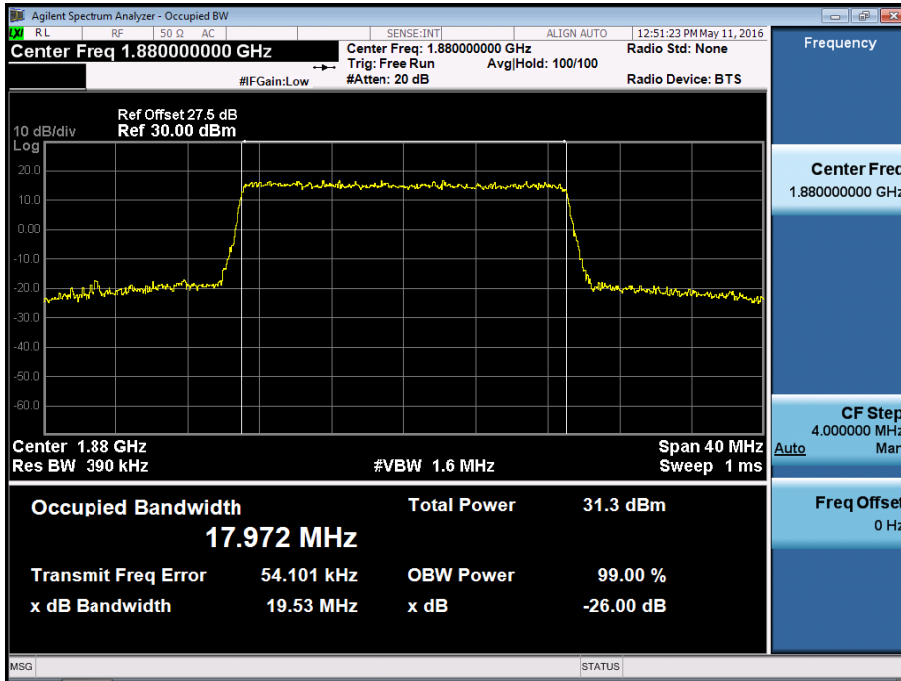

BAND 2. Occupied Bandwidth Plot (20M BW Ch.18900 16QAM RB 100_0)

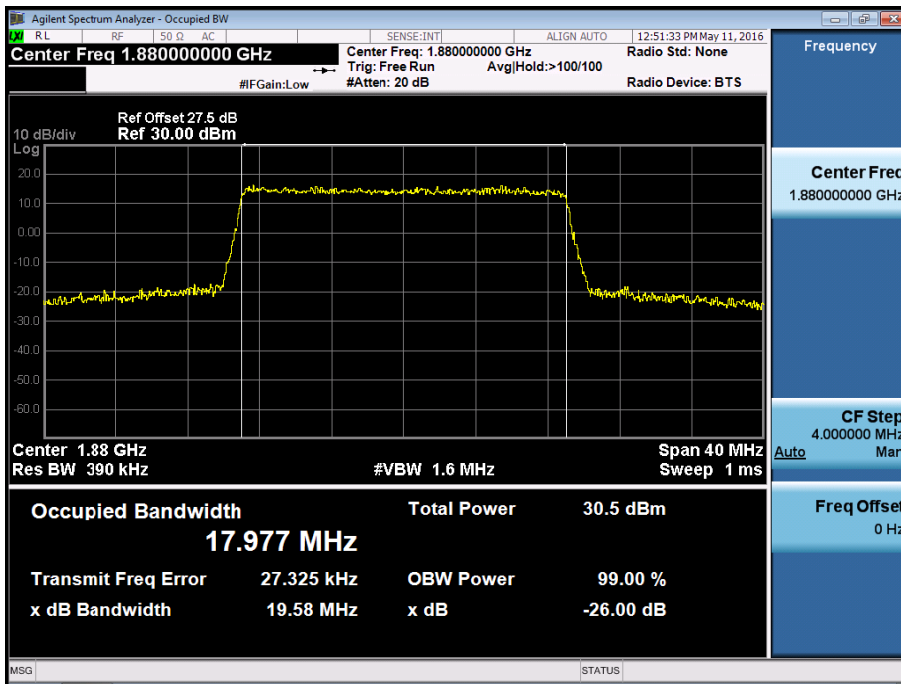

BAND 5. Occupied Bandwidth Plot (1.4M BW Ch.20525 QPSK_RB6_0)

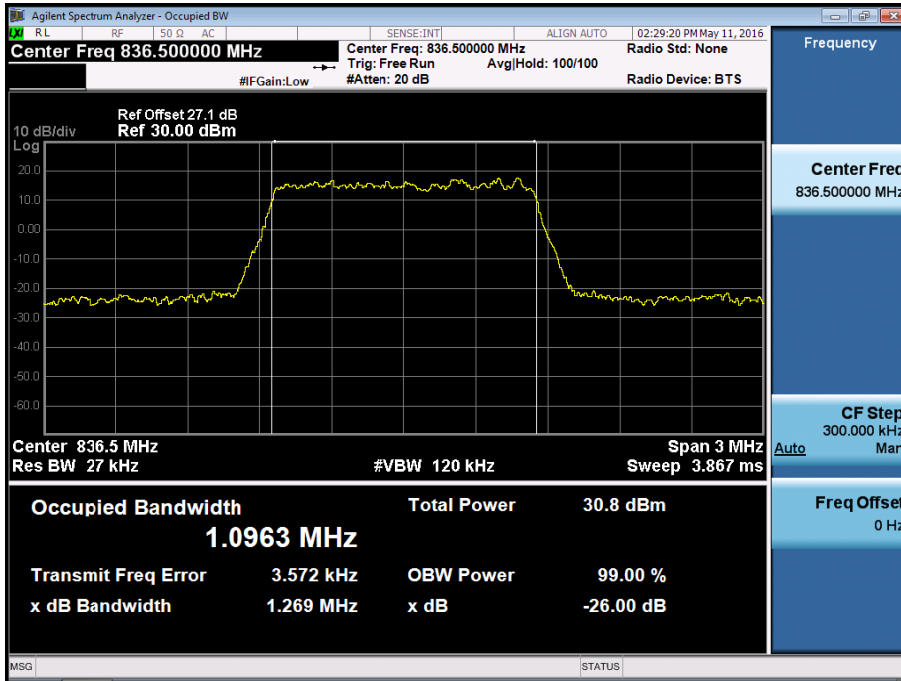

BAND 5. Occupied Bandwidth Plot (1.4M BW Ch.20525 16QAM_RB6_0)

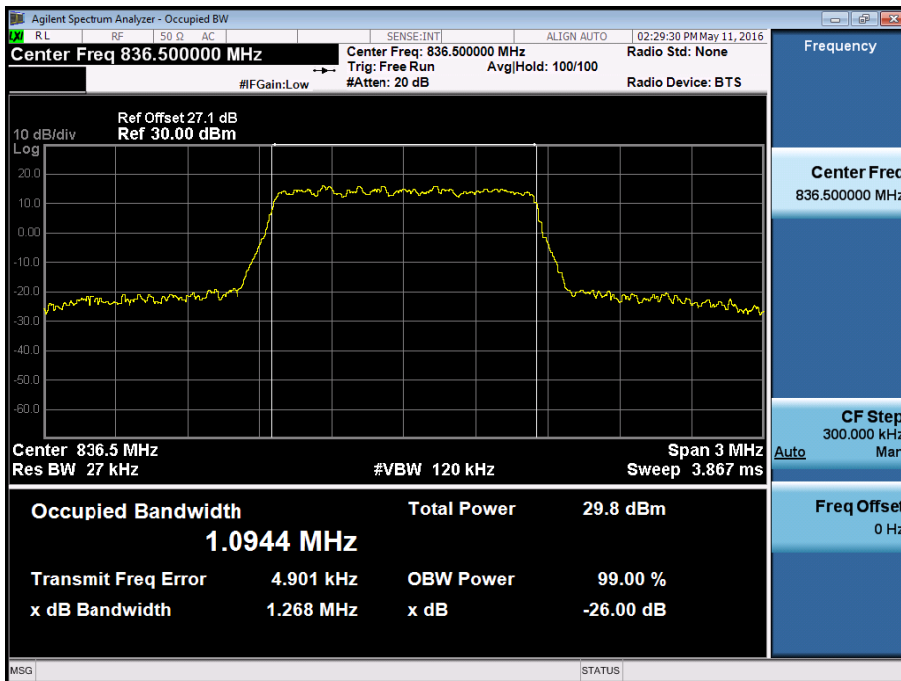

BAND 5. Occupied Bandwidth Plot (3M BW Ch.20525 QPSK_RB15_0)

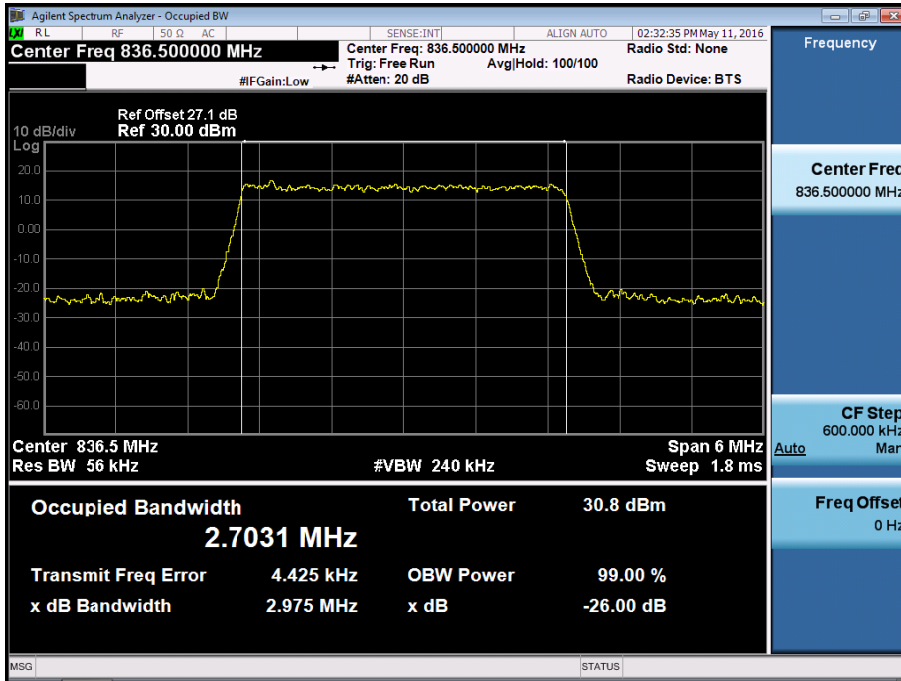

BAND 5. Occupied Bandwidth Plot (3M BW Ch.20525 16QAM_RB15_0)

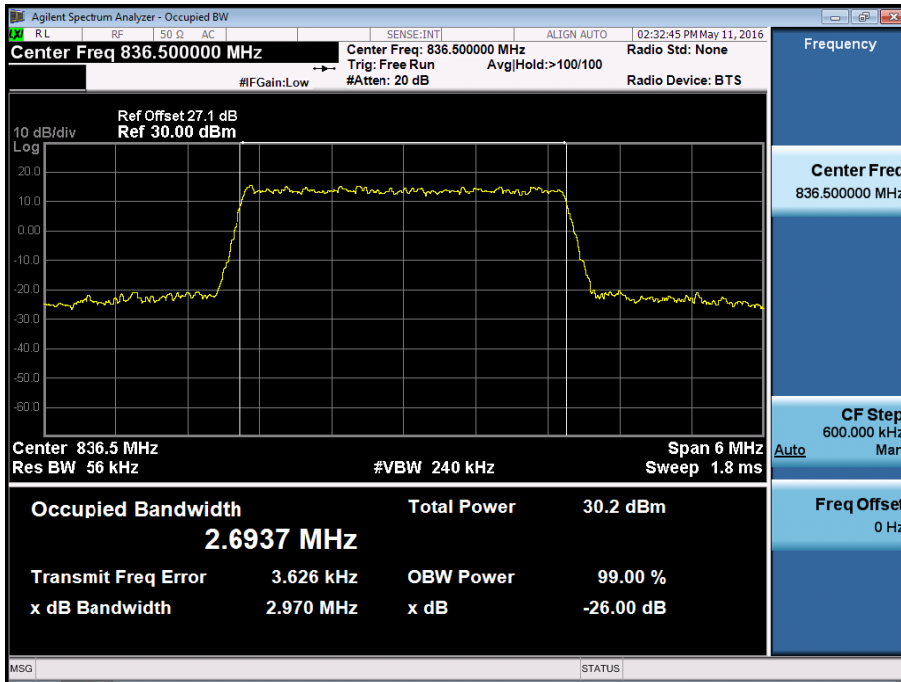

BAND 5. Occupied Bandwidth Plot (5M BW Ch.20525 QPSK_RB25_0)

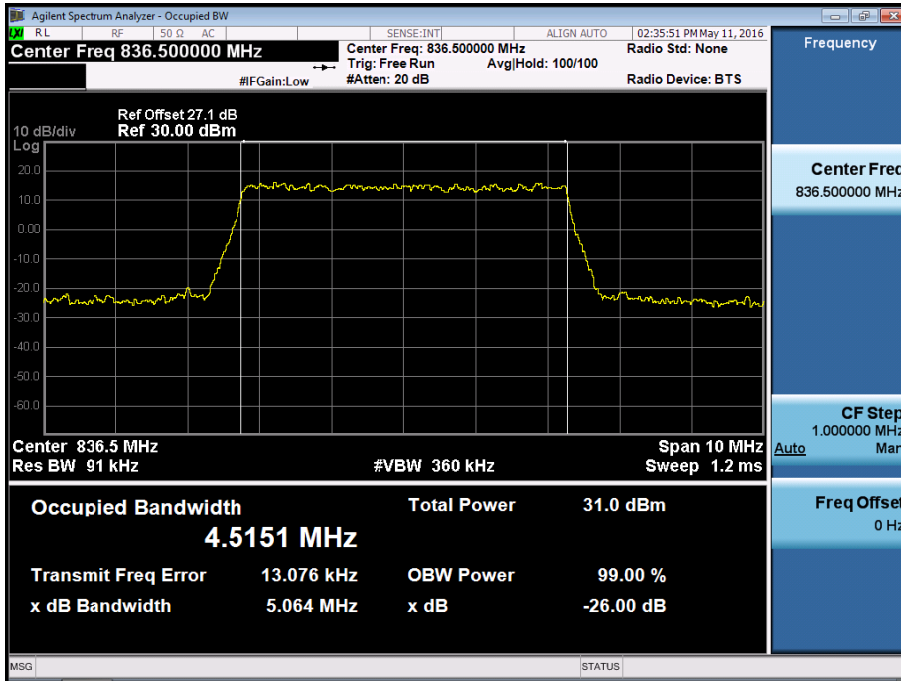

BAND 5. Occupied Bandwidth Plot (5M BW Ch.20525 16QAM_RB25_0)

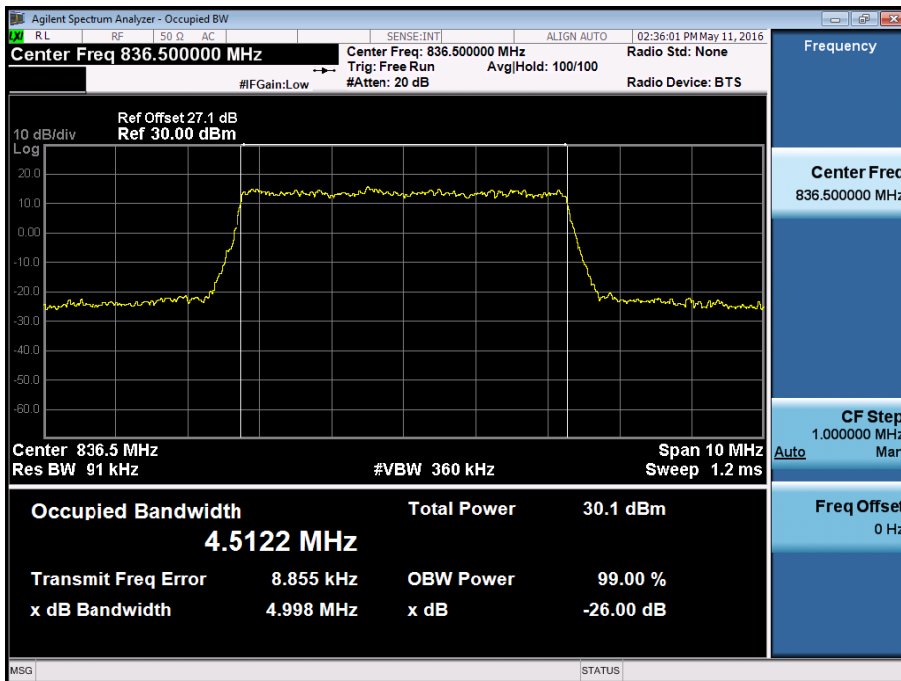

BAND 5. Occupied Bandwidth Plot (10M BW Ch.20525 QPSK_RB50_0)

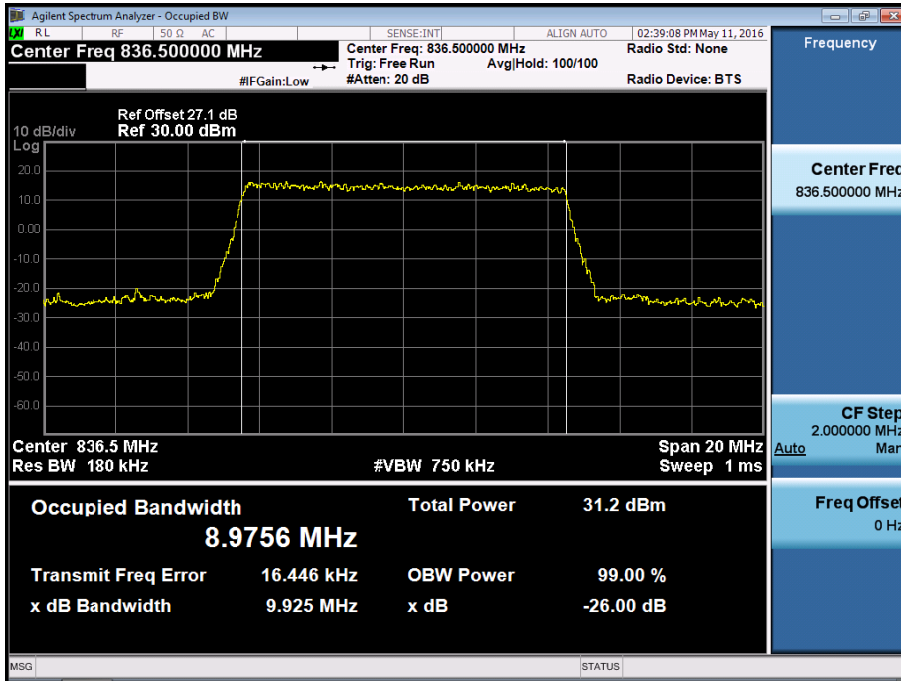

BAND 5. Occupied Bandwidth Plot (10M BW Ch.20525 16QAM_RB50_0)

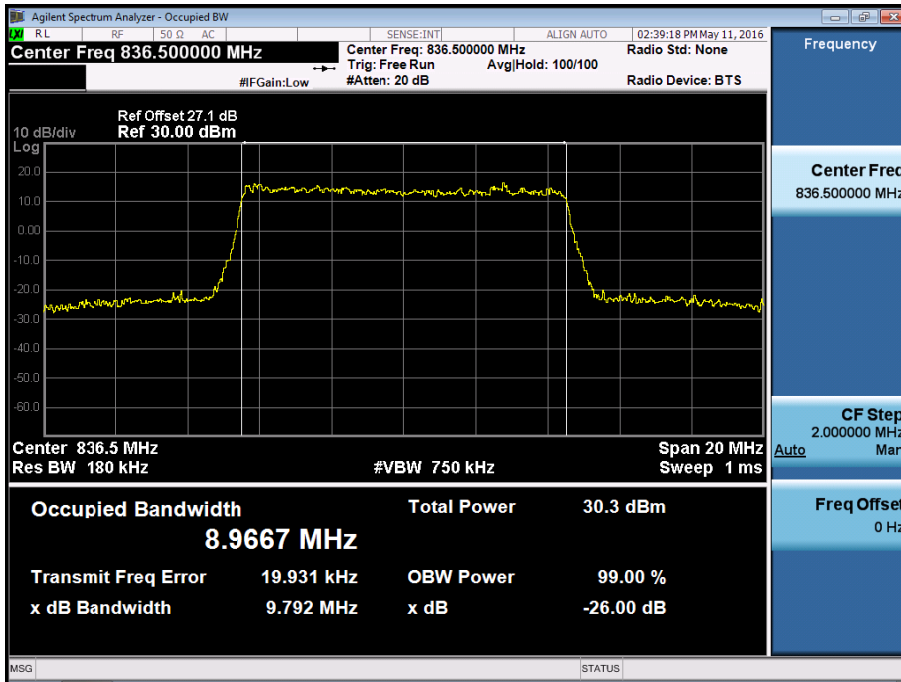

BAND 2. PAR Plot (1.4M BW Ch.18900 QPSK RB 6_0)

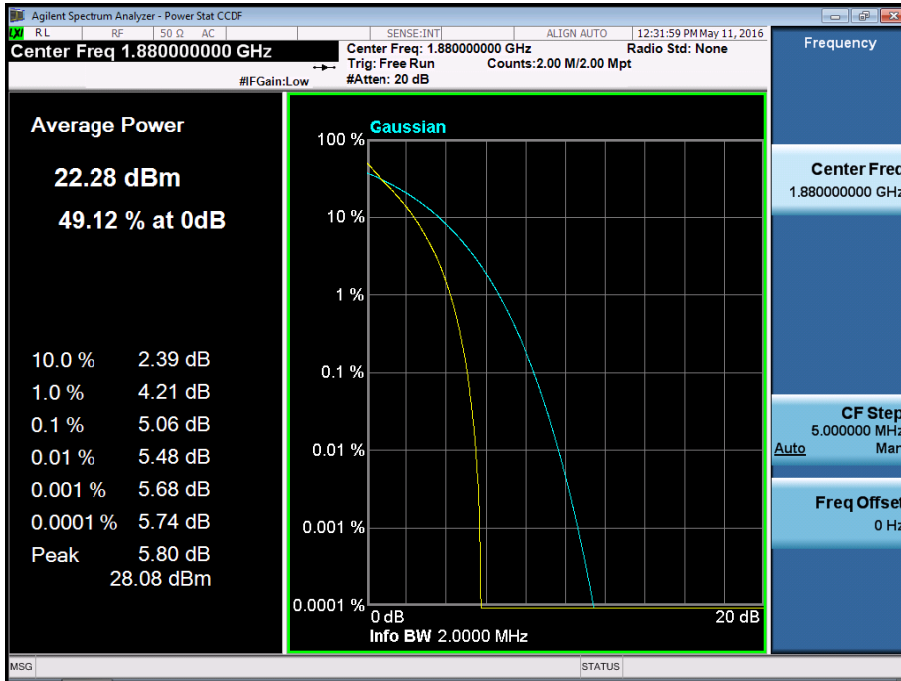

BAND 2. PAR Plot (1.4M BW Ch.18900 16QAM RB 6_0)

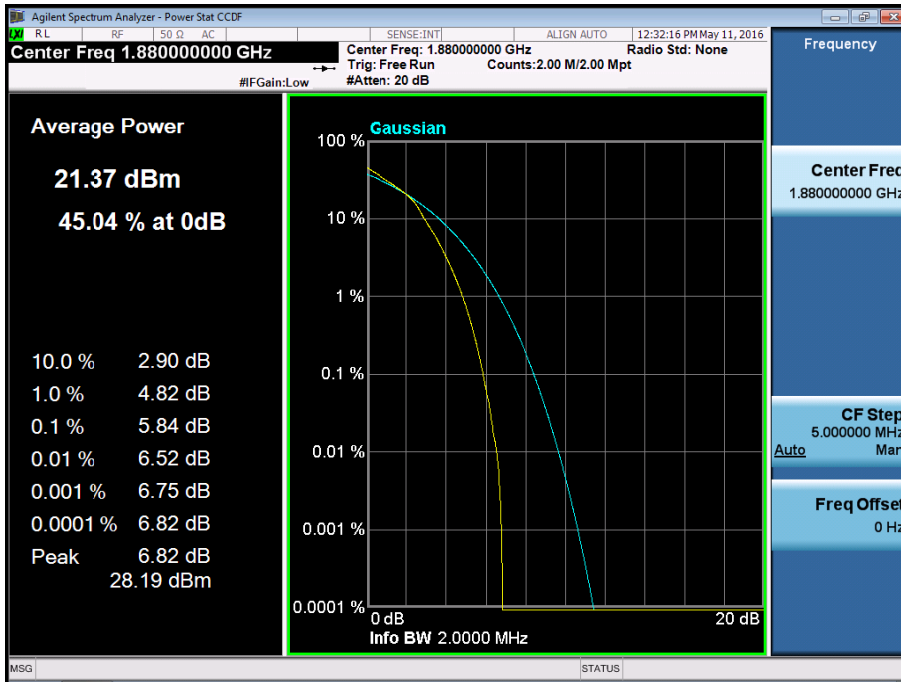

BAND 2. PAR Plot (3M BW Ch.18900 QPSK RB 15_0)

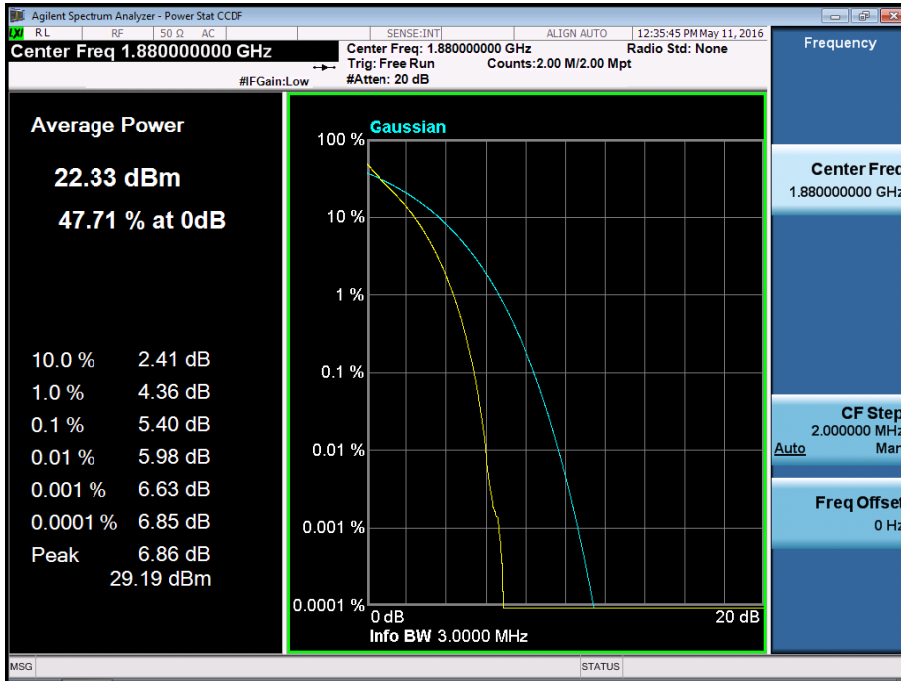

BAND 2. PAR Plot (3M BW Ch.18900 16QAM RB 15_0)

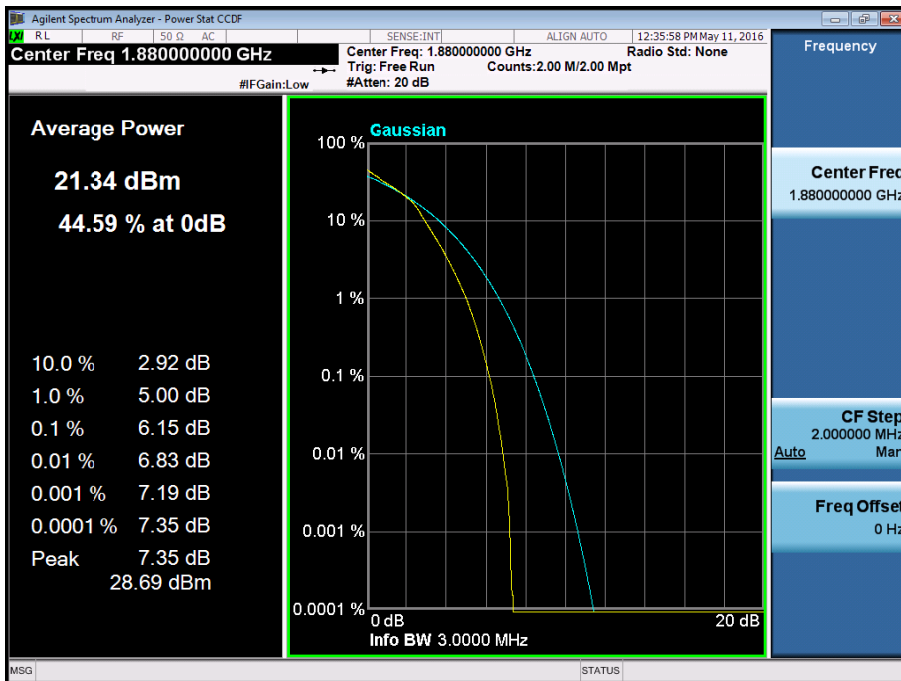

BAND 2. PAR Plot (5M BW Ch.18900 QPSK RB 25_0)

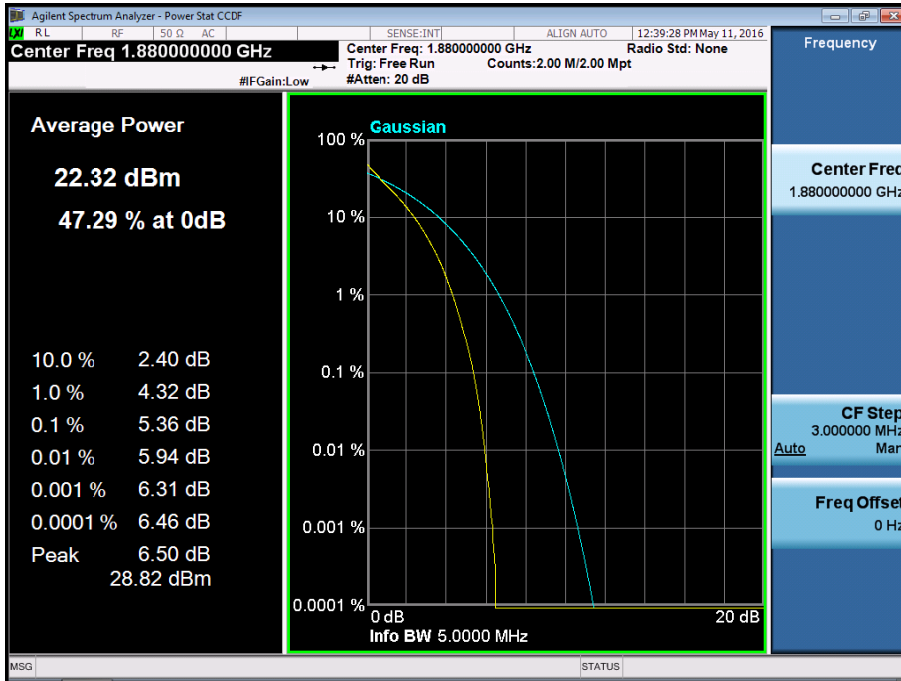

BAND 2. PAR Plot (5M BW Ch.18900 16QAM RB 25_0)

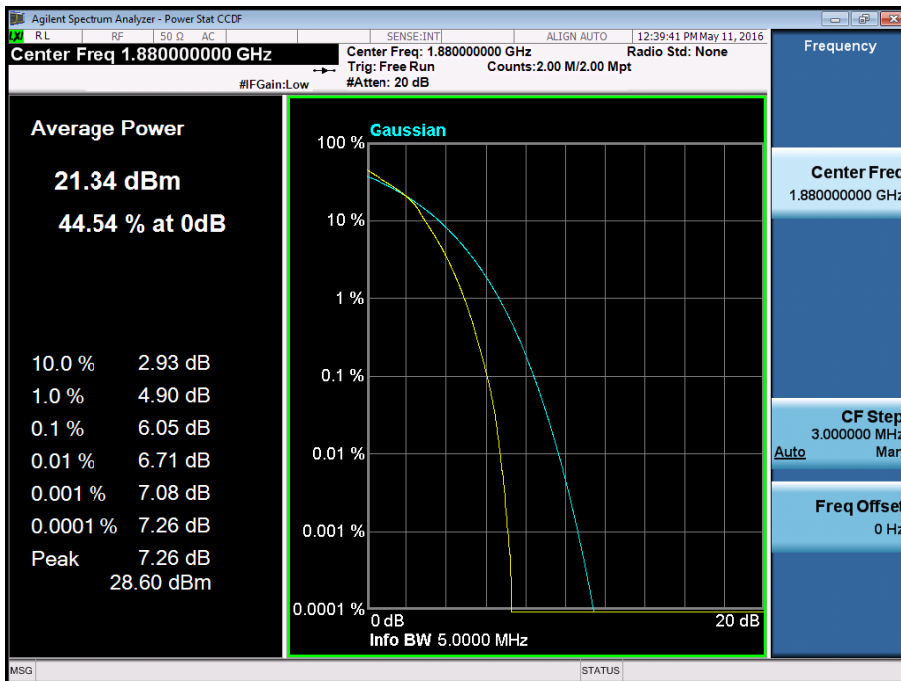

BAND 2. PAR Plot (10M BW Ch.18900 QPSK RB 50_0)

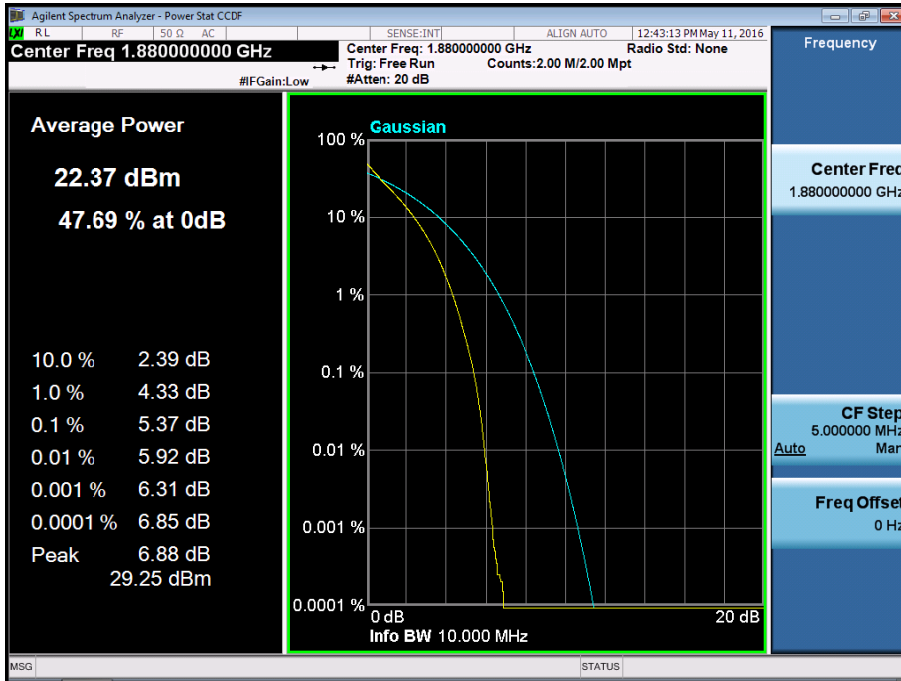

BAND 2. PAR Plot (10M BW Ch.18900 16QAM RB 50_0)

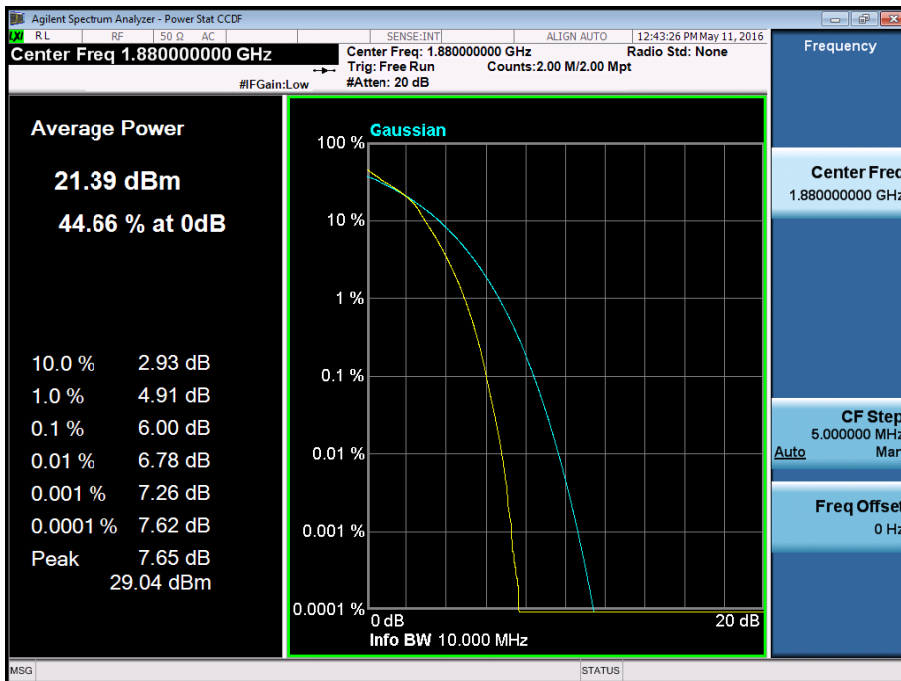

BAND 2. PAR Plot (15M BW Ch.18900 QPSK RB 75_0)

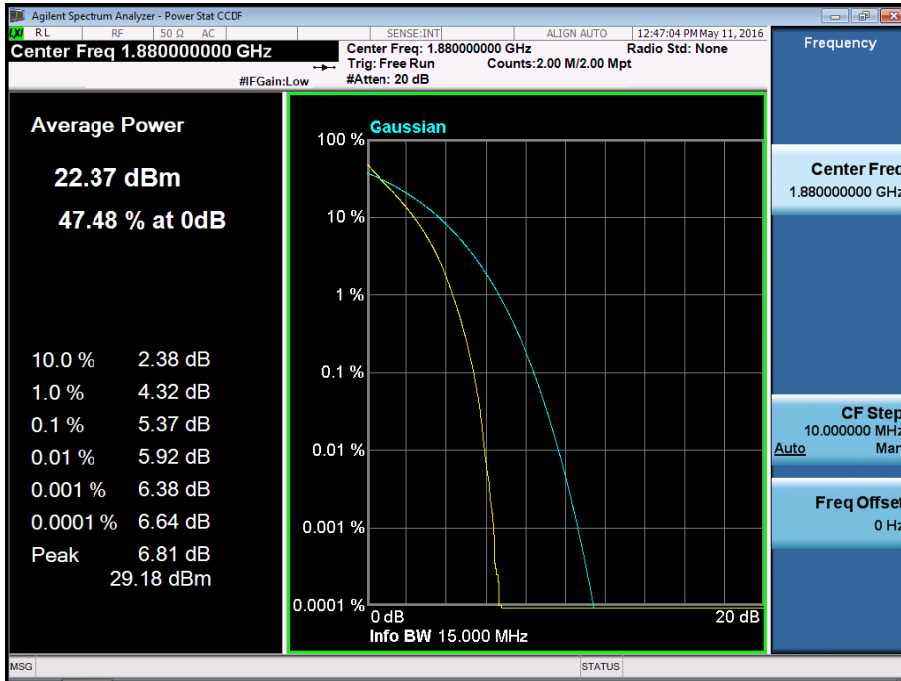

BAND 2. PAR Plot (15M BW Ch.18900 16QAM RB 75_0)

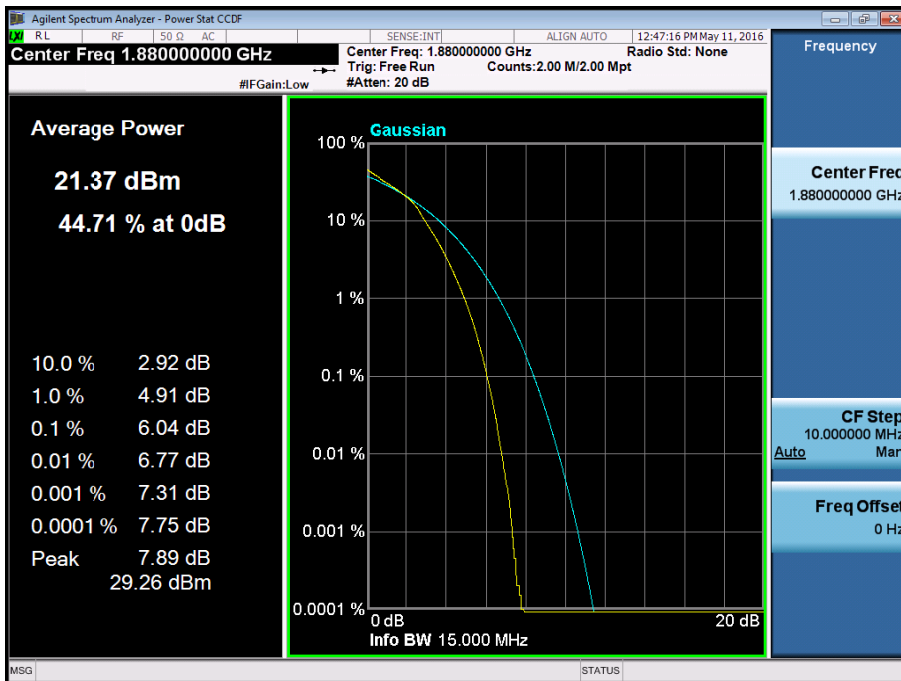

BAND 2. PAR Plot (20M BW Ch.18900 QPSK RB 100_0)

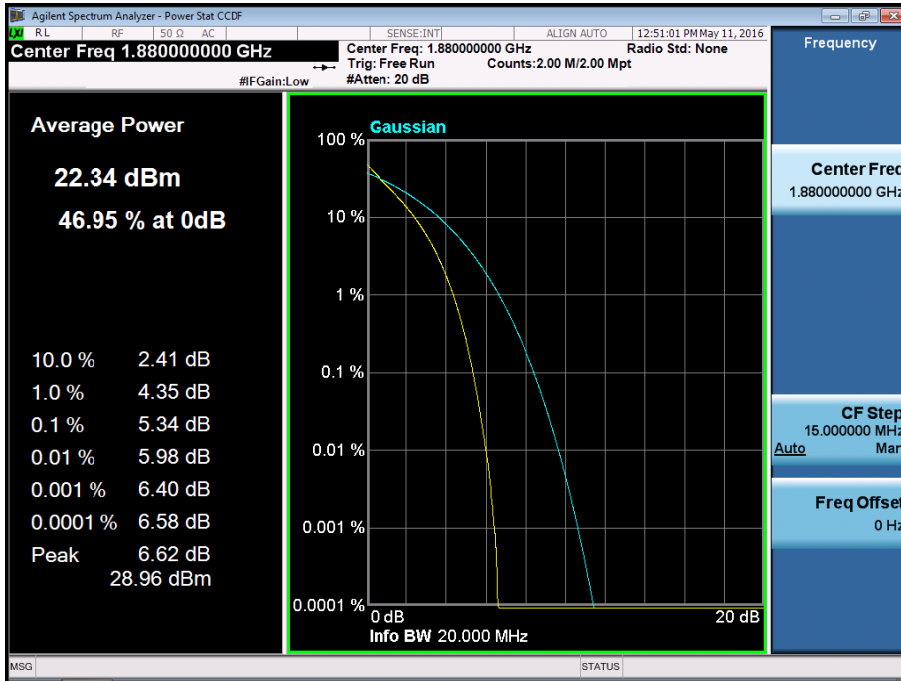

BAND 2. PAR Plot (20M BW Ch.18900 16QAM RB 100_0)

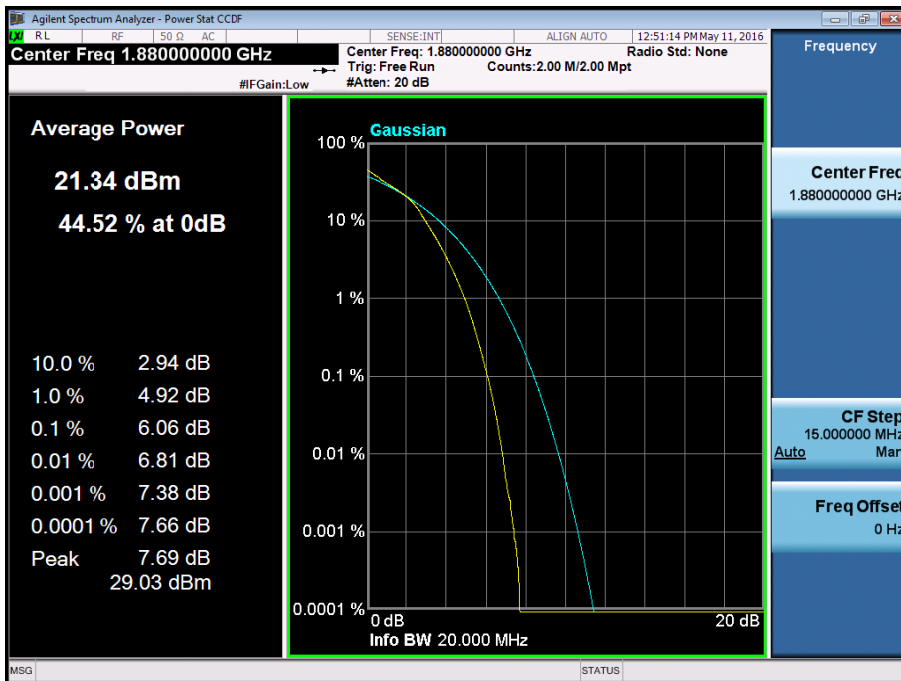

BAND 2. Lower Band Edge Plot (1.4M BW Ch.18607 QPSK_RB1_Offset 0) -1

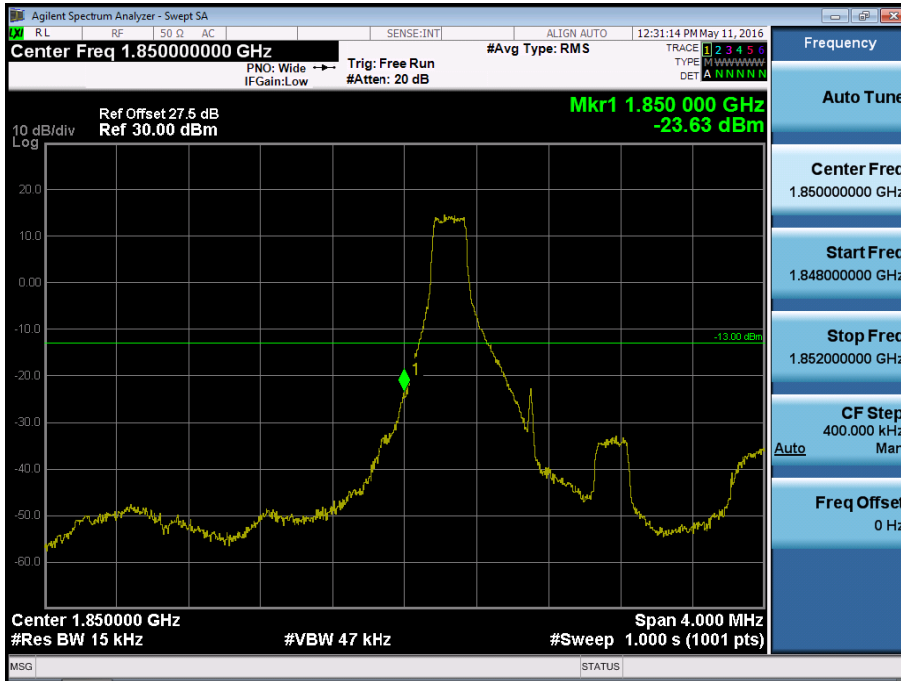

BAND 2. Lower Band Edge Plot (1.4M BW Ch.18607 QPSK_RB6_Offset 0) -2

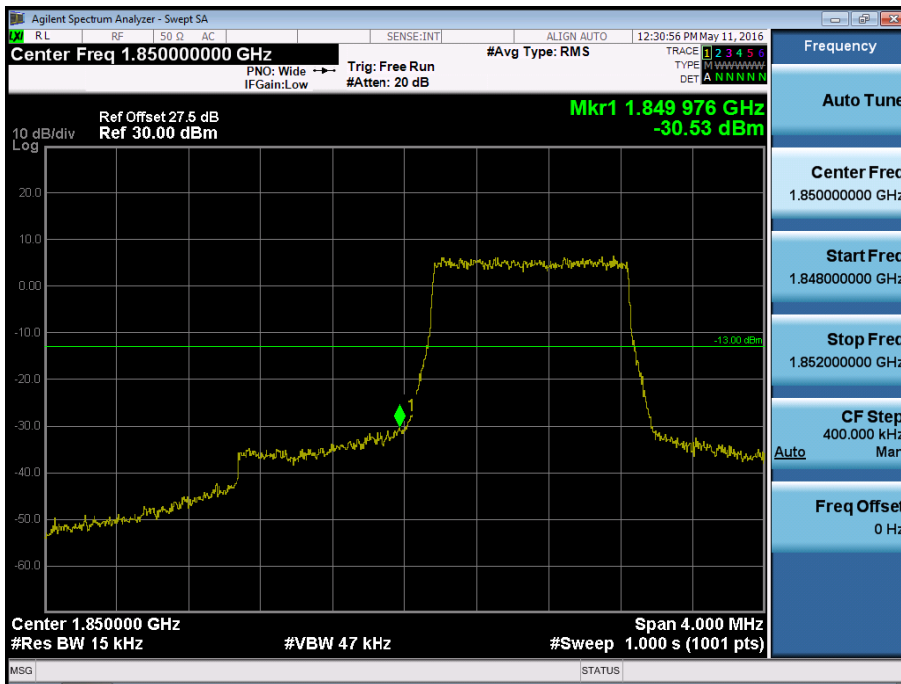

BAND 2. Lower Extended Band Edge Plot (1.4M BW Ch.18607 QPSK_RB6_0) -3

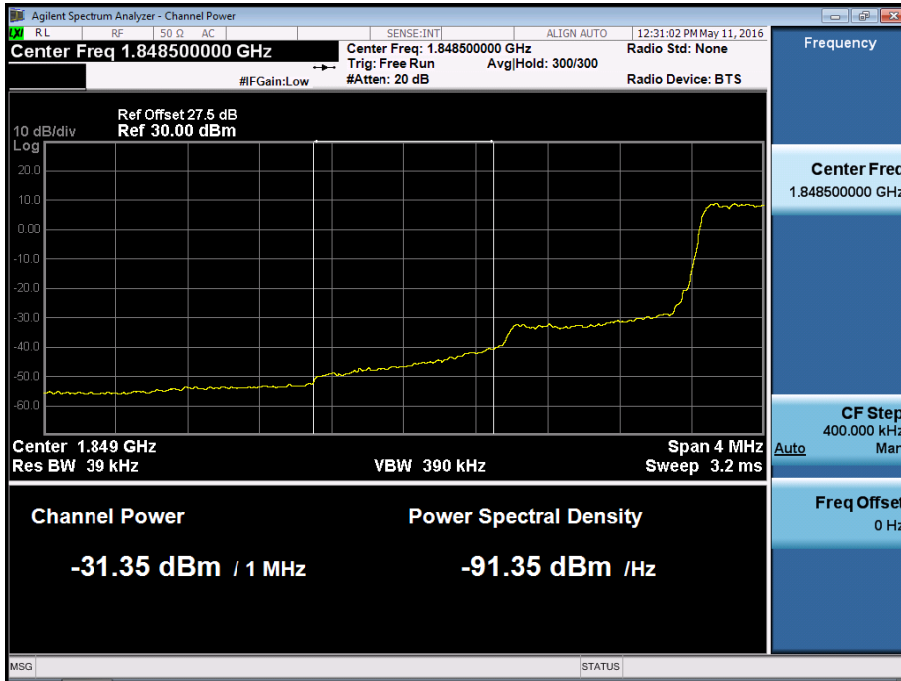

BAND 2. Lower Band Edge Plot (3M BW Ch.18615 QPSK_RB1_Offset 0) -1

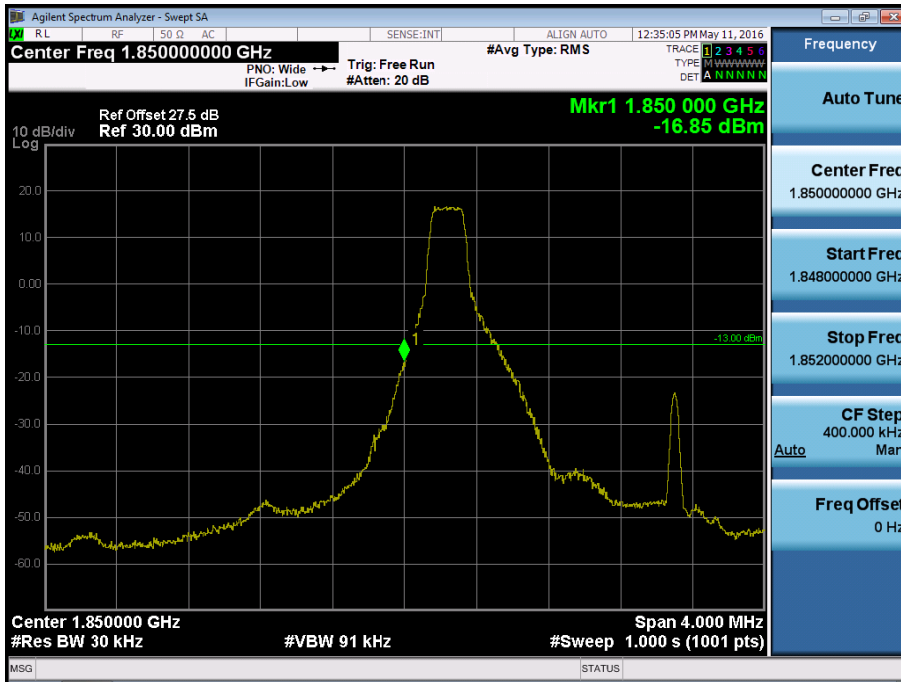

BAND 2. Lower Band Edge Plot (3M BW Ch.18615 QPSK_RB15_Offset 0) -2

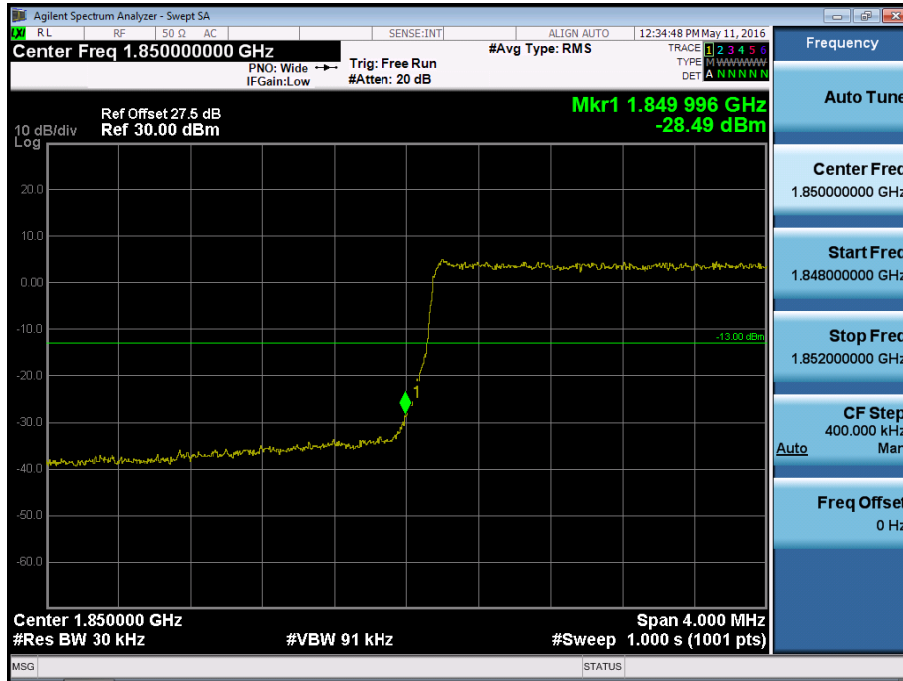

BAND 2. Lower Extended Band Edge Plot (3M BW Ch.18615 QPSK_RB15_0) -3

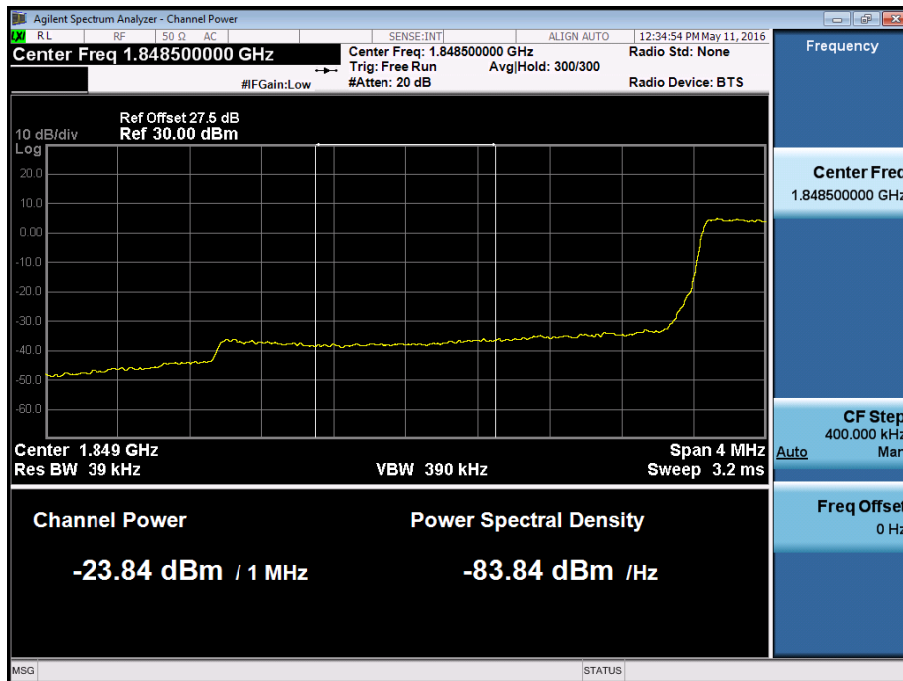

BAND 2. Lower Band Edge Plot (5M BW Ch.18625 QPSK_RB1_Offset 0) -1

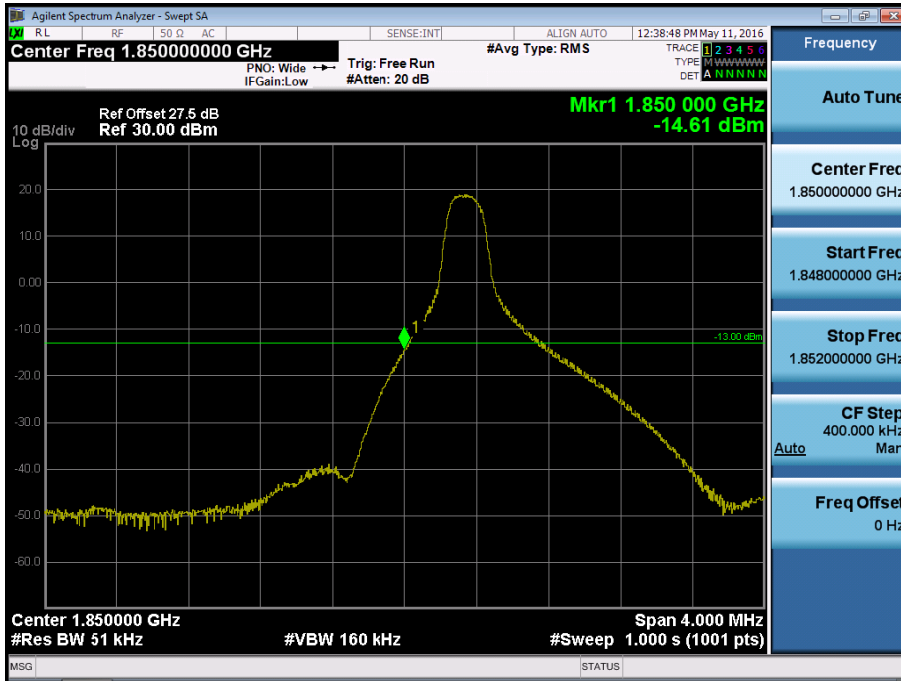

BAND 2. Lower Band Edge Plot (5M BW Ch.18625 QPSK_RB25_Offset 0) -2

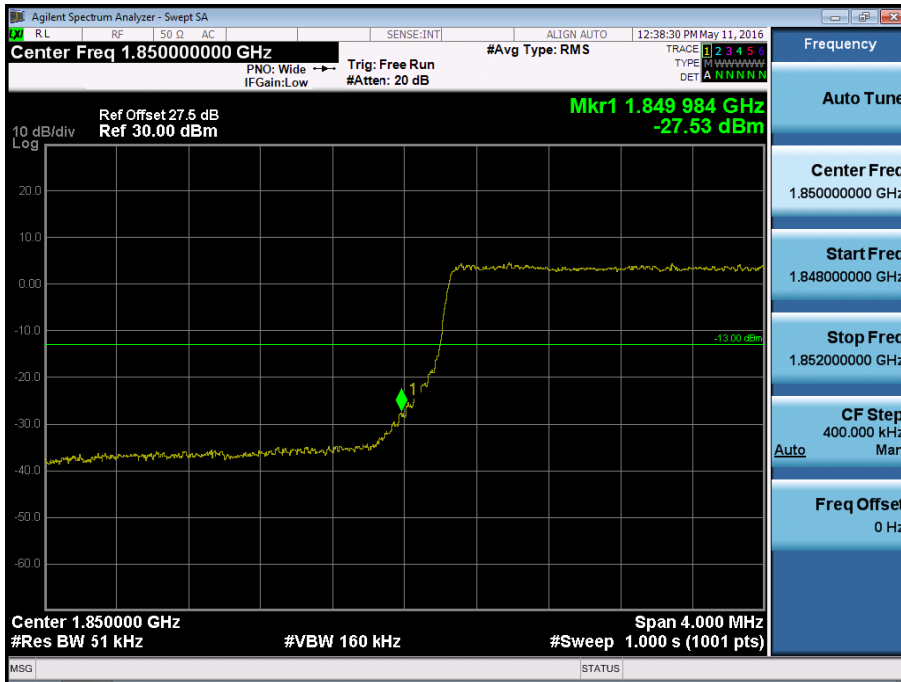

BAND 2. Lower Extended Band Edge Plot (5M BW Ch.18625 QPSK_RB25_0) -3

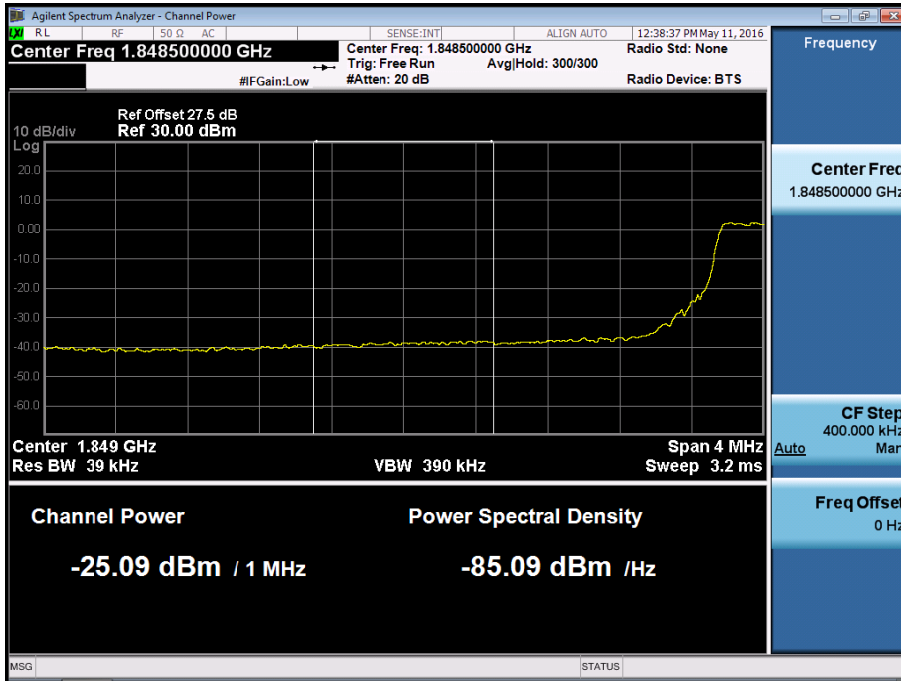

BAND 2. Lower Band Edge Plot (10M BW Ch.18650 QPSK_RB1_Offset 0) -1



BAND 2. Lower Band Edge Plot (10M BW Ch.18650 QPSK_RB50_Offset 0) -2



BAND 2. Lower Extended Band Edge Plot (10M BW Ch.18650 QPSK_RB50_0) -3

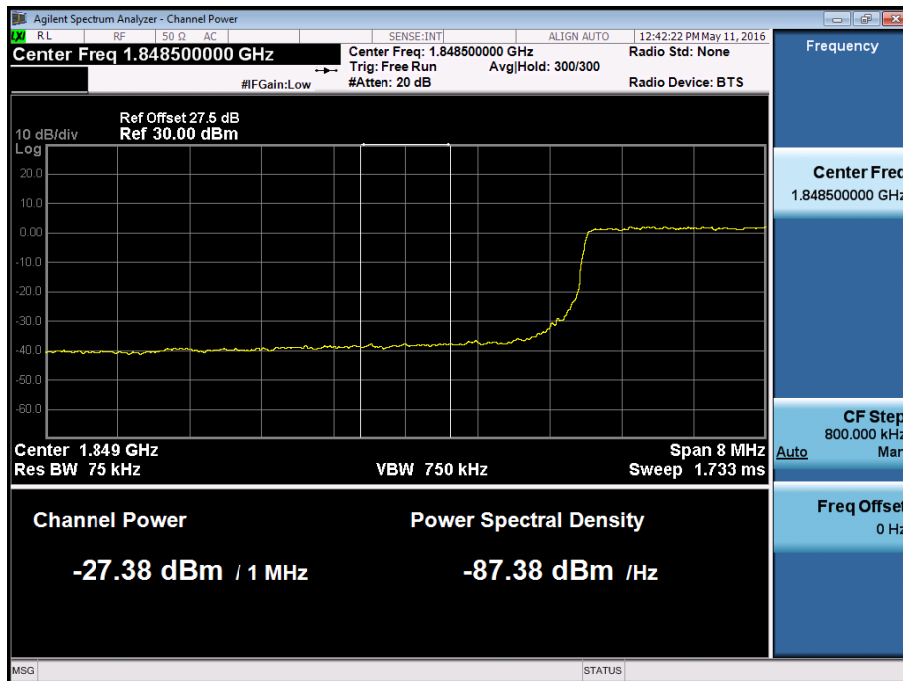

BAND 2. Lower Band Edge Plot (15M BW Ch.18675 QPSK_RB75_Offset 0) -1

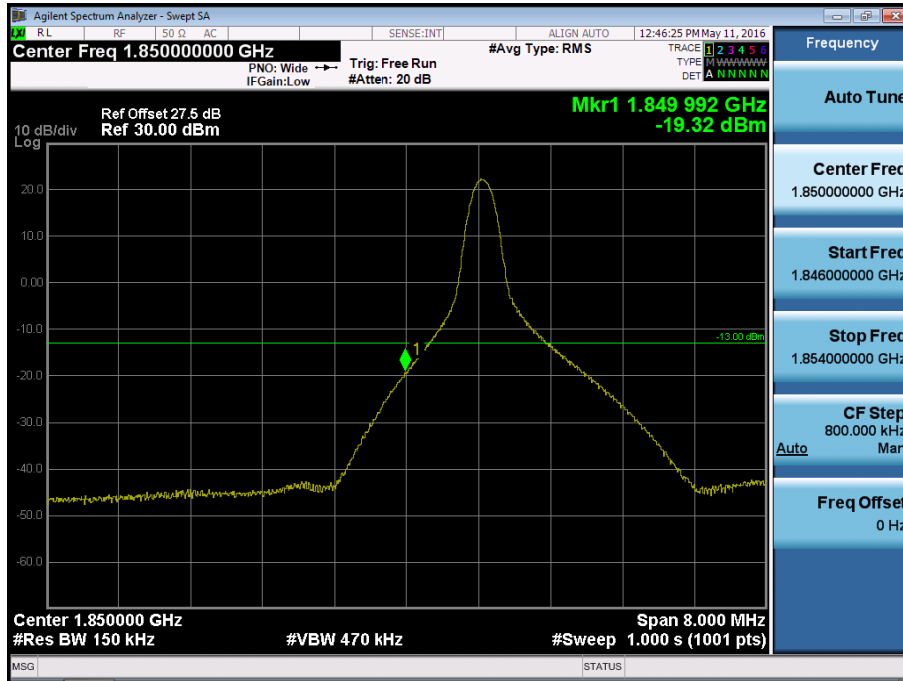

BAND 2. Lower Band Edge Plot (15M BW Ch.18675 QPSK_RB75_Offset 0) -2

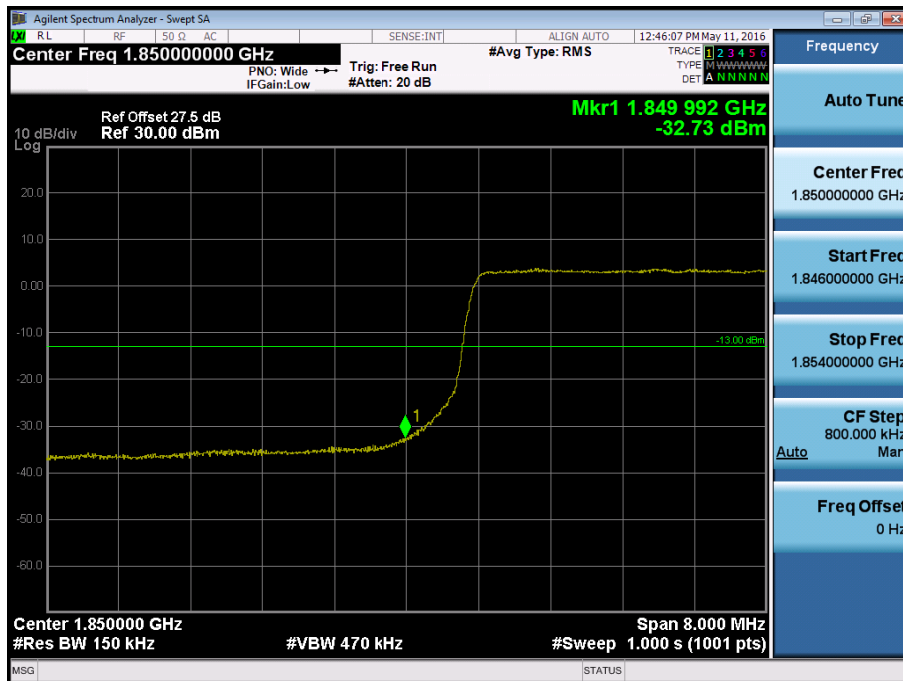

BAND 2. Lower Extended Band Edge Plot (15M BW Ch.18675 QPSK_RB75_0) -3

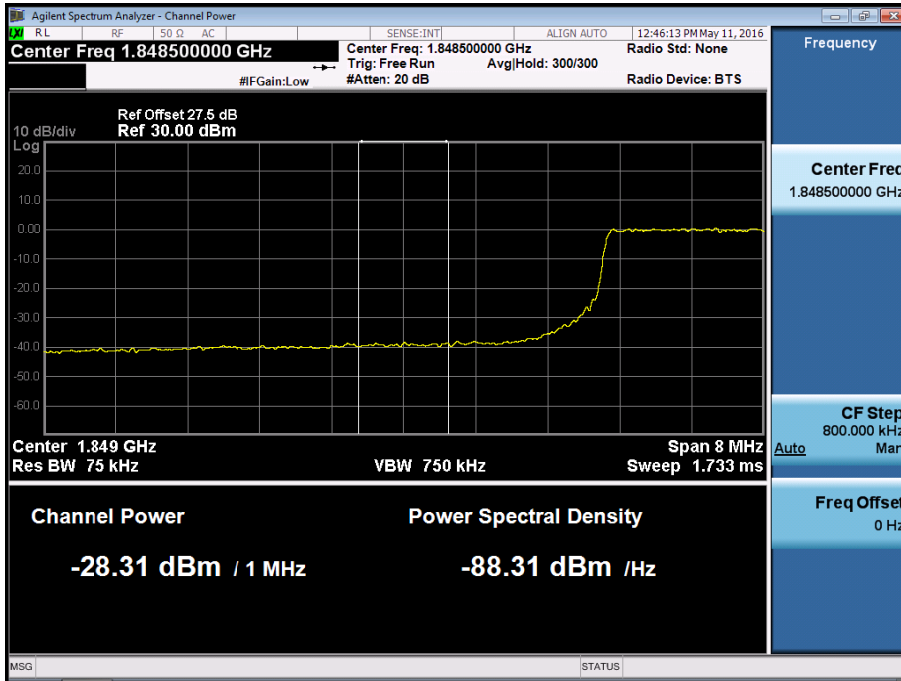

BAND 2. Lower Band Edge Plot (20M BW Ch.18700 QPSK_RB1_Offset 0) -1

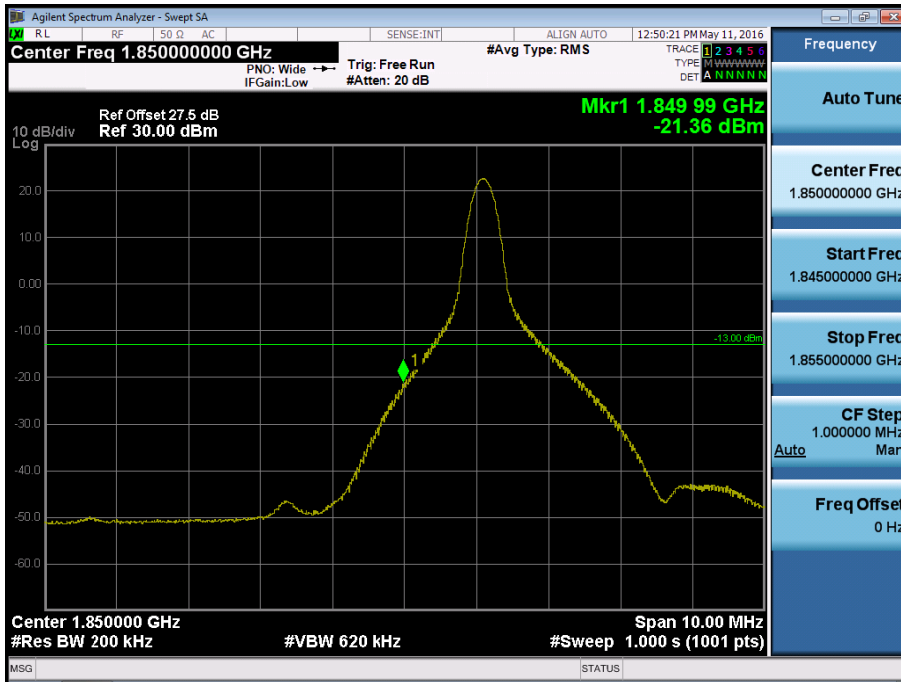

BAND 2. Lower Band Edge Plot (20M BW Ch.18700 QPSK_RB100_Offset 0) -2



BAND 2. Lower Extended Band Edge Plot (20M BW Ch.18700 QPSK_RB100_0) -3

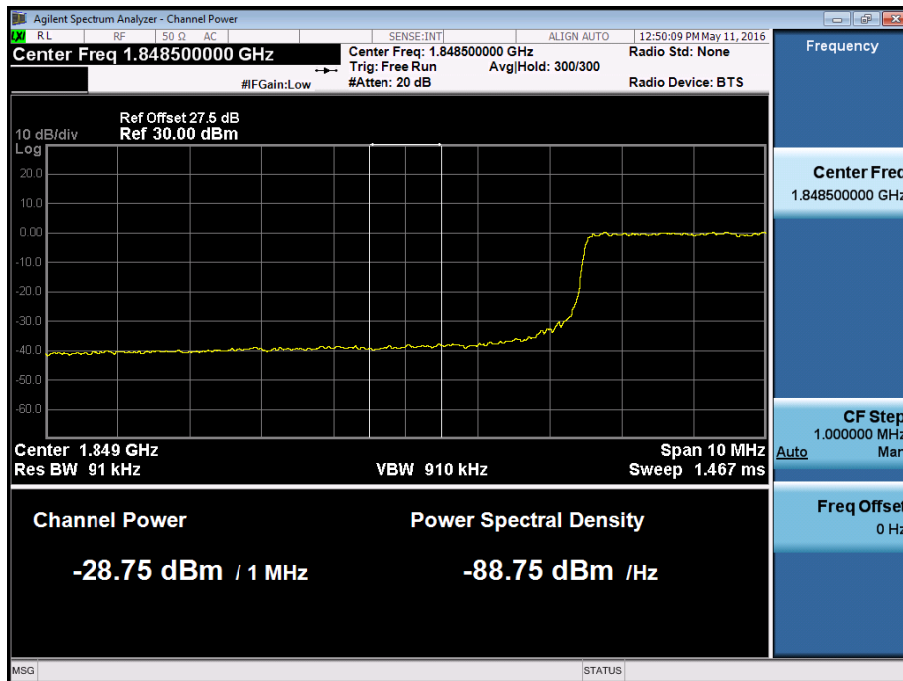

BAND 2. Upper Band Edge Plot (1.4M BW Ch.19193 QPSK_RB1_Offset 5) -1



BAND 2. Upper Band Edge Plot (1.4M BW Ch.19193 QPSK_RB6_Offset 0) -2

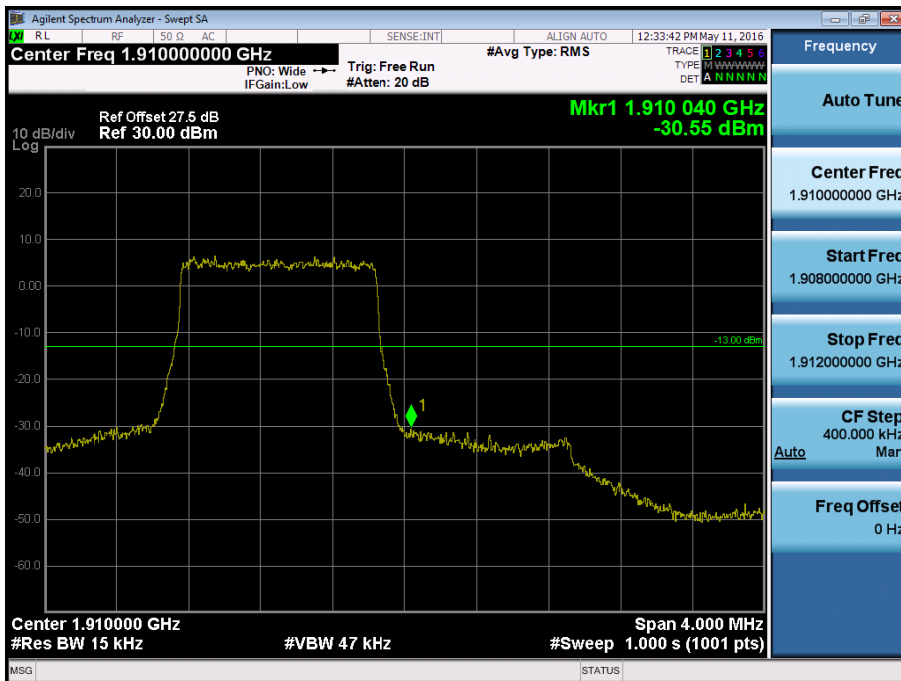

BAND 2. Upper Extended Band Edge Plot (1.4M BW Ch.19193 QPSK_RB6_0) -3

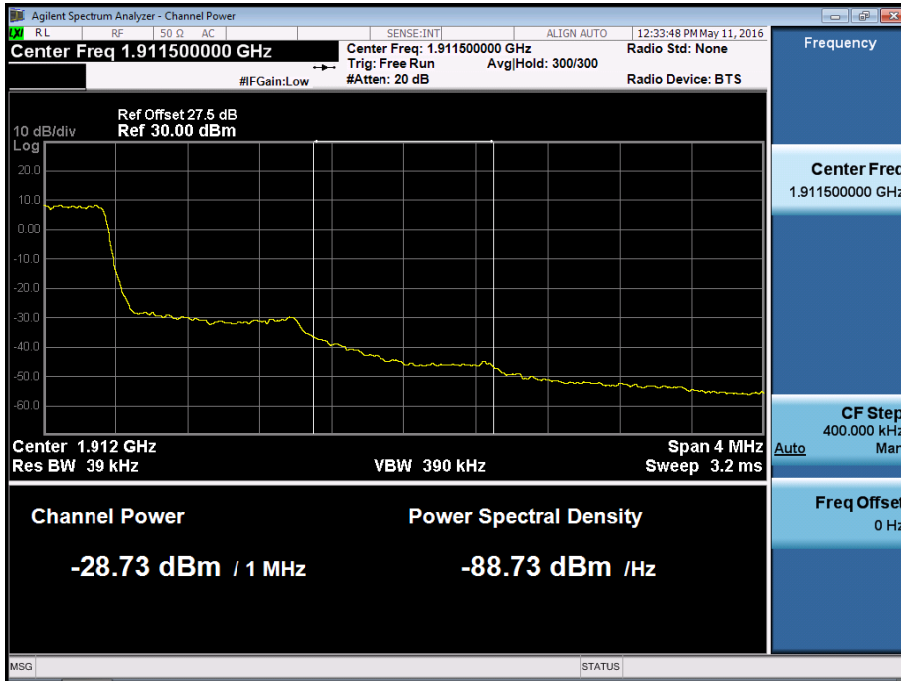

BAND 2. Upper Band Edge Plot (3M BW Ch.19185 QPSK_RB1_Offset 14) -1

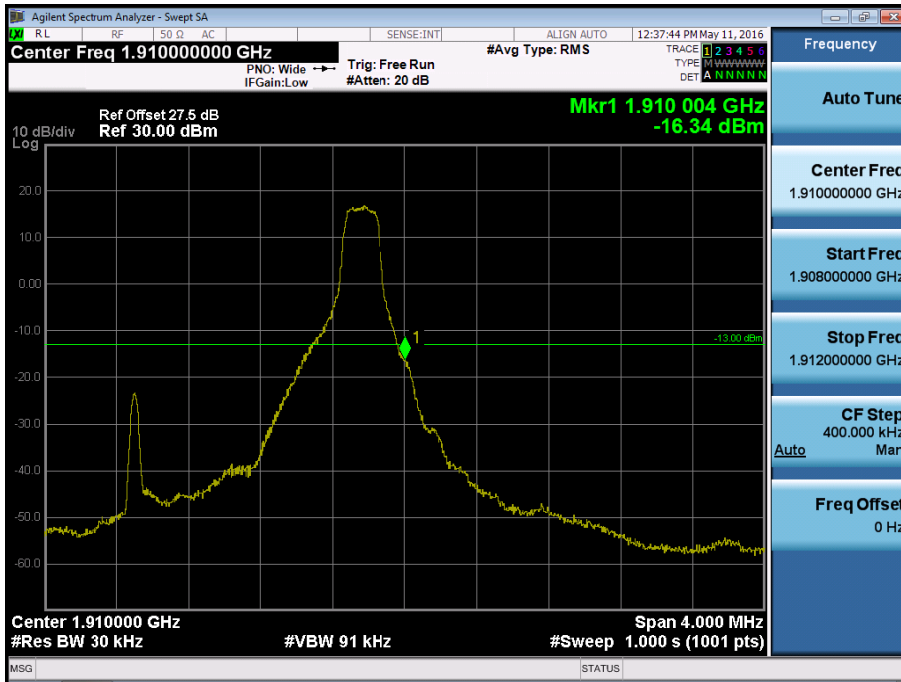

BAND 2. Upper Band Edge Plot (3M BW Ch.19185 QPSK_RB15_Offset 0) -2



BAND 2. Upper Extended Band Edge Plot (3M BW Ch.19185 QPSK_RB15 0) -3

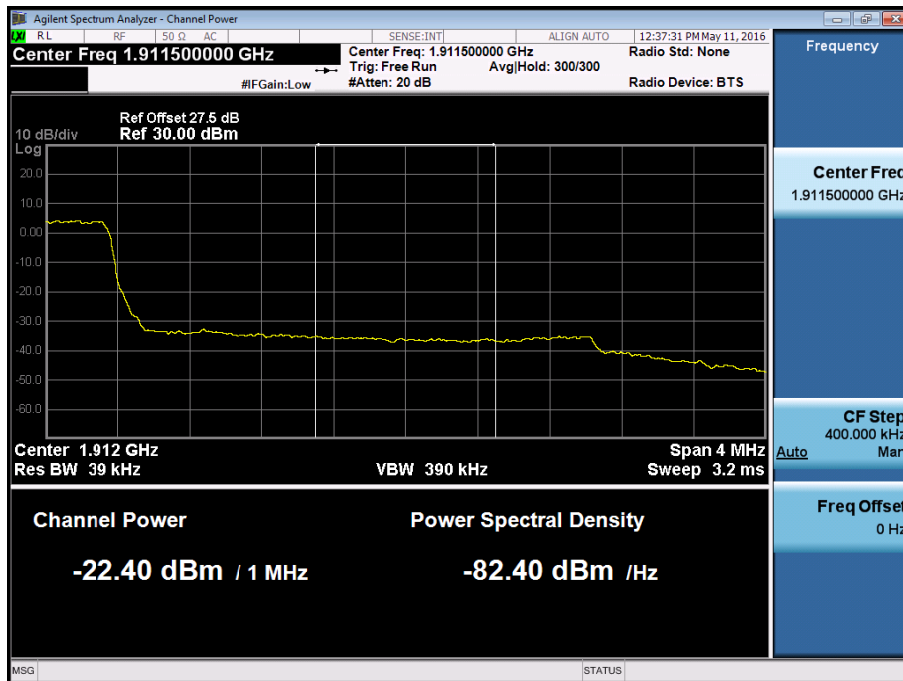

BAND 2. Upper Band Edge Plot (5M BW Ch.19175 QPSK_RB1_Offset 24) -1



BAND 2. Upper Band Edge Plot (5M BW Ch.19175 QPSK_RB25_Offset 0) -2

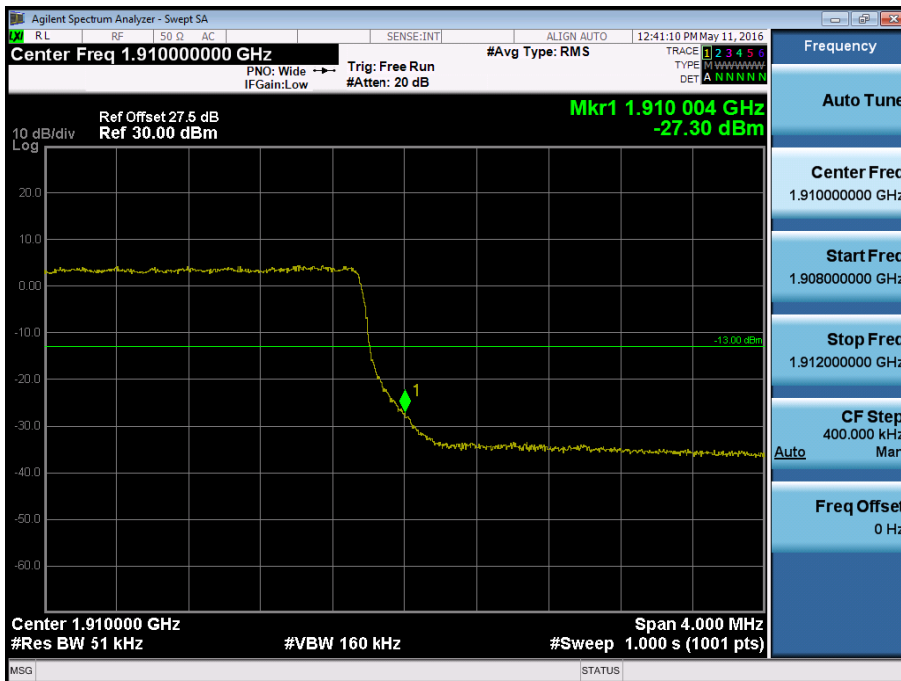

BAND 2. Upper Extended Band Edge Plot (5M BW Ch.19175 QPSK_RB25_0) -3



BAND 2. Upper Band Edge Plot (10M BW Ch.19150 QPSK_RB1_Offset 49) -1

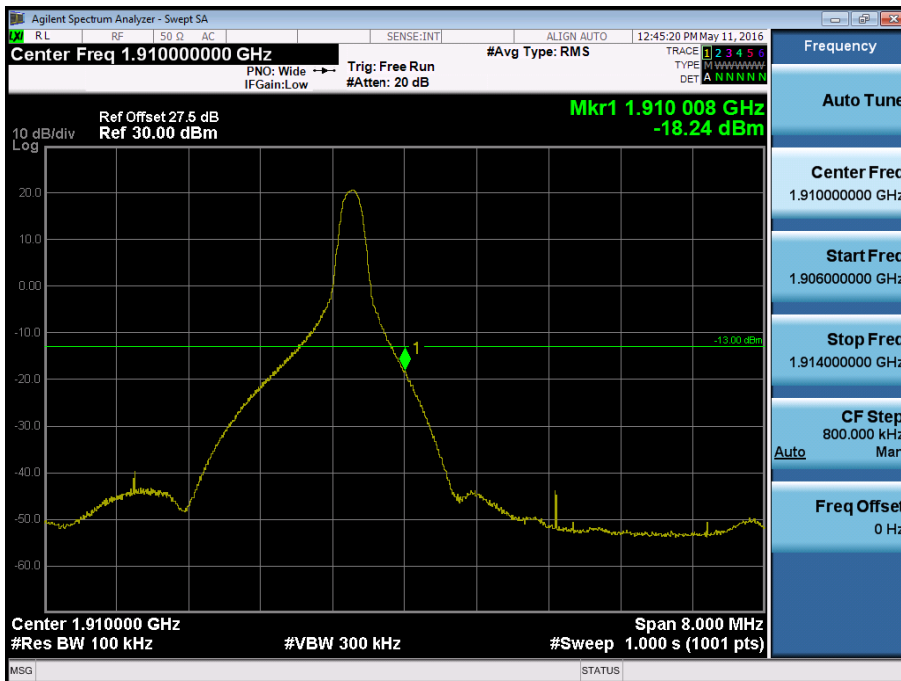

BAND 2. Upper Band Edge Plot (10M BW Ch.19150 QPSK_RB50_Offset 0) -2



BAND 2. Upper Extended Band Edge Plot (10M BW Ch.19150 QPSK_RB50_0) -3

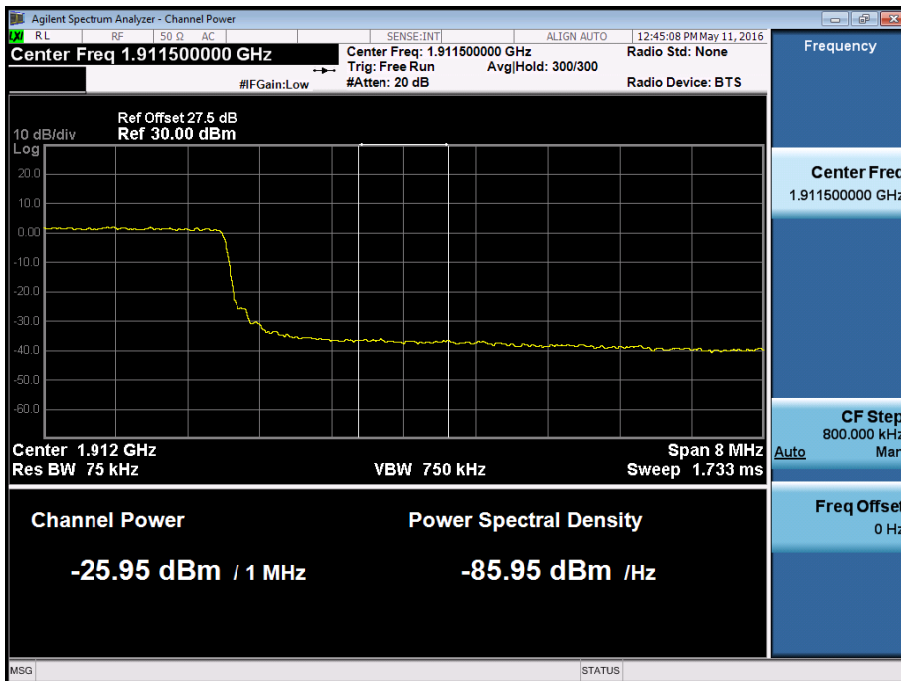

BAND 2. Upper Band Edge Plot (15M BW Ch.19125 QPSK_RB1_Offset 74) -1

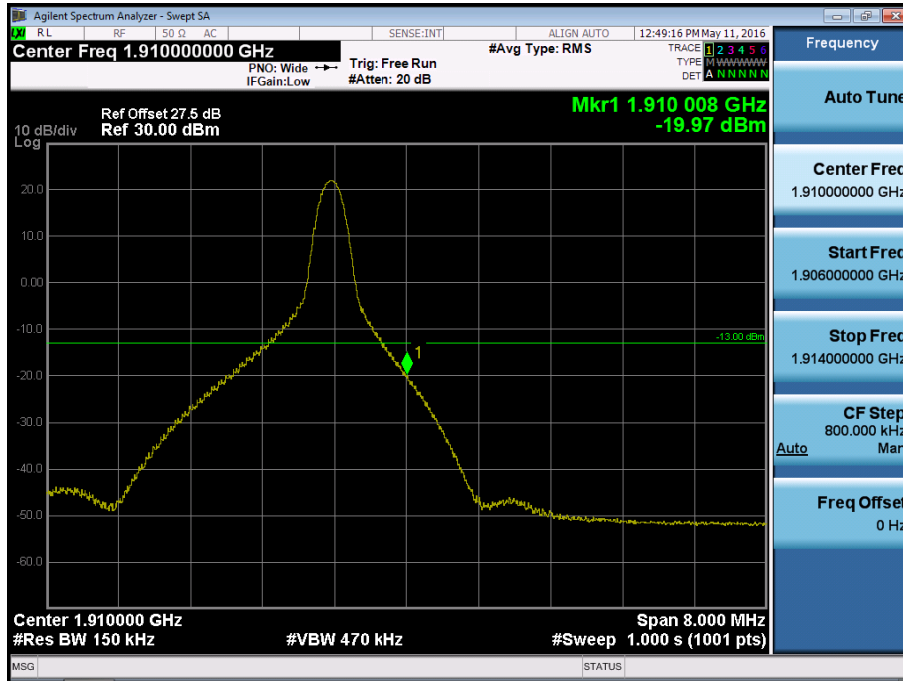

BAND 2. Upper Band Edge Plot (15M BW Ch.19125 QPSK_RB75_Offset 0) -2



BAND 2. Upper Extended Band Edge Plot (15M BW Ch.19125 QPSK_RB75_0) -3

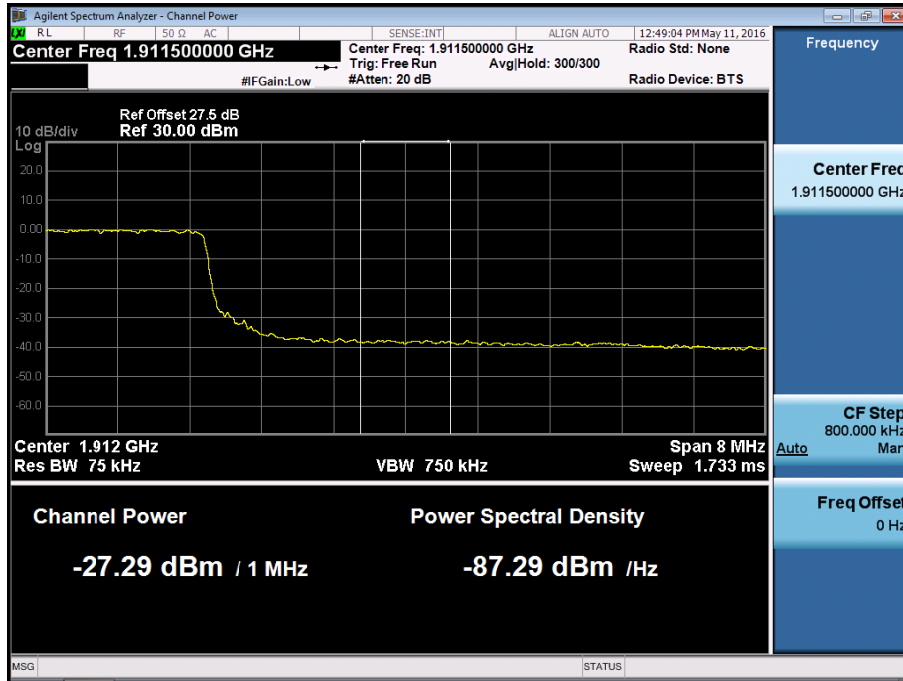

BAND 2. Upper Band Edge Plot (20M BW Ch.19100 QPSK_RB1_Offset 99) -1

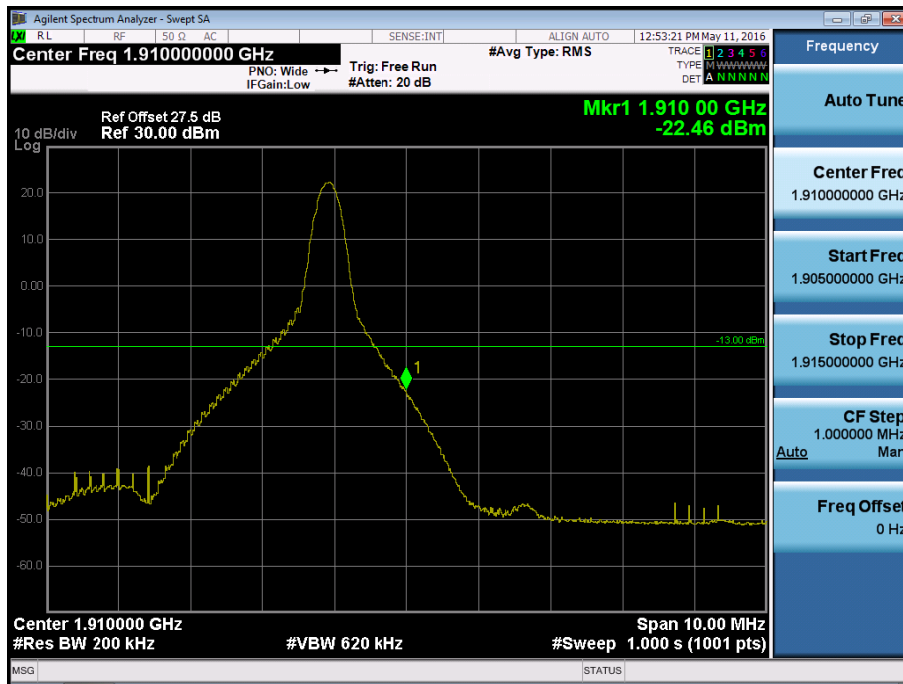

BAND 2. Upper Band Edge Plot (20M BW Ch.19100 QPSK_RB100_Offset 0) -2



BAND 2. Upper Extended Band Edge Plot (20M BW Ch.19100 QPSK_RB100_0) -3

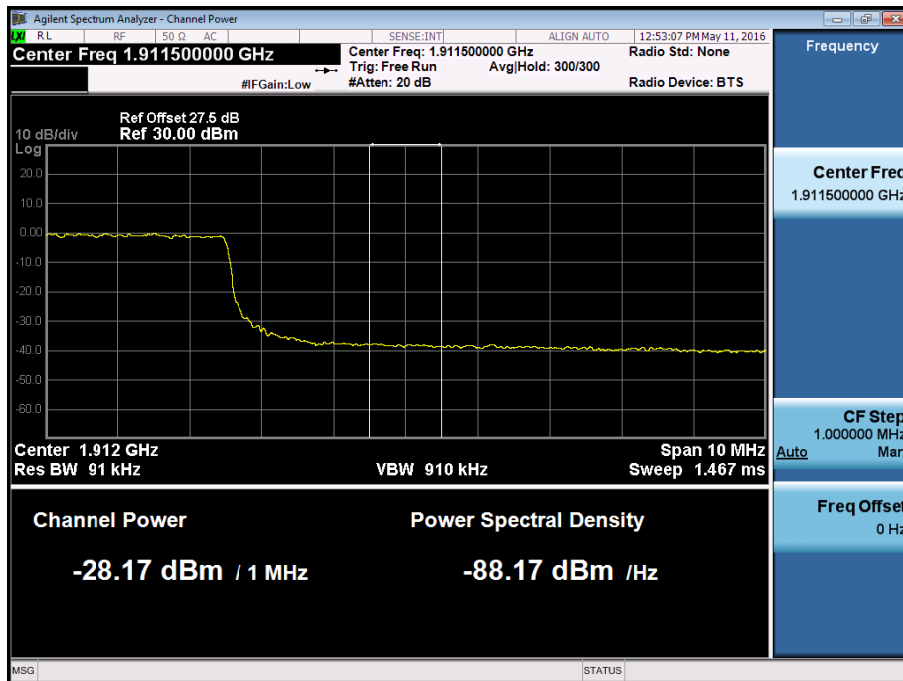

BAND 5. Lower Band Edge Plot (1.4M BW Ch.20407 QPSK_RB1_Offset 0)

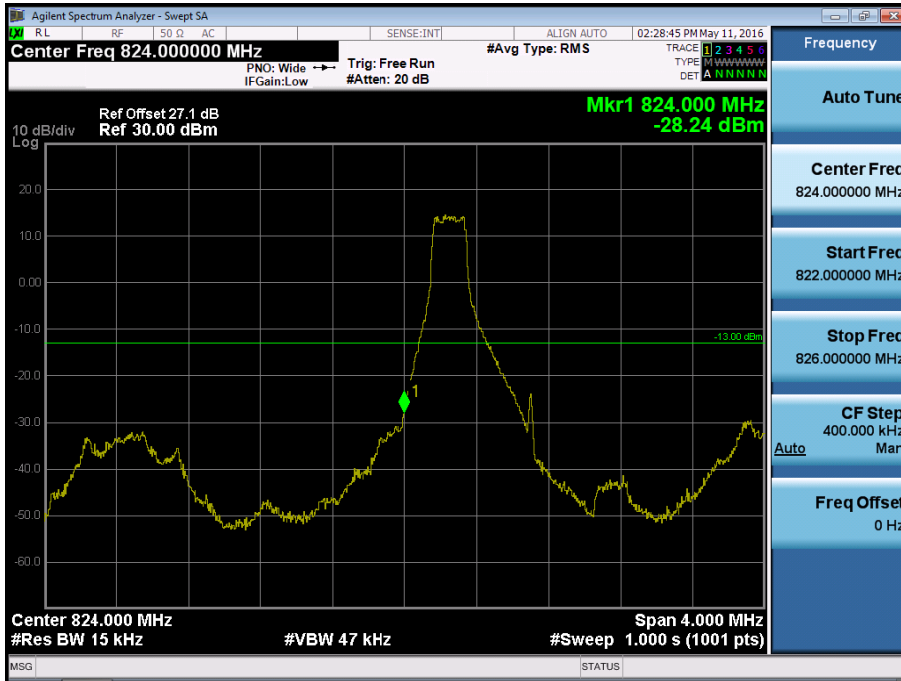

BAND 5. Lower Band Edge Plot (1.4M BW Ch.20407 QPSK_RB6_Offset 0)

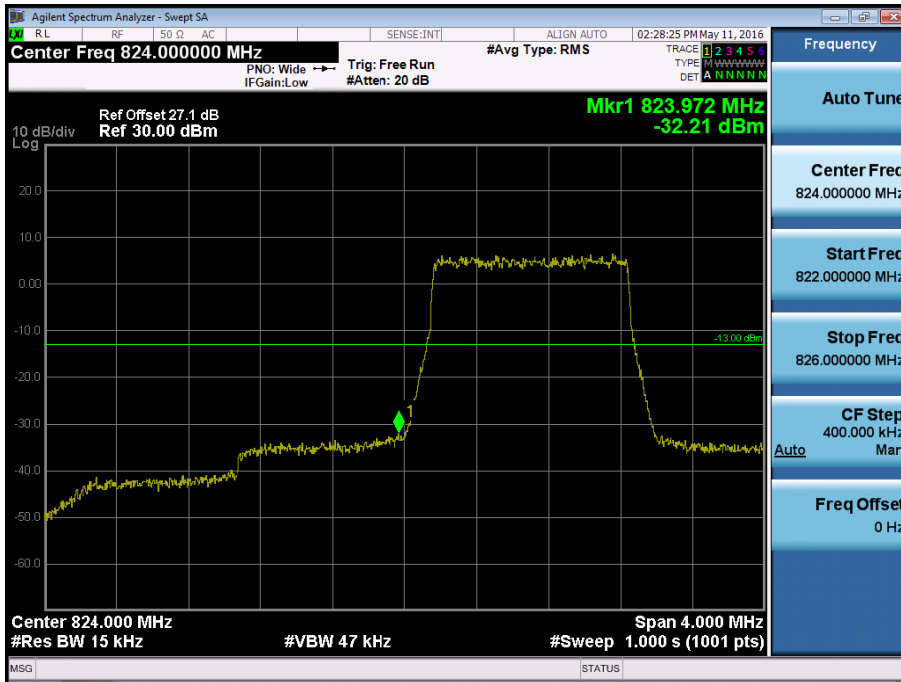

BAND 5. Lower Extended Band Edge Plot (1.4M BW Ch.20407 QPSK_RB6_0)

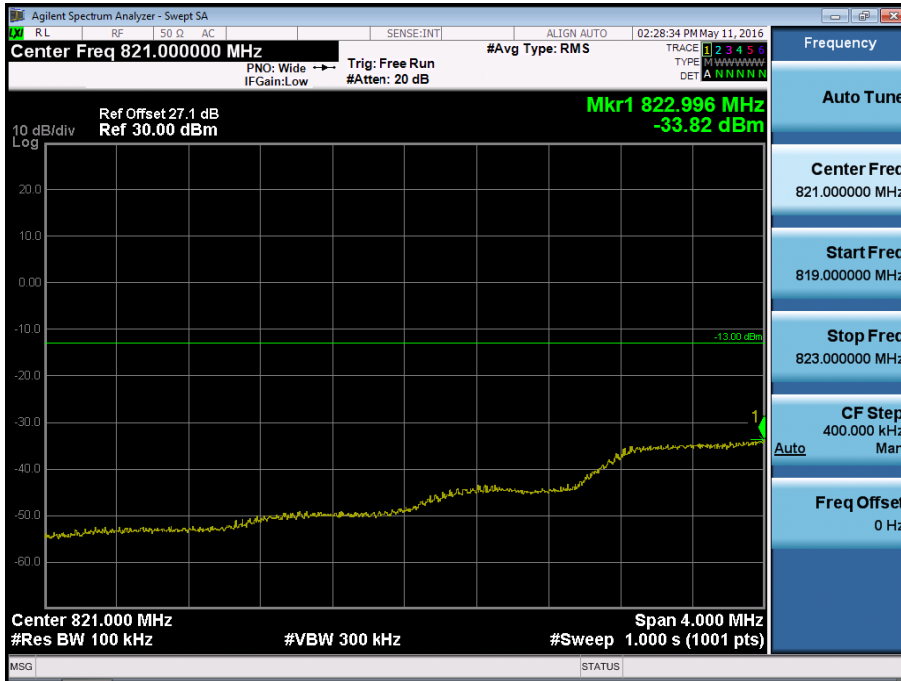

BAND 5. Lower Band Edge Plot (3M BW Ch.20415 QPSK_RB1_Offset 0)

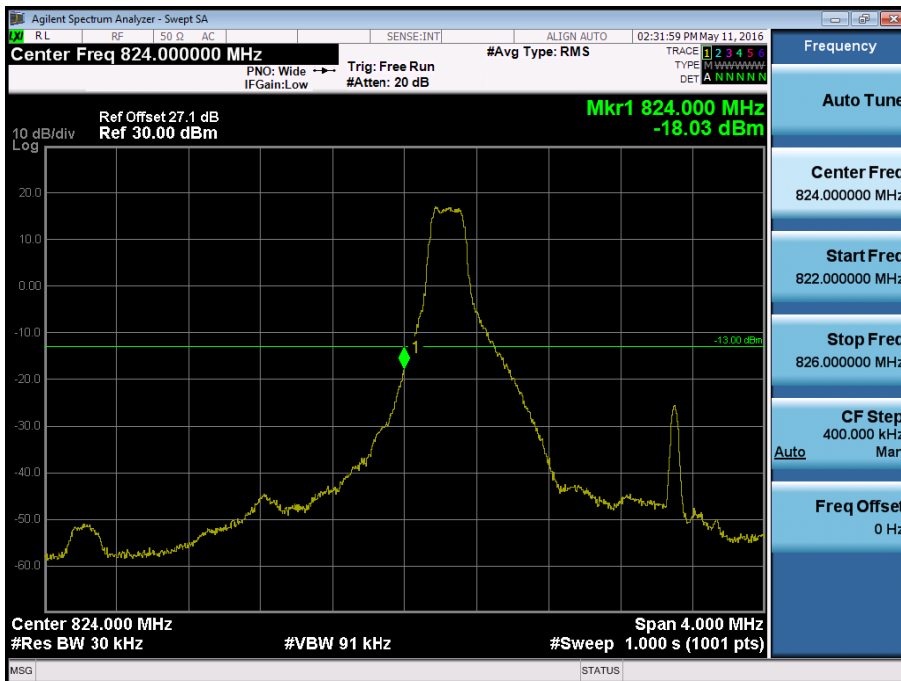

BAND 5. Lower Band Edge Plot (3M BW Ch.20415 QPSK_RB15_Offset 0)

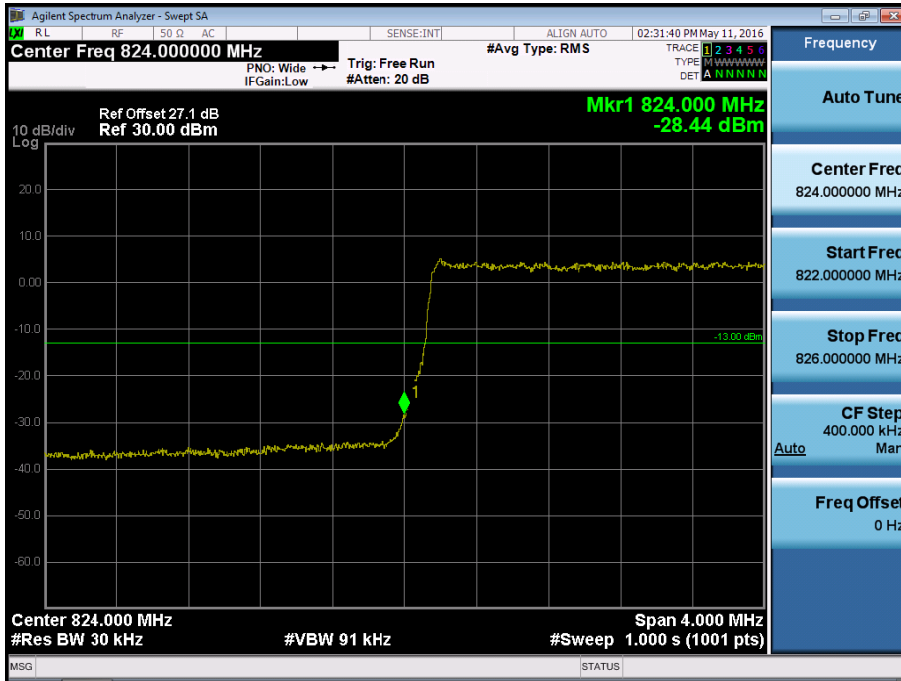

BAND 5. Lower Extended Band Edge Plot (3M BW Ch.20415 QPSK_RB15_0)

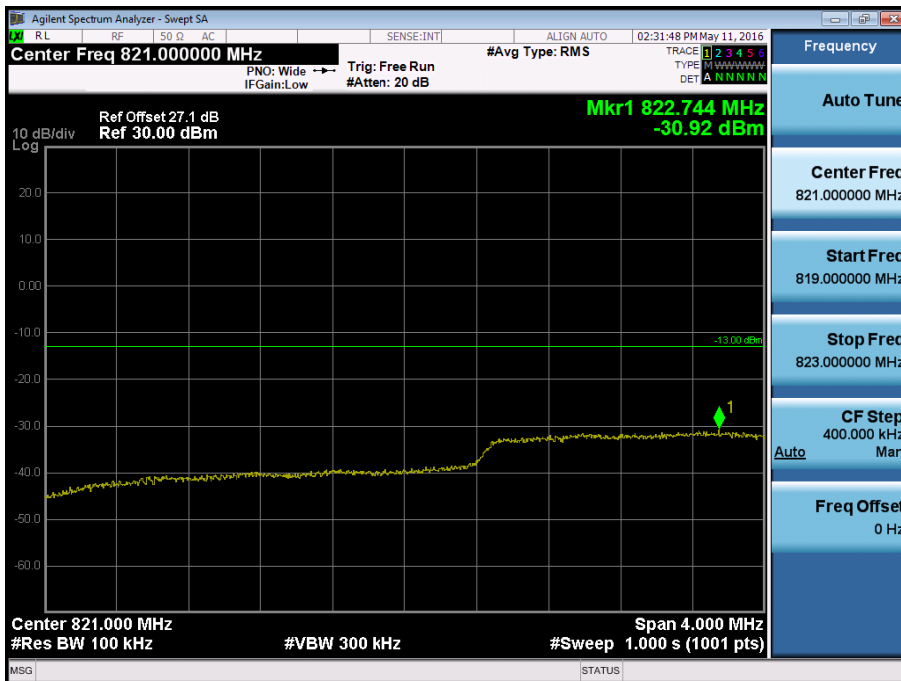

BAND 5. Lower Band Edge Plot (5M BW Ch.20425 QPSK_RB1_Offset 0)

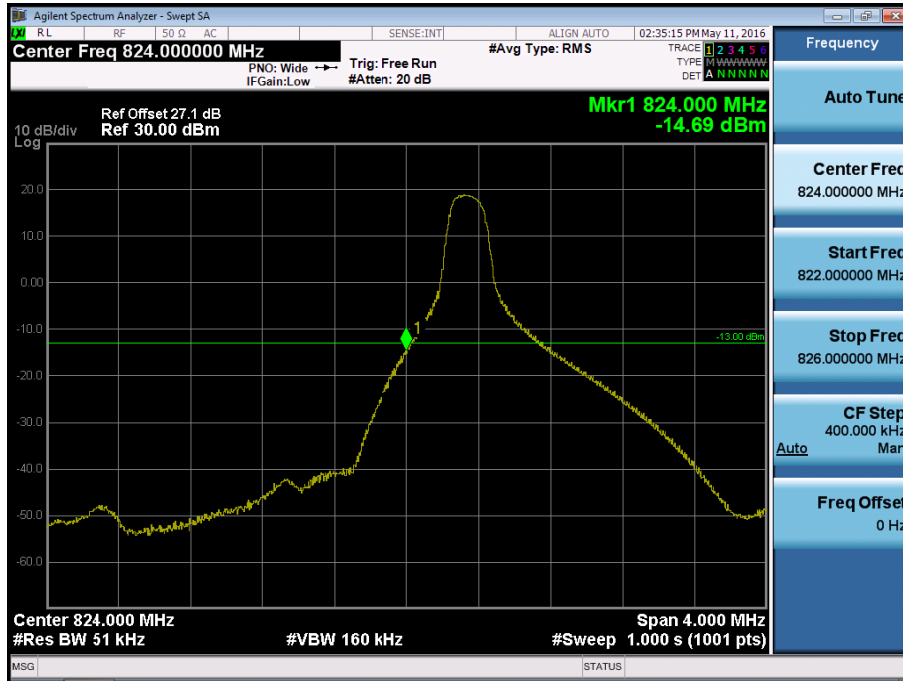

BAND 5. Lower Band Edge Plot (5M BW Ch.20425 QPSK_RB25_Offset 0)

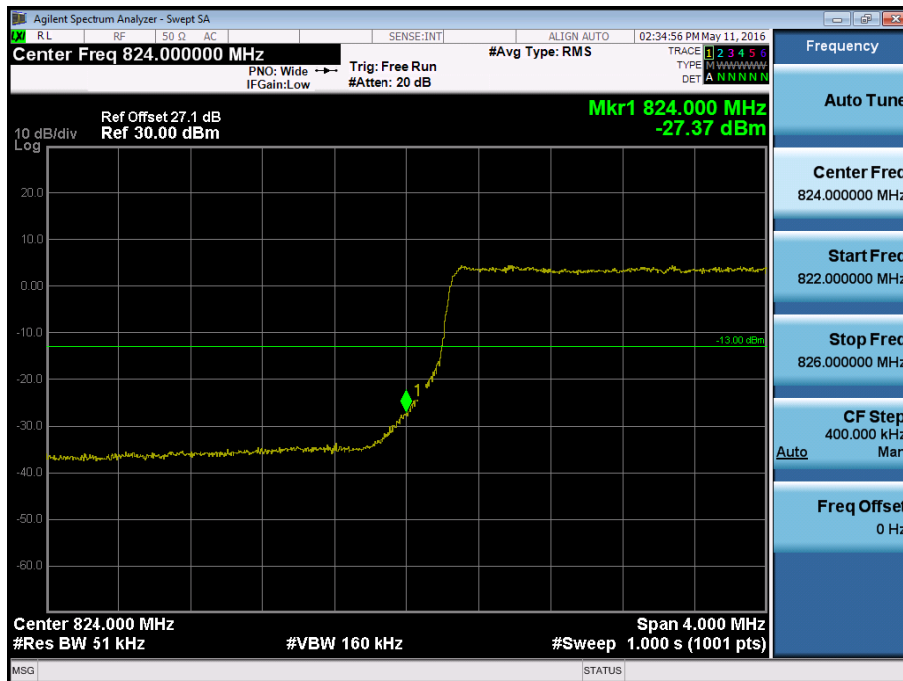

BAND 5. Lower Extended Band Edge Plot (5M BW Ch.20425 QPSK_RB25_0)

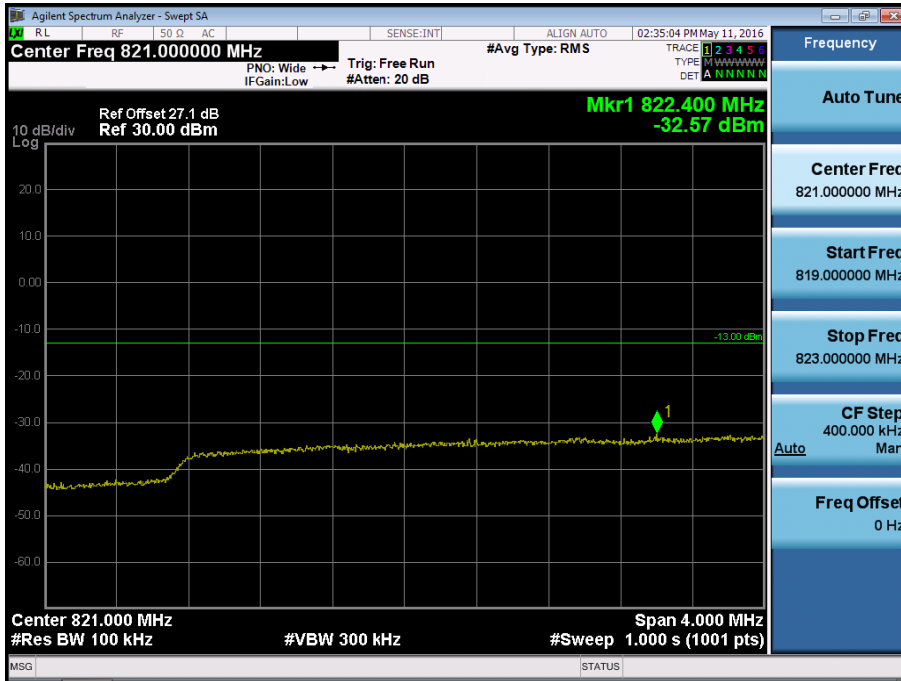

BAND 5. Lower Band Edge Plot (10M BW Ch.20450 QPSK_RB1_Offset 0)

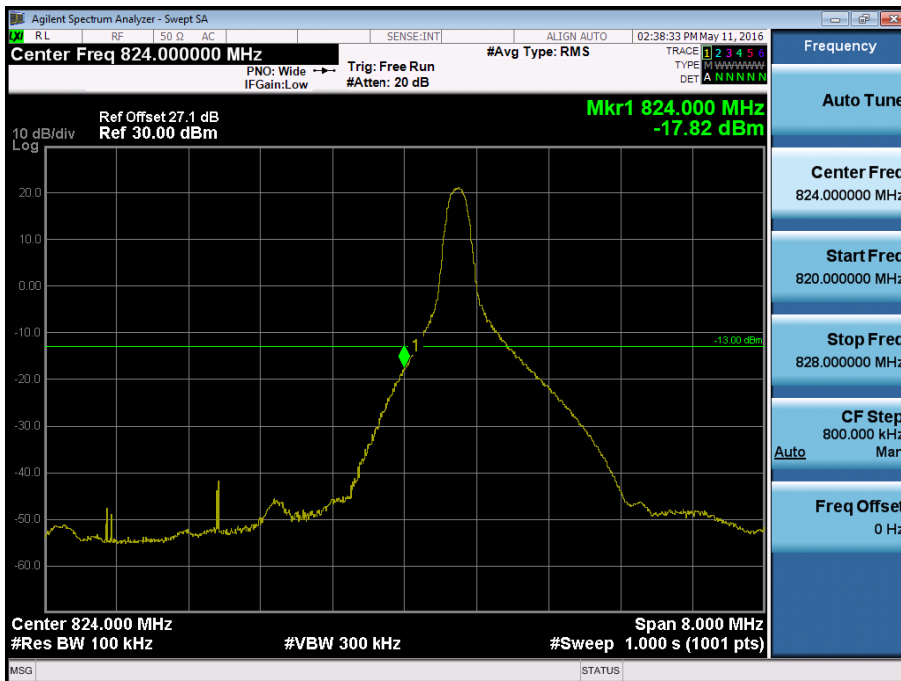

BAND 5. Lower Band Edge Plot (10M BW Ch.20450 QPSK_RB50_Offset 0)

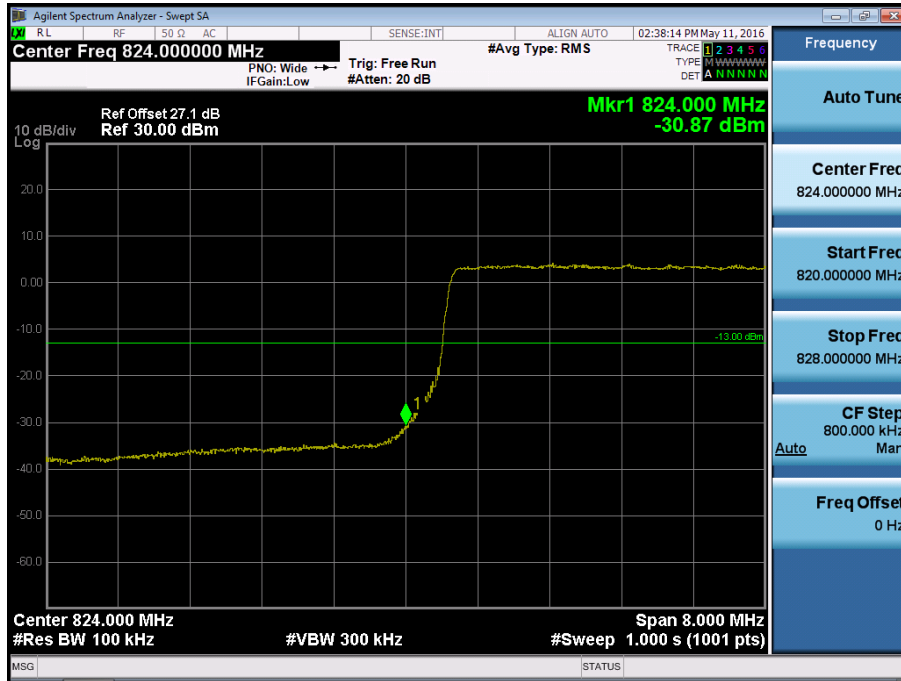

BAND 5. Lower Extended Band Edge Plot (10M BW Ch.20450 QPSK_RB50_0)

