

FCC LTE REPORT

FCC Certification

Applicant Name:
 LG Electronics MobileComm U.S.A., Inc.

Date of Issue:
 June 10, 2016

Address:
 1000 Sylvan Avenue, Englewood Cliffs NJ 07632

Location:
 HCT CO., LTD.,
 74, Seoicheon-ro 578beon-gil, Majang-myeon,
 Icheon-si, Gyeonggi-do, 17383, Rep. of KOREA

Report No.: HCT-R-1605-F050-1
HCT FRN: 0005866421

FCC ID: ZNFK220AR

APPLICANT: LG Electronics MobileComm U.S.A., Inc.

According to the Evaluation report, all of the data contained herein is reused from the reference FCC ID: ZNFK220H report.

FCC Model(s): LG-K220AR
Additional FCC Model(s): LGK220AR, K220AR, LG-K220F, LGK220F, K220F
EUT Type: GSM WCDMA LTE Phone with BT & WLAN
FCC Classification: Licensed Portable Transmitter Held to Ear (PCE)
FCC Rule Part(s): §27, §2

Mode (MHz)	Tx Frequency (MHz)	Emission Designator	Modulation	EIRP	
				Max. Power (W)	Max. Power (dBm)
LTE – Band7 (5)	2502.5 – 2567.5	4M53G7D	QPSK	0.140	21.45
		4M51W7D	16QAM	0.114	20.58
LTE – Band7 (10)	2505.0 – 2565.0	8M98G7D	QPSK	0.123	20.91
		8M98W7D	16QAM	0.107	20.30
LTE – Band7 (15)	2507.5 – 2562.5	13M5G7D	QPSK	0.134	21.27
		13M5W7D	16QAM	0.111	20.45
LTE – Band7 (20)	2510.0 – 2560.0	18M0G7D	QPSK	0.130	21.13
		17M9W7D	16QAM	0.104	20.19

The measurements shown in this report were made in accordance with the procedures specified in CFR47 section §2.947. I assume full responsibility for the accuracy and completeness of these measurements, and for the qualifications of all persons taking them.

HCT CO., LTD. Certifies that no party to this application has subject to a denial of Federal benefits that includes FCC benefits pursuant to section 5301 of the Anti-Drug Abuse Act of 1998,21 U.S. C.853(a)



Report prepared by
: Jeong Ho Kim
Test engineer of RF Team



Approved by
: Kyoung Houn Seo
Manager of RF Team

This report only responds to the tested sample and may not be reproduced, except in full, without written approval of the HCT Co., Ltd.

Version

TEST REPORT NO.	DATE	DESCRIPTION
HCT-R-1605-F050	May 24, 2016	- First Approval Report
HCT-R-1605-F050-1	June 10, 2016	- Revised the Cover Page

Table of Contents

- 1. GENERAL INFORMATION 4
- 2. INTRODUCTION 5
 - 2.1. EUT DESCRIPTION..... 5
 - 2.2. MEASURING INSTRUMENT CALIBRATION..... 5
 - 2.3. TEST FACILITY 5
- 3. DESCRIPTION OF TESTS 6
 - 3.1 EIRP RADIATED POWER AND RADIATED SPURIOUS EMISSIONS 6
 - 3.2 OCCUPIED BANDWIDTH. 7
 - 3.3 SPURIOUS AND HARMONIC EMISSIONS AT ANTENNA TERMINAL..... 8
 - 3.4 FREQUENCY STABILITY / VARIATION OF AMBIENT TEMPERATURE 9
- 4. LIST OF TEST EQUIPMENT 10
- 5. MEASUREMENT UNCERTAINTY 11
- 6. SUMMARY OF TEST RESULTS 12
- 7. SAMPLE CALCULATION 13
- 8. TEST DATA 14
 - 8.1 EQUIVALENT ISOTROPIC RADIATED POWER (Band 7) 14
 - 8.2 RADIATED SPURIOUS EMISSIONS 16
 - 8.2.1 RADIATED SPURIOUS EMISSIONS (5 MHz Band 7 LTE) 16
 - 8.2.2 RADIATED SPURIOUS EMISSIONS (10 MHz Band 7 LTE) 17
 - 8.2.3 RADIATED SPURIOUS EMISSIONS (15 MHz Band 7 LTE) 18
 - 8.2.4 RADIATED SPURIOUS EMISSIONS (20 MHz Band 7 LTE) 19
 - 8.3 OCCUPIED BANDWIDTH 20
 - 8.4 CONDUCTED SPURIOUS EMISSIONS 21
 - 8.4.1 BAND EDGE..... 22
 - 8.5 FREQUENCY STABILITY / VARIATION OF AMBIENT TEMPERATURE 23
 - 8.5.1 FREQUENCY STABILITY (5 MHz Band 7 LTE) 23
 - 8.5.2 FREQUENCY STABILITY (10 MHz Band 7 LTE) 24
 - 8.5.3 FREQUENCY STABILITY (15 MHz Band 7 LTE) 25
 - 8.5.4 FREQUENCY STABILITY (20 MHz Band 7 LTE) 26
- 9. TEST PLOTS..... 27

MEASUREMENT REPORT

1. GENERAL INFORMATION

Applicant Name: LG Electronics MobileComm U.S.A., Inc.

Address: 1000 Sylvan Avenue, Englewood Cliffs NJ 07632

FCC ID: ZNFK220AR

Application Type: Certification

FCC Classification: Licensed Portable Transmitter Held to Ear (PCE)

FCC Rule Part(s): §2 , §27

EUT Type: GSM WCDMA LTE Phone with BT & WLAN

FCC Model(s): LG-K220AR

Additional FCC Model(s): LGK220AR, K220AR, LG-K220F, LGK220F, K220F

Tx Frequency: 2502.5 MHz – 2567.5 MHz (LTE – Band 7): 5 MHz
2505.0 MHz – 2565.0 MHz (LTE – Band 7): 10 MHz
2507.5 MHz – 2562.5 MHz (LTE – Band 7): 15 MHz
2510.0 MHz – 2560.0 MHz (LTE – Band 7): 20 MHz

Max. RF Output Power:

Band 7 (5 MHz) :	0.140 W (QPSK) (21.45 dBm)
	0.114 W (16-QAM) (20.58 dBm)
Band 7 (10 MHz) :	0.123 W (QPSK) (20.91 dBm)
	0.107 W (16-QAM) (20.30 dBm)
Band 7 (15 MHz) :	0.134 W (QPSK) (21.27 dBm)
	0.111 W (16-QAM) (20.45 dBm)
Band 7 (20 MHz) :	0.130 W (QPSK) (21.13 dBm)
	0.104 W (16-QAM) (20.19 dBm)

Emission Designator(s):

Band 7 (5 MHz) :	4M53G7D (QPSK) / 4M51W7D (16-QAM)
Band 7 (10 MHz) :	8M98G7D (QPSK) / 8M98W7D (16-QAM)
Band 7 (15 MHz) :	13M5G7D (QPSK) / 13M5W7D (16-QAM)
Band 7 (20 MHz) :	18M0G7D (QPSK) / 17M9W7D (16-QAM)

Date(s) of Tests: April 20, 2016 ~ May 19, 2016

Antenna Specification:

Manufacturer:	LS Mtron Co., Ltd.
Antenna type:	PIFA Antenna (Planar Inverted F)
Peak Gain:	Band 7: -3.17 dBi

2. INTRODUCTION

2.1. EUT DESCRIPTION

The LG Electronics MobileComm U.S.A., Inc. LG-K220AR GSM WCDMA LTE Phone with BT & WLAN consists of LTE 7.

2.2. MEASURING INSTRUMENT CALIBRATION

The measuring equipment, which was utilized in performing the tests documented herein, has been calibrated in accordance with the manufacturer's recommendations for utilizing calibration equipment, which is traceable to recognized national standards.

2.3. TEST FACILITY

The Fully-anechoic chamber and conducted measurement facility used to collect the radiated data are located at the **74, Seoicheon-ro 578beon-gil, Majang-myeon, Icheon-si, Gyeonggi-do, 17383, Rep. of KOREA.**

3. DESCRIPTION OF TESTS

3.1 EIRP RADIATED POWER AND RADIATED SPURIOUS EMISSIONS

Note: EIRP(Equivalent Isotropic Radiated Power)

Test Procedure

Radiated emission measurements are performed in the Fully-anechoic chamber. The equipment under test is placed on a non-conductive table 3-meters away from the receive antenna in accordance with ANSI/TIA-603-D-2010 Clause 2.2.17. The turntable is rotated through 360 degrees, and the receiving antenna scans in order to determine the level of the maximized emission. The level and position of the maximized emission is recorded with the spectrum analyzer using RMS detector.

A half wave dipole is then substituted in place of the EUT. For emissions above 1GHz, a horn antenna is substituted in place of the EUT. The substitute antenna is driven by a signal generator and the previously recorded signal was duplicated.

The power is calculated by the following formula;

$$P_{d(dBm)} = P_{g(dBm)} - \text{cable loss}_{(dB)} + \text{antenna gain}_{(dB)}$$

Where: P_d is the dipole equivalent power and P_g is the generator output power into the substitution antenna.

The maximum EIRP is calculated by adding the forward power to the calibrated source plus its appropriate gain value. These steps are repeated with the receiving antenna in both vertical and horizontal polarization. the difference between the gain of the horn and an isotropic antenna are taken into consideration

Radiated spurious emissions

1. Frequency Range : 30 MHz ~ 10th Harmonics of highest channel fundamental frequency.
2. Measured distance : 30 MHz ~ 11 GHz at 3 m
11 GHz ~ 26 GHz at 1m
3. The EUT was setup to maximum output power. The 100 kHz RBW was used to scan from 30 MHz to 1 GHz. Also, the 1 MHz RBW was used to scan from 1 GHz to 26.5 GHz. And limit is -25 dBm. The high, low and a middle channel were tested for out of band measurements.

3.2 OCCUPIED BANDWIDTH.

Test set-up

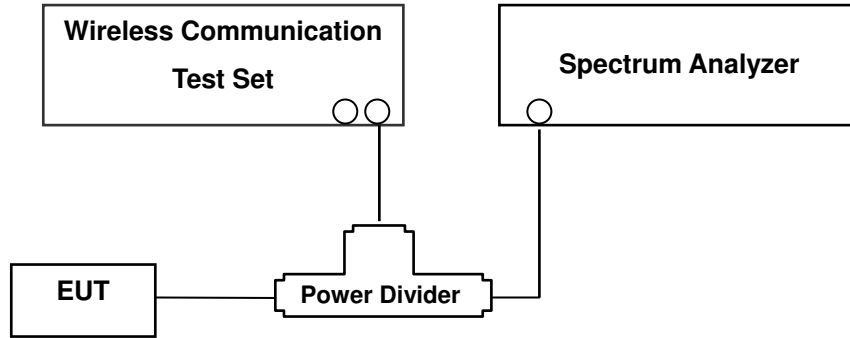

(Configuration of conducted Emission measurement)

The width of a frequency band such that, below the lower and above the upper frequency limits, the mean powers emitted are each equal to a specified percentage 0.5 % of the total mean power of a given emission.

Test Procedure

OBW is tested in accordance with KDB971168 D01 Power Meas License Digital Systems v02r02, October 17, 2014, Section 4.2.

The EUT makes a call to the communication simulator. The power was measured with R&S Spectrum Analyzer. All measurements were done at 3 channels(low, middle and high operational range.)

The conducted occupied bandwidth used the power splitter via EUT RF power connector between simulation base station and spectrum analyzer.

The communication simulator station system controlled a EUT to export maximum output power under transmission mode and specific channel frequency. Use OBW measurement function of Spectrum analyzer to measure 99 % occupied bandwidth

3.3 SPURIOUS AND HARMONIC EMISSIONS AT ANTENNA TERMINAL.

Test Procedure

Spurious and harmonic emissions at antenna terminal is tested in accordance with KDB971168 D01 Power Meas License Digital Systems v02r02, October 17, 2014, Section 6.0.

The level of the carrier and the various conducted spurious and harmonic frequencies is measured by means of a calibrated spectrum analyzer.

The EUT was setup to maximum output power. The 1 MHz RBW was used to scan from 30 MHz to 26.5 GHz. And limit is -25 dBm. The high, low and a middle channel were tested for out of band measurements.

- Channel Edge Requirement : In the 1 MHz bands immediately outside and adjacent to the channel, a resolution bandwidth of at least 1 percent of the emission bandwidth of the fundamental emission of the transmitter may be employed to measure the out of band Emissions.

NOTES: The analyzer plot offsets were determined by below conditions.

- For LTE Band 7, total offset 27.6 dBm = 20 dBm attenuator + 6 dBm Divider + 1.6 dBm RF cables.

3.4 FREQUENCY STABILITY / VARIATION OF AMBIENT TEMPERATURE

Test Set-up

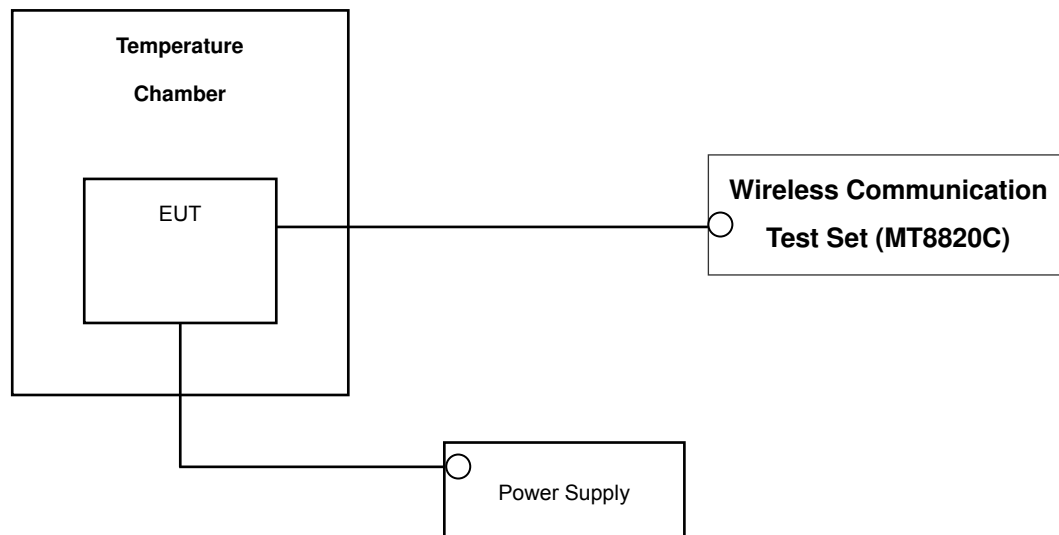

* Nominal Operating Voltage

Test Procedure

Frequency stability is tested in accordance with ANSI/TIA-603-D-2010 section 2.2.2.

The frequency stability of the transmitter is measured by:

- a.) **Temperature:** The temperature is varied from - 30 °C to + 50 °C using an environmental chamber.
- b.) **Primary Supply Voltage:** The primary supply voltage is varied from battery end point to 100 % of the voltage normally at the input to the device or at the power supply terminals if cables are not normally supplied.

Specification — the frequency stability shall be sufficient to ensure that the fundamental emission stays within the authorized frequency block .

Time Period and Procedure:

The carrier frequency of the transmitter is measured at room temperature (20°C to provide a reference).

1. The equipment is turned on in a "standby" condition for one minute before applying power to the transmitter. Measurement of the carrier frequency of the transmitter is made within one minute after applying power to the transmitter.
2. Frequency measurements are made at 10°C intervals ranging from -30°C to +50°C. A period of at least one half-hour is provided to allow stabilization of the equipment at each temperature level.

NOTE: The EUT is tested down to the battery endpoint.

4. LIST OF TEST EQUIPMENT

Manufacture	Model/ Equipment	Serial Number	Calibration Interval	Calibration Due
MITEQ	AMF-6D-001180-35-20P/AMP	1081666	Annual	09/03/2016
Wainwright	WHK1.2/15G-10EF/H.P.F	4	Annual	04/11/2017
Wainwright	WHK3.3/18G-10EF/H.P.F	2	Annual	04/11/2017
Hewlett Packard	11667B / Power Splitter	10545	Annual	02/15/2017
Hewlett Packard	11667B / Power Splitter	11275	Annual	04/29/2017
ITECH	IT6720/ Power Supply	0100215626700119	Annual	11/02/2016
Schwarzbeck	UHAP/ Dipole Antenna	557	Biennial	03/23/2017
Schwarzbeck	UHAP/ Dipole Antenna	558	Biennial	03/23/2017
EXP	EX-TH400/ Chamber	None	Annual	05/29/2016
Schwarzbeck	BBHA 9120D/ Horn Antenna	147	Biennial	09/01/2016
Schwarzbeck	BBHA 9120D/ Horn Antenna	1299	Biennial	05/15/2017
Schwarzbeck	BBHA 9170/ Horn Antenna(15~40GHz)	BBHA9170342	Biennial	04/30/2017
Schwarzbeck	BBHA 9170/ Horn Antenna(15~35GHz)	BBHA9170124	Biennial	04/30/2017
Agilent	N9020A/Signal Analyzer	MY52090906	Annual	05/13/2017
Hewlett Packard	8493C/ATTENUATOR	17280	Annual	06/29/2016
REOHDE&SCHWARZ	FSV40/Spectrum Analyzer	1307.9002K40-100931-NK	Annual	06/04/2016
Agilent	8960 (E5515C)/ Base Station	MY48360800	Annual	10/30/2016
Anritsu Corp.	MT8820C/Wideband Radio Communication Tester	6200863156	Annual	02/26/2017
Anritsu Corp.	MT8820C/Wideband Radio Communication Tester	6201026545	Annual	02/16/2017
Schwarzbeck	VULB9160/ Bilog Antenna	3150	Biennial	11/17/2016
Schwarzbeck	VULB9160/ Bilog Antenna	3368	Biennial	10/10/2016

5. MEASUREMENT UNCERTAINTY

The measurement uncertainties shown below were calculated in accordance with the requirements of ANSI C63.4:2014.

All measurement uncertainty values are shown with a coverage factor of $k = 2$ to indicate a 95 % level of confidence. The measurement data shown herein meets or exceeds the U_{CISPR} measurement uncertainty values specified in CISPR 16-4-2 and, thus, can be compared directly to specified limits to determine compliance.

Parameter	Expanded Uncertainty (\pm dB)
Conducted Disturbance (150 kHz ~ 30 MHz)	1.82
Radiated Disturbance (9 kHz ~ 30 MHz)	3.40
Radiated Disturbance (30 MHz ~ 1 GHz)	4.80
Radiated Disturbance (1 GHz ~ 18 GHz)	6.07

6. SUMMARY OF TEST RESULTS

FCC Part Section(s)	Test Description	Test Limit	Test Condition	Test Result
2.1049	Occupied Bandwidth	N/A	CONDUCTED	PASS
2.1051, 27.53(m)(4)	Band Edge / Conducted Spurious Emissions.	< 40 + 10log10 (P[Watts]) at Channel edges < 43 + 10log10 (P[Watts]) between 5 and X MHz from Channel edges < 55 + 10log10 (P[Watts]) beyond X MHz beyond from Channel edges		PASS
* 2.1046	Conducted Output Power	N/A		PASS
2.1055, 27.54	Frequency stability	Emission must remain in band		PASS
27.50(h)(2)	Equivalent Isotropic Radiated Power	< 2 Watts max. EIRP	RADIATED	PASS
2.1053, 27.53(m)(4)	Undesirable Emissions	< 40 + 10log10 (P[Watts]) at Channel edges < 43 + 10log10 (P[Watts]) between 5 and X MHz from Channel edges < 55 + 10log10 (P[Watts]) beyond X MHz beyond from Channel edges		PASS

*See SAR Report

7. SAMPLE CALCULATION

A. EIRP Sample Calculation

Mode	Ch./ Freq.		Measured Level(dBm)	Substitute LEVEL(dBm)	Ant. Gain (dBi)	C.L	Pol.	Limit W	EIRP	
	channel	Freq.(MHz)							W	dBm
LTE Band7	21100	2,535.00	-15.36	19.46	10.72	1.78	V	< 2.00	0.69	28.40

EIRP = Substitute LEVEL(dBm) + Ant. Gain – CL(Cable Loss)

- 1) The EUT mounted on a wooden tripod is 2.5 meter above test site ground level.
- 2) During the test , the turn table is rotated until the maximum signal is found.
- 3) Record the field strength meter's level.
- 4) Replace the EUT with dipole/Horn antenna that is connected to a calibrated signal generator.
- 5) Increase the signal generator output till the field strength meter's level is equal to the item (3).
- 6) The signal generator output level with Ant. Gain and cable loss are the rating of Equivalent Isotropic Radiated Power (**EIRP**).

B. Emission Designator

QPSK Modulation

Emission Designator = 4M48G7D

LTE BW = 4.48 MHz

G = Phase Modulation

7 = Quantized/Digital Info

D = Data transmission; telemetry; telecommand

16QAM Modulation

Emission Designator = 4M48W7D

LTE BW = 4.48 MHz

W = main carrier modulated in a combination of two

or more of the following modes;

amplitude, angle, pulse

7 = Quantized/Digital Info

D = Data transmission; telemetry; telecommand

8. TEST DATA

8.1 EQUIVALENT ISOTROPIC RADIATED POWER (Band 7)

Freq (MHz)	Bandwidth	Modulation	Measured Level (dBm)	Substitute Level (dBm)	Ant. Gain(dBi)	C.L	Pol	Limit	EIRP	
								W	W	dBm
2502.5	5 MHz	QPSK	-23.70	12.73	10.95	2.87	V	< 2.00	0.121	20.81
		16-QAM	-24.54	11.89	10.95	2.87	V		0.099	19.97
2535.0		QPSK	-23.64	12.85	10.98	2.95	V		0.123	20.88
		16-QAM	-24.51	11.98	10.98	2.95	V		0.100	20.01
2567.5		QPSK	-23.36	13.42	11.00	2.97	V		0.140	21.45
		16-QAM	-24.23	12.55	11.00	2.97	V		0.114	20.58

Equivalent Isotropic Radiated Power Data (5 MHz Band 7 LTE)

Note: All of RB size has been tested for emissions and EIRP, with the 1RB configuration observed as the worst case

Freq (MHz)	Bandwidth	Modulation	Measured Level (dBm)	Substitute Level (dBm)	Ant. Gain(dBi)	C.L	Pol	Limit	EIRP	
								W	W	dBm
2505.0	10 MHz	QPSK	-23.70	12.70	10.95	2.88	V	< 2.00	0.120	20.77
		16-QAM	-24.59	11.81	10.95	2.88	V		0.097	19.88
2535.0		QPSK	-23.67	12.82	10.98	2.95	V		0.122	20.85
		16-QAM	-24.52	11.97	10.98	2.95	V		0.100	20.00
2565.0		QPSK	-23.90	12.88	11.00	2.97	V		0.123	20.91
		16-QAM	-24.51	12.27	11.00	2.97	V		0.107	20.30

Equivalent Isotropic Radiated Power Data (10 MHz Band 7 LTE)

Note: All of RB size has been tested for emissions and EIRP, with the 1RB configuration observed as the worst case

Freq (MHz)	Bandwidth	Modulation	Measured Level (dBm)	Substitute Level (dBm)	Ant. Gain(dBi)	C.L	Pol	Limit	EIRP	
								W	W	dBm
2507.5	15 MHz	QPSK	-23.72	12.59	10.96	2.89	V	< 2.00	0.116	20.66
		16-QAM	-24.63	11.68	10.96	2.89	V		0.094	19.75
2535.0		QPSK	-23.66	12.83	10.98	2.95	V		0.122	20.86
		16-QAM	-24.53	11.96	10.98	2.95	V		0.100	19.99
2562.5		QPSK	-23.57	13.24	11.00	2.97	V		0.134	21.27
		16-QAM	-24.39	12.42	11.00	2.97	V		0.111	20.45

Equivalent Isotropic Radiated Power Data (15 MHz Band 7 LTE)

Note: All of RB size has been tested for emissions and EIRP, with the 1RB configuration observed as the worst case

Freq (MHz)	Bandwidth	Modulation	Measured Level (dBm)	Substitute Level (dBm)	Ant. Gain(dBi)	C.L	Pol	Limit	EIRP	
								W	W	dBm
2510.0	20 MHz	QPSK	-23.71	12.66	10.96	2.89	V	< 2.00	0.118	20.73
		16-QAM	-24.57	11.80	10.96	2.89	V		0.097	19.87
2535.0		QPSK	-23.70	12.79	10.98	2.95	V		0.121	20.82
		16-QAM	-24.55	11.94	10.98	2.95	V		0.099	19.97
2560.0		QPSK	-23.71	13.10	11.00	2.97	V		0.130	21.13
		16-QAM	-24.65	12.16	11.00	2.97	V		0.104	20.19

Equivalent Isotropic Radiated Power Data (20 MHz Band 7 LTE)

Note: All of RB size has been tested for emissions and EIRP, with the 1RB configuration observed as the worst case

NOTES:

Equivalent Isotropic Radiated Power Measurements by Substitution Method

according to ANSI/TIA/EIA-603-D-2010 June 24, 2010:

The EUT was placed on a non-conductive styrofoam resin table 3-meters from the receive antenna. The receive antenna height and turntable rotation was adjusted for the highest reading on the receive spectrum analyzer. For 5 MHz, 10MHz BW signals, RBW = 1-5% of the OBW, not to exceed 1MHz, VBW ≥ 3 x RBW, Detector = RMS. A Horn antenna was substituted in place of the EUT. This dipole antenna was driven by a signal generator and the level of the signal generator was adjusted to obtain the same receive spectrum analyzer reading. The conducted power at the terminals of the Horn antenna is measured. The difference between the gain of the horn and an isotropic antenna is taken into consideration and the EIRP is recorded.

Also, we have done x, y, z planes in EUT and horizontal and vertical polarization in detecting antenna. The worst case of the EUT is z plane in LTE mode. Also worst case of detecting Antenna is vertical polarization in LTE mode.

8.2 RADIATED SPURIOUS EMISSIONS

8.2.1 RADIATED SPURIOUS EMISSIONS (5 MHz Band 7 LTE)

- ▣ OPERATING FREQUENCY : 2567.50 MHz
- ▣ MEASURED OUTPUT POWER: 21.45 dBm = 0.140 W
- ▣ MODULATION SIGNAL: 5 MHz QPSK
- ▣ DISTANCE: 3 meters
- ▣ LIMIT: $55 + 10 \log_{10}(W) =$ 46.45 dBc

Ch	Freq (MHz)	Measured Level (dBm)	Ant. Gain (dBi)	Substitute Level (dBm)	C.L	Pol	EIRP (dBm)	dBc
20775 (2502.5)	5,005.00	-51.41	12.57	-45.13	4.49	V	-37.05	58.50
	7,507.50	-57.60	11.70	-41.24	5.69	H	-35.23	56.68
	10,010.00	-58.95	11.01	-34.63	6.84	H	-30.46	51.91
21100 (2535.0)	5,070.00	-51.94	12.67	-45.19	4.56	V	-37.08	58.53
	7,605.00	-57.01	11.63	-40.48	5.67	H	-34.52	55.97
	10,140.00	-61.38	10.94	-38.66	6.66	H	-34.38	55.83
21425 (2567.5)	5,135.00	-50.04	12.76	-42.57	4.57	V	-34.37	55.82
	7,702.50	-56.76	11.56	-39.91	5.84	H	-34.19	55.64
	10,270.00	-59.86	10.87	-36.99	6.78	H	-32.90	54.35

- NOTES:**
1. Radiated Spurious Emission Measurements at 1 meter and 3 meter by Substitution Method according to ANSI/TIA/EIA-603-D-2010 June 24, 2010:
 2. We are performed all frequency to 10th harmonics from 30 MHz. Measurements above show only up to 3 maximum emissions noted, or would be lesser if no specific emissions from the EUT are recorded (ie: margin > 20 dB from the applicable limit) and considered that's already beyond the background noise floor.
 3. We have done x, y, z planes in EUT and horizontal and vertical polarization in detecting antenna.
 4. All of RB size has been tested for emissions and EIRP, with the 1RB configuration observed as the worst case
 5. We are performed 16QAM and QPSK modulations. The worst case data are reported in the table above.

8.2.2 RADIATED SPURIOUS EMISSIONS (10 MHz Band 7 LTE)

- ▣ OPERATING FREQUENCY : 2565.00 MHz
- ▣ MEASURED OUTPUT POWER: 20.91 dBm = 0.123 W
- ▣ MODULATION SIGNAL: 10 MHz QPSK
- ▣ DISTANCE: 3 meters
- ▣ LIMIT: $55 + 10 \log_{10}(W) =$ 45.91 dBc

Ch	Freq (MHz)	Measured Level (dBm)	Ant. Gain (dBi)	Substitute Level (dBm)	C.L	Pol	EIRP (dBm)	dBc
20800 (2505.0)	5,010.00	-51.71	12.58	-45.19	4.48	V	-37.09	58.00
	7,515.00	-57.73	11.70	-41.46	5.69	H	-35.45	56.36
	10,020.00	-59.22	11.01	-34.87	7.01	H	-30.87	51.78
21100 (2535.0)	5,070.00	-51.25	12.67	-44.50	4.56	V	-36.39	57.30
	7,605.00	-57.03	11.63	-40.50	5.67	H	-34.54	55.45
	10,140.00	-60.29	10.94	-37.57	6.66	H	-33.29	54.20
21400 (2565.0)	5,130.00	-51.14	12.76	-43.83	4.52	V	-35.59	56.50
	7,695.00	-57.42	11.57	-40.69	5.77	H	-34.88	55.79
	10,260.00	-60.73	10.87	-37.46	6.74	H	-33.33	54.24

- NOTES:**
1. Radiated Spurious Emission Measurements at 1 meter and 3 meter by Substitution Method according to ANSI/TIA/EIA-603-D-2010 June 24, 2010:
 2. We are performed all frequency to 10th harmonics from 30 MHz. Measurements above show only up to 3 maximum emissions noted, or would be lesser if no specific emissions from the EUT are recorded (ie: margin > 20 dB from the applicable limit) and considered that's already beyond the background noise floor.
 3. We have done x, y, z planes in EUT and horizontal and vertical polarization in detecting antenna.
 4. All of RB size has been tested for emissions and EIRP, with the 1RB configuration observed as the worst case
 5. We are performed 16QAM and QPSK modulations. The worst case data are reported in the table above.

8.2.3 RADIATED SPURIOUS EMISSIONS (15 MHz Band 7 LTE)

- ▣ OPERATING FREQUENCY : 2562.50 MHz
- ▣ MEASURED OUTPUT POWER: 21.27 dBm = 0.134 W
- ▣ MODULATION SIGNAL: 15 MHz QPSK
- ▣ DISTANCE: 3 meters
- ▣ LIMIT: $55 + 10 \log_{10}(W) =$ 46.27 dBc

Ch	Freq (MHz)	Measured Level (dBm)	Ant. Gain (dBi)	Substitute Level (dBm)	C.L	Pol	EIRP (dBm)	dBc
20825 (2507.5)	5,015.00	-51.96	12.59	-45.58	4.48	V	-37.47	58.74
	7,522.50	-57.72	11.70	-41.53	5.70	H	-35.53	56.80
	10,030.00	-60.80	11.00	-36.58	7.01	H	-32.59	53.86
21100 (2535.0)	5,070.00	-51.24	12.67	-44.49	4.56	V	-36.38	57.65
	7,605.00	-56.96	11.63	-40.43	5.67	H	-34.47	55.74
	10,140.00	-60.76	10.94	-38.04	6.66	H	-33.76	55.03
21375 (2562.5)	5,125.00	-51.88	12.75	-44.58	4.51	V	-36.34	57.61
	7,687.50	-57.47	11.57	-40.87	5.67	H	-34.97	56.24
	10,250.00	-61.34	10.88	-38.15	6.63	H	-33.90	55.17

- NOTES:**
1. Radiated Spurious Emission Measurements at 1 meter and 3 meter by Substitution Method according to ANSI/TIA/EIA-603-D-2010 June 24, 2010:
 2. We are performed all frequency to 10th harmonics from 30 MHz. Measurements above show only up to 3 maximum emissions noted, or would be lesser if no specific emissions from the EUT are recorded (ie: margin > 20 dB from the applicable limit) and considered that's already beyond the background noise floor.
 3. We have done x, y, z planes in EUT and horizontal and vertical polarization in detecting antenna.
 4. All of RB size has been tested for emissions and EIRP, with the 1RB configuration observed as the worst case
 5. We are performed 16QAM and QPSK modulations. The worst case data are reported in the table above.

8.2.4 RADIATED SPURIOUS EMISSIONS (20 MHz Band 7 LTE)

- ▣ OPERATING FREQUENCY : 2560.00 MHz
- ▣ MEASURED OUTPUT POWER: 21.13 dBm = 0.130 W
- ▣ MODULATION SIGNAL: 20 MHz QPSK
- ▣ DISTANCE: 3 meters
- ▣ LIMIT: $55 + 10 \log_{10}(W) =$ 46.13 dBc

Ch	Freq (MHz)	Measured Level (dBm)	Ant. Gain (dBi)	Substitute Level (dBm)	C.L	Pol	EIRP (dBm)	dBc
20850 (2510.0)	5,020.00	-52.71	12.60	-46.48	4.47	V	-38.35	59.48
	7,530.00	-58.82	11.69	-42.37	5.67	H	-36.35	57.48
	10,040.00	-59.51	11.00	-35.89	6.58	H	-31.47	52.60
21100 (2535.0)	5,070.00	-52.94	12.67	-46.19	4.56	V	-38.08	59.21
	7,605.00	-57.79	11.63	-41.26	5.67	H	-35.30	56.43
	10,140.00	-60.83	10.94	-38.11	6.66	H	-33.83	54.96
21350 (2560.0)	5,120.00	-53.02	12.75	-45.74	4.50	V	-37.49	58.62
	7,680.00	-59.31	11.58	-42.66	5.62	H	-36.70	57.83
	10,240.00	-62.87	10.88	-39.32	6.57	H	-35.01	56.14

- NOTES:**
1. Radiated Spurious Emission Measurements at 1 meter and 3 meter by Substitution Method according to ANSI/TIA/EIA-603-D-2010 June 24, 2010:
 2. We are performed all frequency to 10th harmonics from 30 MHz. Measurements above show only up to 3 maximum emissions noted, or would be lesser if no specific emissions from the EUT are recorded (ie: margin > 20 dB from the applicable limit) and considered that's already beyond the background noise floor.
 3. We have done x, y, z planes in EUT and horizontal and vertical polarization in detecting antenna.
 4. All of RB size has been tested for emissions and EIRP, with the 1RB configuration observed as the worst case
 5. We are performed 16QAM and QPSK modulations. The worst case data are reported in the table above.

8.3 OCCUPIED BANDWIDTH

Band	Band Width	Frequency (MHz)	Modulation	Resource Block Size	Resource Block Offset	Data (dB)
7	5 MHz	2535.0	QPSK	25	0	4.5293
			16-QAM	25	0	4.5063
	10 MHz		QPSK	50	0	8.9835
			16-QAM	50	0	8.9846
	15 MHz		QPSK	75	0	13.4980
			16-QAM	75	0	13.4910
	20 MHz		QPSK	100	0	18.0270
			16-QAM	100	0	17.9460

- Plots of the EUT's Occupied Bandwidth are shown Page 28 ~ 31.

8.4 CONDUCTED SPURIOUS EMISSIONS

■ FACTORS FOR FREQUENCY

Frequency Range (GHz)	Factor [dB]
0.03 – 1	27.145
1 – 5	26.960
5 – 10	27.542
10 – 15	28.439
15 – 20	29.144
Above 20	30.148

NOTES:

Factor(dB) = Cable Loss + Attenuator + Power Splitter

Band	Band Width (MHz)	Frequency (MHz)	Frequency of Maximum Harmonic (GHz)	Factor (dB)	Measurement Maximum Data (dBm)	Result (dBm)	Limit (dBm)
7	5	2502.5	5.6012	27.542	-69.627	-42.085	-25.00
		2535.0	25.8763	30.148	-69.787	-39.639	
		2567.5	6.9372	27.542	-69.438	-41.896	
	10	2505.0	2.7384	26.960	-69.668	-42.708	
		2535.0	26.1617	30.148	-70.147	-39.999	
		2565.0	24.7081	30.148	-69.089	-38.941	
	15	2507.5	26.1692	30.148	-69.361	-39.213	
		2535.0	25.6242	30.148	-69.665	-39.517	
		2562.5	3.7074	26.960	-69.291	-42.331	
	20	2510.0	26.4394	30.148	-69.606	-39.458	
		2535.0	26.1477	30.148	-70.109	-39.961	
		2560.0	26.0846	30.148	-68.771	-38.623	

NOTES:

1. Conducted Spurious Emissions was Tested QPSK Modulation, Resource Block Size 1 and Resource Block Offset 0
2. Result (dBm) = Measurement Maximum Data (dBm) + Factor (dB)

- Plots of the EUT's Conducted Spurious Emissions are shown Page 40 ~ 51.

8.4.1 BAND EDGE

Band	Band Width (MHz)	Frequency (MHz)	Modulation	Resource Block Size	Resource Block Offset	Channel Edge ~ -1MHz (Limit : -10 dBm)	-1MHz ~ -4MHz (Limit : -10 dBm)	-4MHz ~ -9.5MHz (Limit : -13 dBm)	-9.5MHz ~ (Limit : -25 dBm)
						Lower	Lower	Lower	Lower
7	5	2502.5	QPSK	25	0	-24.42	-20.16	-30.72	-48.11
	10	2505.0	QPSK	50	0	-26.52	-22.42	-25.26	-39.42
	15	2507.5	QPSK	75	0	-27.76	-24.34	-26.50	-32.10
	20	2510.0	QPSK	100	0	-28.66	-25.70	-27.05	-30.97

Band	Band Width (MHz)	Frequency (MHz)	Modulation	Resource Block Size	Resource Block Offset	Channel Edge ~±1MHz (Limit : -10 dBm)		±1 MHz ~ ±5 MHz (Limit : -10 dBm)		±5 MHz ~ ±6 MHz (Limit : -13 dBm)		±6 MHz ~ (Limit : -25 dBm)	
						Lower	Upper	Lower	Upper	Lower	Upper	Lower	Upper
7	5	2502.5	QPSK	25	0	-	-24.25	-	-19.95	-	-35.57	-	-38.32
		2535.0	QPSK	25	0	-22.88	-23.08	-17.19	-17.41	-36.30	-37.85	-37.35	-38.68
		2567.5	QPSK	25	0	-23.53	-24.07	-18.57	-19.14	-35.52	-37.74	-38.32	-40.68
	10	2505.0	QPSK	50	0	-	-26.85	-	-22.64	-	-26.40	-	-37.90
		2535.0	QPSK	50	0	-23.78	-23.98	-19.00	-19.31	-23.69	-24.27	-38.31	-41.21
		2565.0	QPSK	50	0	-24.48	-25.29	-19.95	-20.49	-24.79	-25.57	-37.14	-40.61
	15	2507.5	QPSK	75	0	-	-27.26	-	-24.36	-	-26.74	-	-38.91
		2535.0	QPSK	75	0	-24.21	-24.43	-20.35	-20.57	-22.98	-23.95	-38.36	-39.62
		2562.5	QPSK	75	0	-26.36	-26.24	-22.80	-22.84	-25.87	-26.19	-38.09	-42.54
	20	2510.0	QPSK	100	0	-	-28.11	-	-25.18	-	-26.89	-	-39.71
		2535.0	QPSK	100	0	-24.58	-25.39	-21.53	-22.11	-23.72	-24.69	-38.77	-39.32
		2560.0	QPSK	100	0	-27.69	-27.50	-25.00	-24.64	-27.68	-27.21	-38.21	-48.42

NOTES: Channel Edge was Tested QPSK Modulation and Full RB (Resource Block) Size

- Plots of the EUT's Band Edge are shown Page 32 ~ 39.

8.5 REQUENCY STABILITY / VARIATION OF AMBIENT TEMPERATURE

8.5.1 FREQUENCY STABILITY (5 MHz Band 7 LTE)

- ▣ OPERATING FREQUENCY: 2,535,000,000 Hz
- ▣ CHANNEL: 21100 (5 MHz)
- ▣ REFERENCE VOLTAGE: 3.85 VDC
- ▣ DEVIATION LIMIT: Emission must remain in band

Voltage (%)	Power (VDC)	Temp. (°C)	Frequency (Hz)	Frequency Error (Hz)	Deviation (%)	ppm
100%	3.85	+20(Ref)	2535 000 010	0.0	0.000 000	0.0000
100%		-30	2535 000 019	9.1	0.000 000	0.0036
100%		-20	2535 000 018	8.1	0.000 000	0.0032
100%		-10	2535 000 014	4.6	0.000 000	0.0018
100%		0	2535 000 017	7.2	0.000 000	0.0028
100%		+10	2535 000 020	10.9	0.000 000	0.0043
100%		+30	2535 000 016	6.1	0.000 000	0.0024
100%		+40	2535 000 018	8.8	0.000 000	0.0035
100%		+50	2535 000 018	8.0	0.000 000	0.0032
Batt. Endpoint	3.60	+20	2535 000 018	8.5	0.000 000	0.0034

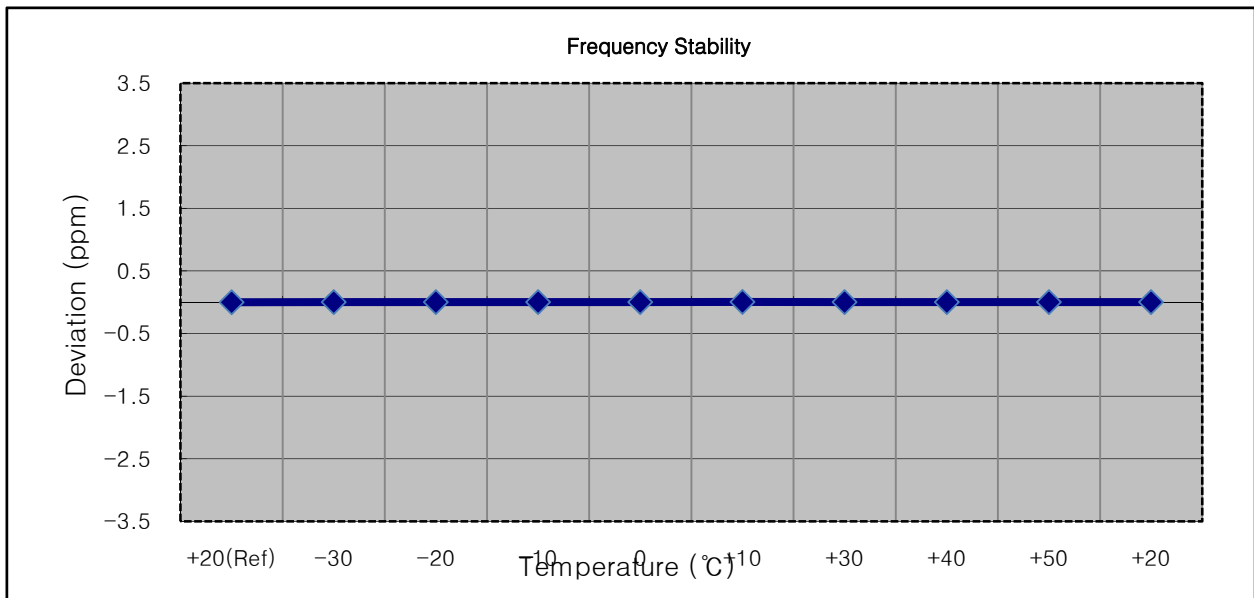

8.5.2 FREQUENCY STABILITY (10 MHz Band 7 LTE)

- ▣ OPERATING FREQUENCY: 2,535,000,000 Hz
- ▣ CHANNEL: 21100 (10 MHz)
- ▣ REFERENCE VOLTAGE: 3.85 VDC
- ▣ DEVIATION LIMIT: Emission must remain in band

Voltage (%)	Power (VDC)	Temp. (°C)	Frequency (Hz)	Frequency Error (Hz)	Deviation (%)	ppm
100%	3.85	+20(Ref)	2535 000 003	0.0	0.000 000	0.0000
100%		-30	2535 000 008	4.9	0.000 000	0.0019
100%		-20	2535 000 010	7.4	0.000 000	0.0029
100%		-10	2535 000 007	4.1	0.000 000	0.0016
100%		0	2535 000 009	5.8	0.000 000	0.0023
100%		+10	2535 000 010	7.4	0.000 000	0.0029
100%		+30	2534 999 996	-6.5	0.000 000	-0.0026
100%		+40	2535 000 007	4.0	0.000 000	0.0016
100%		+50	2535 000 009	6.4	0.000 000	0.0025
Batt. Endpoint		3.60	+20	2535 000 009	5.8	0.000 000

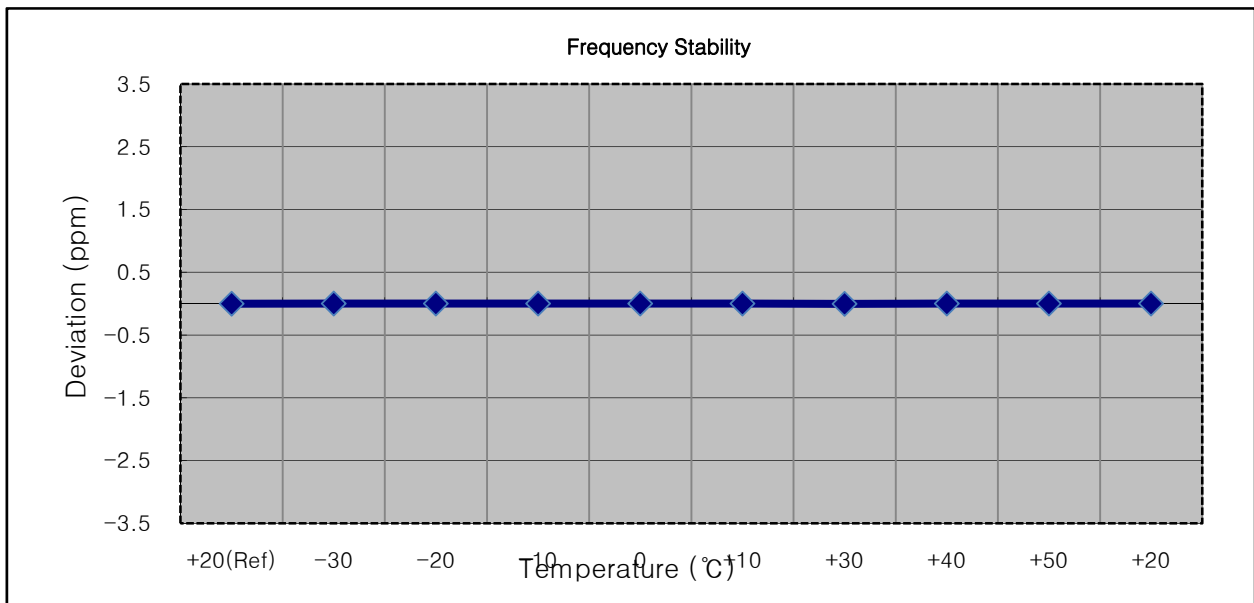

8.5.3 FREQUENCY STABILITY (15 MHz Band 7 LTE)

- ▣ OPERATING FREQUENCY: 2,535,000,000 Hz
- ▣ CHANNEL: 21100 (15 MHz)
- ▣ REFERENCE VOLTAGE: 3.85 VDC
- ▣ DEVIATION LIMIT: Emission must remain in band

Voltage (%)	Power (VDC)	Temp. (°C)	Frequency (Hz)	Frequency Error (Hz)	Deviation (%)	ppm	
100%	3.85	+20(Ref)	2535 000 005	0.0	0.000 000	0.000	
100%		-30	2535 000 013	7.6	0.000 000	0.003	
100%		-20	2535 000 014	8.4	0.000 000	0.003	
100%		-10	2535 000 012	7.0	0.000 000	0.003	
100%		0	2535 000 013	7.9	0.000 000	0.003	
100%		+10	2535 000 011	6.2	0.000 000	0.002	
100%		+30	2535 000 011	6.2	0.000 000	0.002	
100%		+40	2535 000 014	8.4	0.000 000	0.003	
100%		+50	2535 000 000	2535 000 000	-5.5	0.000 000	-0.002
Batt. Endpoint		3.60	+20	2535 000 014	8.5	0.000 000	0.003

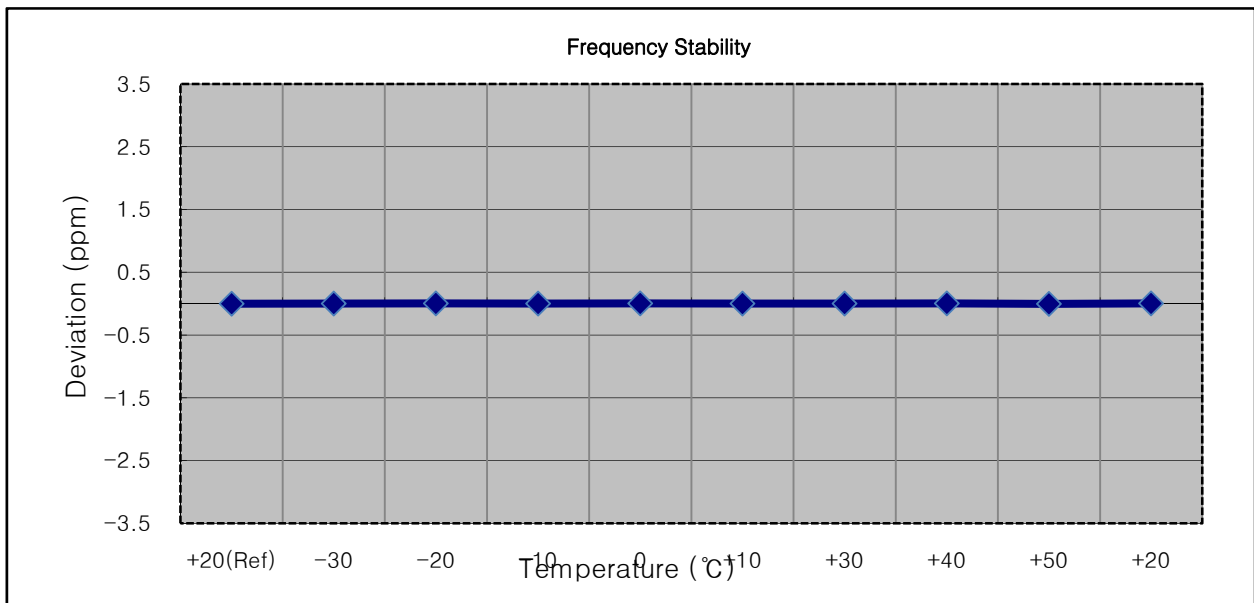

8.5.4 FREQUENCY STABILITY (20 MHz Band 7 LTE)

- ▣ OPERATING FREQUENCY: 2,535,000,000 Hz
- ▣ CHANNEL: 21100 (20 MHz)
- ▣ REFERENCE VOLTAGE: 3.85 VDC
- ▣ DEVIATION LIMIT: Emission must remain in band

Voltage (%)	Power (VDC)	Temp. (°C)	Frequency (Hz)	Frequency Error (Hz)	Deviation (%)	ppm
100%	3.85	+20(Ref)	2535 000 006	0.0	0.000 000	0.000
100%		-30	2535 000 014	8.3	0.000 000	0.003
100%		-20	2535 000 002	-3.1	0.000 000	-0.001
100%		-10	2535 000 014	8.0	0.000 000	0.003
100%		0	2535 000 014	8.0	0.000 000	0.003
100%		+10	2535 000 009	3.8	0.000 000	0.001
100%		+30	2535 000 011	5.5	0.000 000	0.002
100%		+40	2535 000 009	3.7	0.000 000	0.001
100%		+50	2535 000 001	-4.7	0.000 000	-0.002
Batt. Endpoint		3.60	+20	2535 000 012	6.5	0.000 000

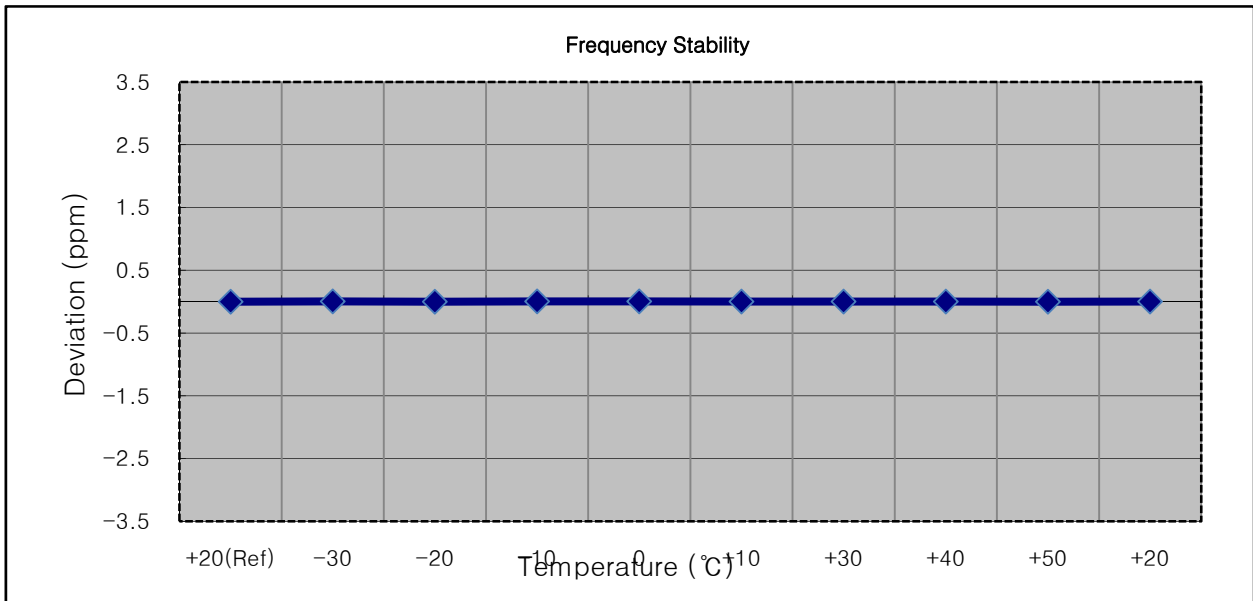

9. TEST PLOTS

BAND7. Occupied Bandwidth Plot (5MHz Ch.21100 QPSK RB 25)

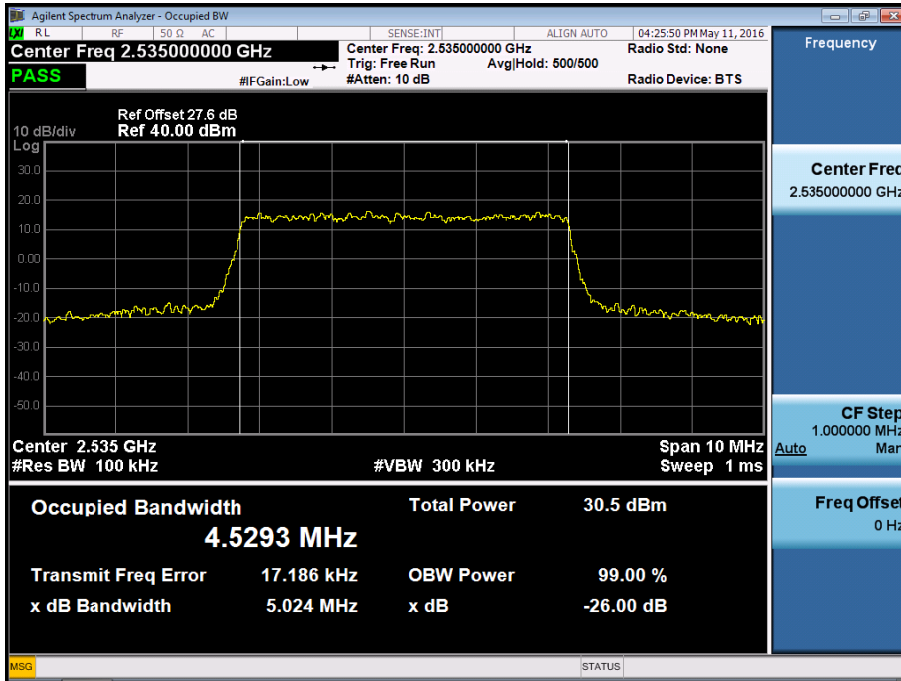

BAND7. Occupied Bandwidth Plot (5MHz Ch.21100 16-QAM RB 25)

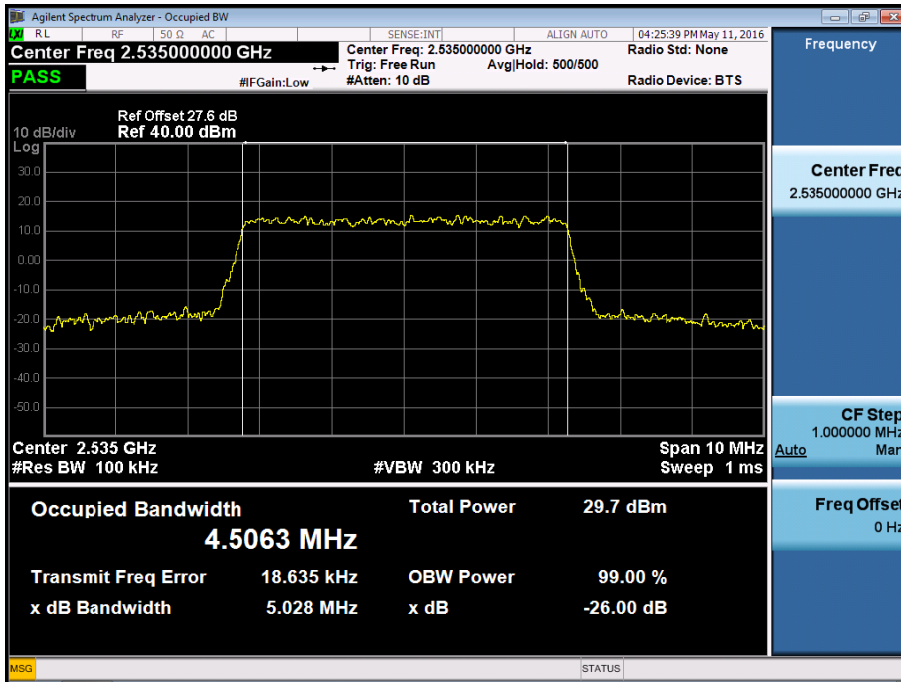

BAND7. Occupied Bandwidth Plot (10MHz Ch.21100 QPSK RB 50)

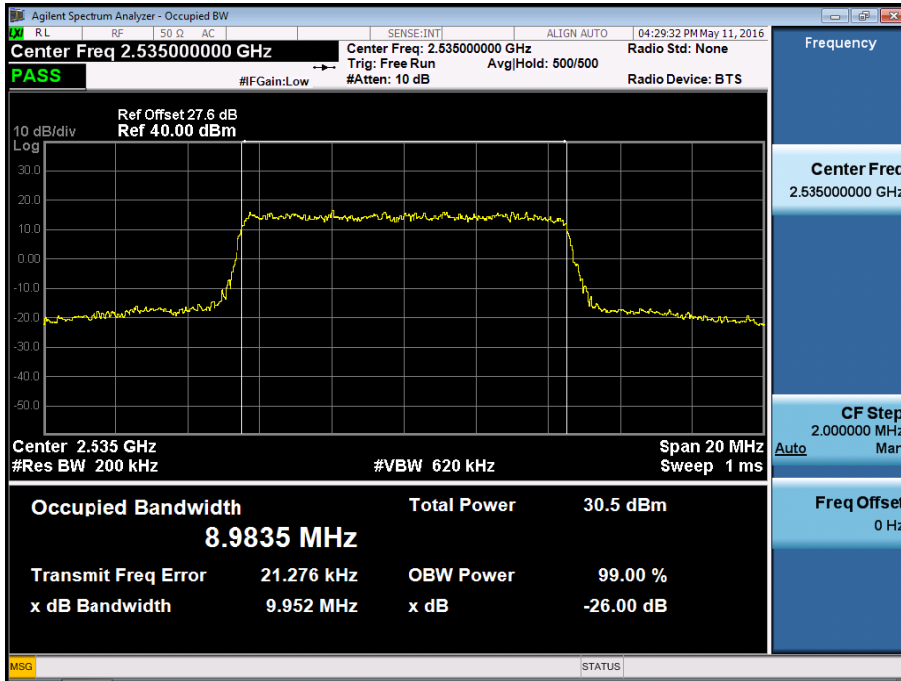

BAND7. Occupied Bandwidth Plot (10MHz Ch.21100 16-QAM RB 50)

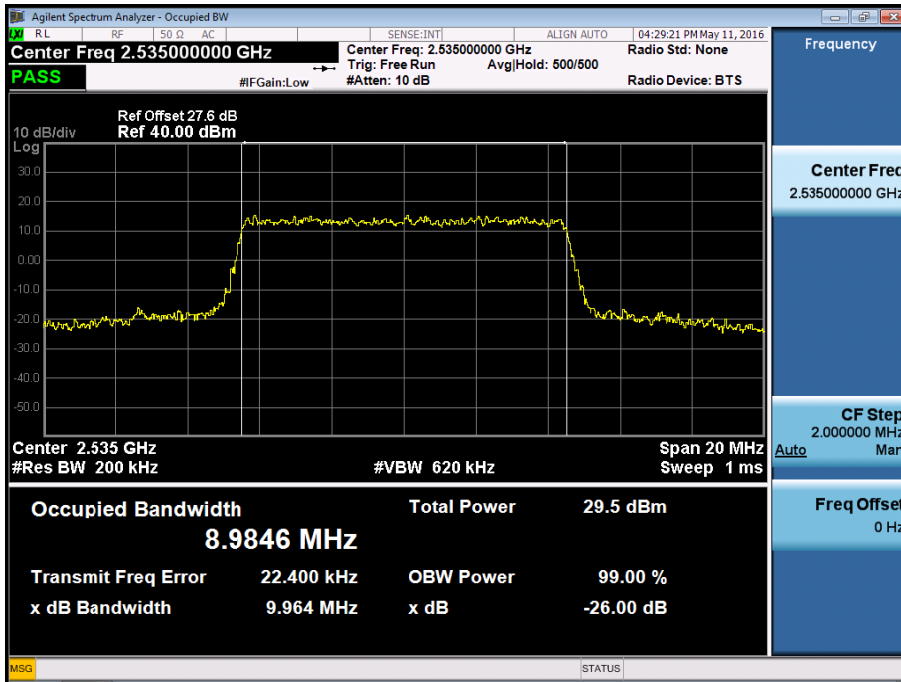

BAND7. Occupied Bandwidth Plot (15MHz Ch.21100 QPSK RB 75)

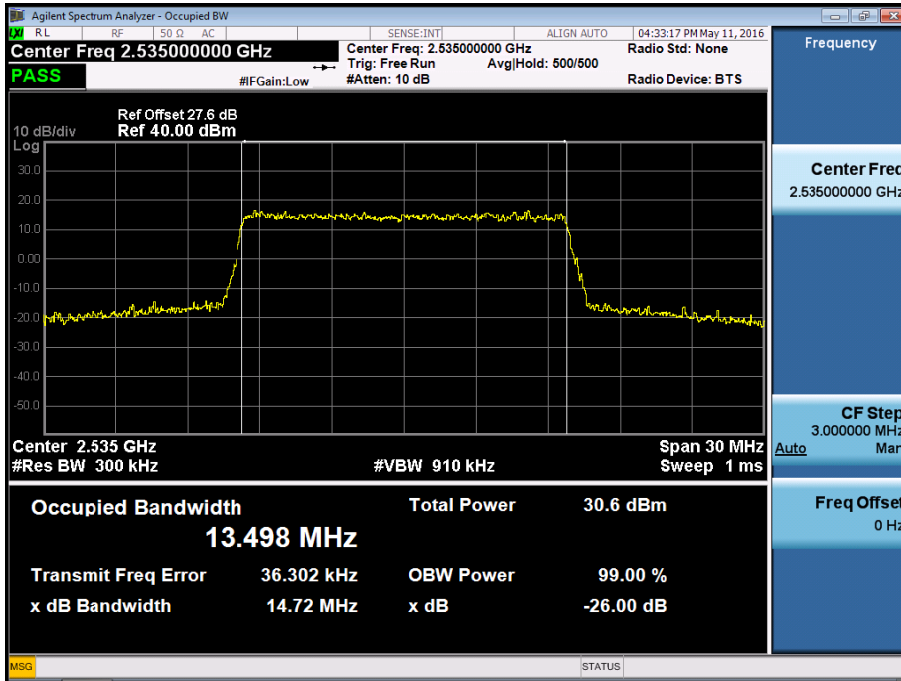

BAND7. Occupied Bandwidth Plot (15MHz Ch.21100 16-QAM RB 75)

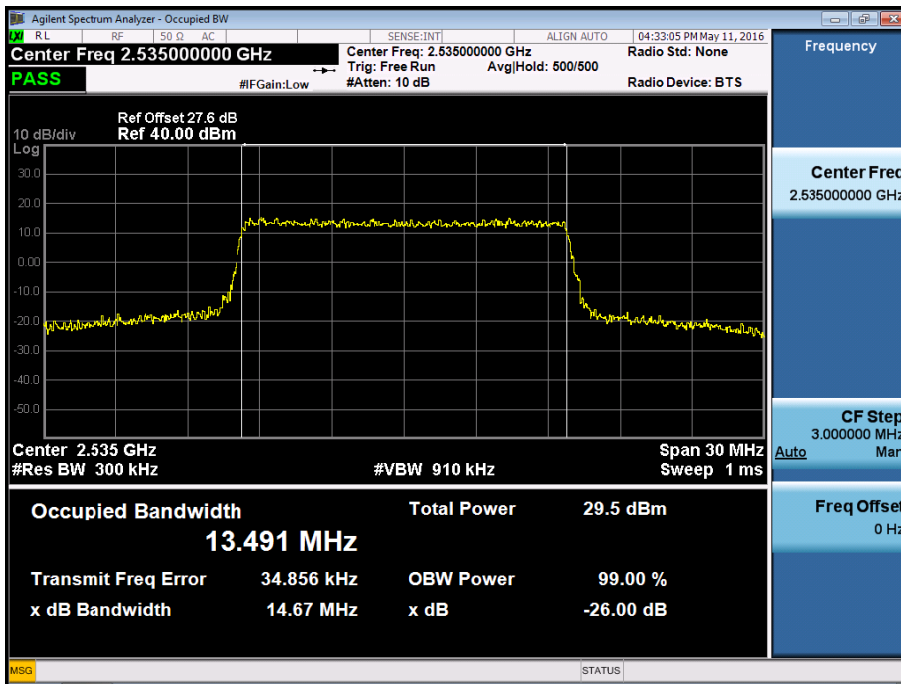

BAND7. Occupied Bandwidth Plot (20MHz Ch.21100 QPSK RB 100)

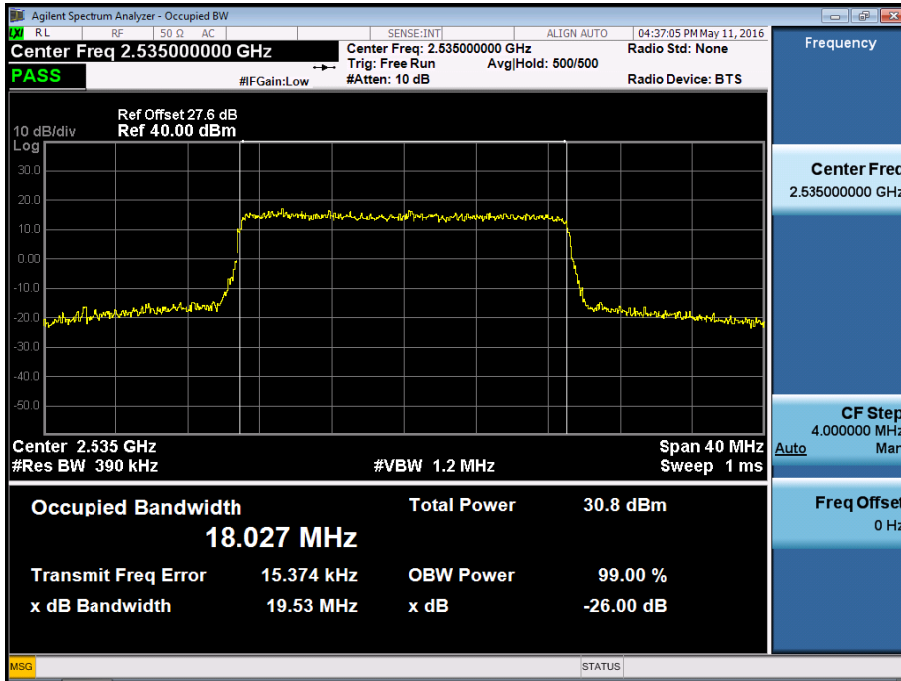

BAND7. Occupied Bandwidth Plot (20MHz Ch.21100 16-QAM RB 100)

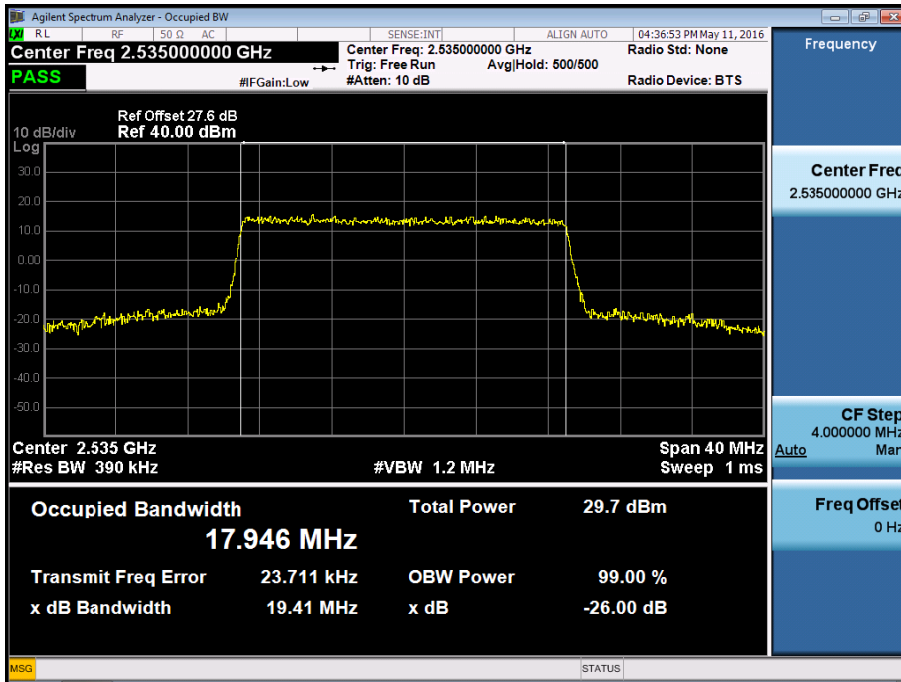

BAND7. Low Channel Edge Plot (5MHz Ch.20775 QPSK RB 25)-1



BAND7. Low Channel Edge Plot (5MHz Ch.20775 QPSK RB 25)-2

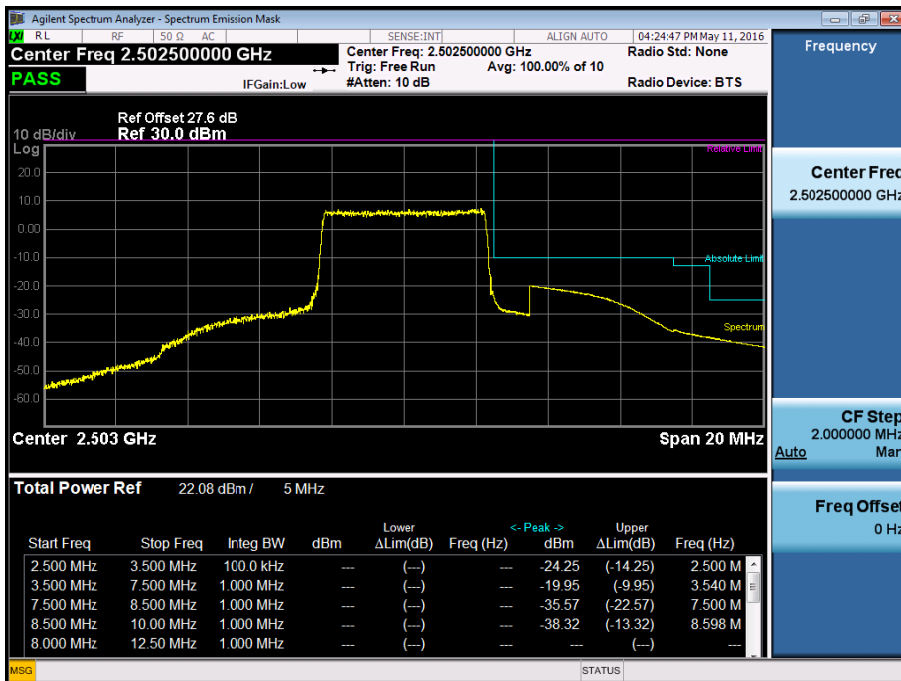

BAND7. Mid Channel Edge Plot (5MHz Ch.21100 QPSK RB 25)

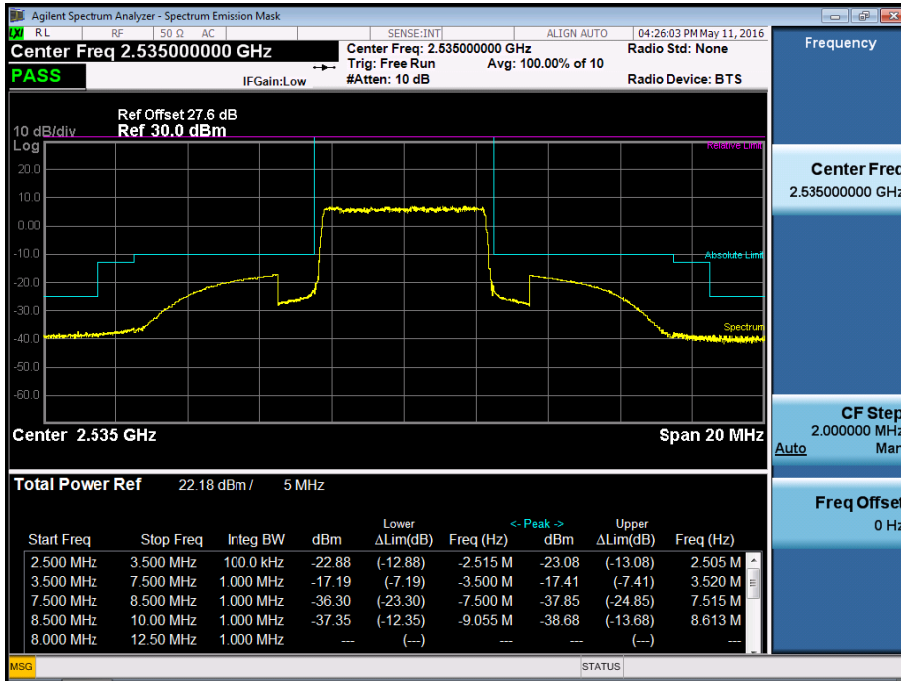

BAND7. High Channel Edge Plot (5MHz Ch.21425 QPSK RB 25)

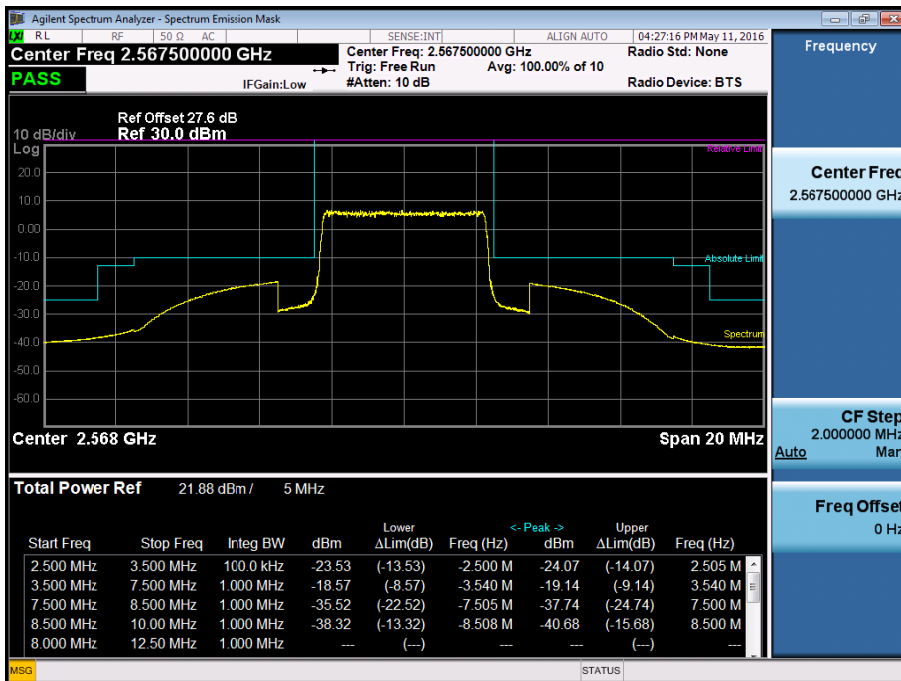

BAND7. Low Channel Edge Plot (10MHz Ch.20800 QPSK RB 50)-1



BAND7. Low Channel Edge Plot (10MHz Ch.20800 QPSK RB 50)-2



BAND7. Mid Channel Edge Plot (10MHz Ch.21100 QPSK RB 50)

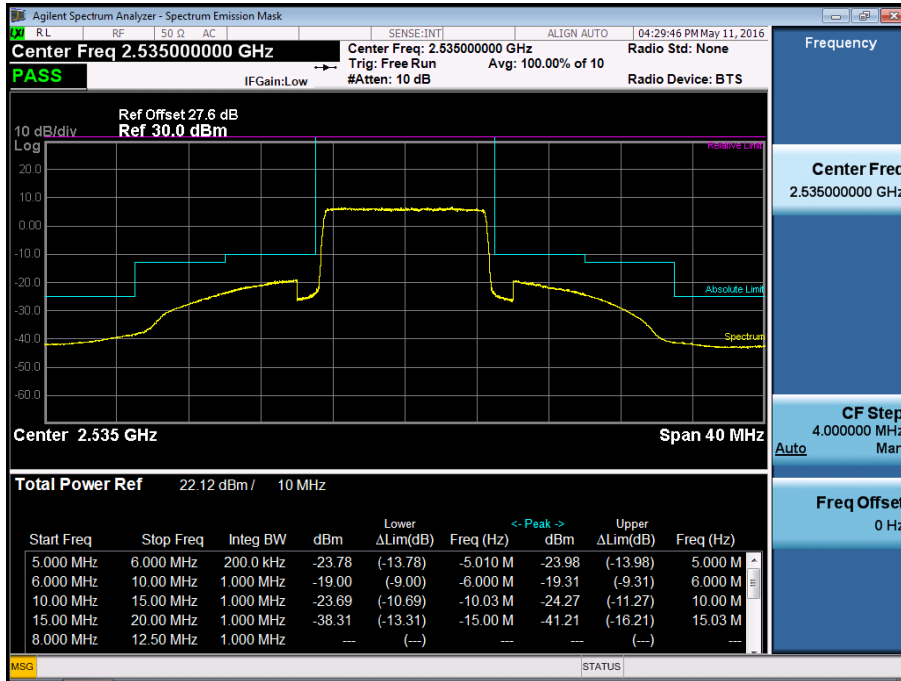

BAND7. High Channel Edge Plot (10MHz Ch.21400 QPSK RB 50)

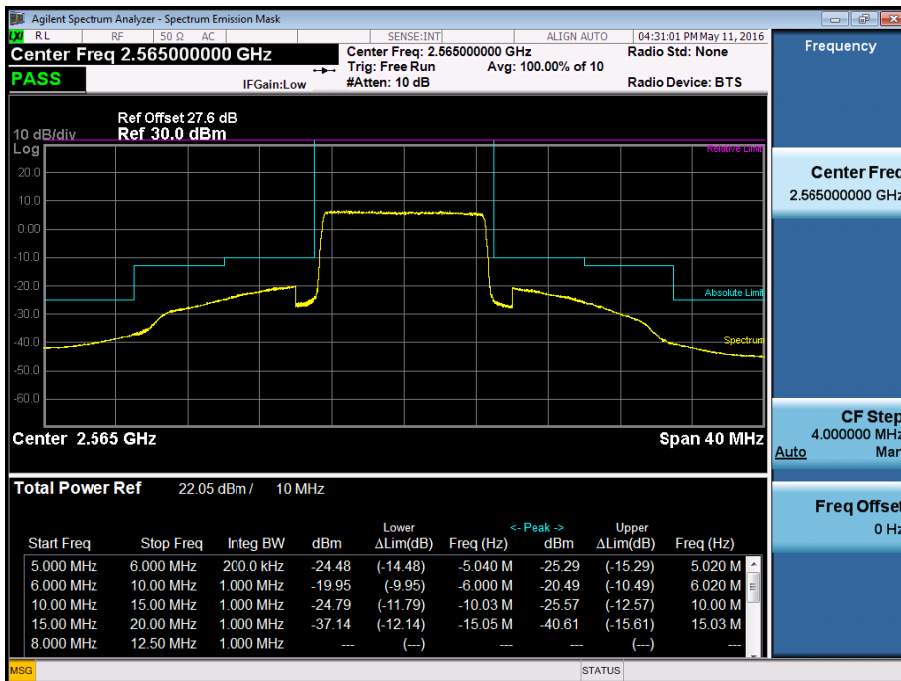

BAND7. Low Channel Edge Plot (15MHz Ch.20825 QPSK RB 75)-1

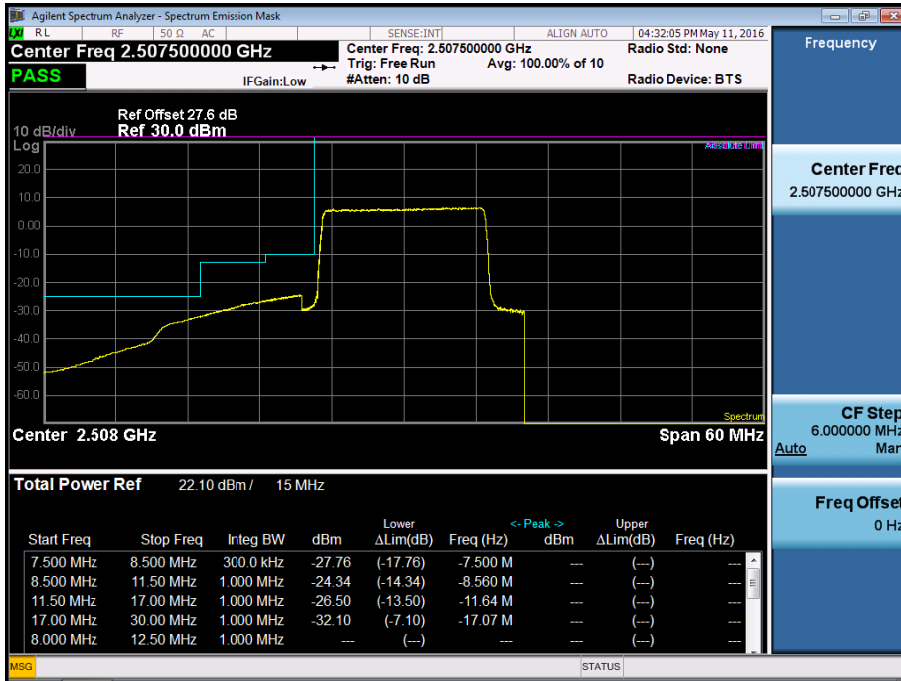

BAND7. Low Channel Edge Plot (15MHz Ch.20825 QPSK RB 75)-2



BAND7. Mid Channel Edge Plot (15MHz Ch.21100 QPSK RB 75)

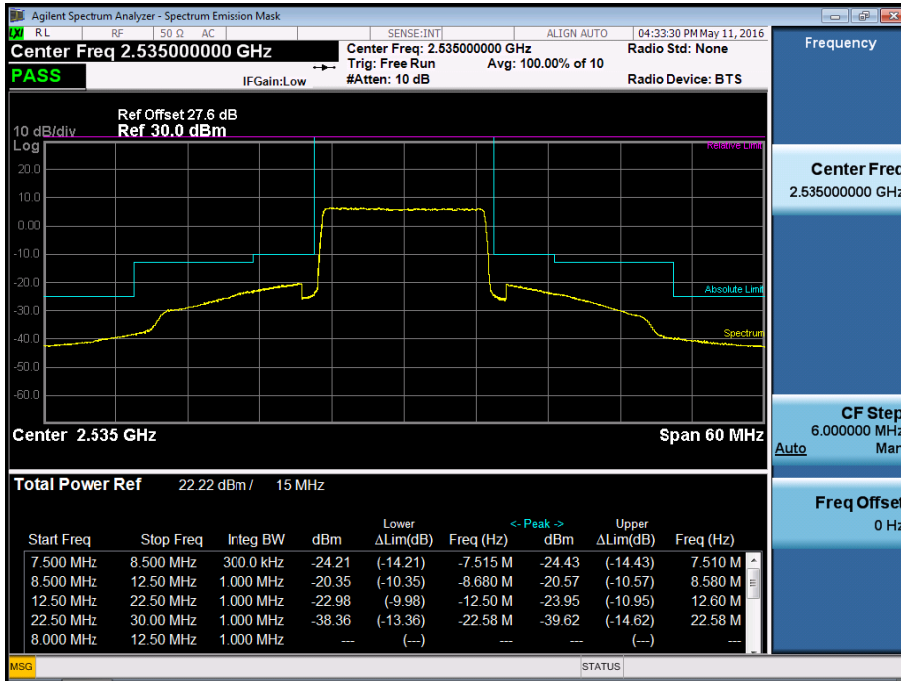

BAND7. High Channel Edge Plot (15MHz Ch.21375 QPSK RB 75)

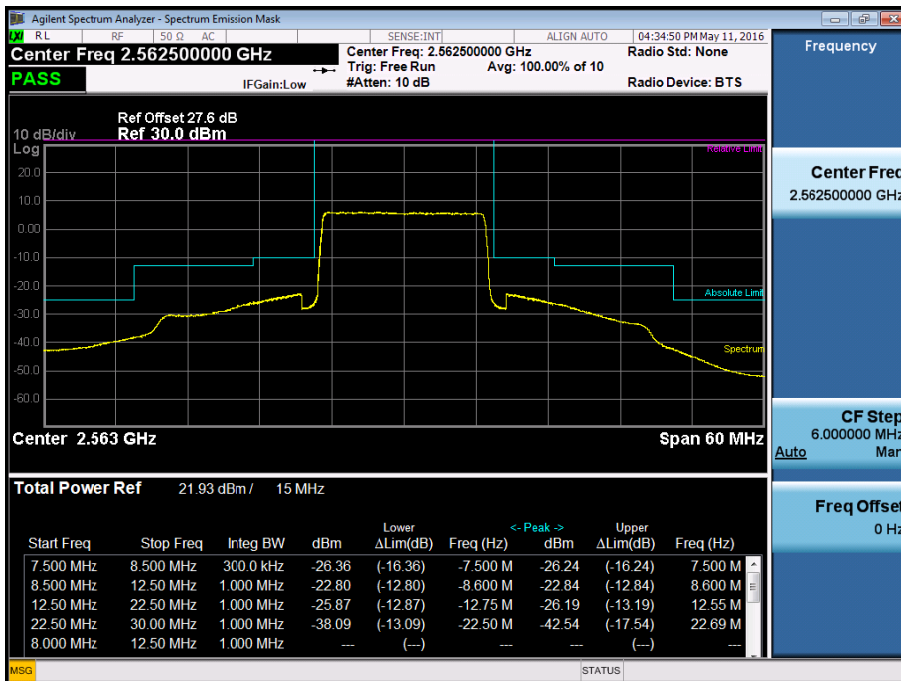

BAND7. Low Channel Edge Plot (20MHz Ch.20850 QPSK RB 100)-1

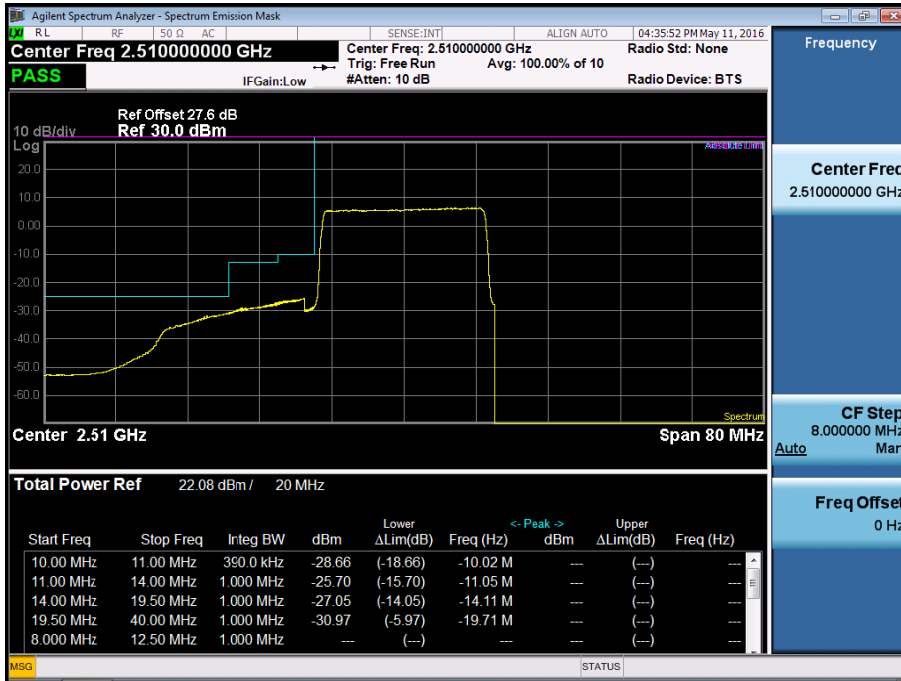

BAND7. Low Channel Edge Plot (20MHz Ch.20850 QPSK RB 100)-2



BAND7. Mid Channel Edge Plot (20MHz Ch.21100 QPSK RB 100)

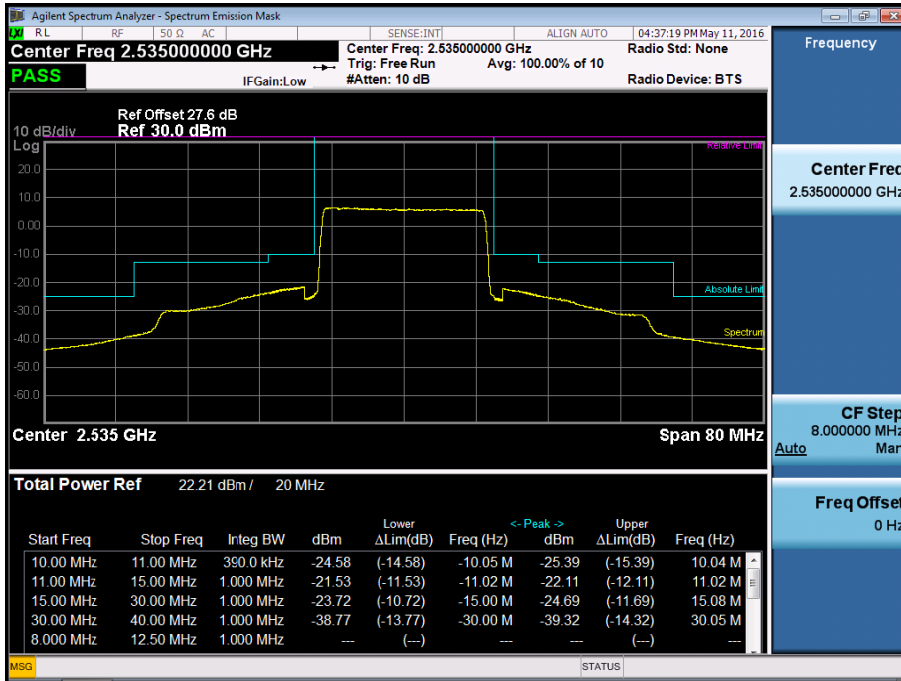

BAND7. High Channel Edge Plot (20MHz Ch.21350 QPSK RB 100)

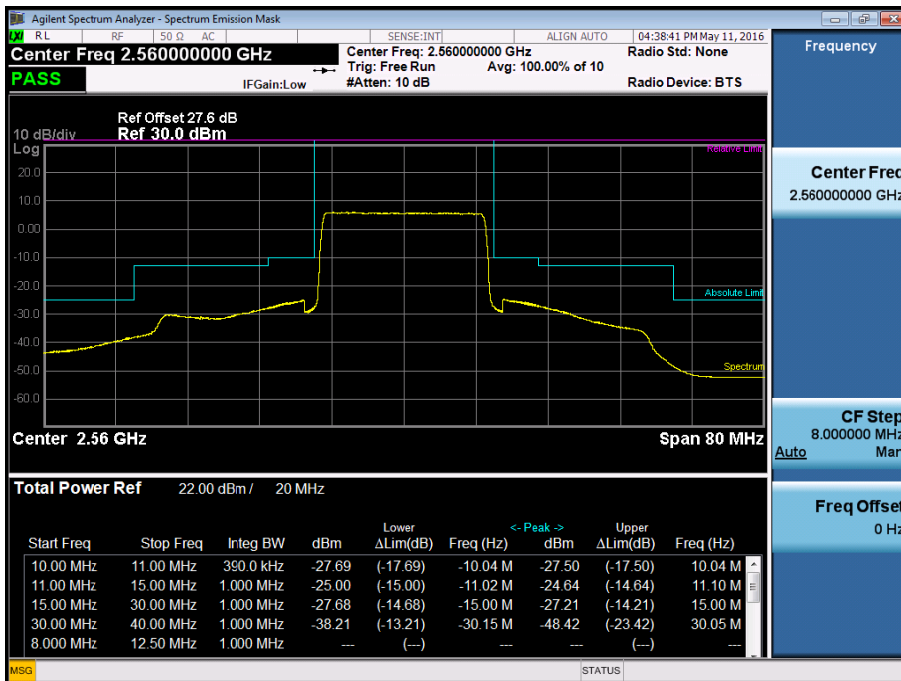

BAND7. Conducted Spurious Plot 1 (5MHz Ch.20775 QPSK RB 1, Offset 0)

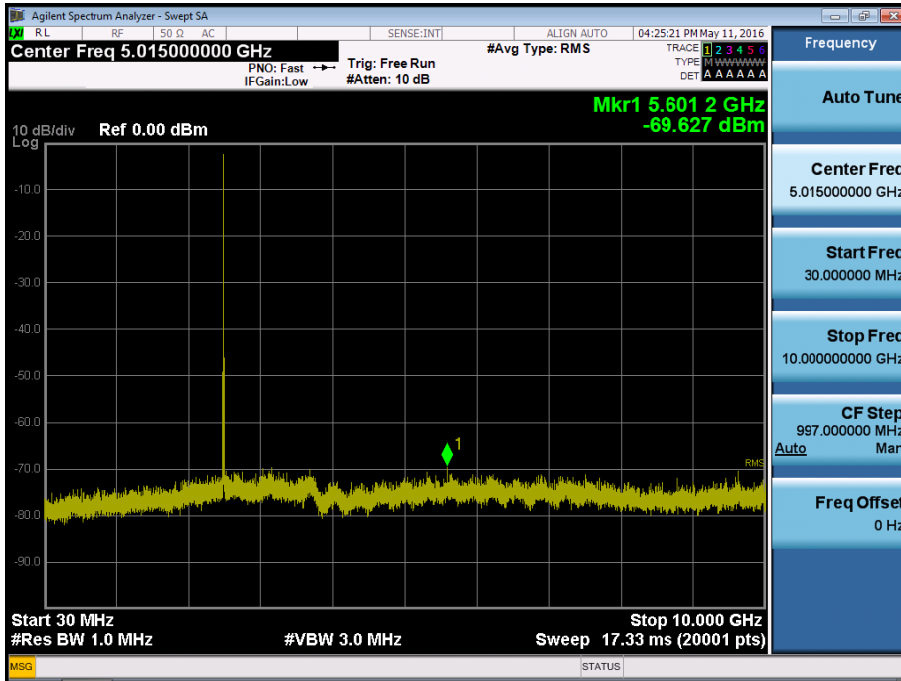

BAND7. Conducted Spurious Plot 2 (5MHz Ch.20775 QPSK RB 1, Offset 0)

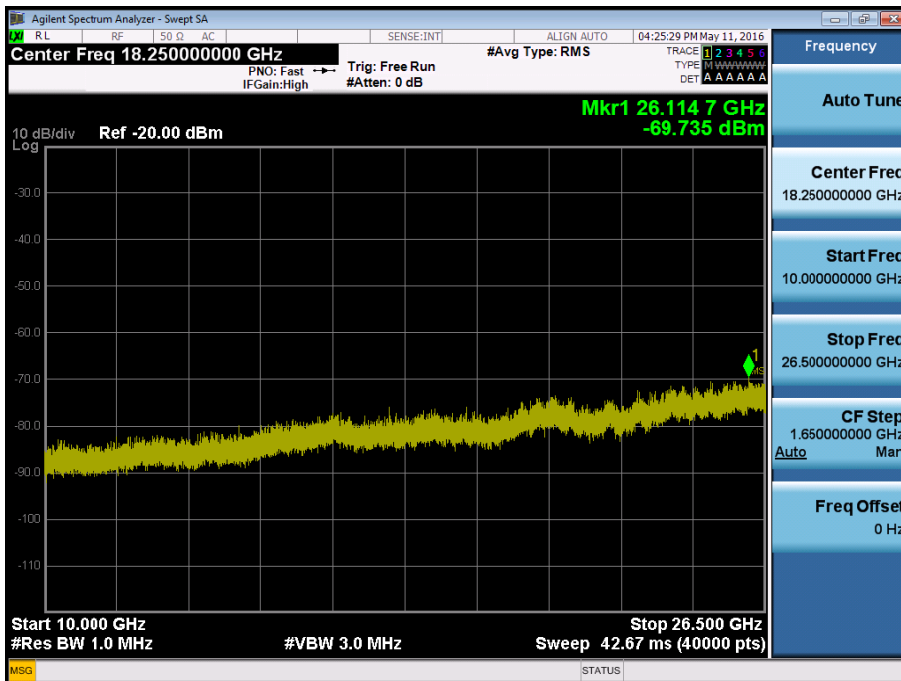

BAND7. Conducted Spurious Plot 1 (5MHz Ch.21100 QPSK RB 1, Offset 0)

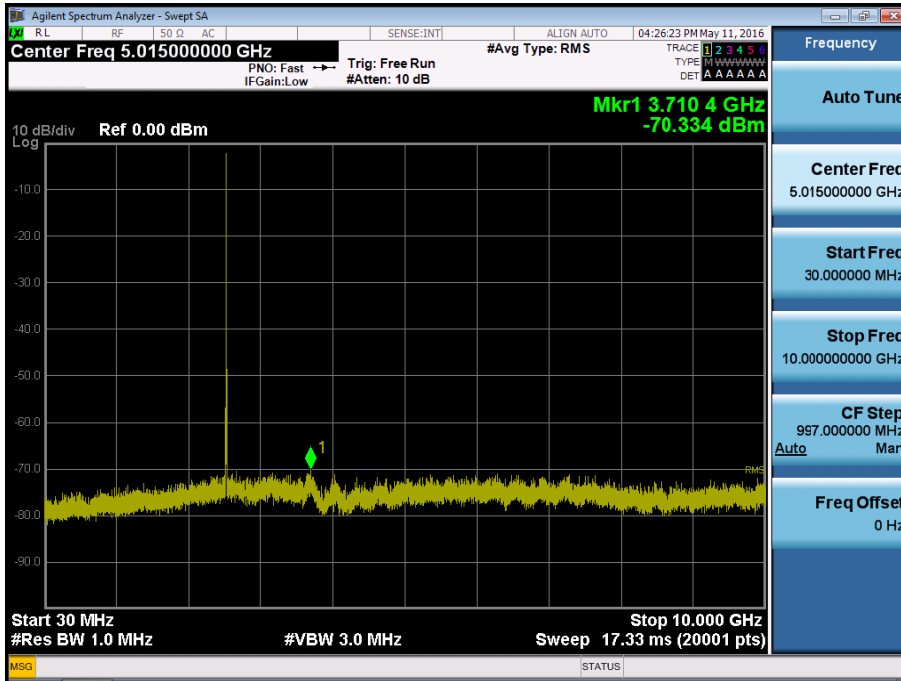

BAND7. Conducted Spurious Plot 2 (5MHz Ch.21100 QPSK RB 1, Offset 0)

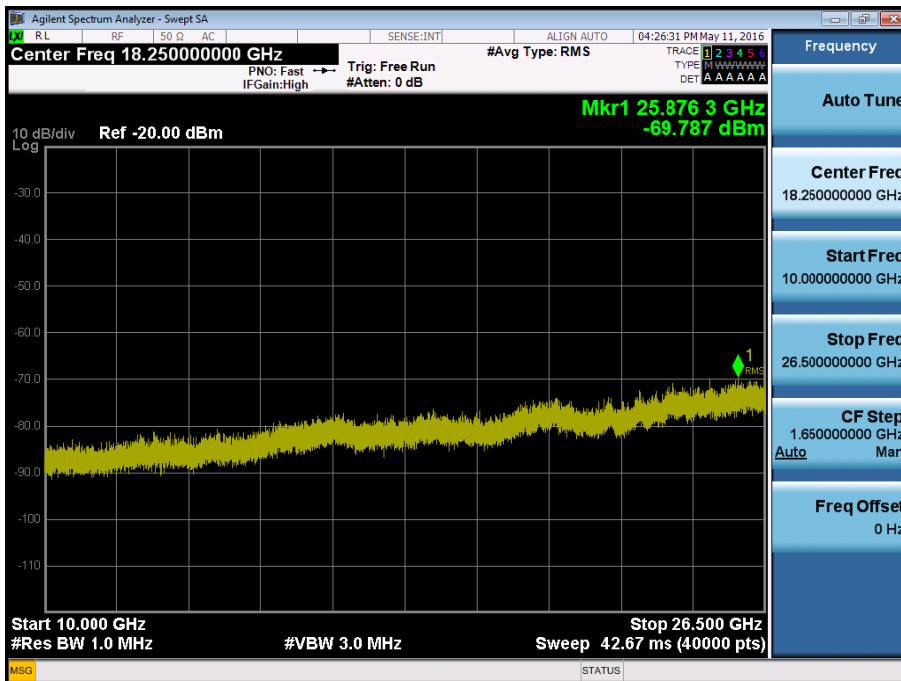

BAND7. Conducted Spurious Plot 1 (5MHz Ch.21425 QPSK RB 1, Offset 0)

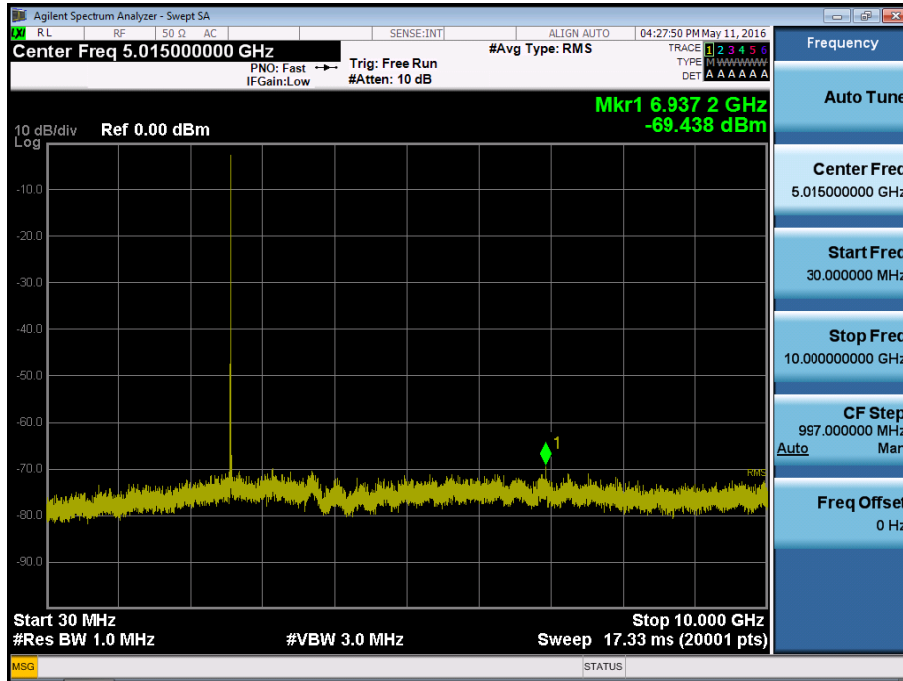

BAND7. Conducted Spurious Plot 2 (5MHz Ch.21425 QPSK RB 1, Offset 0)

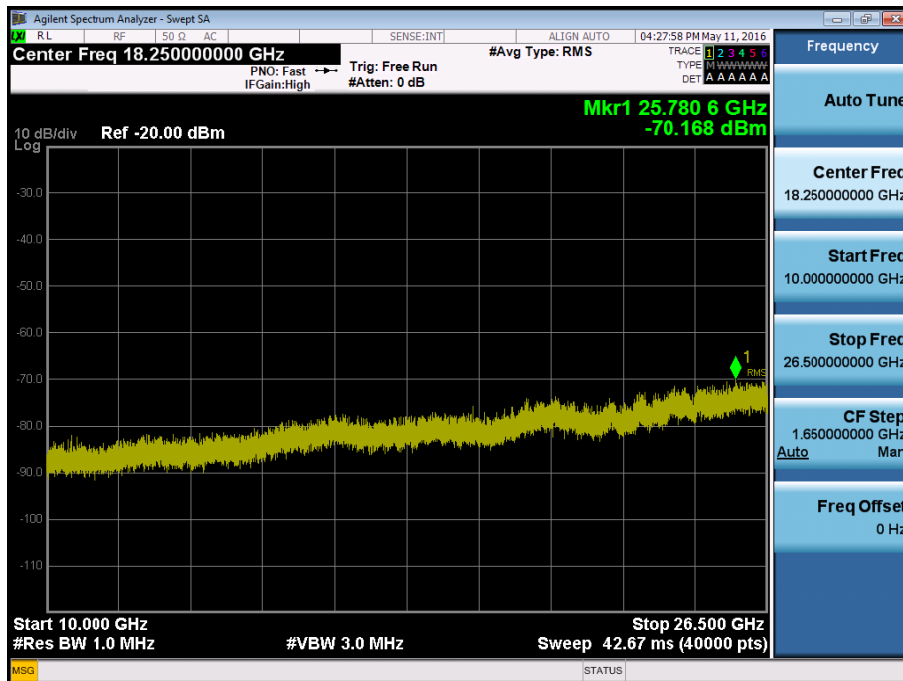

BAND7. Conducted Spurious Plot 1 (10MHz Ch.20800 QPSK RB 1, Offset 0)

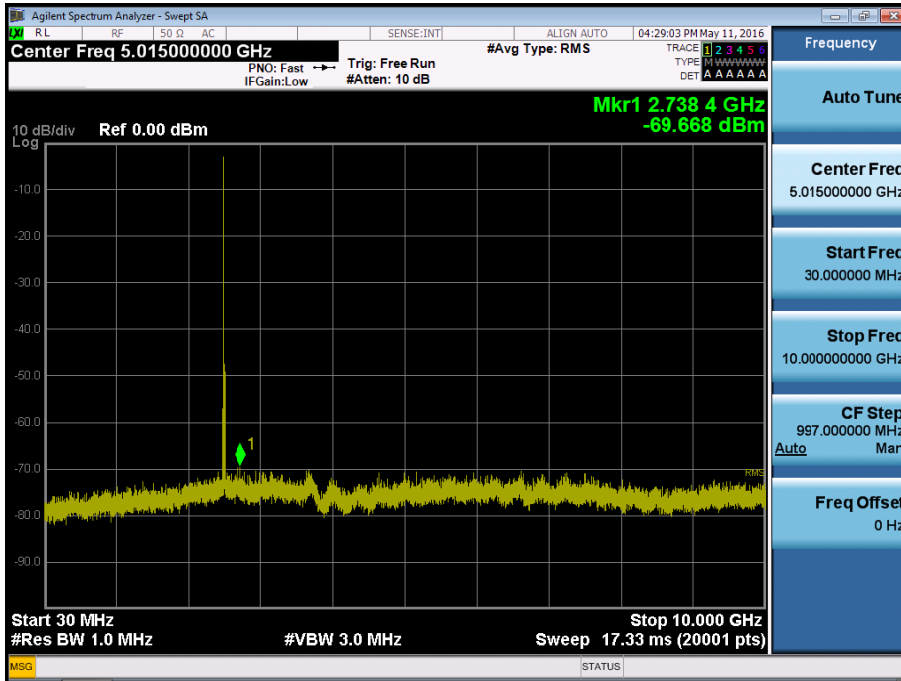

BAND7. Conducted Spurious Plot 2 (10MHz Ch.20800 QPSK RB 1, Offset 0)

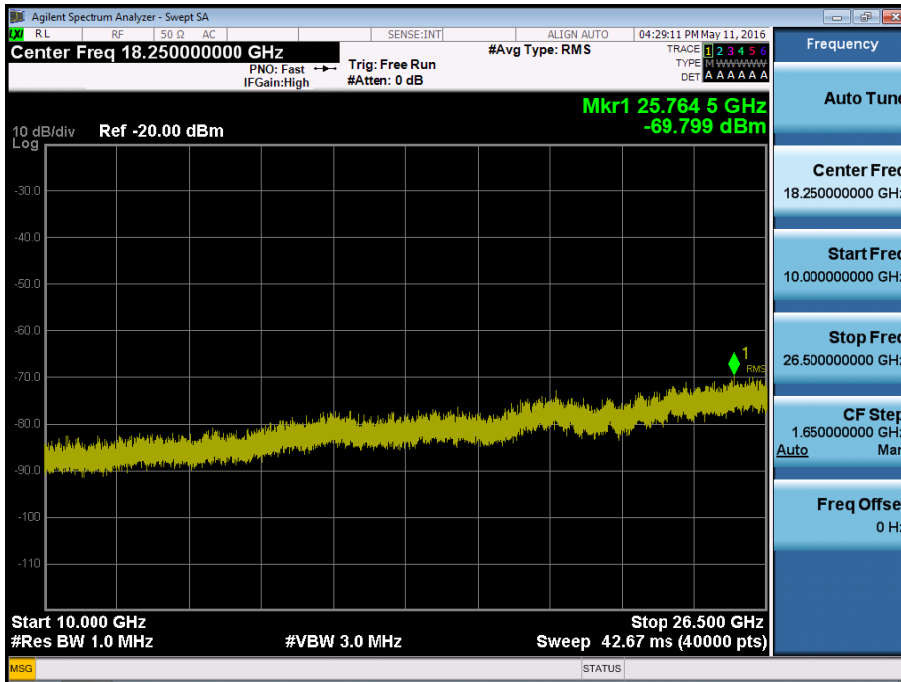

BAND7. Conducted Spurious Plot 1 (10MHz Ch.21100 QPSK RB 1, Offset 0)

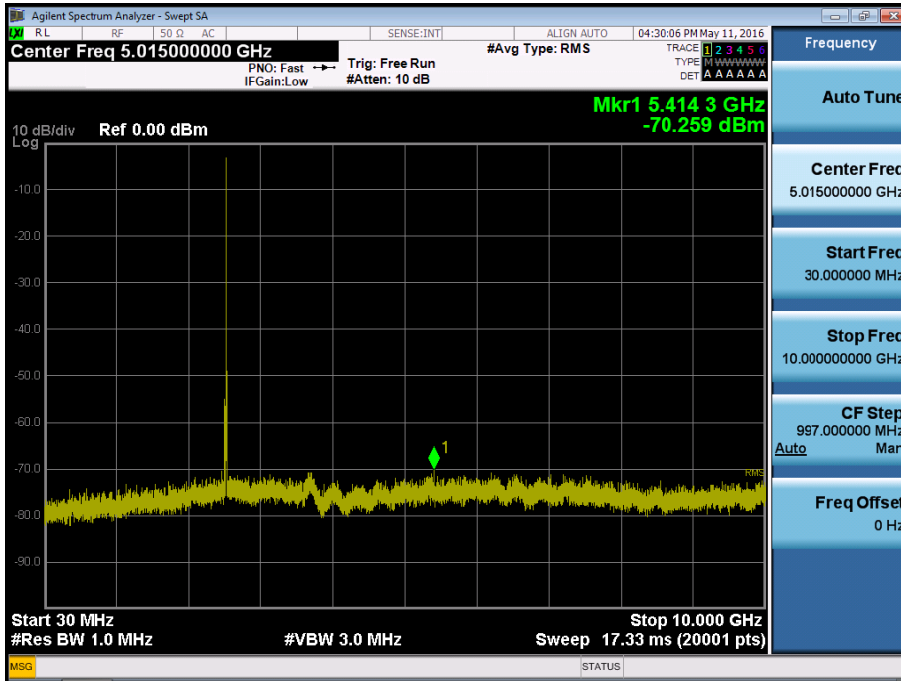

BAND7. Conducted Spurious Plot 2 (10MHz Ch.21100 QPSK RB 1, Offset 0)

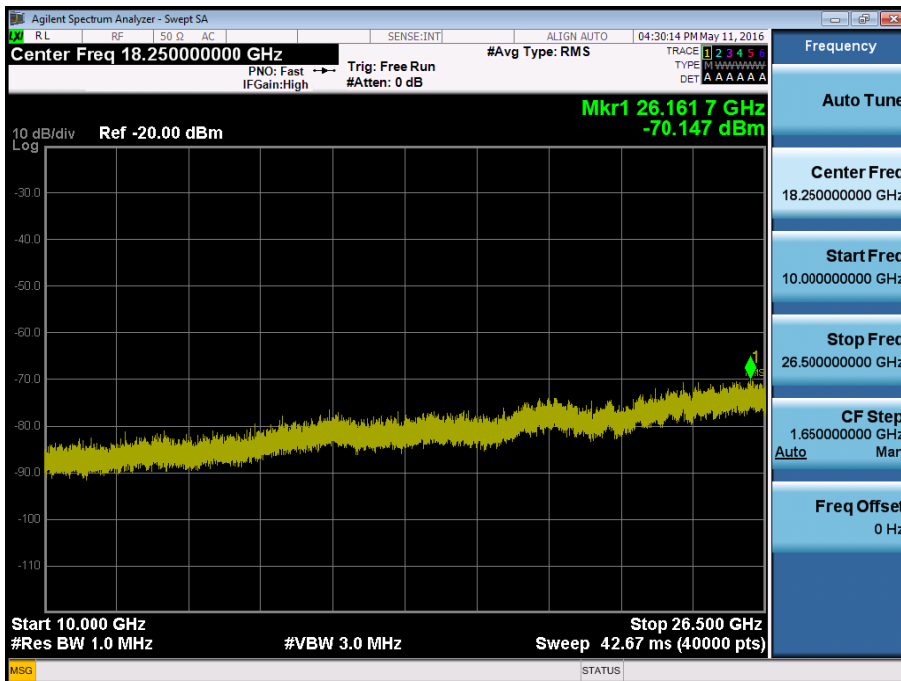

BAND7. Conducted Spurious Plot 1 (10MHz Ch.21400 QPSK RB 1, Offset 0)

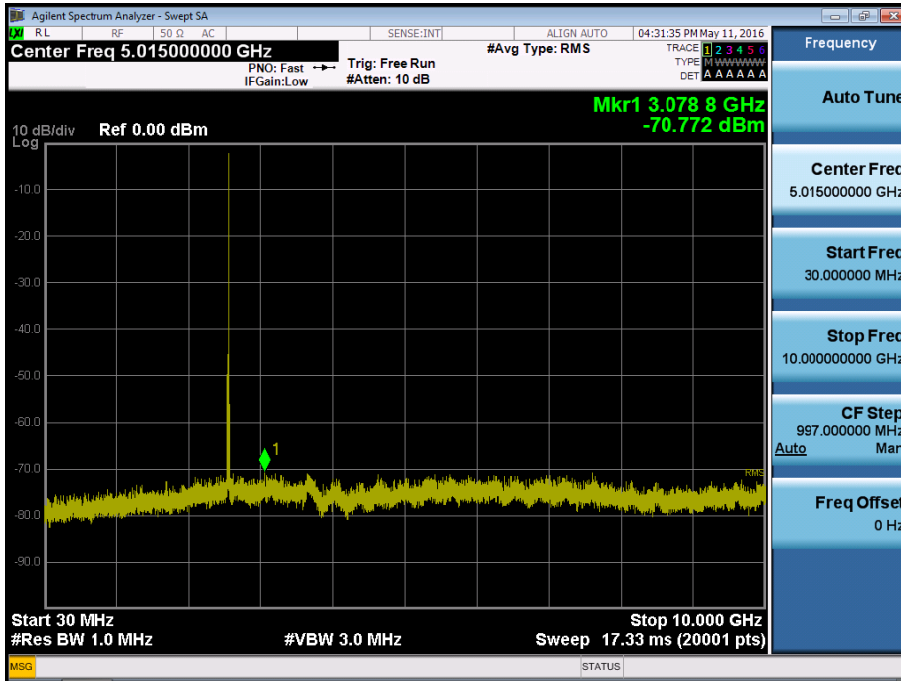

BAND7. Conducted Spurious Plot 2 (10MHz Ch.21400 QPSK RB 1, Offset 0)

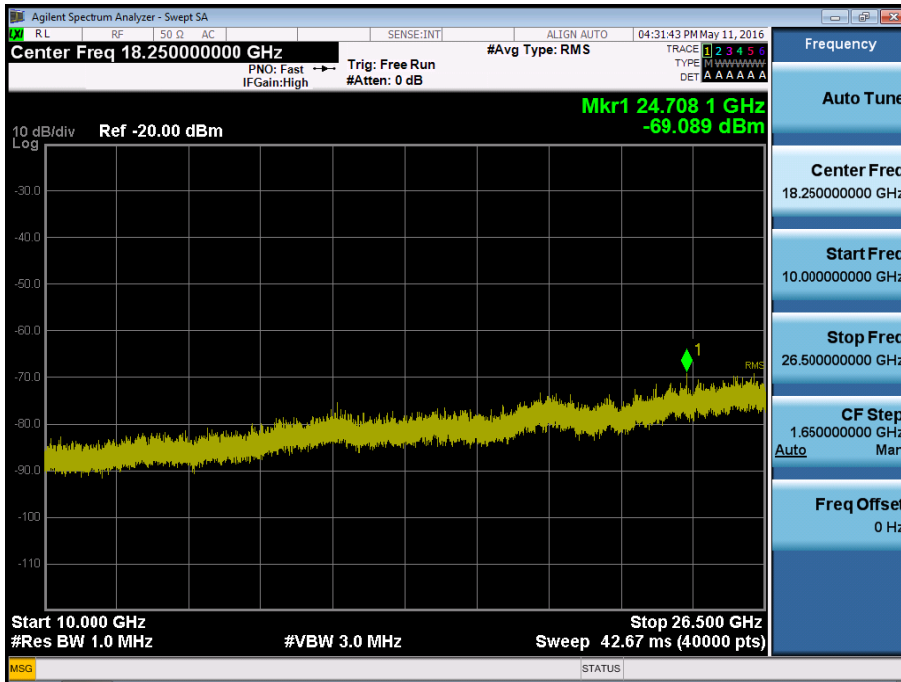

BAND7. Conducted Spurious Plot 1 (15MHz Ch.20825 QPSK RB 1, Offset 0)

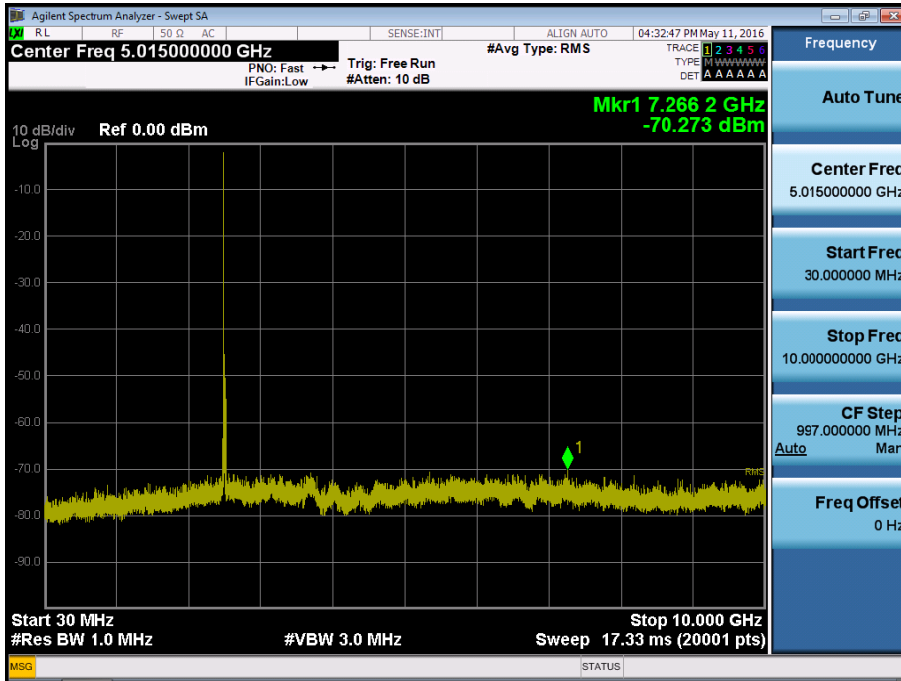

BAND7. Conducted Spurious Plot 2 (15MHz Ch.20825 QPSK RB 1, Offset 0)

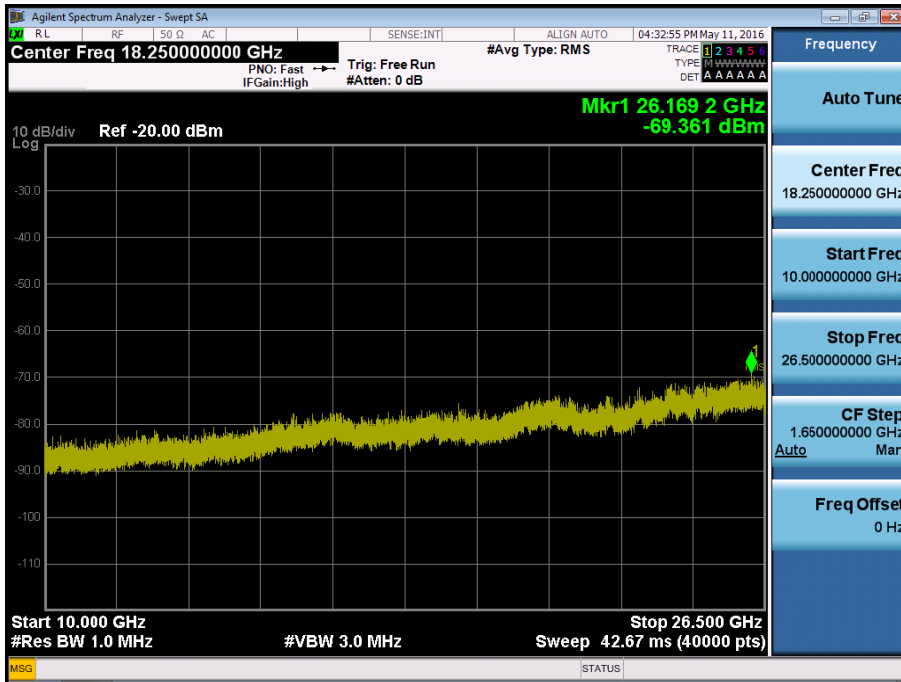

BAND7. Conducted Spurious Plot 1 (15MHz Ch.21100 QPSK RB 1, Offset 0)

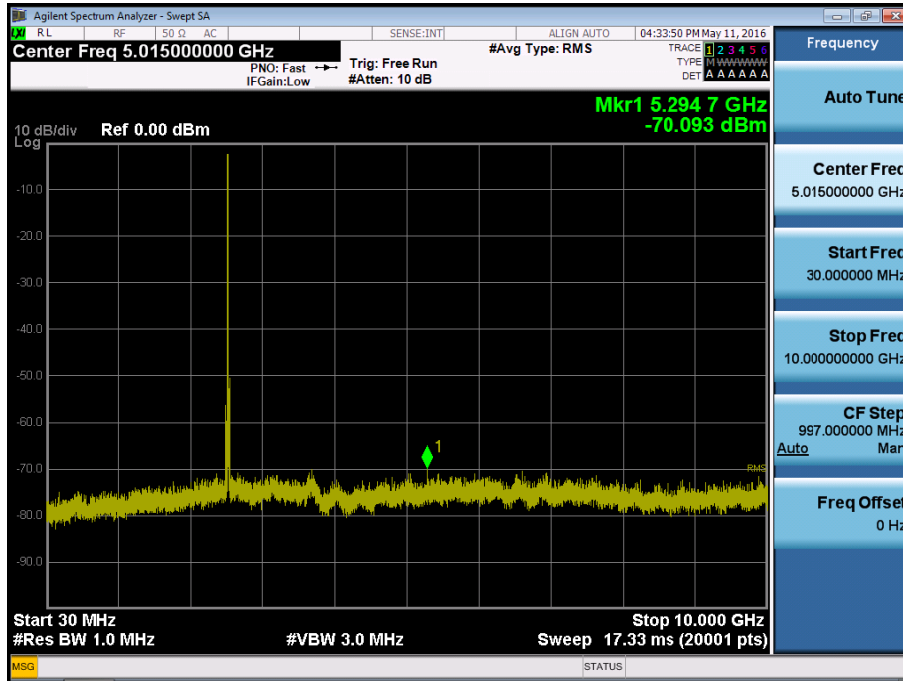

BAND7. Conducted Spurious Plot 2 (15MHz Ch.21100 QPSK RB 1, Offset 0)

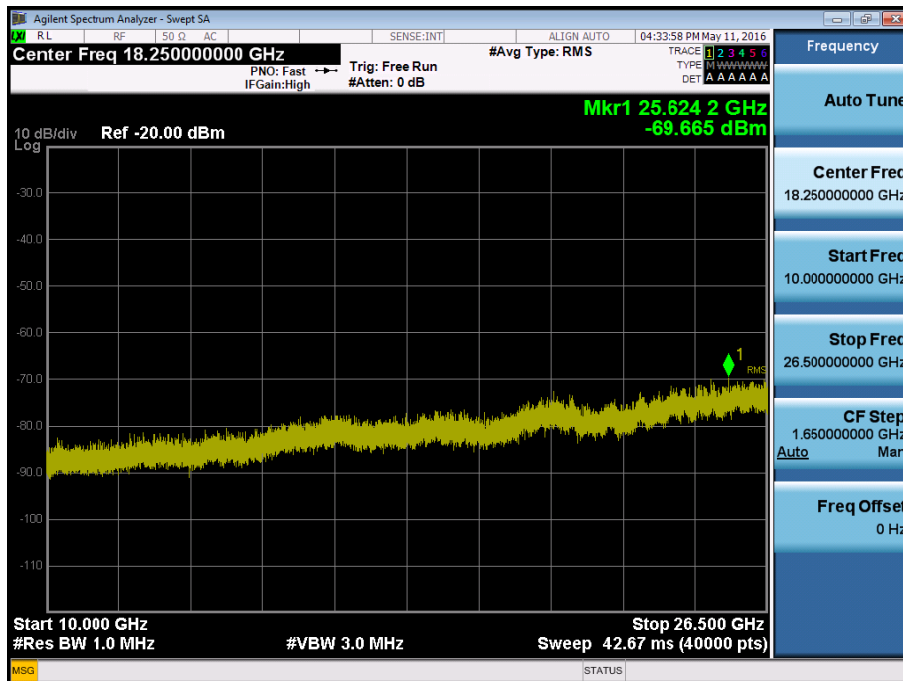

BAND7. Conducted Spurious Plot 1 (15MHz Ch.21375 QPSK RB 1, Offset 0)

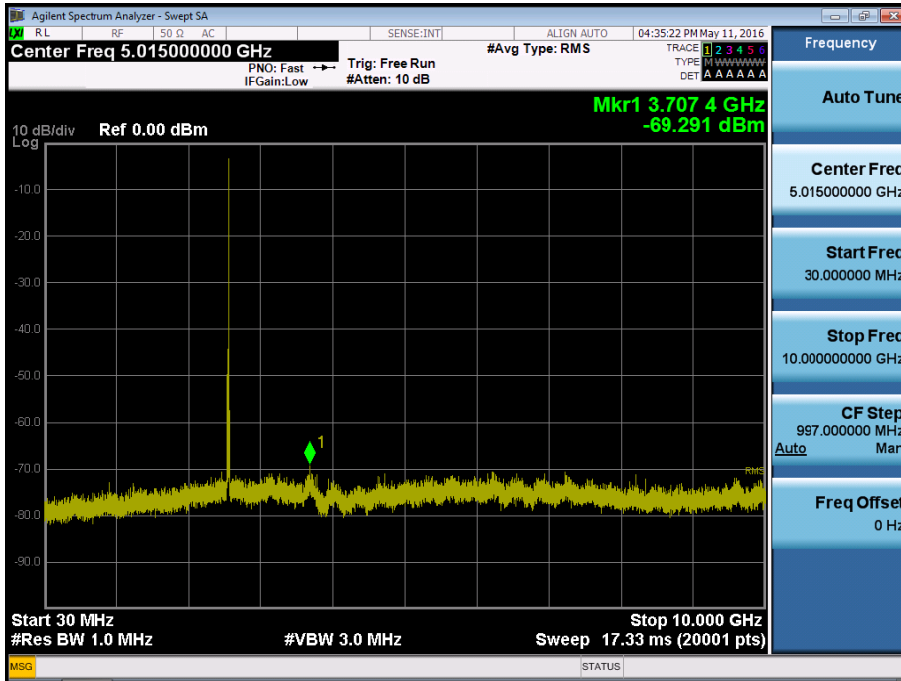

BAND7. Conducted Spurious Plot 2 (15MHz Ch.21375 QPSK RB 1, Offset 0)

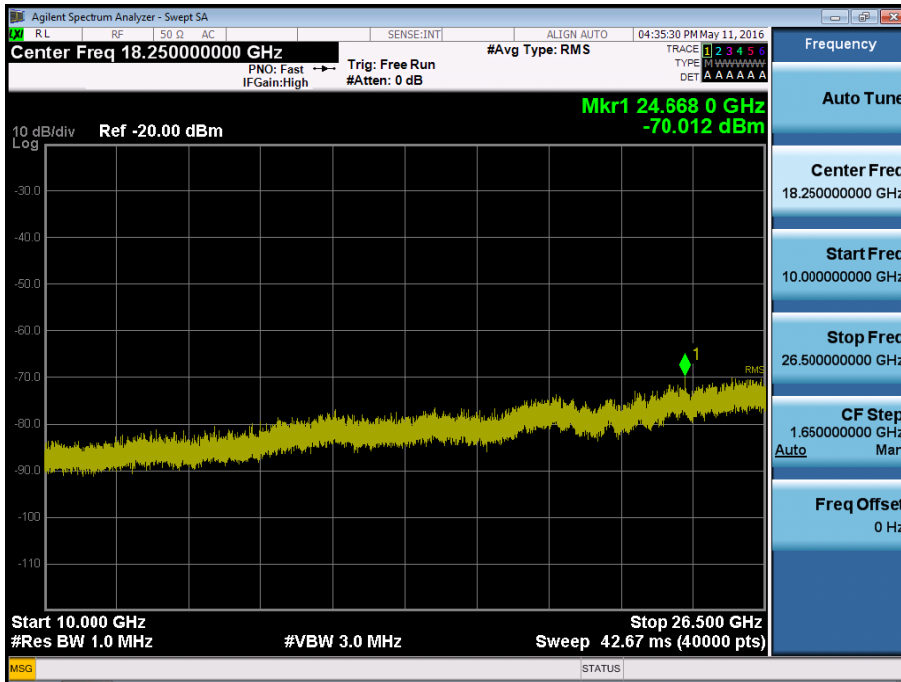

BAND7. Conducted Spurious Plot 1 (20MHz Ch.20850 QPSK RB 1, Offset 0)

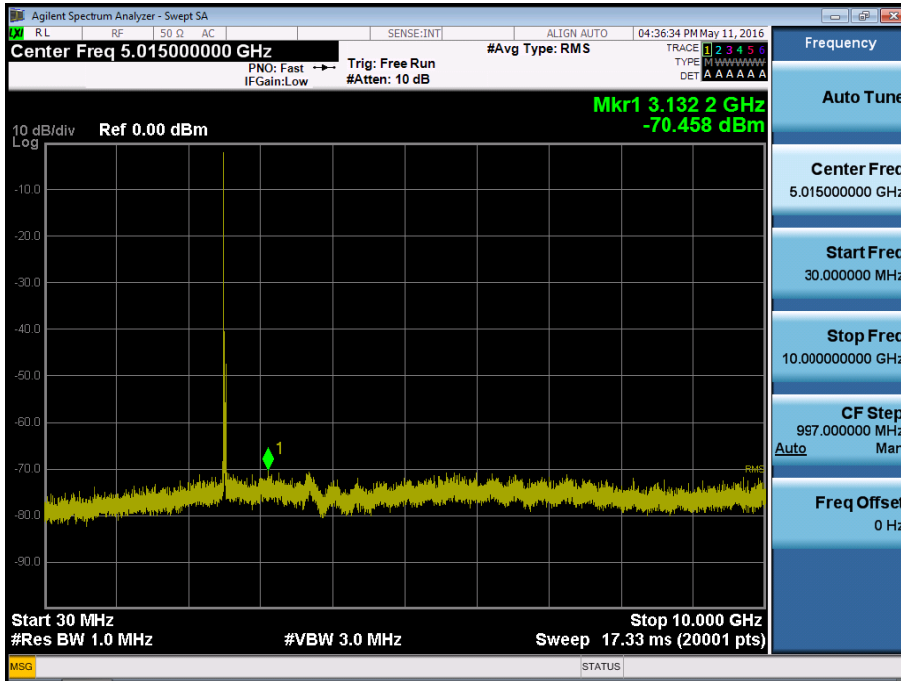

BAND7. Conducted Spurious Plot 2 (20MHz Ch.20850 QPSK RB 1, Offset 0)

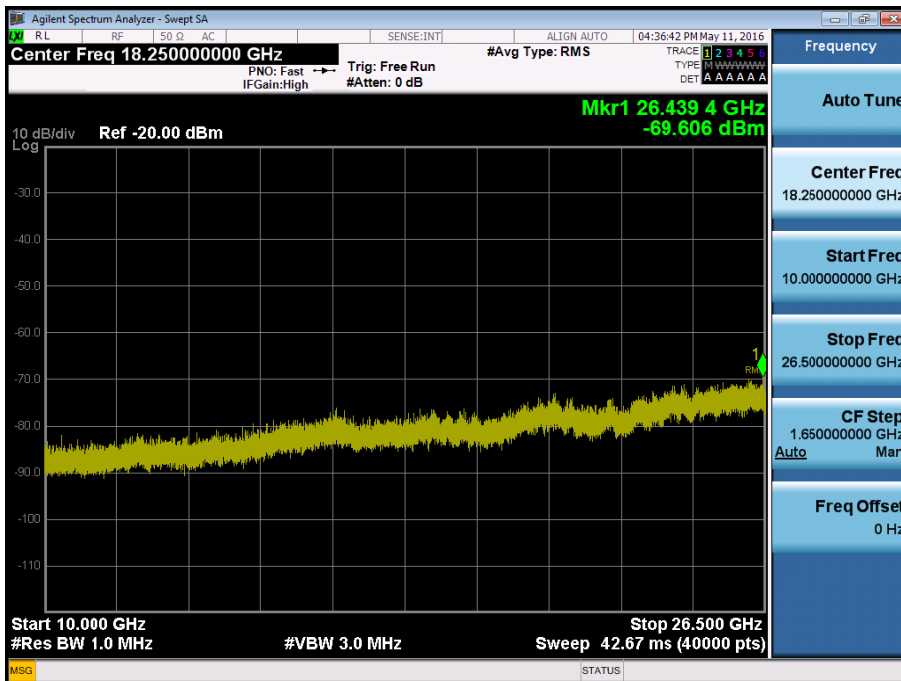

BAND7. Conducted Spurious Plot 1 (20MHz Ch.21100 QPSK RB 1, Offset 0)

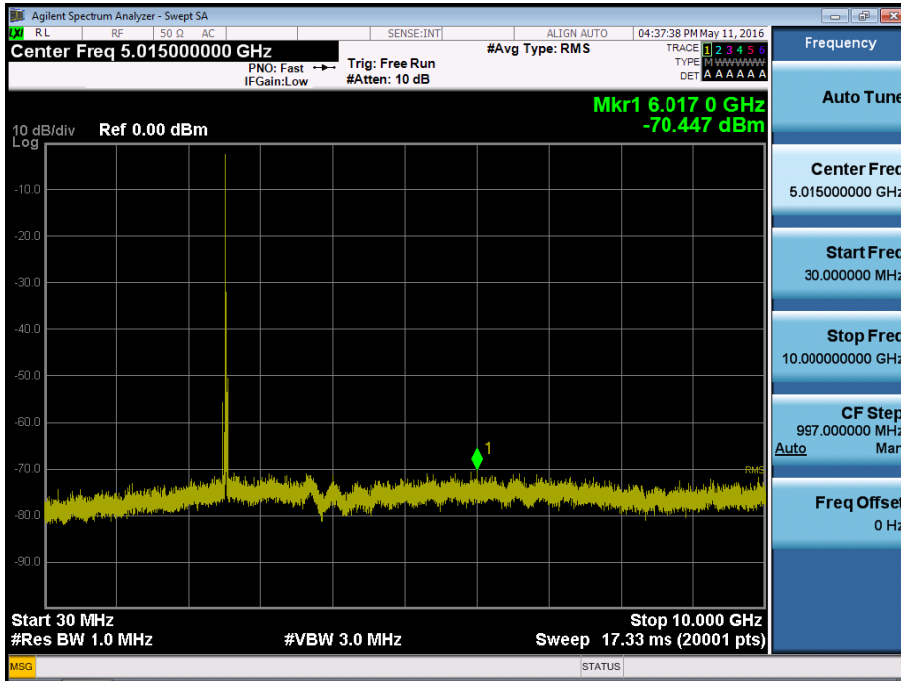

BAND7. Conducted Spurious Plot 2 (20MHz Ch.21100 QPSK RB 1, Offset 0)

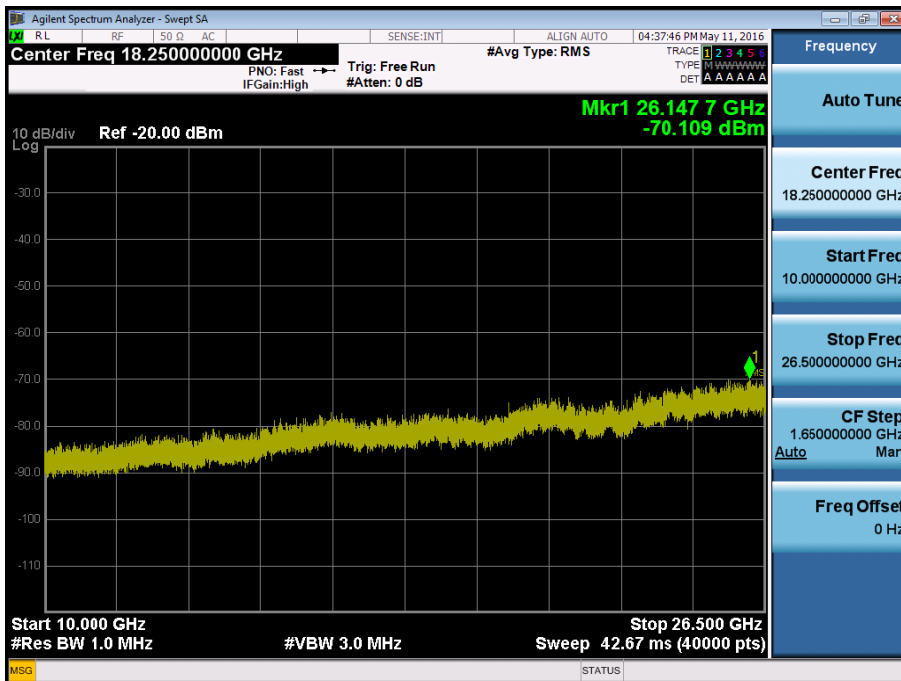

BAND7. Conducted Spurious Plot 1 (20MHz Ch.21350 QPSK RB 1, Offset 0)

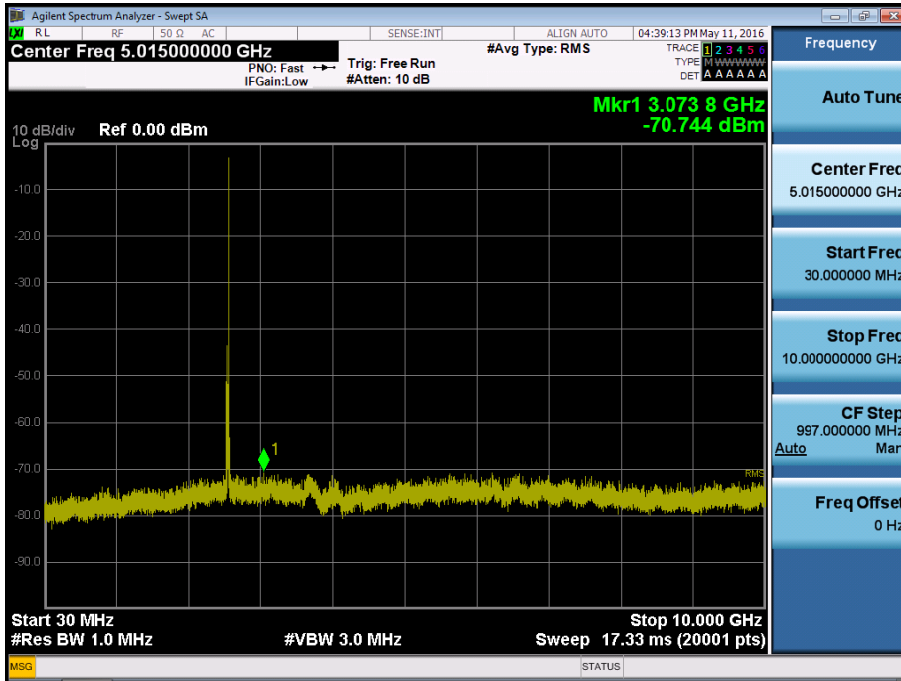

BAND7. Conducted Spurious Plot 2 (20MHz Ch.21350 QPSK RB 1, Offset 0)

