

FCC GSM/WCDMA REPORT

FCC Certification

Applicant Name: LG Electronics MobileComm U.S.A., Inc.	Date of Issue: August 19, 2016
Address: 1000 Sylvan Avenue, Englewood Cliffs NJ 07632	Location: HCT CO., LTD., 74, Seoicheon-ro 578beon-gil, Majang-myeon, Icheon-si, Gyeonggi-do, 17383, Rep. of KOREA
	Report No.: HCT-R-1608-F021 HCT FRN: 0005866421

FCC ID:	ZNFH990
APPLICANT:	LG Electronics MobileComm U.S.A., Inc.

FCC Model(s): LG-H990
Additional FCC Model(s): LG-H990TR, LG-H990ds
EUT Type: GSM/WCDMA/LTE Phone with Bluetooth, WLAN, NFC
FCC Classification: Licensed Portable Transmitter Held to Ear (PCE)
FCC Rule Part(s): §22, §24, §27, §2

Mode	Tx Frequency (MHz)	Rx Frequency (MHz)	Emission Designator	ERP	
				Max. Power (W)	Max. Power (dBm)
GSM850	824.2 – 848.8	869.2 – 893.8	242 KGXW	0.810	29.09
GSM850 EDGE			247 KG7W	0.211	23.25
WCDMA850	826.4 – 846.6	871.4 – 891.6	4M16F9W	0.100	20.01

Mode	Tx Frequency (MHz)	Rx Frequency (MHz)	Emission Designator	EIRP	
				Max. Power (W)	Max. Power (dBm)
GSM1900	1850.2 – 1909.8	1930.2 – 1989.8	244 KGXW	0.846	29.28
GSM1900 EDGE			242 KG7W	0.350	25.44
WCDMA1900	1852.4 – 1907.6	1932.4 – 1987.6	4M17F9W	0.118	20.71
WCDMA1700	1712.4 – 1752.6	2112.4 – 2152.6	4M15F9W	0.172	22.34

The measurements shown in this report were made in accordance with the procedures specified in CFR47 section §2.947. I assume full responsibility for the accuracy and completeness of these measurements, and for the qualifications of all persons taking them.

HCT CO., LTD. Certifies that no party to this application has subject to a denial of Federal benefits that includes FCC benefits pursuant to section 5301 of the Anti-Drug Abuse Act of 1998, 21 U.S. C. 853(a)



Report prepared by
: Jeong Ho Kim
Test engineer of RF Team



Approved by
: Kyoung Houn Seo
Manager of RF Team

This report only responds to the tested sample and may not be reproduced, except in full, without written approval of the HCT Co., Ltd.

Version

TEST REPORT NO.	DATE	DESCRIPTION
HCT-R-1608-F021	August 19, 2016	- First Approval Report

Table of Contents

1. GENERAL INFORMATION	4
2. INTRODUCTION	5
2.1. EUT DESCRIPTION.....	5
2.2. MEASURING INSTRUMENT CALIBRATION.....	5
2.3. TEST FACILITY	5
3. DESCRIPTION OF TESTS	6
3.1 ERP/EIRP RADIATED POWER AND RADIATED SPURIOUS EMISSIONS.....	6
3.2 PEAK- TO- AVERAGE RATIO	7
3.3 OCCUPIED BANDWIDTH.	9
3.4 SPURIOUS AND HARMONIC EMISSIONS AT ANTENNA TERMINAL.....	10
3.5 FREQUENCY STABILITY / VARIATION OF AMBIENT TEMPERATURE	11
4. LIST OF TEST EQUIPMENT	12
5. MEASUREMENT UNCERTAINTY	13
6. SUMMARY OF TEST RESULTS	14
7. SAMPLE CALCULATION	15
8. TEST DATA	16
8.1 EFFECTIVE RADIATED POWER	16
8.2 EQUIVALENT ISOTROPIC RADIATED POWER	17
8.3 RADIATED SPURIOUS EMISSIONS	19
8.3.1 RADIATED SPURIOUS EMISSIONS (GSM850)	19
8.3.2 RADIATED SPURIOUS EMISSIONS(GSM1900)	20
8.3.3 RADIATED SPURIOUS EMISSIONS (WCDMA850)	21
8.3.4 RADIATED SPURIOUS EMISSIONS (WCDMA1900)	22
8.3.5 RADIATED SPURIOUS EMISSIONS (WCDMA1700).....	23
8.4 PEAK-TO-AVERAGE RATIO	24
8.5 OCCUPIED BANDWIDTH	25
8.6 CONDUCTED SPURIOUS EMISSIONS	26
8.6.1 BAND EDGE.....	26
8.7 FREQUENCY STABILITY / VARIATION OF AMBIENT TEMPERATURE	27
8.7.1 FREQUENCY STABILITY (GSM850)	27
8.7.2 FREQUENCY STABILITY (GSM1900)	28
8.7.3 FREQUENCY STABILITY (WCDMA850)	29
8.7.4 FREQUENCY STABILITY (WCDMA1900)	30
8.7.5 FREQUENCY STABILITY (WCDMA1700)	31
9. TEST PLOTS.....	32

MEASUREMENT REPORT

1. GENERAL INFORMATION

Applicant Name: LG Electronics MobileComm U.S.A., Inc.

Address: 1000 Sylvan Avenue, Englewood Cliffs NJ 07632

FCC ID: ZNFH990

Application Type: Certification

FCC Classification: Licensed Portable Transmitter Held to Ear (PCE)

FCC Rule Part(s): §22, §24, §27, §2

EUT Type: GSM/WCDMA/LTE Phone with Bluetooth, WLAN, NFC

FCC Model(s): LG-H990

Additional FCC Model(s): LG-H990TR, LG-H990ds

Tx Frequency:
824.20 - 848.80 MHz (GSM850)
826.40 - 846.60 MHz (WCDMA850)
1 850.20 - 1 909.80 MHz (GSM1900)
1 852.4 - 1 907.6 MHz (WCDMA1900)
1 712.4 - 1 752.6 MHz (WCDMA1700)

Rx Frequency:
869.20 - 893.80 MHz (GSM850)
871.40 - 891.60 MHz (WCDMA850)
1 930.20 - 1 989.80 MHz (GSM1900)
1 932.4 - 1 987.6 MHz (WCDMA1900)
2 112.4 - 2 152.6 MHz (WCDMA1700)

Max. RF Output Power:
0.810 W GSM850 (29.09 dBm) / 0.846 W GSM1900 (29.28 dBm)
0.211 W GSM850 EDGE (23.25 dBm) / 0.350 W GSM1900 EDGE (25.44 dBm)
0.100 W WCDMA850 (20.01 dBm) / 0.118 W WCDMA1900 (20.71 dBm)
0.172 W WCDMA1700 (22.34 dBm)

Emission Designator(s):
242 KGXW (GSM850) 244 KGXW (GSM1900)
247 KG7W (GSM850 EDGE) 242 KG7W (GSM1900 EDGE)
4M16F9W (WCDMA850) 4M17F9W (WCDMA1900)
4M15F9W (WCDMA1700)

Date(s) of Tests: July 19, 2016 ~ August 19, 2016

Antenna Specification:
Manufacturer: Ace Technology
Antenna type: PIFA Antenna (Planar Inverted F)
Peak Gain: GSM850/ WCDMA850 : -8.1 dBi
GSM1900/ WCDMA1900 : -1.0 dBi
WCDMA1700 : -2.7 dBi

2. INTRODUCTION

2.1. EUT DESCRIPTION

The LG Electronics MobileComm U.S.A., Inc. LG-H990 GSM/WCDMA/LTE Phone with Bluetooth, WLAN, NFC consists of GPRS Class33, EDGE33, GSM850, GSM1900, WCDMA850, WCDMA1900, WCDMA1700, HSDPA, HSUPA, and HSPA+.

2.2. MEASURING INSTRUMENT CALIBRATION

The measuring equipment, which was utilized in performing the tests documented herein, has been calibrated in accordance with the manufacturer's recommendations for utilizing calibration equipment, which is traceable to recognized national standards.

2.3. TEST FACILITY

The Fully-anechoic chamber and conducted measurement facility used to collect the radiated data are located at the **74, Seoicheon-ro 578beon-gil, Majang-myeon, Icheon-si, Gyeonggi-do, 17383, Rep. of KOREA.**

3. DESCRIPTION OF TESTS

3.1 ERP/EIRP RADIATED POWER AND RADIATED SPURIOUS EMISSIONS

Note: ERP(Effective Radiated Power), EIRP(Effective Isotropic Radiated Power)

Test Procedure

Radiated emission measurements are performed in the Fully-anechoic chamber. The equipment under test is placed on a non-conductive table 3-meters away from the receive antenna in accordance with ANSI/TIA-603-D-2010 Clause 2.2.17. The turntable is rotated through 360 degrees, and the receiving antenna scans in order to determine the level of the maximized emission. The level and position of the maximized emission is recorded with the spectrum analyzer using RMS detector.

A half wave dipole is then substituted in place of the EUT. For emissions above 1GHz, a horn antenna is substituted in place of the EUT. The substitute antenna is driven by a signal generator and the previously recorded signal was duplicated.

The power is calculated by the following formula;

$$P_{d(\text{dBm})} = P_{g(\text{dBm})} - \text{cable loss}_{(\text{dB})} + \text{antenna gain}_{(\text{dB})}$$

Where: P_d is the dipole equivalent power and P_g is the generator output power into the substitution antenna.

The maximum EIRP is calculated by adding the forward power to the calibrated source plus its appropriate gain value. These steps are repeated with the receiving antenna in both vertical and horizontal polarization. the difference between the gain of the horn and an isotropic antenna are taken into consideration

Radiated spurious emissions

1. Frequency Range : 30 MHz ~ 10th Harmonics of highest channel fundamental frequency.
2. The EUT was setup to maximum output power. The 100 kHz RBW was used to scan from 30 MHz to 1 GHz. Also, the 1 MHz RBW was used to scan from 1 GHz to 10 GHz(GSM850/WCDMA850) or 20 GHz(GSM1900/WCDMA1900/WCDMA1700). The high, low and a middle channel were tested for out of band measurements.

3.2 PEAK- TO- AVERAGE RATIO

Test Procedure

Peak to Average Power Ratio is tested in accordance with KDB971168 D01 Power Meas License Digital Systems v02r02, October 17, 2014, Section 5.7.

- Section 5.7.1 CCDF Procedure for PAPR

- a) Set resolution/measurement bandwidth \geq signal's occupied bandwidth;
- b) Set the number of counts to a value that stabilizes the measured CCDF curve;
- c) Set the measurement interval as follows:
 - 1) for continuous transmissions, set to 1 ms,
 - 2) for burst transmissions, employ an external trigger that is synchronized with the EUT burst timing sequence, or use the internal burst trigger with a trigger level that allows the burst to stabilize and set the measurement interval to a time that is less than or equal to the burst duration.
- d) Record the maximum PAPR level associated with a probability of 0.1%.

- Section 5.7.2 Alternate Procedure for PAPR

Use one of the procedures presented in 5.1 to measure the total peak power and record as P_{Pk} . Use one of the applicable procedures presented 5.2 to measure the total average power and record as P_{Avg} . Determine the P.A.R. from: $P.A.R._{(dB)} = P_{Pk (dBm)} - P_{Avg (dBm)}$ (P_{Avg} = Average Power + Duty cycle Factor)

5.1.1 Peak power measurements with a spectrum/signal analyzer or EMI receiver

The following procedure can be used to determine the total peak output power.

- a) Set the RBW \geq OBW.
- b) Set VBW $\geq 3 \times$ RBW.
- c) Set span $\geq 2 \times$ RBW
- d) Sweep time = auto couple.
- e) Detector = peak.
- f) Ensure that the number of measurement points \geq span/RBW.
- g) Trace mode = max hold.
- h) Allow trace to fully stabilize.
- i) Use the peak marker function to determine the peak amplitude level.

5.2.2 Procedures for use with a spectrum/signal analyzer when EUT cannot be configured to transmit continuously and sweep triggering/signal gating cannot be properly implemented

If the EUT cannot be configured to transmit continuously (burst duty cycle < 98%), then one of the following procedures can be used. The selection of the applicable procedure will depend on the characteristics of the measured burst duty cycle.

Measure the burst duty cycle with a spectrum/signal analyzer or EMC receiver can be used in zero-span mode if the response time and spacing between bins on the sweep are sufficient to permit accurate measurement of the burst on/off time of the transmitted signal.

5.2.2.2 Constant burst duty cycle

If the measured burst duty cycle is constant (i.e., duty cycle variations are less than ± 2 percent), then:

- a) Set span to at least 1.5 times the OBW.
- b) Set RBW = 1-5% of the OBW, not to exceed 1 MHz.
- c) Set VBW $\geq 3 \times$ RBW.
- d) Number of points in sweep $\geq 2 \times$ span / RBW. (This gives bin-to-bin spacing \leq RBW/2, so that narrowband signals are not lost between frequency bins.)
- e) Sweep time = auto.
- f) Detector = RMS (power averaging).
- g) Set sweep trigger to "free run".
- h) Trace average at least 100 traces in power averaging (i.e., RMS) mode.
- i) Compute power by integrating the spectrum across the OBW of the signal using the instrument's band power measurement function with band limits set equal to the OBW band edges. If the instrument does not have a band power function, sum the spectrum levels (in power units) at intervals equal to the RBW extending across the entire OBW of the spectrum.
- j) Add $10 \log (1/x)$, where x is the duty cycle, to the measured power in order to compute the average power during the actual transmission times (because the measurement represents an average over both the on and off times of the transmission).

For example, add $10 \log (1/0.25) = 6$ dB if the duty cycle is a constant 25%.

3.3 OCCUPIED BANDWIDTH.

Test set-up

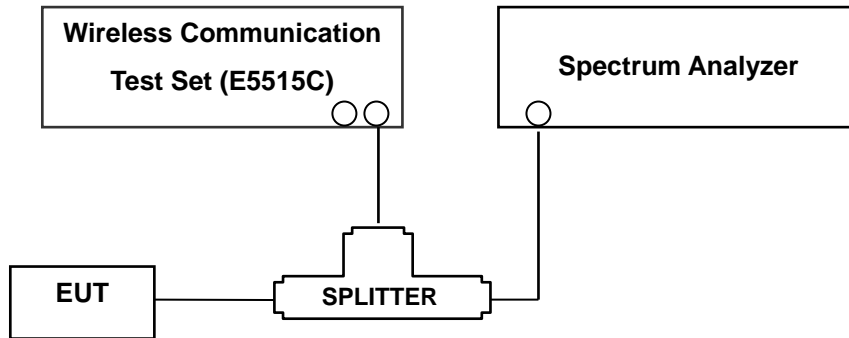

(Configuration of conducted Emission measurement)

The width of a frequency band such that, below the lower and above the upper frequency limits, the mean powers emitted are each equal to a specified percentage 0.5 % of the total mean power of a given emission.

Test Procedure

OBW is tested in accordance with KDB971168 D01 Power Meas License Digital Systems v02r02, October 17, 2014, Section 4.2.

The EUT makes a call to the communication simulator. The power was measured with R&S Spectrum Analyzer. All measurements were done at 3 channels(low, middle and high operational range.)

The conducted occupied bandwidth used the power splitter via EUT RF power connector between simulation base station and spectrum analyzer.

The communication simulator station system controlled a EUT to export maximum output power under transmission mode and specific channel frequency. Use OBW measurement function of Spectrum analyzer to measure 99 % occupied bandwidth

3.4 SPURIOUS AND HARMONIC EMISSIONS AT ANTENNA TERMINAL.

Test Procedure

Spurious and harmonic emissions at antenna terminal is tested in accordance with KDB971168 D01 Power Meas License Digital Systems v02r02, October 17, 2014, Section 6.0.

The level of the carrier and the various conducted spurious and harmonic frequencies is measured by means of a calibrated spectrum analyzer.

On any frequency outside a licensee's frequency block, the power of any emission shall be attenuated below the transmitter power (P) by at least $43 + 10 \log(P)$ dB. The RBW settings used in the testing are greater than 1 % of the occupied bw. The 1 MHz RBW was used to scan from 10 MHz to 10 GHz. (GSM1900 Mode: 10 MHz to 20 GHz). A display line was placed at - 13 dBm to show compliance. The high, lowest and a middle channel were tested for out of band measurements.

Measurements of all out of band are made on RBW = 1MHz and VBW \geq 3 MHz in the worst case despite RBW = 100 kHz and VBW \geq 300 kHz upon 1 GHz.

- RBW = 1 MHz
- VBW \geq 3 MHz
- Detector = Peak
- Trace Mode = max hold
- Sweep time = auto
- Number of points in sweep \geq 2 * Span / RBW

- Band Edge Requirement : According to FCC 22.917, 24.238, 27.53 specified that power of any emission outside of The authorized operating frequency ranges must be attenuated below the transmitting power (P) by a factor of at least $43 + 10 \log(P)$ dB. In the 1 MHz bands immediately outside and adjacent to the frequency block a resolution bandwidth of at least one percent of the emission bandwidth of the fundamental emission of the transmitter may be employed.

All measurements were done at 2 channels(low and high operational frequency range.)

The band edge measurement used the power splitter via EUT RF power connector between simulation base station and spectrum analyzer.

In GSM mode, the center frequency of spectrum set to the band edge frequency. The span is 1MHz (RBW = at least 1 % of the EBW, VBW \geq 3*RBW, Detector = Average).

In WCDMA mode, the center frequency of spectrum set to the band edge frequency. The span is 7MHz (RBW = at least 1% of the EBW, \geq 3*RBW, Detector = Average).

NOTES: The analyzer plot offsets were determined by below conditions.

- For GSM850 and WCDMA850, total offset 26.8 dB = 20 dB attenuator + 6 dB Splitter + 0.8 dB RF cables.
- For GSM1900 and WCDMA1900, total offset 27.3 dB = 20 dB attenuator + 6 dB Splitter + 1.3 dB RF cables.
- For WCDMA1700, total offset 27.2 dB = 20 dB attenuator + 6 dB Splitter + 1.2 dB RF cables.

3.5 FREQUENCY STABILITY / VARIATION OF AMBIENT TEMPERATURE

Test Set-up

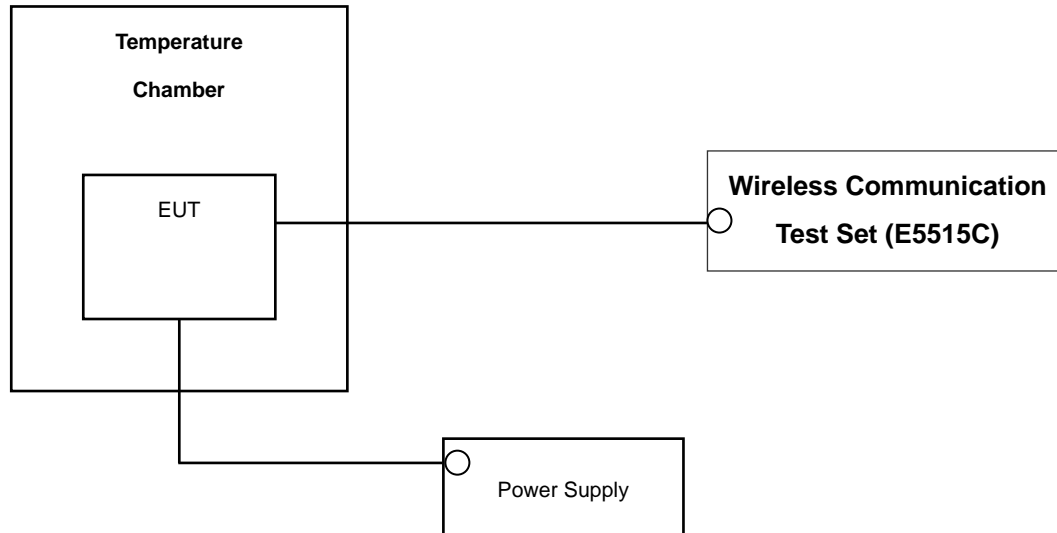

* Nominal Operating Voltage

Test Procedure

Frequency stability is tested in accordance with ANSI/TIA-603-D-2010 section 2.2.2.

The frequency stability of the transmitter is measured by:

- a.) **Temperature:** The temperature is varied from - 30 °C to + 50 °C using an environmental chamber.
- b.) **Primary Supply Voltage:** The primary supply voltage is varied from battery end point to 100 % of the voltage normally at the input to the device or at the power supply terminals if cables are not normally supplied.

Specification — the frequency stability shall be sufficient to ensure that the fundamental emission stays within the authorized frequency block(GSM1900/WCDMA1900/WCDMA1700). The frequency stability of the transmitter shall be maintained within $\pm 0.00025\%$ (± 2.5 ppm) of the center frequency(GSM850/WCDMA850).

Time Period and Procedure:

The carrier frequency of the transmitter is measured at room temperature (20°C to provide a reference).

1. The equipment is turned on in a "standby" condition for one minute before applying power to the transmitter. Measurement of the carrier frequency of the transmitter is made within one minute after applying power to the transmitter.
2. Frequency measurements are made at 10°C intervals ranging from -30°C to +50°C. A period of at least one half-hour is provided to allow stabilization of the equipment at each temperature level.

NOTE: The EUT is tested down to the battery endpoint.

4. LIST OF TEST EQUIPMENT

Manufacture	Model/ Equipment	Serial Number	Calibration Interval	Calibration Due
MITEQ	AMF-6D-001180-35-20P/AMP	1081666	Annual	09/03/2016
Wainwright	WHK1.2/15G-10EF/H.P.F	4	Annual	04/11/2017
Wainwright	WHK3.3/18G-10EF/H.P.F	2	Annual	04/11/2017
Hewlett Packard	11667B / Power Splitter	10545	Annual	02/15/2017
Hewlett Packard	11667B / Power Splitter	11275	Annual	04/29/2017
Agilent	E3632A/DC Power Supply	KR75303243	Annual	07/12/2017
Schwarzbeck	UHAP/ Dipole Antenna	557	Biennial	03/23/2017
Schwarzbeck	UHAP/ Dipole Antenna	558	Biennial	03/23/2017
EXP	EX-TH400/ Chamber	None	Annual	05/31/2017
Schwarzbeck	BBHA 9120D/ Horn Antenna	147	Biennial	09/01/2016
Schwarzbeck	BBHA 9120D/ Horn Antenna	1299	Biennial	05/15/2017
Schwarzbeck	BBHA 9170/ Horn Antenna(15~40GHz)	BBHA9170342	Biennial	04/30/2017
Schwarzbeck	BBHA 9170/ Horn Antenna(15~35GHz)	BBHA9170124	Biennial	04/30/2017
Agilent	N9020A/Signal Analyzer	MY52090906	Annual	05/13/2017
Hewlett Packard	8493C/ATTENUATOR	17280	Annual	06/22/2017
REOHDE&SCHWARZ	FSV40/Spectrum Analyzer	1307.9002K40-100931-NK	Annual	06/15/2017
Agilent	8960 (E5515C)/ Base Station	MY48360800	Annual	10/30/2016
Anritsu Corp.	MT8820C/Wideband Radio Communication Tester	6200863156	Annual	02/26/2017
Anritsu Corp.	MT8820C/Wideband Radio Communication Tester	6201026545	Annual	02/16/2017
Schwarzbeck	VULB9160/ Bilog Antenna	3150	Biennial	11/17/2016
Schwarzbeck	VULB9160/ Bilog Antenna	3368	Biennial	10/10/2016

5. MEASUREMENT UNCERTAINTY

The measurement uncertainties shown below were calculated in accordance with the requirements of ANSI C63.4:2014.

All measurement uncertainty values are shown with a coverage factor of $k = 2$ to indicate a 95 % level of confidence. The measurement data shown herein meets or exceeds the U_{CISPR} measurement uncertainty values specified in CISPR 16-4-2 and, thus, can be compared directly to specified limits to determine compliance.

Parameter	Expanded Uncertainty (\pm dB)
Conducted Disturbance (150 kHz ~ 30 MHz)	1.82
Radiated Disturbance (9 kHz ~ 30 MHz)	3.40
Radiated Disturbance (30 MHz ~ 1 GHz)	4.80
Radiated Disturbance (1 GHz ~ 18 GHz)	6.07

6. SUMMARY OF TEST RESULTS

FCC Part Section(s)	Test Description	Test Limit	Test Condition	Test Result
2.1049	Occupied Bandwidth	N/A	CONDUCTED	PASS
2.1051, 22.917(a), 24.238(a), 27.53(h)	Band Edge / Spurious and Harmonic Emissions at Antenna Terminal.	< 43 + 10log10 (P[Watts]) at Band Edge and for all out-of-band emissions		PASS
2.1046	* Conducted Output Power	-		PASS
24.232(d), 27.50(d)(5)	Peak- to- Average Ratio	< 13 dB		PASS
2.1055, 22.355	Frequency stability / variation of ambient temperature	< 2.5 ppm (Part22)		PASS
24.235, 27.54		Emission must remain in band (Part24, 27)		PASS
22.913(a)(2)	Effective Radiated Power	< 7 Watts max. ERP	RADIATED	PASS
24.232(c)	Equivalent Isotropic Radiated Power	< 2 Watts max. EIRP		PASS
27.50(d)(4)	Equivalent Isotropic Radiated Power	<1 Watts max. EIRP		PASS
2.1053, 22.917(a), 24.238(a), 27.53(h)	Radiated Spurious and Harmonic Emissions	< 43 + 10log10 (P[Watts]) for all out-of band emissions		PASS

*: See SAR Report

7. SAMPLE CALCULATION

A. ERP Sample Calculation

Mode	Ch./ Freq.		Measured Level(dBm)	Substitute LEVEL(dBm)	Ant. Gain (dBd)	C.L	Pol.	Limit W	ERP	
	channel	Freq.(MHz)							W	dBm
GSM850	128	824.20	-21.37	38.40	-10.61	0.95	H	< 7.00	0.483	26.84

ERP = Substitute LEVEL(dBm) + Ant. Gain – CL(Cable Loss)

- 1) The EUT mounted on a non-conductive turntable is 2.5 meter above test site ground level.
- 2) During the test , the turn table is rotated until the maximum signal is found.
- 3) Record the field strength meter's level.
- 4) Replace the EUT with dipole/Horn antenna that is connected to a calibrated signal generator.
- 5) Increase the signal generator output till the field strength meter's level is equal to the item (3).
- 6) The signal generator output level with Ant. Gain and cable loss are the rating of effective radiated power (ERP).

B. Emission Designator

GSM Emission Designator

Emission Designator = 249KGXW

GSM BW = 249 kHz

G = Phase Modulation

X = Cases not otherwise covered

W = Combination (Audio/Data)

EDGE Emission Designator

Emission Designator = 249KG7W

GSM BW = 249 kHz

G = Phase Modulation

7 = Quantized/Digital Info

W = Combination (Audio/Data)

WCDMA Emission Designator

Emission Designator = 4M17F9W

WCDMA BW = 4.17 MHz

F = Frequency Modulation

9 = Composite Digital Info

W = Combination (Audio/Data)

8. TEST DATA

8.1 EFFECTIVE RADIATED POWER

(GSM850 Mode)

Mode	Ch./ Freq.		Measured Level (dBm)	Substitute LEVEL (dBm)	Ant. Gain (dBd)	C.L	Pol.	Limit	ERP	
	channel	Freq.(MHz)						W	W	dBm
GSM850	128	824.2	-21.22	41.30	-10.59	1.67	H	< 7.00	0.802	29.04
	190	836.6	-22.29	41.31	-10.54	1.68	H		0.810	29.09
	251	848.8	-23.02	39.99	-10.48	1.69	H		0.605	27.82
EDGE	190	836.6	-28.13	35.47	-10.54	1.68	H		0.211	23.25

(WCDMA850 Mode)

Mode	Ch./ Freq.		Measured Level (dBm)	Substitute LEVEL (dBm)	Ant. Gain (dBd)	C.L	Pol.	Limit	ERP	
	channel	Freq.(MHz)						W	W	dBm
WCDMA850	4132	826.4	-30.51	32.26	-10.58	1.67	H	< 7.00	0.100	20.01
	4183	836.6	-31.42	32.18	-10.54	1.68	H		0.099	19.96
	4233	846.6	-31.71	31.53	-10.50	1.69	H		0.086	19.34

Note: Standard batteries are the only options for this phone.

NOTES:

Effective Radiated Power Output Measurements by Substitution Method according to ANSI/TIA/EIA-603-D-2010 June 24, 2010:

The EUT was placed on a non-conductive styrofoam resin table 3-meters from the receive antenna. Turntable rotation was adjusted for the highest reading on the receive spectrum analyzer. For WCDMA, GSM signals, RBW = 1-5% of the OBW, not to exceed 1MHz, VBW ≥ 3 x RBW, Detector = RMS. A half-wave dipole was substituted in place of the EUT. This dipole antenna was driven by a signal generator and the level of the signal generator was adjusted to obtain the same receive spectrum analyzer reading. The conducted power at the terminals of the dipole is measured. The ERP is recorded.

This device was tested under all configurations and the highest power is reported in WCDMA mode with HSDPA Inactive at 12.2 kbps RMC and TPC bits all set to "1" and in GSM mode using a Power Control Level of "0" in the PCS Band and "5" in the Cellular Band. This unit was tested with its standard battery. Also, we have done x, y, z planes in EUT and horizontal and vertical polarization in detecting antenna. The worst case of the EUT is x plane in GSM850 and WCDMA850 mode. Also worst case of detecting Antenna is in horizontal polarization in GSM850 and WCDMA850 mode.

The EDGE mode testing were performed using 1Tx because 1Tx is highest power in EDGE mode.

8.2 EQUIVALENT ISOTROPIC RADIATED POWER

(GSM1900 Mode)

Mode	Ch./ Freq.		Measured Level (dBm)	Substitute LEVEL (dBm)	Ant. Gain (dBi)	C.L	Pol.	Limit	EIRP	
	channel	Freq.(MHz)						W	W	dBm
GSM1900	512	1850.2	-11.80	21.81	9.82	2.54	V	< 2.00	0.811	29.09
	661	1880.0	-11.94	21.94	9.91	2.57	V		0.846	29.28
	810	1909.8	-13.10	21.14	10.00	2.60	V		0.714	28.54
EDGE	661	1880.0	-15.78	18.10	9.91	2.57	V		0.350	25.44

Note: Standard batteries are the only options for this phone.

NOTES:

Equivalent Isotropic Radiated Power Measurements by Substitution Method according to ANSI/TIA/EIA-603-D-2010 June 24, 2010:

The EUT was placed on a non-conductive styrofoam resin table 3-meters from the receive antenna. Turntable rotation was adjusted for the highest reading on the receive spectrum analyzer. For GSM signals, RBW = 1-5% of the OBW, not to exceed 1MHz, VBW ≥ 3 x RBW, Detector = RMS. A Horn antenna was substituted in place of the EUT. This Horn antenna was driven by a signal generator and the level of the signal generator was adjusted to obtain the same receive spectrum analyzer reading. The conducted power at the terminals of the Horn antenna is measured. The difference between the gain of the horn and an isotropic antenna is taken into consideration and the EIRP is recorded.

This device was tested under all configurations and the highest power is reported in GSM mode using a Power Control Level of "0" in the PCS Band and "5" in the Cellular Band. This unit was tested with its standard battery. Also, we have done x, y, z planes in EUT and horizontal and vertical polarization in detecting antenna. The worst case of the EUT is z plane in GSM1900 mode. Also worst case of detecting Antenna is in vertical polarization in GSM1900 mode.

The EDGE mode testing were performed using 1Tx because 1Tx is highest power in EDGE mode.

(WCDMA1900 Mode)

Mode	Ch./ Freq.		Measured Level (dBm)	Substitute LEVEL (dBm)	Ant. Gain (dBi)	C.L	Pol.	Limit	EIRP	
	channel	Freq.(MHz)						W	W	dBm
WCDMA1900	9262	1852.4	-20.18	13.43	9.82	2.54	V	< 2.00	0.118	20.71
	9400	1880.0	-20.72	13.16	9.91	2.57	V		0.112	20.50
	9538	1907.6	-21.52	12.72	10.00	2.60	V		0.103	20.12

(WCDMA1700 Mode)

Mode	Ch./ Freq.		Measured Level (dBm)	Substitute LEVEL (dBm)	Ant. Gain (dBi)	C.L	Pol.	Limit	EIRP	
	channel	Freq.(MHz)						W	W	dBm
WCDMA1700	1312	1712.4	-18.52	14.82	9.37	2.45	H	< 1.00	0.149	21.74
	1412	1732.4	-18.56	14.76	9.44	2.47	H		0.149	21.73
	1513	1752.6	-18.02	15.30	9.51	2.47	H		0.172	22.34

Note: Standard batteries are the only options for this phone.

NOTES:

Equivalent Isotropic Radiated Power Measurements by Substitution Method according to ANSI/TIA/EIA-603-D-2010 June 24, 2010:

The EUT was placed on a non-conductive styrofoam resin table 3-meters from the receive antenna. Turntable rotation was adjusted for the highest reading on the receive spectrum analyzer. For WCDMA signals, rotation was adjusted for the highest reading on the receive spectrum analyzer. For WCDMA signals, RBW = 1-5% of the OBW, not to exceed 1MHz, VBW ≥ 3 x RBW, Detector = RMS. A Horn antenna was substituted in place of the EUT. This Horn antenna was driven by a signal generator and the level of the signal generator was adjusted to obtain the same receive spectrum analyzer reading. The conducted power at the terminals of the Horn antenna is measured. The difference between the gain of the horn and an isotropic antenna is taken into consideration and the EIRP is recorded.

This device was tested under all configurations and the highest power is reported in WCDMA mode with HSDPA Inactive at 12.2 kbps RMC and TPC bits all set to "1". This unit was tested with its standard battery. Also, we have done x, y, z planes in EUT and horizontal and vertical polarization in detecting antenna. The worst case of the EUT is z plane in WCDMA1900 and WCDMA1700 (x plane) mode. Also worst case of detecting Antenna is in vertical polarization in WCDMA1900 and WCDMA1700 (horizontal polarization) mode.

8.3 RADIATED SPURIOUS EMISSIONS

8.3.1 RADIATED SPURIOUS EMISSIONS (GSM850)

- MEASURED OUTPUT POWER: 29.09 dBm = 0.810 W
- MODULATION SIGNAL: GSM850
- DISTANCE: 3 meters
- LIMIT: $43 + 10 \log_{10}(W) =$ 42.09 dBc

Ch.	Freq.(MHz)	<u>Measured Level</u> [dBm]	Ant. Gain (dBd)	<u>Substitute</u> <u>Level</u> [dBm]	C.L	Pol.	ERP (dBm)	dBc
128 (824.2)	1,648.40	-47.44	9.16	-49.54	2.40	H	-42.78	71.87
	2,472.60	-51.73	10.92	-50.53	2.99	V	-42.60	71.69
	3,296.80	-56.71	11.92	-56.15	3.41	H	-47.64	76.73
190 (836.6)	1,673.20	-51.35	9.23	-53.46	2.42	H	-46.65	75.74
	2,509.80	-51.62	10.96	-50.57	2.89	V	-42.50	71.59
	3,346.40	-52.36	12.02	-52.25	3.44	V	-43.67	72.76
251 (848.8)	1,697.60	-53.92	9.34	-56.08	2.44	V	-49.18	78.27
	2,546.40	-55.17	10.98	-54.25	2.96	V	-46.23	75.32
	3,395.20	-52.59	12.13	-52.61	3.58	H	-44.06	73.15

- NOTES:**
1. Radiated Spurious Emission Measurements at 3 meters by Substitution Method according to ANSI/TIA/EIA-603-D-2010 June 24, 2010:
 2. We are performed all frequency to 10th harmonics from 30 MHz. Measurements above show only up to 3 maximum emissions noted, or would be lesser if no specific emissions from the EUT are recorded (ie: margin > 20 dB from the applicable limit) and considered that's already beyond the background noise floor.
 3. We have done x, y, z planes in EUT and horizontal and vertical polarization in detecting antenna.

8.3.2 RADIATED SPURIOUS EMISSIONS(GSM1900)

- MEASURED OUTPUT POWER: 29.28 dBm = 0.846 W
- MODULATION SIGNAL: GSM1900
- DISTANCE: 3 meters
- LIMIT: $43 + 10 \log_{10}(W) =$ 42.28 dBc

Ch.	Freq.(MHz)	<u>Measured Level</u> [dBm]	Ant. Gain (dBi)	<u>Substitute</u> <u>Level</u> [dBm]	C.L	Pol.	EIRP (dBm)	dBc
512 (1850.2)	3,700.40	-41.30	12.52	-39.49	3.74	H	-30.71	59.99
	5,550.60	-55.92	13.29	-48.21	4.82	H	-39.74	69.02
	7,400.80	-54.57	11.72	-37.71	5.69	H	-31.68	60.96
661 (1880.0)	3,760.00	-40.13	12.56	-38.49	3.71	H	-29.64	58.92
	5,640.00	-55.65	13.30	-48.15	4.96	H	-39.81	69.09
	7,520.00	-55.20	11.70	-39.02	5.70	H	-33.02	62.30
810 (1909.8)	3,819.60	-37.88	12.60	-35.31	3.89	H	-26.60	55.88
	5,729.40	-57.94	13.31	-49.83	5.12	H	-41.64	70.92
	7,639.20	-55.61	11.61	-39.07	5.60	H	-33.06	62.34

- NOTES:**
1. Radiated Spurious Emission Measurements at 3 meters by Substitution Method according to ANSI/TIA/EIA-603-D-2010 June 24, 2010:
 2. We are performed all frequency to 10th harmonics from 30 MHz. Measurements above show only up to 3 maximum emissions noted, or would be lesser if no specific emissions from the EUT are recorded (ie: margin > 20 dB from the applicable limit) and considered that's already beyond the background noise floor.
 3. We have done x, y, z planes in EUT and horizontal and vertical polarization in detecting antenna.

8.3.3 RADIATED SPURIOUS EMISSIONS (WCDMA850)

- MEASURED OUTPUT POWER: 20.01 dBm = 0.100 W
- MODULATION SIGNAL: WCDMA850
- DISTANCE: 3 meters
- LIMIT: $43 + 10 \log_{10}(W) =$ 33.01 dBc

Ch.	Freq.(MHz)	<u>Measured Level</u> [dBm]	Ant. Gain (dBd)	<u>Substitute</u> <u>Level</u> [dBm]	C.L	Pol.	ERP (dBm)	dBc
4,132 (826.4)	1,652.80	-59.90	9.16	-62.00	2.40	H	-55.24	75.25
	2,479.20	-59.04	10.93	-58.31	2.98	V	-50.36	70.37
	3,305.60	-57.40	11.94	-56.96	3.45	H	-48.47	68.48
4,183 (836.6)	1,673.20	-59.01	9.23	-61.13	2.42	H	-54.32	74.33
	2,509.80	-59.12	10.96	-58.08	2.89	H	-50.01	70.02
	3,346.40	-58.66	12.03	-58.53	3.47	H	-49.97	69.98
4,233 (846.6)	1,693.20	-58.22	9.30	-60.29	2.42	V	-53.41	73.42
	2,539.80	-59.56	10.98	-58.34	2.96	H	-50.32	70.33
	3,386.40	-58.43	12.12	-58.46	3.53	V	-49.87	69.88

- NOTES:**
1. Radiated Spurious Emission Measurements at 3 meters by Substitution Method according to ANSI/TIA/EIA-603-D-2010 June 24, 2010:
 2. We are performed all frequency to 10th harmonics from 30 MHz. Measurements above show only up to 3 maximum emissions noted, or would be lesser if no specific emissions from the EUT are recorded (ie: margin > 20 dB from the applicable limit) and considered that's already beyond the background noise floor.
 3. We have done x, y, z planes in EUT and horizontal and vertical polarization in detecting antenna.

8.3.4 RADIATED SPURIOUS EMISSIONS (WCDMA1900)

- MEASURED OUTPUT POWER: 20.71 dBm = 0.118 W
- MODULATION SIGNAL: WCDMA1900
- DISTANCE: 3 meters
- LIMIT: $43 + 10 \log_{10}(W) =$ 33.71 dBc

Ch.	Freq.(MHz)	<u>Measured Level</u> [dBm]	Ant. Gain (dBi)	<u>Substitute</u> <u>Level</u> [dBm]	C.L	Pol.	EIRP (dBm)	dBc
9262 (1852.4)	3,704.80	-52.22	12.52	-50.45	3.76	H	-41.69	62.40
	5,557.20	-56.63	13.29	-49.17	4.86	H	-40.74	61.45
	7,409.60	-57.51	11.72	-40.65	5.61	V	-34.54	55.25
9400 (1880.0)	3,760.00	-49.91	12.56	-48.28	3.71	H	-39.43	60.14
	5,640.00	-56.20	13.30	-48.70	4.96	H	-40.36	61.07
	7,520.00	-56.72	11.70	-40.53	5.70	H	-34.53	55.24
9538 (1907.6)	3,815.20	-50.18	12.60	-47.88	3.86	V	-39.13	59.84
	5,722.80	-56.90	13.31	-49.28	5.10	H	-41.07	61.78
	7,630.40	-55.75	11.62	-38.97	5.64	V	-32.99	53.70

- NOTES:**
1. Radiated Spurious Emission Measurements at 3 meters by Substitution Method according to ANSI/TIA/EIA-603-D-2010 June 24, 2010:
 2. We are performed all frequency to 10th harmonics from 30 MHz. Measurements above show only up to 3 maximum emissions noted, or would be lesser if no specific emissions from the EUT are recorded (ie: margin > 20 dB from the applicable limit) and considered that's already beyond the background noise floor.
 3. We have done x, y, z planes in EUT and horizontal and vertical polarization in detecting antenna.

8.3.5 RADIATED SPURIOUS EMISSIONS (WCDMA1700)

- MEASURED OUTPUT POWER: 22.34 dBm = 0.172 W
- MODULATION SIGNAL: WCDMA1700
- DISTANCE: 3 meters
- LIMIT: $43 + 10 \log_{10}(W) =$ 35.34 dBc

Ch.	Freq.(MHz)	<u>Measured Level</u> [dBm]	Ant. Gain (dBi)	<u>Substitute</u> <u>Level</u> [dBm]	C.L	Pol.	EIRP (dBm)	dBc
1312 (1712.4)	3,424.80	-43.47	12.20	-43.11	3.58	H	-34.49	56.83
	5,137.20	-58.04	12.77	-50.41	4.61	H	-42.25	64.59
	6,849.60	-56.34	12.04	-42.49	5.50	H	-35.95	58.29
1412 (1732.4)	3,464.80	-44.27	12.28	-43.35	3.52	H	-34.59	56.93
	5,197.20	-57.71	12.86	-50.57	4.74	H	-42.45	64.79
	6,929.60	-56.85	11.87	-41.45	5.57	V	-35.15	57.49
1513 (1752.6)	3,505.20	-50.19	12.35	-48.71	3.70	H	-40.06	62.40
	5,257.80	-57.64	12.95	-50.96	4.72	V	-42.73	65.07
	7,010.40	-55.70	11.73	-41.54	5.47	V	-35.28	57.62

- NOTES:**
1. Radiated Spurious Emission Measurements at 3 meters by Substitution Method according to ANSI/TIA/EIA-603-D-2010 June 24, 2010:
 2. We are performed all frequency to 10th harmonics from 30 MHz. Measurements above show only up to 3 maximum emissions noted, or would be lesser if no specific emissions from the EUT are recorded (ie: margin > 20 dB from the applicable limit) and considered that's already beyond the background noise floor.
 3. We have done x, y, z planes in EUT and horizontal and vertical polarization in detecting antenna.

8.4 PEAK-TO-AVERAGE RATIO

Band	Ch.	Measured P _{Pk} (dBm)	Measured P _{Avg} (dBm)	P _{Avg} (Duty Cycle)			P.A.R. = P _{Pk} - P _{Avg} (dB)	Limit (dB)	Pass / Fail
				T _{XTotal} (ms)	T _{XOn} (ms)	Factor (dB)			
GSM1900	661	30.573	20.61	4.616	0.5475	9.26	0.70	13	Pass
GSM1900 EDGE	661	29.964	16.87	4.616	0.5475	9.26	3.84		
WCDMA1900	9400	CCDF Procedure					2.86		
WCDMA1700	1412						2.95		

- Plots of the EUT's Peak- to- Average Ratio are shown Page 41 ~ 45.

NOTES:

Peak to Average Power Ratio was tested in accordance with KDB971168 D01 Power Meas License Digital Systems v02r02, October 17, 2014, Section 5.7.

Only GSM(include EDGE) Mode was tested by Section 5.7.2 Alternate Procedure

$P.A.R_{(dB)} = P_{Pk} (dBm) - P_{Avg} (dBm)$ (P_{Avg} = Average Power + Duty cycle Factor)

Duty cycle Factor = $10 \log (1/x)$, $x = T_{XOn} / T_{XTotal}$

8.5 OCCUPIED BANDWIDTH

Band	Channel	Frequency(MHz)	Data (GSM: kHz / WCDMA : MHz)
GSM850	128	824.20	239.24
	190	836.60	241.88
	251	848.80	242.29
GSM850 EDGE	251	848.80	247.26
GSM1900	512	1,850.20	243.80
	661	1,880.00	242.64
	810	1,909.80	240.35
GSM1900 EDGE	512	1,850.20	242.15
WCDMA850	4132	826.40	4.1317
	4183	836.60	4.1441
	4233	846.60	4.1555
WCDMA1900	9262	1852.40	4.1650
	9400	1880.00	4.1511
	9538	1907.60	4.1688
WCDMA1700	1312	1712.40	4.1476
	1412	1732.40	4.1404
	1513	1752.60	4.1427

- Plots of the EUT's Occupied Bandwidth are shown Page 33 ~ 41.

8.6 CONDUCTED SPURIOUS EMISSIONS

■ FACTORS FOR FREQUENCY

Frequency Range (GHz)	Factor [dB]
0.03 – 1	27.145
1 – 5	26.960
5 – 10	27.542
10 – 15	28.439
15 – 20	29.144
Above 20	30.148

NOTES:

Factor(dB) = Cable Loss + Attenuator + Power Splitter

Band	Channel	Frequency of Maximum Harmonic (GHz)	Factor (dB)	Measurement Maximum Data (dBm)	Result	(dBm)
GSM850	128	3.3520	26.960	-59.794	-32.834	-13.00
	190	3.7289	26.960	-59.157	-32.197	
	251	3.7020	26.960	-59.586	-32.626	
GSM1900	512	19.23273	29.144	-54.884	-25.740	
	661	16.74717	29.144	-54.111	-24.967	
	810	16.86542	29.144	-54.268	-25.124	
WCDMA850	4132	3.7000	26.960	-60.074	-33.114	
	4183	6.1670	27.542	-59.177	-31.635	
	4233	3.0574	26.960	-59.203	-32.243	
WCDMA1900	9262	18.54596	29.144	-54.136	-24.992	
	9400	19.29573	29.144	-54.736	-25.592	
	9538	16.59616	29.144	-53.977	-24.833	
WCDMA1700	1312	18.90547	29.144	-54.209	-25.065	
	1412	17.03793	29.144	-54.026	-24.882	
	1513	18.76722	29.144	-54.682	-25.538	

NOTES:

1. Result (dBm) = Measurement Maximum Data (dBm) + Factor (dB)

- Plots of the EUT's Conducted Spurious Emissions are shown Page 63 ~ 75.

8.6.1 BAND EDGE

- Plots of the EUT's Band Edge are shown Page 45 ~ 63.

8.7 FREQUENCY STABILITY / VARIATION OF AMBIENT TEMPERATURE

8.7.1 FREQUENCY STABILITY (GSM850)

- ▣ OPERATING FREQUENCY: 836,600,000 Hz
- ▣ CHANNEL: 190
- ▣ REFERENCE VOLTAGE: 3.85 VDC
- ▣ DEVIATION LIMIT: ± 0.000 25 % or 2.5 ppm

Voltage (%)	Power (VDC)	Temp. (°C)	Frequency (Hz)	Frequency Error (Hz)	Deviation (%)	ppm
100%	3.85	+20(Ref)	836 600 016	0.0	0.000 000	0.0000
100%		-30	836 600 031	14.5	0.000 002	0.0173
100%		-20	836 600 031	15.2	0.000 002	0.0182
100%		-10	836 600 029	12.7	0.000 002	0.0152
100%		0	836 600 031	14.9	0.000 002	0.0178
100%		+10	836 600 031	15.0	0.000 002	0.0179
100%		+30	836 600 030	13.7	0.000 002	0.0164
100%		+40	836 600 027	10.5	0.000 001	0.0125
100%		+50	836 600 030	14.3	0.000 002	0.0171
Batt. Endpoint		3.60	+20	836 600 028	11.6	0.000 001

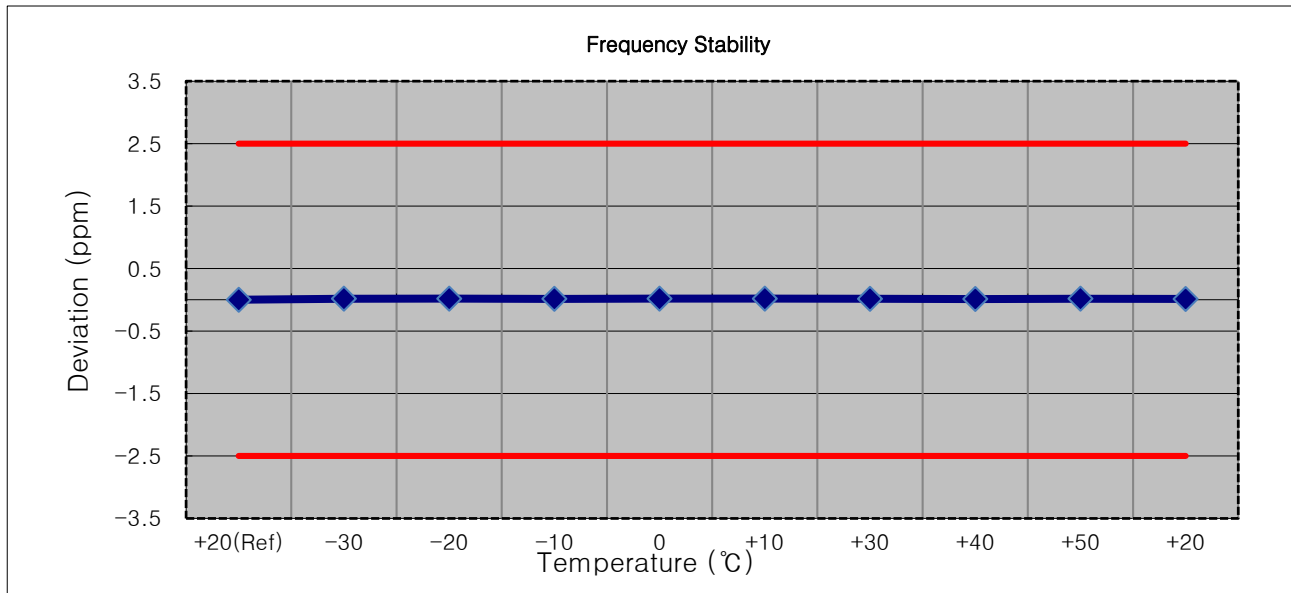

8.7.2 FREQUENCY STABILITY (GSM1900)

- ▣ OPERATING FREQUENCY: 1880,000,000 Hz
- ▣ CHANNEL: 661
- ▣ REFERENCE VOLTAGE: 3.85 VDC
- ▣ DEVIATION LIMIT: Emission must remain in band

Voltage (%)	Power (VDC)	Temp. (°C)	Frequency (Hz)	Frequency Error (Hz)	Deviation (%)	ppm
100%	3.85	+20(Ref)	1880 000 031	0.0	0.000 000	0.0000
100%		-30	1880 000 059	27.7	0.000 001	0.0147
100%		-20	1880 000 061	30.1	0.000 002	0.0160
100%		-10	1880 000 059	28.1	0.000 001	0.0149
100%		0	1880 000 060	28.8	0.000 002	0.0153
100%		+10	1880 000 061	29.8	0.000 002	0.0159
100%		+30	1880 000 062	30.6	0.000 002	0.0163
100%		+40	1880 000 058	26.6	0.000 001	0.0141
100%		+50	1880 000 055	24.1	0.000 001	0.0128
Batt. Endpoint		3.60	+20	1880 000 057	25.5	0.000 001

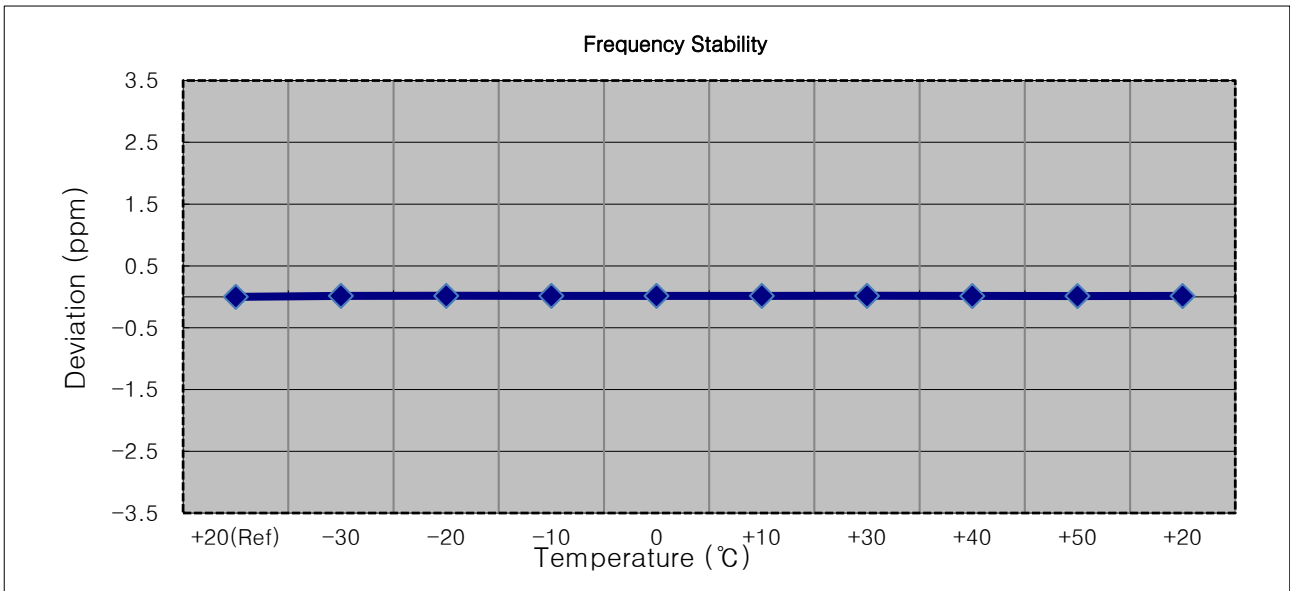

8.7.3 FREQUENCY STABILITY (WCDMA850)

- ▣ OPERATING FREQUENCY: 836,600,000 Hz
- ▣ CHANNEL: 4183
- ▣ REFERENCE VOLTAGE: 3.85 VDC
- ▣ DEVIATION LIMIT: ± 0.000 25 % or 2.5 ppm

Voltage (%)	Power (VDC)	Temp. (°C)	Frequency (Hz)	Frequency Error (Hz)	Deviation (%)	ppm
100%	3.85	+20(Ref)	836 600 001	0.0	0.000 000	0.0000
100%		-30	836 600 002	1.8	0.000 000	0.0021
100%		-20	836 600 000	-1.1	0.000 000	-0.0014
100%		-10	836 600 000	-0.9	0.000 000	-0.0010
100%		0	836 600 002	1.1	0.000 000	0.0013
100%		+10	836 600 001	0.7	0.000 000	0.0009
100%		+30	836 600 000	-0.8	0.000 000	-0.0010
100%		+40	836 600 001	0.6	0.000 000	0.0007
100%		+50	836 600 000	-1.1	0.000 000	-0.0014
Batt. Endpoint	3.60	+20	836 600 002	1.0	0.000 000	0.0012

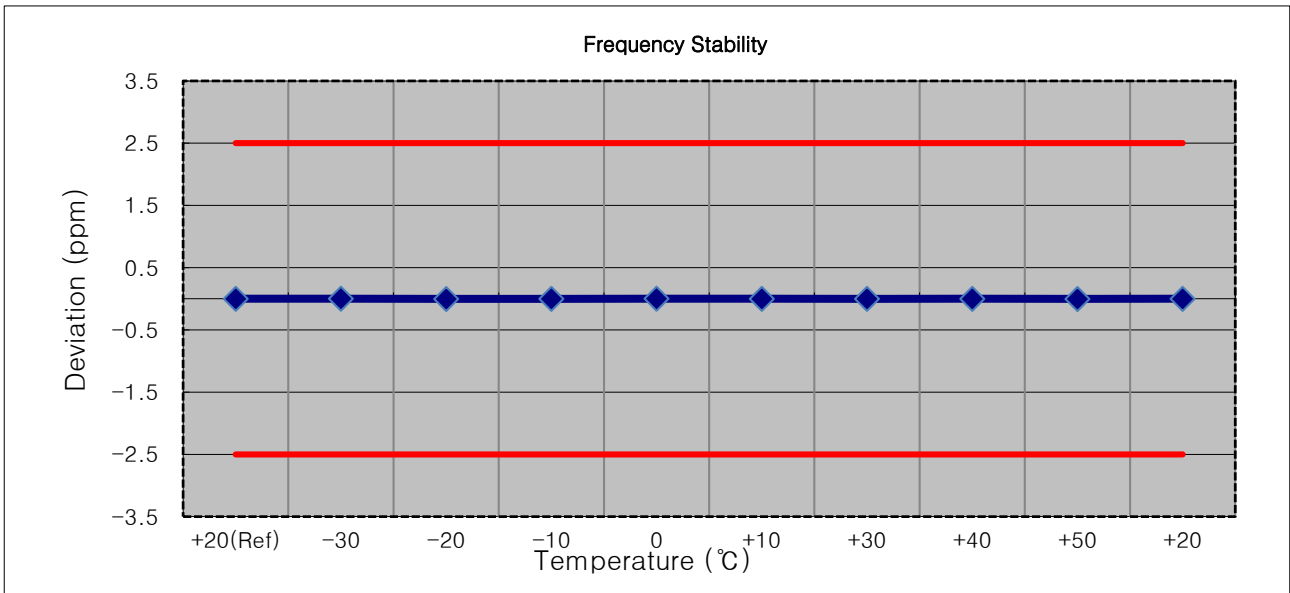

8.7.4 FREQUENCY STABILITY (WCDMA1900)

- ▣ OPERATING FREQUENCY: 1,880,000,000 Hz
- ▣ CHANNEL: 9400
- ▣ REFERENCE VOLTAGE: 3.85 VDC
- ▣ DEVIATION LIMIT: Emission must remain in band

Voltage (%)	Power (VDC)	Temp. (°C)	Frequency (Hz)	Frequency Error (Hz)	Deviation (%)	ppm
100%	3.85	+20(Ref)	1879 999 996	0.0	0.000 000	0.0000
100%		-30	1879 999 991	-4.6	0.000 000	-0.0025
100%		-20	1879 999 992	-3.8	0.000 000	-0.0020
100%		-10	1879 999 993	-2.9	0.000 000	-0.0016
100%		0	1879 999 992	-3.5	0.000 000	-0.0019
100%		+10	1879 999 991	-4.3	0.000 000	-0.0023
100%		+30	1879 999 992	-4.1	0.000 000	-0.0022
100%		+40	1879 999 991	-4.2	0.000 000	-0.0022
100%		+50	1879 999 992	-4.1	0.000 000	-0.0022
Batt. Endpoint	3.60	+20	1879 999 992	-4.0	0.000 000	-0.0021

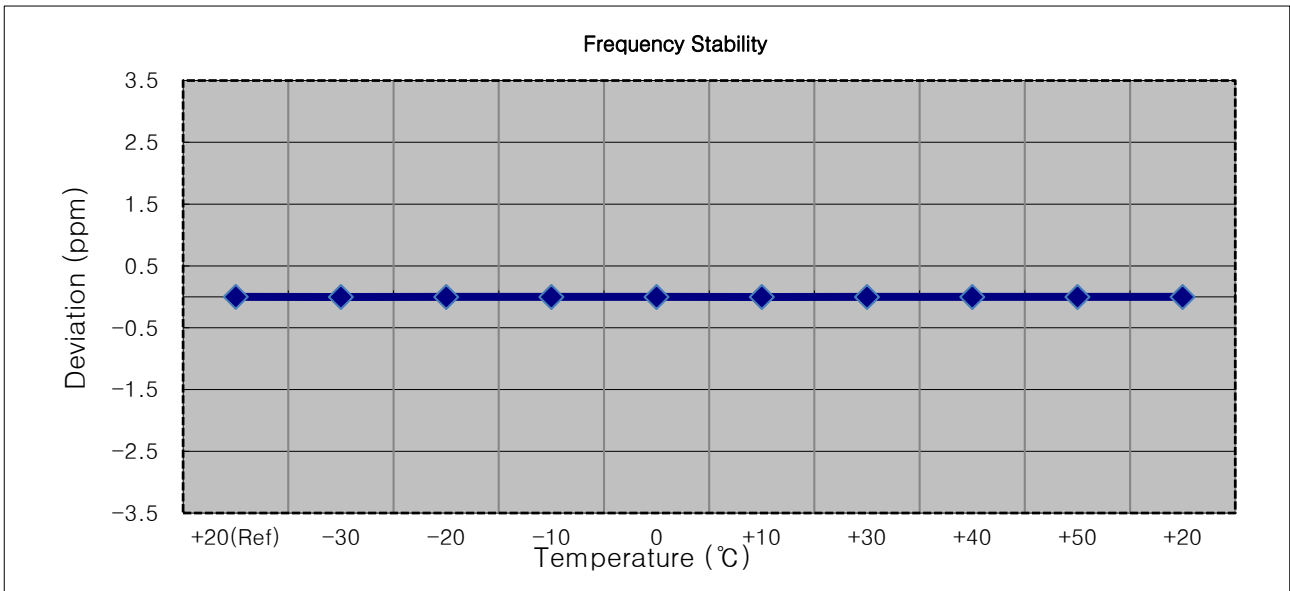

8.7.5 FREQUENCY STABILITY (WCDMA1700)

- ▣ OPERATING FREQUENCY: 1,732,400,000 Hz
- ▣ CHANNEL: 1412
- ▣ REFERENCE VOLTAGE: 3.85 VDC
- ▣ DEVIATION LIMIT: Emission must remain in band

Voltage (%)	Power (VDC)	Temp. (°C)	Frequency (Hz)	Frequency Error (Hz)	Deviation (%)	ppm
100%	3.85	+20(Ref)	1732 399 997	0.0	0.000 000	0.0000
100%		-30	1732 399 993	-4.2	0.000 000	-0.0024
100%		-20	1732 399 993	-4.2	0.000 000	-0.0024
100%		-10	1732 399 993	-4.2	0.000 000	-0.0024
100%		0	1732 399 993	-4.0	0.000 000	-0.0023
100%		+10	1732 399 992	-4.5	0.000 000	-0.0026
100%		+30	1732 399 993	-4.4	0.000 000	-0.0025
100%		+40	1732 399 994	-3.3	0.000 000	-0.0019
100%		+50	1732 399 992	-4.7	0.000 000	-0.0027
Batt. Endpoint	3.60	+20	1732 399 993	-3.5	0.000 000	-0.0020

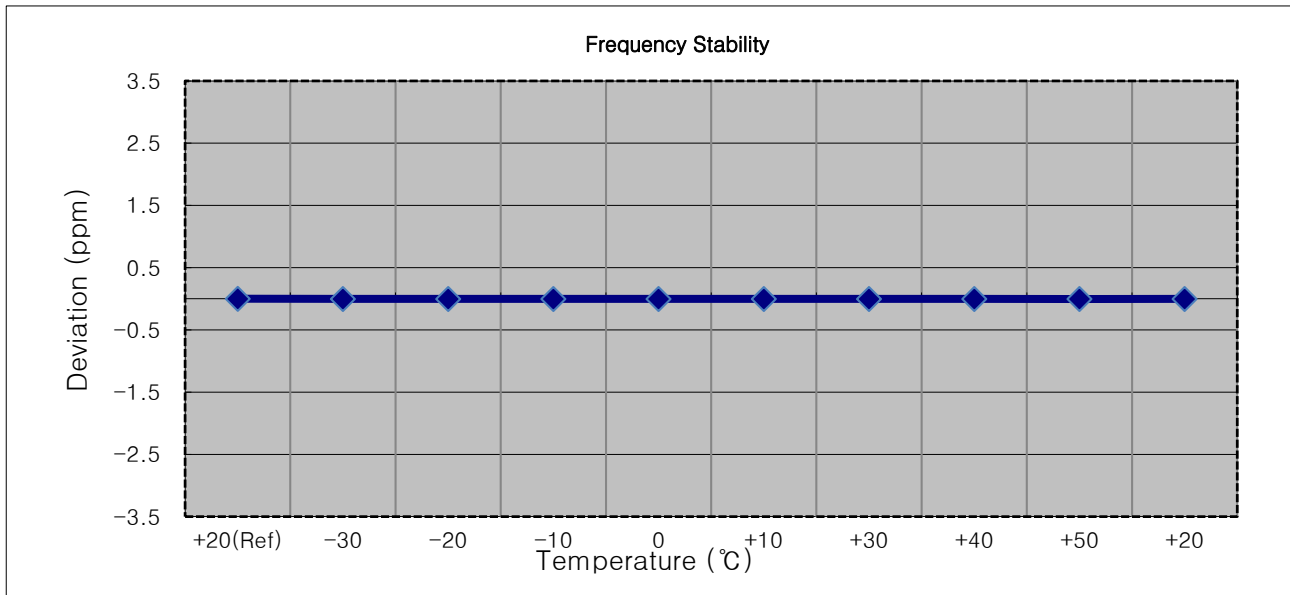

9. TEST PLOTS

■ GSM850 MODE (128 CH.) Occupied Bandwidth

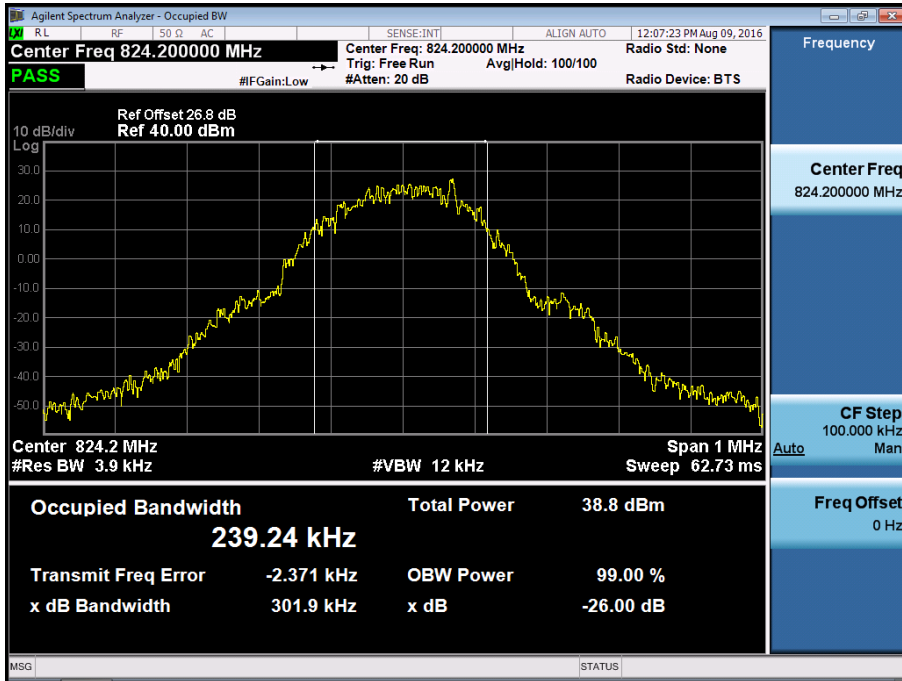

■ GSM850 MODE (190 CH.) Occupied Bandwidth

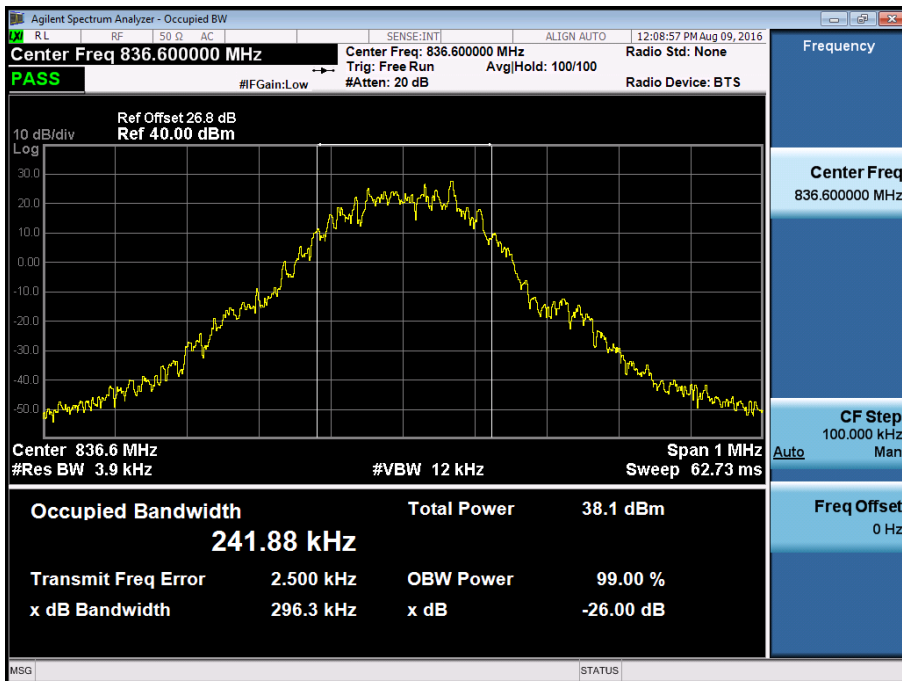

■ GSM850 MODE (251 CH.) Occupied Bandwidth

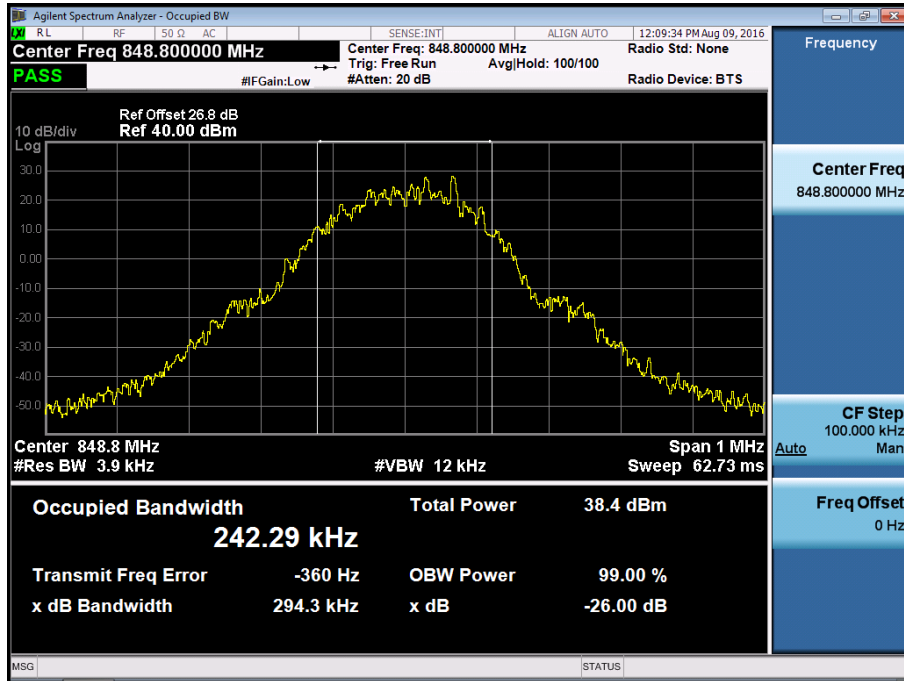

■ GSM850 EDGE (251 CH.) Occupied Bandwidth

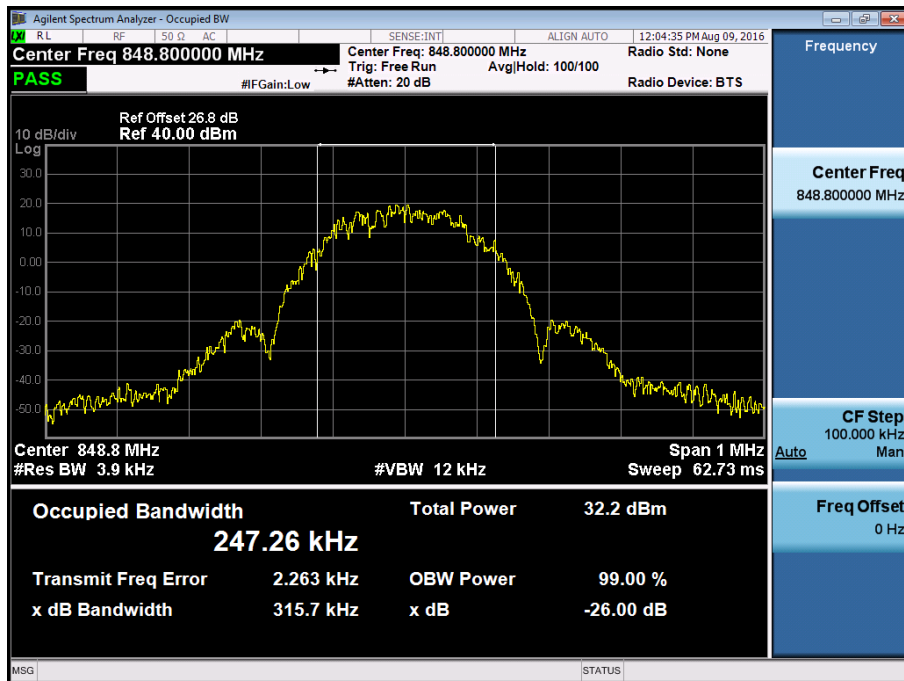

■ GSM1900 MODE (512 CH.) Occupied Bandwidth

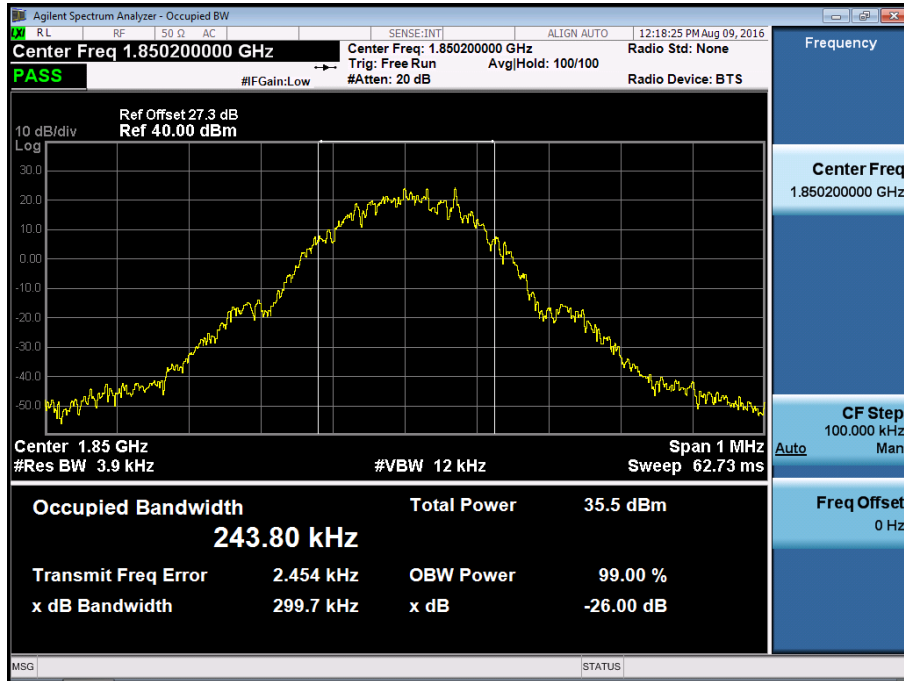

■ GSM1900 MODE (661 CH.) Occupied Bandwidth

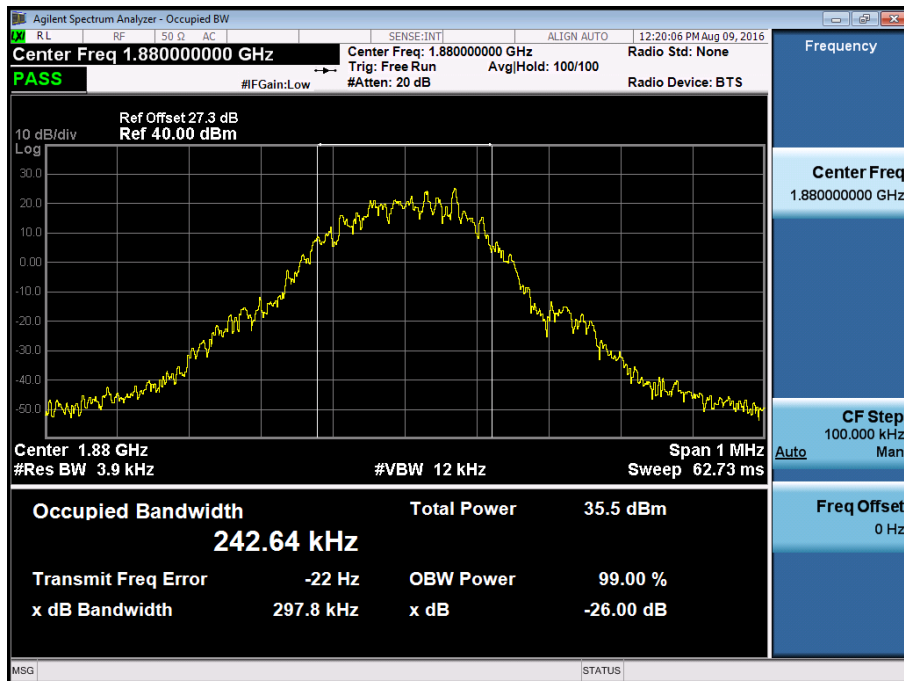

■ GSM1900 MODE (810 CH.) Occupied Bandwidth

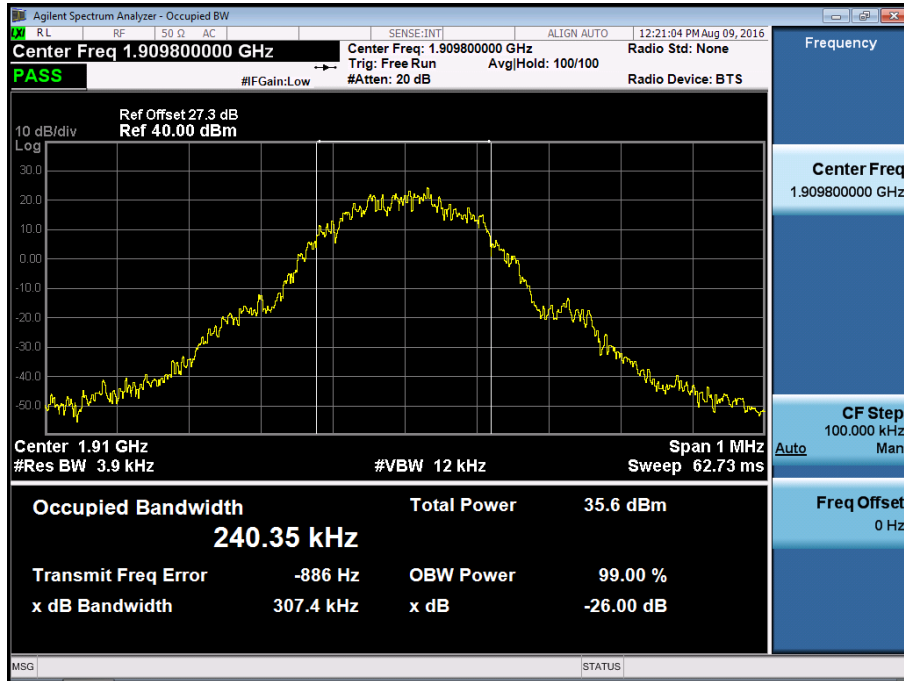

■ GSM1900 EDGE (512 CH.) Occupied Bandwidth

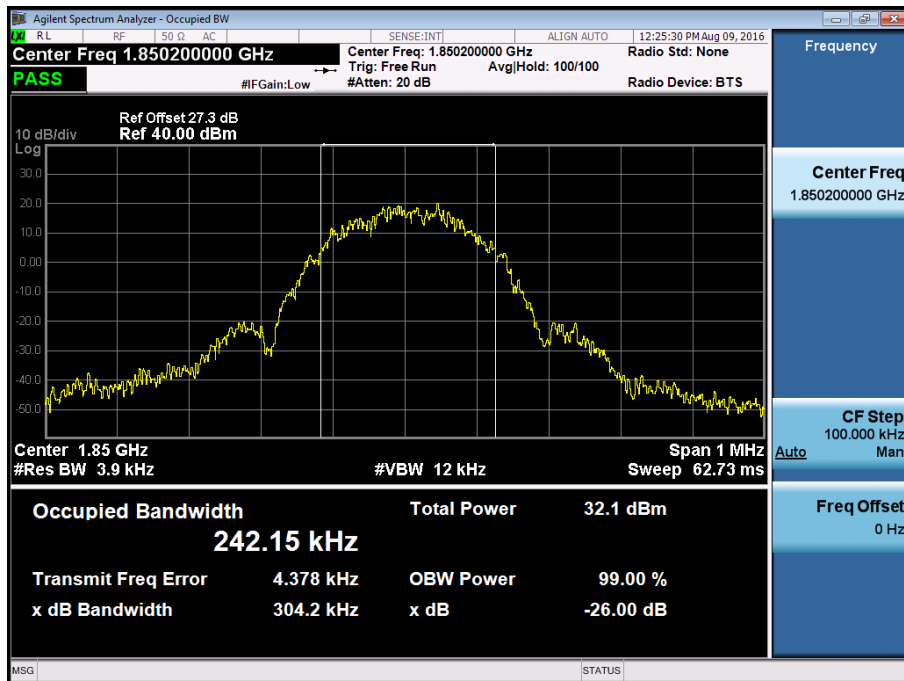

■ WCDMA850 MODE (4132 CH.) Occupied Bandwidth

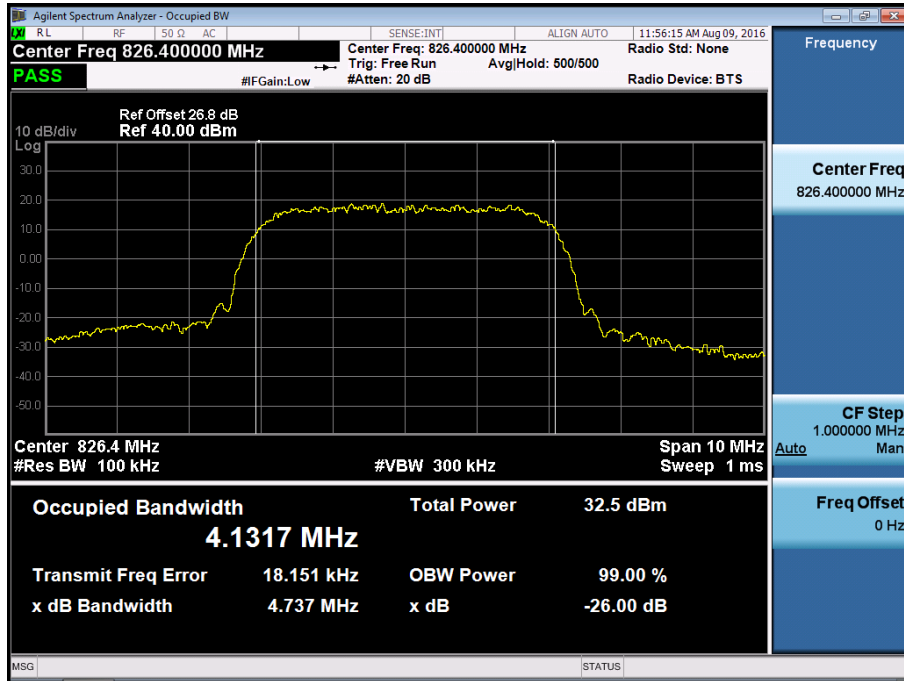

■ WCDMA850 MODE (4183 CH.) Occupied Bandwidth

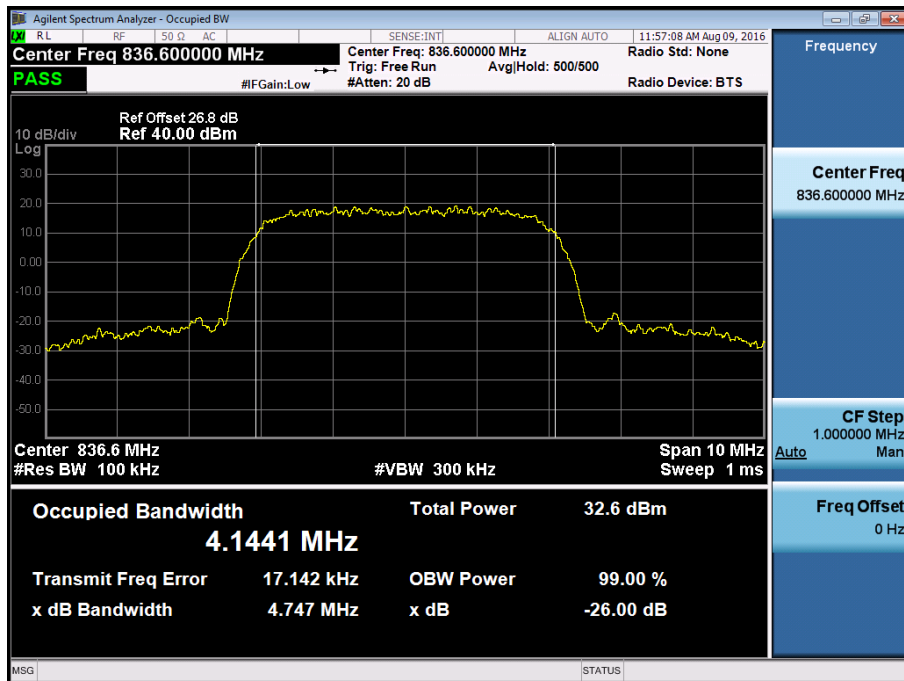

■ WCDMA850MODE (4233 CH.) Occupied Bandwidth

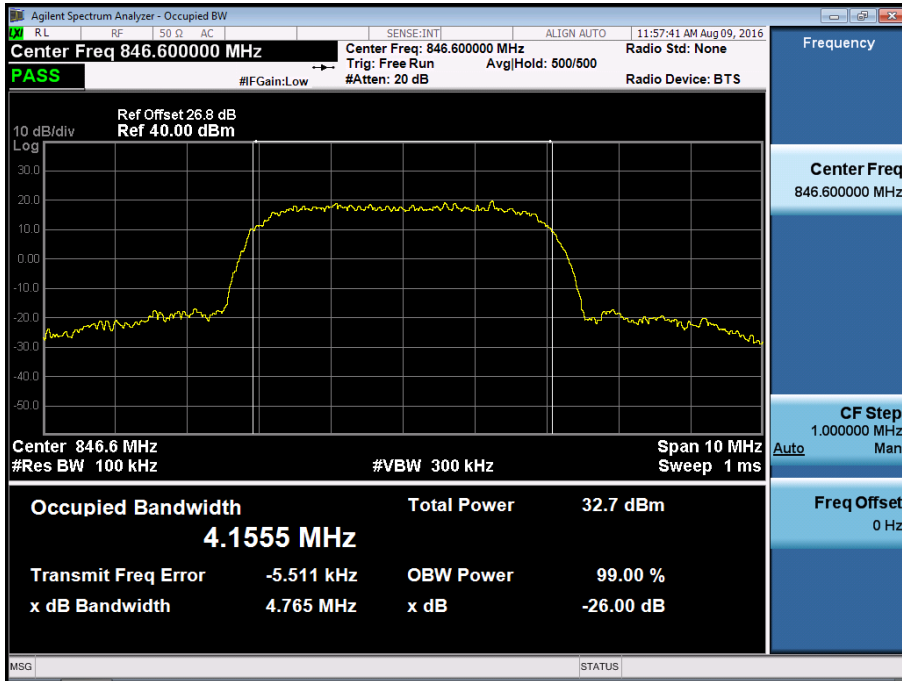

■ WCDMA1900 MODE (9262 CH.) Occupied Bandwidth

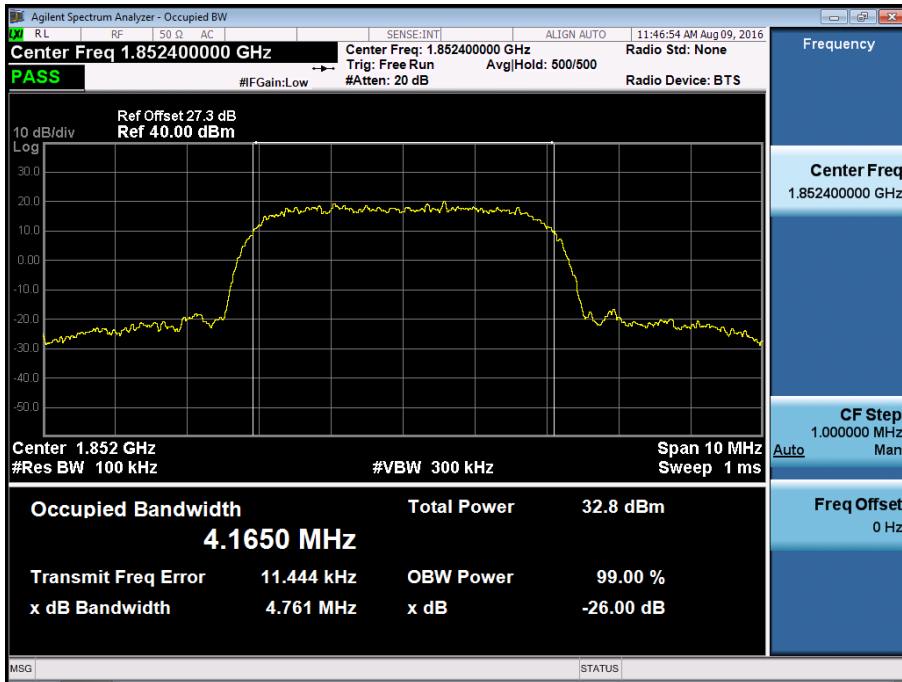

■ WCDMA1900 MODE (9400 CH.) Occupied Bandwidth

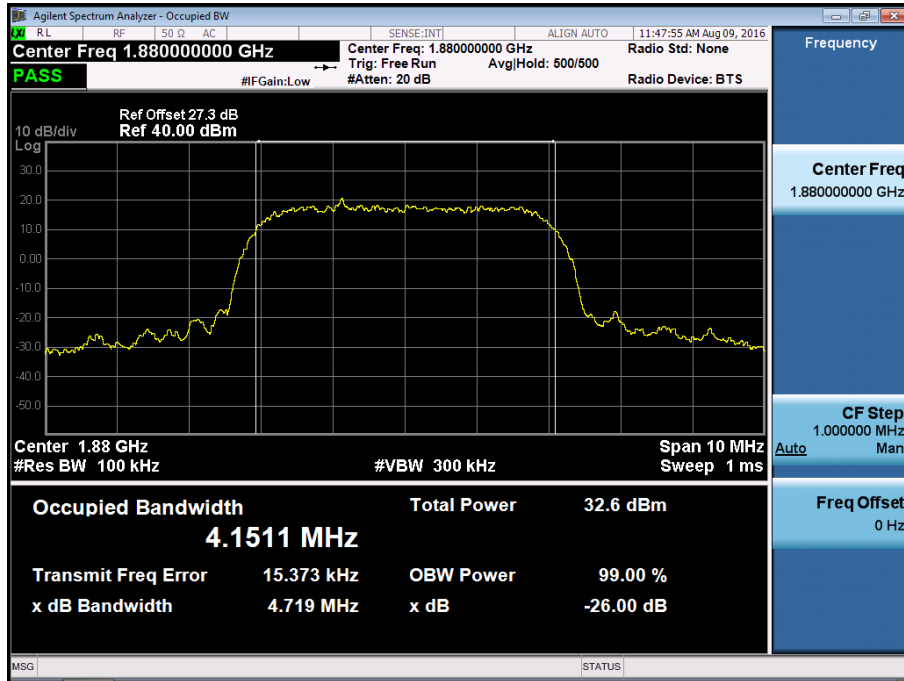

■ WCDMA1900 MODE (9538 CH.) Occupied Bandwidth

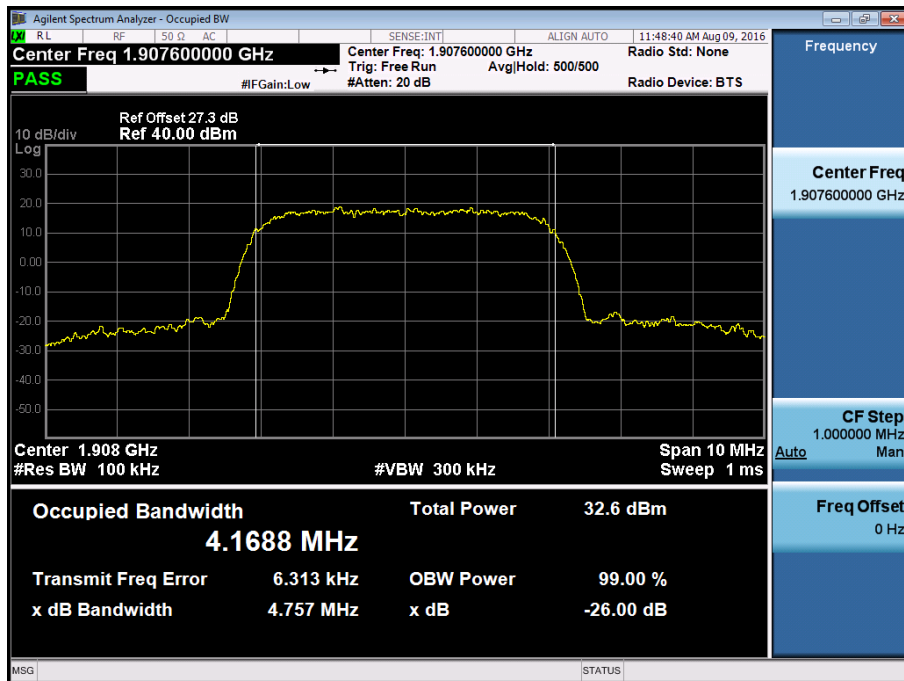

■ WCDMA1700 MODE (1312 CH.) Occupied Bandwidth

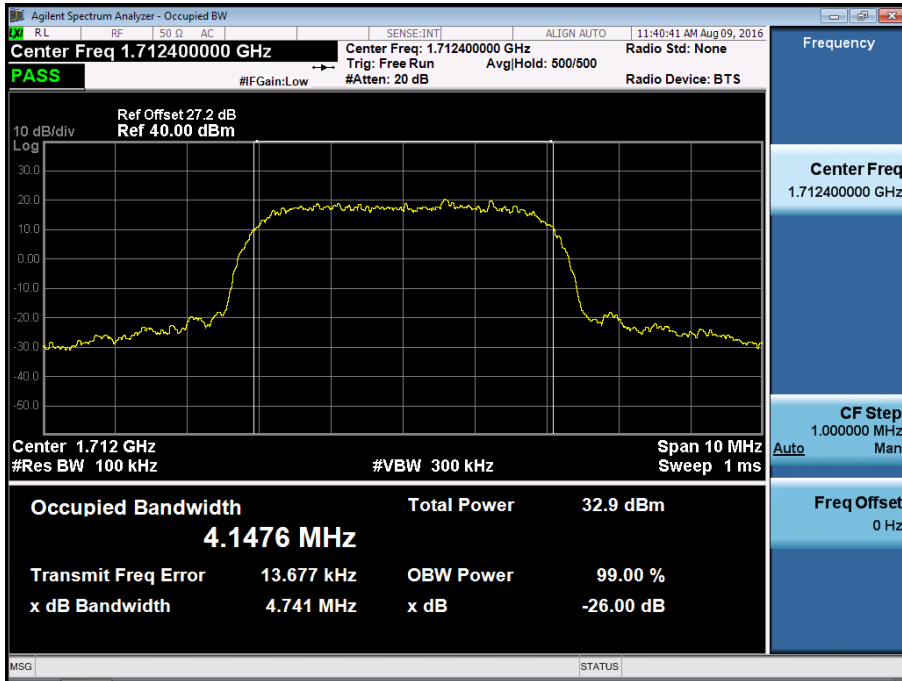

■ WCDMA1700 MODE (1412 CH.) Occupied Bandwidth

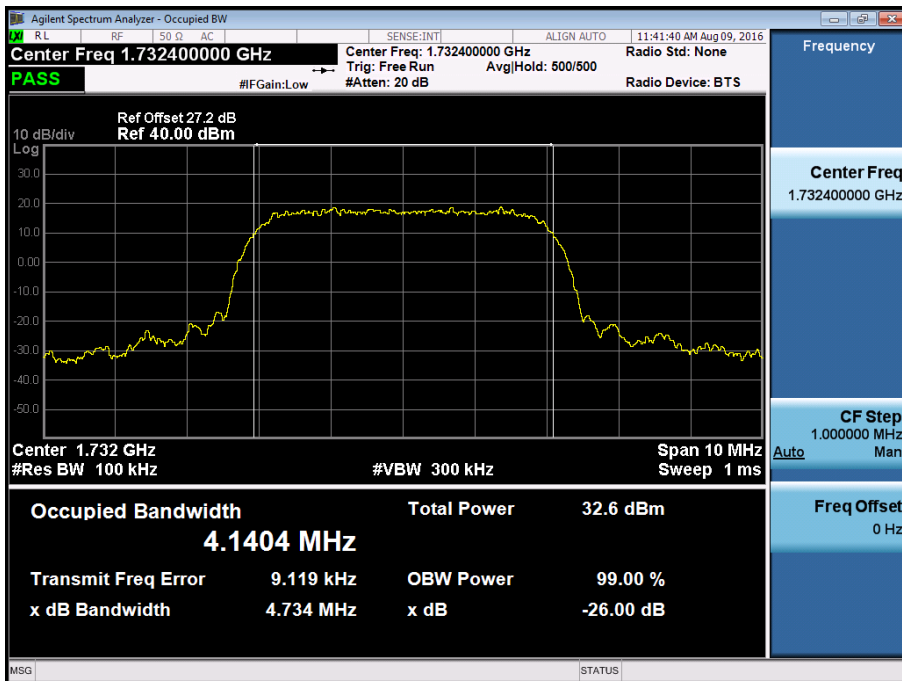

■ WCDMA1700 MODE (1513 CH.) Occupied Bandwidth

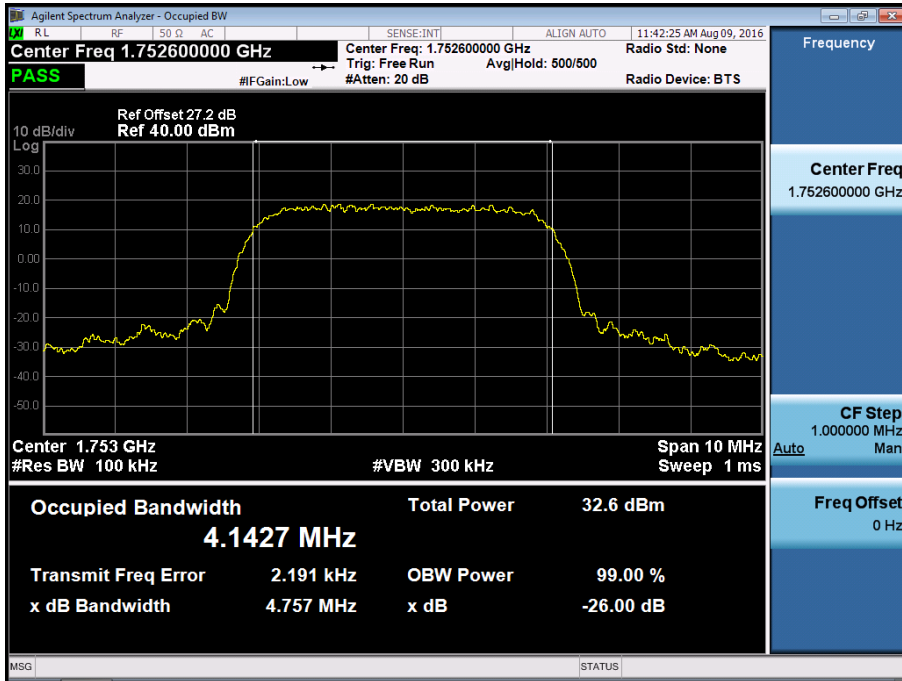

■ GSM1900 MODE (661 CH.) Peak-to-Average Ratio P_{PK}

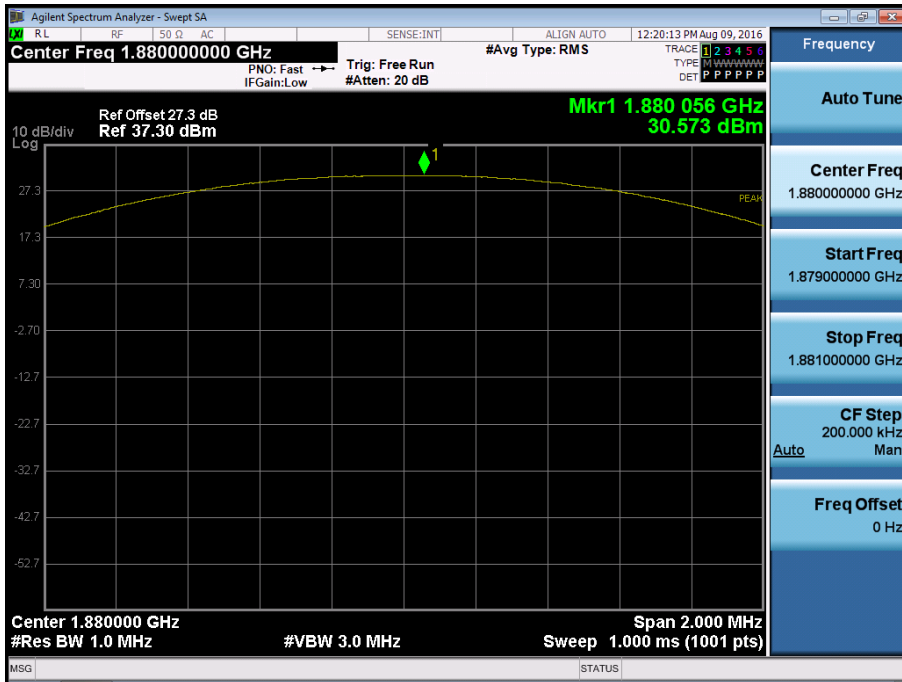

■ GSM1900 MODE (661 CH.) Peak-to-Average Ratio P_{Avg}

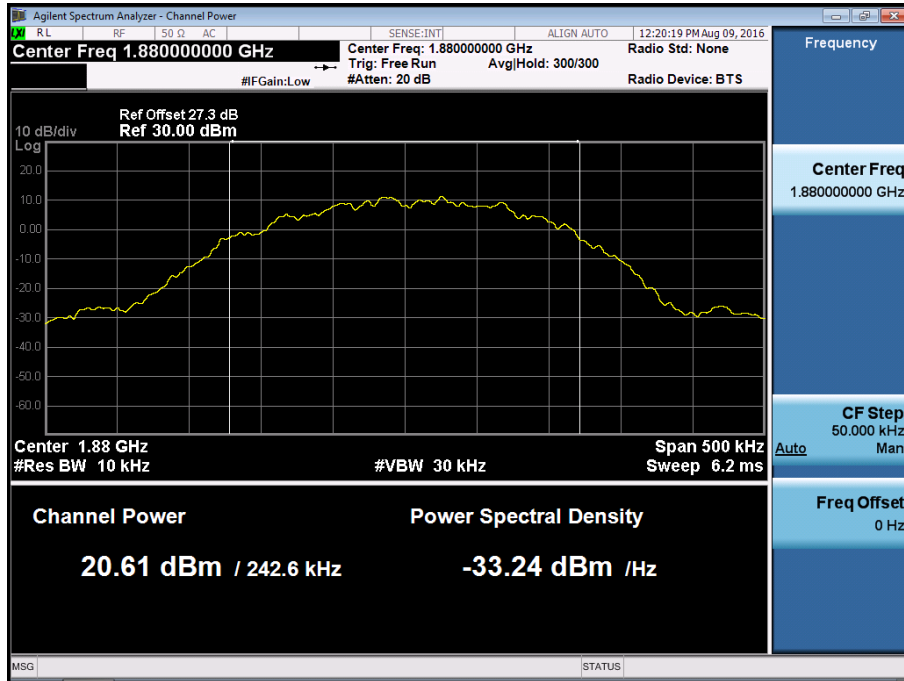

■ GSM1900 MODE (661 CH.) Peak-to-Average Ratio Duty

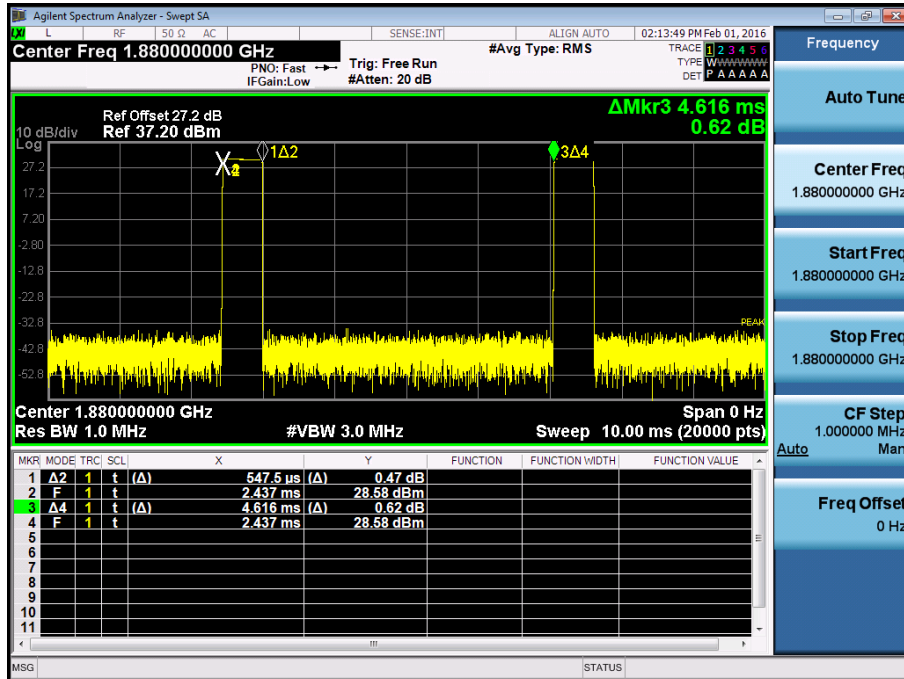

■ GSM1900 EDGE (661 CH.) Peak-to-Average Ratio Duty

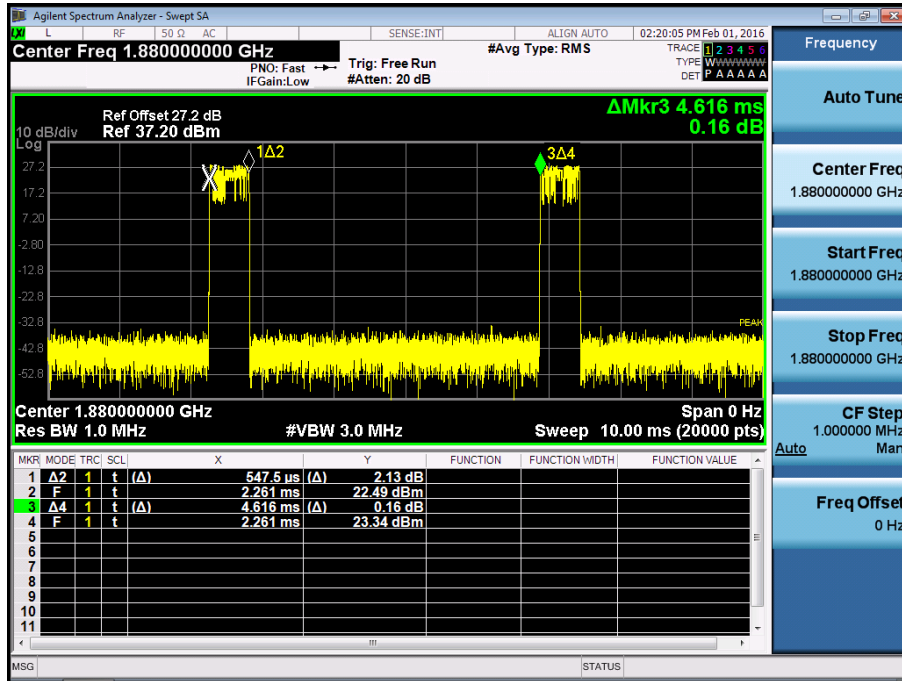

■ GSM1900 EDGE (661 CH.) Peak-to-Average Ratio P_{pk}

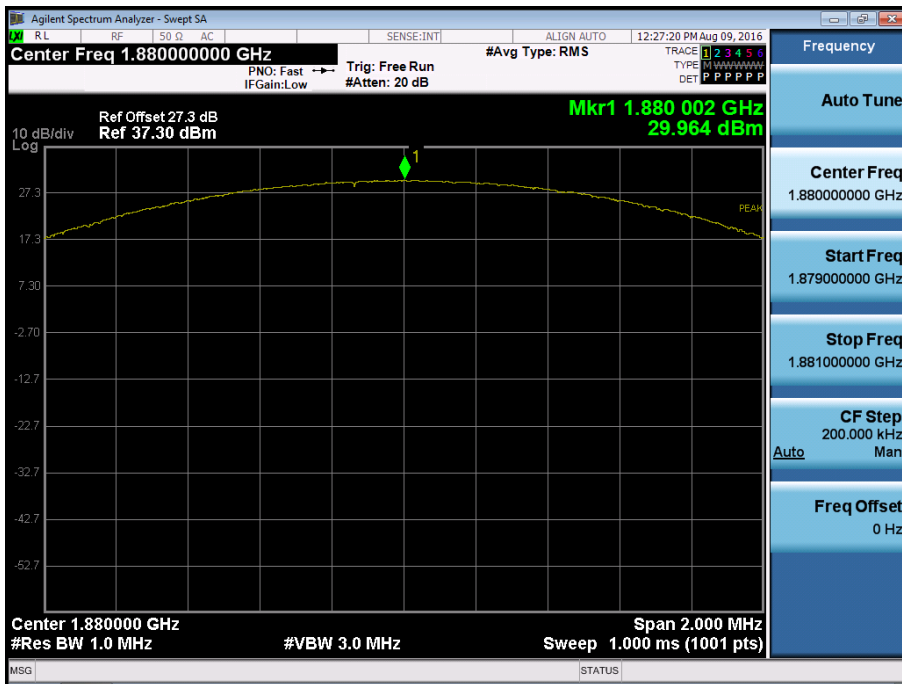

■ GSM1900 EDGE (661 CH.) Peak-to-Average Ratio P_{Avg}

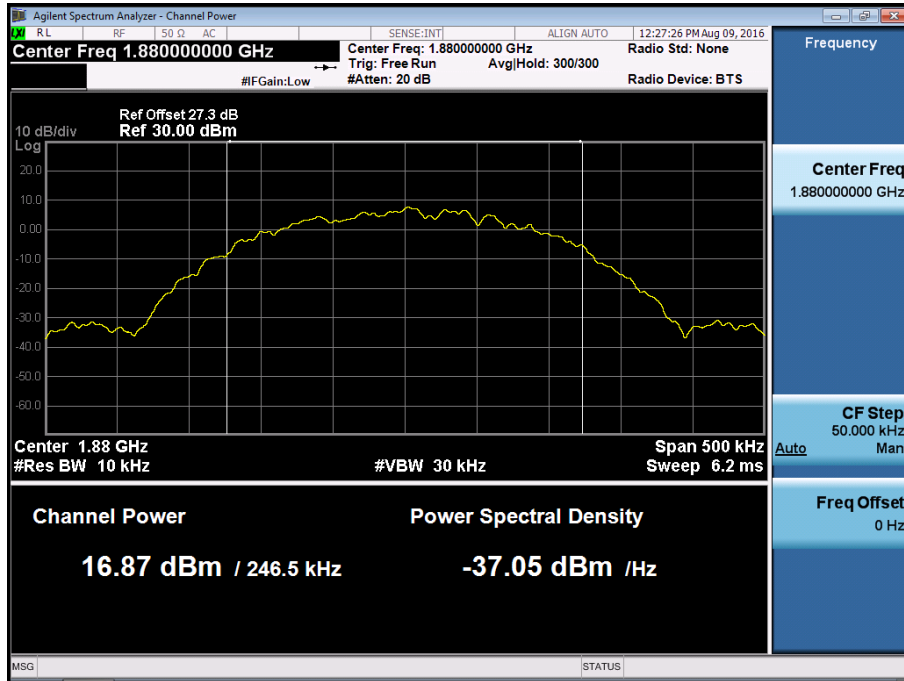

■ WCDMA1900 MODE (9400 CH.) Peak-to-Average Ratio

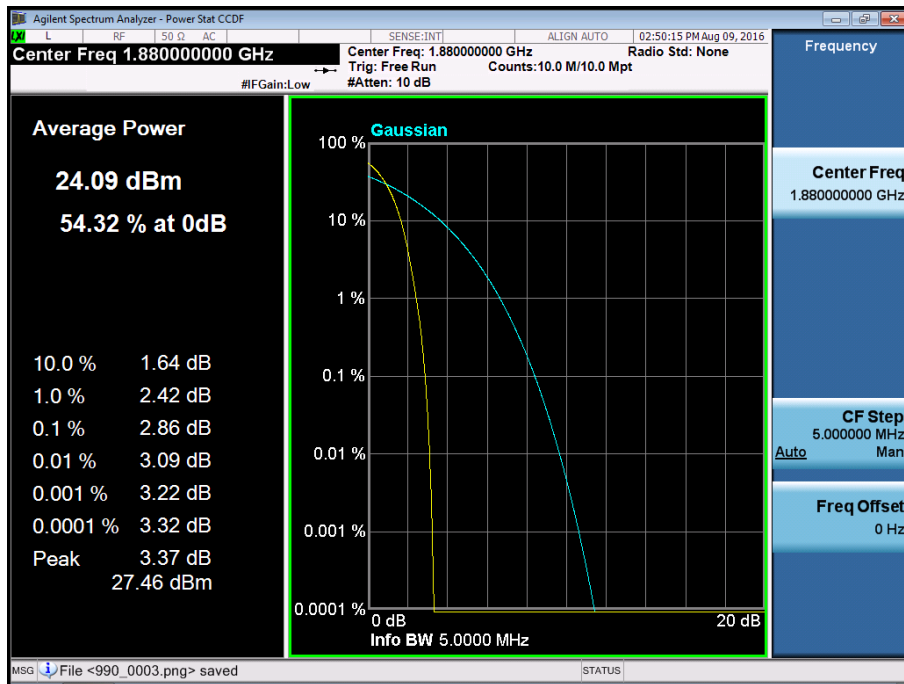

■ WCDMA1700 MODE (1412 CH.) Peak-to-Average Ratio

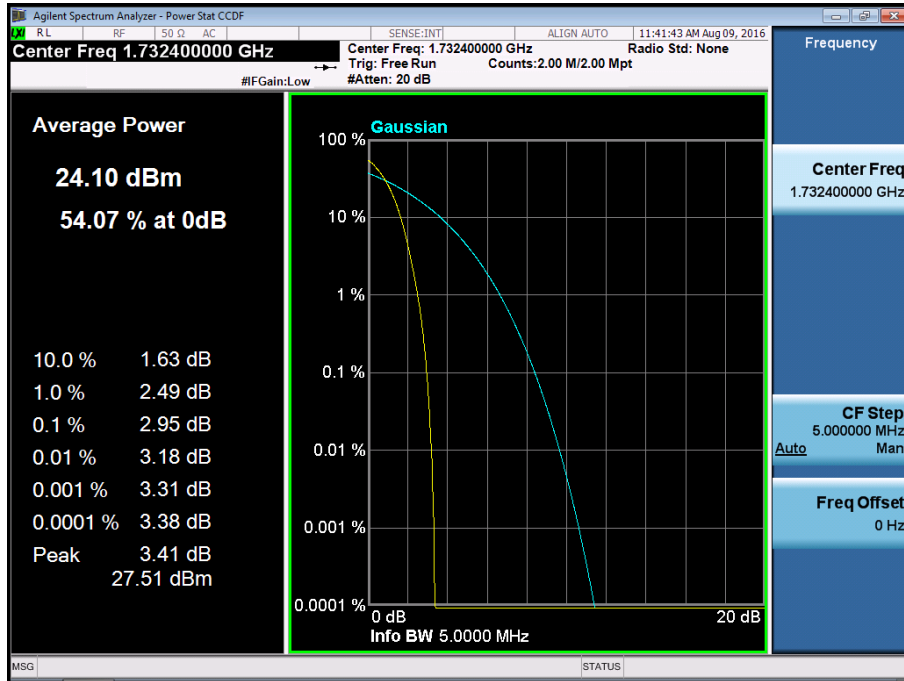

■ GSM850 MODE (128 CH.) Block Edge 1

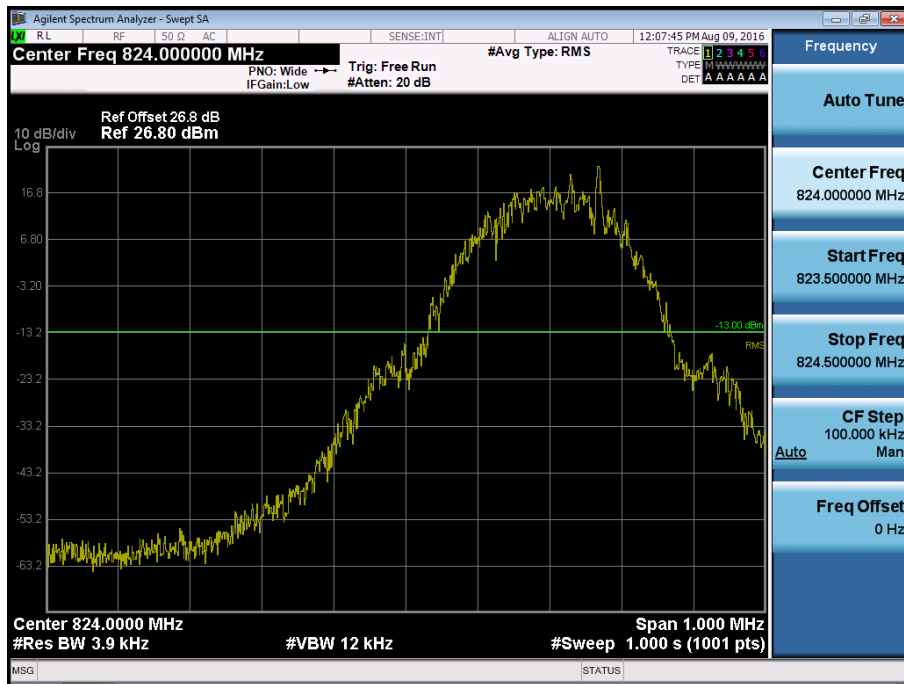

■ GSM850 MODE (128 CH.) Block Edge 2

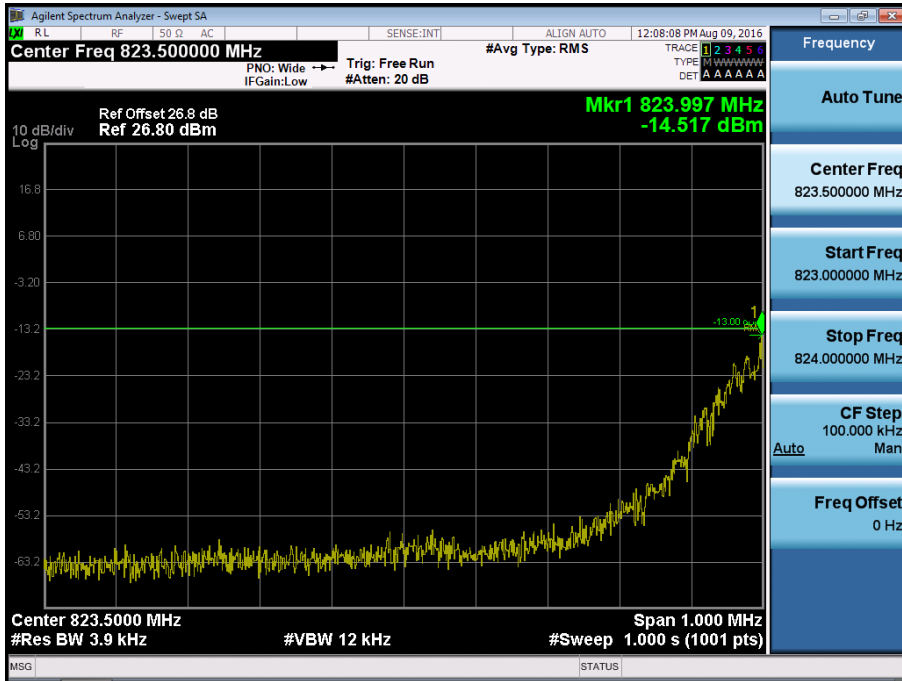

■ GSM850 MODE (128 CH.) Block Edge 3

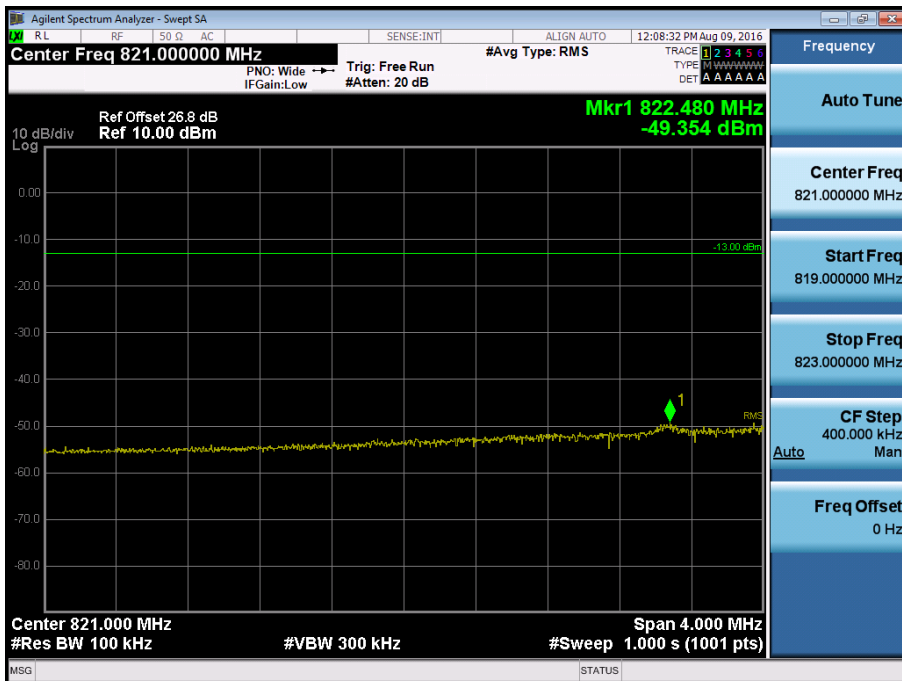

■ GSM850 MODE (251 CH.) Block Edge 1

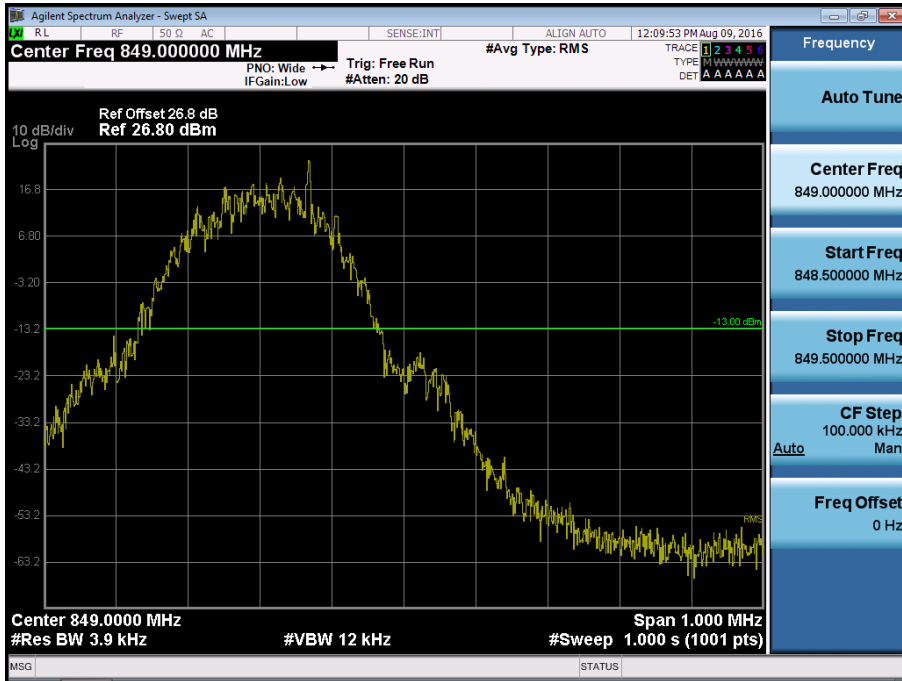

■ GSM850 MODE (251 CH.) Block Edge 2

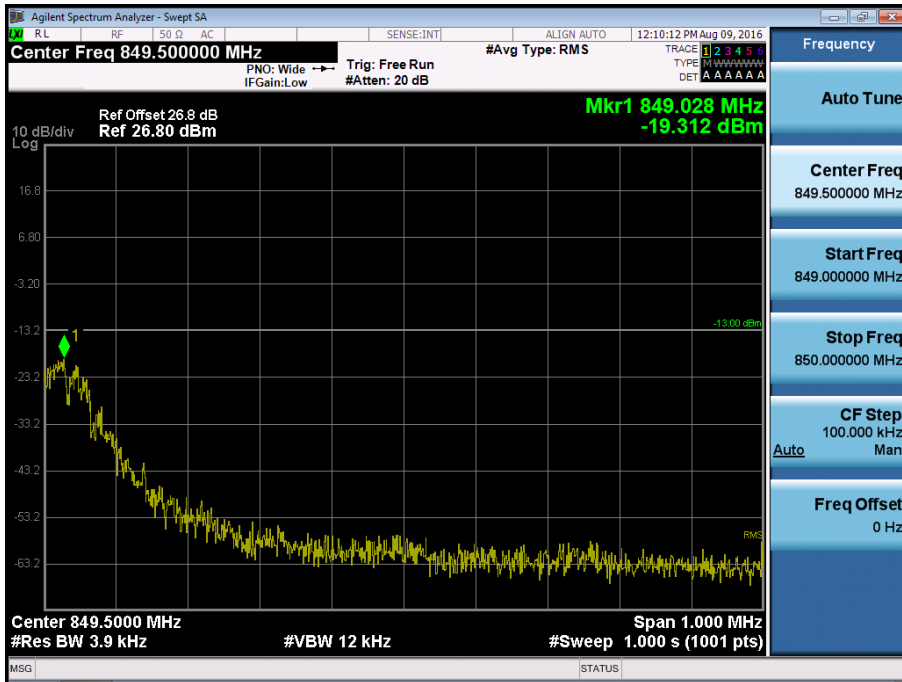

■ GSM850 MODE (251 CH.) Block Edge 3

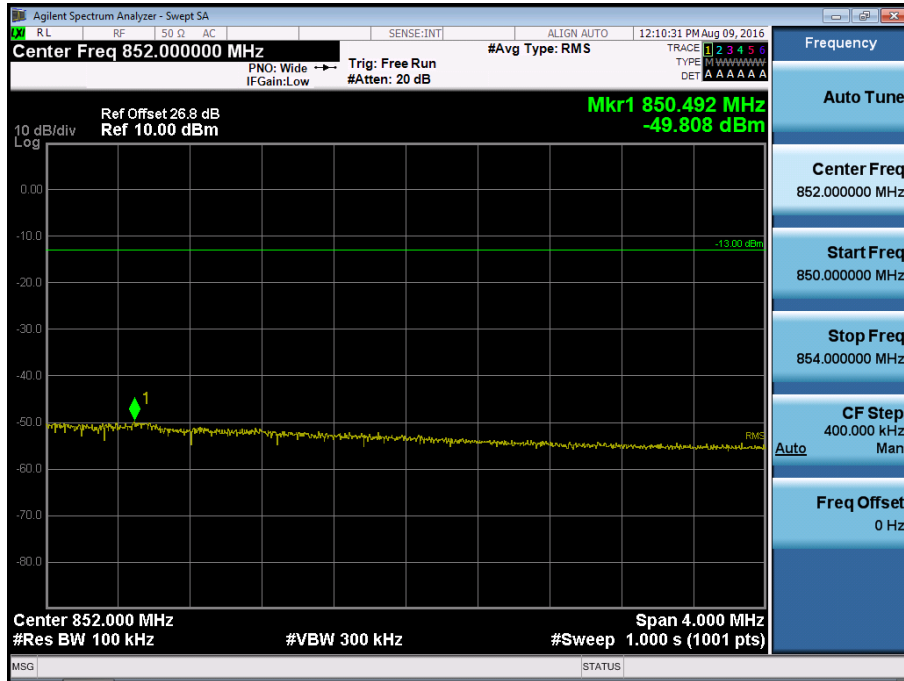

■ EDGE MODE (128 CH.) Block Edge 1

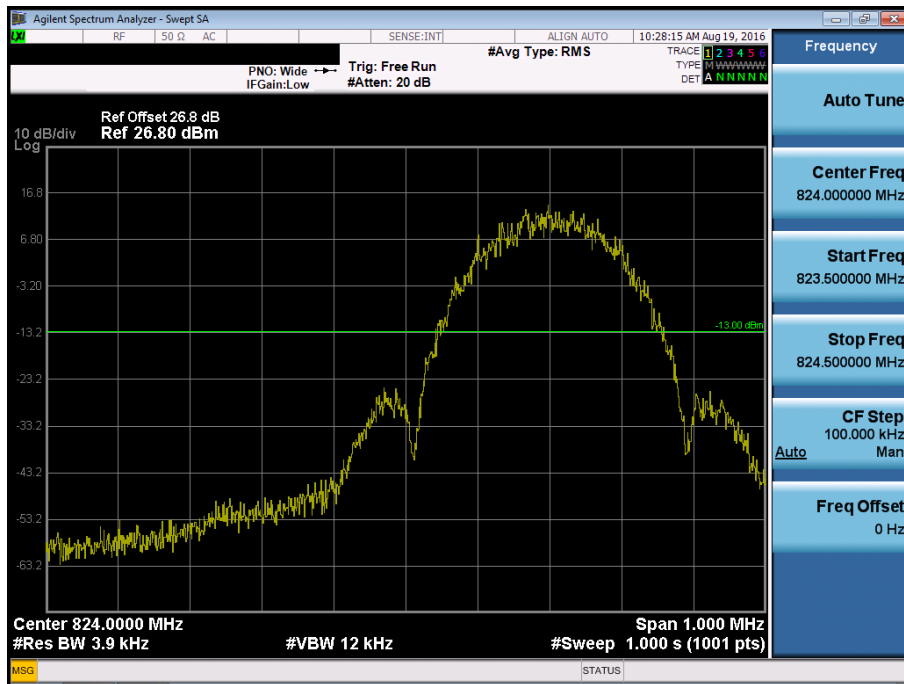

■ EDGE MODE (128 CH.) Block Edge 2

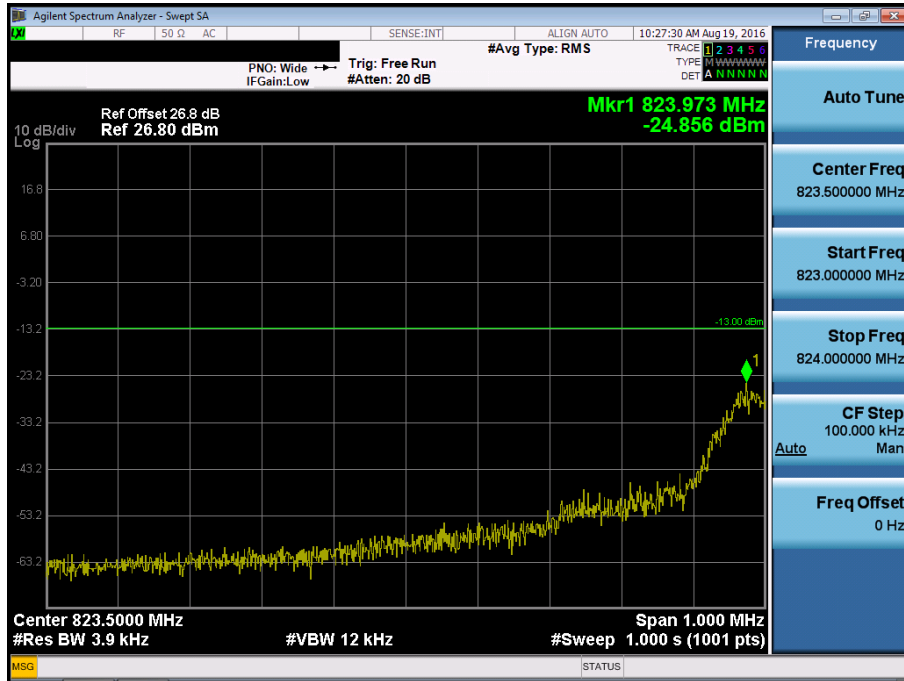

■ EDGE MODE (128 CH.) Block Edge 3

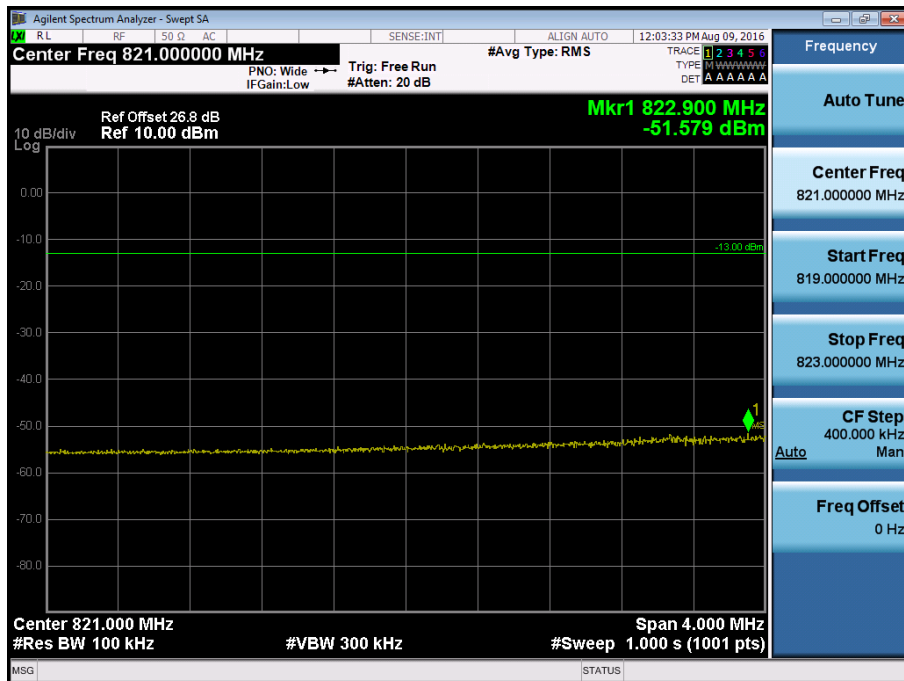

■ EDGE MODE (251 CH.) Block Edge 1

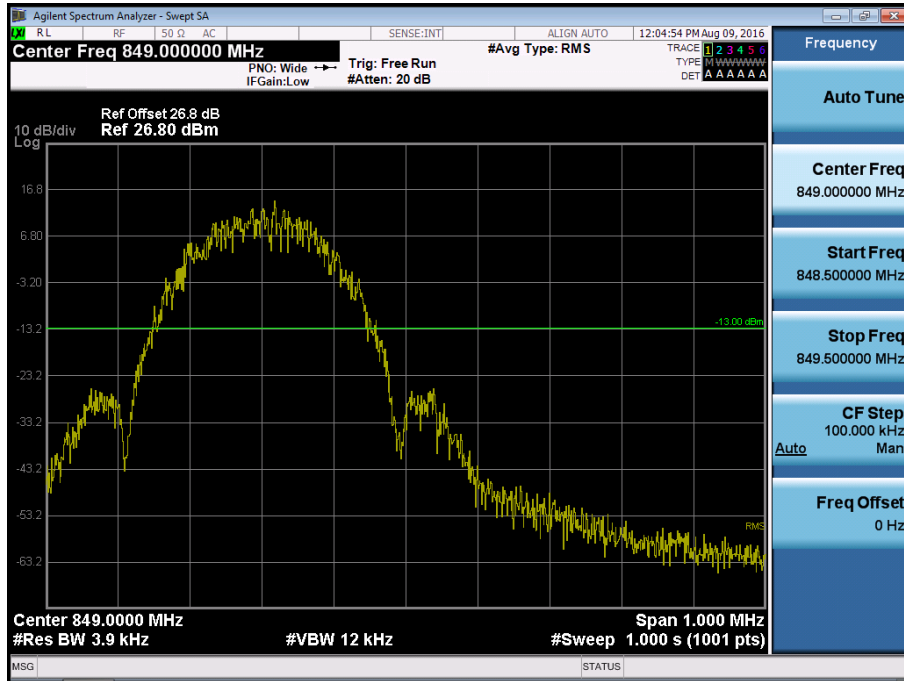

■ EDGE MODE (251 CH.) Block Edge 2

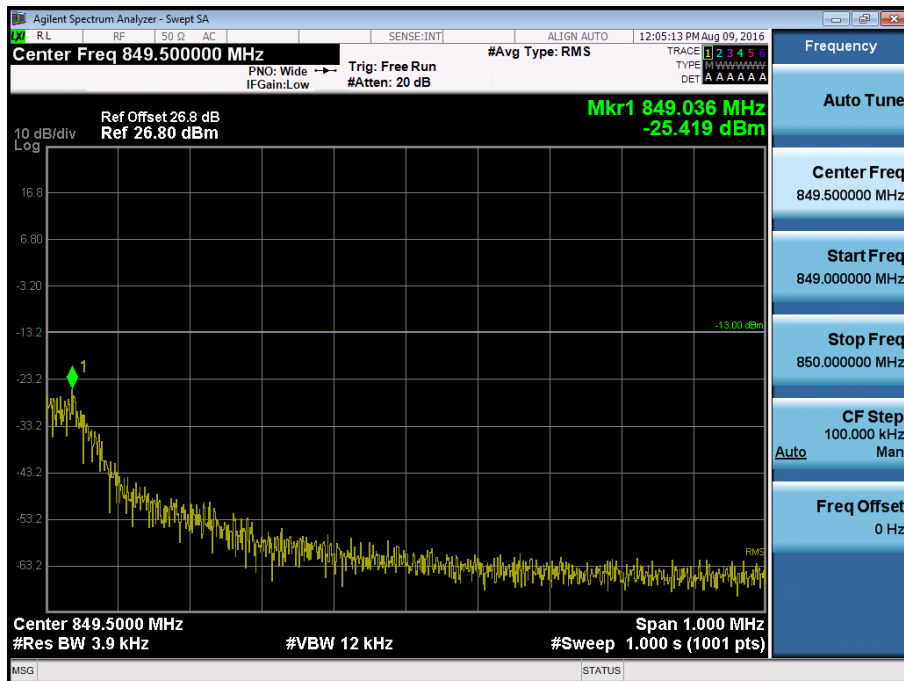

■ EDGE MODE (251 CH.) Block Edge 3

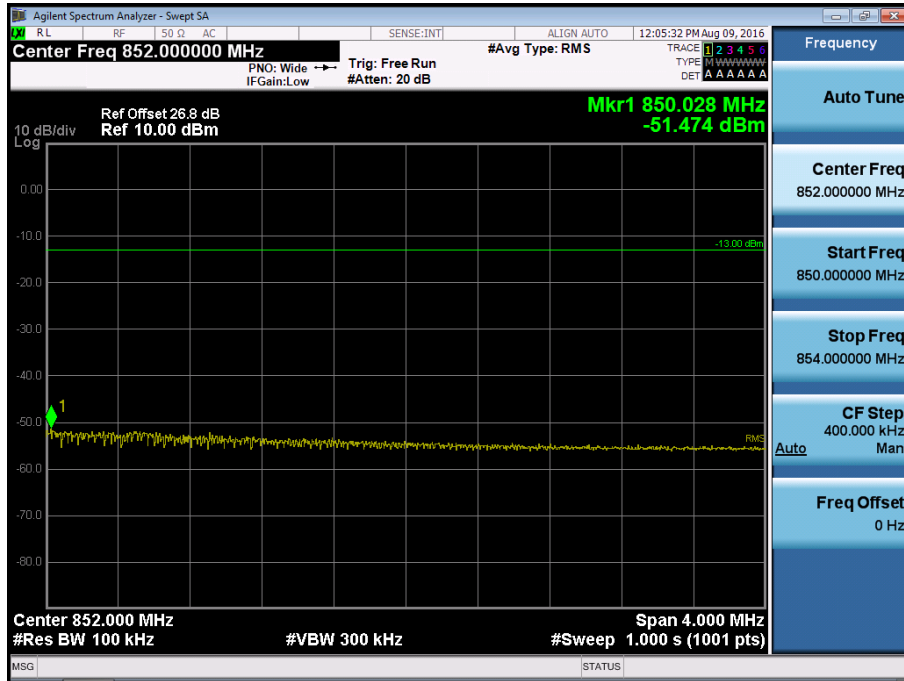

■ GSM1900 MODE (512 CH.) Block Edge 1

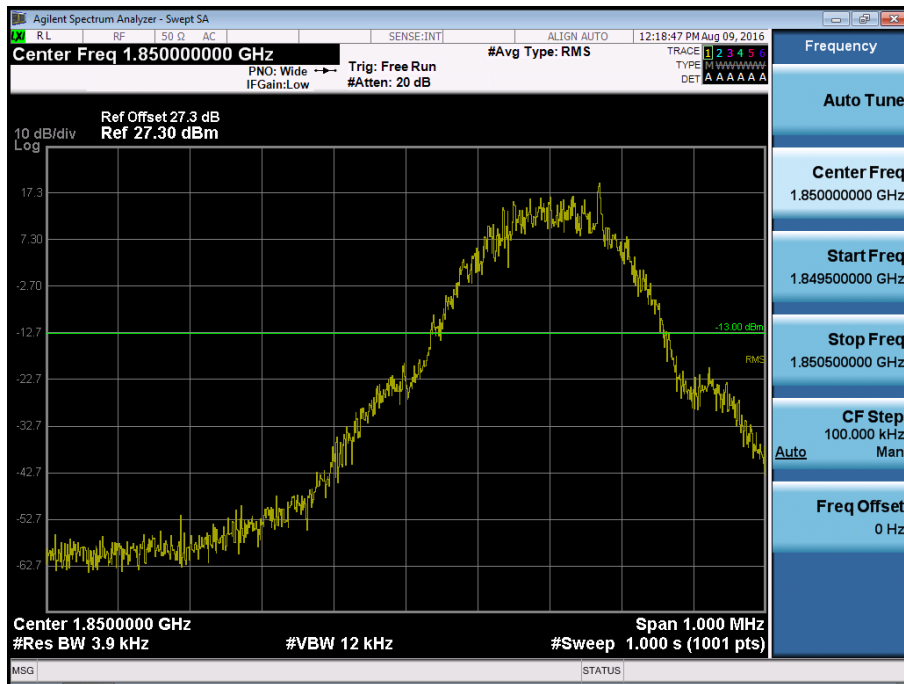

■ GSM1900 MODE (512 CH.) Block Edge 2

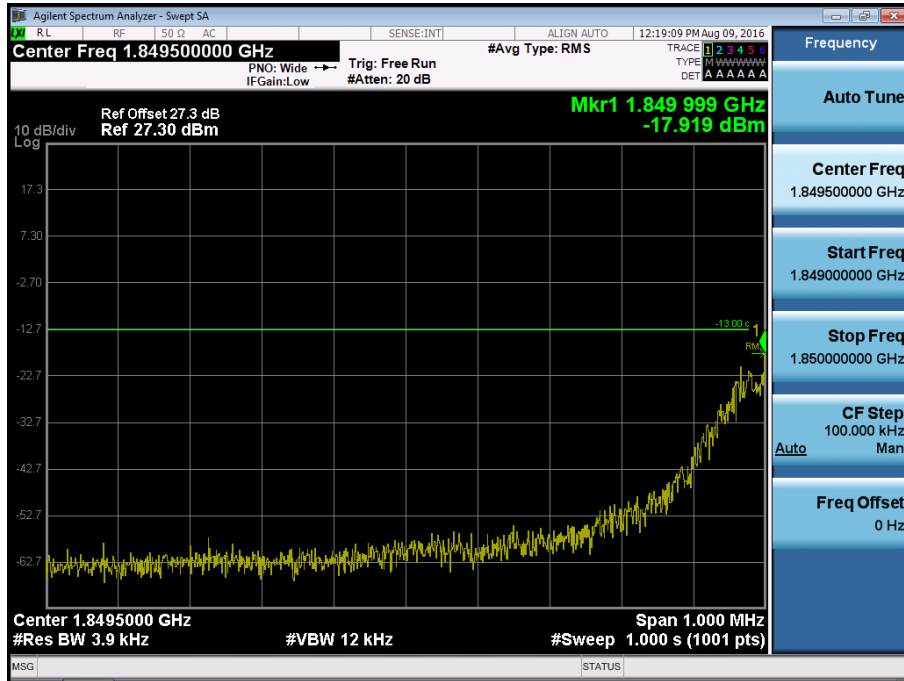

■ GSM1900 MODE (512 CH.) Block Edge 3

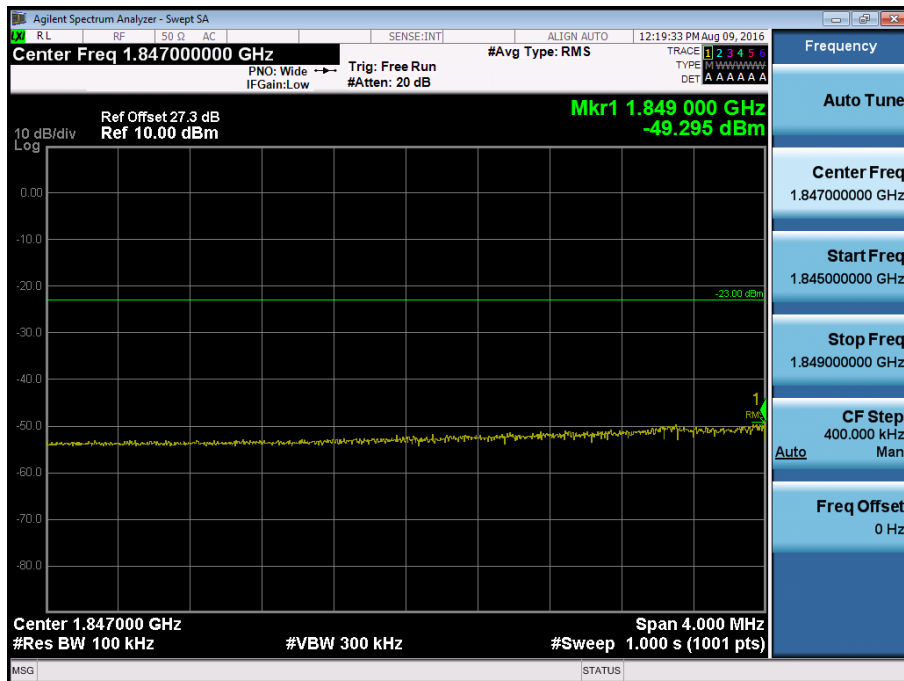

Note : We used a narrower RBW in order to increase accuracy.

Calculation = Reading Value + 10*log(1 MHz/100 kHz) dB = -49.295 dBm + 10 dB = -39.295 dBm

■ GSM1900 MODE (810 CH.) Block Edge 1

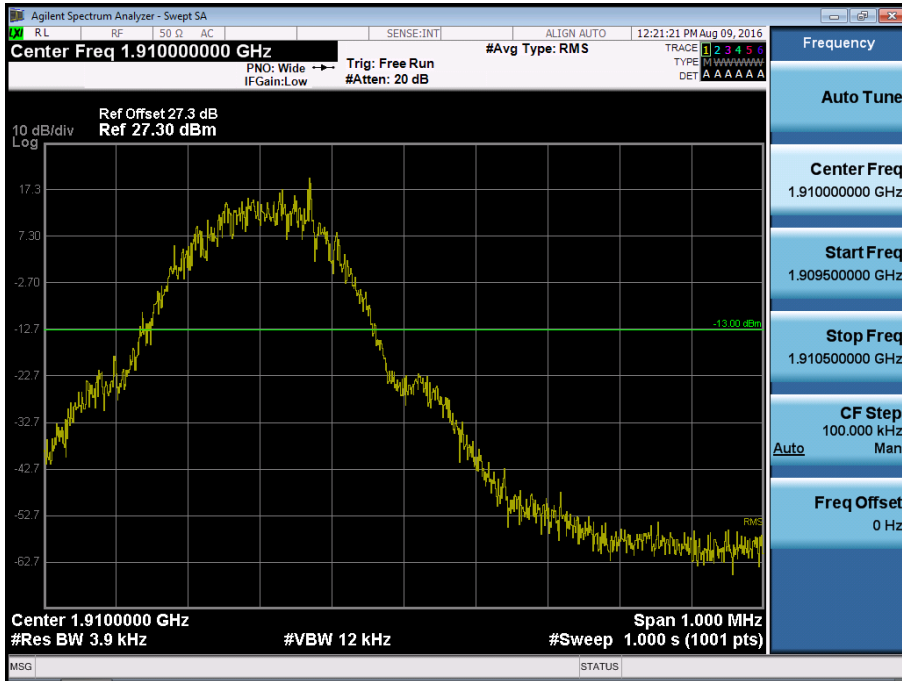

■ GSM1900 MODE (810 CH.) Block Edge 2

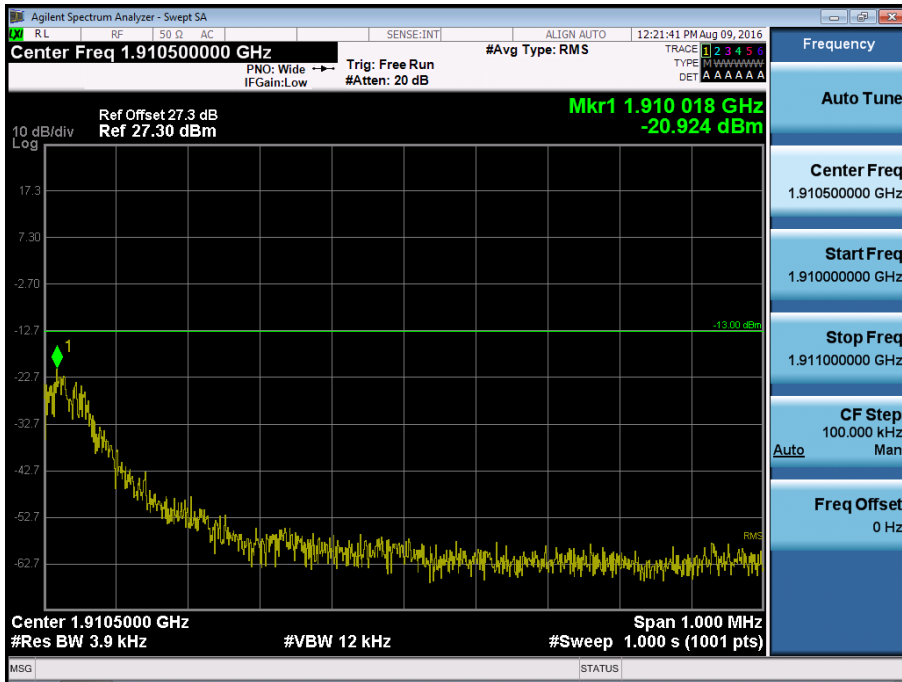

■ GSM1900 MODE (810 CH.) Block Edge 3

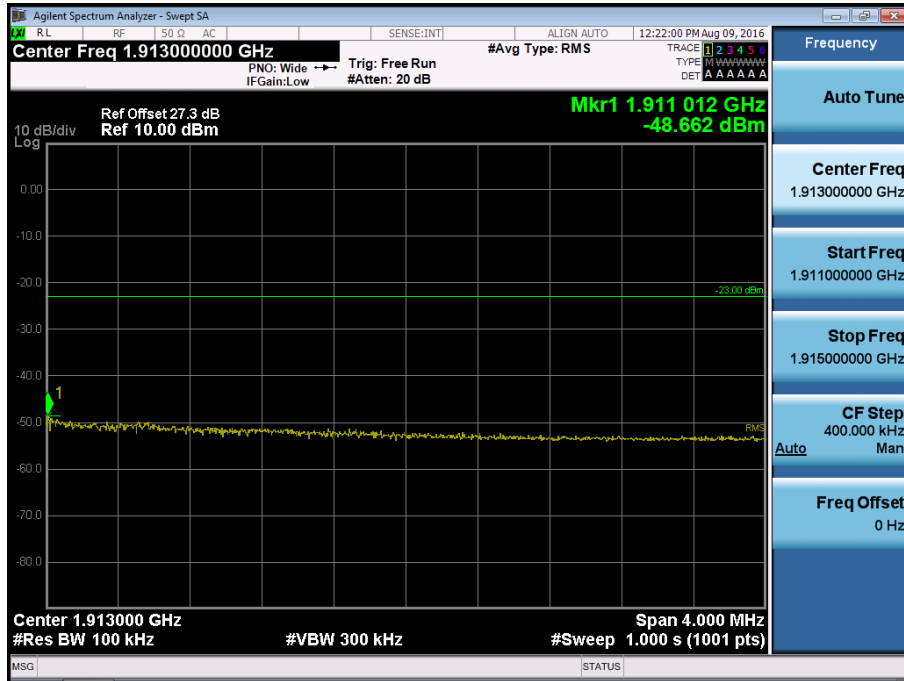

Note : We used a narrower RBW in order to increase accuracy.

Calculation = Reading Value + 10*log(1 MHz/100 kHz) dB = -48.662 dBm + 10 dB = **-38.662 dBm**

■ EDGE MODE (512 CH.) Block Edge 1

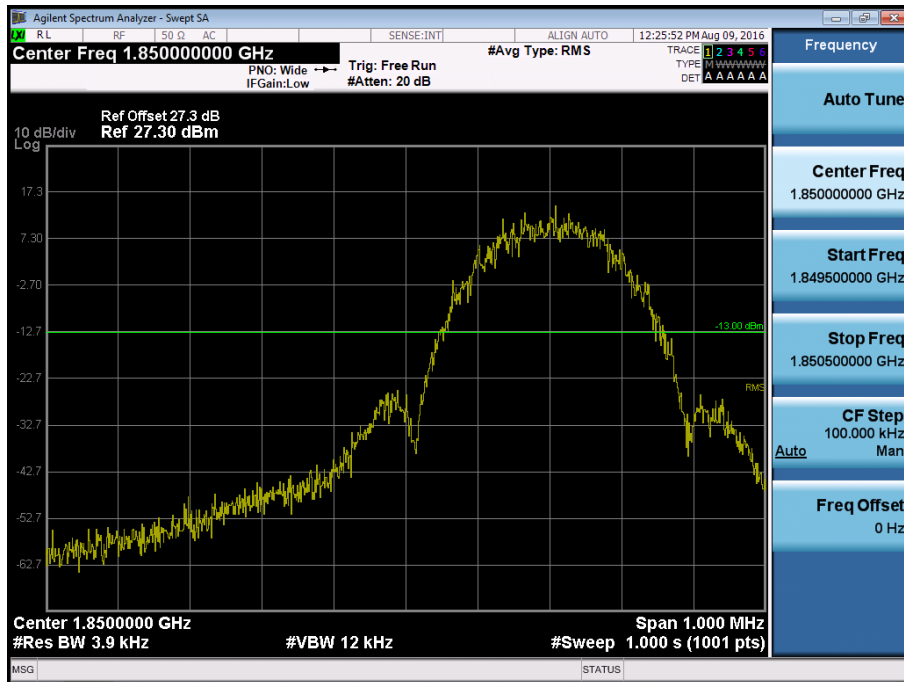

■ EDGE MODE (512 CH.) Block Edge 2

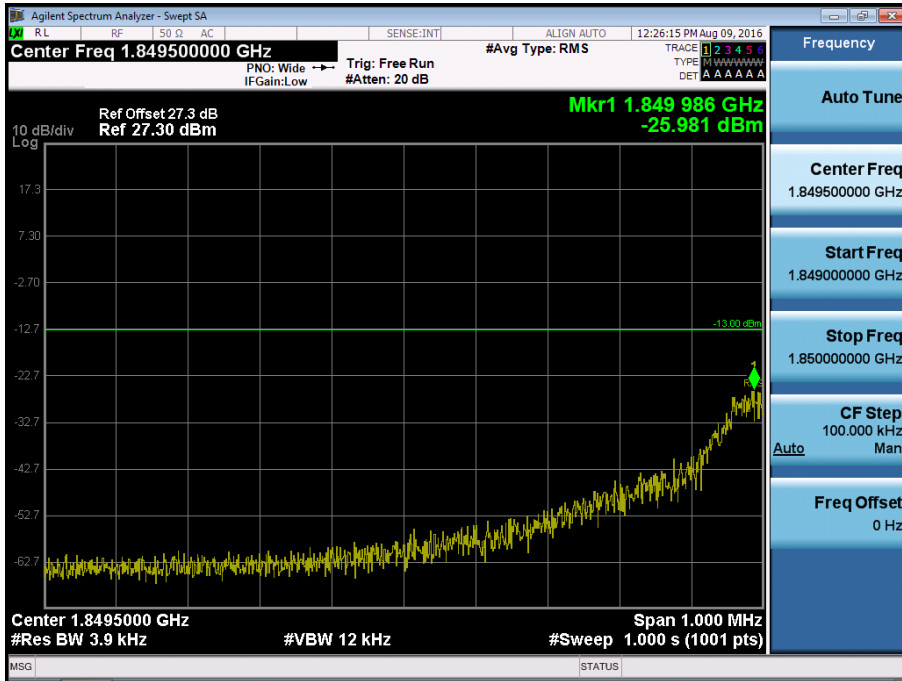

■ EDGE MODE (512 CH.) Block Edge 3

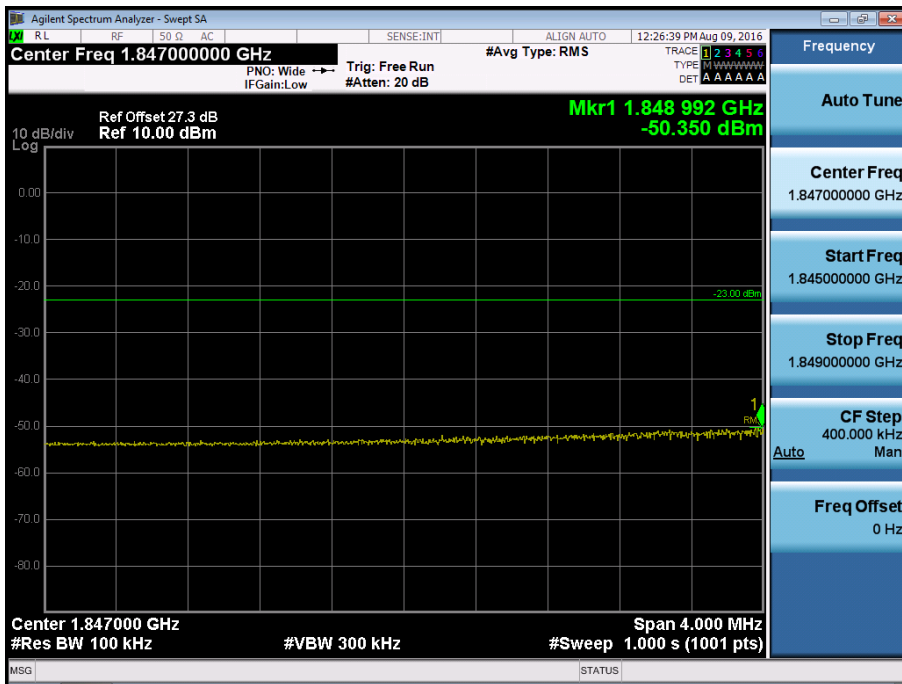

Note : We used a narrower RBW in order to increase accuracy.

Calculation = Reading Value + $10 \cdot \log(1 \text{ MHz}/100 \text{ kHz}) \text{ dB} = -50.350 \text{ dBm} + 10 \text{ dB} = -40.350 \text{ dBm}$

■ EDGE MODE (810 CH.) Block Edge 1

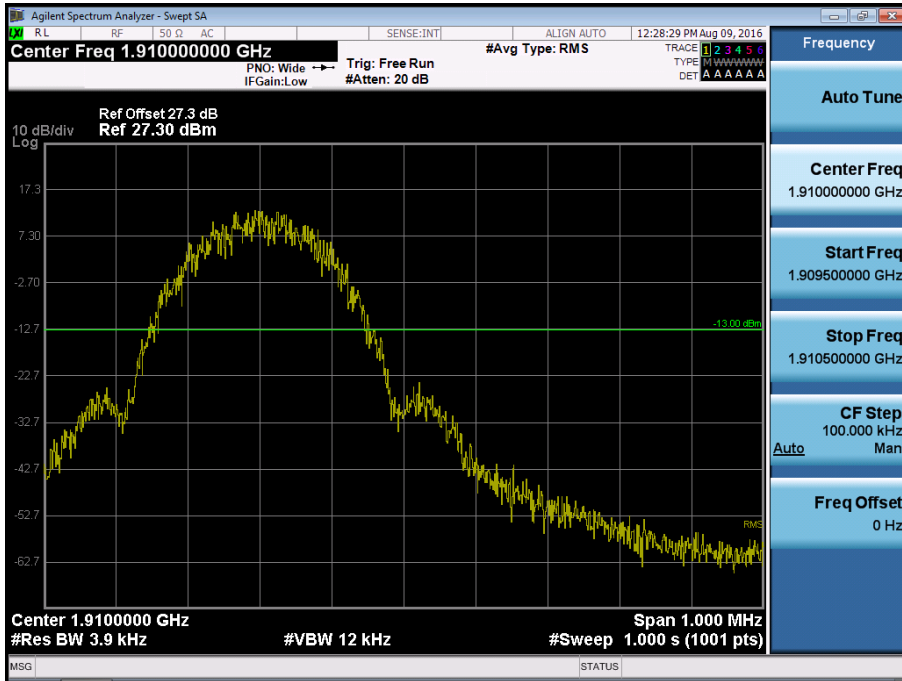

■ EDGE MODE (810 CH.) Block Edge 2

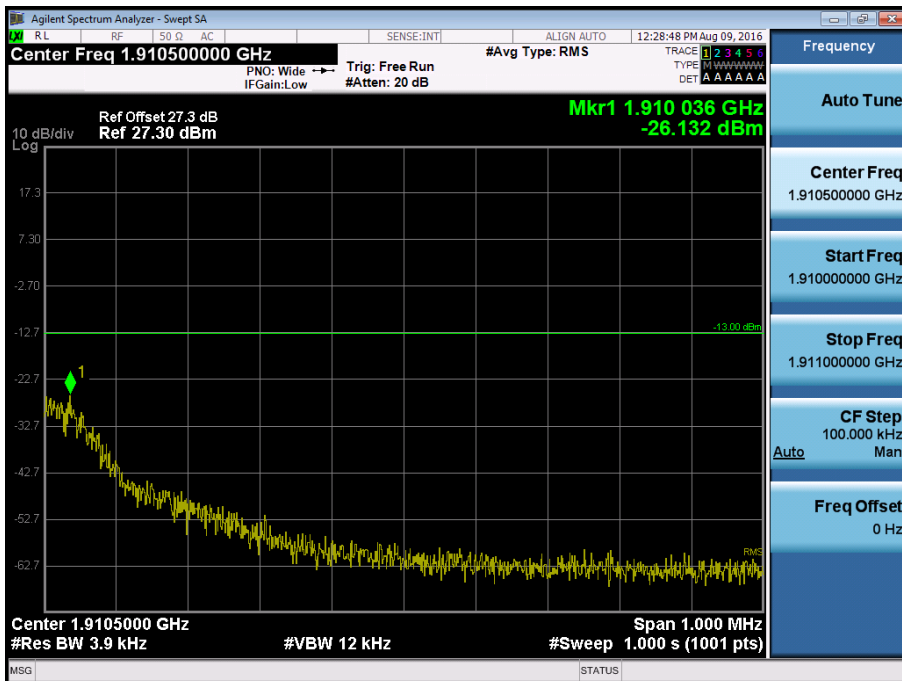

■ EDGE MODE (810 CH.) Block Edge 3

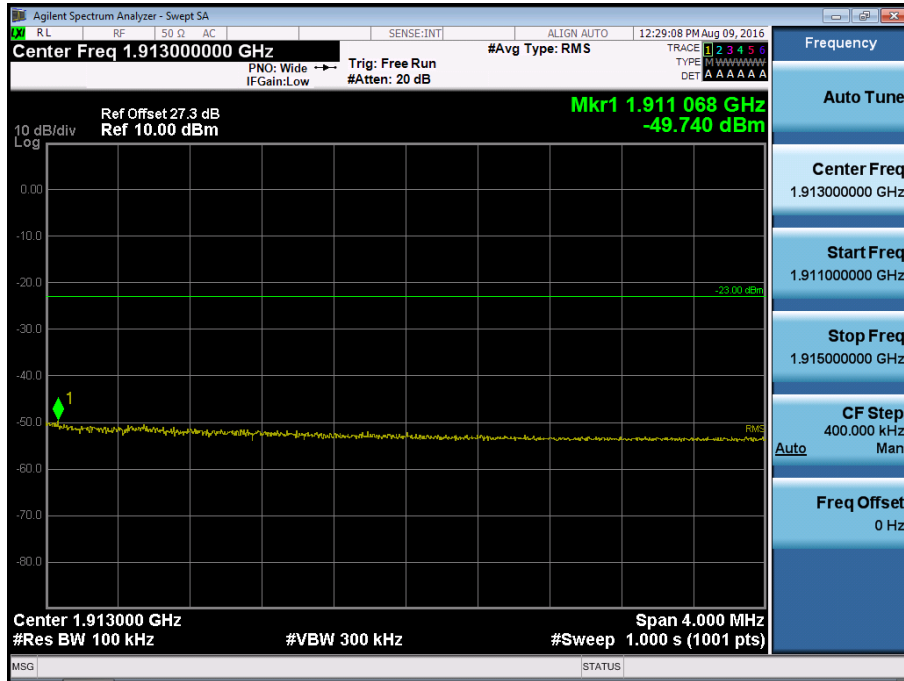

Note : We used a narrower RBW in order to increase accuracy.

Calculation = Reading Value + 10*log(1 MHz/100 kHz) dB = -49.740 dBm + 10 dB = **-39.740 dBm**

■ WCDMA850 MODE (4132 CH.) Block Edge

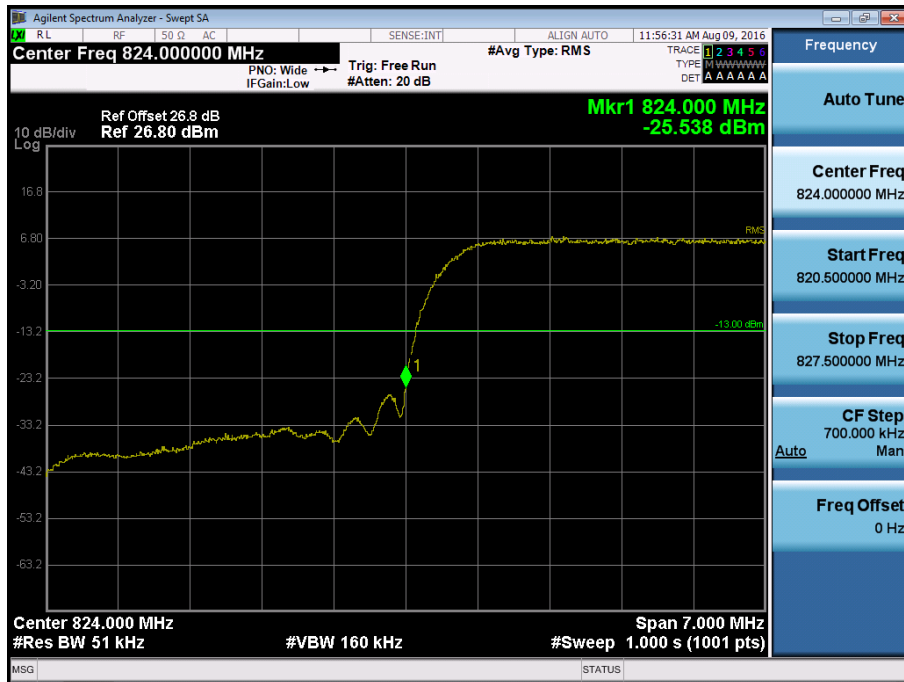

■ WCDMA850 MODE (4132 CH.) – 4 MHz Span



■ WCDMA850MODE (4233 CH.) Block Edge



■ WCDMA850MODE (4233 CH.) – 4 MHz Span



■ WCDMA1900 MODE (9262 CH.) Block Edge

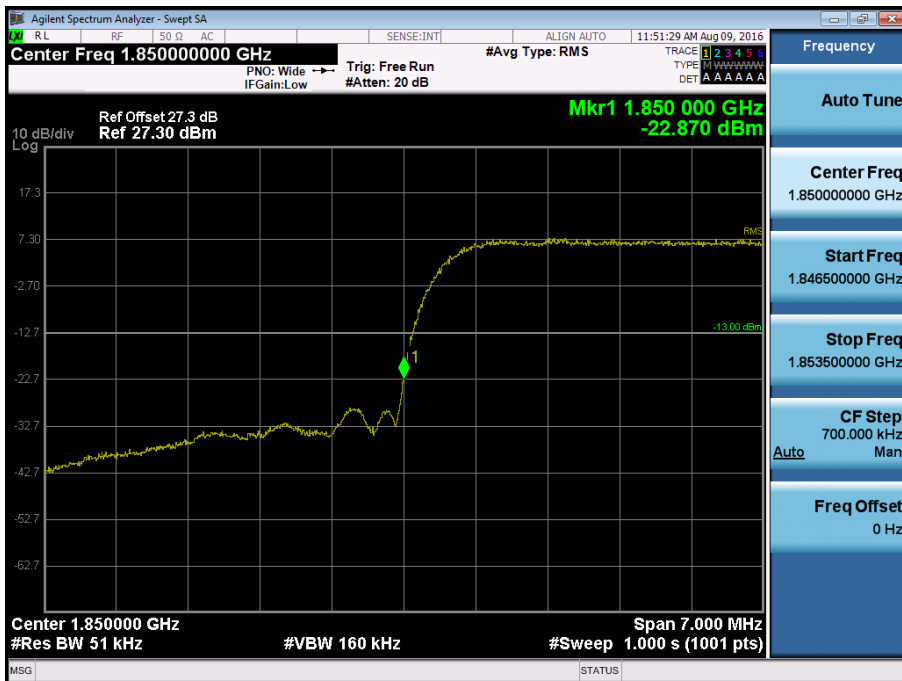

■ WCDMA1900 MODE (9262 CH.) – 4 MHz Span

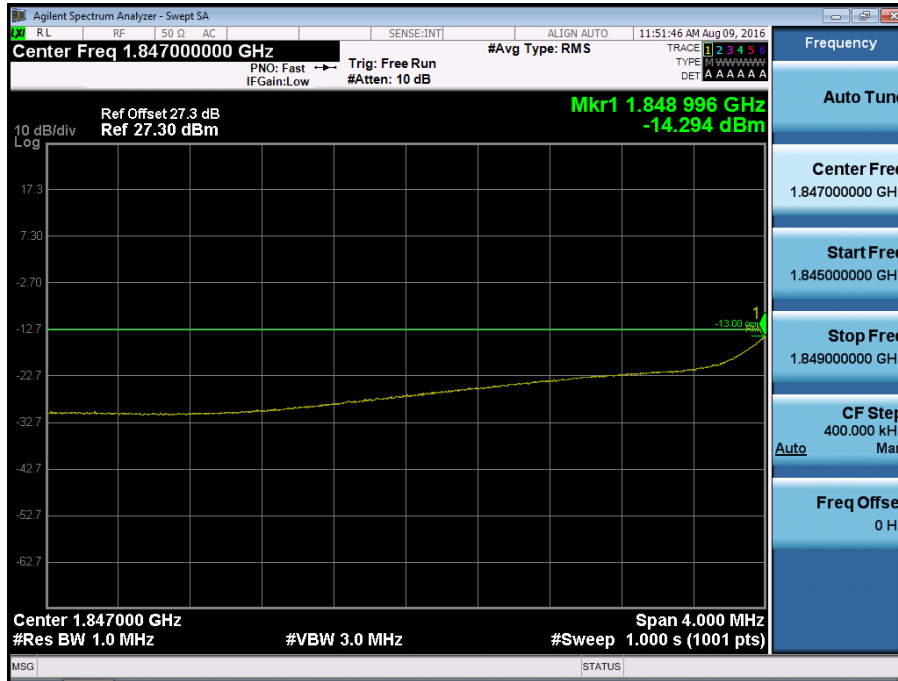

■ WCDMA1900 MODE (9538 CH.) Block Edge



■ WCDMA1900 MODE (9538 CH.) – 4 MHz Span



■ WCDMA1700 MODE (1312 CH.) Block Edge

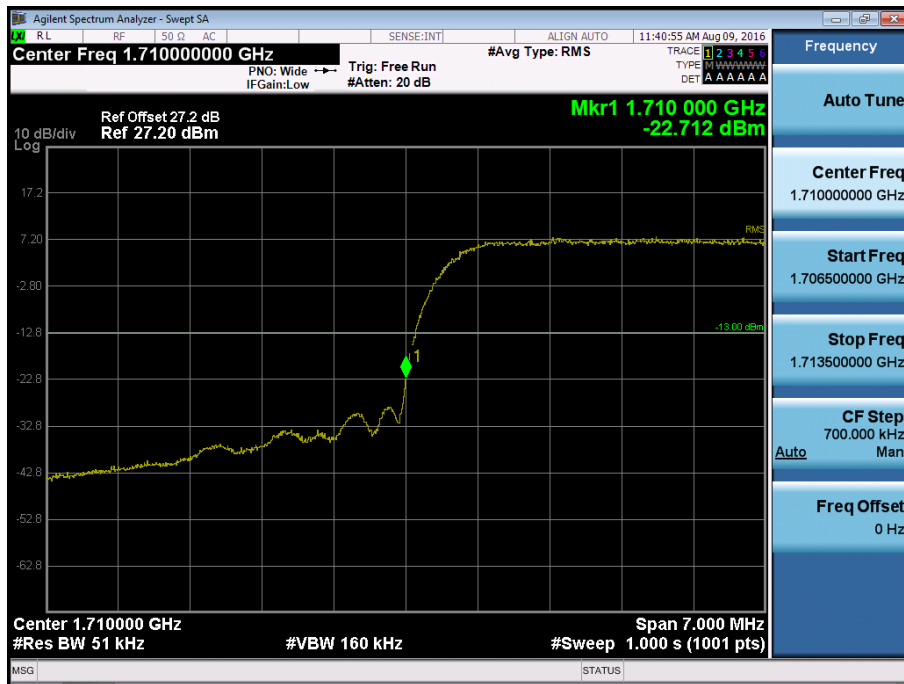

■ WCDMA1700 MODE (1312 CH.) – 4 MHz Span

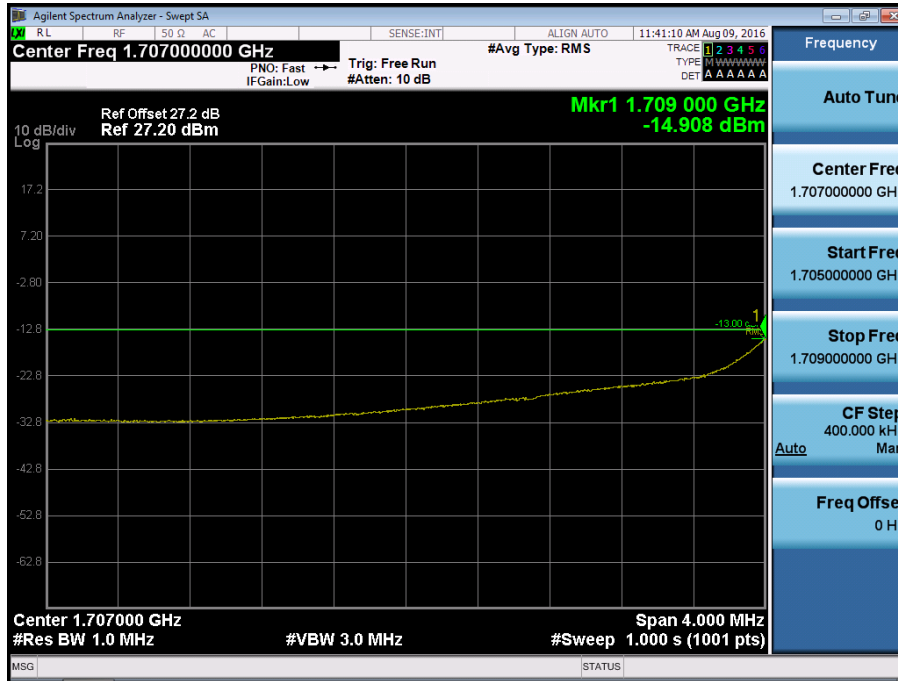

■ WCDMA1700 MODE (1513 CH.) Block Edge

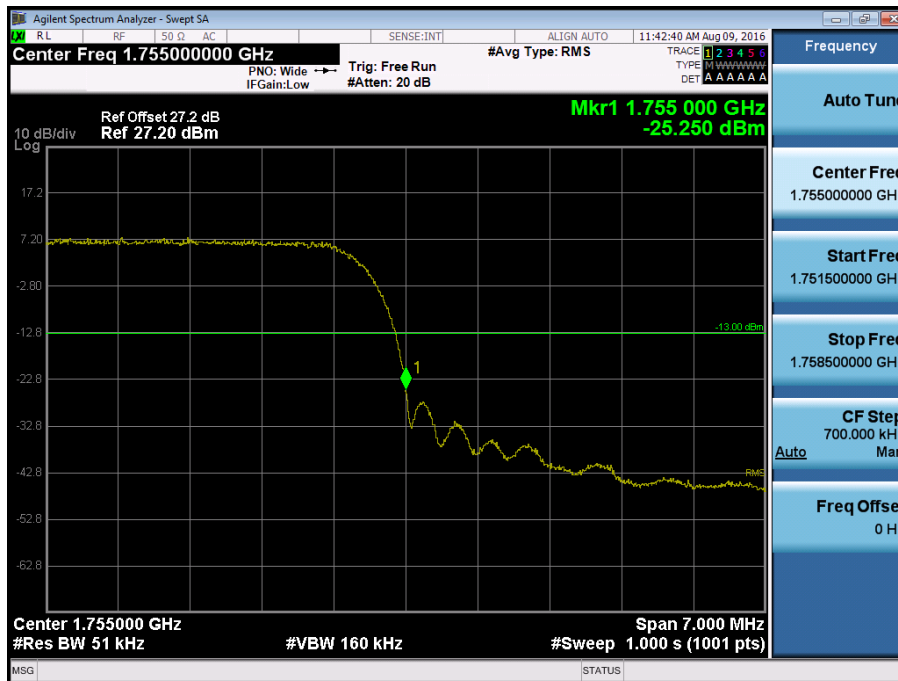

■ WCDMA1700 MODE (1513 CH.) – 4 MHz Span

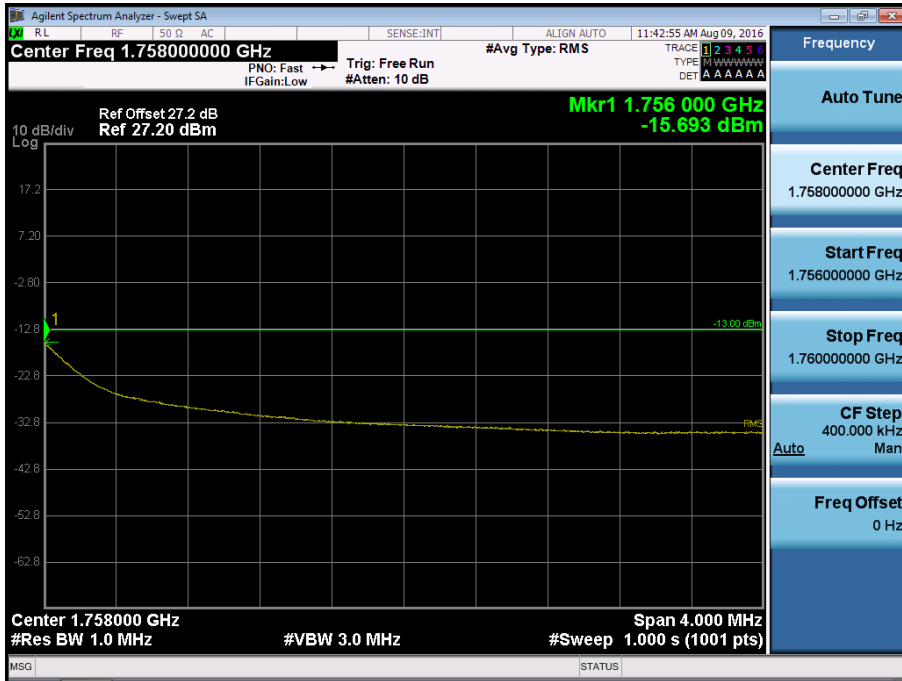

■ GSM850 MODE (128 CH.) Conducted Spurious Emissions

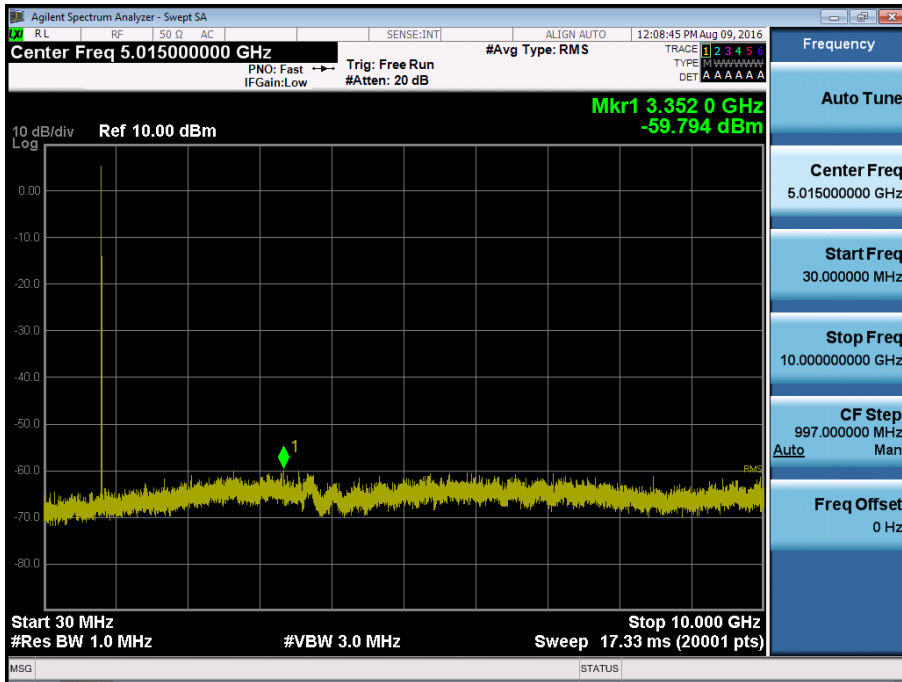

■ GSM850 MODE (190 CH.) Conducted Spurious Emissions

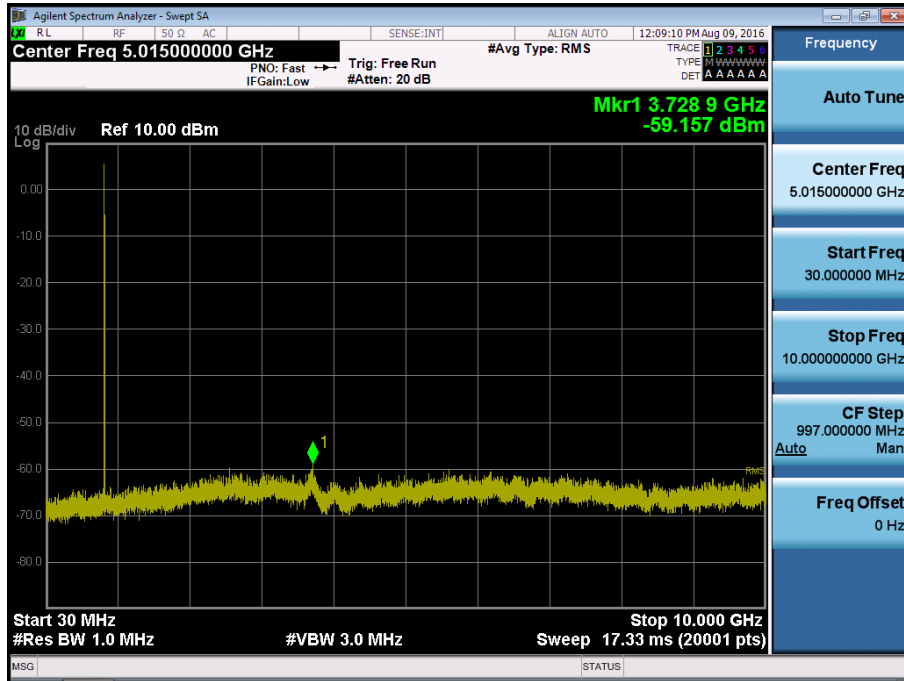

■ GSM850 MODE (251 CH.) Conducted Spurious Emissions

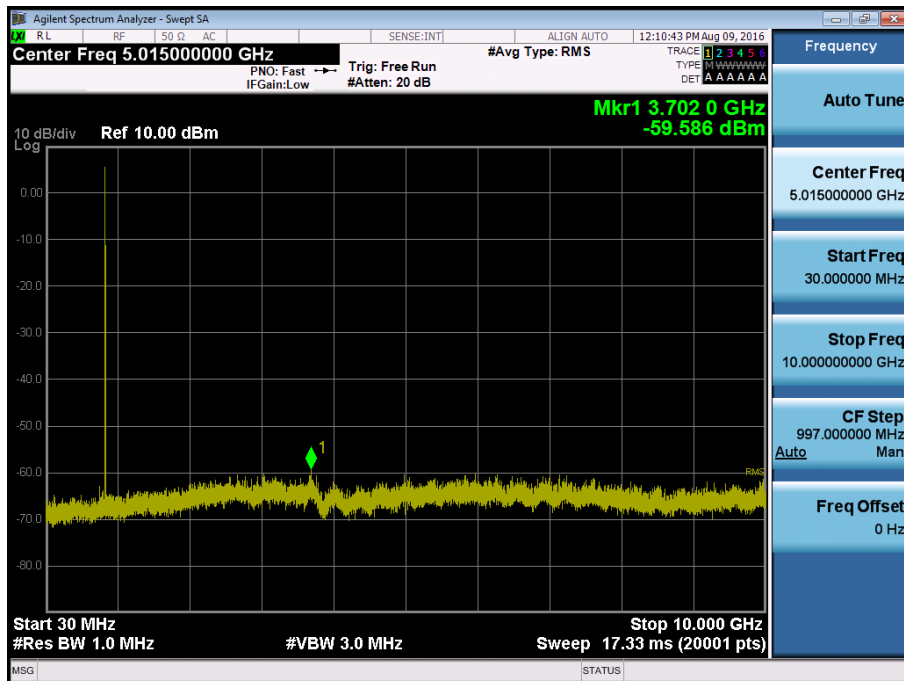

■ GSM1900 MODE (512 CH.) Conducted Spurious Emissions1

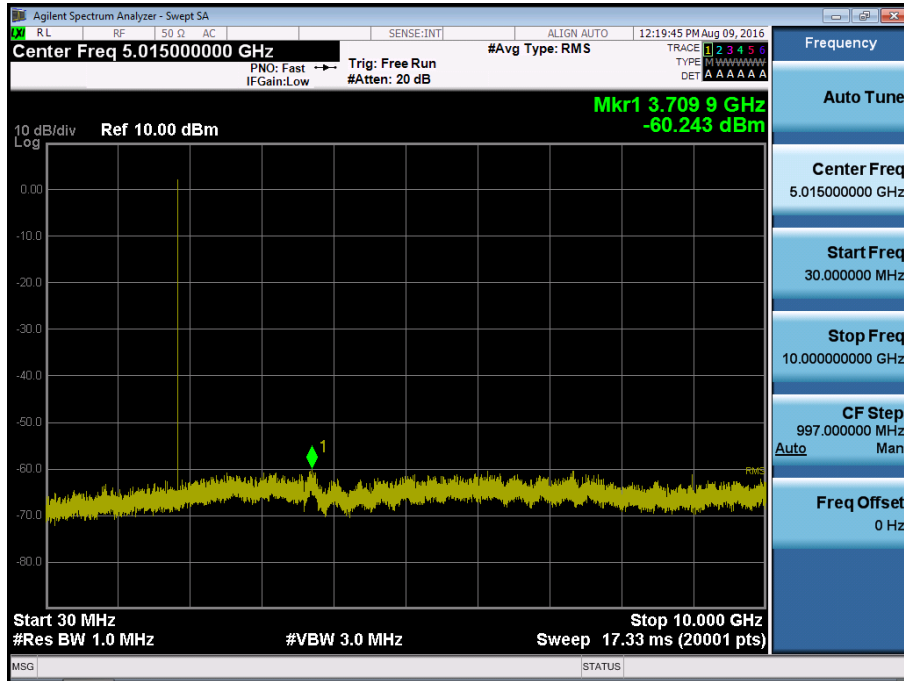

■ GSM1900 MODE (512 CH.) Conducted Spurious Emissions2

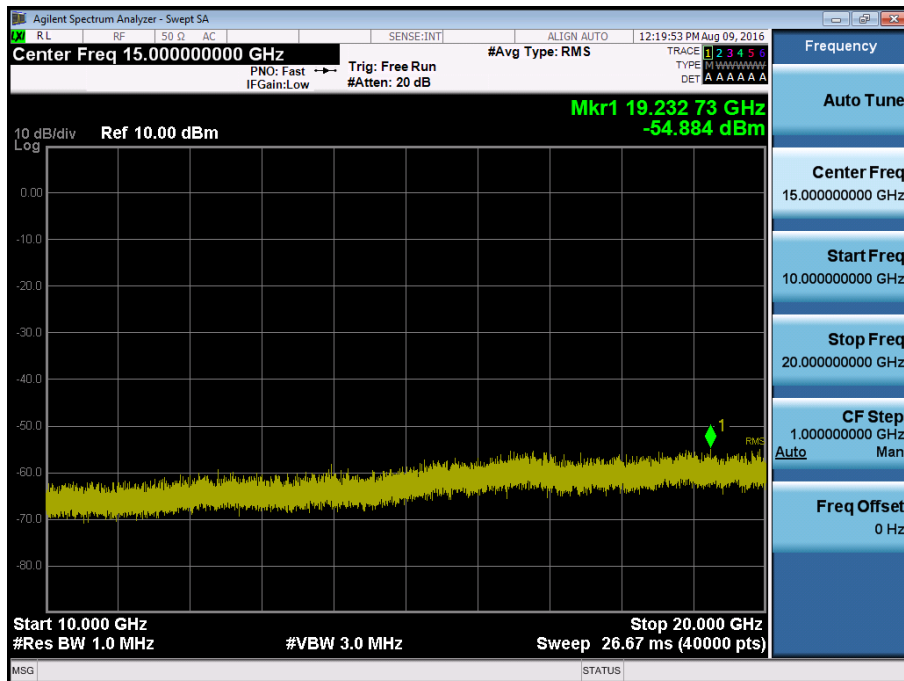

■ GSM1900 MODE (661 CH) Conducted Spurious Emissions1

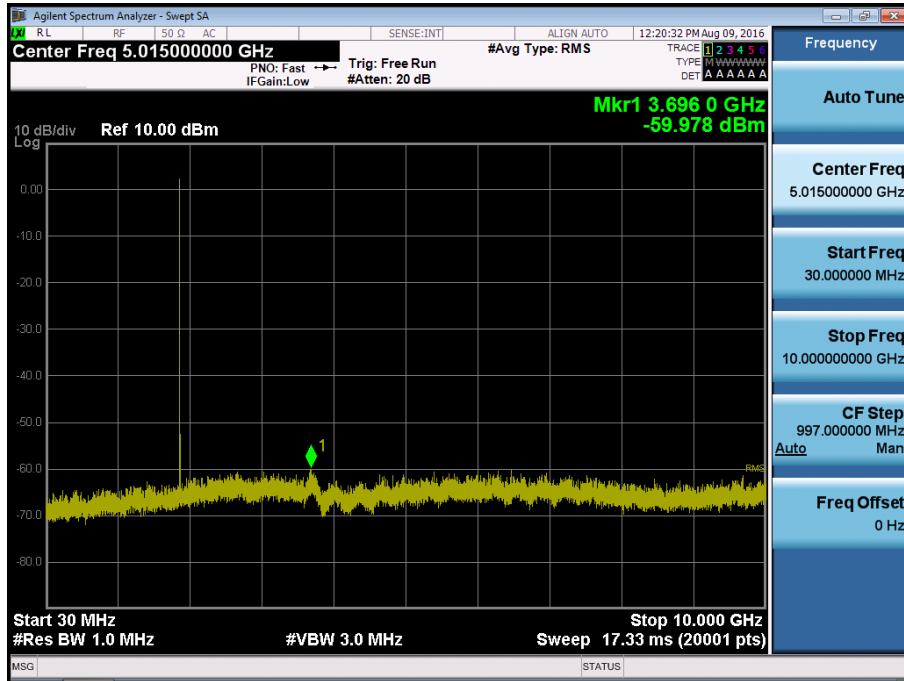

■ GSM1900 MODE (661 CH.) Conducted Spurious Emissions2

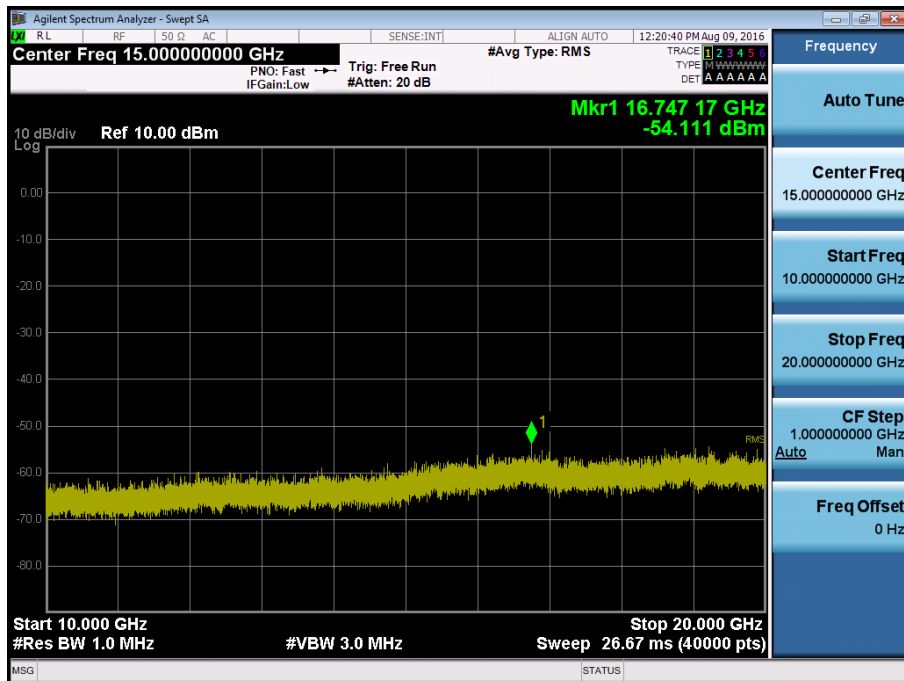

■ GSM1900 MODE (810 CH.) Conducted Spurious Emissions1

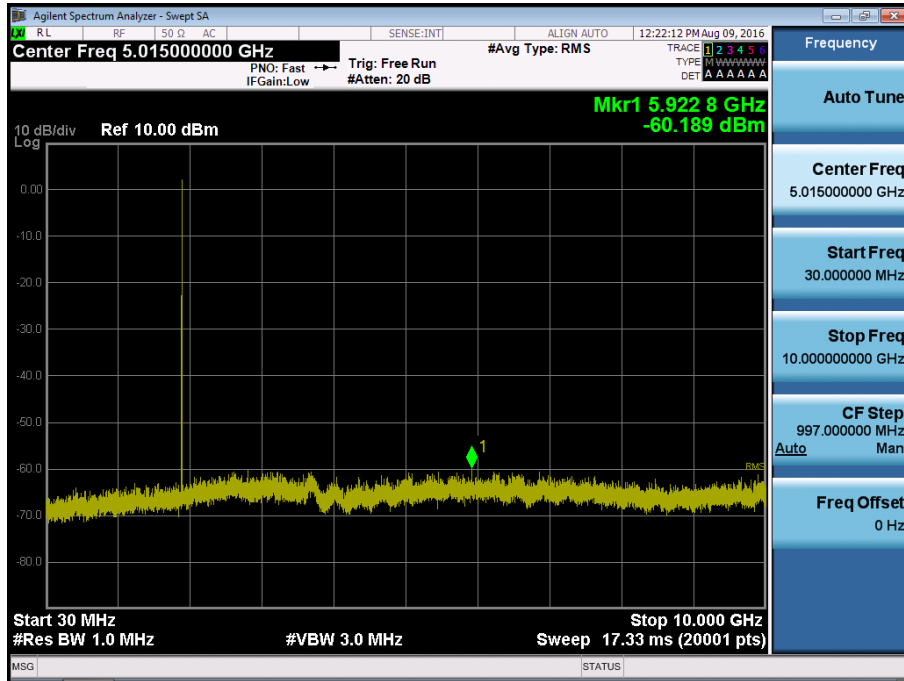

■ GSM1900 MODE (810 CH.) Conducted Spurious Emissions2

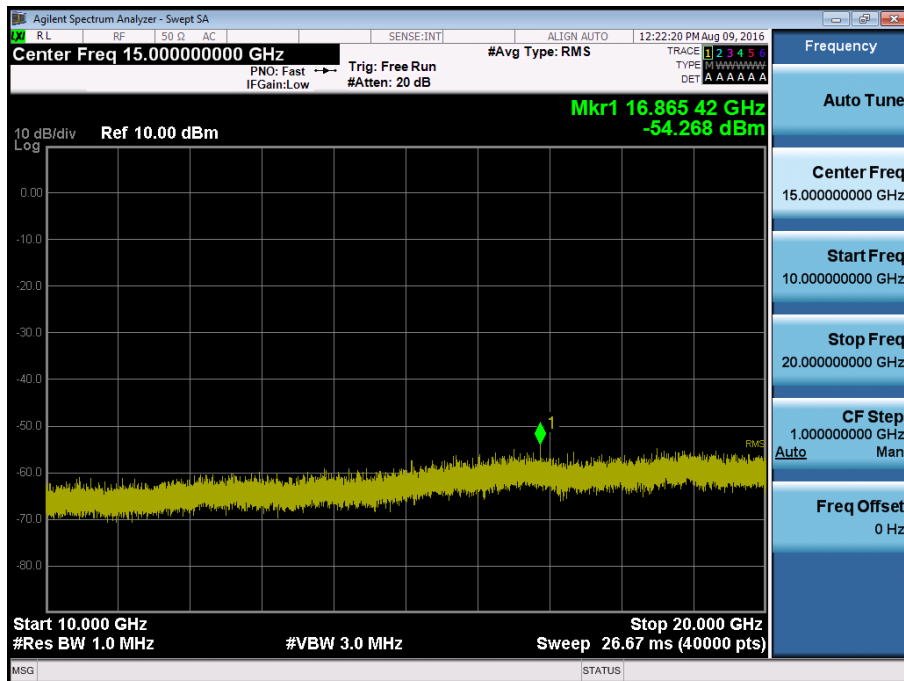

■ WCDMA850 MODE (4132 CH.) Conducted Spurious Emissions

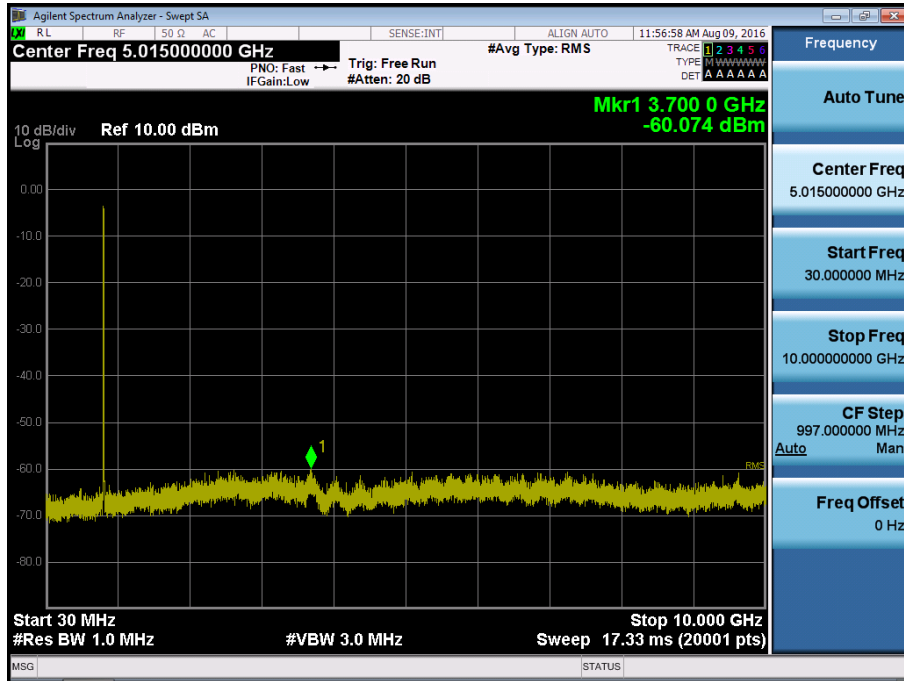

■ WCDMA850 MODE (4183 CH.) Conducted Spurious Emissions

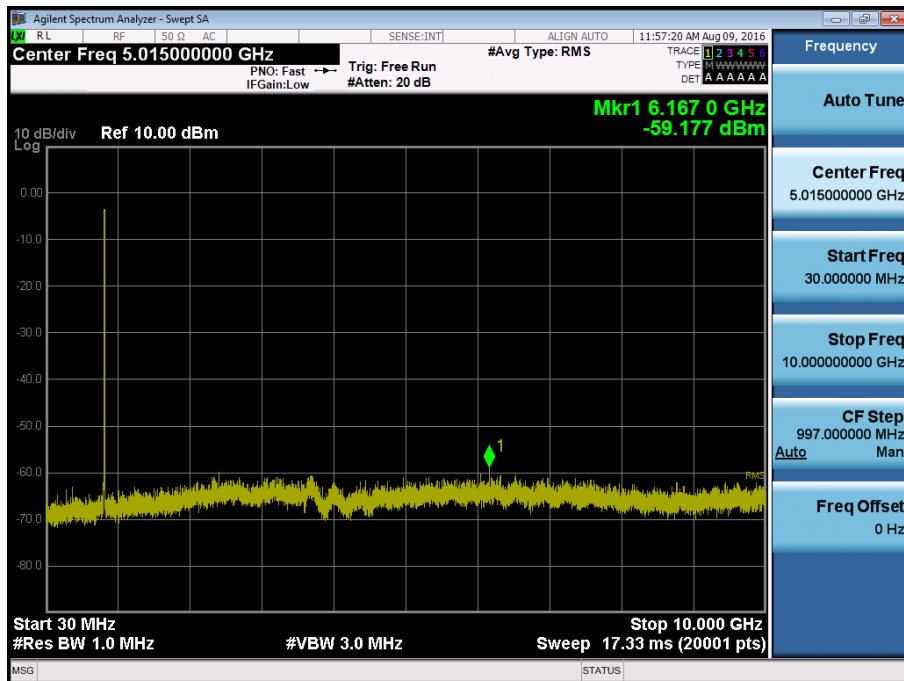

■ WCDMA850MODE (4233 CH.) Conducted Spurious Emissions

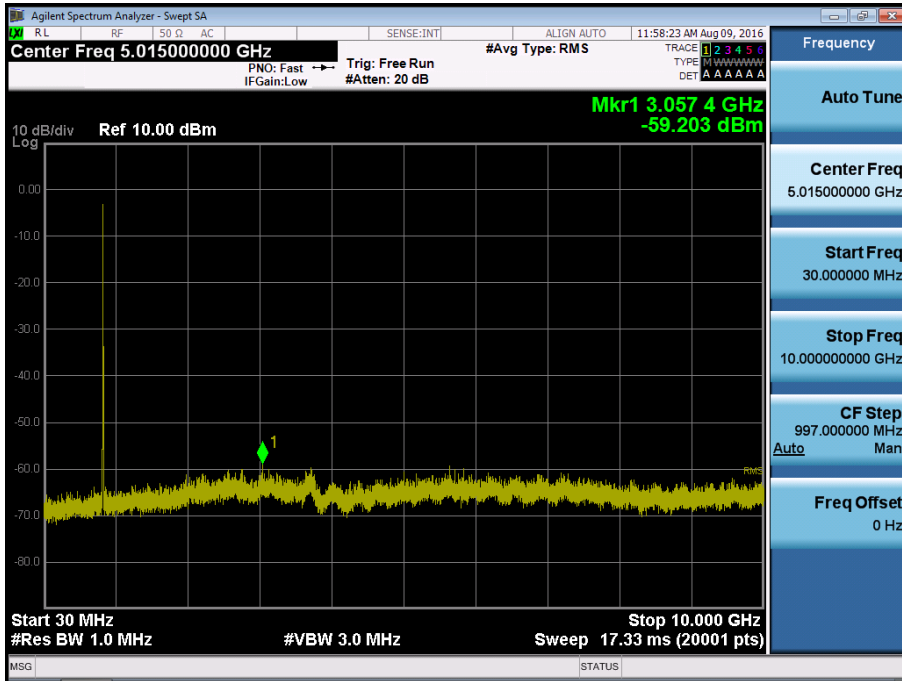

■ WCDMA1900 MODE (9262 CH.) Conducted Spurious Emissions1

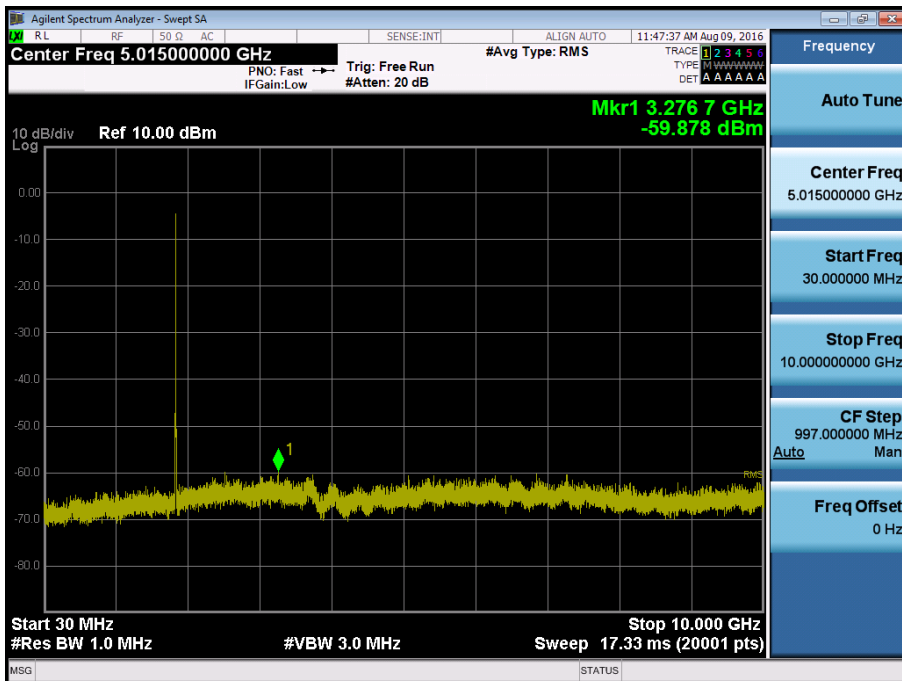

■ WCDMA1900 MODE (9262 CH.) Conducted Spurious Emissions2

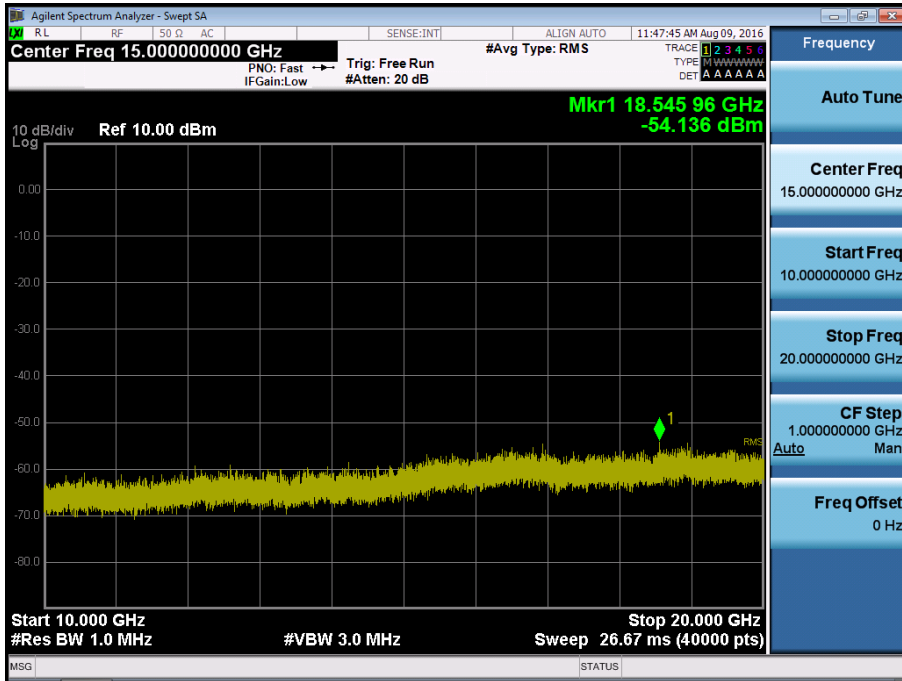

■ WCDMA1900 MODE (9400 CH.) Conducted Spurious Emissions1

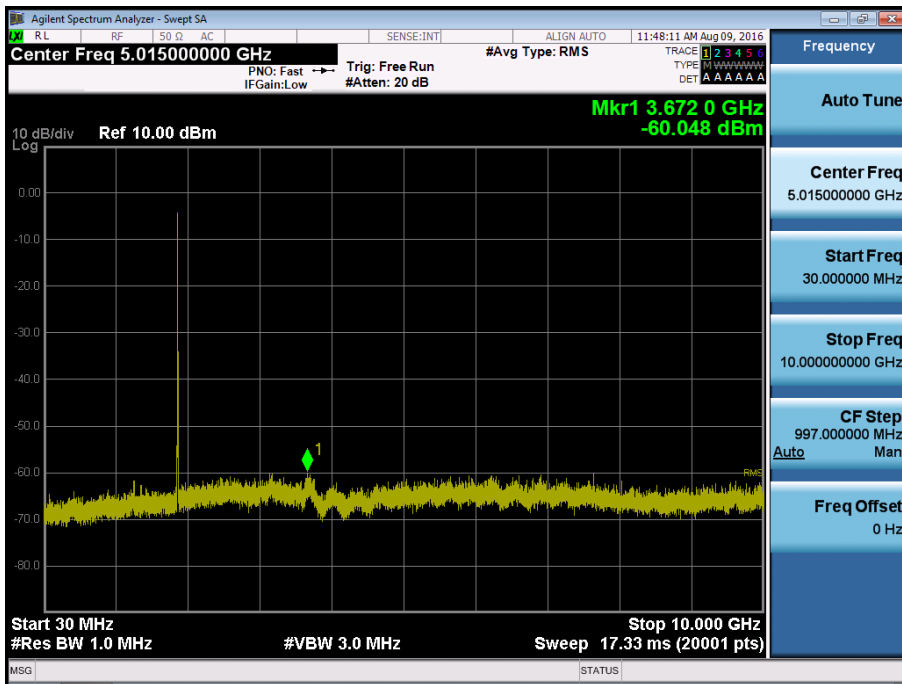

■ WCDMA1900 MODE (9400 CH.) Conducted Spurious Emissions2

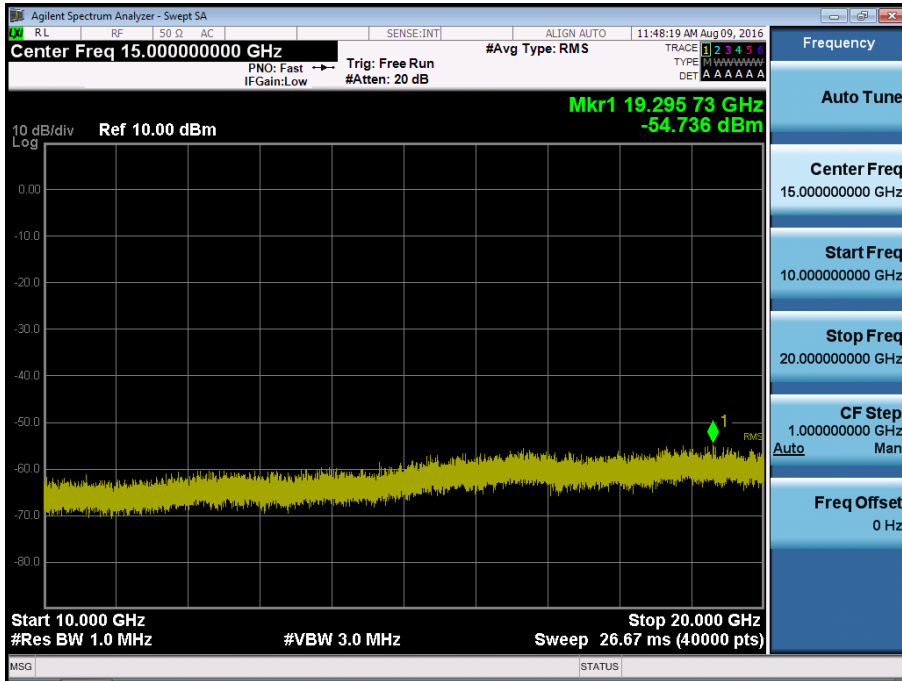

■ WCDMA1900 MODE (9538 CH.) Conducted Spurious Emissions1

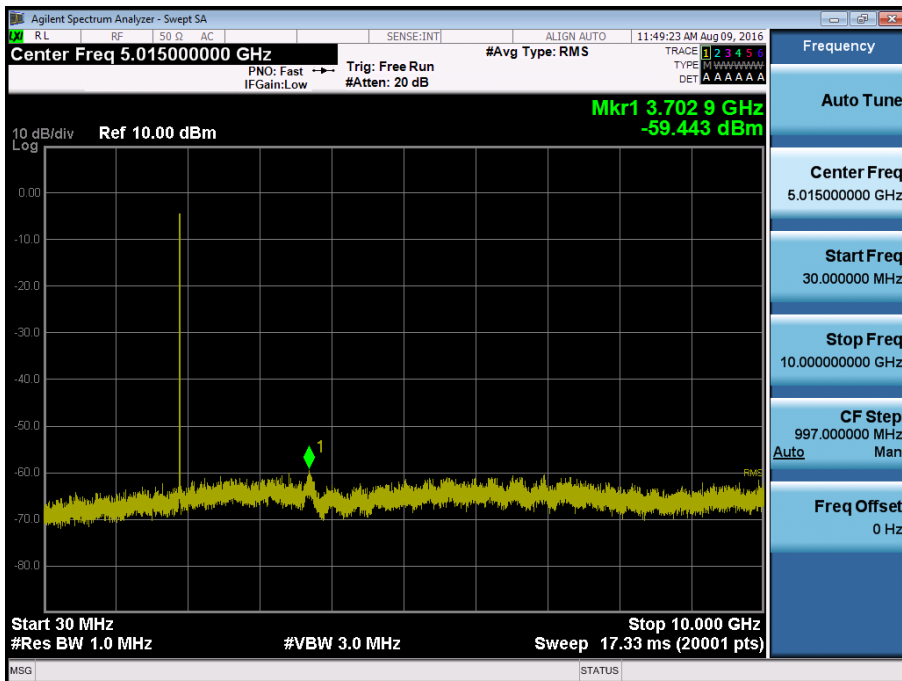

■ WCDMA1900 MODE (9538 CH.) Conducted Spurious Emissions2

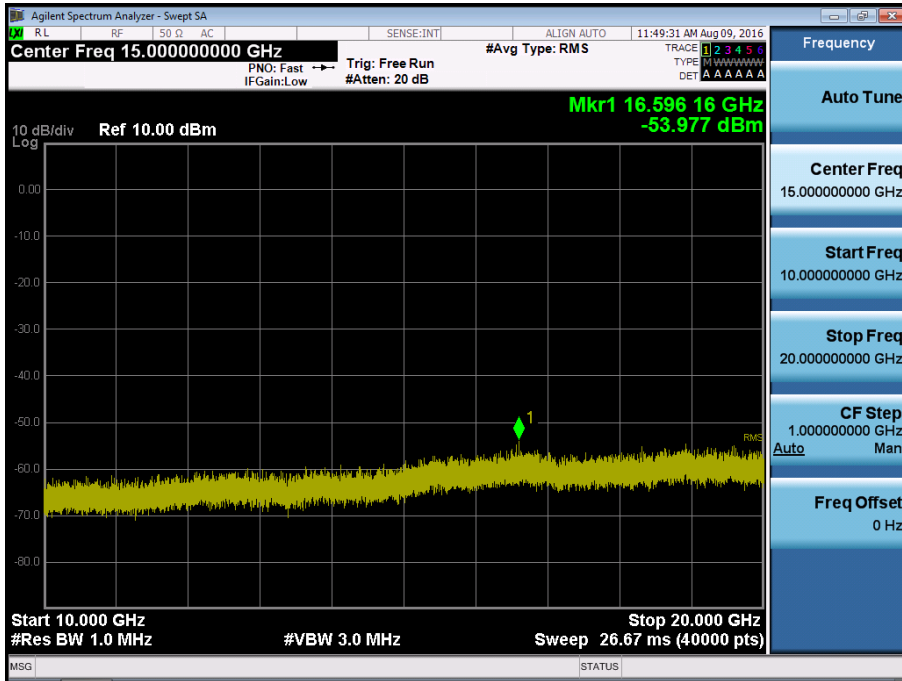

■ WCDMA1700 MODE (1312 CH.) Conducted Spurious Emissions1

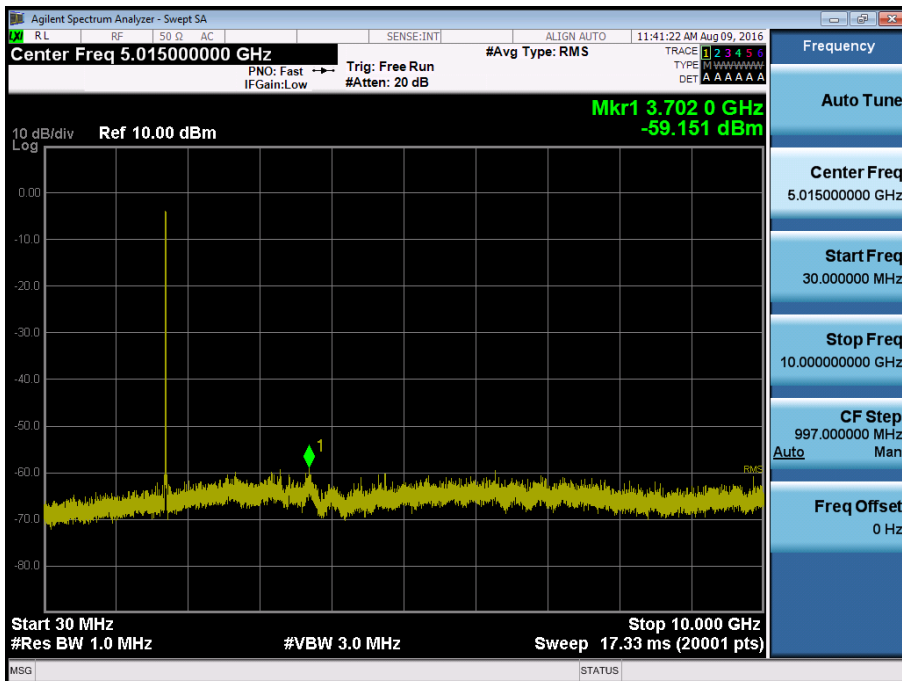

■ WCDMA1700 MODE (1312 CH.) Conducted Spurious Emissions2

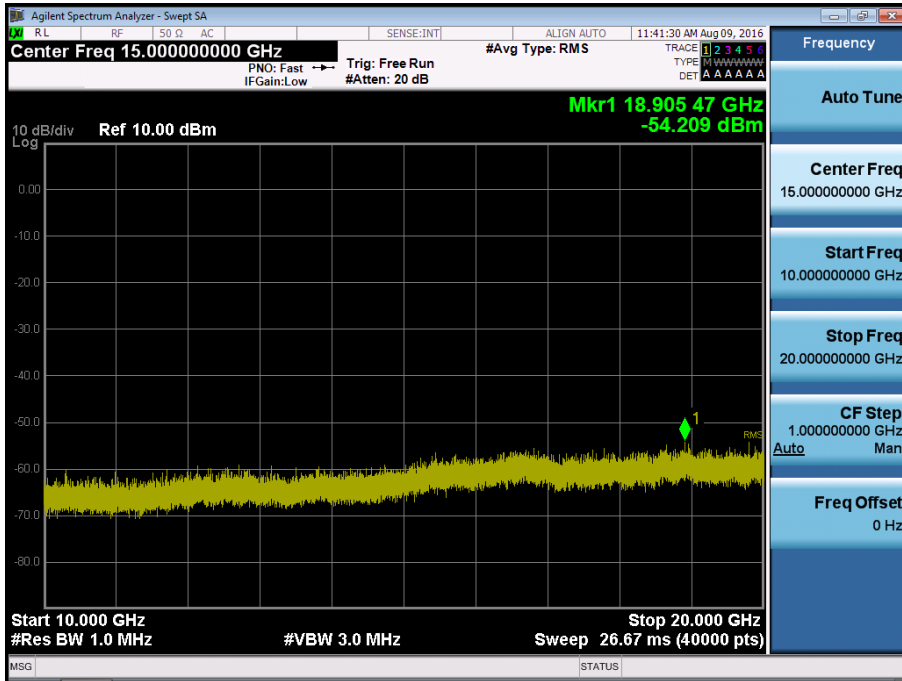

■ WCDMA1700 MODE (1412 CH.) Conducted Spurious Emissions1

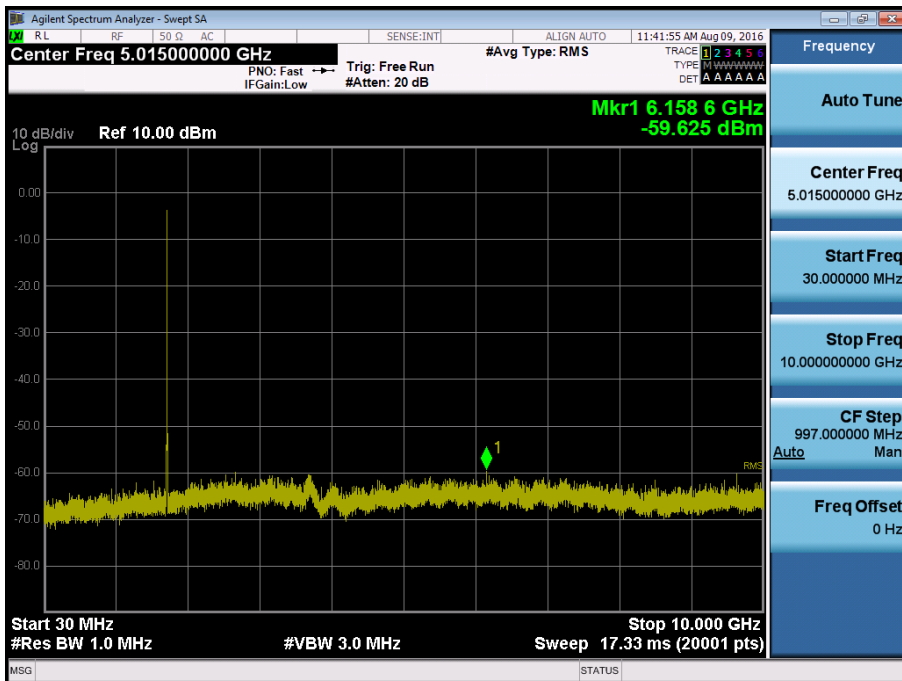

■ WCDMA1700 MODE (1412 CH.) Conducted Spurious Emissions2

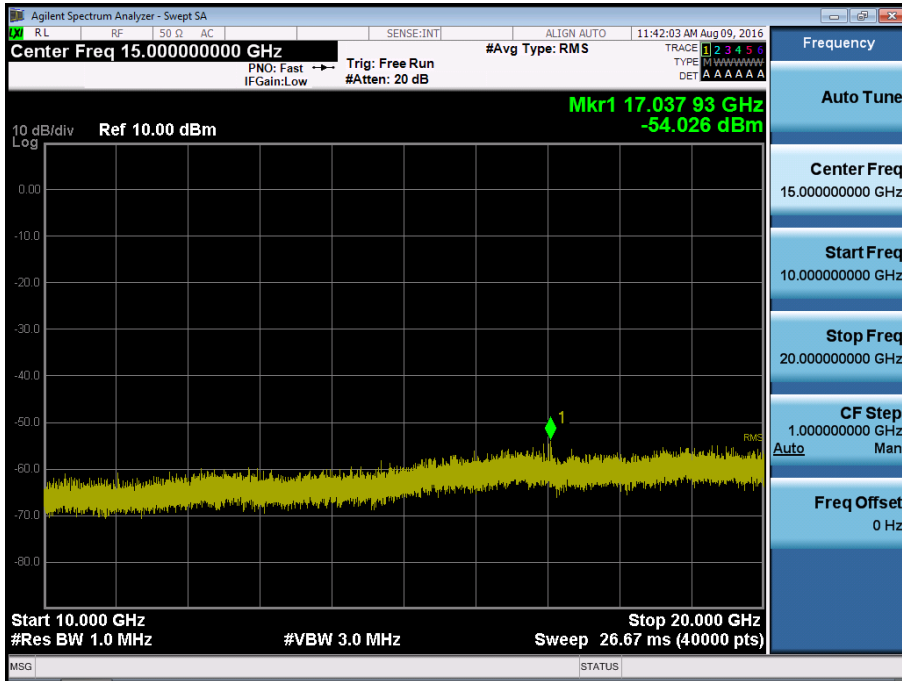

■ WCDMA1700 MODE (1513 CH.) Conducted Spurious Emissions1

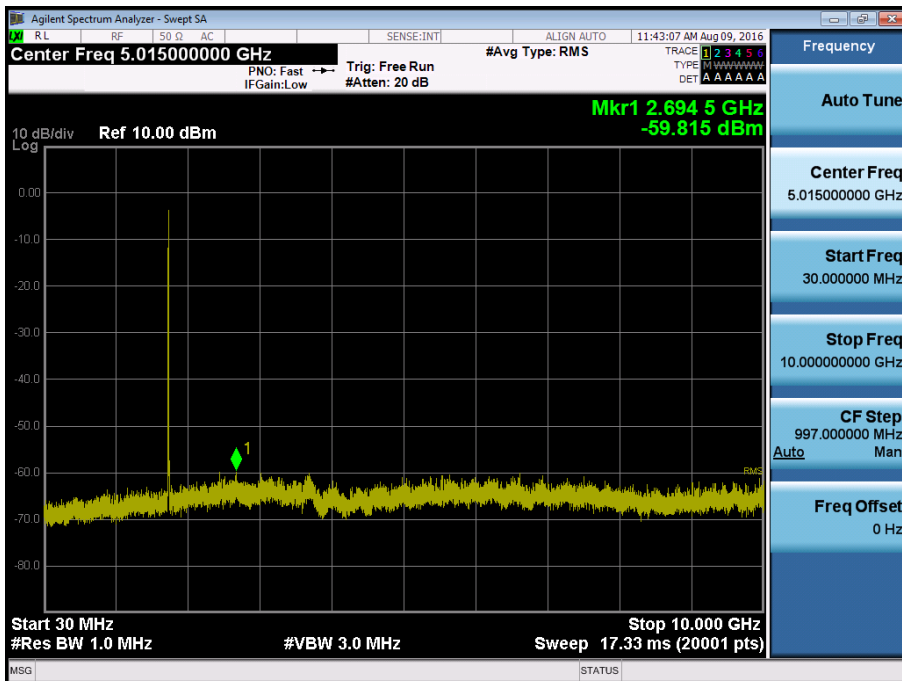

■ WCDMA1700 MODE (1513 CH.) Conducted Spurious Emissions2

