

# REPORT

## FCC Certification

**Applicant Name:**

LG Electronics MobileComm U.S.A., Inc.

**Address:**

1000 Sylvan Avenue, Englewood Cliffs NJ 07632

**Date of Issue:**

January 19, 2015

**Test Site/Location:**HCT CO., LTD., 74, Seoicheon-ro 578beon-gil,  
Majang-myeon, Icheon-si, Gyeonggi-do, Korea**Report No.:** HCT-R-1501-F025**HCT FRN:** 0005866421**FCC ID:** ZNFH955A**APPLICANT:** LG Electronics MobileComm U.S.A., Inc.**FCC Model(s):**

LG-H955a

**Additional FCC Model(s):**

H955A, LGH955A, LG-H955a, H955a, LGH955a

**EUT Type:**

Cellular/PCS GSM/GPRS/EDGE/WCDMA/HSDPA/HSUPA/LTE Phone with Bluetooth, WLAN, NFC

**FCC Classification:**

Licensed Portable Transmitter Held to Ear (PCE)

**FCC Rule Part(s):**

§2 , §27

Mode (MHz)	Tx Frequency (MHz)	Emission Designator	Modulation	ERP	
				Max. Power (W)	Max. Power (dBm)
LTE – Band17 (5)	706.5 – 713.5	4M51G7D	QPSK	0.026	14.22
		4M50W7D	16QAM	0.028	14.42
8M98G7D		QPSK	0.024	13.89	
8M95W7D		16QAM	0.026	14.09	
LTE – Band17 (10)					

The measurements shown in this report were made in accordance with the procedures specified in §2.947. I assume full responsibility for the accuracy and completeness of these measurements, and for the qualifications of all persons taking them.

HCT CO., LTD. Certifies that no party to this application has subject to a denial of Federal benefits that includes FCC benefits pursuant to section 5301 of the Anti-Drug Abuse Act of 1998, 21 U.S.C. 853(a)

**Report prepared by**  
: Kwon Jeong**Test engineer of RF Team****Approved by**  
: Kyoung Houn Seo**Manager of RF Team**

This report only responds to the tested sample and may not be reproduced, except in full, without written approval of the HCT Co., Ltd.

## Version

TEST REPORT NO.	DATE	DESCRIPTION
HCT-R-1501-F025	January 19, 2015	- First Approval Report

# Table of Contents

1. GENERAL INFORMATION .....	4
2. INTRODUCTION .....	5
2.1. EUT DESCRIPTION.....	5
2.2. MEASURING INSTRUMENT CALIBRATION.....	5
2.3. TEST FACILITY .....	5
3. DESCRIPTION OF TESTS .....	6
3.1 ERP/EIRP RADIATED POWER AND RADIATED SPURIOUS EMISSIONS.....	6
3.2 OCCUPIED BANDWIDTH. ....	8
3.3 BLOCK B FREQUENCY RANGE (704 – 710 and 734 – 740 MHz, 777 – 792 MHz) .....	9
3.4 SPURIOUS AND HARMONIC EMISSIONS AT ANTENNA TERMINAL.....	9
3.5 FREQUENCY STABILITY / VARIATION OF AMBIENT TEMPERATURE .....	10
4. LIST OF TEST EQUIPMENT .....	11
5. SUMMARY OF TEST RESULTS .....	12
6. SAMPLE CALCULATION .....	13
7. TEST DATA .....	14
7.1 EFFECTIVE RADIATED POWER OUTPUT .....	14
7.2 RADIATED SPURIOUS EMISSIONS.....	16
7.2.1 RADIATED SPURIOUS EMISSIONS (5 MHz Band 17 LTE).....	16
7.2.2 RADIATED SPURIOUS EMISSIONS (10 MHz Band 17 LTE).....	17
7.3 OCCUPIED BANDWIDTH .....	18
7.4 CONDUCTED SPURIOUS EMISSIONS .....	18
7.4.1 BAND EDGE.....	18
7.5 FREQUENCY STABILITY / VARIATION OF AMBIENT TEMPERATURE .....	19
7.5.1 FREQUENCY STABILITY (5 MHz Band 17 LTE).....	19
7.5.2 FREQUENCY STABILITY (10 MHz Band 17 LTE).....	20
8. TEST PLOTS.....	21

# MEASUREMENT REPORT

## 1. GENERAL INFORMATION

**Applicant Name:** LG Electronics MobileComm U.S.A., Inc.

**Address:** 1000 Sylvan Avenue, Englewood Cliffs NJ 07632

**FCC ID:** ZNFH955A

**Application Type:** Certification

**FCC Classification:** Licensed Portable Transmitter Held to Ear (PCE)

**FCC Rule Part(s):** §2 , §27

**EUT Type:** Cellular/PCS GSM/GPRS/EDGE/WCDMA/HSDPA/HSUPA/LTE Phone with Bluetooth, WLAN, NFC

**FCC Model(s):** LG-H955a

**Additional FCC Model(s):** H955A, LGH955A, LG-H955a, H955a, LGH955a

**Tx Frequency:** 706.5 MHz – 713.5 MHz (LTE – Band 17)

**Max. RF Output Power:**

Band 17 ( 5 MHz) :	0.026 W (QPSK) (14.22 dBm)
	0.028 W (16-QAM) (14.42 dBm)
Band 17 (10 MHz) :	0.024 W (QPSK) (13.89 dBm)
	0.026 W (16-QAM) (14.09 dBm)

**Emission Designator(s):**

Band 17 ( 5 MHz) :	4M51G7D (QPSK) / 4M50W7D (16-QAM)
Band 17 (10 MHz) :	8M98G7D (QPSK) / 8M95W7D (16-QAM)

**Date(s) of Tests:** December 11, 2014 ~ January 07, 2015

**Antenna Specification**

Manufacturer: AT & C Co., Ltd.

Antenna type: Internal Antenna

Peak Gain: Band 17: -5.99 dBi

## **2. INTRODUCTION**

### **2.1. EUT DESCRIPTION**

The LG Electronics MobileComm U.S.A., Inc. LG-H955a Cellular/PCS GSM/GPRS/EDGE/WCDMA/HSDPA/HSUPA/LTE Phone with Bluetooth, WLAN, NFC consists of LTE 17.

### **2.2. MEASURING INSTRUMENT CALIBRATION**

The measuring equipment, which was utilized in performing the tests documented herein, has been calibrated in accordance with the manufacturer's recommendations for utilizing calibration equipment, which is traceable to recognized national standards.

### **2.3. TEST FACILITY**

The Fully-anechoic chamber and conducted measurement facility used to collect the radiated data are located at the **74, Seoicheon-ro 578beon-gil, Majang-myeon, Icheon-si, Gyeonggi-do, Korea.**

## **3. DESCRIPTION OF TESTS**

### **3.1 ERP/EIRP RADIATED POWER AND RADIATED SPURIOUS EMISSIONS**

Note: ERP(Effective Radiated Power), EIRP(Effective Isotropic Radiated Power)

#### Test Procedure

Radiated emission measurements are performed in the Fully-anechoic chamber. The equipment under test is placed on a non-conductive table 3-meters away from the receive antenna in accordance with ANSI/TIA-603-C-2004 Clause 2.2.17. The turntable is rotated through 360 degrees, and the receiving antenna scans in order to determine the level of the maximized emission. The level and position of the maximized emission is recorded with the spectrum analyzer using a positive peak detector.

A half wave dipole is then substituted in place of the EUT. For emissions above 1GHz, a horn antenna is substituted in place of the EUT. The substitute antenna is driven by a signal generator and the previously recorded signal was duplicated.

The power is calculated by the following formula;

$$P_{d(dBm)} = P_{g(dBm)} - \text{cable loss}_{(dB)} + \text{antenna gain}_{(dB)}$$

Where:  $P_d$  is the dipole equivalent power and  $P_g$  is the generator output power into the substitution antenna.

The maximum EIRP is calculated by adding the forward power to the calibrated source plus its appropriate gain value. These steps are repeated with the receiving antenna in both vertical and horizontal polarization. the difference between the gain of the horn and an isotropic antenna are taken into consideration

#### **Radiated spurious emissions**

: Frequency Range : 30 MHz ~ 10<sup>th</sup> Harmonics of highest channel fundamental frequency.

#### **5.1.1 Peak power measurements with a spectrum/signal analyzer or EMI receiver**

The following procedure can be used to determine the total peak output power.

- a) Set the RBW  $\geq$  OBW.
- b) Set VBW  $\geq$  3  $\times$  RBW.
- c) Set span  $\geq$  2  $\times$  RBW
- d) Sweep time = auto couple.
- e) Detector = peak.
- f) Ensure that the number of measurement points  $\geq$  span/RBW.
- g) Trace mode = max hold.
- h) Allow trace to fully stabilize.
- i) Use the peak marker function to determine the peak amplitude level.

### **5.2.2 Procedures for use with a spectrum/signal analyzer when EUT cannot be configured to transmit continuously and sweep triggering/signal gating cannot be properly implemented**

If the EUT cannot be configured to transmit continuously (burst duty cycle < 98%), then one of the following procedures can be used. The selection of the applicable procedure will depend on the characteristics of the measured burst duty cycle.

Measure the burst duty cycle with a spectrum/signal analyzer or EMC receiver can be used in zero-span mode if the response time and spacing between bins on the sweep are sufficient to permit accurate measurement of the burst on/off time of the transmitted signal.

#### **5.2.2.2 Constant burst duty cycle**

If the measured burst duty cycle is constant (i.e., duty cycle variations are less than  $\pm 2$  percent), then:

- a) Set span to at least 1.5 times the OBW.
- b) Set RBW = 1-5% of the OBW, not to exceed 1 MHz.
- c) Set VBW  $\geq 3 \times$  RBW.
- d) Number of points in sweep  $\geq 2 \times$  span / RBW. (This gives bin-to-bin spacing  $\leq$  RBW/2, so that narrowband signals are not lost between frequency bins.)
- e) Sweep time = auto.
- f) Detector = RMS (power averaging).
- g) Set sweep trigger to "free run".
- h) Trace average at least 100 traces in power averaging (i.e., RMS) mode.
- i) Compute power by integrating the spectrum across the OBW of the signal using the instrument's band power measurement function with band limits set equal to the OBW band edges. If the instrument does not have a band power function, sum the spectrum levels (in power units) at intervals equal to the RBW extending across the entire OBW of the spectrum.
- j) Add  $10 \log (1/x)$ , where  $x$  is the duty cycle, to the measured power in order to compute the average power during the actual transmission times (because the measurement represents an average over both the on and off times of the transmission).

For example, add  $10 \log (1/0.25) = 6$  dB if the duty cycle is a constant 25%.

### 3.2 OCCUPIED BANDWIDTH.

#### Test set-up

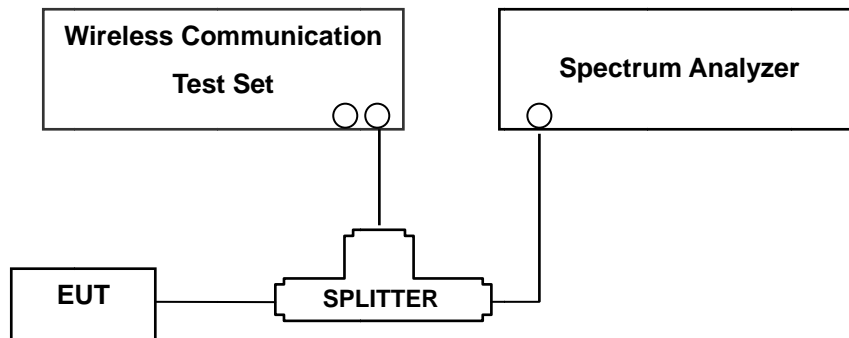

(Configuration of conducted Emission measurement)

The width of a frequency band such that, below the lower and above the upper frequency limits, the mean powers emitted are each equal to a specified percentage 0.5 % of the total mean power of a given emission.

#### Test Procedure

OBW is tested in accordance with KDB971168 D01 Power Meas License Digital Systems v02r02, October 17, 2014, Section 4.2.

The EUT makes a call to the communication simulator. The power was measured with R&S Spectrum Analyzer. All measurements were done at 3 channels(low, middle and high operational range.)

The conducted occupied bandwidth used the power splitter via EUT RF power connector between simulation base station and spectrum analyzer.

The communication simulator station system controlled a EUT to export maximum output power under transmission mode and specific channel frequency. Use OBW measurement function of Spectrum analyzer to measure 99 % occupied bandwidth



### 3.3 BLOCK B FREQUENCY RANGE (704 – 710 and 734 – 740 MHz, 777 – 792 MHz)

§27.5(c)

698-746 MHz Band. The following frequencies are available for licensing pursuant to this part in the 698–746 MHz band: (1) Three paired channel blocks of 12 MHz each are available for assignment as follows :

Block A : 698 – 704 MHz and 728 – 734 MHz ;

Block B : 704 – 710 MHz and 734 – 740 MHz ; and

Block C : 710 – 716 MHz and 740 – 746 MHz.

The EUT is only being authorized for operation in Blocks B and C.

### 3.4 SPURIOUS AND HARMONIC EMISSIONS AT ANTENNA TERMINAL.

#### Test Procedure

Spurious and harmonic emissions at antenna terminal is tested in accordance with KDB971168 D01 Power Meas License Digital Systems v02r02, October 17, 2014, Section 6.0.

The level of the carrier and the various conducted spurious and harmonic frequencies is measured by means of a calibrated spectrum analyzer.

The spectrum is scanned from the lowest frequency generated in the equipment up to a frequency including its 10th harmonic. On any frequency outside a licensee's frequency block, the power of any emission shall be attenuated below the transmitter power (P) by at least  $43 + 10 \log(P)$  dB. Compliance with these provisions is based on the use of measurement instrumentation employing a resolution bandwidth of 1 MHz or greater. However, in the 100 kHz bands immediately outside and adjacent to the frequency block a resolution bandwidth of at least 30 kHz bandwidth may be employed. The emission bandwidth is defined as the width of the signal between two points, one below the carrier center frequency and one above the carrier center frequency

**NOTES:** The analyzer plot offsets were determined by below conditions.

- For LTE Band 17, total offset 26.5 dB = 20 dB attenuator + 6 dB Divider + 0.5 dB RF cables.

### 3.5 FREQUENCY STABILITY / VARIATION OF AMBIENT TEMPERATURE

#### Test Set-up

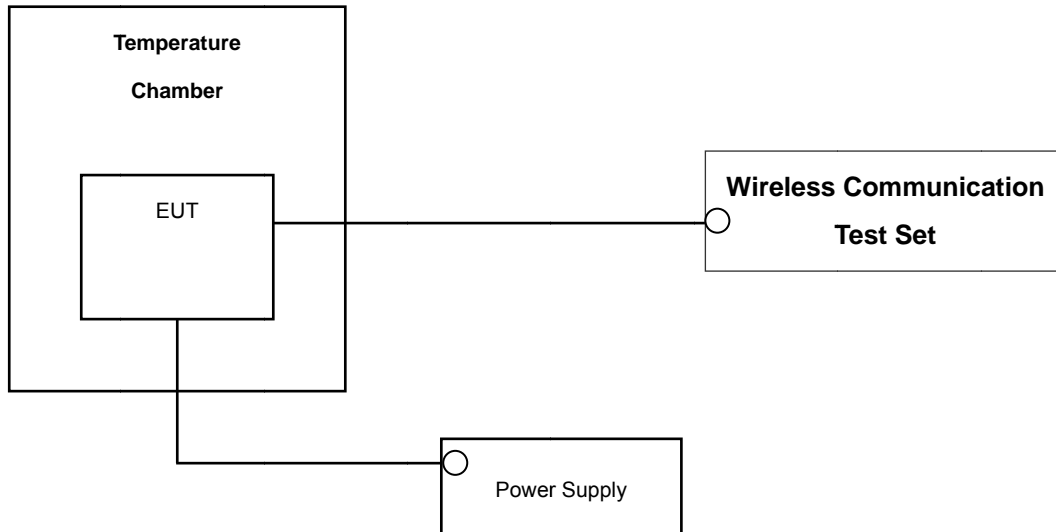

\* Nominal Operating Voltage

#### Test Procedure

Frequency stability is tested in accordance with ANSI/TIA-603-C-2004 section 2.2.2

The frequency stability of the transmitter is measured by:

- a.) **Temperature:** The temperature is varied from - 30 °C to + 50 °C using an environmental chamber.
- b.) **Primary Supply Voltage:** The primary supply voltage is varied from the end point to 115 % of the voltage normally at the input to the device or at the power supply terminals if cables are not normally supplied.

Specification — the frequency stability shall be sufficient to ensure that the fundamental emission stays within the authorized frequency block

#### Time Period and Procedure:

The carrier frequency of the transmitter is measured at room temperature (20°C to provide a reference).

1. The equipment is turned on in a “standby” condition for one minute before applying power to the transmitter. Measurement of the carrier frequency of the transmitter is made within one minute after applying power to the transmitter.
2. Frequency measurements are made at 10°C intervals ranging from -30°C to +50°C. A period of at least one half-hour is provided to allow stabilization of the equipment at each temperature level.

## 4. LIST OF TEST EQUIPMENT

Manufacture	Model/ Equipment	Serial Number	Calibration Interval	Calibration Due
Agilent	N1921A/ Power Sensor	MY45241059	Annual	07/09/2015
Agilent	N1911A/ Power Meter	MY45100523	Annual	01/24/2015
MITEQ	AMF-6D-001180-35-20P/AMP	1081666	Annual	09/04/2015
Wainwright	WHK1.2/15G-10EF/H.P.F	4	Annual	06/17/2015
Wainwright	WRCJV2400/2483.5-2370/2520-60/12SS / B.R.F.	1	Annual	06/17/2015
Wainwright	WHK3.3/18G-10EF/H.P.F	2	Annual	06/17/2015
Hewlett Packard	11667B / Power Splitter	10545	Annual	02/22/2015
Hewlett Packard	11667B / Power Splitter	11275	Annual	05/19/2015
Digital	EP-3010/ Power Supply	3110117	Annual	10/29/2015
Schwarzbeck	UHAP/ Dipole Antenna	557	Biennial	03/05/2015
Schwarzbeck	UHAP/ Dipole Antenna	558	Biennial	05/03/2015
Korea Engineering	KR-1005L / Chamber	KRAC05063-3CH	Annual	10/29/2015
Schwarzbeck	BBHA 9120D/ Horn Antenna	147	Biennial	09/01/2016
Schwarzbeck	BBHA 9120D/ Horn Antenna	1151	Biennial	10/05/2015
Schwarzbeck	BBHA 9170/ Horn Antenna(15~40GHz)	BBHA9170541	Biennial	07/05/2015
Agilent	E4440A/Spectrum Analyzer	US45303008	Annual	04/09/2015
WEINSCHL	ATTENUATOR	BR0592	Annual	10/22/2015
REOHDE&SCHWARZ	FSV40/Spectrum Analyzer	1307.9002K40-100931-NK	Annual	06/09/2015
Agilent	8960 (E5515C)/ Base Station	MY48360222	Annual	08/26/2015
Anritsu Corp.	MT8820C/Wideband Radio Communication Tester	6200863156	Annual	04/01/2015

## 5. SUMMARY OF TEST RESULTS

FCC Part Section(s)	Test Description	Test Limit	Test Condition	Test Result
2.1049	Occupied Bandwidth	N/A	CONDUCTED	PASS
2.1051, 27.53(g)	Band Edge / Spurious and Harmonic Emissions at Antenna Terminal.	$< 43 + 10 \log_{10}(P[\text{Watts}])$ at Band Edge and for all-of-band emissions		PASS
*2.1046	Conducted Output Power	N/A		PASS
2.1055, 27.54	Frequency stability / variation of ambient temperature	Emission must remain in band		PASS
27.50(c)(10)	Effective Radiated Power (Band 17)	$< 3$ Watts max. ERP	RADIATED	PASS
2.1053, 27.53(g)	Undesirable Out-of-Band Emissions	$< 43 + 10 \log_{10}(P[\text{Watts}])$ for all out-of-band emissions		PASS

\*: See SAR Report

## 6. SAMPLE CALCULATION

### A. ERP Sample Calculation

Mode	Ch./ Freq.		Measured Level(dBm)	Substitute LEVEL(dBm)	Ant. Gain (dBd)	C.L	Pol.	ERP	
	channel	Freq.(MHz)						W	dBm
LTE	23755	706.5	-28.75	29.60	-10.21	0.76	V	0.073	18.63

**ERP = SubstituteLEVEL(dBm) + Ant. Gain – CL(Cable Loss)**

- 1) The EUT mounted on a wooden tripod is 2.5 meter above test site ground level.
- 2) During the test , the turn table is rotated and the antenna height is found.
- 3) Record the field strength meter's level.
- 4) Replace the EUT with dipole/Horn antenna that is connected to a calibrated signal generator.
- 5) Increase the signal generator output till the field strength meter's level is equal to the item (3).
- 6) The signal generator output level with Ant. Gain and cable loss are the rating of effective radiated power (ERP).

## B. Emission Designator

### QPSK Modulation

**Emission Designator = 4M48G7D**

LTE BW = 4.48 MHz

G = Phase Modulation

7 = Quantized/Digital Info

D = Data transmission; telemetry; telecommand

### 16QAM Modulation

**Emission Designator = 4M48W7D**

LTE BW = 4.48 MHz

W = main carrier modulated in a combination of two

or more of the following modes;

amplitude, angle, pulse

7 = Quantized/Digital Info

D = Data transmission; telemetry; telecommand

## 7. TEST DATA

### 7.1 EFFECTIVE RADIATED POWER OUTPUT

Freq (MHz)	Bandwidth	Modulation	Measured Level (dBm)	Substitute Level (dBm)	Ant. Gain(dBd)	C.L	Pol	ERP	
								W	dBm
706.5	5 MHz	QPSK	-35.74	25.29	-10.21	1.08	V	0.025	14.00
		16-QAM	-35.75	25.28	-10.21	1.08	V	0.025	13.99
710.0		QPSK	-35.14	25.53	-10.22	1.09	V	0.026	14.22
		16-QAM	-34.94	25.73	-10.22	1.09	V	0.028	14.42
713.5		QPSK	-35.62	25.23	-10.24	1.08	V	0.025	13.91
		16-QAM	-35.76	25.09	-10.24	1.08	V	0.024	13.77

Effective Radiated Power Data (5 MHz Band 17 LTE)

Note: Worst case is 1 resource block

Freq (MHz)	Bandwidth	Modulation	Measured Level (dBm)	Substitute Level (dBm)	Ant. Gain(dBd)	C.L	Pol	ERP	
								W	dBm
709.0	10 MHz	QPSK	-35.72	25.20	-10.22	1.09	V	0.024	13.89
		16-QAM	-35.52	25.40	-10.22	1.09	V	0.026	14.09
710.0		QPSK	-35.66	25.01	-10.22	1.09	V	0.023	13.70
		16-QAM	-35.65	25.02	-10.22	1.09	V	0.023	13.71
711.0		QPSK	-35.71	24.88	-10.23	1.08	V	0.023	13.57
		16-QAM	-35.71	24.88	-10.23	1.08	V	0.023	13.57

Effective Radiated Power Data (10 MHz Band 17 LTE)

Note: Worst case is 1 resource block.

**NOTES:**Effective Radiated Power Output Measurements by Substitution Methodaccording to ANSI/TIA/EIA-603-C-2004, Aug. 17, 2004:

The EUT was placed on a non-conductive styrofoam resin table 3-meters from the receive antenna. The receive antenna height and turntable rotation was adjusted for the highest reading on the receive spectrum analyzer.

A half-wave dipole was substituted in place of the EUT. This dipole antenna was driven by a signal generator and the level of the signal generator was adjusted to obtain the same receive spectrum analyzer reading. The conducted power at the terminals of the dipole is measured. The ERP is recorded.

Also, we have done x, y, z planes in EUT and horizontal and vertical polarization in detecting antenna. The worst case of the EUT is y plane in LTE mode. Also worst case of detecting Antenna is vertical polarization in LTE mode.

## 7.2 RADIATED SPURIOUS EMISSIONS

### 7.2.1 RADIATED SPURIOUS EMISSIONS (5 MHz Band 17 LTE)

OPERATING FREQUENCY : 710.0 MHz  
 MEASURED OUTPUT POWER: 14.42 dBm = 0.028 W  
 MODULATION SIGNAL: 5 MHz 16-QAM  
 DISTANCE: 3 meters  
 LIMIT:  $43 + 10 \log_{10}(W) =$  27.42 dBc

Ch	Freq (MHz)	Measured Level (dBm)	Ant. Gain (dBd)	Substitute Level (dBm)	C.L	Pol	ERP (dBm)	dBc
23755 (706.50)	1,413.0	-54.48	7.80	-58.17	1.58	V	-51.95	66.37
	2,119.5	-56.41	9.55	-59.83	1.99	V	-52.27	66.69
	2,826.0	-57.34	10.84	-59.96	2.31	V	-51.43	65.85
23790 (710.00)	1,420.0	-55.54	7.86	-59.87	1.59	V	-53.60	68.02
	2,130.0	-56.63	9.49	-59.79	1.99	V	-52.29	66.71
	2,840.0	-58.53	10.90	-61.04	2.30	V	-52.44	66.86
23825 (713.50)	1,427.0	-53.68	7.90	-57.23	1.60	H	-50.93	65.35
	2,140.5	-57.08	9.42	-60.02	1.98	V	-52.58	67.00
	2,854.0	-57.69	10.94	-60.40	2.31	V	-51.77	66.19

- NOTES:**
1. Radiated Spurious Emission Measurements at 3 meters by Substitution Method according to ANSI/TIA/EIA-603-C-2004, Aug. 17, 2004:
  2. We are performed all frequency to 10<sup>th</sup> harmonics from 30 MHz. Measurements above show only up to 3 maximum emissions noted, or would be lesser if no specific emissions from the EUT are recorded (ie: margin > 20 dB from the applicable limit) and considered that's already beyond the background noise floor.
  3. we have done x, y, z planes in EUT and horizontal and vertical polarization in detecting antenna.
  4. Worst case is 1 resource block.



**7.2.2 RADIATED SPURIOUS EMISSIONS (10 MHz Band 17 LTE)**

OPERATING FREQUENCY : 709.0 MHz  
 MEASURED OUTPUT POWER: 14.09 dBm = 0.026 W  
 MODULATION SIGNAL: 10 MHz 16-QAM  
 DISTANCE: 3 meters  
 LIMIT:  $43 + 10 \log_{10}(W) =$  27.09 dBc

Ch	Freq (MHz)	Measured Level (dBm)	Ant. Gain (dBd)	Substitute Level (dBm)	C.L	Pol	ERP (dBm)	dBc
23780 (709.00)	1,418.0	-58.81	7.84	-62.54	1.58	V	-56.28	70.37
	2,127.0	-56.72	9.55	-59.94	1.99	V	-52.38	66.47
	2,836.0	-58.31	10.88	-60.80	2.30	V	-52.22	66.31
23790 (710.00)	1,420.0	-59.03	7.86	-63.36	1.59	V	-57.09	71.18
	2,130.0	-57.26	9.49	-60.42	1.99	V	-52.92	67.01
	2,840.0	-58.23	10.90	-60.74	2.30	V	-52.14	66.23
23800 (711.00)	1,422.0	-57.36	7.86	-61.69	1.59	V	-55.42	69.51
	2,133.0	-57.86	9.49	-61.02	1.99	V	-53.52	67.61
	2,844.0	-58.01	10.90	-60.52	2.30	V	-51.92	66.01

- NOTES:**
1. Radiated Spurious Emission Measurements at 3 meters by Substitution Method according to ANSI/TIA/EIA-603-C-2004, Aug. 17, 2004:
  2. We are performed all frequency to 10<sup>th</sup> harmonics from 30 MHz. Measurements above show only up to 3 maximum emissions noted, or would be lesser if no specific emissions from the EUT are recorded (ie: margin > 20 dB from the applicable limit) and considered that's already beyond the background noise floor.
  3. we have done x, y, z planes in EUT and horizontal and vertical polarization in detecting antenna.
  4. Worst case is 1 resource block.

### 7.3 OCCUPIED BANDWIDTH

Band	Band Width (MHz)	Frequency (MHz)	Modulation	Resource Block Size	Resource Block Offset	Data ( MHz )
Band 17	5	710.0	QPSK	25	0	4.5068
			16-QAM	25	0	4.4993
	10		QPSK	50	0	8.9768
			16-QAM	50	0	8.9453

- Plots of the EUT's Occupied Bandwidth are shown Page 22 ~ 23.

### 7.4 CONDUCTED SPURIOUS EMISSIONS

Band	Band Width (MHz)	Frequency (MHz)	Modulation	Resource Block Size	Resource Block Offset	Frequency of Maximum Harmonic (GHz)	Maximum Data [dBm]
Band 17	5	706.5	QPSK	1	0	6.949750	-26.69
		710.0		1	0	6.997750	-26.92
		713.5		1	0	6.986250	-26.48
	10	709.0		1	0	6.965750	-26.15
		710.0		1	0	6.987750	-26.96
		711.0		1	0	6.991250	-25.39

- Plots of the EUT's Conducted Spurious Emissions are shown Page 30~ 35.

#### 7.4.1 BAND EDGE

- Plots of the EUT's Band Edge are shown Page 24 ~ 29

**7.5 FREQUENCY STABILITY / VARIATION OF AMBIENT TEMPERATURE**

**7.5.1 FREQUENCY STABILITY (5 MHz Band 17 LTE)**

OPERATING FREQUENCY: 710,000,000 Hz  
 CHANNEL: 23790 (5 MHz)  
 REFERENCE VOLTAGE: 3.8 VDC  
 DEVIATION LIMIT: -

Voltage (%)	Power (VDC)	Temp. ( )	Frequency (Hz)	Frequency Error (Hz)	Deviation (%)	ppm
100%	3.80	+20(Ref)	710 000 003	0	0.000 000	0.000
100%		-30	710 000 005	2.30	0.000 000	0.003
100%		-20	710 000 005	2.40	0.000 000	0.003
100%		-10	710 000 000	-2.80	0.000 000	-0.004
100%		0	710 000 005	1.80	0.000 000	0.003
100%		+10	710 000 007	3.80	0.000 001	0.005
100%		+30	710 000 008	4.70	0.000 001	0.007
100%		+40	710 000 005	2.40	0.000 000	0.003
100%		+50	710 000 007	3.70	0.000 001	0.005
115%		4.35	+20	709 999 999	-3.50	0.000 000
Batt. Endpoint	3.00	+20	710 000 000	-2.80	0.000 000	-0.004

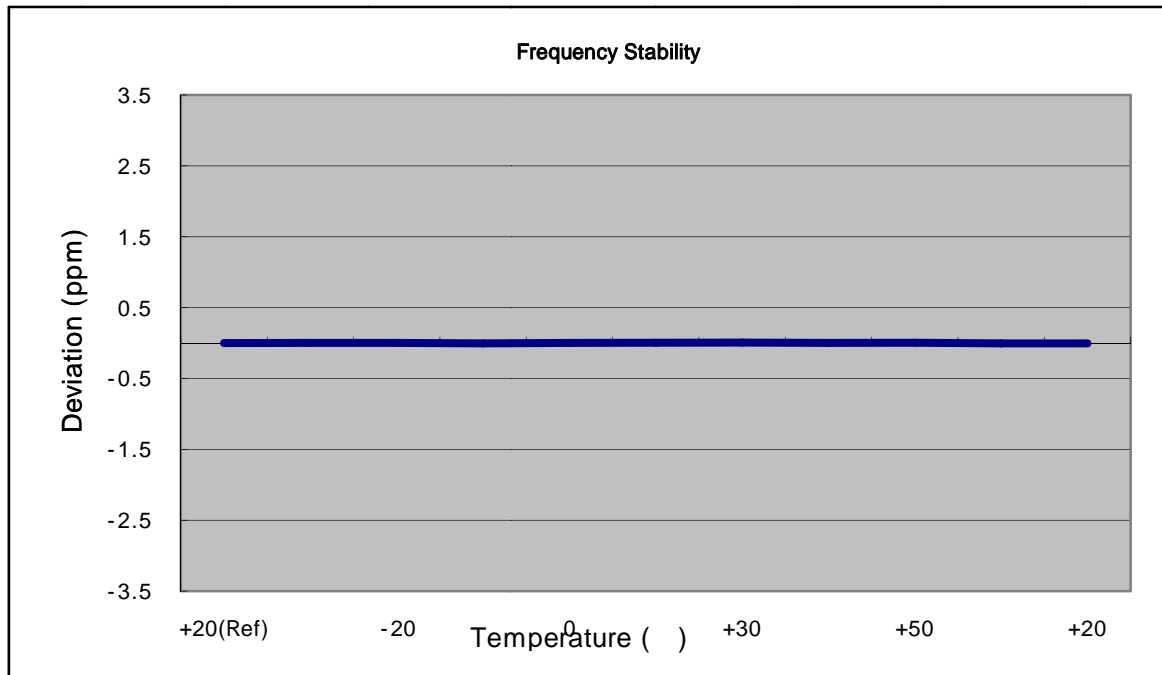

**7.5.2 FREQUENCY STABILITY (10 MHz Band 17 LTE)**

OPERATING FREQUENCY: 710,000,000 Hz  
 CHANNEL: 23790 (10 MHz)  
 REFERENCE VOLTAGE: 3.8 VDC  
 DEVIATION LIMIT: -

Voltage (%)	Power (VDC)	Temp. ( )	Frequency (Hz)	Frequency Error (Hz)	Deviation (%)	ppm
100%	3.80	+20(Ref)	709 999 998	0	0.000 000	0.000
100%		-30	709 999 999	1.00	0.000 000	0.001
100%		-20	710 000 000	2.10	0.000 000	0.003
100%		-10	710 000 000	2.60	0.000 000	0.004
100%		0	710 000 000	2.90	0.000 000	0.004
100%		+10	709 999 996	-1.50	0.000 000	-0.002
100%		+30	710 000 000	2.90	0.000 000	0.004
100%		+40	710 000 000	2.40	0.000 000	0.003
100%		+50	710 000 001	3.80	0.000 001	0.005
115%	4.35	+20	710 000 002	4.10	0.000 001	0.006
Batt. Endpoint	3.00	+20	710 000 001	3.00	0.000 000	0.004

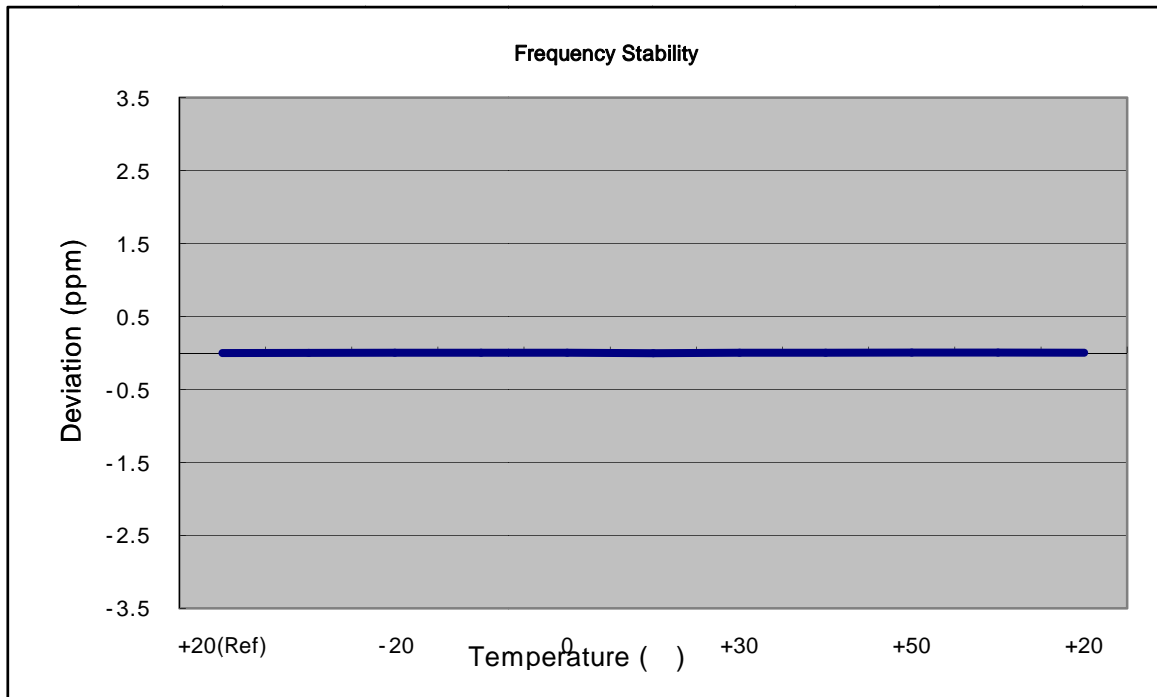

## **8. TEST PLOTS**

BAND17. Occupied Bandwidth Plot (5M BW Ch.23790 QPSK RB 25)

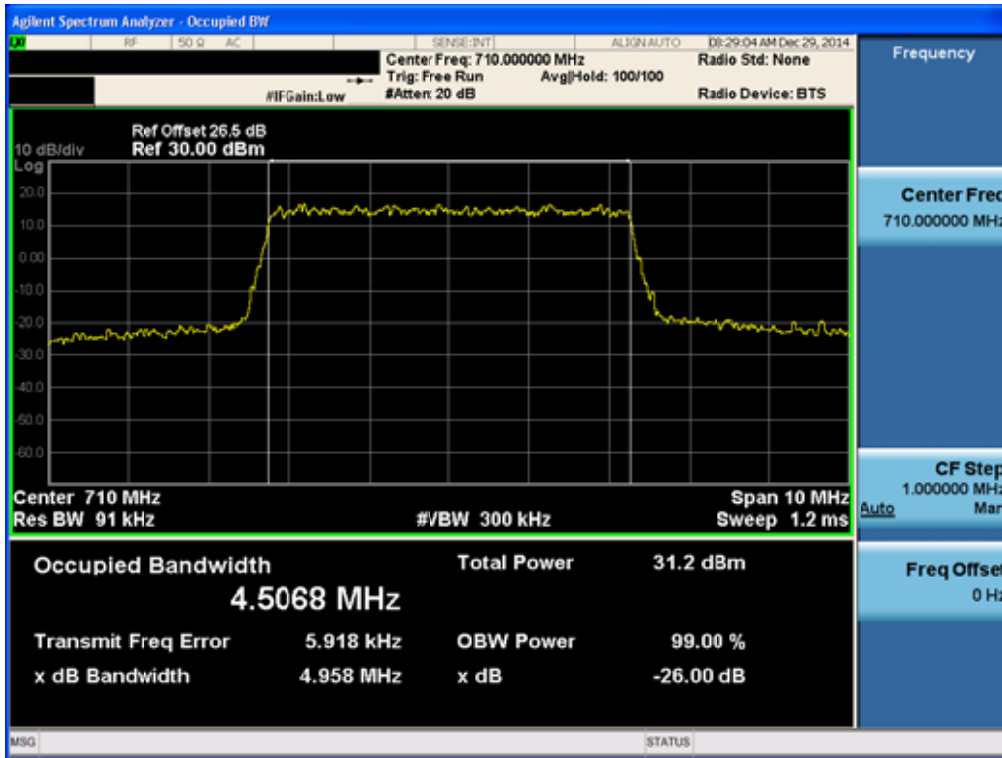

BAND17. Occupied Bandwidth Plot (5M BW Ch.23790 16QAM RB 25)

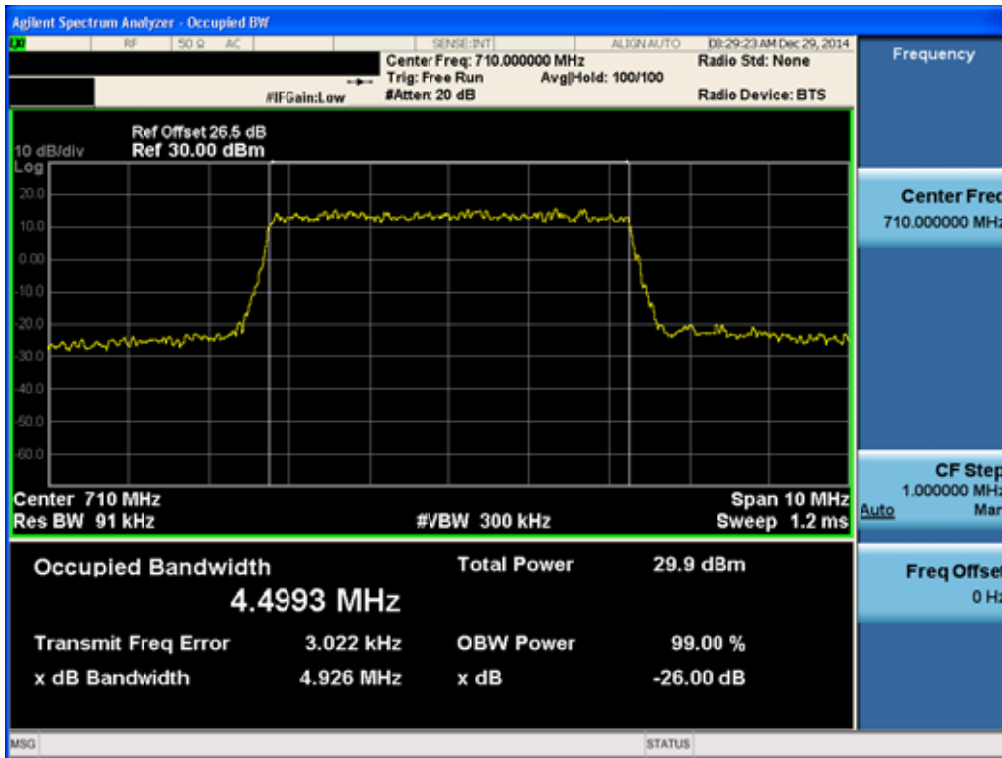

BAND17. Occupied Bandwidth Plot (10M BW Ch.23790 QPSK RB 50)

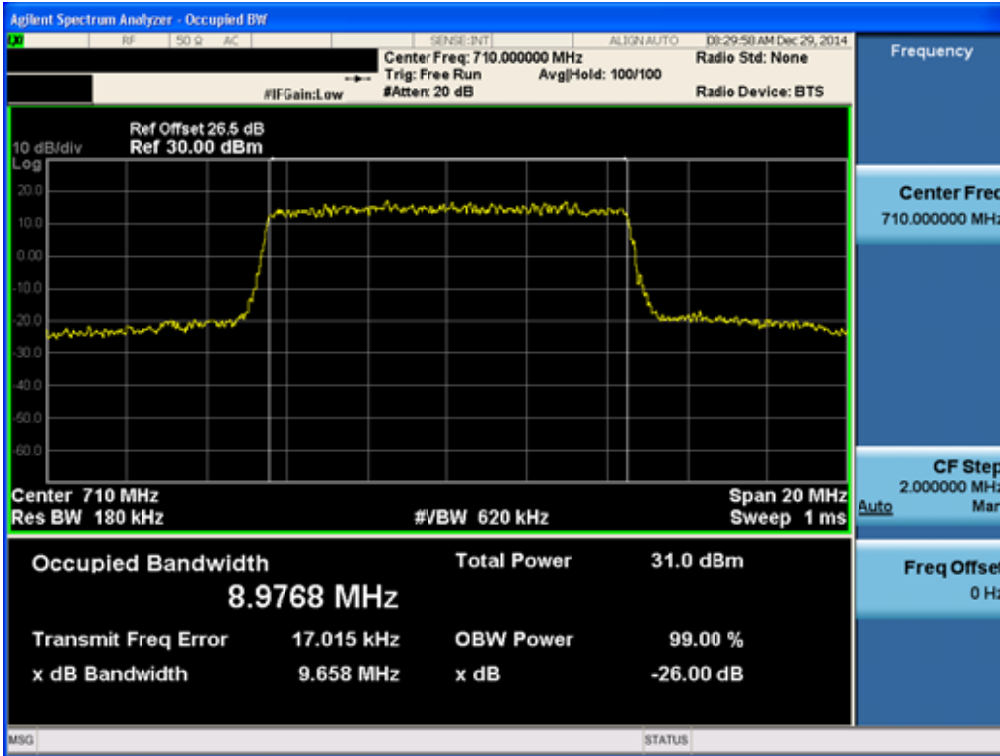

BAND17. Occupied Bandwidth Plot (10M BW Ch.23790 16QAMRB 50)

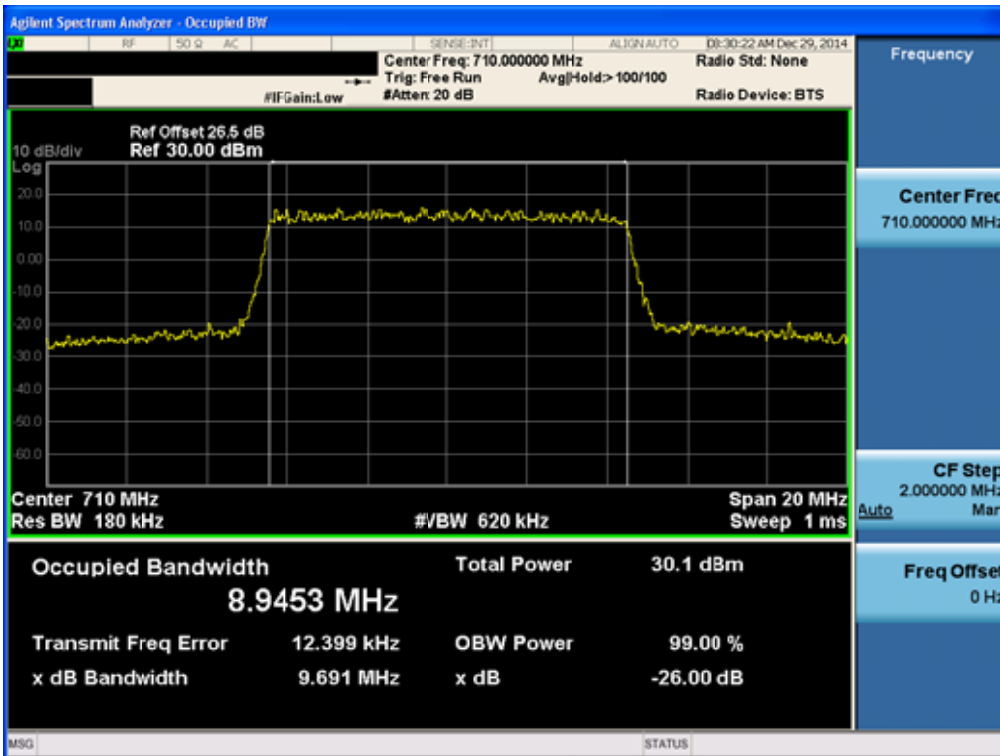

Band 17 Lower Band Edge Plot (5M BW Ch.23755 QPSK\_RB1 OFFSET0)

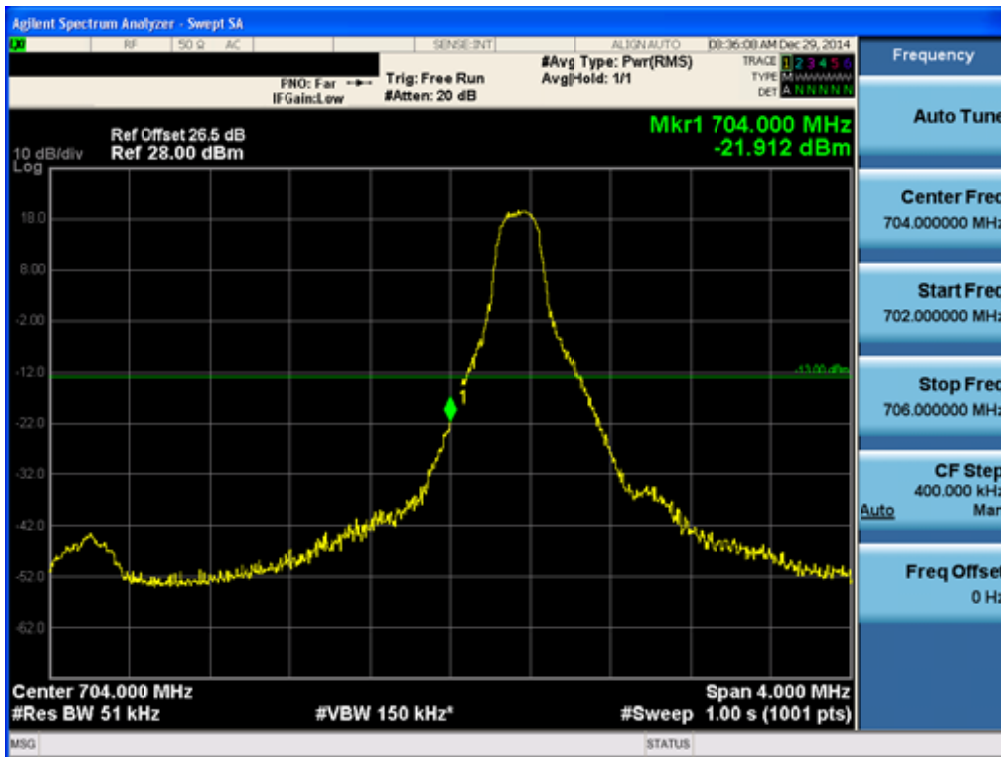

Band 17 Lower Band Edge Plot (5M BW Ch.23755 QPSK\_RB25)

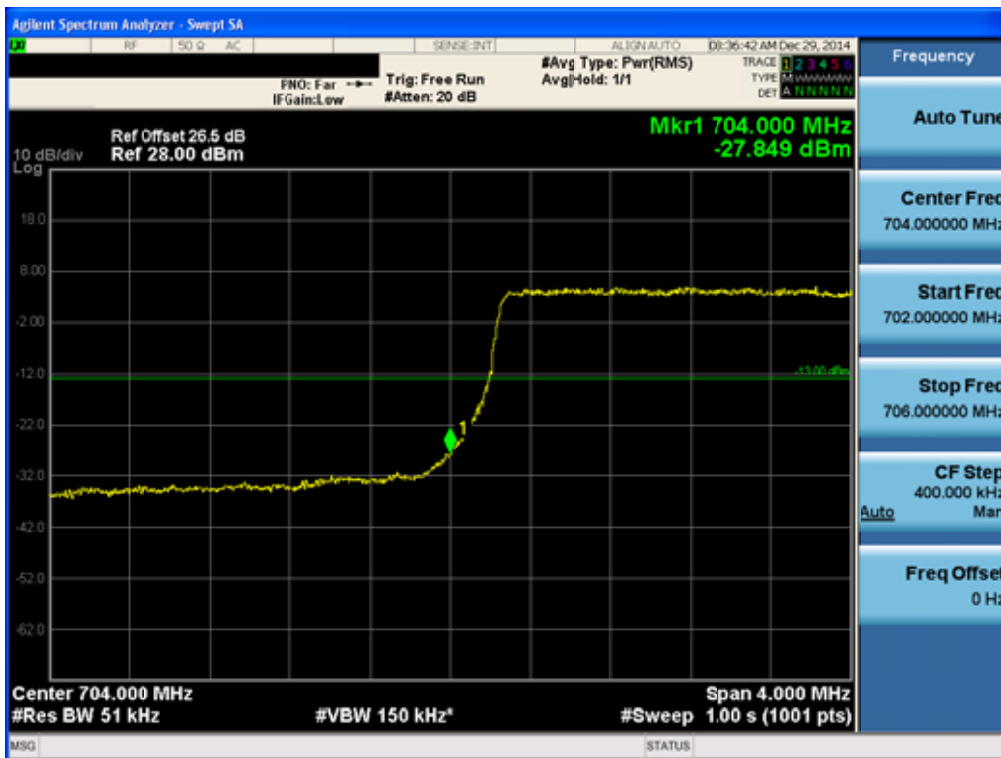



Band 17 Lower Extended Band Edge Plot (5M BW Ch.23755 QPSK\_RB25\_0)



Band 17 Lower Band Edge Plot (10M BW Ch.23780 QPSK\_RB1\_0)

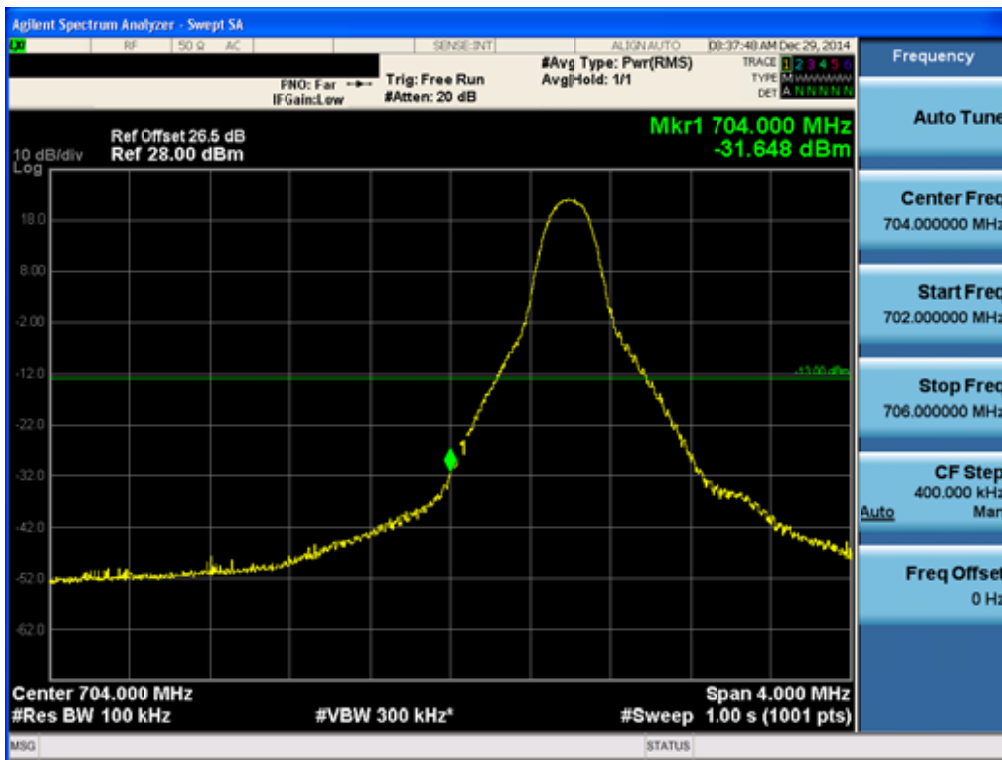

Band 17 Lower Band Edge Plot (10M BW Ch.23780 QPSK\_RB50\_0)

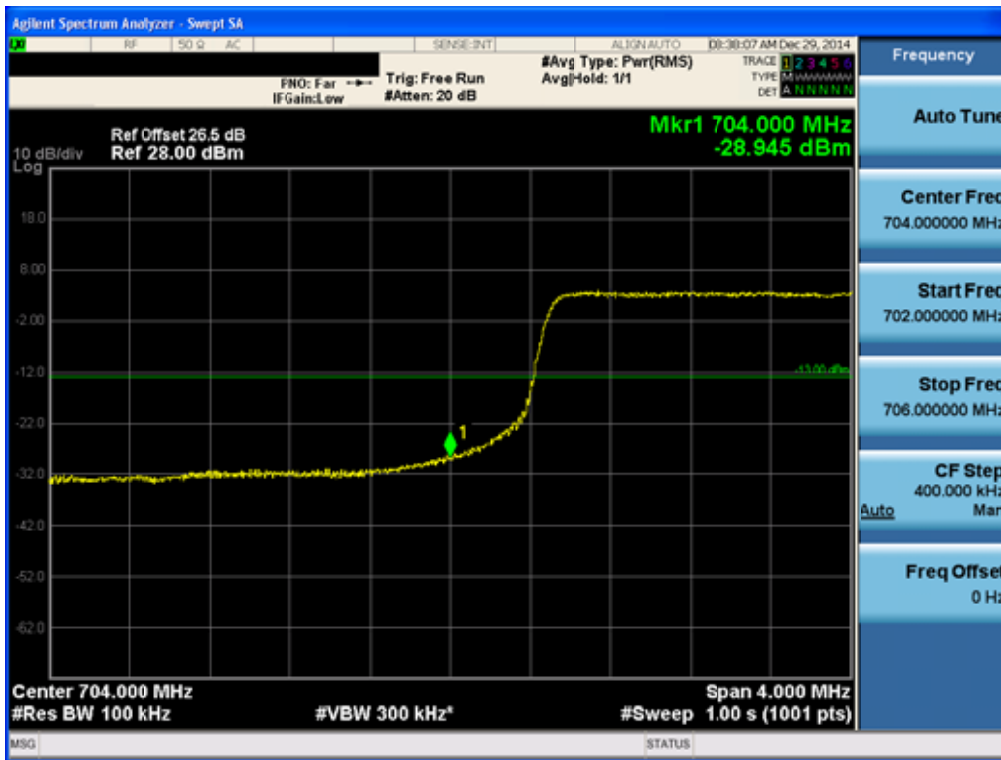

Band 17 Lower Extended Band Edge Plot (10M BW Ch.23780 QPSK\_RB50\_0)

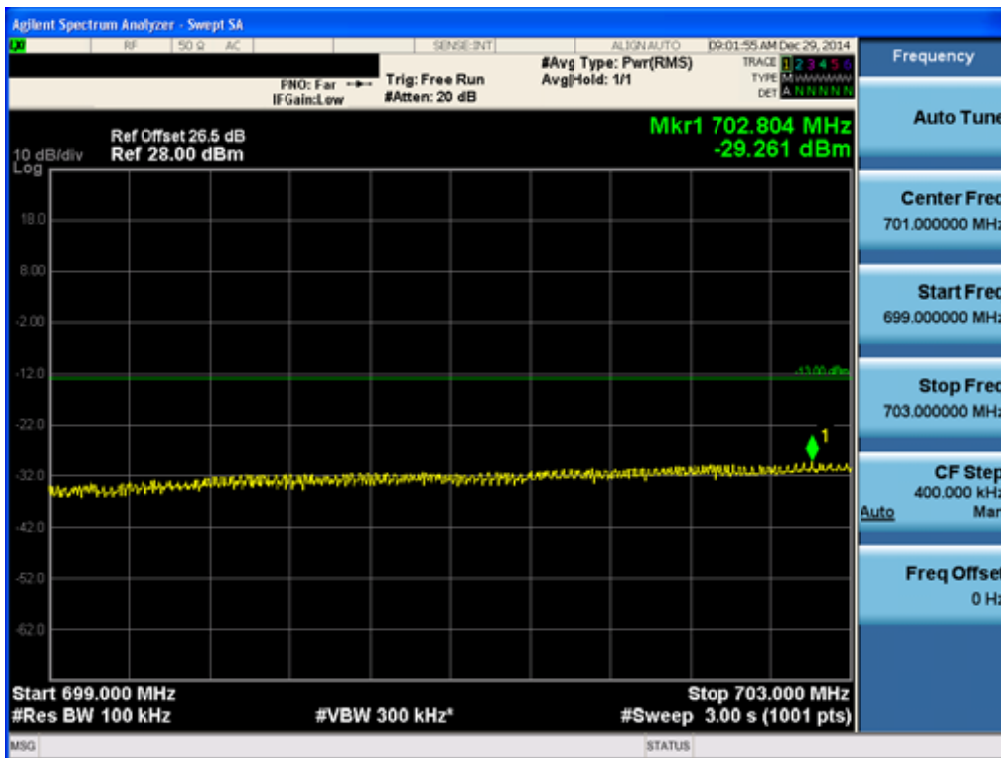

Band 17 Upper Band Edge Plot (5M BW Ch.23825 QPSK\_RB1\_Offset 24)

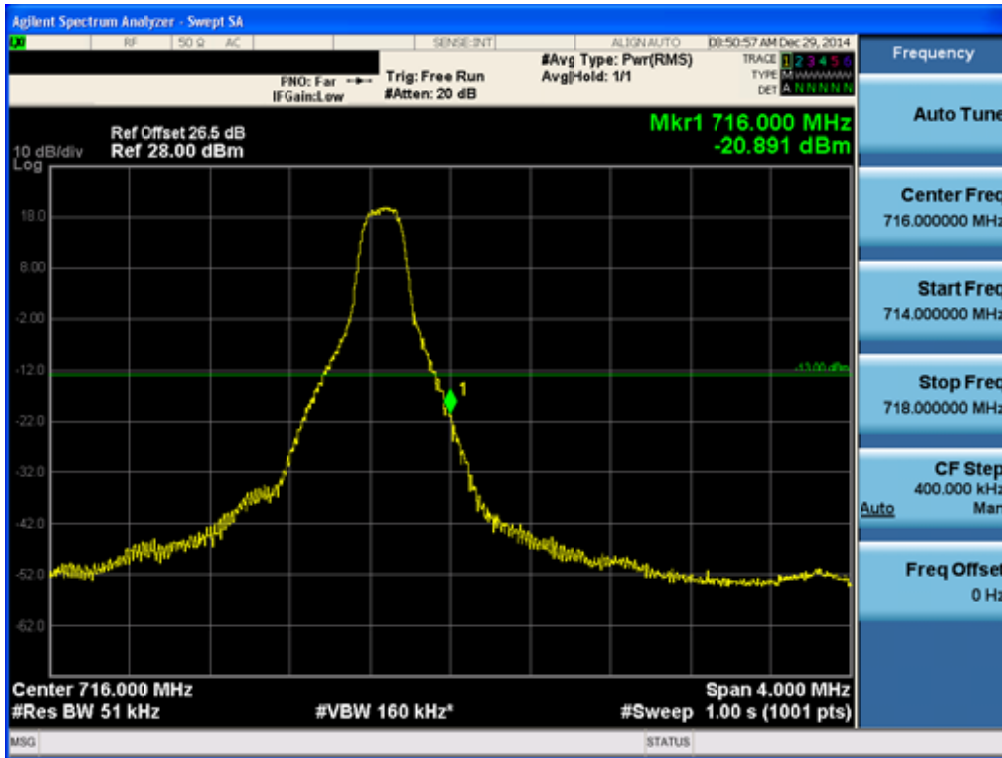

Band 17 Upper Band Edge Plot (5M BW Ch.23825 QPSK\_RB25)

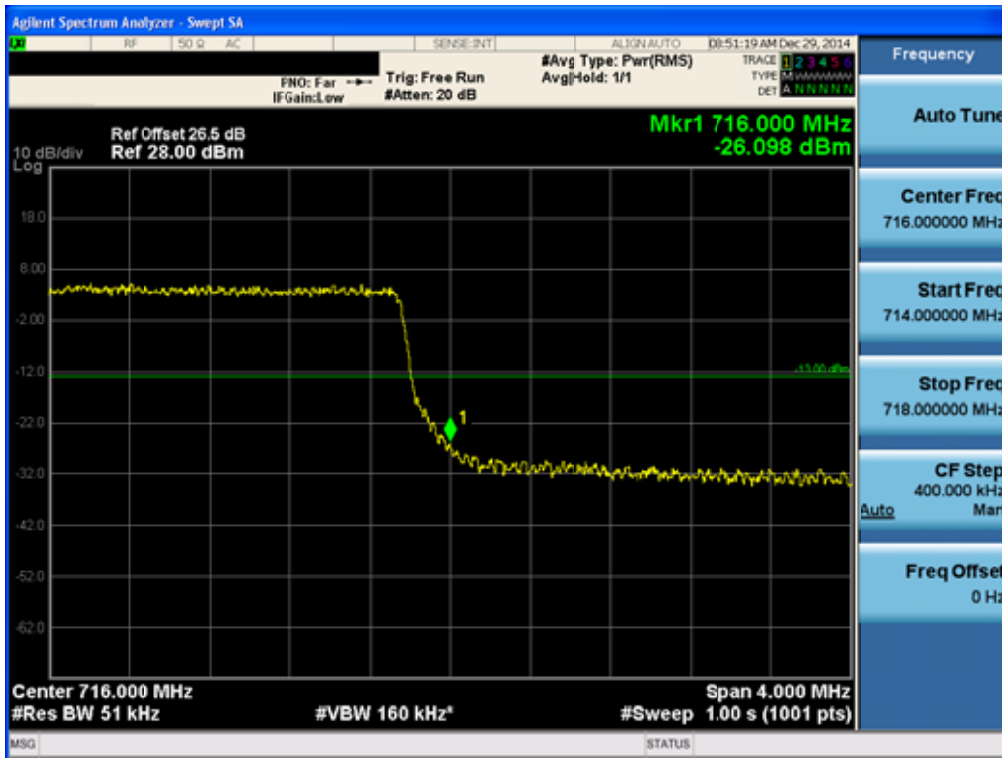

Band 17 Upper Extended Band Edge Plot (5M BW Ch.23825 QPSK\_RB25\_0)



Band 17 Upper Band Edge Plot (10M BW Ch.23800 QPSK\_RB1\_Offset 49)

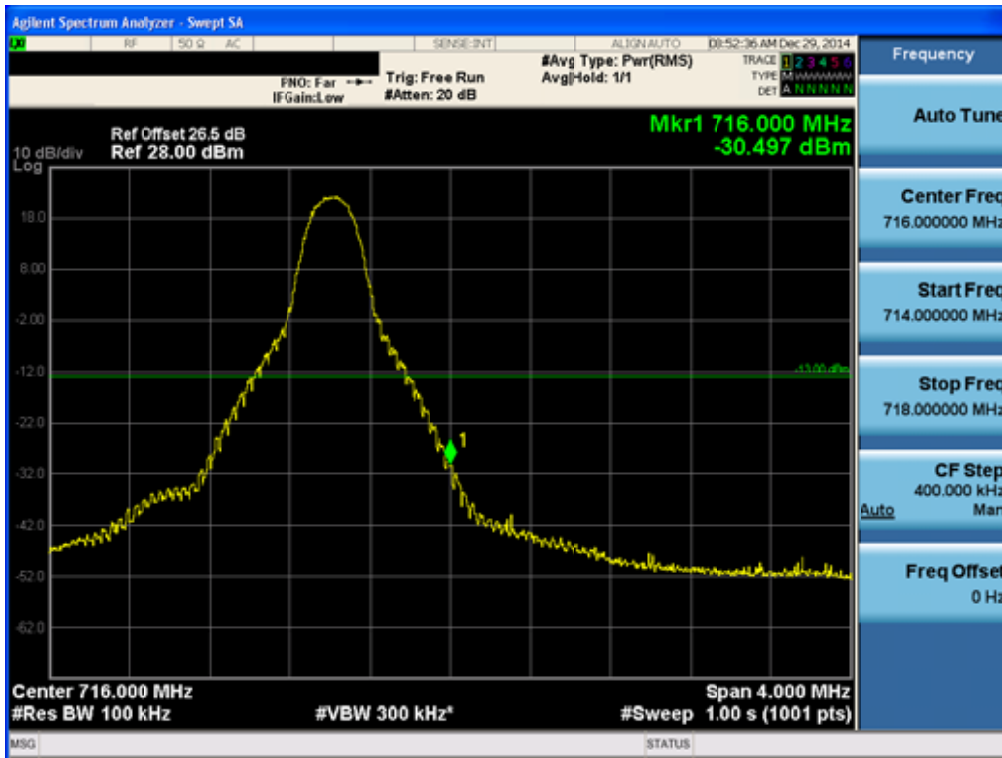

Band 17 Upper Band Edge Plot (10M BW Ch.23800 QPSK\_RB50)

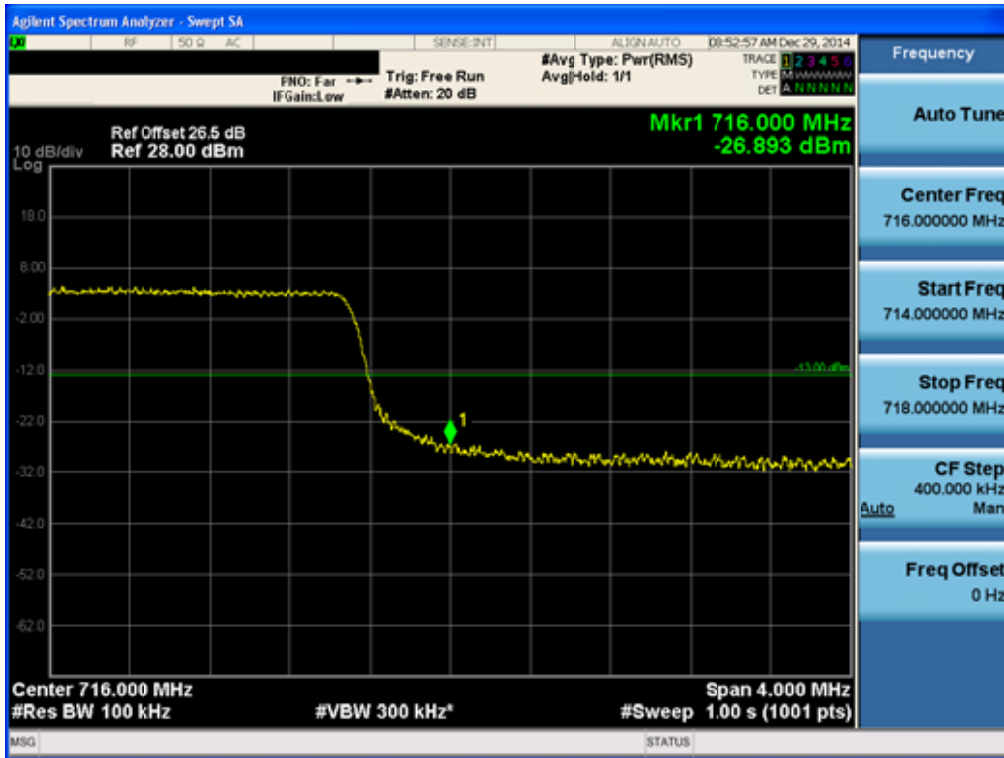

Band 17 Upper Extended Band Edge Plot (10M BW Ch.23800 QPSK\_RB50\_0)

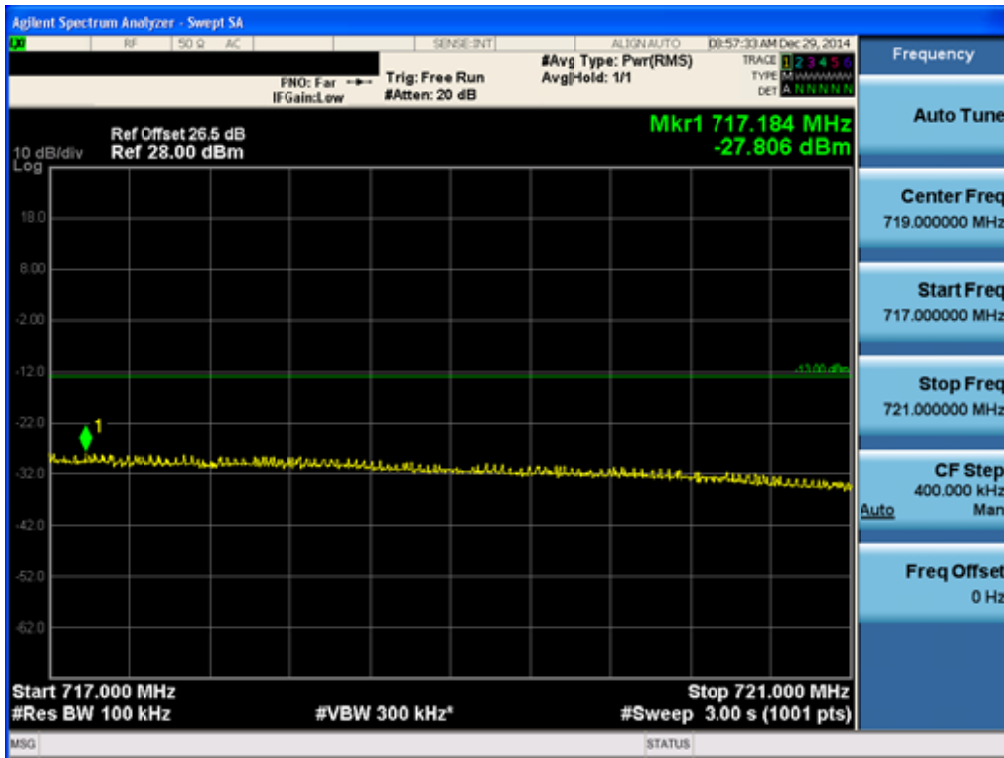

BAND17. Conducted Spurious Plot\_1 (23755ch\_5MHz\_QPSK\_RB 1\_0)

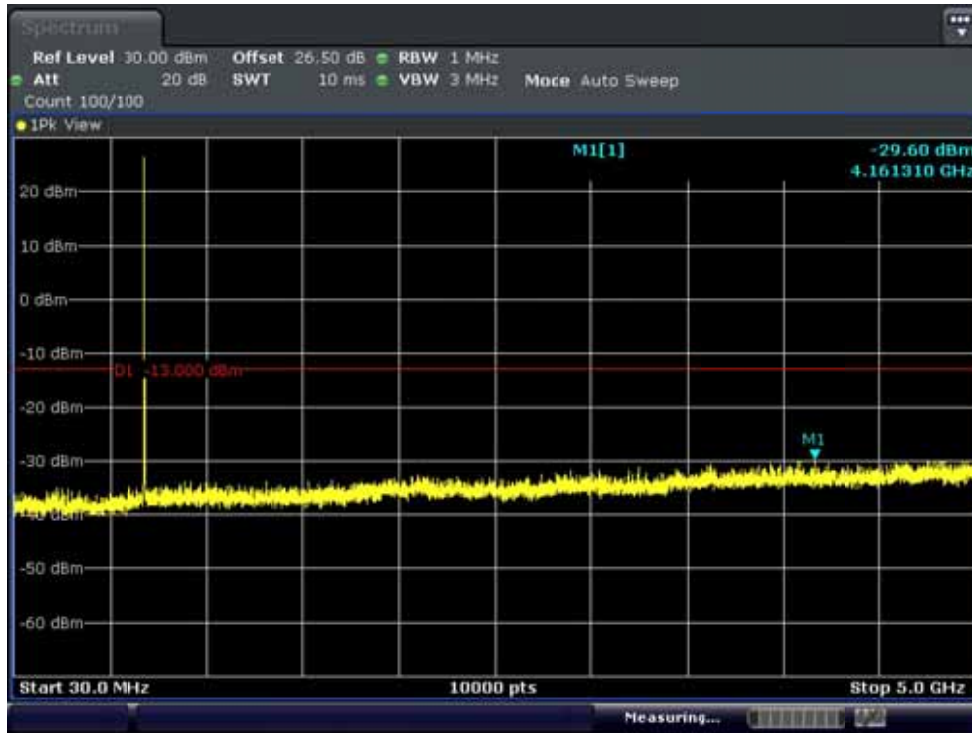

BAND17. Conducted Spurious Plot\_2 (23755ch\_5MHz\_QPSK\_RB 1\_0)

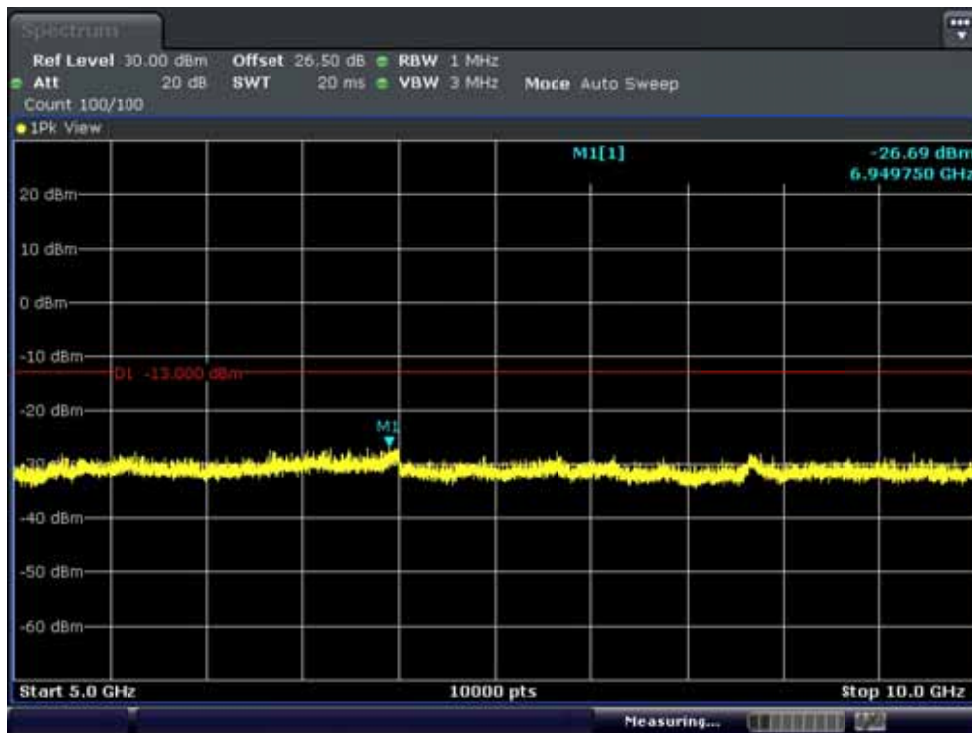

BAND17. Conducted Spurious Plot\_1 (23790ch\_5MHz\_QPSK\_RB 1\_0)

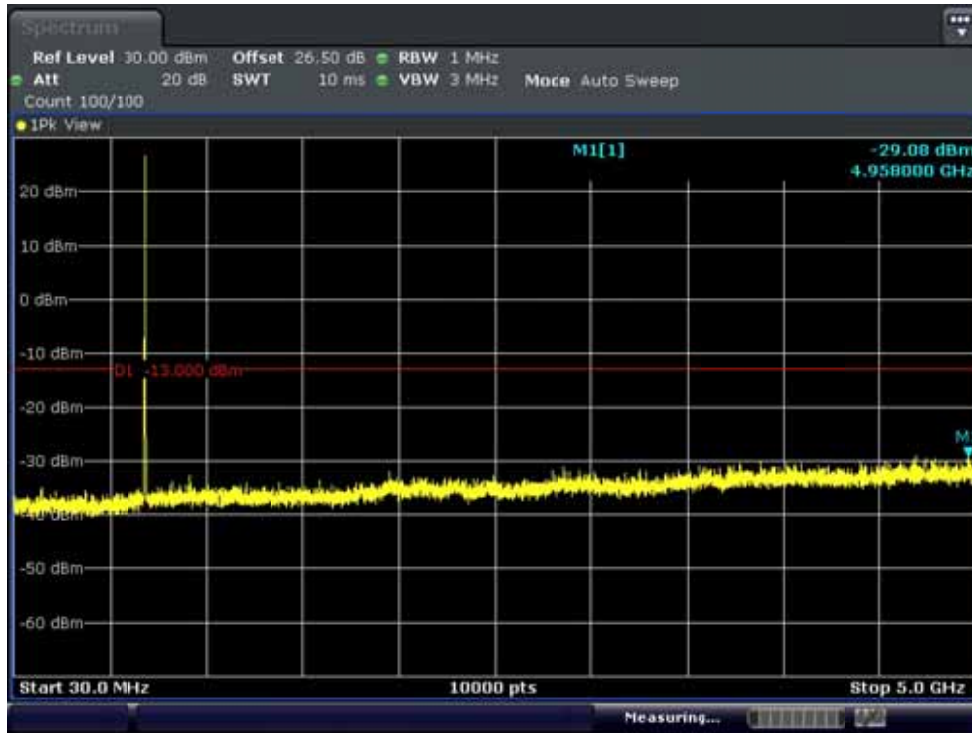

BAND17. Conducted Spurious Plot\_2 (23790ch\_5MHz\_QPSK\_RB 1\_0)

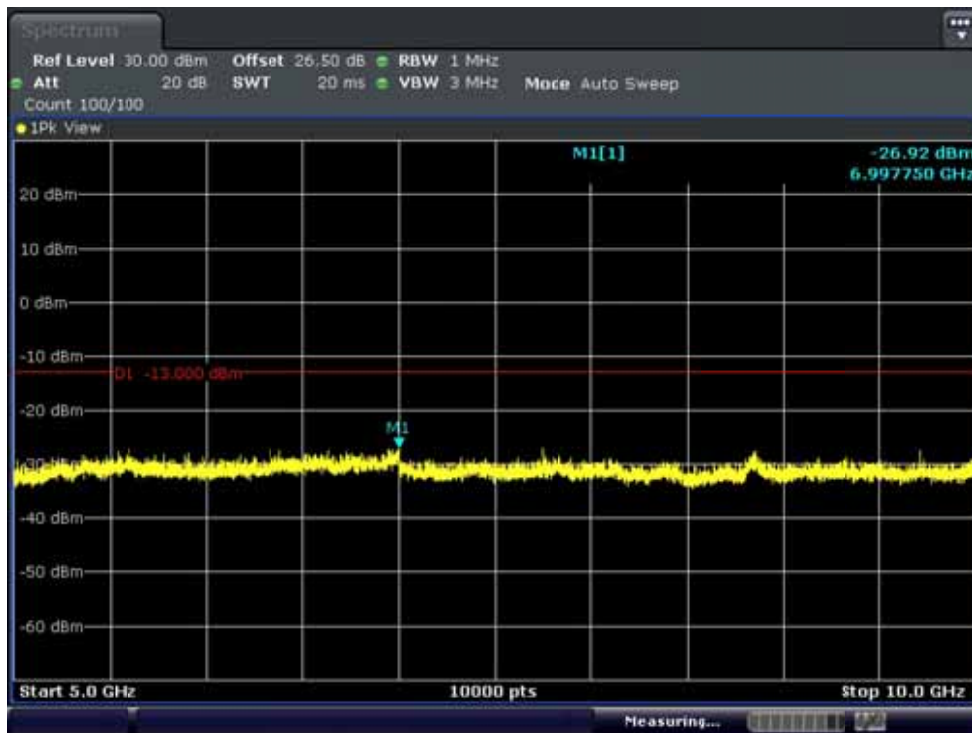

BAND17. Conducted Spurious Plot\_1 (23825ch\_5MHz\_QPSK\_RB 1\_0)

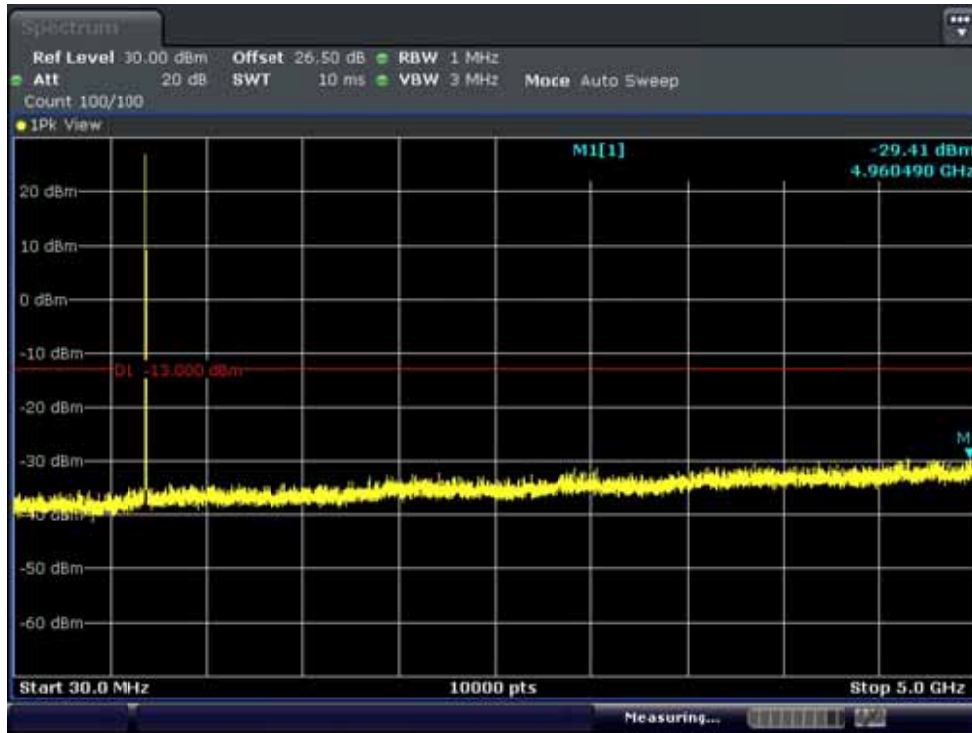

BAND17. Conducted Spurious Plot\_2 (23825ch\_5MHz\_QPSK\_RB 1\_0)

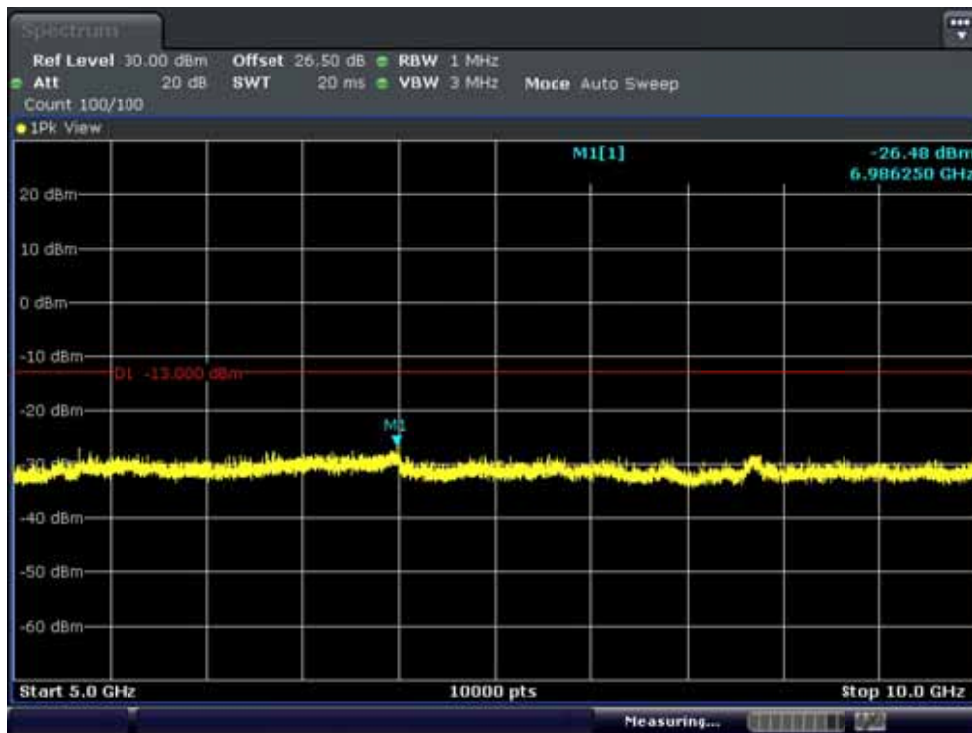



BAND17. Conducted Spurious Plot\_1 (23780ch\_10MHz\_QPSK\_RB 1\_0)

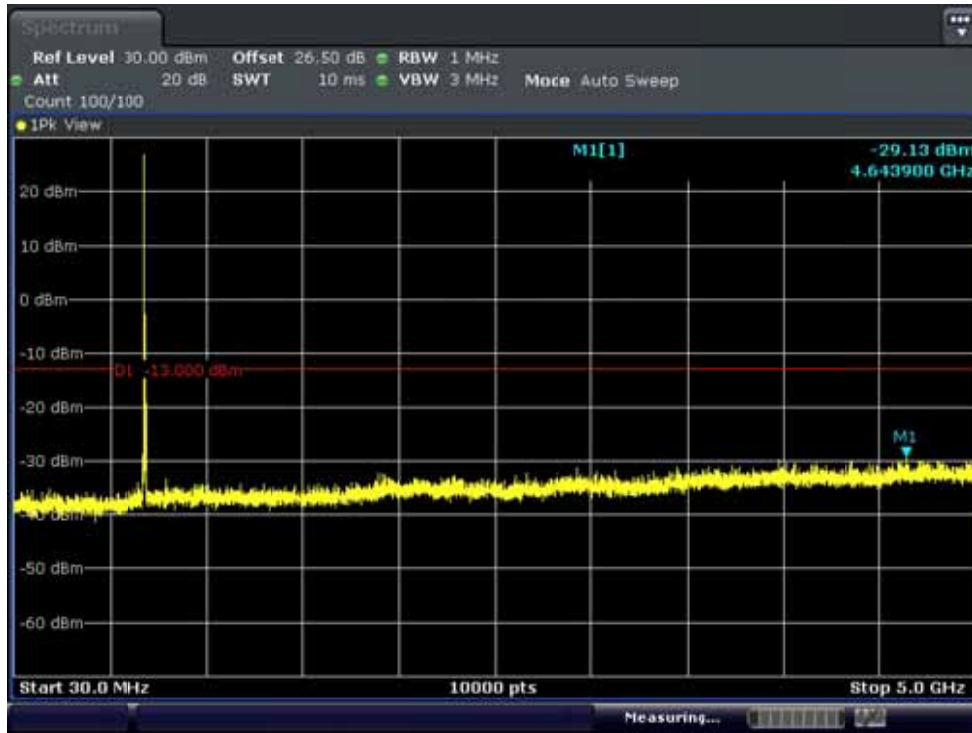

BAND17. Conducted Spurious Plot\_2 (23780ch\_10MHz\_QPSK\_RB 1\_0)



BAND17. Conducted Spurious Plot\_1 (23790ch\_10MHz\_QPSK\_RB 1\_0)

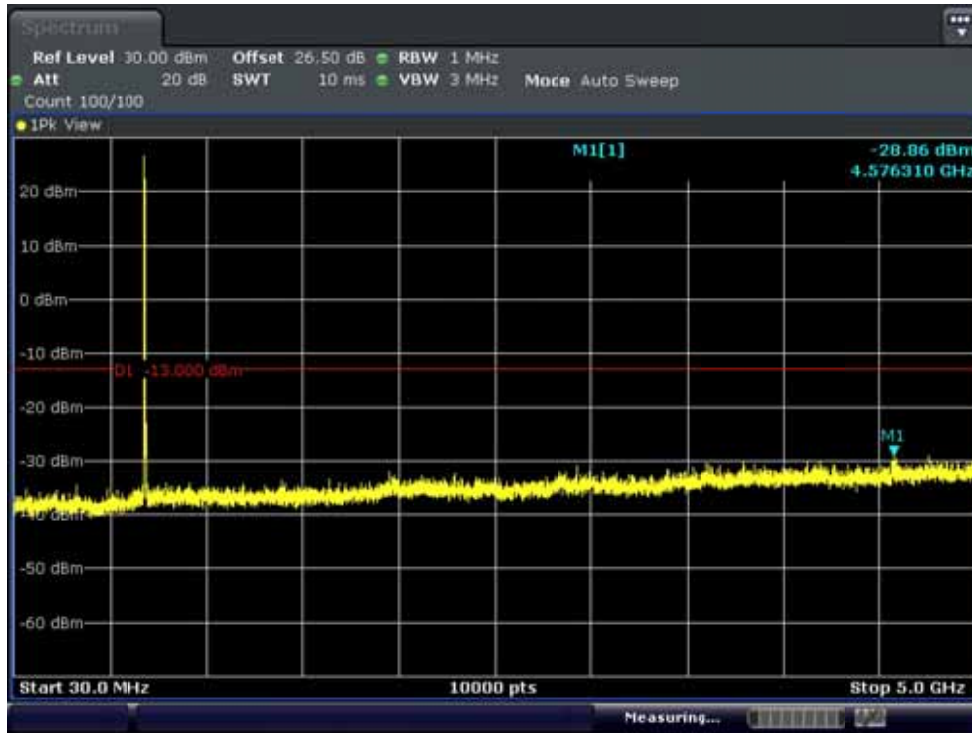

BAND17. Conducted Spurious Plot\_2 (23790ch\_10MHz\_QPSK\_RB 1\_0)

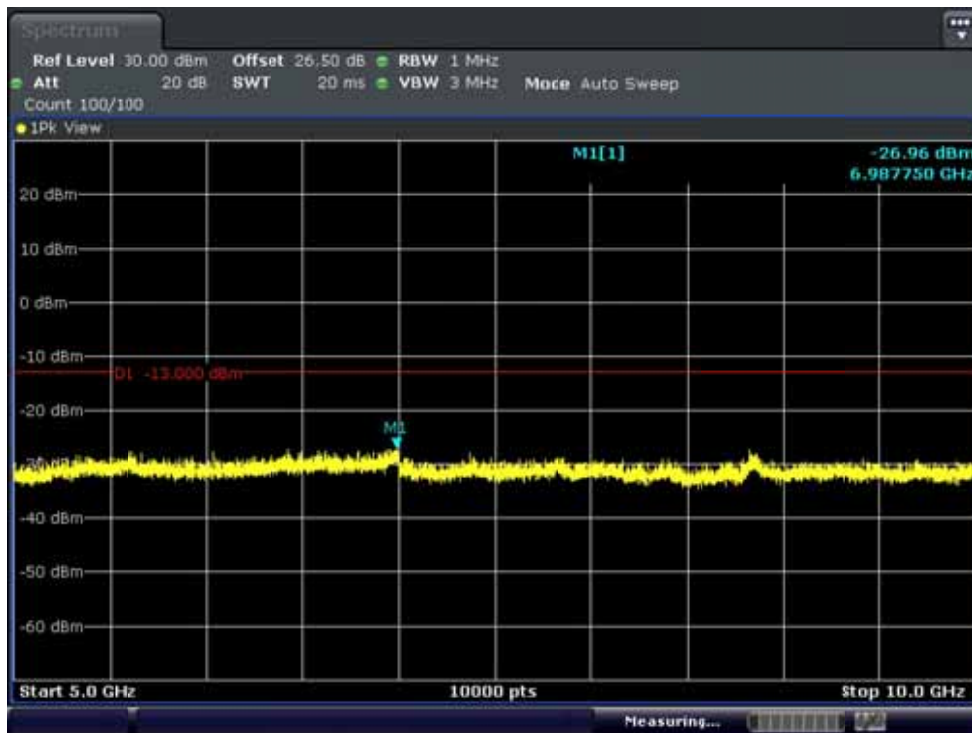

BAND17. Conducted Spurious Plot\_1 (23800ch\_10MHz\_QPSK\_RB 1\_0)

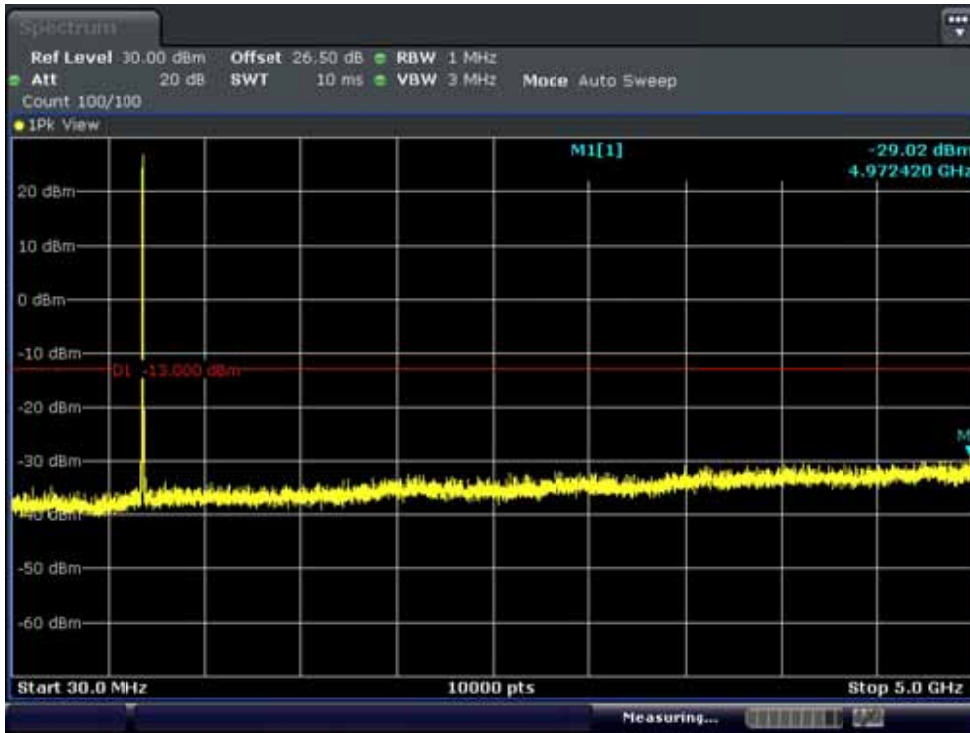

BAND17. Conducted Spurious Plot\_2 (23800ch\_10MHz\_QPSK\_RB 1\_0)

