

REPORT

FCC Certification

Applicant Name:
 LG Electronics MobileComm U.S.A., Inc.

Address:
 1000 Sylvan Avenue, Englewood Cliffs NJ 07632

Date of Issue:
 January 19, 2015

Test Site/Location:
 HCT CO., LTD., 74, Seoicheon-ro 578beon-gil,
 Majang-myeon, Icheon-si, Gyeonggi-do, Korea

Report No.: HCT-R-1501-F024

HCT FRN: 0005866421

FCC ID:	ZNFH955A
APPLICANT:	LG Electronics MobileComm U.S.A., Inc.

FCC Model(s): LG-H955a
Additional FCC Model(s): H955A, LGH955A, LG-H955a, H955a, LGH955a
EUT Type: Cellular/PCS GSM/GPRS/EDGE/WCDMA/HSDPA/HSUPA/LTE Phone with Bluetooth, WLAN, NFC
FCC Classification: Licensed Portable Transmitter Held to Ear (PCE)
FCC Rule Part(s): §27, §2

Mode (MHz)	Tx Frequency (MHz)	Emission Designator	Modulation	ERP	
				Max. Power (W)	Max. Power (dBm)
LTE – Band7 (5)	2502.5 – 2567.5	4M49G7D	QPSK	0.438	26.41
		4M50W7D	16QAM	0.446	26.49
LTE – Band7 (10)	2505.0 – 2565.0	8M97G7D	QPSK	0.444	26.47
		8M95W7D	16QAM	0.460	26.63
LTE – Band7 (15)	2507.5 – 2562.5	13M4G7D	QPSK	0.438	26.41
		13M5W7D	16QAM	0.416	26.19
LTE – Band7 (20)	2510.0 – 2560.0	17M9G7D	QPSK	0.444	26.47
		17M9W7D	16QAM	0.396	25.98

The measurements shown in this report were made in accordance with the procedures specified in §2.947. I assume full responsibility for the accuracy and completeness of these measurements, and for the qualifications of all persons taking them.

HCT CO., LTD. Certifies that no party to this application has subject to a denial of Federal benefits that includes FCC benefits pursuant to section 5301 of the Anti-Drug Abuse Act of 1998, 21 U.S. C.853(a)



Report prepared by
: Kwon Jeong
Test engineer of RF Team



Approved by
: Kyoung Houn Seo
Manager of RF Team

This report only responds to the tested sample and may not be reproduced, except in full, without written approval of the HCT Co., Ltd.

Version

TEST REPORT NO.	DATE	DESCRIPTION
HCT-R-1501-F024	January 19, 2015	- First Approval Report

Table of Contents

1. GENERAL INFORMATION	4
2. INTRODUCTION	5
2.1. EUT DESCRIPTION.....	5
2.2. MEASURING INSTRUMENT CALIBRATION.....	5
2.3. TEST FACILITY	5
3. DESCRIPTION OF TESTS.....	6
3.1 ERP/EIRP RADIATED POWER AND RADIATED SPURIOUS EMISSIONS.....	6
3.2 OCCUPIED BANDWIDTH.	7
3.3 SPURIOUS AND HARMONIC EMISSIONS AT ANTENNA TERMINAL.....	8
3.4 PEAK-AVERAGE RATIO.	9
3.5 FREQUENCY STABILITY / VARIATION OF AMBIENT TEMPERATURE	11
4. LIST OF TEST EQUIPMENT	12
5. SUMMARY OF TEST RESULTS	13
6. SAMPLE CALCULATION	14
7. TEST DATA	15
7.1 EQUIVALENT ISOTROPIC RADIATED POWER OUTPUT (Band 7).....	15
7.2 RADIATED SPURIOUS EMISSIONS	17
7.2.1 RADIATED SPURIOUS EMISSIONS (5 MHz Band 7 LTE).....	17
7.2.2 RADIATED SPURIOUS EMISSIONS (10 MHz Band 7 LTE).....	18
7.2.3 RADIATED SPURIOUS EMISSIONS (15 MHz Band 7 LTE).....	19
7.2.4 RADIATED SPURIOUS EMISSIONS (20 MHz Band 7 LTE).....	20
7.3 PEAK-TO-AVERAGE RATIO	21
7.4 OCCUPIED BANDWIDTH	21
7.5 CONDUCTED SPURIOUS EMISSIONS	22
7.5.1 BAND EDGE.....	22
7.6 FREQUENCY STABILITY / VARIATION OF AMBIENT TEMPERATURE	23
7.6.1 FREQUENCY STABILITY (5 MHz Band 7 LTE).....	23
7.6.2 FREQUENCY STABILITY (10 MHz Band 7 LTE).....	24
7.6.3 FREQUENCY STABILITY (15 MHz Band 7 LTE).....	25
7.6.4 FREQUENCY STABILITY (20 MHz Band 7 LTE).....	26
8. TEST PLOTS.....	27

MEASUREMENT REPORT

1. GENERAL INFORMATION

Applicant Name: LG Electronics MobileComm U.S.A., Inc.

Address: 1000 Sylvan Avenue, Englewood Cliffs NJ 07632

FCC ID: ZNFH955A

Application Type: Certification

FCC Classification: Licensed Portable Transmitter Held to Ear (PCE)

FCC Rule Part(s): §27, §2

EUT Type: Cellular/PCS GSM/GPRS/EDGE/WCDMA/HSDPA/HSUPA/LTE Phone with Bluetooth, WLAN, NFC

FCC Model(s): LG-H955a

Additional FCC Model(s): H955A, LGH955A, LG-H955a, H955a, LGH955a

Tx Frequency: 2502.5 MHz – 2567.5 MHz (LTE – Band 7): 5 MHz
2505.0 MHz – 2565.0 MHz (LTE – Band 7): 10 MHz
2507.5 MHz – 2562.5 MHz (LTE – Band 7): 15 MHz
2510.0 MHz – 2560.0 MHz (LTE – Band 7): 20 MHz

Max. RF Output Power:

Band 7 (5 MHz) :	0.438 W (QPSK) (26.41 dBm) 0.446 W (16-QAM) (26.49 dBm)
Band 7 (10 MHz) :	0.444 W (QPSK) (26.47 dBm) 0.460 W (16-QAM) (26.63 dBm)
Band 7 (15 MHz) :	0.438 W (QPSK) (26.41 dBm) 0.416 W (16-QAM) (26.19 dBm)
Band 7 (20 MHz) :	0.444 W (QPSK) (26.47 dBm) 0.396 W (16-QAM) (25.98 dBm)

Emission Designator(s):

Band 7 (5 MHz) :	4M49G7D (QPSK) / 4M50W7D (16-QAM)
Band 7 (10 MHz) :	8M97G7D (QPSK) / 8M95W7D (16-QAM)
Band 7 (15 MHz) :	13M4G7D (QPSK) / 13M5W7D (16-QAM)
Band 7 (20 MHz) :	17M9G7D (QPSK) / 17M9W7D (16-QAM)

Date(s) of Tests: December 11, 2014 ~ January 07, 2015

Antenna Specification

Manufacturer: AT & C Co., Ltd.

Antenna type: Internal Antenna

Peak Gain: Band 7: -0.83 dBi

2. INTRODUCTION

2.1. EUT DESCRIPTION

The LG Electronics MobileComm U.S.A., Inc. LG-H955a Cellular/PCS GSM/GPRS/EDGE/WCDMA/HSDPA/HSUPA/LTE Phone with Bluetooth, WLAN, NFC consists of LTE 7.

2.2. MEASURING INSTRUMENT CALIBRATION

The measuring equipment, which was utilized in performing the tests documented herein, has been calibrated in accordance with the manufacturer's recommendations for utilizing calibration equipment, which is traceable to recognized national standards.

2.3. TEST FACILITY

The Fully-anechoic chamber and conducted measurement facility used to collect the radiated data are located at the **74, Seoicheon-ro 578beon-gil, Majang-myeon, Icheon-si, Gyeonggi-do, Korea.**

3. DESCRIPTION OF TESTS

3.1 ERP/EIRP RADIATED POWER AND RADIATED SPURIOUS EMISSIONS

ERP/EIRP

Note: ERP(Effective Radiated Power), EIRP(Equivalent Isotropic Radiated Power)

Test Procedure

Radiated emission measurements are performed in the Fully-anechoic chamber. The equipment under test is placed on a non-conductive table 3-meters away from the receive antenna in accordance with ANSI/TIA-603-C-2004 Clause 2.2.17. The turntable is rotated through 360 degrees, and the receiving antenna scans in order to determine the level of the maximized emission. The level and position of the maximized emission is recorded with the spectrum analyzer using a positive peak detector.

A half wave dipole is then substituted in place of the EUT. For emissions above 1GHz, a horn antenna is substituted in place of the EUT. The substitute antenna is driven by a signal generator and the previously recorded signal was duplicated.

The power is calculated by the following formula;

$$P_{d(\text{dBm})} = P_{g(\text{dBm})} - \text{cable loss}_{(\text{dB})} + \text{antenna gain}_{(\text{dB})}$$

Where: P_d is the dipole equivalent power and P_g is the generator output power into the substitution antenna.

The maximum EIRP is calculated by adding the forward power to the calibrated source plus its appropriate gain value. These steps are repeated with the receiving antenna in both vertical and horizontal polarization. the difference between the gain of the horn and an isotropic antenna are taken into consideration

Radiated spurious emissions

1. Frequency Range : 30 MHz ~ 10th Harmonics of highest channel fundamental frequency.
2. Measured distance : 30 MHz ~ 11 GHz at 3 m
11 GHz ~ 26 GHz at 1m
3. The EUT was setup to maximum output power. The 100 kHz RBW was used to scan from 30 MHz to 1 GHz. Also, the 1 MHz RBW was used to scan from 1 GHz to 26.5 GHz. And limit is -25 dBm. The high, low and a middle channel were tested for out of band measurements.

3.2 OCCUPIED BANDWIDTH.

Test set-up

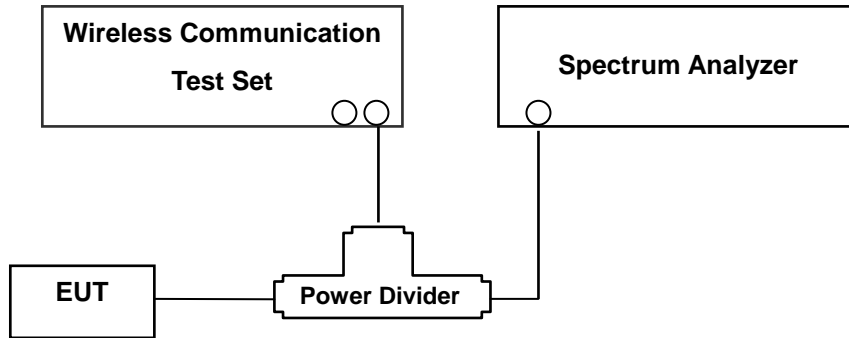

(Configuration of conducted Emission measurement)

The width of a frequency band such that, below the lower and above the upper frequency limits, the mean powers emitted are each equal to a specified percentage 0.5 % of the total mean power of a given emission.

Test Procedure

OBW is tested in accordance with KDB971168 D01 Power Meas License Digital Systems v02r02, October 17, 2014, Section 4.2..

The EUT makes a call to the communication simulator. The power was measured with R&S Spectrum Analyzer. All measurements were done at 3 channels(low, middle and high operational range.)

The conducted occupied bandwidth used the power splitter via EUT RF power connector between simulation base station and spectrum analyzer.

The communication simulator station system controlled a EUT to export maximum output power under transmission mode and specific channel frequency. Use OBW measurement function of Spectrum analyzer to measure 99 % occupied bandwidth

3.3 SPURIOUS AND HARMONIC EMISSIONS AT ANTENNA TERMINAL.

Test Procedure

Spurious and harmonic emissions at antenna terminal is tested in accordance with KDB971168 D01 Power Meas License Digital Systems v02r02, October 17, 2014, Section 6.0.

The level of the carrier and the various conducted spurious and harmonic frequencies is measured by means of a calibrated spectrum analyzer.

The EUT was setup to maximum output power. The 1 MHz RBW was used to scan from 30 MHz to 26.5 GHz. And limit is -25 dBm. The high, low and a middle channel were tested for out of band measurements.

- Channel Edge Requirement : In the 1MHz bands immediately outside and adjacent to the channel, a resolution bandwidth of at least 1 percent of the emission bandwidth of the fundamental emission of the transmitter may be employed to measure the out of band Emissions. Limit is -13dBm at channel edge and -25dBm at up to 5.5MHz from the channel edge.

NOTES: The analyzer plot offsets were determined by below conditions.

- For LTE Band 7, total offset 27.3 dBm = 20 dBm attenuator + 6 dBm Divider + 1.3 dBm RF cables.

3.4 PEAK-AVERAGE RATIO.

Test Procedure

Peak to Average Power Ratio is tested in accordance with KDB971168 D01 Power Meas License Digital Systems v02r02, October 17, 2014, Section 5.7.

- Section 5.7.1 CCDF Procedure

- a) Set resolution/measurement bandwidth \geq signal's occupied bandwidth;
- b) Set the number of counts to a value that stabilizes the measured CCDF curve;
- c) Set the measurement interval as follows:
 - 1) for continuous transmissions, set to 1 ms,
 - 2) for burst transmissions, employ an external trigger that is synchronized with the EUT burst timing sequence, or use the internal burst trigger with a trigger level that allows the burst to stabilize and set the measurement interval to a time that is less than or equal to the burst duration.
- d) Record the maximum PAPR level associated with a probability of 0.1%.

- Section 5.7.2 Alternate Procedure

Use one of the procedures presented in 5.1 to measure the total peak power and record as P_{Pk} . Use one of the applicable procedures presented 5.2 to measure the total average power and record as P_{Avg} . Determine the P.A.R. from: $P.A.R._{(dB)} = P_{Pk (dBm)} - P_{Avg (dBm)}$ (P_{Avg} = Average Power + Duty cycle Factor)

5.1.1 Peak power measurements with a spectrum/signal analyzer or EMI receiver

The following procedure can be used to determine the total peak output power.

- a) Set the RBW \geq OBW.
- b) Set VBW $\geq 3 \times$ RBW.
- c) Set span $\geq 2 \times$ RBW
- d) Sweep time = auto couple.
- e) Detector = peak.
- f) Ensure that the number of measurement points \geq span/RBW.
- g) Trace mode = max hold.
- h) Allow trace to fully stabilize.
- i) Use the peak marker function to determine the peak amplitude level.

5.2.2 Procedures for use with a spectrum/signal analyzer when EUT cannot be configured to transmit continuously and sweep triggering/signal gating cannot be properly implemented

If the EUT cannot be configured to transmit continuously (burst duty cycle < 98%), then one of the following procedures can be used. The selection of the applicable procedure will depend on the characteristics of the measured burst duty cycle.

Measure the burst duty cycle with a spectrum/signal analyzer or EMC receiver can be used in zero-span mode if the response time and spacing between bins on the sweep are sufficient to permit accurate measurement of the burst on/off time of the transmitted signal.

5.2.2.2 Constant burst duty cycle

If the measured burst duty cycle is constant (i.e., duty cycle variations are less than ± 2 percent), then:

- a) Set span to at least 1.5 times the OBW.
- b) Set RBW = 1-5% of the OBW, not to exceed 1 MHz.
- c) Set VBW $\geq 3 \times$ RBW.
- d) Number of points in sweep $\geq 2 \times$ span / RBW. (This gives bin-to-bin spacing \leq RBW/2, so that narrowband signals are not lost between frequency bins.)
- e) Sweep time = auto.
- f) Detector = RMS (power averaging).
- g) Set sweep trigger to "free run".
- h) Trace average at least 100 traces in power averaging (i.e., RMS) mode.
- i) Compute power by integrating the spectrum across the OBW of the signal using the instrument's band power measurement function with band limits set equal to the OBW band edges. If the instrument does not have a band power function, sum the spectrum levels (in power units) at intervals equal to the RBW extending across the entire OBW of the spectrum.
- j) Add $10 \log (1/x)$, where x is the duty cycle, to the measured power in order to compute the average power during the actual transmission times (because the measurement represents an average over both the on and off times of the transmission).

For example, add $10 \log (1/0.25) = 6$ dB if the duty cycle is a constant 25%.

3.5 FREQUENCY STABILITY / VARIATION OF AMBIENT TEMPERATURE

Test Set-up

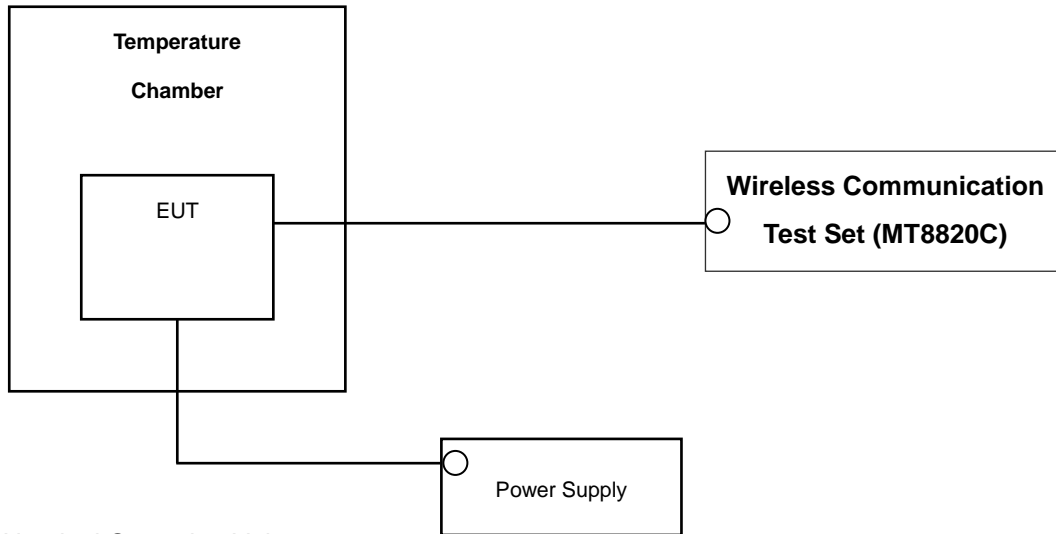

* Nominal Operating Voltage

Test Procedure

Frequency stability is tested in accordance with ANSI/TIA-603-C-2004 section 2.2.2.

The frequency stability of the transmitter is measured by:

- a.) **Temperature:** The temperature is varied from - 30 °C to + 50 °C using an environmental chamber.
- b.) **Primary Supply Voltage:** The primary supply voltage is varied from battery end point to 115 % of the voltage normally at the input to the device or at the power supply terminals if cables are not normally supplied.

Specification — the frequency stability shall be sufficient to ensure that the fundamental emission stays within the authorized frequency block(LTE Band7).

Time Period and Procedure:

The carrier frequency of the transmitter is measured at room temperature (20°C to provide a reference).

1. The equipment is turned on in a “standby” condition for one minute before applying power to the transmitter. Measurement of the carrier frequency of the transmitter is made within one minute after applying power to the transmitter.
2. Frequency measurements are made at 10°C intervals ranging from -30°C to +50°C. A period of at least one half-hour is provided to allow stabilization of the equipment at each temperature level.

4. LIST OF TEST EQUIPMENT

Manufacture	Model/ Equipment	Serial Number	Calibration Interval	Calibration Due
Agilent	N1921A/ Power Sensor	MY45241059	Annual	07/09/2015
Agilent	N1911A/ Power Meter	MY45100523	Annual	01/24/2015
MITEQ	AMF-6D-001180-35-20P/AMP	1081666	Annual	09/04/2015
Wainwright	WHK1.2/15G-10EF/H.P.F	4	Annual	06/17/2015
Wainwright	WRCJV2400/2483.5-2370/2520-60/12SS / B.R.F.	1	Annual	06/17/2015
Wainwright	WHK3.3/18G-10EF/H.P.F	2	Annual	06/17/2015
Hewlett Packard	11667B / Power Splitter	10545	Annual	02/22/2015
Hewlett Packard	11667B / Power Splitter	11275	Annual	05/19/2015
Digital	EP-3010/ Power Supply	3110117	Annual	10/29/2015
Schwarzbeck	UHAP/ Dipole Antenna	557	Biennial	03/05/2015
Schwarzbeck	UHAP/ Dipole Antenna	558	Biennial	05/03/2015
Korea Engineering	KR-1005L / Chamber	KRAC05063-3CH	Annual	10/29/2015
Schwarzbeck	BBHA 9120D/ Horn Antenna	147	Biennial	09/01/2016
Schwarzbeck	BBHA 9120D/ Horn Antenna	1151	Biennial	10/05/2015
Schwarzbeck	BBHA 9170/ Horn Antenna(15~40GHz)	BBHA9170541	Biennial	07/05/2015
Agilent	E4440A/Spectrum Analyzer	US45303008	Annual	04/09/2015
WEINSCHEL	ATTENUATOR	BR0592	Annual	10/22/2015
REOHDE&SCHWARZ	FSV40/Spectrum Analyzer	1307.9002K40-100931-NK	Annual	06/09/2015
Agilent	8960 (E5515C)/ Base Station	MY48360222	Annual	08/26/2015
Anritsu Corp.	MT8820C/Wideband Radio Communication Tester	6200863156	Annual	04/01/2015

5. SUMMARY OF TEST RESULTS

FCC Part Section(s)	Test Description	Test Limit	Test Condition	Test Result
2.1049	Occupied Bandwidth	N/A	CONDUCTED	PASS
2.1051, 27.53(m)(4)	Band Edge / Conducted Spurious Emissions.	< 40 + 10log10 (P[Watts]) at Channel edges < 43 + 10log10 (P[Watts]) between 5 and X MHz from Channel edges < 55 + 10log10 (P[Watts]) beyond X MHz beyond from Channel edges		PASS
27.50(d)(5)	Peak-Average Ratio	< 13 dB		PASS
*2.1046	Conducted Output Power	N/A		PASS
2.1055, 27.54	Frequency stability	Emission must remain in band		PASS
27.50(h)(2)	Equivalent Isotropic Radiated Power	< 2 Watts max. EIRP	RADIATED	PASS
2.1053, 27.53(m)(4)	Undesirable Emissions	< 40 + 10log10 (P[Watts]) at Channel edges < 43 + 10log10 (P[Watts]) between 5 and X MHz from Channel edges < 55 + 10log10 (P[Watts]) beyond X MHz beyond from Channel edges		PASS

*See SAR Report

6. SAMPLE CALCULATION

A. EIRP Sample Calculation

Mode	Ch./ Freq.		Measured Level(dBm)	Substitute LEVEL(dBm)	Ant. Gain (dBi)	C.L	Pol.	EIRP	
	channel	Freq.(MHz)						W	dBm
LTE Band7	21100	2,535.00	-15.36	19.58	10.67	2.18	V	0.64	28.07

EIRP = SubstituteLEVEL(dBm) + Ant. Gain – CL(Cable Loss)

- 1) The EUT mounted on a wooden tripod is 2.5 meter above test site ground level.
- 2) During the test , the turn table is rotated until the maximum signal is found.
- 3) Record the field strength meter's level.
- 4) Replace the EUT with dipole/Horn antenna that is connected to a calibrated signal generator.
- 5) Increase the signal generator output till the field strength meter's level is equal to the item (3).
- 6) The signal generator output level with Ant. Gain and cable loss are the rating of Equivalent Isotropic Radiated Power (**EIRP**).

B. Emission Designator

QPSK Modulation

Emission Designator = 4M48G7D

LTE BW = 4.48 MHz

G = Phase Modulation

7 = Quantized/Digital Info

D = Data transmission; telemetry; telecommand

16QAM Modulation

Emission Designator = 4M48W7D

LTE BW = 4.48 MHz

W = main carrier modulated in a combination of two

or more of the following modes;

amplitude, angle, pulse

7 = Quantized/Digital Info

D = Data transmission; telemetry; telecommand

7. TEST DATA

7.1 EQUIVALENT ISOTROPIC RADIATED POWER OUTPUT (Band 7)

Freq (MHz)	Bandwidth	Modulation	Measured Level (dBm)	Substitute Level (dBm)	Ant. Gain(dBi)	C.L	Pol	EIRP	
								W	dBm
2502.5	5 MHz	QPSK	-18.91	17.94	10.63	2.16	V	0.438	26.41
		16-QAM	-18.83	18.02	10.63	2.16	V	0.446	26.49
2535.0		QPSK	-19.53	17.41	10.67	2.18	V	0.389	25.90
		16-QAM	-19.51	17.43	10.67	2.18	V	0.391	25.92
2567.5		QPSK	-20.82	15.96	10.73	2.19	V	0.282	24.50
		16-QAM	-20.71	16.07	10.73	2.19	V	0.289	24.61

Equivalent Isotropic Radiated Power Data (5 MHz Band 7 LTE)

Note: Worst case is 1 resource block.

Freq (MHz)	Bandwidth	Modulation	Measured Level (dBm)	Substitute Level (dBm)	Ant. Gain(dBi)	C.L	Pol	EIRP	
								W	dBm
2505.0	10 MHz	QPSK	-18.85	17.99	10.64	2.16	V	0.444	26.47
		16-QAM	-18.69	18.15	10.64	2.16	V	0.460	26.63
2535.0		QPSK	-18.97	17.97	10.67	2.18	V	0.443	26.46
		16-QAM	-19.07	17.87	10.67	2.18	V	0.433	26.36
2565.0		QPSK	-20.93	15.85	10.73	2.19	V	0.275	24.39
		16-QAM	-20.64	16.14	10.73	2.19	V	0.294	24.68

Equivalent Isotropic Radiated Power Data (10 MHz Band 7 LTE)

Note: Worst case is 1 resource block.

Freq (MHz)	Bandwidth	Modulation	Measured Level (dBm)	Substitute Level (dBm)	Ant. Gain(dBi)	C.L	Pol	EIRP	
								W	dBm
2507.5	15 MHz	QPSK	-19.12	17.72	10.64	2.16	V	0.417	26.20
		16-QAM	-19.13	17.71	10.64	2.16	V	0.416	26.19
2535.0		QPSK	-19.02	17.92	10.67	2.18	V	0.438	26.41
		16-QAM	-19.48	17.46	10.67	2.18	V	0.394	25.95
2562.5		QPSK	-20.64	16.01	10.73	2.18	V	0.286	24.56
		16-QAM	-20.63	16.02	10.73	2.18	V	0.286	24.57

Equivalent Isotropic Radiated Power Data (15 MHz Band 7 LTE)

Note: Worst case is 1 resource block.

Freq (MHz)	Bandwidth	Modulation	Measured Level (dBm)	Substitute Level (dBm)	Ant. Gain(dBi)	C.L	Pol	EIRP	
								W	dBm
2510.0	20 MHz	QPSK	-18.95	17.55	10.64	2.16	V	0.401	26.03
		16-QAM	-19.27	17.23	10.64	2.16	V	0.372	25.71
2535.0		QPSK	-18.96	17.98	10.67	2.18	V	0.444	26.47
		16-QAM	-19.45	17.49	10.67	2.18	V	0.396	25.98
2560.0		QPSK	-19.85	16.80	10.73	2.18	V	0.343	25.35
		16-QAM	-19.50	17.15	10.73	2.18	V	0.372	25.70

Equivalent Isotropic Radiated Power Data (20 MHz Band 7 LTE)

Note: Worst case is 1 resource block.

NOTES:

Equivalent Isotropic Radiated Power Measurements by Substitution Method

according to ANSI/TIA/EIA-603-C-2004, Aug. 17, 2004:

The EUT was placed on a non-conductive styrofoam resin table 3-meters from the receive antenna. The receive antenna height and turntable rotation was adjusted for the highest reading on the receive spectrum analyzer. For 5 MHz, 10MHz BW signals, a peak detector is used, with $RBW \geq OBW$, $VBW \geq 3 \times RBW$. A Horn antenna was substituted in place of the EUT. This dipole antenna was driven by a signal generator and the level of the signal generator was adjusted to obtain the same receive spectrum analyzer reading. The conducted power at the terminals of the Horn antenna is measured. The difference between the gain of the horn and an isotropic antenna is taken into consideration and the EIRP is recorded.

Also, we have done x, y, z planes in EUT and horizontal and vertical polarization in detecting antenna. The worst case of the EUT is z plane in LTE mode. Also worst case of detecting Antenna is vertical polarization in LTE mode.

7.2 RADIATED SPURIOUS EMISSIONS

7.2.1 RADIATED SPURIOUS EMISSIONS (5 MHz Band 7 LTE)

- ▣ OPERATING FREQUENCY : 2502.50 MHz
- ▣ MEASURED OUTPUT POWER: 26.49 dBm = 0.446 W
- ▣ MODULATION SIGNAL: 5 MHz 16-QAM
- ▣ DISTANCE: 3 meters
- ▣ LIMIT: $55 + 10 \log_{10}(W) =$ 51.49 dBc

Ch	Freq (MHz)	Measured Level (dBm)	Ant. Gain (dBi)	Substitute Level (dBm)	C.L	Pol	EIRP (dBm)	dBc
20775 (2502.5)	5,005.0	-56.13	12.40	-52.91	3.15	H	-43.66	70.15
	7,507.5	-54.08	11.06	-42.30	4.19	H	-35.43	61.92
	10,010.0	-56.72	11.68	-40.47	4.59	H	-33.38	59.87
21100 (2535.0)	5,070.0	-55.69	12.30	-52.31	3.15	H	-43.16	69.65
	7,605.0	-53.88	11.30	-42.25	4.05	H	-35.00	61.49
	10,140.0	-56.11	11.59	-38.86	4.57	H	-31.84	58.33
21425 (2567.5)	5,135.0	-56.94	12.35	-53.09	3.20	H	-43.94	70.43
	7,702.5	-54.98	11.45	-42.95	4.05	V	-35.55	62.04
	10,270.0	-55.97	11.40	-38.56	4.57	V	-31.73	58.22

- NOTES:**
1. Radiated Spurious Emission Measurements at 1 meter and 3 meter by Substitution Method according to ANSI/TIA/EIA-603-C-2004, Aug. 17, 2004:
 2. We are performed all frequency to 10th harmonics from 30 MHz. Measurements above show only up to 3 maximum emissions noted, or would be lesser if no specific emissions from the EUT are recorded (ie: margin > 20 dB from the applicable limit) and considered that's already beyond the background noise floor.
 3. we have done x, y, z planes in EUT and horizontal and vertical polarization in detecting antenna.
 4. Worst case is 1 resource block.

7.2.2 RADIATED SPURIOUS EMISSIONS (10 MHz Band 7 LTE)

- ▣ OPERATING FREQUENCY : 2505.00 MHz
- ▣ MEASURED OUTPUT POWER: 26.63 dBm = 0.460 W
- ▣ MODULATION SIGNAL: 10 MHz 16-QAM
- ▣ DISTANCE: 3 meters
- ▣ LIMIT: $55 + 10 \log_{10}(W) =$ 51.63 dBc

Ch	Freq (MHz)	Measured Level (dBm)	Ant. Gain (dBi)	Substitute Level (dBm)	C.L	Pol	EIRP (dBm)	dBc
20800 (2505.0)	5,010.0	-56.13	12.39	-52.73	3.17	H	-43.51	70.14
	7,515.0	-53.95	11.08	-42.34	4.29	H	-35.55	62.18
	10,020.0	-59.38	11.69	-43.25	4.50	H	-36.06	62.69
21100 (2535.0)	5,070.0	-57.71	12.30	-54.33	3.15	H	-45.18	71.81
	7,605.0	-52.42	11.30	-40.79	4.05	H	-33.54	60.17
	10,140.0	-58.26	11.59	-41.01	4.57	H	-33.99	60.62
21400 (2565.0)	5,130.0	-57.89	12.34	-54.05	3.18	H	-44.89	71.52
	7,695.0	-54.87	11.45	-42.67	4.01	H	-35.23	61.86
	10,260.0	-57.55	11.41	-39.86	4.50	H	-32.95	59.58

- NOTES:**
1. Radiated Spurious Emission Measurements at 1 meter and 3 meter by Substitution Method according to ANSI/TIA/EIA-603-C-2004, Aug. 17, 2004:
 2. We are performed all frequency to 10th harmonics from 30 MHz. Measurements above show only up to 3 maximum emissions noted, or would be lesser if no specific emissions from the EUT are recorded (ie: margin > 20 dB from the applicable limit) and considered that's already beyond the background noise floor.
 3. we have done x, y, z planes in EUT and horizontal and vertical polarization in detecting antenna.
 4. Worst case is 1 resource block.

7.2.3 RADIATED SPURIOUS EMISSIONS (15 MHz Band 7 LTE)

▣ OPERATING FREQUENCY :	<u>2535.00 MHz</u>
▣ MEASURED OUTPUT POWER:	<u>26.41 dBm = 0.438 W</u>
▣ MODULATION SIGNAL:	<u>15 MHz QPSK</u>
▣ DISTANCE:	<u>3 meters</u>
▣ LIMIT: $55 + 10 \log_{10}(W) =$	<u>51.41 dBc</u>

Ch	Freq (MHz)	Measured Level (dBm)	Ant. Gain (dBi)	Substitute Level (dBm)	C.L	Pol	EIRP (dBm)	dBc
20825 (2507.5)	5,015.0	-56.69	12.39	-53.27	3.19	H	-44.07	70.48
	7,522.5	-54.95	11.10	-43.44	4.38	H	-36.72	63.13
	10,030.0	-58.56	11.69	-42.52	4.61	H	-35.44	61.85
21100 (2535.0)	5,070.0	-56.33	12.30	-52.95	3.15	H	-43.80	70.21
	7,605.0	-55.23	11.30	-43.60	4.05	H	-36.35	62.76
	10,140.0	-58.18	11.59	-40.93	4.57	H	-33.91	60.32
21375 (2562.5)	5,125.0	-59.93	12.33	-56.05	3.21	H	-46.93	73.34
	7,687.5	-54.33	11.44	-42.18	3.95	H	-34.69	61.10
	10,250.0	-59.00	11.42	-41.72	4.63	H	-34.93	61.34

- NOTES:**
1. Radiated Spurious Emission Measurements at 1 meter and 3 meter by Substitution Method according to ANSI/TIA/EIA-603-C-2004, Aug. 17, 2004:
 2. We are performed all frequency to 10th harmonics from 30 MHz. Measurements above show only up to 3 maximum emissions noted, or would be lesser if no specific emissions from the EUT are recorded (ie: margin > 20 dB from the applicable limit) and considered that's already beyond the background noise floor.
 3. we have done x, y, z planes in EUT and horizontal and vertical polarization in detecting antenna.
 4. Worst case is 1 resource block.

7.2.4 RADIATED SPURIOUS EMISSIONS (20 MHz Band 7 LTE)

- ▣ OPERATING FREQUENCY : 2535.00 MHz
- ▣ MEASURED OUTPUT POWER: 26.47 dBm = 0.444 W
- ▣ MODULATION SIGNAL: 20 MHz QPSK
- ▣ DISTANCE: 3 meters
- ▣ LIMIT: $55 + 10 \log_{10}(W) =$ 51.47 dBc

Ch	Freq (MHz)	Measured Level (dBm)	Ant. Gain (dBi)	Substitute Level (dBm)	C.L	Pol	EIRP (dBm)	dBc
20850 (2510.0)	5,020.0	-56.21	12.38	-53.20	3.20	H	-44.02	70.49
	7,530.0	-54.74	11.12	-43.07	4.29	H	-36.24	62.71
	10,040.0	-59.07	11.70	-42.24	4.58	H	-35.12	61.59
21100 (2535.0)	5,070.0	-59.76	12.30	-56.38	3.15	H	-47.23	73.70
	7,605.0	-55.09	11.30	-43.46	4.05	H	-36.21	62.68
	10,140.0	-59.36	11.59	-42.11	4.57	H	-35.09	61.56
21350 (2560.0)	5,120.0	-60.87	12.31	-57.09	3.23	H	-48.01	74.48
	7,680.0	-56.18	11.43	-44.35	3.90	H	-36.82	63.29
	10,240.0	-59.44	11.44	-41.98	4.66	H	-35.20	61.67

- NOTES:**
1. Radiated Spurious Emission Measurements at 1 meter and 3 meter by Substitution Method according to ANSI/TIA/EIA-603-C-2004, Aug. 17, 2004:
 2. We are performed all frequency to 10th harmonics from 30 MHz. Measurements above show only up to 3 maximum emissions noted, or would be lesser if no specific emissions from the EUT are recorded (ie: margin > 20 dB from the applicable limit) and considered that's already beyond the background noise floor.
 3. we have done x, y, z planes in EUT and horizontal and vertical polarization in detecting antenna.
 4. Worst case is 1 resource block.

7.3 PEAK-TO-AVERAGE RATIO

Band	Band Width	Frequency (MHz)	Modulation	Resource Block Size	Resource Block Offset	Data (dB)
Band 7	5 MHz	2535.0	QPSK	25	0	5.05
			16-QAM	25	0	5.78
	10 MHz		QPSK	50	0	5.03
			16-QAM	50	0	5.80
	15 MHz		QPSK	75	0	4.88
			16-QAM	75	0	5.67
	20 MHz		QPSK	100	0	4.92
			16-QAM	100	0	5.71

- Plots of the EUT's Peak- to- Average Ratio are shown Page 32 ~ 35

7.4 OCCUPIED BANDWIDTH

Band	Band Width (MHz)	Frequency (MHz)	Modulation	Resource Block Size	Resource Block Offset	Data (MHz)
Band 7	5	2535.0	QPSK	25	0	4.4924
			16-QAM	25	0	4.5030
	10		QPSK	50	0	8.9655
			16-QAM	50	0	8.9516
	15		QPSK	75	0	13.4450
			16-QAM	75	0	13.4640
	20		QPSK	100	0	17.9230
			16-QAM	100	0	17.9100

- Plots of the EUT's Occupied Bandwidth are shown Page 28 ~ 31

7.5 CONDUCTED SPURIOUS EMISSIONS

- Plots of the EUT's Conducted Spurious Emissions are shown Page 42 ~ 53

7.5.1 BAND EDGE

Band	Band Width (MHz)	Frequency (MHz)	Modulation	Resource Block Size	Resource Block Offset	Channel Edge Data [dBm]					
						Channel Edge (Limit: -10dBm)		5 MHz ~ X MHz from the Channel Edge (Limit: -13dBm)		X MHz ~ from the Channel Edge (Limit: -25dBm)	
						Lower	Upper	Lower	Upper	Lower	Upper
Band 7	5	2502.5	QPSK	25	0	-18.05	-19.94	-35.29	-34.25	-37.68	-36.38
		2535.0		25	0	-18.84	-20.62	-36.78	-37.91	-38.88	-39.12
		2567.5		25	0	-17.81	-18.53	-34.17	-35.33	-36.77	-37.66
	10	2505.0		50	0	-22.33	-22.92	-27.56	-26.90	-38.97	-35.52
		2535.0		50	0	-22.35	-24.84	-26.98	-29.82	-38.77	-39.19
		2565.0		50	0	-21.43	-21.77	-25.60	-27.79	-36.38	-37.69
	15	2507.5		75	0	-23.35	-23.36	-26.65	-25.85	-42.76	-37.40
		2535.0		75	0	-23.26	-25.73	-26.13	-29.01	-40.25	-39.92
		2562.5		75	0	-22.61	-22.94	-25.51	-27.09	-37.97	-39.75
	20	2510.0		100	0	-24.29	-23.93	-27.53	-26.38	-43.56	-38.00
		2535.0		100	0	-23.81	-26.18	-26.12	-29.32	-40.99	-40.30
		2560.0		100	0	-24.03	-24.32	-26.81	-27.91	-38.99	-41.62

- Plots of the EUT's Band Edge are shown Page 36 ~ 41

7.6 FREQUENCY STABILITY / VARIATION OF AMBIENT TEMPERATURE

7.6.1 FREQUENCY STABILITY (5 MHz Band 7 LTE)

- ▣ OPERATING FREQUENCY: 2535.000,000 Hz
- ▣ CHANNEL: 21100 (5 MHz)
- ▣ REFERENCE VOLTAGE: 3.8 VDC
- ▣ DEVIATION LIMIT: -

Voltage (%)	Power (VDC)	Temp. (°C)	Frequency (Hz)	Frequency Error (Hz)	Deviation (%)	ppm
100%	3.80	+20(Ref)	2535 000 005	0	0.000 000	0.000
100%		-30	2534 999 994	-10.6	0.000 000	-0.004
100%		-20	2534 999 998	-7.0	0.000 000	-0.003
100%		-10	2535 000 000	-5.2	0.000 000	-0.002
100%		0	2535 000 013	7.9	0.000 000	0.003
100%		+10	2534 999 995	-10.5	0.000 000	-0.004
100%		+30	2535 000 012	6.7	0.000 000	0.003
100%		+40	2534 999 996	-9.3	0.000 000	-0.004
100%		+50	2535 000 000	-4.9	0.000 000	-0.002
115%	4.35	+20	2534 999 998	-7.4	0.000 000	-0.003
Batt. Endpoint	3.00	+20	2535 000 001	-4.3	0.000 000	-0.002

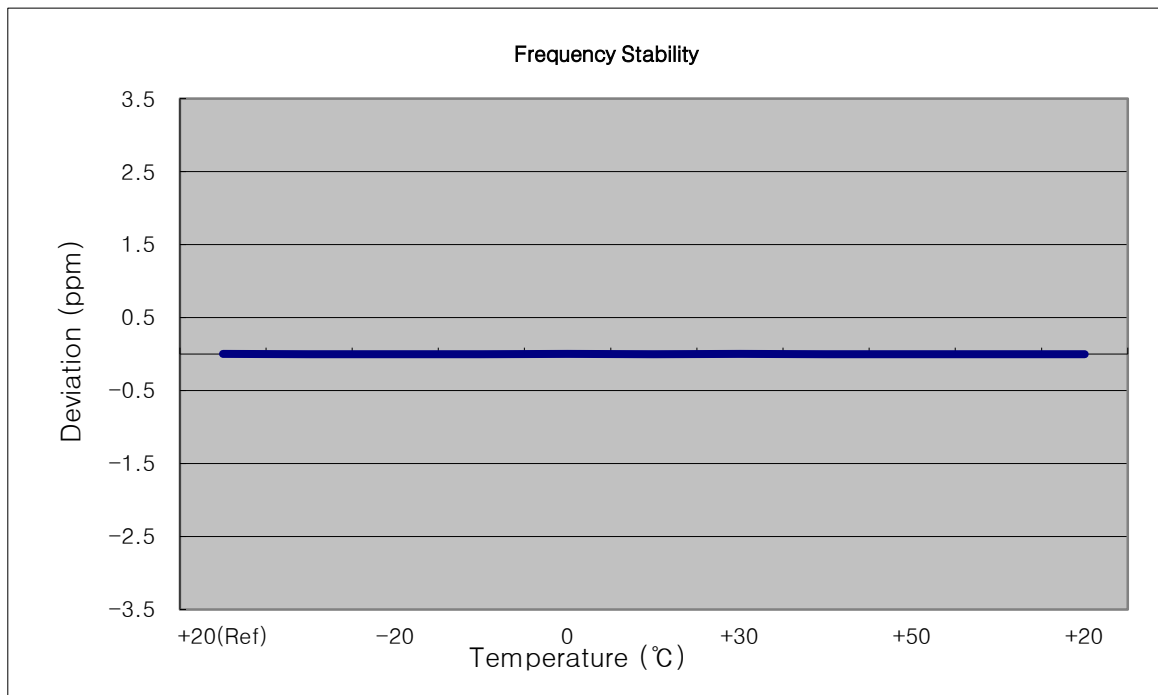

7.6.2 FREQUENCY STABILITY (10 MHz Band 7 LTE)

- ▣ OPERATING FREQUENCY: 2535.000,000 Hz
- ▣ CHANNEL: 21100 (10 MHz)
- ▣ REFERENCE VOLTAGE: 3.8 VDC
- ▣ DEVIATION LIMIT: -

Voltage (%)	Power (VDC)	Temp. (°C)	Frequency (Hz)	Frequency Error (Hz)	Deviation (%)	ppm
100%	3.80	+20(Ref)	2535 000 004	0	0.000 000	0.000
100%		-30	2534 999 997	-6.7	0.000 000	-0.003
100%		-20	2534 999 999	-4.6	0.000 000	-0.002
100%		-10	2534 999 996	-7.7	0.000 000	-0.003
100%		0	2534 999 998	-5.9	0.000 000	-0.002
100%		+10	2534 999 999	-5.2	0.000 000	-0.002
100%		+30	2534 999 995	-8.5	0.000 000	-0.003
100%		+40	2534 999 994	-9.6	0.000 000	-0.004
100%		+50	2534 999 996	-8.3	0.000 000	-0.003
115%		4.35	+20	2534 999 998	-6.2	0.000 000
Batt. Endpoint	3.00	+20	2535 000 000	-4.0	0.000 000	-0.002

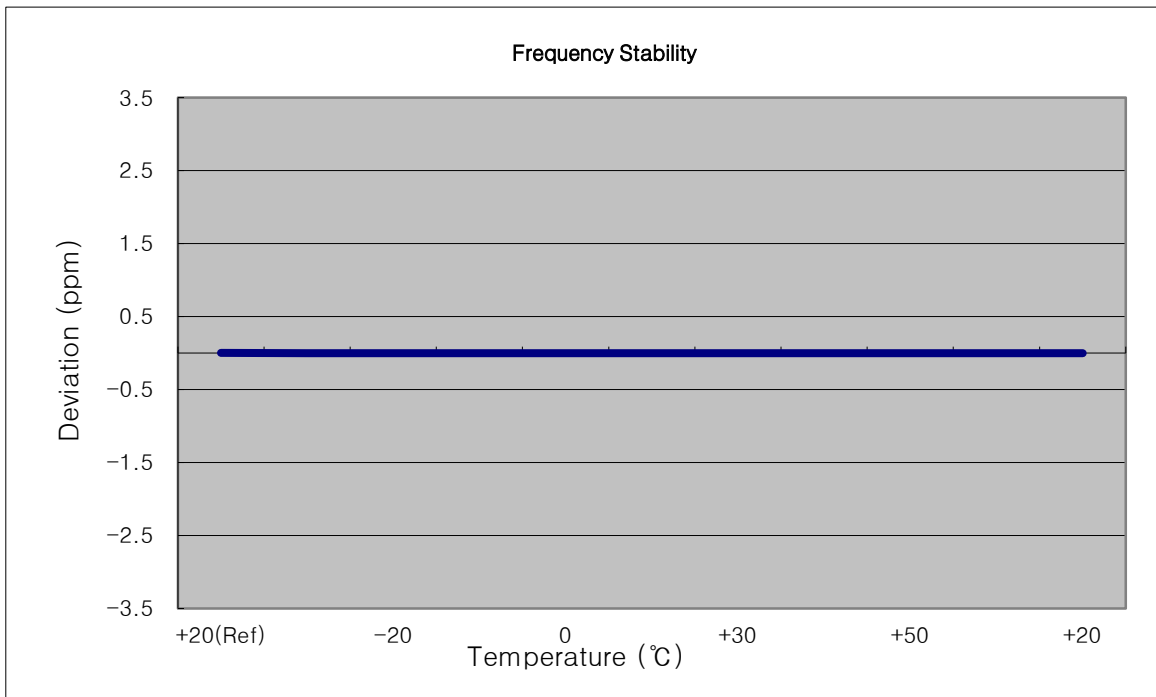

7.6.3 FREQUENCY STABILITY (15 MHz Band 7 LTE)

- ▣ OPERATING FREQUENCY: 2535.000,000 Hz
- ▣ CHANNEL: 21100 (15 MHz)
- ▣ REFERENCE VOLTAGE: 3.8 VDC
- ▣ DEVIATION LIMIT: -

Voltage (%)	Power (VDC)	Temp. (°C)	Frequency (Hz)	Frequency Error (Hz)	Deviation (%)	ppm
100%	3.80	+20(Ref)	2535 000 008	0	0.000 000	0.000
100%		-30	2535 000 001	-6.7	0.000 000	-0.003
100%		-20	2535 000 000	-7.9	0.000 000	-0.003
100%		-10	2534 999 999	-8.8	0.000 000	-0.003
100%		0	2535 000 002	-5.8	0.000 000	-0.002
100%		+10	2535 000 003	-4.4	0.000 000	-0.002
100%		+30	2535 000 002	-5.9	0.000 000	-0.002
100%		+40	2535 000 001	-6.3	0.000 000	-0.002
100%		+50	2535 000 012	4.5	0.000 000	0.002
115%	4.35	+20	2535 000 000	-7.5	0.000 000	-0.003
Batt. Endpoint	3.00	+20	2535 000 001	-7.0	0.000 000	-0.003

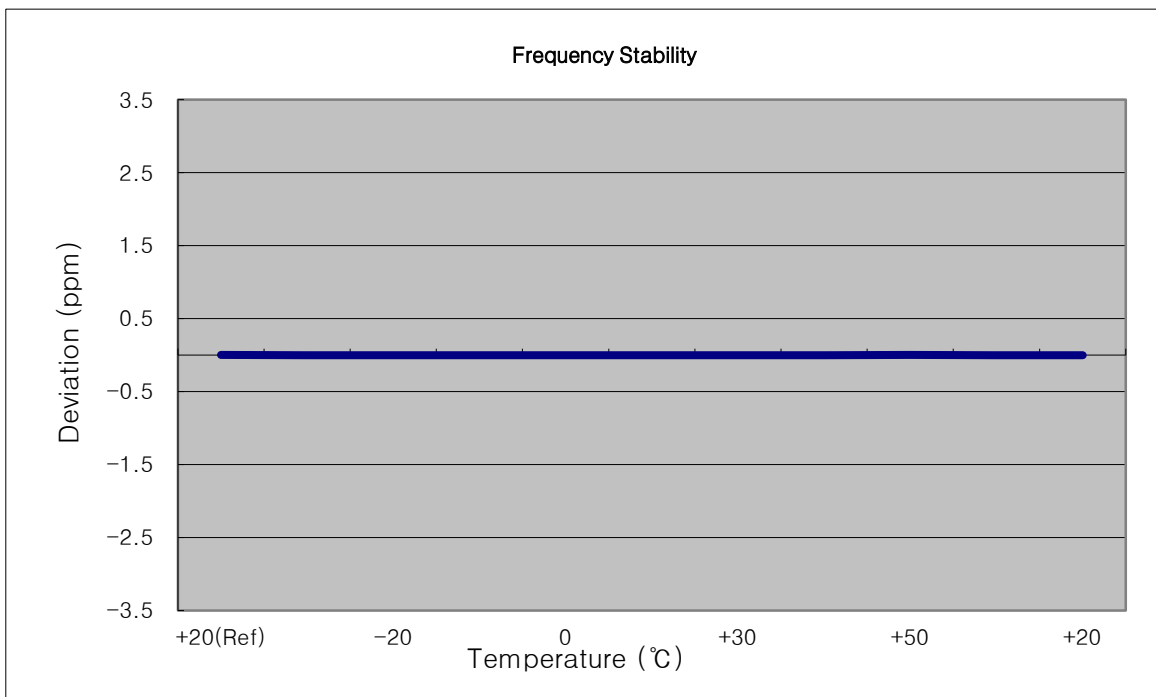

7.6.4 FREQUENCY STABILITY (20 MHz Band 7 LTE)

- ▣ OPERATING FREQUENCY: 2535.000,000 Hz
- ▣ CHANNEL: 21100 (20 MHz)
- ▣ REFERENCE VOLTAGE: 3.8 VDC
- ▣ DEVIATION LIMIT: -

Voltage (%)	Power (VDC)	Temp. (°C)	Frequency (Hz)	Frequency Error (Hz)	Deviation (%)	ppm
100%	3.80	+20(Ref)	2535 000 007	0	0.000 000	0.000
100%		-30	2535 000 001	-6.4	0.000 000	-0.003
100%		-20	2534 999 999	-7.7	0.000 000	-0.003
100%		-10	2535 000 001	-5.9	0.000 000	-0.002
100%		0	2534 999 999	-7.9	0.000 000	-0.003
100%		+10	2535 000 000	-7.1	0.000 000	-0.003
100%		+30	2535 000 003	-4.3	0.000 000	-0.002
100%		+40	2535 000 000	-7.1	0.000 000	-0.003
100%		+50	2534 999 999	-8.5	0.000 000	-0.003
115%	4.35	+20	2535 000 003	-4.2	0.000 000	-0.002
Batt. Endpoint	3.00	+20	2535 000 002	-5.5	0.000 000	-0.002

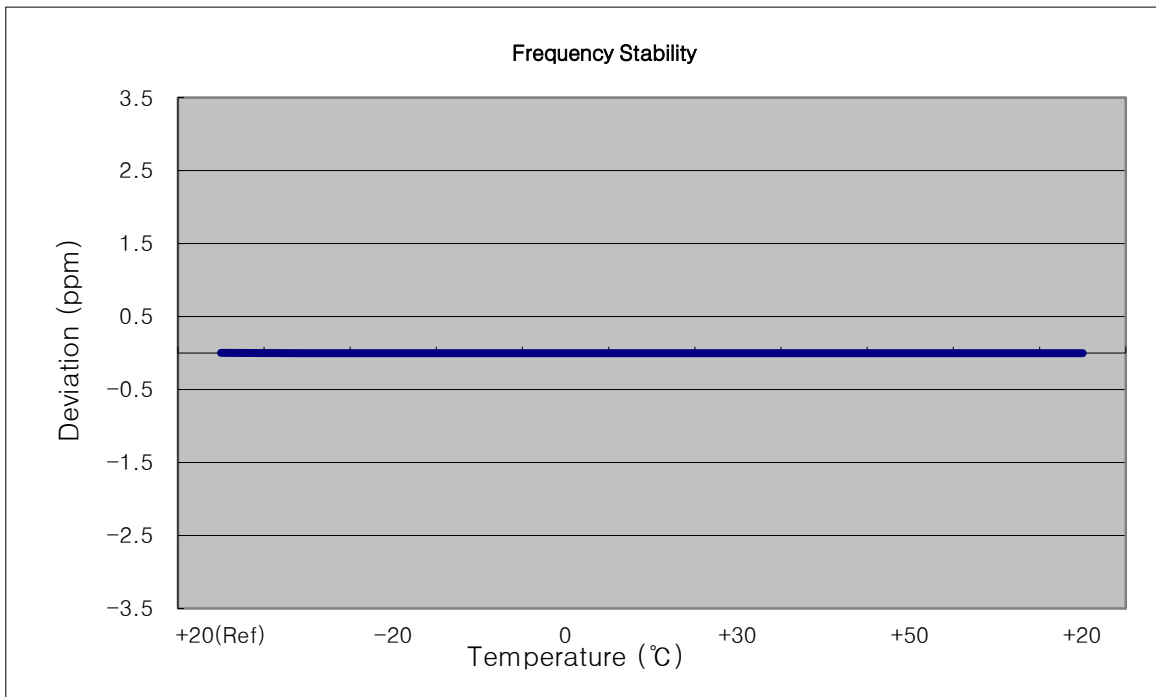

8. TEST PLOTS

BAND7. Occupied Bandwidth Plot (5MHz Ch.21100 QPSK RB 25)

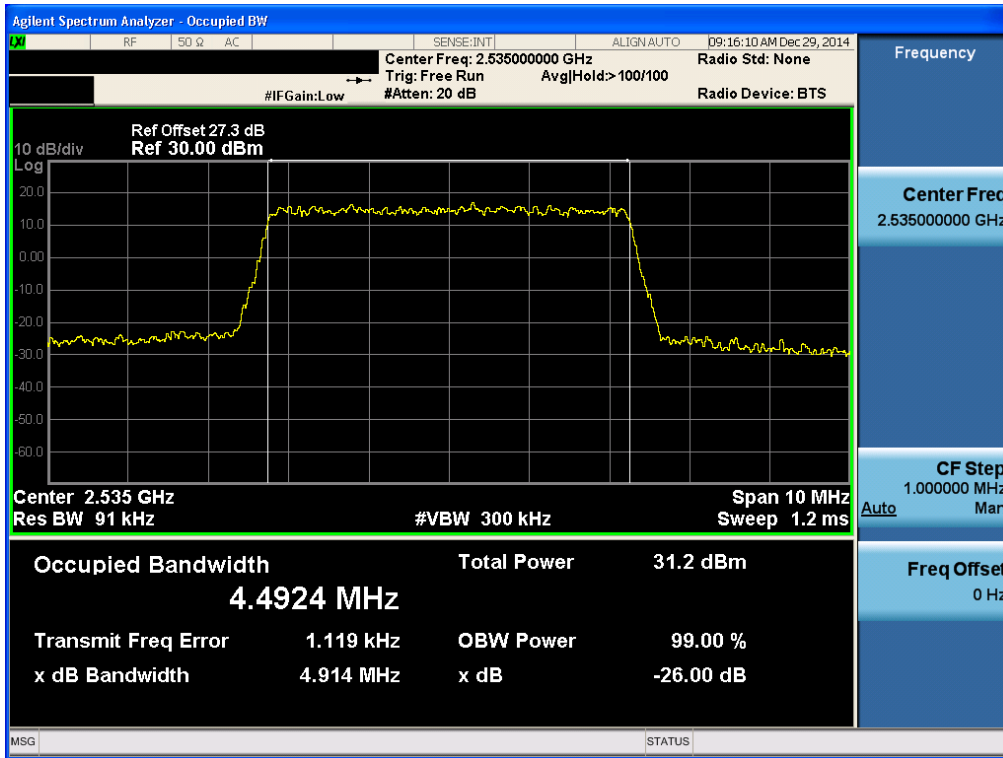

BAND7. Occupied Bandwidth Plot (5MHz Ch.21100 16-QAM RB 25)

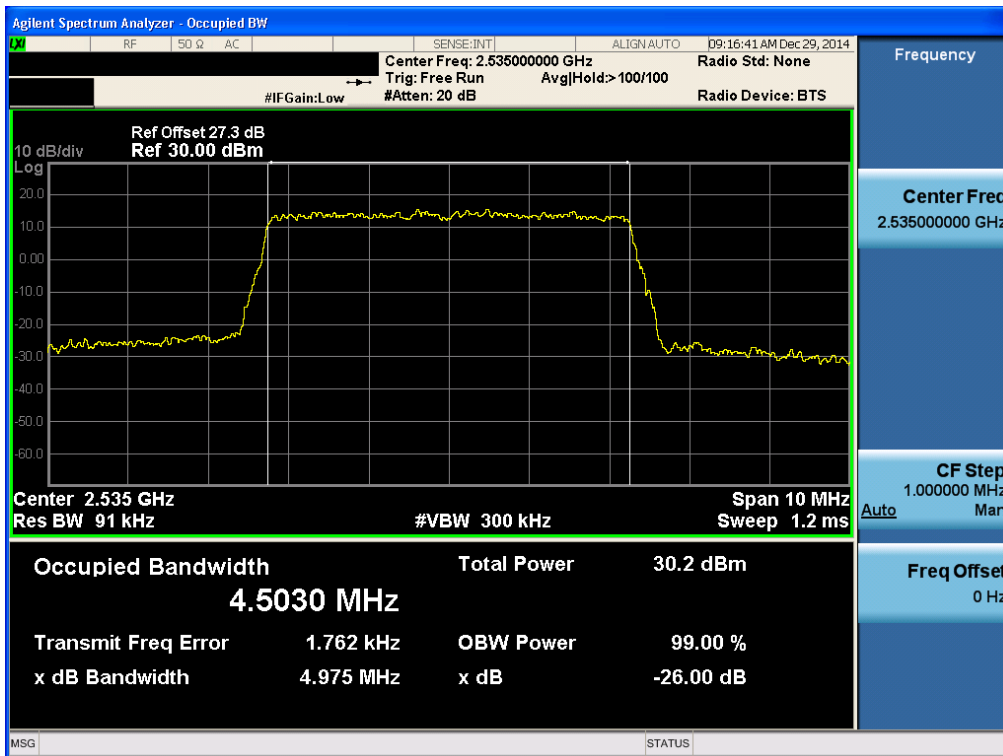

BAND7. Occupied Bandwidth Plot (10MHz Ch.21100 QPSK RB 50)

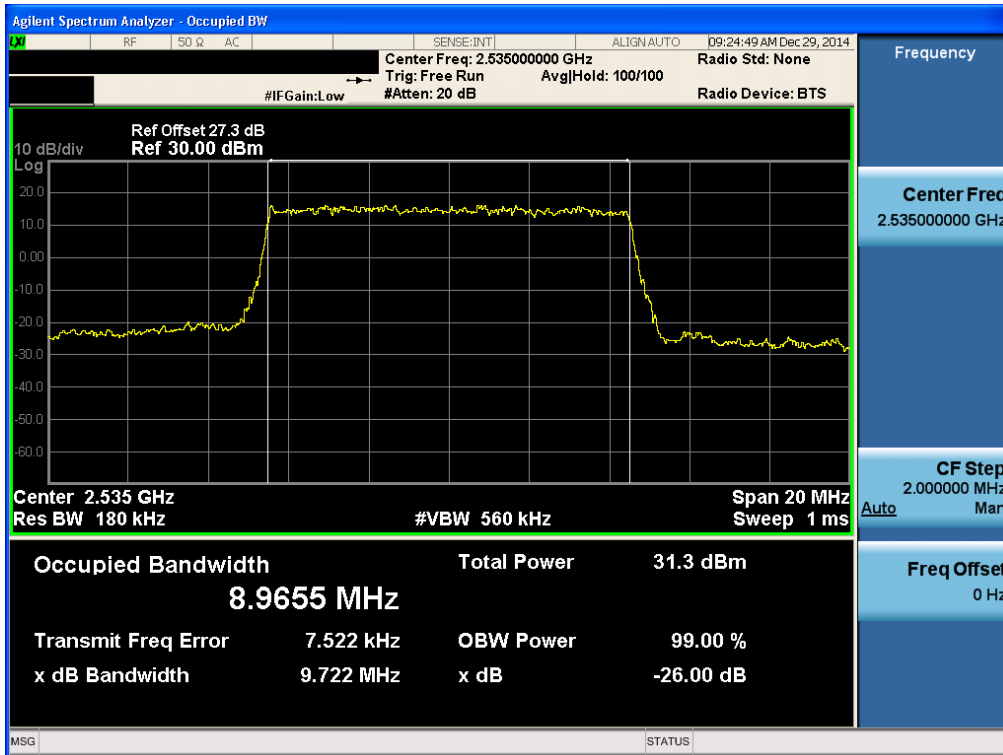

BAND7. Occupied Bandwidth Plot (10MHz Ch.21100 16-QAM RB 50)

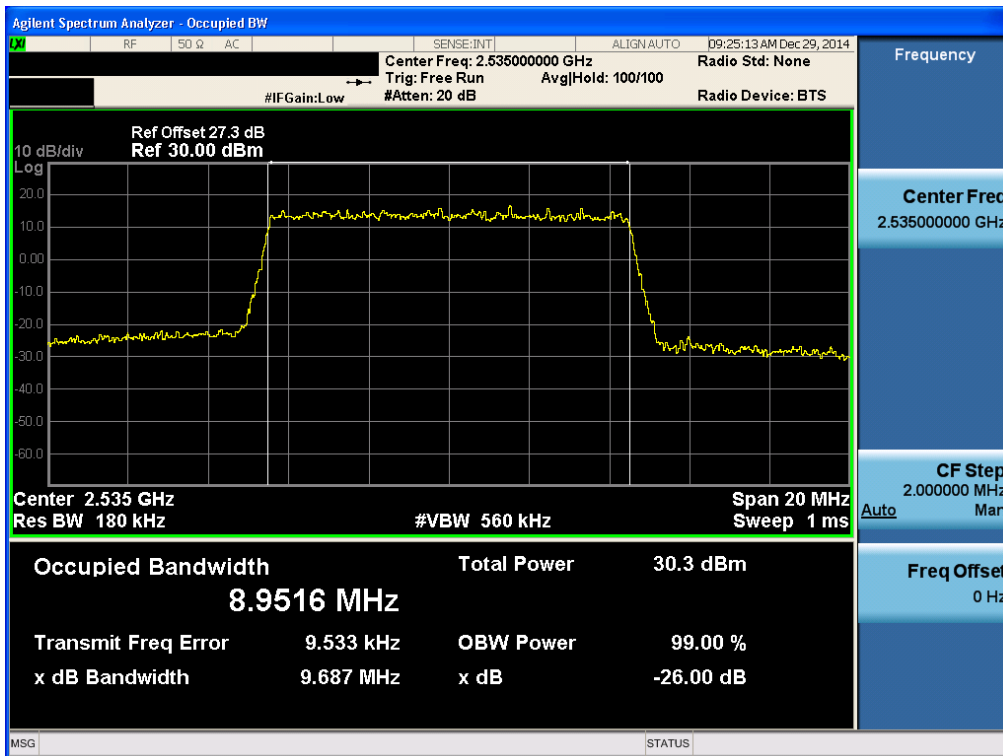

BAND7. Occupied Bandwidth Plot (15MHz Ch.21100 QPSK RB 75)

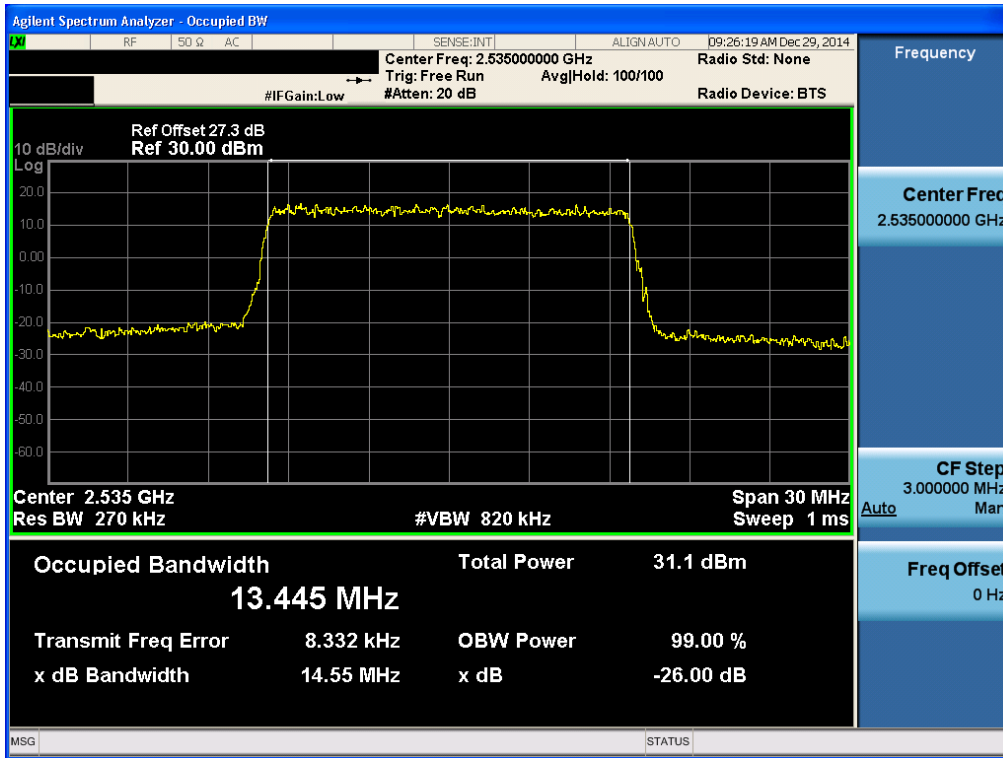

BAND7. Occupied Bandwidth Plot (15MHz Ch.21100 16-QAM RB 75)

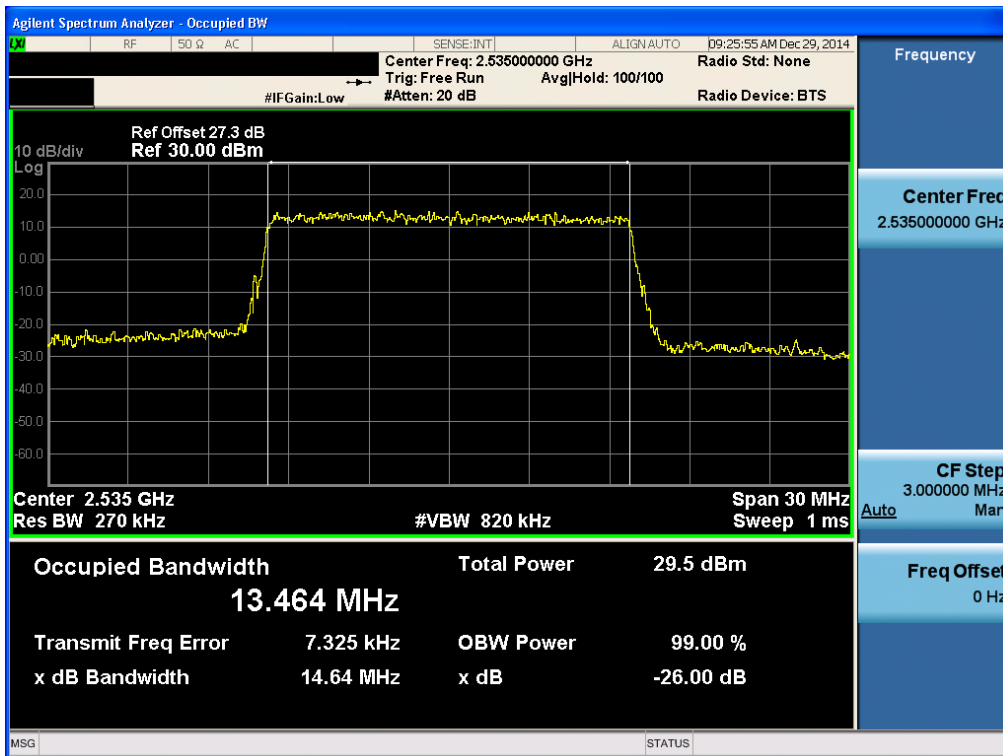

BAND7. Occupied Bandwidth Plot (20MHz Ch.21100 QPSK RB 100)

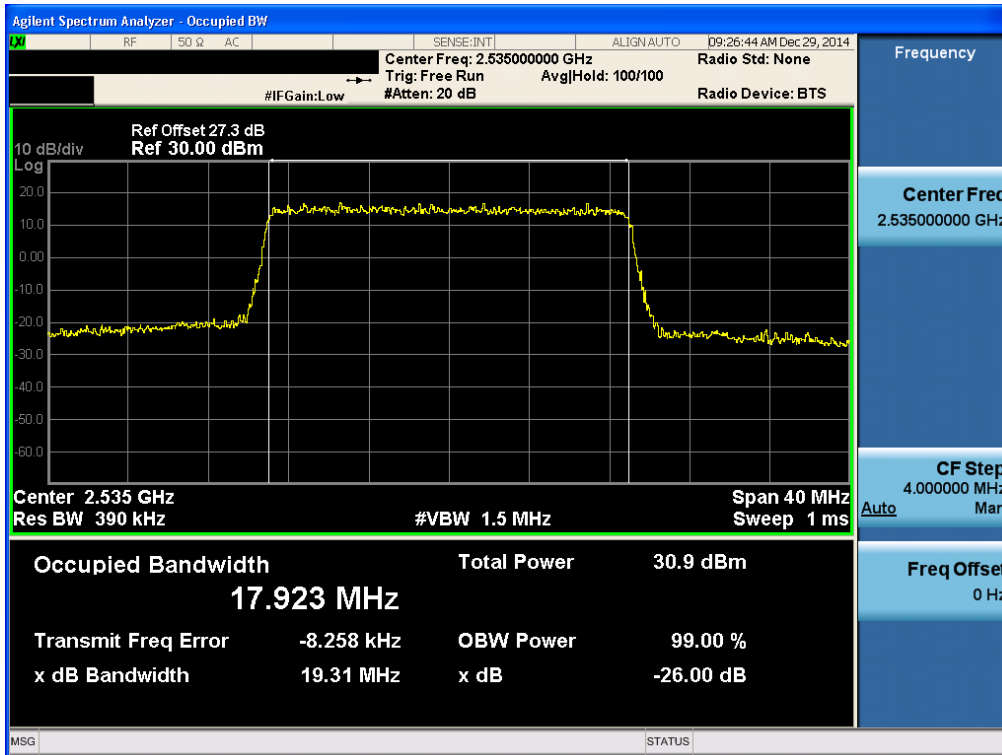

BAND7. Occupied Bandwidth Plot (20MHz Ch.21100 16-QAM RB 100)

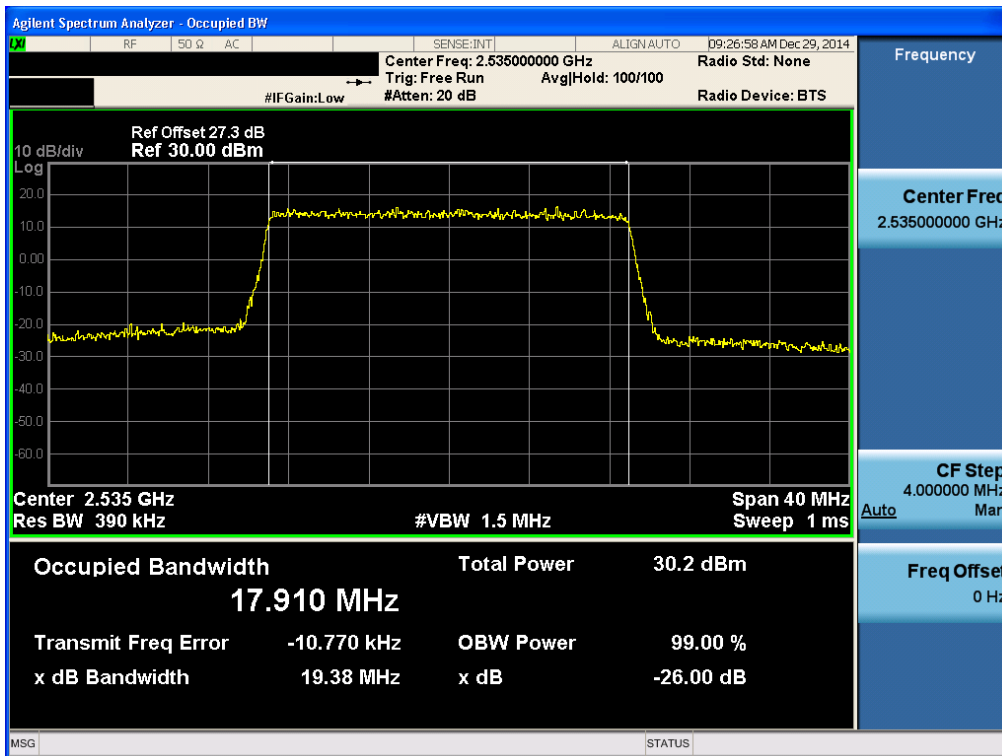

BAND7. Peak to Average Ratio Plot (5MHz Ch.21100 QPSK RB 25)

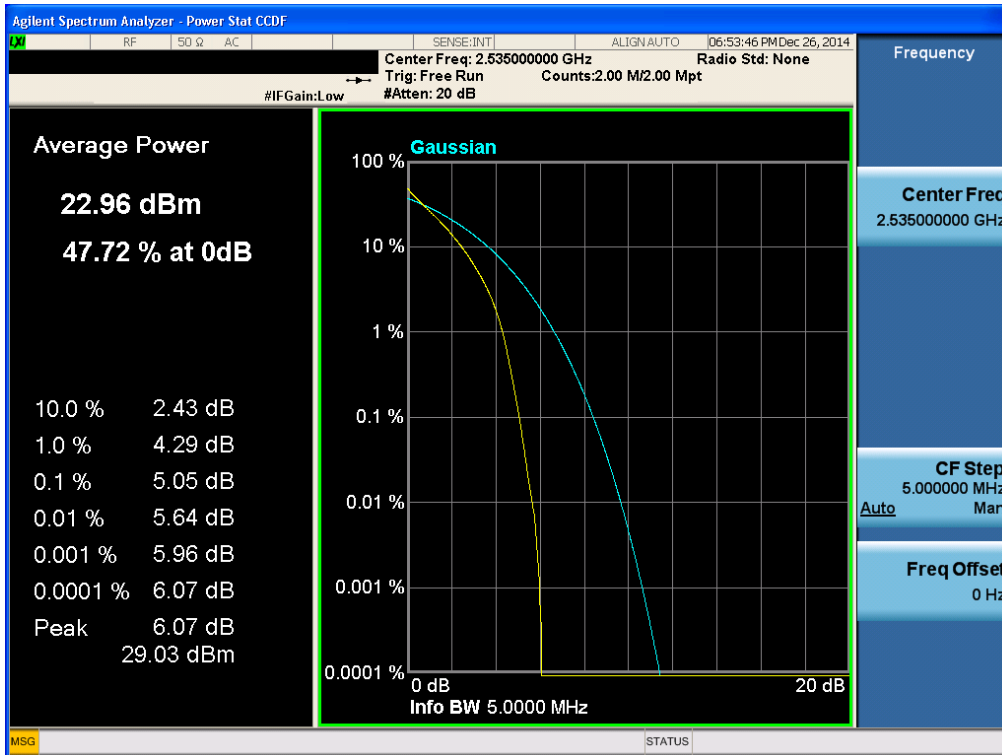

BAND7. Peak to Average Ratio Plot (5MHz Ch.21100 16-QAM RB 25)

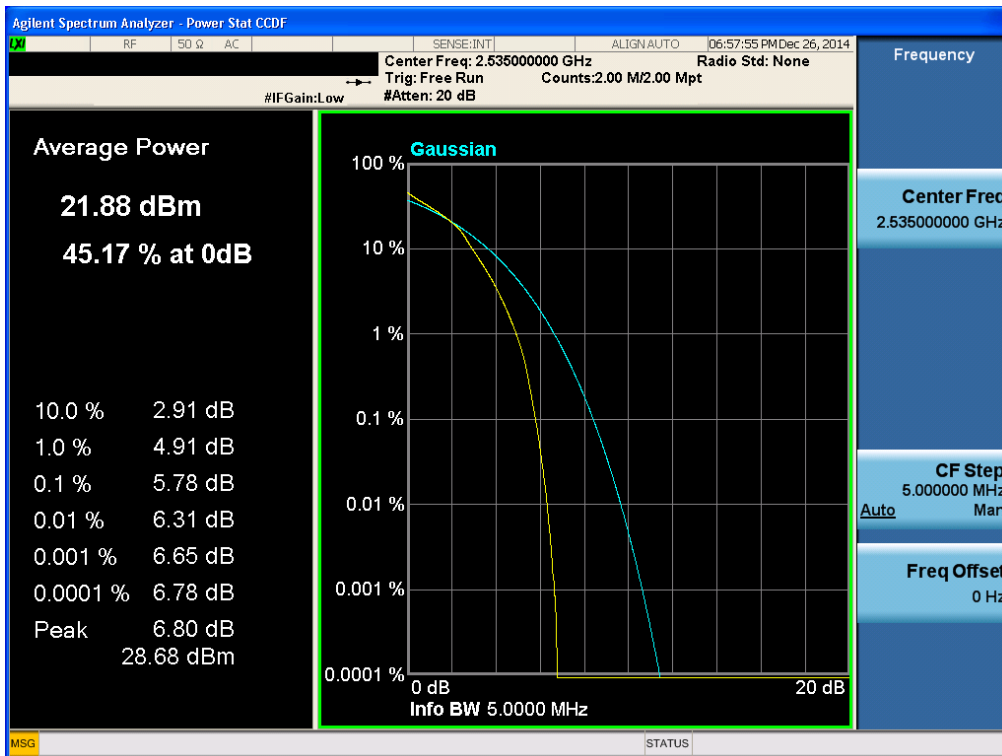

BAND7. Peak to Average Ratio Plot (10MHz Ch.21100 QPSK RB 50)

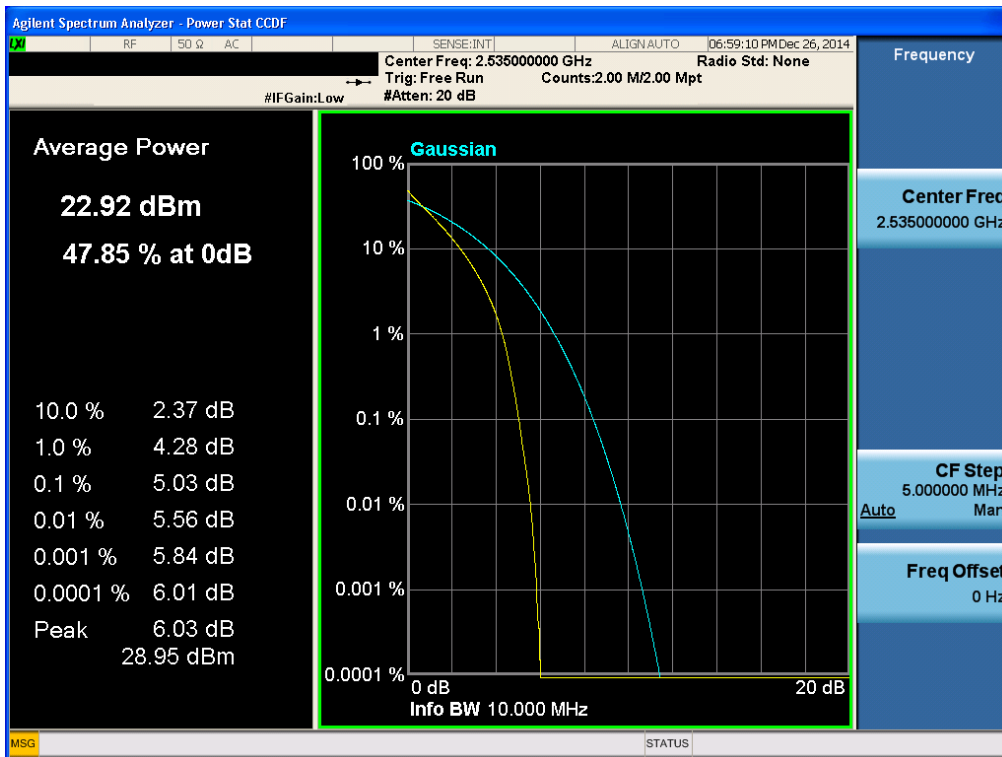

BAND7. Peak to Average Ratio Plot (10MHz Ch.21100 16-QAM RB 50)

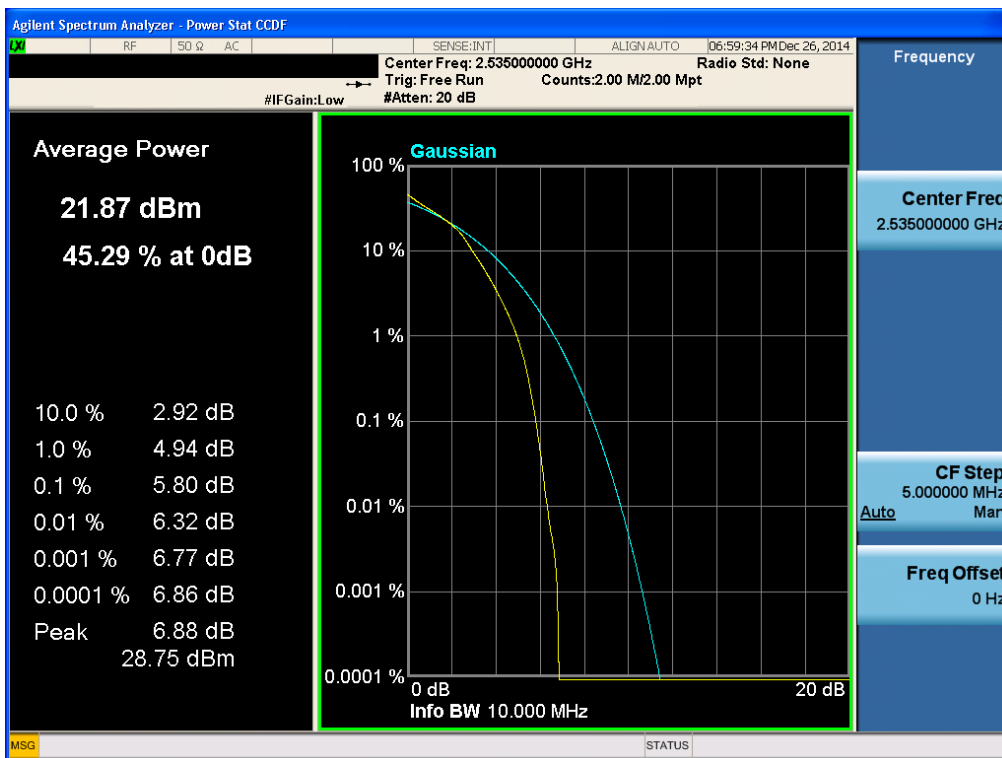

BAND7. Peak to Average Ratio Plot (15MHz Ch.21100 QPSK RB 75)

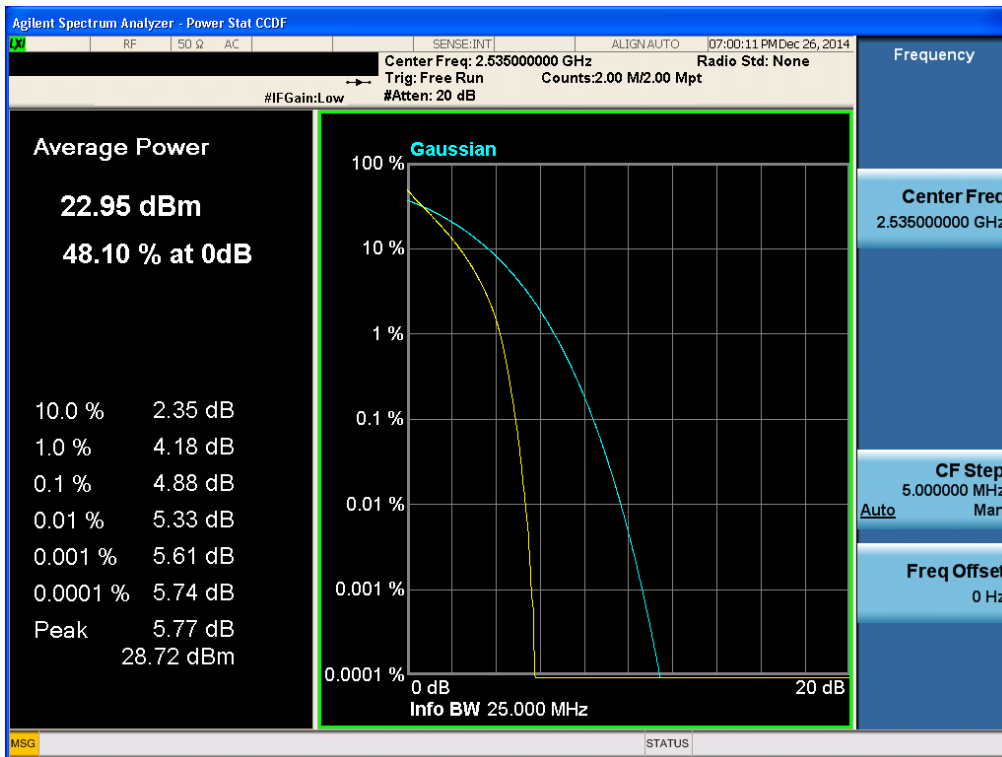

BAND7. Peak to Average Ratio Plot (15MHz Ch.21100 16-QAM RB 75)

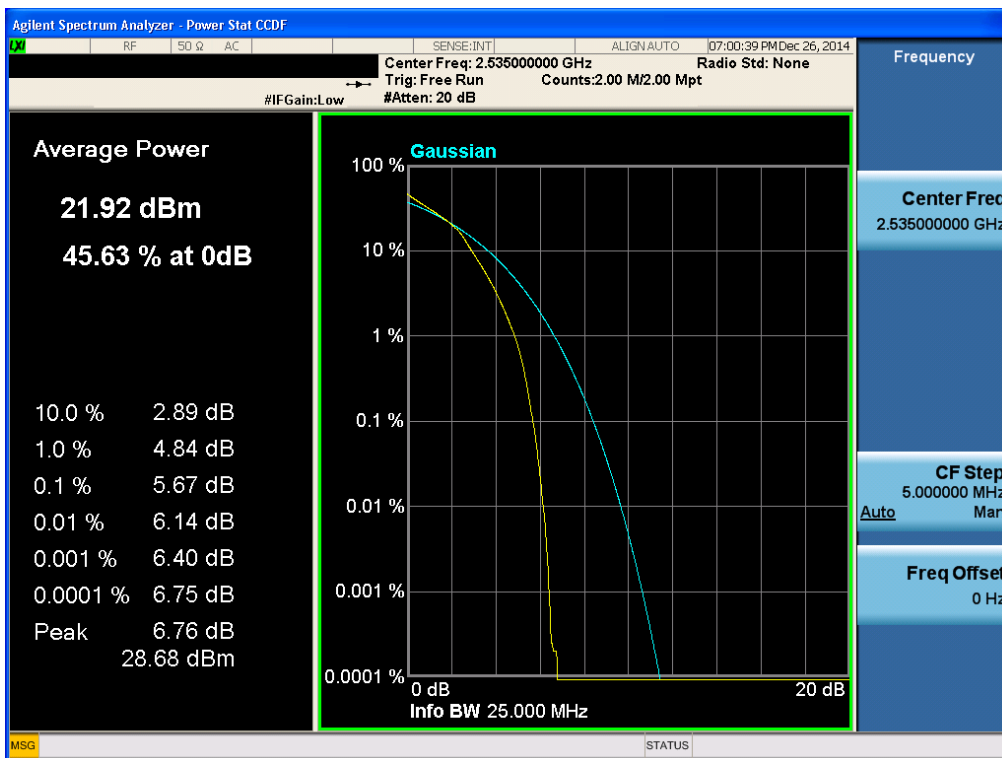

BAND7. Peak to Average Ratio Plot (20MHz Ch.21100 QPSK RB 100)

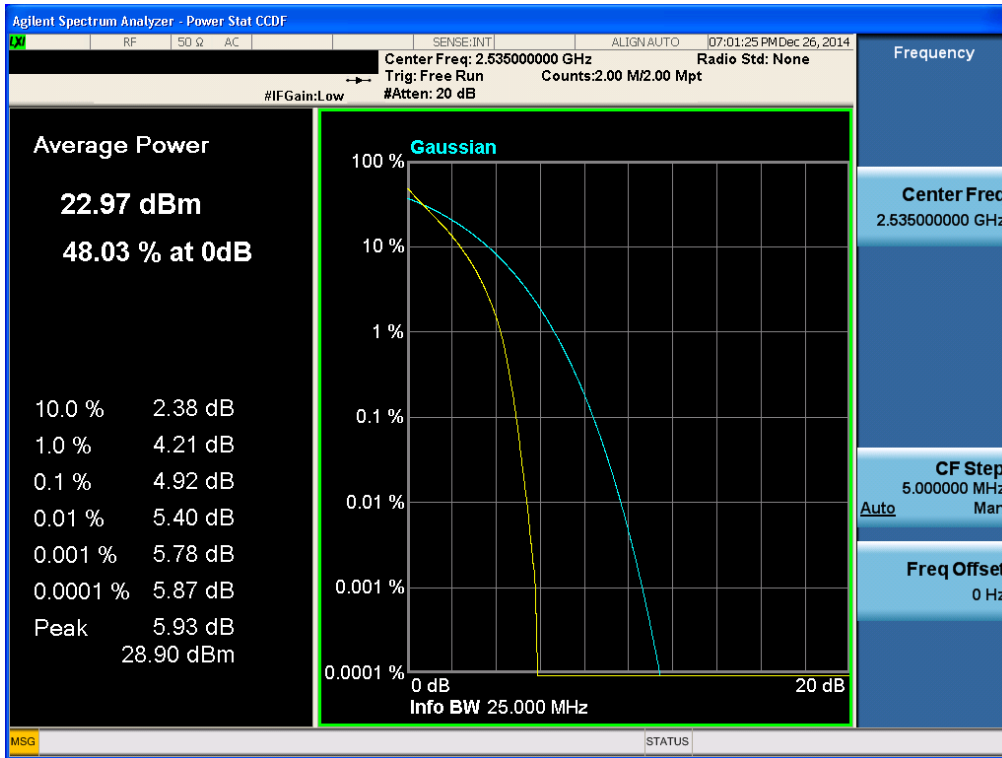

BAND7. Peak to Average Ratio Plot (20MHz Ch.21100 16-QAM RB 100)

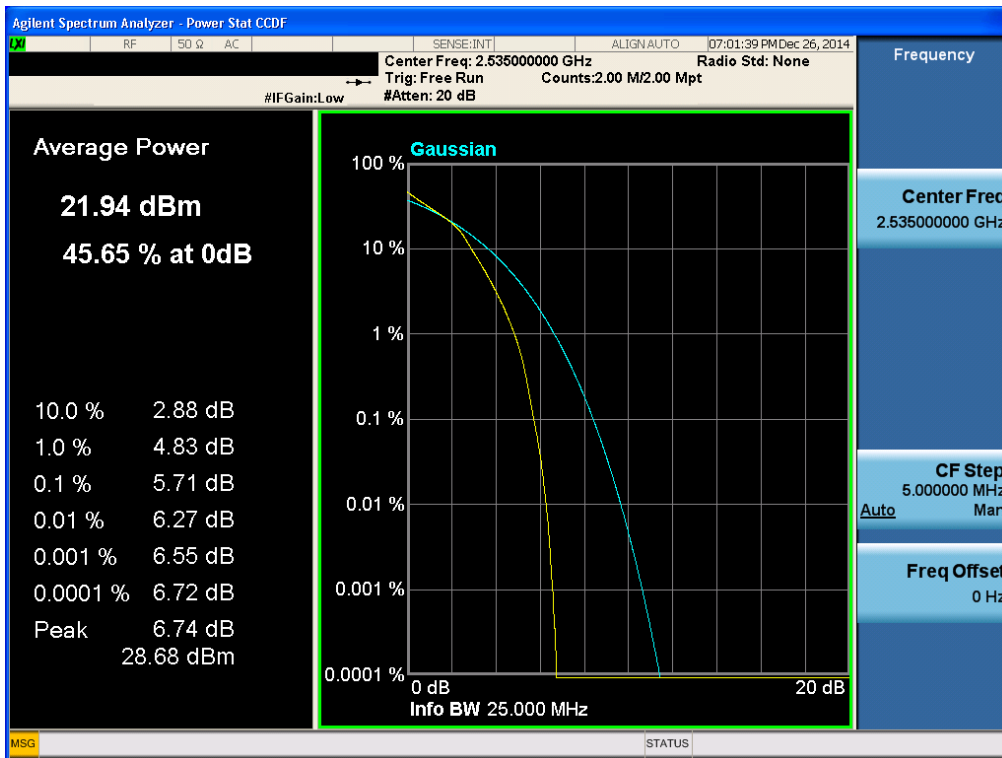

BAND7. Low Channel Edge Plot (5MHz Ch.20775 QPSK RB 25)

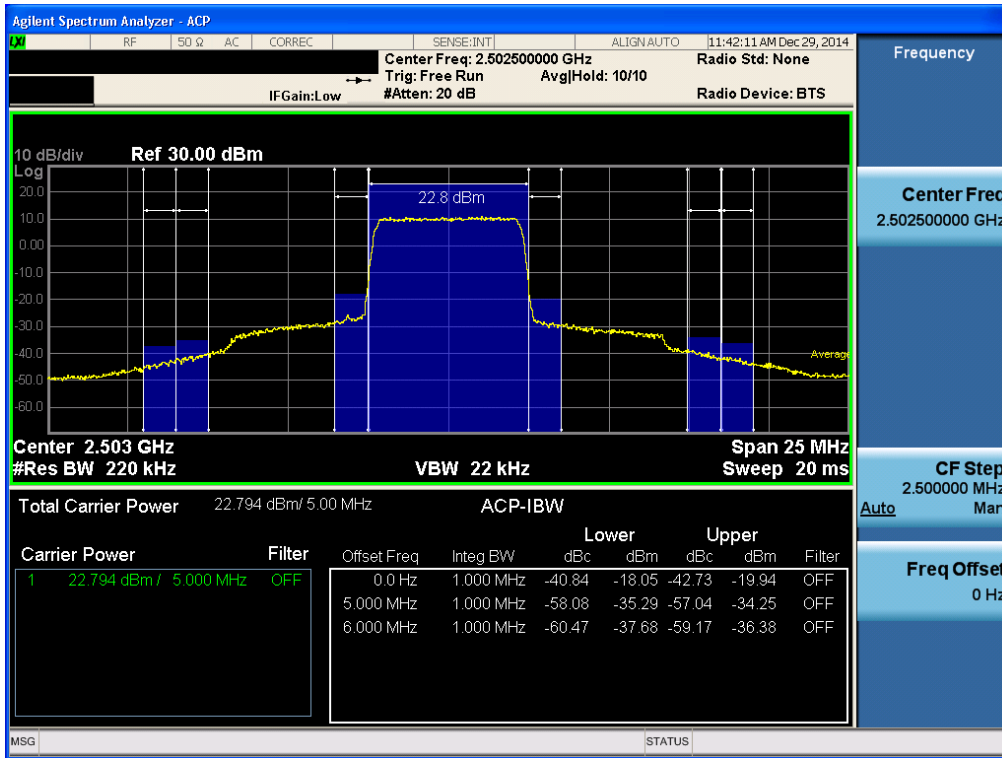

BAND7. Mid Channel Edge Plot (5MHz Ch.21100 QPSK RB 25)

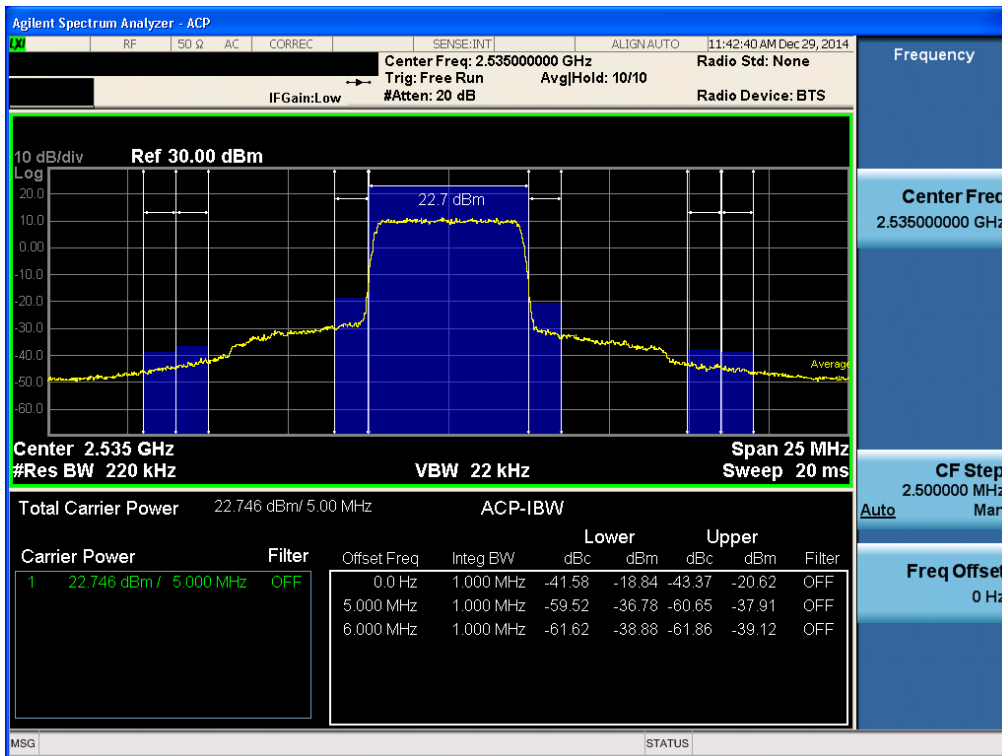

BAND7. High Channel Edge Plot (5MHz Ch.21425 QPSK RB 25)

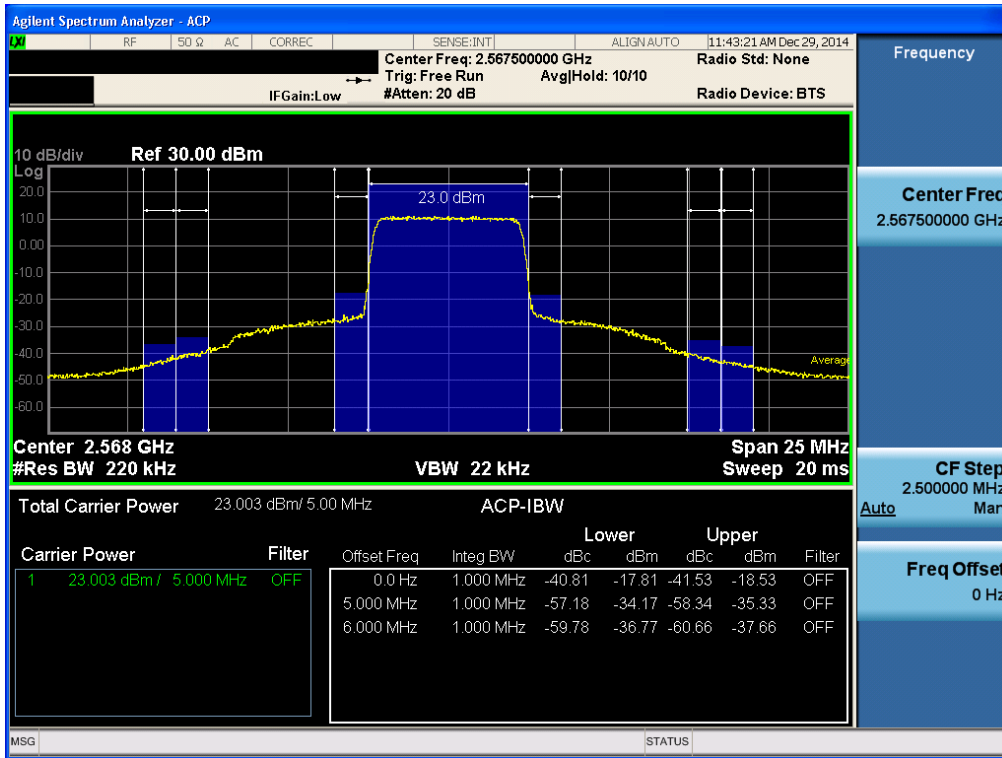

BAND7. Low Channel Edge Plot (10MHz Ch.20800 QPSK RB 50)

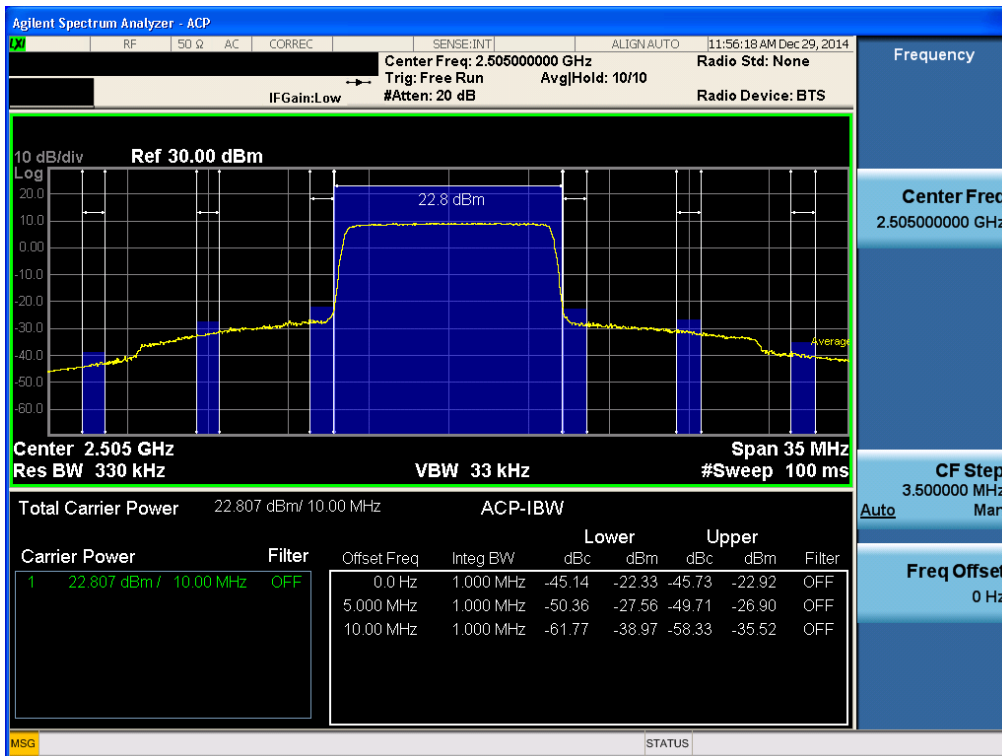

BAND7. Mid Channel Edge Plot (10MHz Ch.21100 QPSK RB 50)

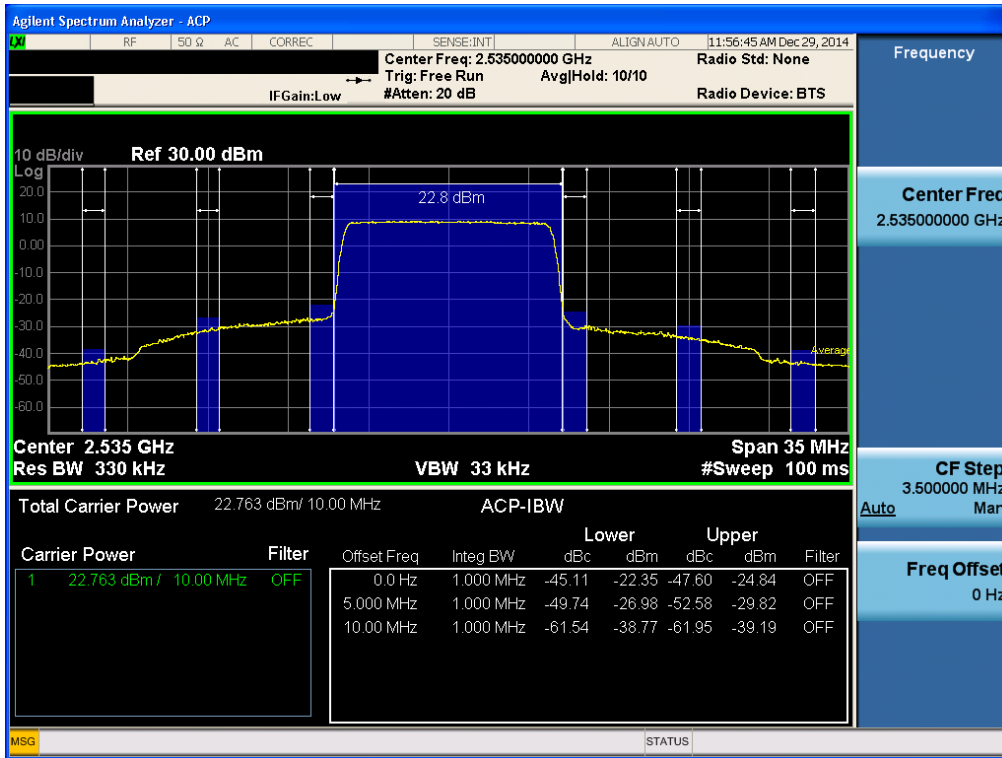

BAND7. High Channel Edge Plot (10MHz Ch.21400 QPSK RB 50)

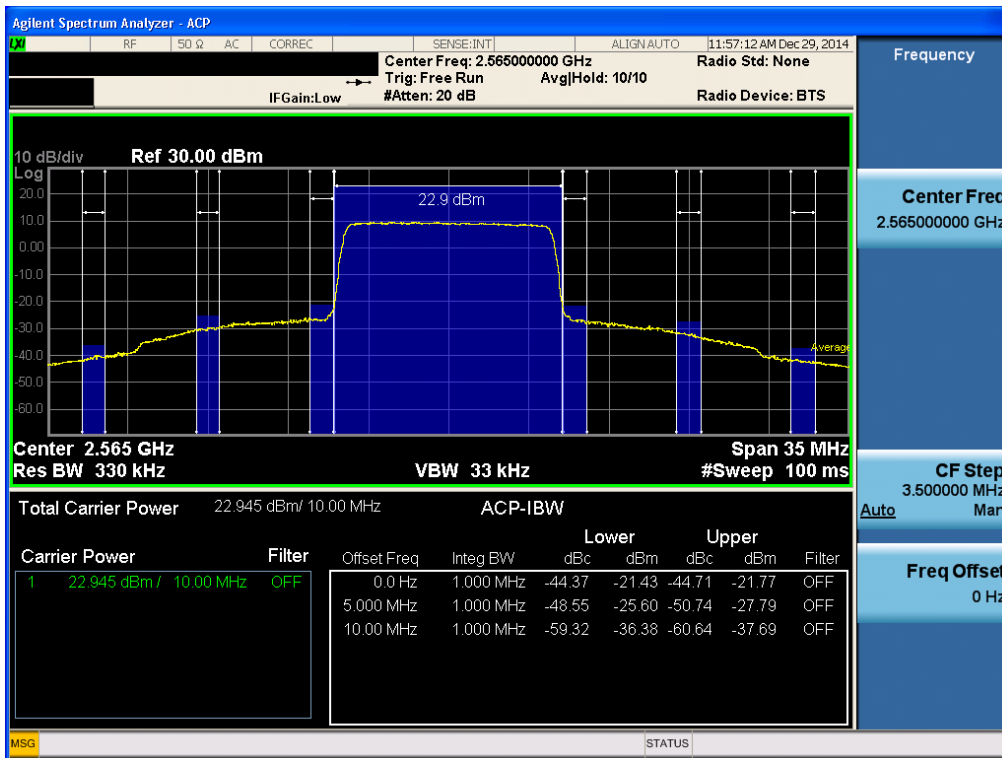

BAND7. Low Channel Edge Plot (15MHz Ch.20825 QPSK RB 75)

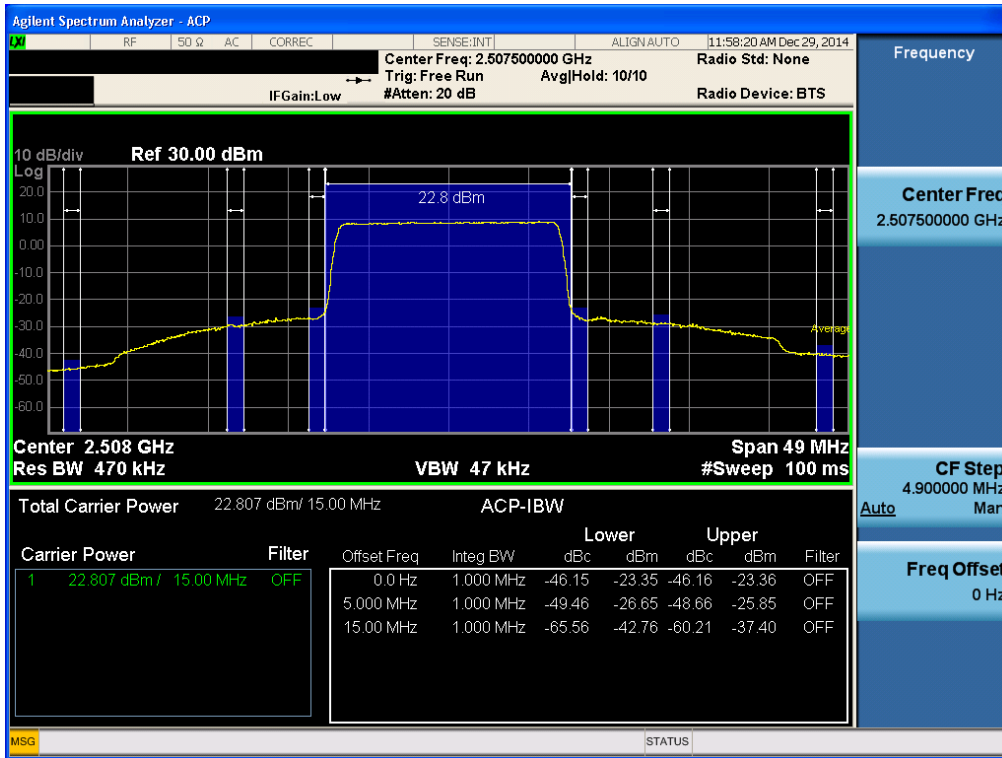

BAND7. Mid Channel Edge Plot (15MHz Ch.21100 QPSK RB 75)

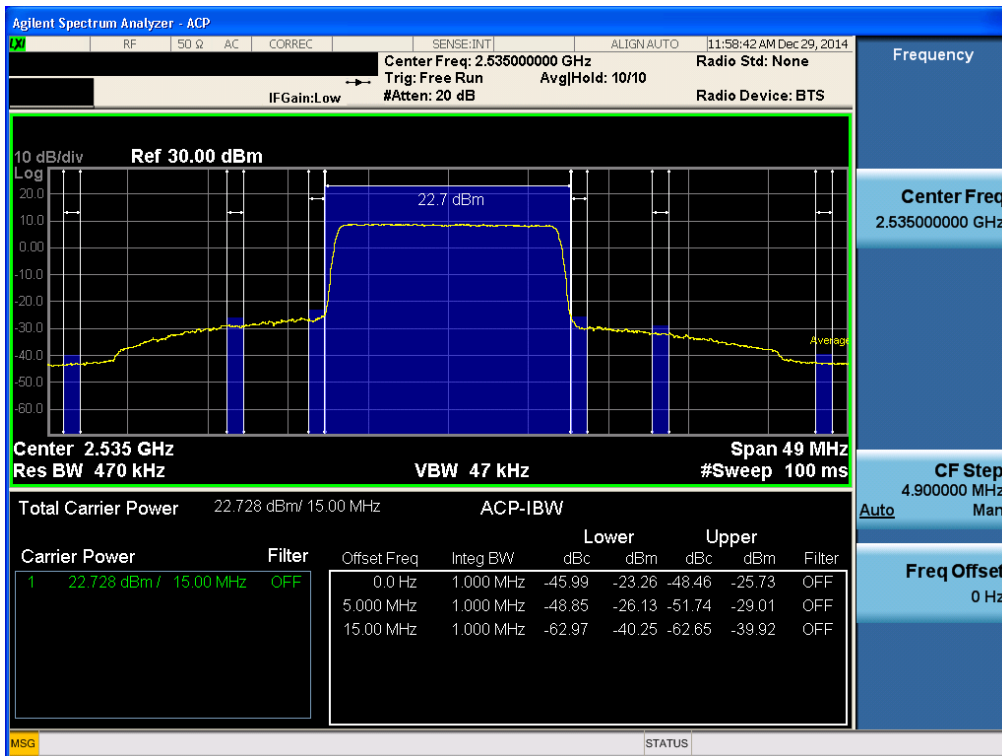

BAND7. High Channel Edge Plot (15MHz Ch.21375 QPSK RB 75)

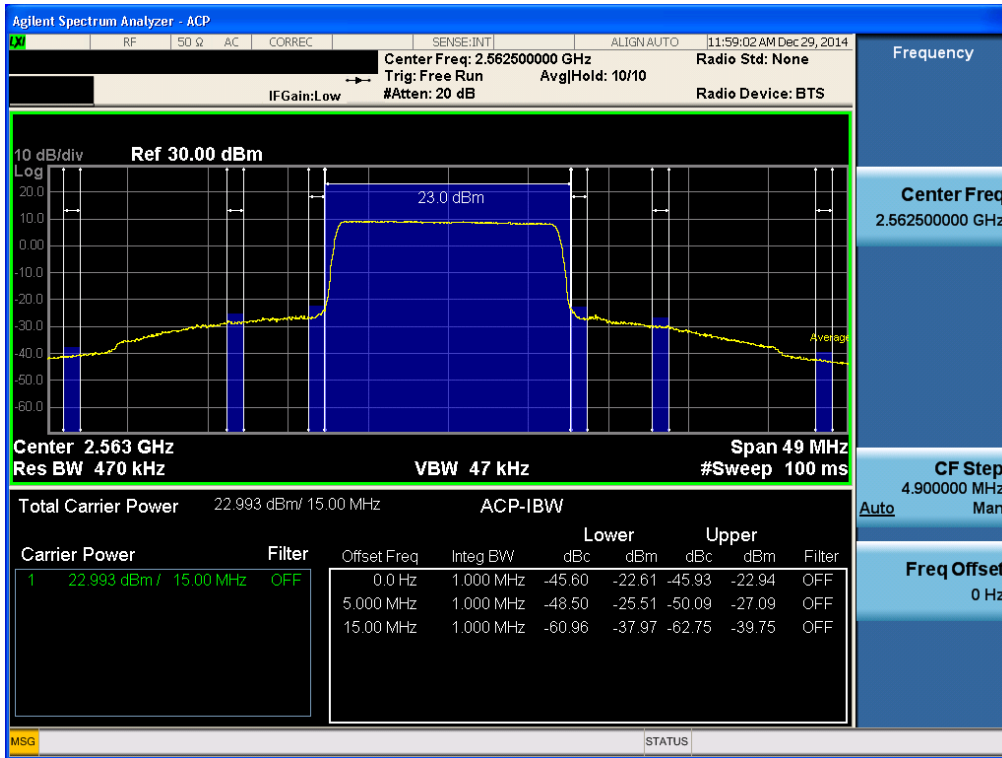

BAND7. Low Channel Edge Plot (20MHz Ch.20850 QPSK RB 100)

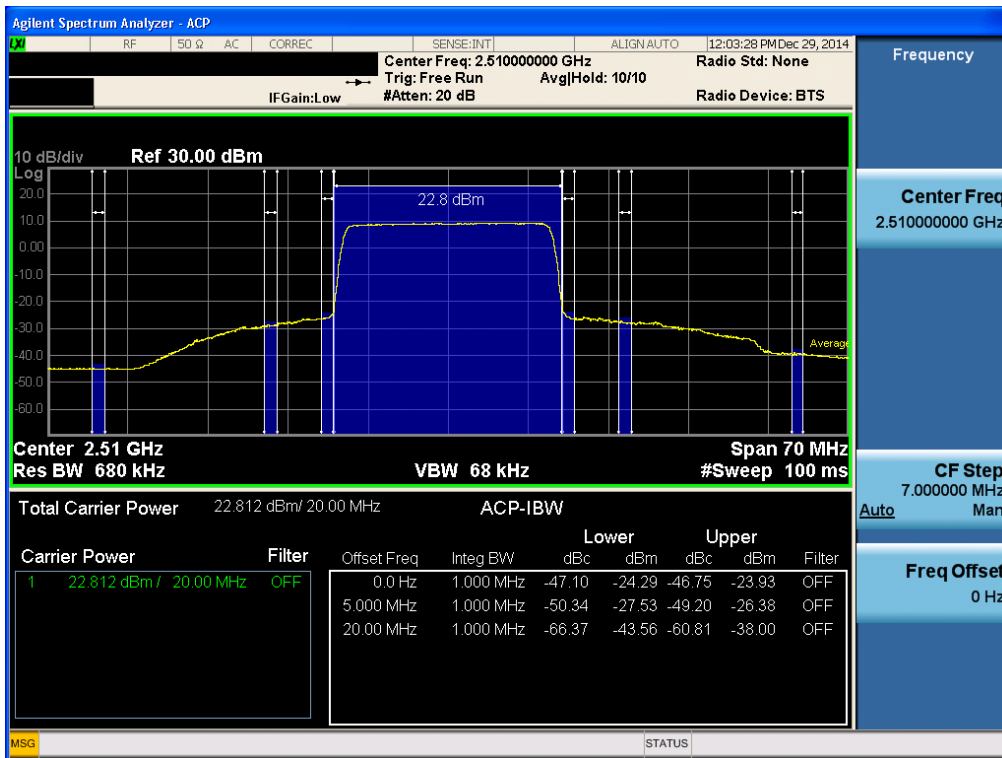

BAND7. Mid Channel Edge Plot (20MHz Ch.21100 QPSK RB 100)

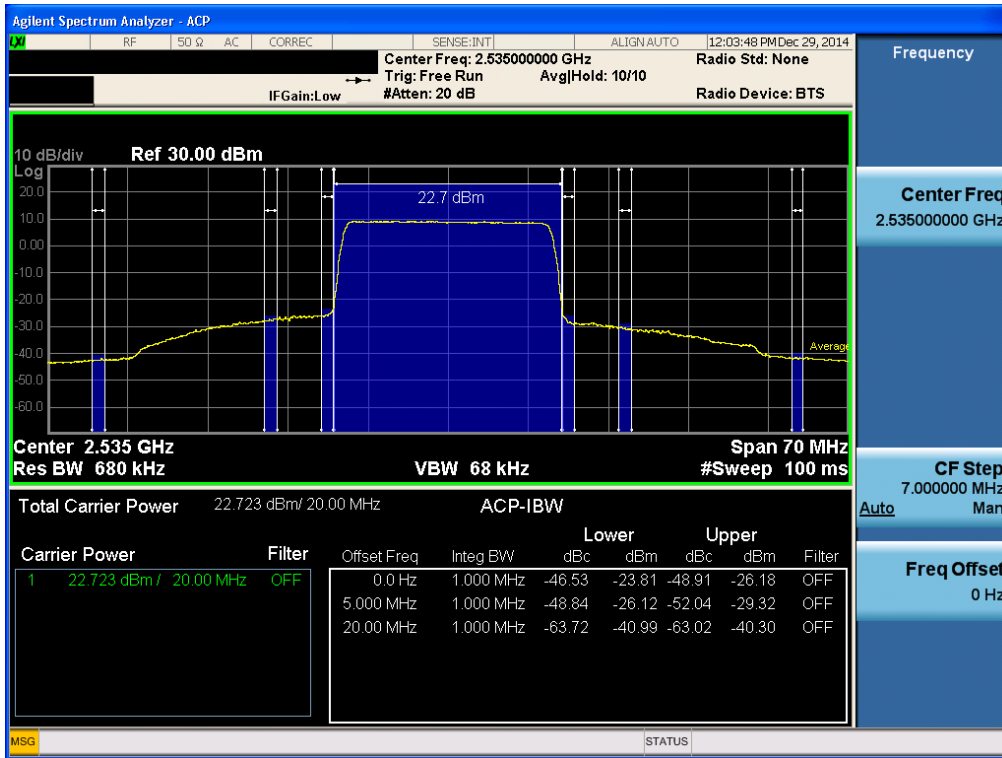

BAND7. High Channel Edge Plot (20MHz Ch.21350 QPSK RB 100)

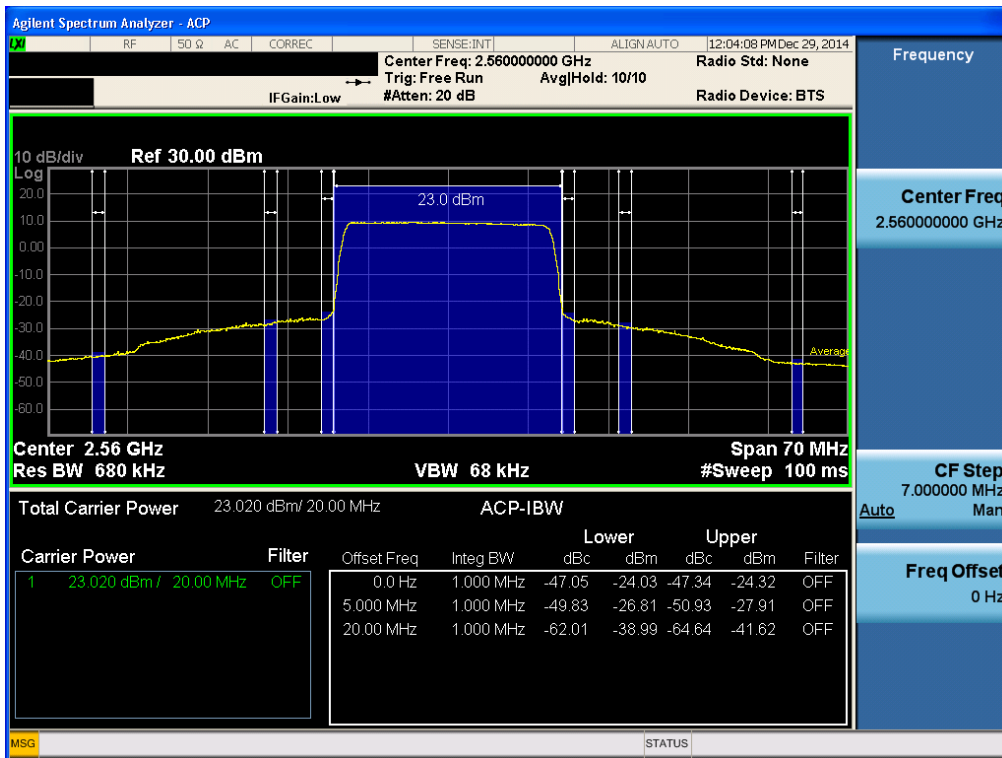

BAND7. Conducted Spurious Plot 1 (5MHz Ch.20775 QPSK RB 1, Offset 0)

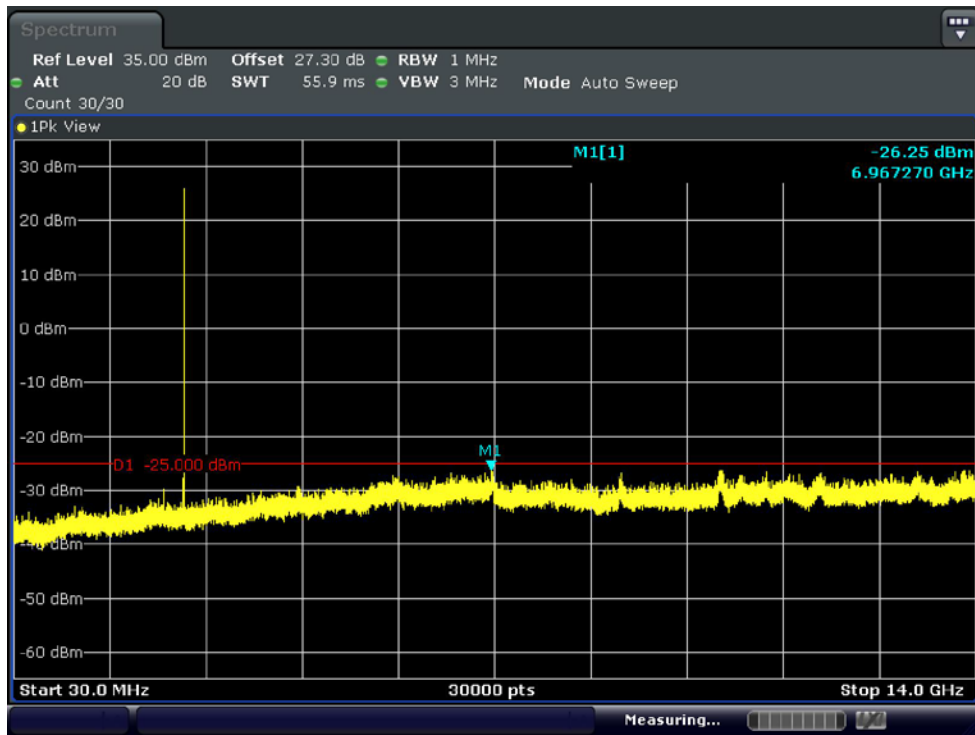

BAND7. Conducted Spurious Plot 2 (5MHz Ch.20775 QPSK RB 1, Offset 0)

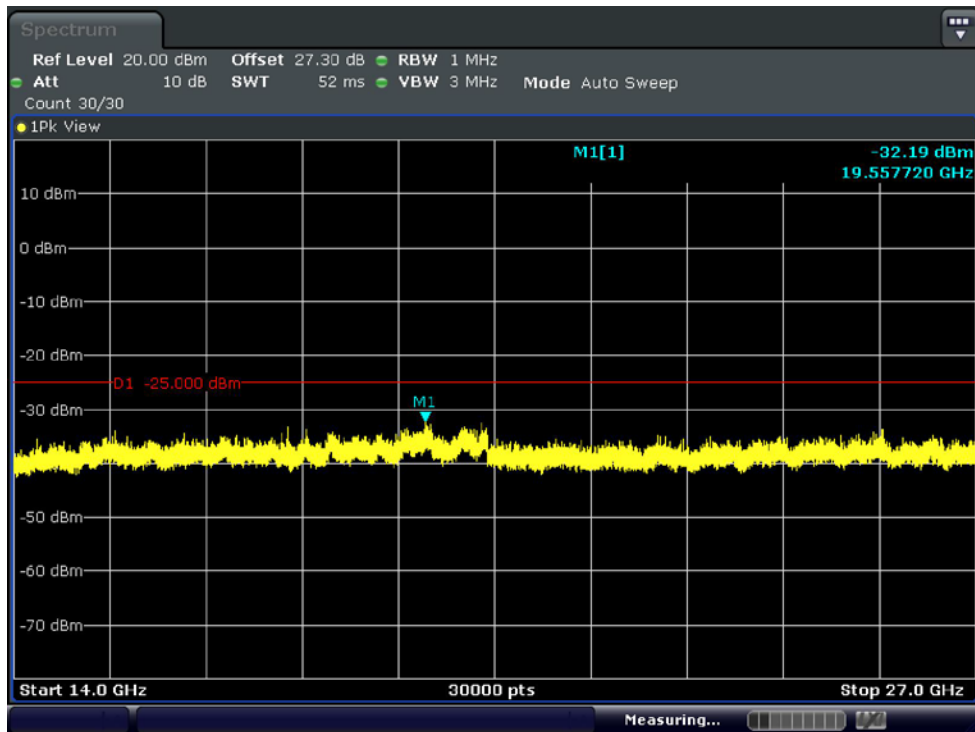

BAND7. Conducted Spurious Plot 1 (5MHz Ch.21425 QPSK RB 1, Offset 0)

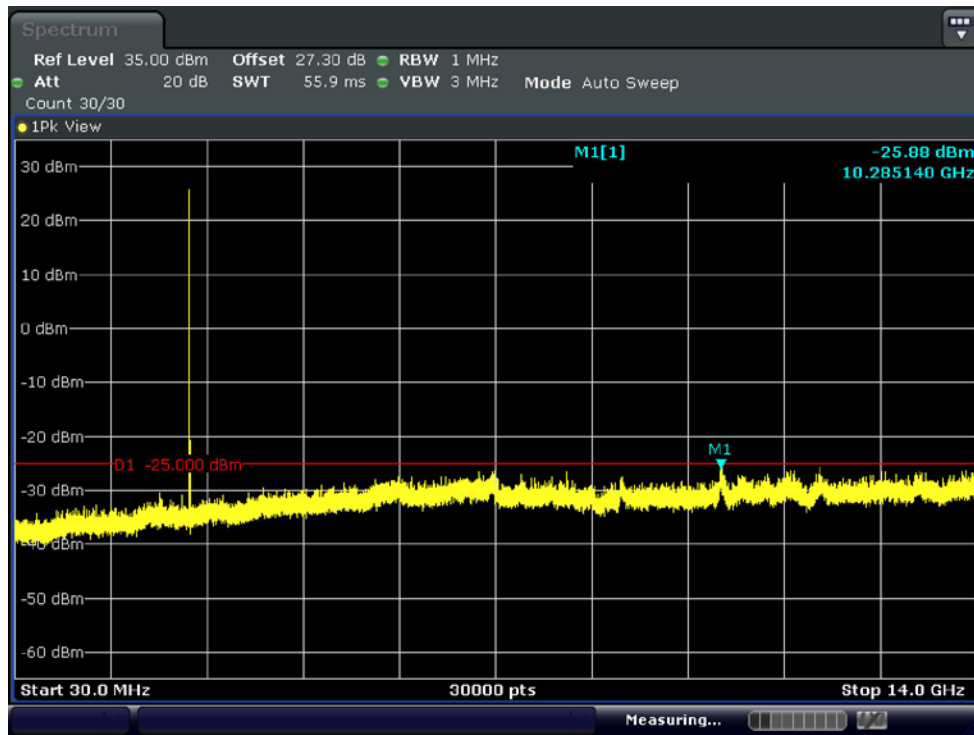

BAND7. Conducted Spurious Plot 2 (5MHz Ch.21425 QPSK RB 1, Offset 0)

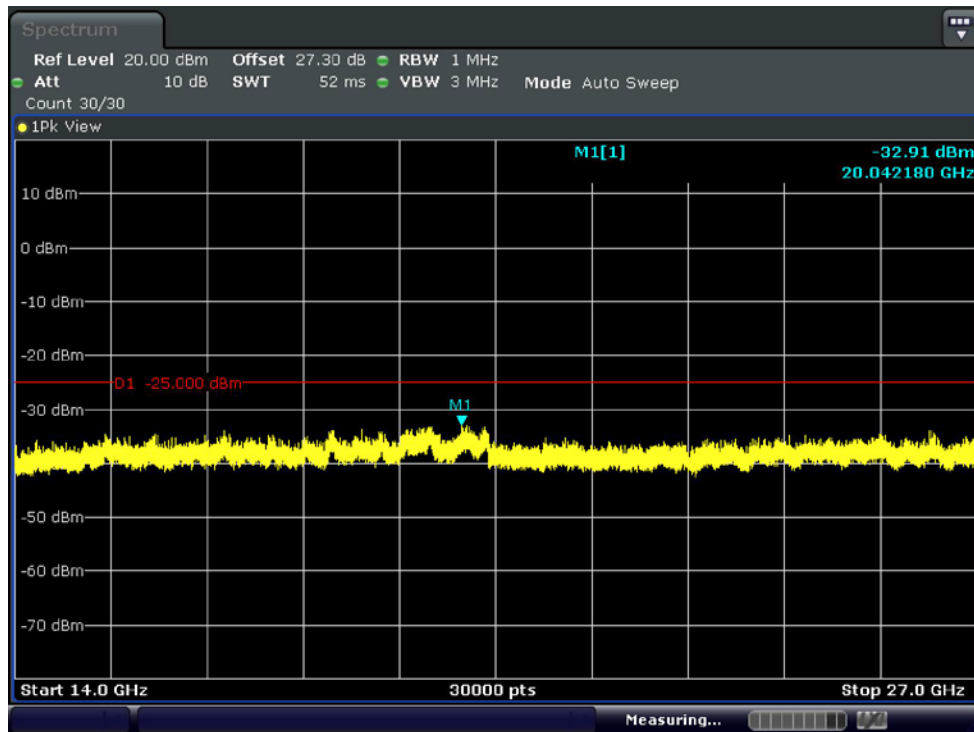

BAND7. Conducted Spurious Plot 1 (10MHz Ch.20800 QPSK RB 1, Offset 0)

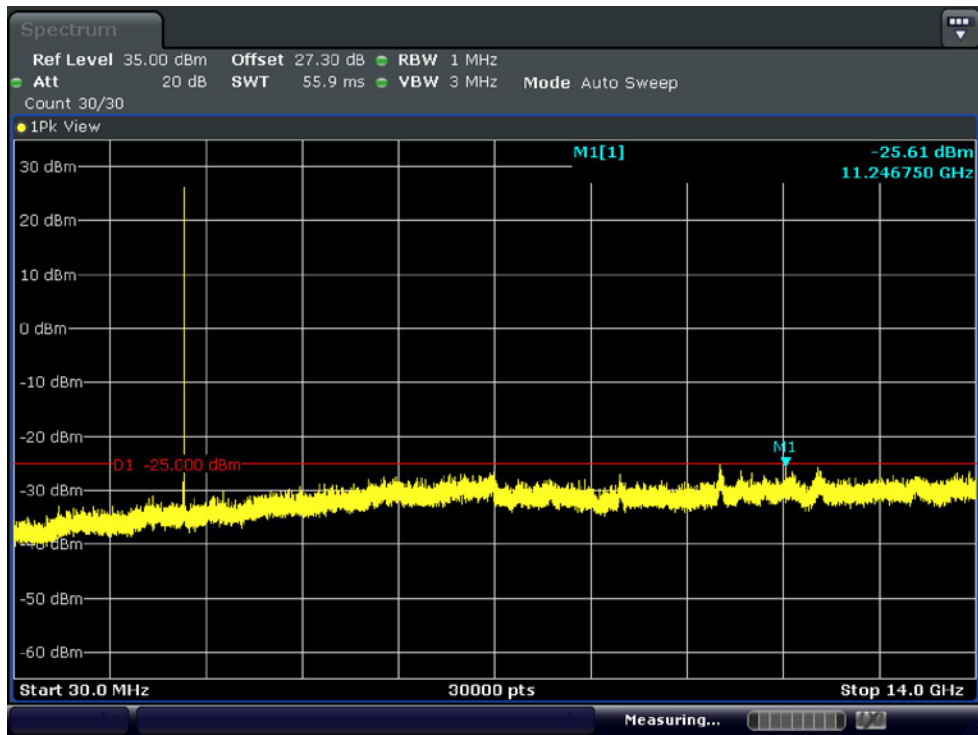

BAND7. Conducted Spurious Plot 2 (10MHz Ch.20800 QPSK RB 1, Offset 0)

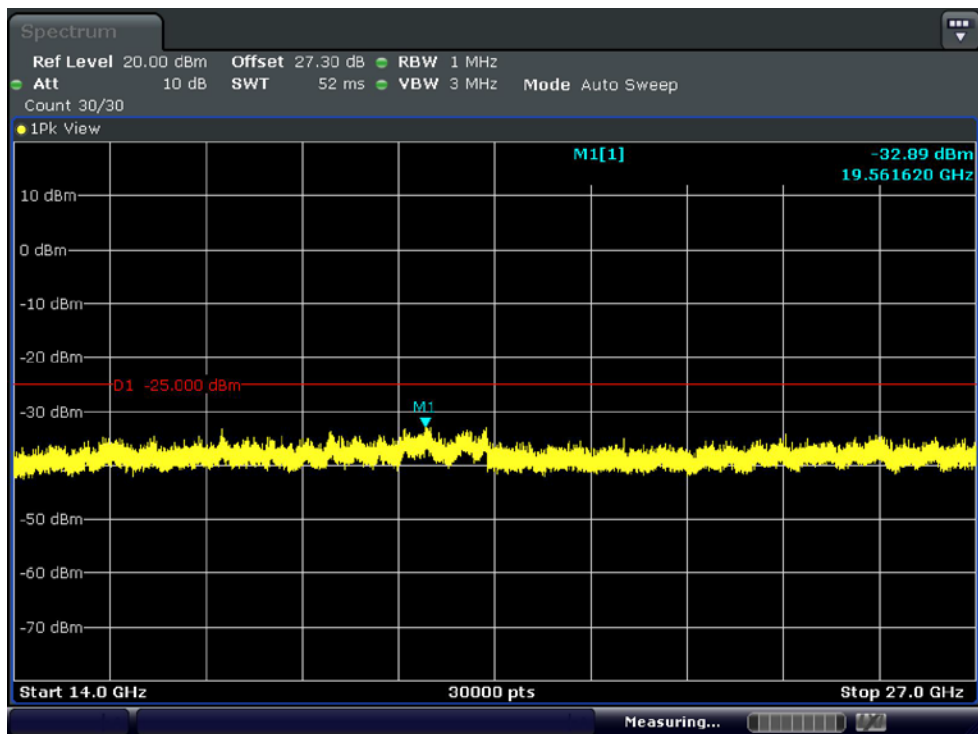

BAND7. Conducted Spurious Plot 1 (10MHz Ch.21100 QPSK RB 1, Offset 0)

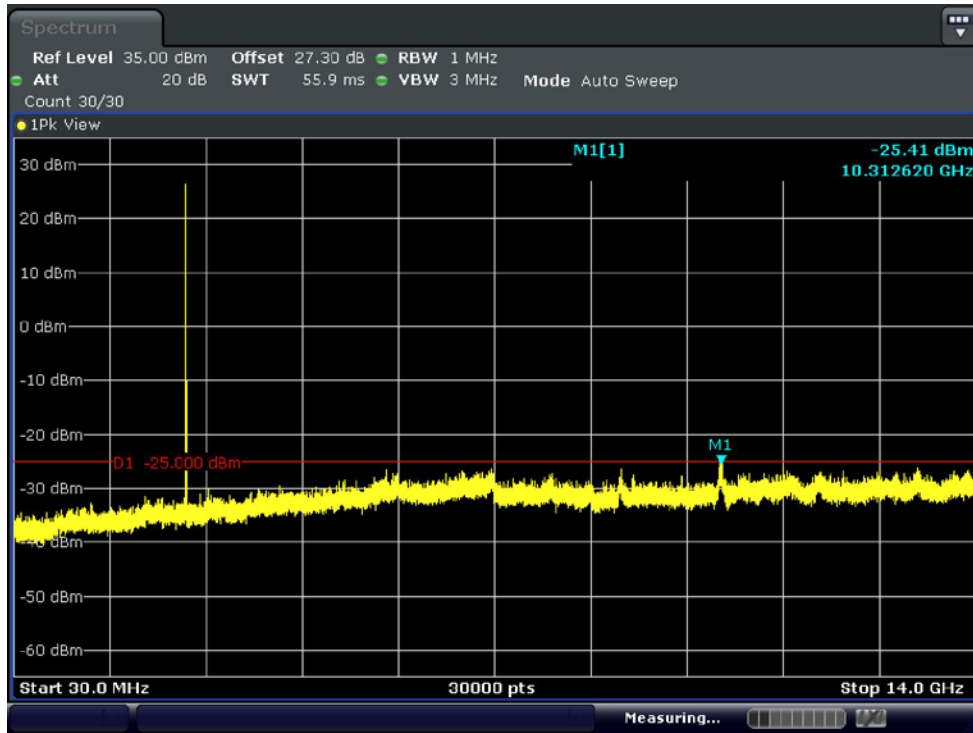

BAND7. Conducted Spurious Plot 2 (10MHz Ch.21100 QPSK RB 1, Offset 0)

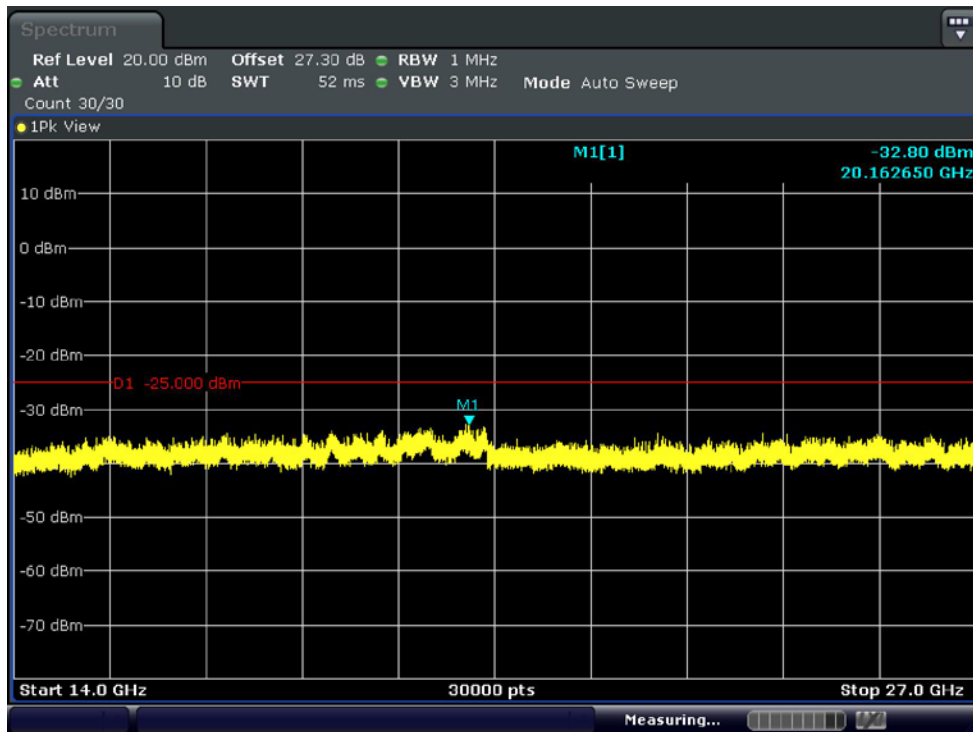

BAND7. Conducted Spurious Plot 1 (10MHz Ch.21400 QPSK RB 1, Offset 0)

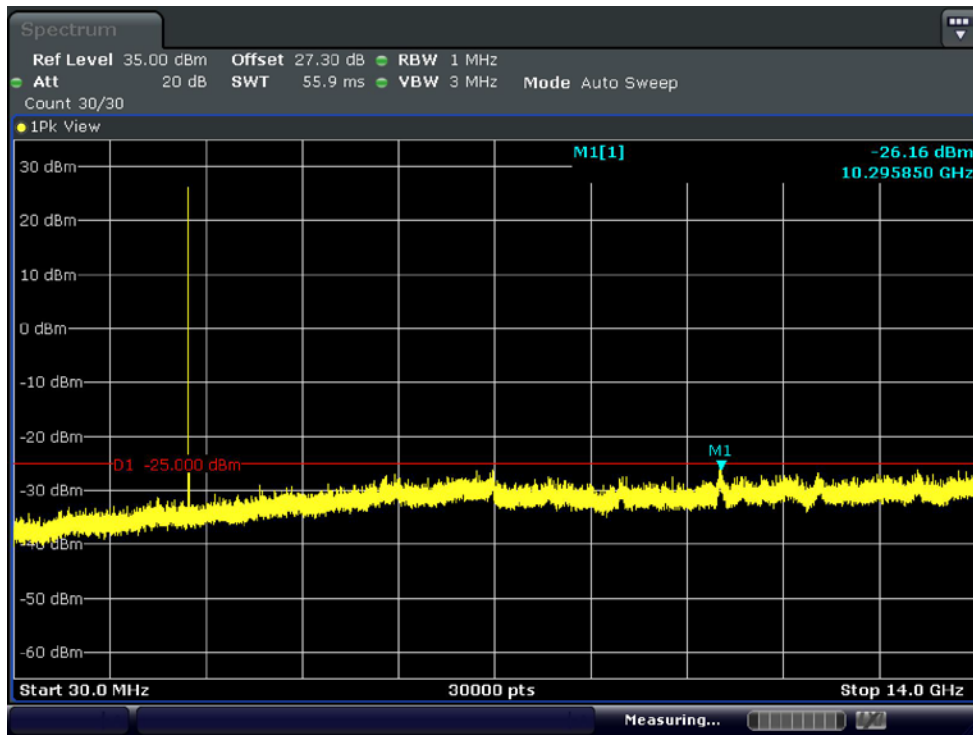

BAND7. Conducted Spurious Plot 2 (10MHz Ch.21400 QPSK RB 1, Offset 0)

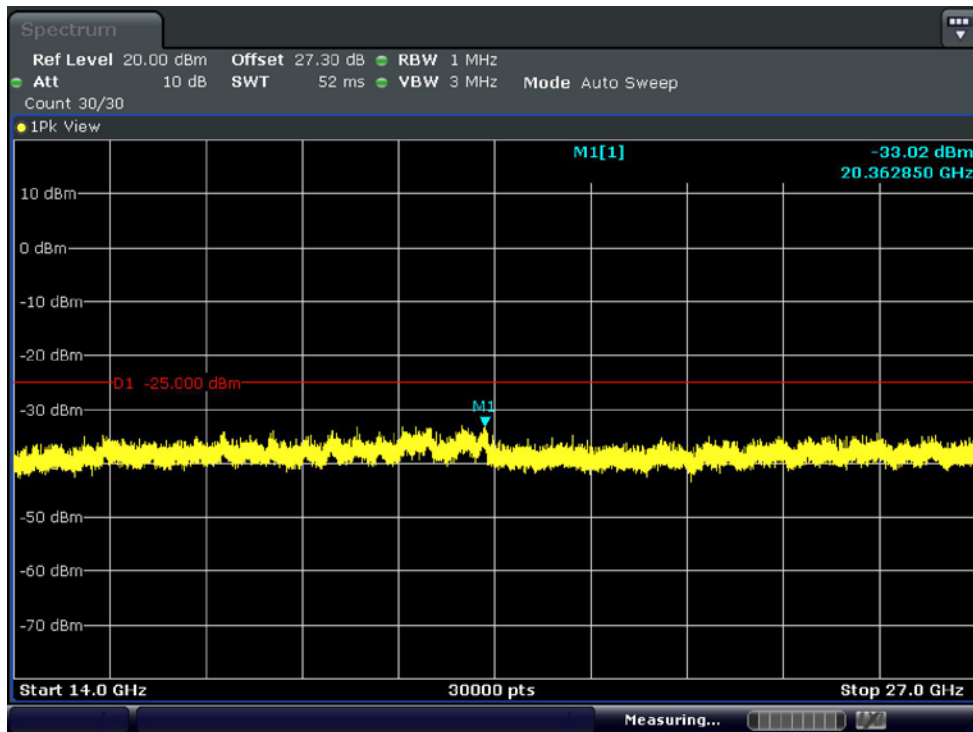

BAND7. Conducted Spurious Plot 1 (15MHz Ch.20825 QPSK RB 1, Offset 0)

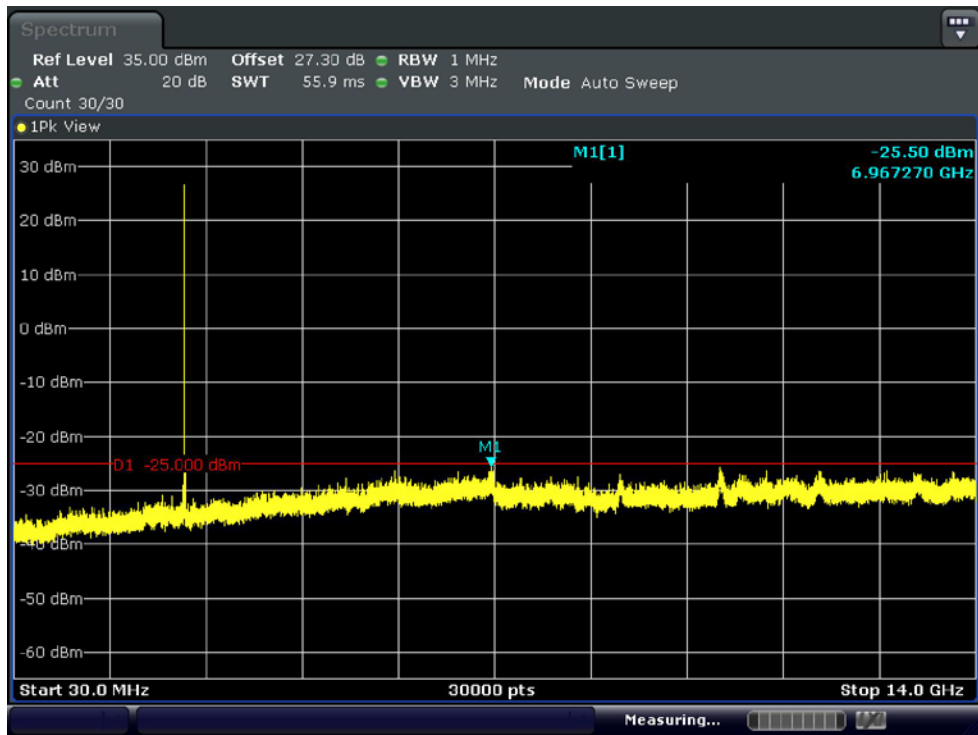

BAND7. Conducted Spurious Plot 2 (15MHz Ch.20825 QPSK RB 1, Offset 0)

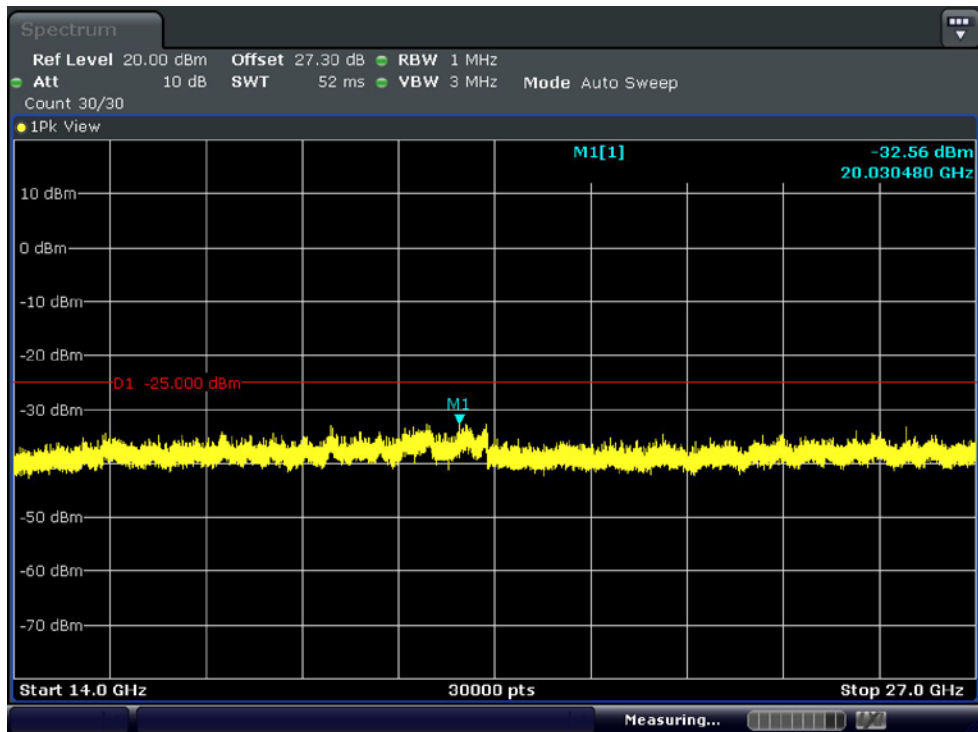

BAND7. Conducted Spurious Plot 1 (15MHz Ch.21100 QPSK RB 1, Offset 0)

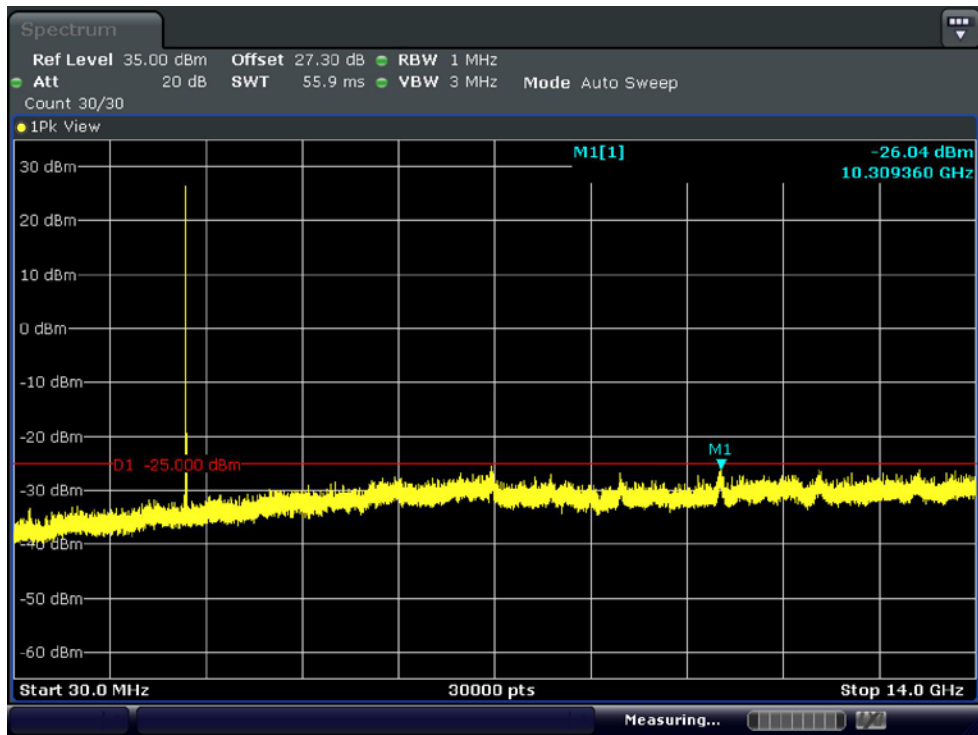

BAND7. Conducted Spurious Plot 2 (15MHz Ch.21100 QPSK RB 1, Offset 0)

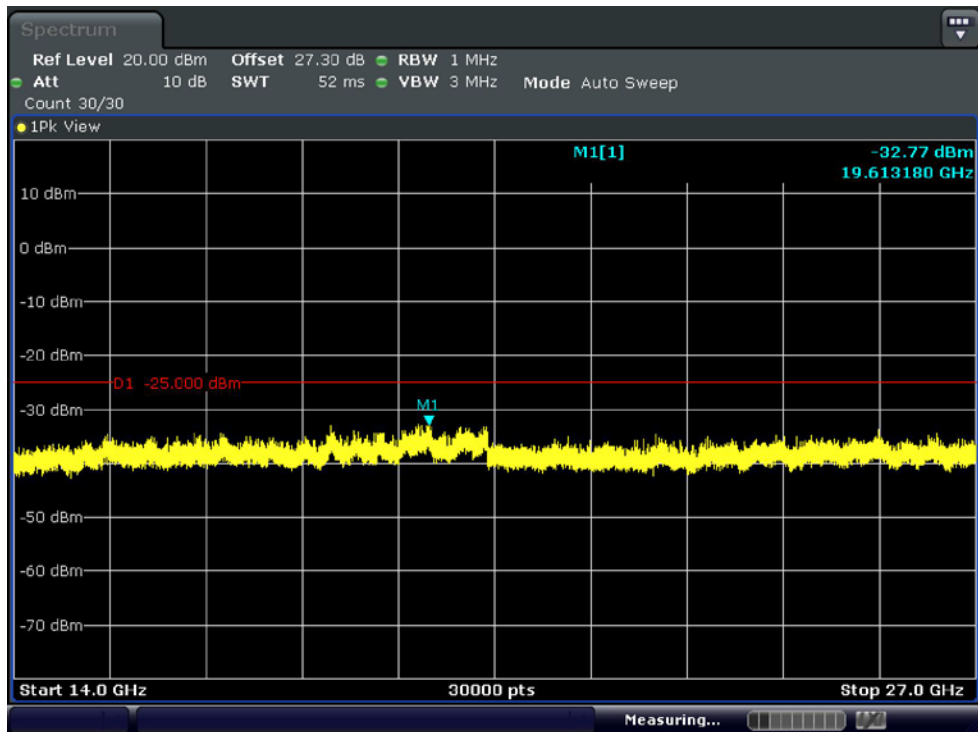

BAND7. Conducted Spurious Plot 1 (15MHz Ch.21375 QPSK RB 1, Offset 0)

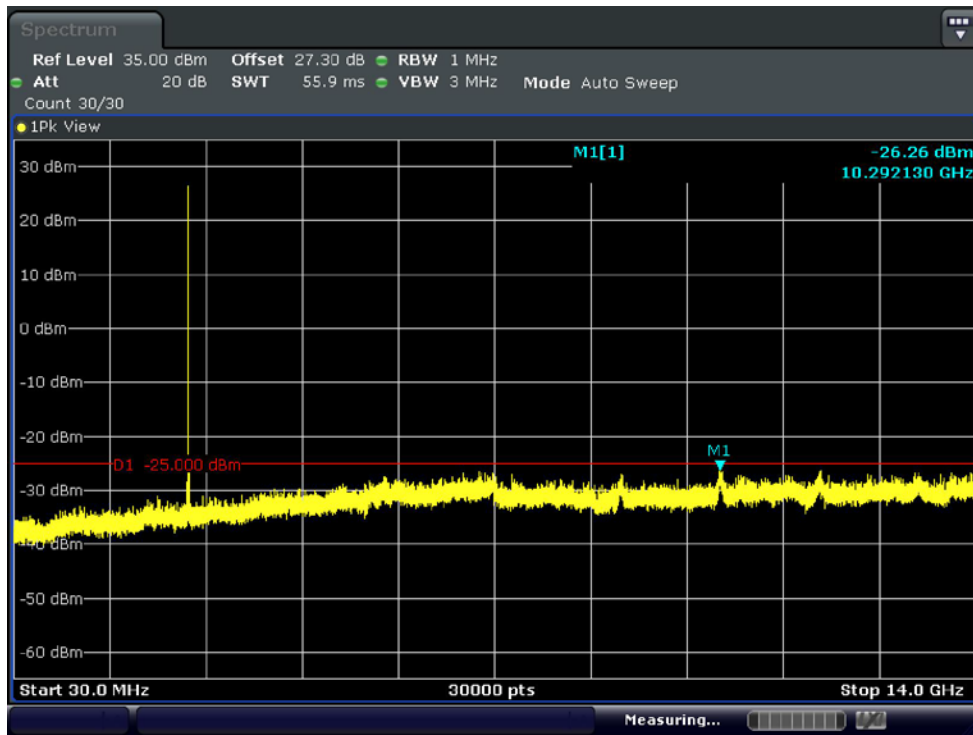

BAND7. Conducted Spurious Plot 2 (15MHz Ch.21375 QPSK RB 1, Offset 0)

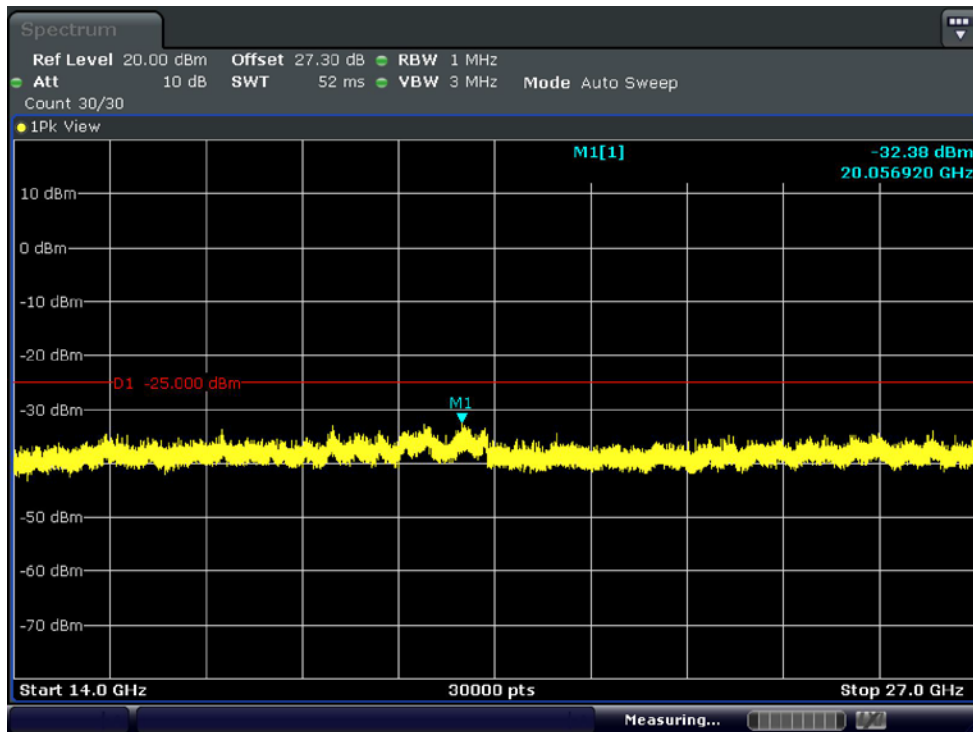

BAND7. Conducted Spurious Plot 1 (20MHz Ch.20850 QPSK RB 1, Offset 0)

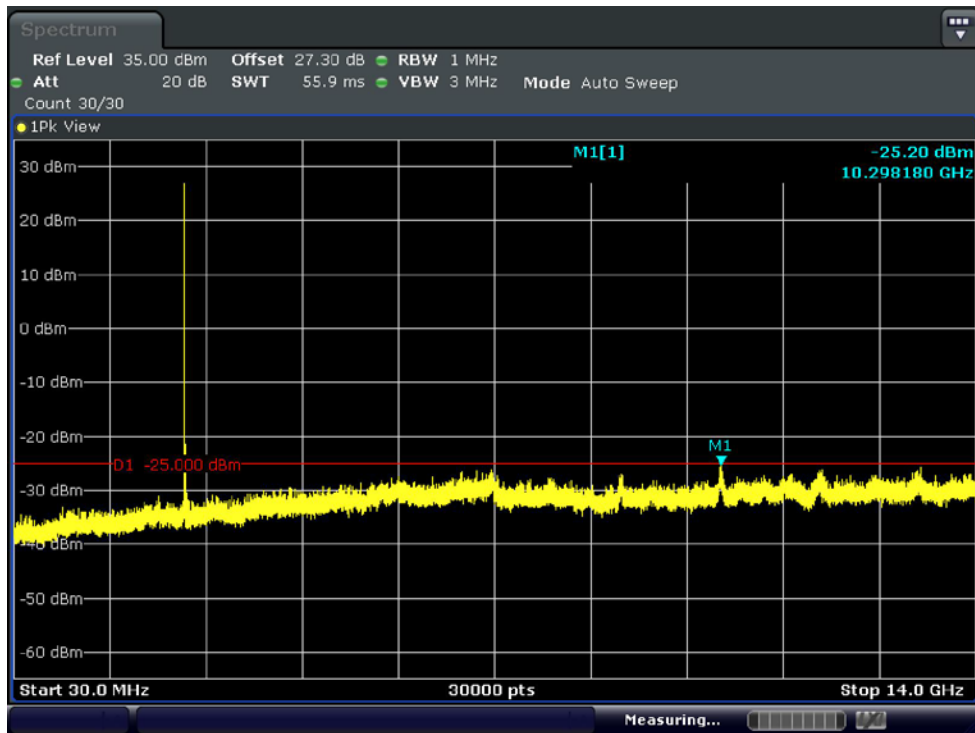

BAND7. Conducted Spurious Plot 2 (20MHz Ch.20850 QPSK RB 1, Offset 0)

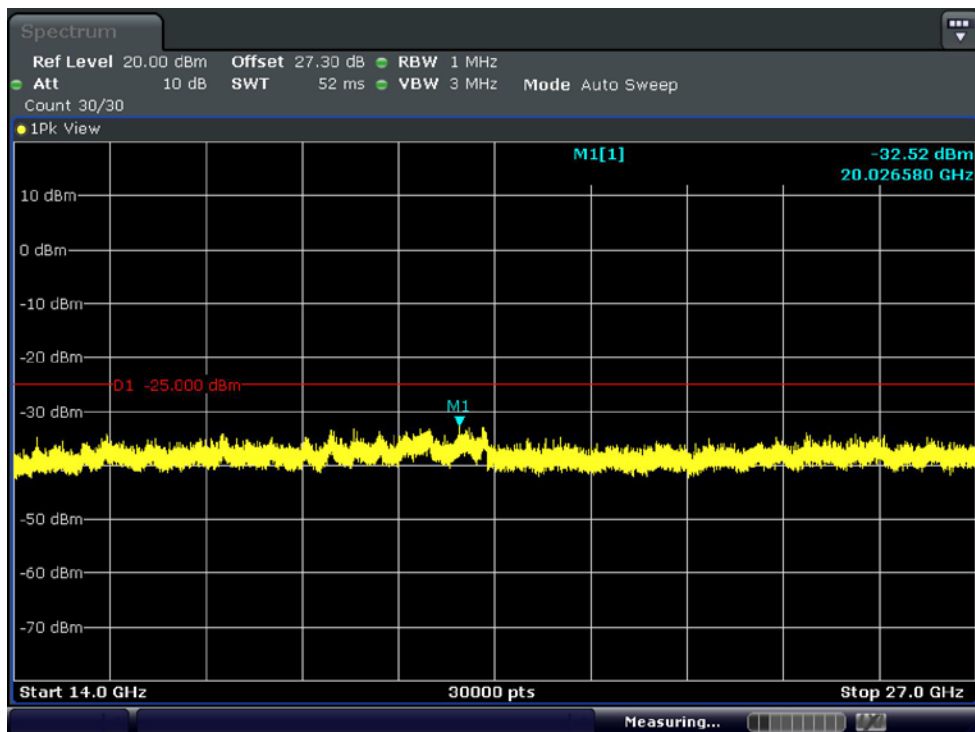

BAND7. Conducted Spurious Plot 1 (20MHz Ch.21100 QPSK RB 1, Offset 0)

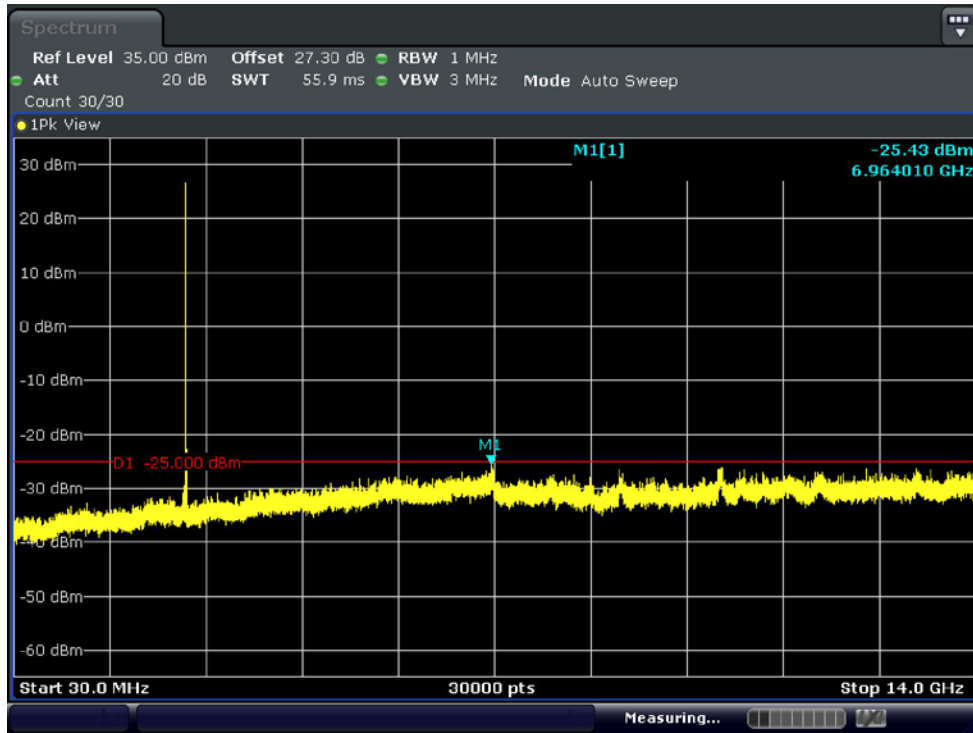

BAND7. Conducted Spurious Plot 2 (20MHz Ch.21100 QPSK RB 1, Offset 0)

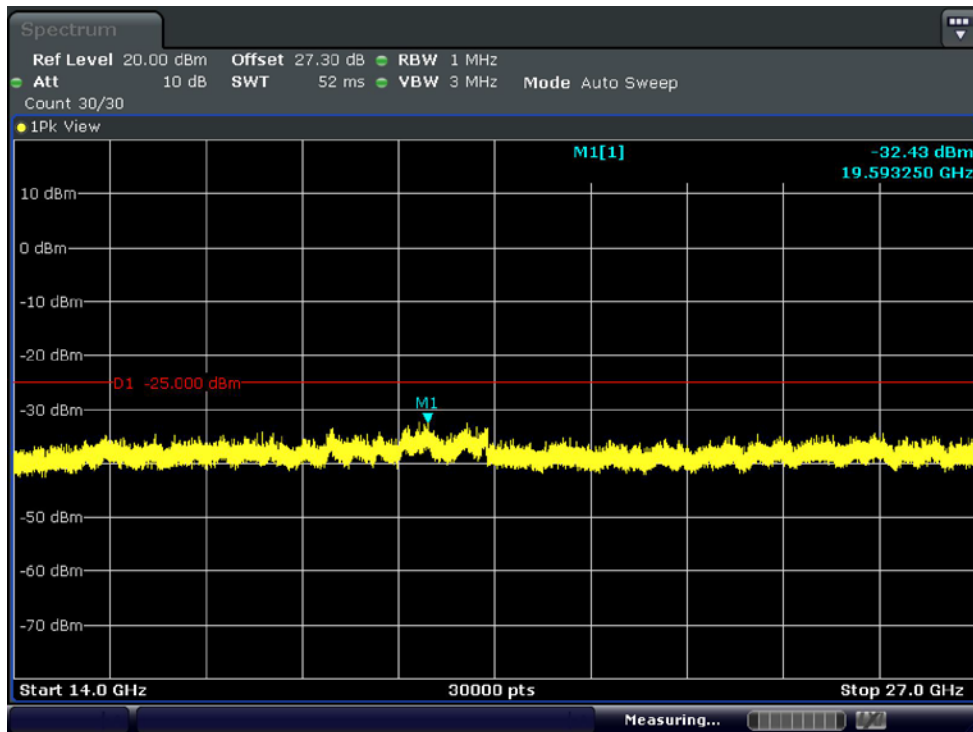

BAND7. Conducted Spurious Plot 1 (20MHz Ch.21350 QPSK RB 1, Offset 0)

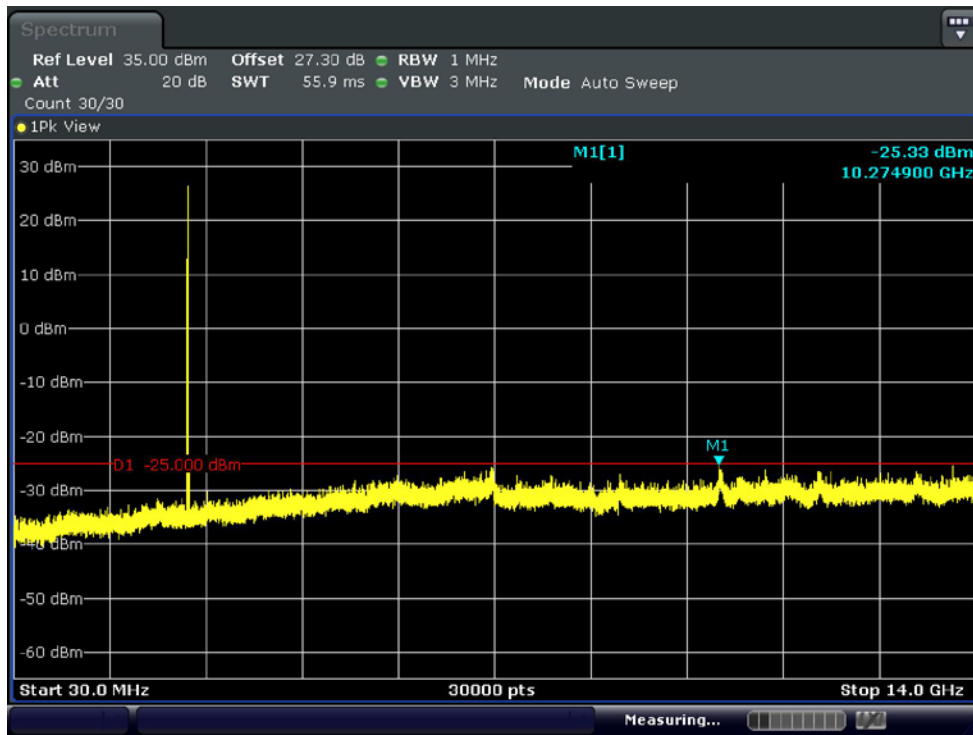

BAND7. Conducted Spurious Plot 2 (20MHz Ch.21350 QPSK RB 1, Offset 0)

