

## HEARING AID COMPATIBILITY

**Applicant Name:**  
 LG Electronics MobileComm U.S.A., Inc.  
 1000 Sylvan Avenue  
 Englewood Cliffs, NJ 07632  
 United States

**Date of Testing:**  
 January 12-15, 2015  
**Test Site/Location:**  
 PCTEST Lab, Columbia, MD, USA  
**Test Report Serial No.:**  
 0Y1501120071-R1.ZNF

<b>FCC ID:</b>	<b>ZNFH950</b>
<b>APPLICANT:</b>	<b>LG ELECTRONICS MOBILECOMM U.S.A., INC.</b>

**Scope of Test:** RF Emissions Testing  
**Application Type:** Certification  
**FCC Rule Part(s):** §20.19(b)  
**HAC Standard:** ANSI C63.19-2011  
**EUT Type:** Portable Handset  
**Model(s):** LG-H950, LGH950, H950  
**Test Device Serial No.:** *Pre-Production Sample [S/N: 1301-4]*

<b>C63.19-2011 HAC Category:</b>	<b>M3 (RF EMISSIONS CATEGORY)</b>
----------------------------------	-----------------------------------



This revised Test Report (S/N: 0Y1501120071-R1.ZNF) supersedes and replaces the previously issued test report on the same subject device for the same type of testing as indicated. Please discard or destroy the previously issued test report(s) and dispose of it accordingly.

This wireless portable device has been shown to be hearing-aid compatible under the above rated category, specified in ANSI/IEEE Std. C63.19-2011 and has been tested in accordance with the specified measurement procedures. Hearing-Aid Compatibility is based on the assumption that all production units will be designed electrically identical to the device tested in this report. Test results reported herein relate only to the item(s) tested.

I attest to the accuracy of data. All measurements reported herein were performed by me or were made under my supervision and are correct to the best of my knowledge and belief. I assume full responsibility for the completeness of these measurements and vouch for the qualifications of all persons taking them.

  
 Randy Ortañez  
 President





FCC ID: ZNFH950		HAC (RF EMISSIONS) TEST REPORT		Reviewed by: Quality Manager
Filename: 0Y1501120071-R1.ZNF	Test Dates: January 12-15, 2015	EUT Type: Portable Handset	Page 1 of 76	

# TABLE OF CONTENTS

---

1.	INTRODUCTION .....	3
2.	EUT DESCRIPTION .....	4
3.	ANSI/IEEE C63.19 PERFORMANCE CATEGORIES .....	5
4.	SYSTEM SPECIFICATIONS .....	6
5.	TEST PROCEDURE .....	11
6.	SYSTEM CHECK .....	13
7.	MODULATION INTERFERENCE FACTOR.....	16
8.	RF CONDUCTED POWER MEASUREMENTS.....	19
9.	JUSTIFICATION OF HELD TO EAR MODES TESTED .....	33
10.	OVERALL MEASUREMENT SUMMARY .....	34
11.	EQUIPMENT LIST .....	36
12.	MEASUREMENT UNCERTAINTY .....	37
13.	TEST DATA.....	38
14.	CALIBRATION CERTIFICATES.....	43
15.	CONCLUSION.....	71
16.	REFERENCES .....	72
17.	TEST PHOTOGRAPHS .....	74

<b>FCC ID:</b> ZNFH950	 <b>PCTEST</b> <small>ENGINEERING LABORATORY, INC.</small>	<b>HAC (RF EMISSIONS) TEST REPORT</b>	 <b>LG</b>	<b>Reviewed by:</b> Quality Manager
<b>Filename:</b> 0Y1501120071-R1.ZNF	<b>Test Dates:</b> January 12-15, 2015	<b>EUT Type:</b> Portable Handset	Page 2 of 76	

# 1. INTRODUCTION

On July 10, 2003, the Federal Communications Commission (FCC) adopted new rules requiring wireless manufacturers and service providers to provide digital wireless phones that are compatible with hearing aids. The FCC has modified the exemption for wireless phones under the Hearing Aid Compatibility Act of 1998 (HAC Act) in WT Docket 01-309 RM-8658<sup>1</sup> to extend the benefits of wireless telecommunications to individuals with hearing disabilities. These benefits encompass business, social and emergency communications, which increase the value of the wireless network for everyone. An estimated more than 10% of the population in the United States show signs of hearing impairment and of that fraction, almost 80% use hearing aids. Approximately 500 million people worldwide suffer from hearing loss.

## Compatibility Tests Involved:

The standard calls for wireless communications devices to be measured for:

- RF Electric-field emissions
- T-coil mode, magnetic-signal strength in the audio band
- T-coil mode, magnetic-signal frequency response through the audio band
- T-coil mode, magnetic-signal and noise articulation index

The hearing aid must be measured for:



- RF immunity in microphone mode
- RF immunity in T-coil mode

In the following tests and results, this report includes the evaluation for a wireless communications device.



Figure 1-1 Hearing Aid *in-vitu*

<sup>1</sup> FCC Rule & Order, WT Docket 01-309 RM-8658

FCC ID: ZNFH950	 PCTEST ENGINEERING LABORATORY, INC.	HAC (RF EMISSIONS) TEST REPORT	 LG	Reviewed by: Quality Manager
Filename: 0Y1501120071-R1.ZNF	Test Dates: January 12-15, 2015	EUT Type: Portable Handset		Page 3 of 76

## 2. EUT DESCRIPTION



FCC ID: ZNFH950  
 Manufacturer: LG Electronics MobileComm U.S.A., Inc.  
 1000 Sylvan Avenue  
 Englewood Cliffs, NJ 07632  
 United States  
 Model(s): LG-H950, LGH950, H950  
 Serial Number: 1301-4  
 Antenna Configurations: Internal Antenna  
 HAC Test Configurations: GSM 850, 128, 190, 251, BT Off, WLAN Off, LTE Off  
 GSM 1900, 512, 661, 810, BT Off, WLAN Off, LTE Off  
 EUT Type: Portable Handset

Air-Interface	Band (MHz)	Type Transport	HAC Tested	Simultaneous But Not Tested	Voice over Digital Transport OTT Capability	WiFi Low Power	Additional GSM Power Reduction
GSM	850	VO	Yes	Yes: WiFi or BT	N/A	N/A	No
	1900						
UMTS	GPRS/EDGE	DT	No	Yes: WiFi or BT	Yes	N/A	No
	850	VD	No <sup>2</sup>	Yes: WiFi or BT	N/A	N/A	N/A
	1900						
LTE	HSPA	DT	No	Yes: WiFi or BT	Yes	N/A	N/A
	700 (B12)	VD <sup>1</sup>	No <sup>2,3</sup>	Yes: WiFi or BT	Yes	N/A	N/A
	700 (B17)						
	850						
	1700						
1900							
WiFi	2500	DT	No	Yes: GSM, UMTS or LTE	Yes	N/A	N/A
	2450						
	5200						
	5300						
BT	5500	DT	No	Yes: GSM, UMTS or LTE	N/A	N/A	N/A
	5800						
Type Transport VO = Voice Only DT = Digital Data - Not intended for CMRS Service VD = CMRS and Data Transport			Notes: 1. The 3GPP VoLTE CMRS service is defined by GSMA in PRD IR.92 for IP Voice Service and Digital Transport. 2. Evaluated for MIF and low-power exemption. 3. No associated T-coil measurement has been made in accordance with the guidance issued by OET in KDB publication 285076 D02 T-Coil testing for CMRS IP.				

**Table 2-1: ZNFH950 HAC Air Interfaces**



FCC ID: ZNFH950	PCTEST ENGINEERING LABORATORY, INC.	HAC (RF EMISSIONS) TEST REPORT	LG	Reviewed by: Quality Manager
Filename: OY1501120071-R1.ZNF	Test Dates: January 12-15, 2015	EUT Type: Portable Handset	Page 4 of 76	

### 3. ANSI/IEEE C63.19 PERFORMANCE CATEGORIES

#### I. RF EMISSIONS

The ANSI Standard presents performance requirements for acceptable interoperability of hearing aids with wireless communications devices. When these parameters are met, a hearing aid operates acceptably in close proximity to a wireless communications device.

Category	Telephone RF Parameters
<b>Near field Category</b>	<b>E-field emissions CW dB(V/m)</b>
<b>f &lt; 960 MHz</b>	
<b>M1</b>	50 to 55
<b>M2</b>	45 to 50
<b>M3</b>	40 to 45
<b>M4</b>	< 40
<b>f &gt; 960 MHz</b>	
<b>M1</b>	40 to 45
<b>M2</b>	35 to 40
<b>M3</b>	30 to 35
<b>M4</b>	< 30
<b>Table 3-1 WD near-field categories as defined in ANSI C63.19-2011</b>	

<b>FCC ID:</b> ZNFH950	 <b>PCTEST</b> ENGINEERING LABORATORY, INC.	<b>HAC (RF EMISSIONS) TEST REPORT</b>	 <b>LG</b>	<b>Reviewed by:</b> Quality Manager
<b>Filename:</b> 0Y1501120071-R1.ZNF	<b>Test Dates:</b> January 12-15, 2015	<b>EUT Type:</b> Portable Handset	Page 5 of 76	

## 4. SYSTEM SPECIFICATIONS

### ER3DV6 E-Field Probe Description

Construction:	One dipole parallel, two dipoles normal to probe axis Built-in shielding against static charges
Calibration:	In air from 100 MHz to 3.0 GHz (absolute accuracy $\pm 6.0\%$ , $k=2$ )
Frequency:	100 MHz to > 6 GHz; Linearity: $\pm 0.2$ dB (100 MHz to 3 GHz)
Directivity	$\pm 0.2$ dB in air (rotation around probe axis) $\pm 0.4$ dB in air (rotation normal to probe axis)
Dynamic Range	2 V/m to > 1000 V/m (M3 or better device readings fall well below diode compression point)
Linearity:	$\pm 0.2$ dB
Dimensions	Overall length: 330 mm (Tip: 16 mm) Tip diameter: 8 mm (Body: 12 mm) Distance from probe tip to dipole centers: 2.5 mm

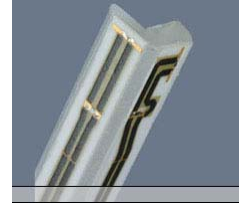
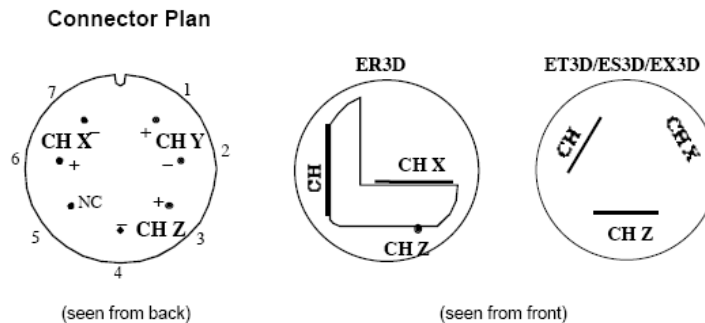

**Figure 4-1**  
E-field Free-space Probe

### Probe Tip Description

HAC field measurements take place in the close near field with high gradients. Increasing the measuring distance from the source will generally decrease the measured field values (in case of the validation dipole approx. 10% per mm).

The electric field probes have an irregular internal geometry because it is physically not possible to have the 3 orthogonal sensors situated with the same center. The effect of the different sensor centers is accounted for in the HAC uncertainty budget ("sensor displacement"). Their geometric center is at 2.5mm from the tip, and the element ends are 1.1mm closer to the tip.



The antistatic shielding inside the probe is connected to the probe connector case.

FCC ID: ZNFH950	PCTEST ENGINEERING LABORATORY, INC.	HAC (RF EMISSIONS) TEST REPORT	LG	Reviewed by: Quality Manager
Filename: OY1501120071-R1.ZNF	Test Dates: January 12-15, 2015	EUT Type: Portable Handset		Page 6 of 76

## Instrumentation Chain

### Equation 1

Conversion of Connector Voltage  $u_i$  to E-Field  $E_i$

$$E_i = \sqrt{\frac{u_i + (u_i^2 \cdot CF)/(DCP)}{Norm_i \cdot ConvF}}$$

whereby

$E_i$ : electric field in V/m  
 $u_i$ : voltage of channel i at the connector in  $\mu\text{V}$   
 $Norm_i$ : sensitivity of channel i in  $\mu\text{V}/(\text{V/m})^2$   
 $ConvF$ : enhancement factor in liquid ( $ConvF=1$  for Air)  
 $DCP$ : diode compression point in  $\mu\text{V}$   
 $CF$ : signal crest factor (peak power/average power)

### Conditions of Calibration

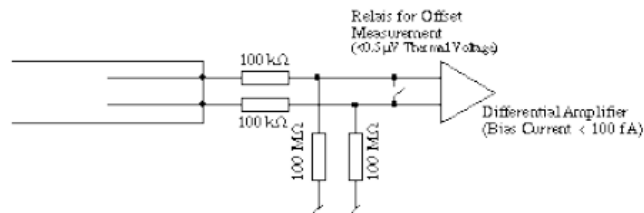

Please note:

- a lower input impedance of the amplifier will result in different sensitivity factors  $Norm_i$  and  $DCP$
- larger bias currents will cause higher offset

## Probe Response to Frequency

The E-field sensors have inherently a very flat frequency response. They are calibrated with a number of frequencies resulting in a common calibration factor, with the frequency behavior documented in the calibration certificate (See also below).

### Frequency Response of E-Field

(TEM-Cell:if110 EXX, Waveguide R22)

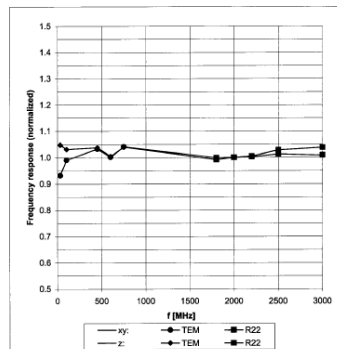

Uncertainty of Frequency Response of E-field:  $\pm 6.3\%$  ( $k=2$ )

Figure 4-2 E-Field Probe Frequency Response

FCC ID: ZNFH950	PCTEST ENGINEERING LABORATORY, INC.	HAC (RF EMISSIONS) TEST REPORT	LG	Reviewed by: Quality Manager
Filename: OY1501120071-R1.ZNF	Test Dates: January 12-15, 2015	EUT Type: Portable Handset		Page 7 of 76

## SPEAG Robotic System



E-field measurements are performed using the DASY5 automated dosimetric assessment system. The DASY5 is made by Schmid & Partner Engineering AG (SPEAG) in Zurich, Switzerland and consists of high precision robotics system (Staubli), robot controller, Intel CORE i7 computer, near-field probe, probe alignment sensor, and the HAC phantom. The robot is a six-axis industrial robot performing precise movements to position the probe to the location (points) of maximum electromagnetic field (EMF).



**Figure 4-3**  
SPEAG Robotic System

## System Hardware

A cell controller system contains the power supply, robot controller, teach pendant (Joystick), and a remote control used to drive the robot motors. The PC consists of the computer with operating system and RF Measurement Software DASY5 v52.8 (with HAC Extension), A/D interface card, monitor, mouse, and keyboard. The Staubli Robot is connected to the cell controller to allow software manipulation of the robot. A data acquisition electronic (DAE) circuit that performs the signal amplification, signal multiplexing, AD-conversion, offset measurements, mechanical surface detection, collision detection, etc. is connected to the Electro-optical coupler (EOC). The EOC performs the conversion from the optical into digital electric signal of the DAE and transfers data to the PC plug-in card.

<b>FCC ID:</b> ZNFH950	 <b>PCTEST</b> ENGINEERING LABORATORY, INC.	<b>HAC (RF EMISSIONS) TEST REPORT</b>	 <b>LG</b>	<b>Reviewed by:</b> Quality Manager
<b>Filename:</b> 0Y1501120071-R1.ZNF	<b>Test Dates:</b> January 12-15, 2015	<b>EUT Type:</b> Portable Handset	Page 8 of 76	



## System Electronics

The DAE consists of a highly sensitive electrometer-grade preamplifier with auto-zeroing, a channel and gain-switching multiplexer, a fast 16 bit AD-converter and a command decoder and control logic unit. Transmission to the PC-card is accomplished through an optical downlink for data and status information and an optical uplink for commands and clock lines. The mechanical probe mounting device includes two different sensor systems for frontal and sidewise probe contacts. They are also used for mechanical surface detection and probe collision detection. The robot uses its own controller with a built in VME-bus computer.

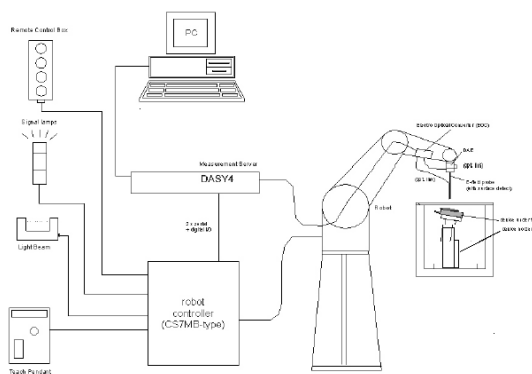



**Figure 4-4**  
SPEAG Robotic System Diagram

## DASY5 Instrumentation Chain

The first step of the evaluation is a linearization of the filtered input signal to account for the compression characteristics of the detector diode. The compensation depends on the input signal, the diode type and the DC-transmission factor from the diode to the evaluation electronics. If the exciting field is pulsed, the crest factor of the signal must be known to correctly compensate for peak power. The formula for each channel can be given as:

$$V_i = U_i + U_i^2 \cdot \frac{cf}{dcp_i}$$

with $V_i$	= compensated signal of channel $i$	( $i = x, y, z$ )
$U_i$	= input signal of channel $i$	( $i = x, y, z$ )
$cf$	= crest factor of exciting field	(DASY parameter)
$dcp_i$	= diode compression point	(DASY parameter)

FCC ID: ZNFH950	 PCTEST Engineering Laboratory, Inc.	HAC (RF EMISSIONS) TEST REPORT	 LG	Reviewed by: Quality Manager
Filename: 0Y1501120071-R1.ZNF	Test Dates: January 12-15, 2015	EUT Type: Portable Handset		Page 9 of 76

From the compensated input signals the primary field data for each channel can be evaluated:

$$E - \text{fieldprobes} : \quad E_i = \sqrt{\frac{V_i}{Norm_i \cdot ConvF}}$$

with  $V_i$  = compensated signal of channel i (i = x, y, z)  
 $Norm_i$  = sensor sensitivity of channel i (i = x, y, z)  
 $\mu\text{V}/(\text{V}/\text{m})^2$  for E-field Probes  
 $ConvF$  = sensitivity enhancement in solution  
 $E_i$  = electric field strength of channel i in V/m

The RSS value of the field components gives the total field strength (Hermitian magnitude):



$$E_{tot} = \sqrt{E_x^2 + E_y^2 + E_z^2}$$

The primary field data are used to calculate the derived field units.

The measurement/integration time per point, as specified by the system manufacturer is >500ms.

The signal response time is evaluated as the time required by the system to reach 90% of the expected final value after an on/off switch of the power source with an integration time of 500ms and a probe response time of <5 ms. In the current implementation, DASY5 waits longer than 100ms after having reached the grid point before starting a measurement, i.e., the response time uncertainty is negligible.

If the device under test does not emit a CW signal, the integration time applied to measure the electric field at a specific point may introduce additional uncertainties due to the discretization. The tolerances for the different systems had the worst-case of 2.6%.

FCC ID: ZNFH950	 <b>PCTEST</b> ENGINEERING LABORATORY, INC.	HAC (RF EMISSIONS) TEST REPORT	 <b>LG</b>	Reviewed by: Quality Manager
Filename: 0Y1501120071-R1.ZNF	Test Dates: January 12-15, 2015	EUT Type: Portable Handset	Page 10 of 76	

## 5. TEST PROCEDURE

### I. RF EMISSIONS

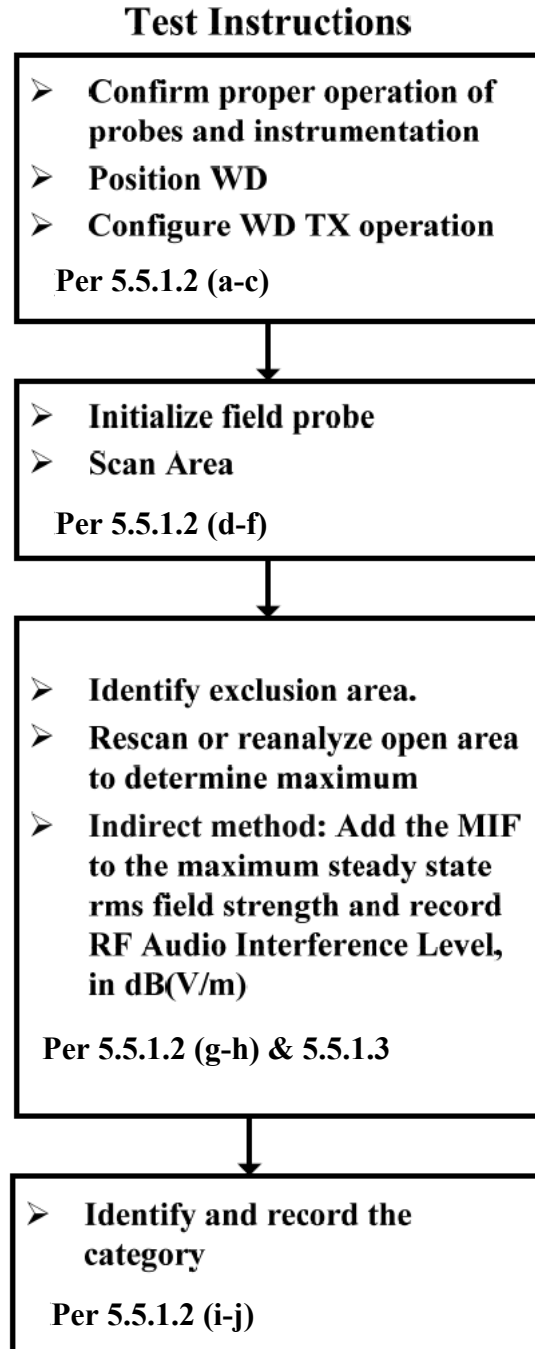

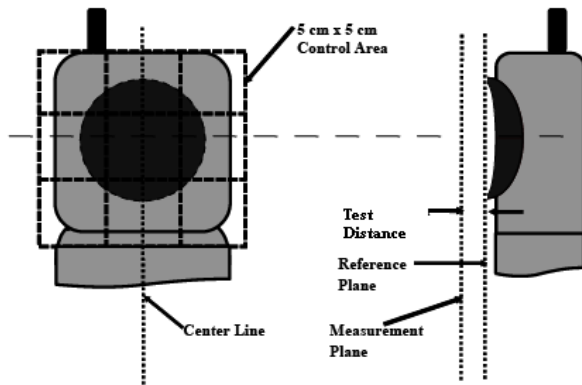

Figure 5-1 RF Emissions Flow Chart

FCC ID: ZNFH950	 PCTEST ENGINEERING LABORATORY, INC.	HAC (RF EMISSIONS) TEST REPORT	 LG	Reviewed by: Quality Manager
Filename: 0Y1501120071-R1.ZNF	Test Dates: January 12-15, 2015	EUT Type: Portable Handset		Page 11 of 76

## Test Setup



**Figure 5-2**

E-Field Emissions Test Setup Diagram (See Test Photographs for actual WD scan grid overlay)

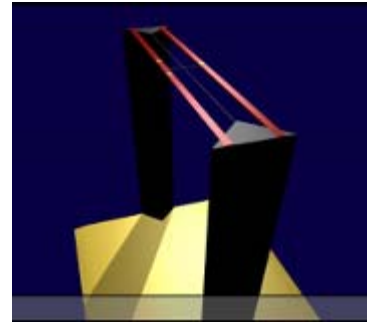



**Figure 5-3**  
HAC Phantom

## RF Emissions Test Procedure:

The following illustrate a typical RF emissions test scan over a wireless communications device:

1. Proper operation of the field probe, probe measurement system, other instrumentation, and the positioning system was confirmed.
2. WD is positioned in its intended test position, acoustic output point of the device perpendicular to the field probe.
3. The WD operation for maximum rated RF output power was configured and confirmed with the base station simulator, at the test channel and other normal operating parameters as intended for the test. The battery was ensured to be fully charged before each test.
4. The center sub-grid was centered over the center of the acoustic output (also audio band magnetic output, if applicable). The WD audio output was positioned tangent (as physically possible) to the measurement plane.
5. A surface calibration was performed before each setup change to ensure repeatable spacing and proper maintenance of the measurement plane using the HAC Phantom.
6. The measurement system measured the field strength at the reference location.
7. Measurements at 2mm or 5mm increments in the 5 x 5 cm region were performed at a distance 15 mm from the center point of the probe measurement element to the WD. A 360° rotation about the azimuth axis at the maximum interpolated position was measured. For the worst-case condition, the peak reading from this rotation was used in re-evaluating the HAC category.
8. The system performed a drift evaluation by measuring the field at the reference location. If the power drift deviated by more than 5%, the HAC test and drift measurements were repeated.

FCC ID: ZNFH950	 PCTEST ENGINEERING LABORATORY, INC.	HAC (RF EMISSIONS) TEST REPORT	 LG	Reviewed by: Quality Manager
Filename: OY1501120071-R1.ZNF	Test Dates: January 12-15, 2015	EUT Type: Portable Handset		Page 12 of 76

## 6. SYSTEM CHECK

### I. System Check Parameters

The input signal was an un-modulated continuous wave. The following points were taken into consideration in performing this check:

- Average Input Power  $P = 100\text{mW RMS}$  ( $20\text{dBm RMS}$ ) after adjustment for return loss
- The test fixture must meet the 2 wavelength separation criterion
- The proper measurement of the 15 mm probe to dipole separation, which is measured from top surface of the dipole to the calibration reference point of the sensor, defined by the probe manufacturer is shown in the following diagram:

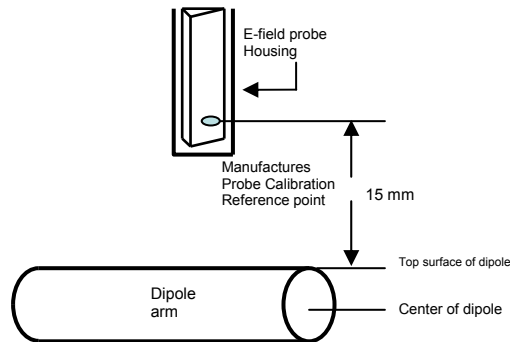

**Figure 6-1**  
Separation Distance from Dipole to Field Probe

RF power was recorded using both an average reading meter and a peak reading meter. Readings of the probe are provided by the measurement system.

To assure proper operation of the near-field measurement probe the input power to the dipole shall be commensurate with the full rated output power of the wireless device [e.g. - for a cellular phone wireless device the average peak antenna input power will be on the order of  $100\text{mW}$  ( $20\text{dBm}$ ) RMS] after adjustment for any mismatch.



### II. Validation Procedure

A dipole antenna meeting the requirements given in C63.19 was placed in the position normally occupied by the WD.

The length of the dipole was scanned, and the average peak value was recorded.

#### Measurement of CW

Using the near-field measurement system, scan the antenna over the radiating dipole and record the greatest field reading observed. Due to the nature of E-fields about free-space dipoles, the two E-field peaks measured over the dipole are averaged to compensate for non-parallelity of the setup (see manufacturer method on dipole calibration certificates, page 2). Field strength measurements shall be made only when the probe is stationary.

FCC ID: ZNFH950	 PCTEST ENGINEERING LABORATORY, INC.	HAC (RF EMISSIONS) TEST REPORT	 LG	Reviewed by: Quality Manager
Filename: OY1501120071-R1.ZNF	Test Dates: January 12-15, 2015	EUT Type: Portable Handset		Page 13 of 76

RF power was recorded using both an average and a peak power reading meter.

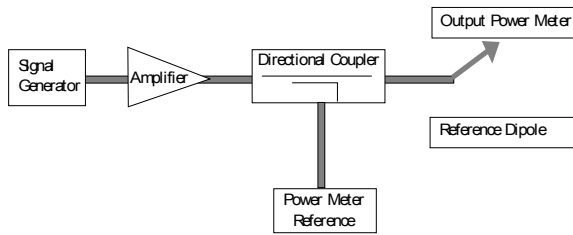

**Figure 6-2**

Setup for Desired Output Power to Dipole

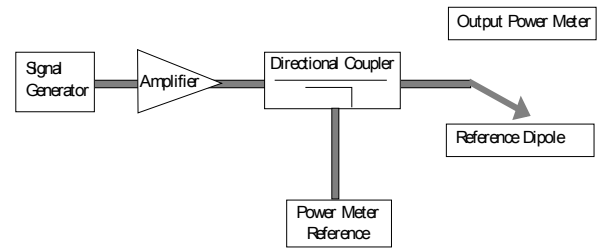
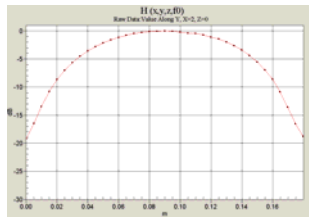

**Figure 6-3**

Setup to Dipole

Using this setup configuration, the signal generator was adjusted for the desired output power (100mW) at a specified frequency. The reference power from the coupled port of the directional coupler is recorded. Next, the output cable is connected to the reference dipole, as shown in Figure 6-3.

The input signal level was adjusted until the reference power from the coupled port of the directional coupler was the same as previously recorded, to compensate for the impedance mismatch between the output cable and the reference dipole. To assure proper operation of the near-field measurement probe the input power to the reference dipole was verified to the full rated output power of the wireless device. The dipole was secured in a holder in a manner to meet the 20 dB reflection. The near-field measurement probe was positioned over the dipole. The antenna was scanned over the appropriate sized area to cover the dipole from end to end. SPEAG uses 2D interpolation algorithms between the measured points. Please see below two dimensional plots showing that the interpolated values interpolate smoothly between 5mm steps for a free-space RF dipole:



**Figure 6-4**

2-D Raw Data from scan along dipole axis

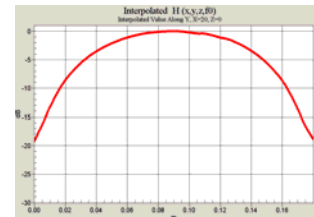

**Figure 6-5**

2-D Interpolated points from scan along dipole axis

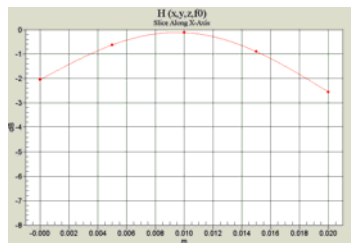

**Figure 6-6**

2-D Raw Data from scan along transverse axis

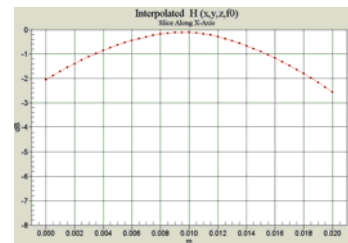

**Figure 6-7**

2-D Interpolated points from scan along transverse axis

FCC ID: ZNFH950	PCTEST ENGINEERING LABORATORY, INC.	HAC (RF EMISSIONS) TEST REPORT	LG	Reviewed by: Quality Manager
Filename: 0Y1501120071-R1.ZNF	Test Dates: January 12-15, 2015	EUT Type: Portable Handset		Page 14 of 76



### III. System Check Results

#### Validation Results

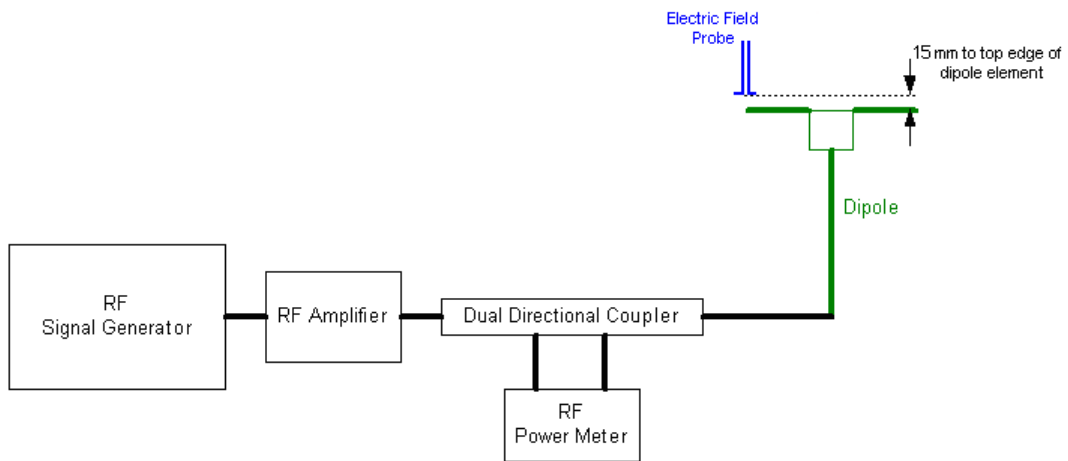
Frequency (MHz)	Dipole S/N	Input Power (dBm)	E-field Result (V/m)	Target Field (V/m)	% Deviation
835	1003	20.0	113.9	107.7	5.7%
1880	1137	20.0	93.0	90.2	3.1%



**Figure 6-8**  
System Check Setup

FCC ID: ZNFH950	 PCTEST ENGINEERING LABORATORY, INC.	HAC (RF EMISSIONS) TEST REPORT	 LG	Reviewed by: Quality Manager
Filename: 0Y1501120071-R1.ZNF	Test Dates: January 12-15, 2015	EUT Type: Portable Handset		Page 15 of 76

## 7. MODULATION INTERFERENCE FACTOR

### I. Measuring Modulation Interference Factors

For any specific fixed and repeatable modulated signal, a modulation interference factor (MIF, expressed in dB) may be determined that relates its interference potential to its steady-state RMS signal level or average power level. This factor is a function only of the audio-frequency amplitude modulation characteristics of the signal and is the same for field-strength and conducted power measurements. The MIF is valid only for a specific repeatable audio-frequency amplitude modulation characteristic; any change in modulation characteristic requires determination and application of a new MIF.

The MIF may be determined using a radiated RF field or a conducted RF signal:

- a. Using RF illumination or conducted coupling, apply the specific modulated signal in question to the measurement system at a level within its confirmed operating dynamic range.
- b. Measure the steady-state RMS level at the output of the fast probe or sensor.
- c. Measure the steady-state average level at the weighting output.
- d. Without changing the square-law detector or weighting system, and using RF illumination or conducted coupling, substitute for the specific modulated signal a 1 kHz, 80% amplitude modulated carrier at the same frequency and adjust its strength until the level at the weighting output equals the step c) measurement.
- e. Without changing the carrier level from step d), remove the 1 kHz modulation and again measure the steady-state RMS level indicated at the output of the fast probe or sensor.
- f. The MIF for the specific modulation characteristic is provided by the ratio of the step e) measurement to the step b) measurement, expressed in dB ( $20 \times \log[(\text{step e})/(\text{step b})]$ ).



The following procedure was used to measure the MIF using the SPEAG Audio Interference Analyzer (AIA), Type No: SE UMS 170 CB, Serial No: 1010:

1. The device was placed into a simulated call using a base station simulator or set to transmit using test software for a given mode.
2. The device was then set to continuously transmit at maximum power.
3. Using a coupler if needed, the device output signal was connected to the RF In port of the AIA, which was connected to a desktop computer. Alternatively, a radiated RF signal may be used with the AIA's built-in antenna.
4. The MIF measurement procedure in the DASY software was run, and the resulting MIF value was recorded.
5. Steps 1-4 were repeated for all CMRS air interfaces, frequency bands, and modulations.

The modulation interference factors obtained were applied to readings taken of the actual wireless device in order to obtain an accurate audio interference level reading using the formula:

$$\text{Audio Interference Level [dB(V/m)]} = 20 * \log[\text{Raw Field Value (V/m)}] + \text{MIF (dB)}$$

Because the MIF value is output power independent, MIF values for a given mode should be constant across all devices; however, per C63.19-2011 §D.7, MIF values should be measured for each device being evaluated. The voice modes for this device have been investigated in this section of the report.

FCC ID: ZNFH950	 PCTEST ENGINEERING LABORATORY, INC.	HAC (RF EMISSIONS) TEST REPORT	 LG	Reviewed by: Quality Manager
Filename: OY1501120071-R1.ZNF	Test Dates: January 12-15, 2015	EUT Type: Portable Handset		Page 16 of 76



## II. MIF Measurement Block Diagrams

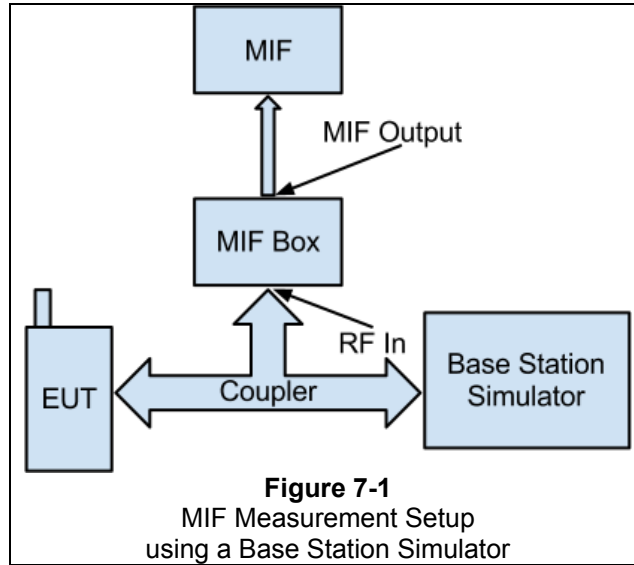

## III. Measured Modulation Interference Factors:

Band	Channel	GSM [dB] CS (1 Slot)
GSM 850	128	3.51
	190	3.51
	251	3.51
GSM 1900	512	3.50
	661	3.50
	810	3.51

**Table 7-1**  
GSM Modulation Interference Factors<sup>1</sup>

Mode	UMTS V [dB]			UMTS II [dB]		
	4132	4183	4233	9262	9400	9538
12.2 kbps RMC	-20.65	-19.28	-21.91	-20.20	-18.89	-17.39
12.2 kbps AMR	-14.74	-15.08	-15.07	-15.16	-15.12	-14.90

**Table 7-2**  
UMTS Modulation Interference Factors<sup>1</sup>

<sup>1</sup> Note: Measured MIF values may be lower than sample MIF values provided in ANSI C63.19-2011 Annex D.7 Table D.5 due to manufacturing variations for each device, however per Annex D.7, the sample MIF values of Table D.5 are not intended to substitute for measurements of actual devices under test and their respective operating modes.



FCC ID: ZNFH950	PCTEST ENGINEERING LABORATORY, INC.	HAC (RF EMISSIONS) TEST REPORT	LG	Reviewed by: Quality Manager
Filename: OY1501120071-R1.ZNF	Test Dates: January 12-15, 2015	EUT Type: Portable Handset		Page 17 of 76

LTE Band	Frequency [MHz]	Channel	Bandwidth [MHz]	Modulation	RB Size	RB Offset	MIF [dB]
7	2535	21100	10	16QAM	1	0	-11.09
2	1880	18900	20	16QAM	1	0	-10.22
4	1732.5	20175	20	16QAM	1	0	-9.96
5	836.5	20525	10	16QAM	1	0	-10.40
12	707.5	23095	10	16QAM	1	0	-9.98
4	1732.5	20175	20	QPSK	1	0	-15.50
4	1732.5	20175	20	16QAM	1	50	-10.06
4	1732.5	20175	20	16QAM	1	99	-10.08
4	1732.5	20175	20	16QAM	50	0	-16.72
4	1732.5	20175	20	16QAM	100	0	-17.24
4	1732.5	20175	15	16QAM	1	0	-10.66
4	1732.5	20175	10	16QAM	1	0	-10.63
4	1732.5	20175	5	16QAM	1	0	-10.57

**Table 7-3**  
LTE Modulation Interference Factors<sup>1,2</sup>

<sup>1</sup>Note: Measured MIF values may be lower than sample MIF values provided in ANSI C63.19-2011 Annex D.7 Table D.5 due to manufacturing variations for each device, however per Annex D.7, the sample MIF values of Table D.5 are not intended to substitute for measurements of actual devices under test and their respective operating modes.

<sup>2</sup> Note: All LTE bands were found to have substantially similar MIF values given similar RB and BW configurations.

FCC ID: ZNFH950	 PCTEST ENGINEERING LABORATORY, INC.	HAC (RF EMISSIONS) TEST REPORT	 LG	Reviewed by: Quality Manager
Filename: 0Y1501120071-R1.ZNF	Test Dates: January 12-15, 2015	EUT Type: Portable Handset	Page 18 of 76	

## 8. RF CONDUCTED POWER MEASUREMENTS

### I. Procedures Used to Establish RF Signal for HAC Testing

The handset was placed into a simulated call using a base station simulator in a shielded chamber. Such test signals offer a consistent means for testing HAC and are recommended for evaluating HAC. Measurements were taken with a fully charged battery. In order to verify that the device was tested and maintained at full power, this was configured with the base station simulator.

### II. HAC Measurement Conditions

#### Output Power Verification

Maximum output power is verified on the High, Middle and Low channels for all applicable air interfaces. See Table 8-1 for air interface specific settings of transmit power parameters.

Air Interface:	Parameter Name:	Parameter Set To:
GSM	PCL	GSM850: "5" GSM1900: "0"
UMTS	TPC	"All 1's"
LTE	TPC	"Max Power"

**Table 8-1**  
**Power Control Parameters and Settings by Air Interface**

### III. Setup Used to Measure RF Conducted Powers

Power measurements were performed using a base station simulator under digital average power.



**Figure 8-1**  
**Power Measurement Setup**

### IV. GSM Conducted Powers

Band	Channel	GSM [dBm] CS (1 Slot)
GSM 850	128	33.17
	190	33.04
	251	33.18
GSM 1900	512	30.01
	661	29.82
	810	30.15

### V. UMTS Conducted Powers

3GPP 34.121 Subtest	Cellular Band [dBm]			PCS Band [dBm]		
	4132	4183	4233	9262	9400	9538
12.2 kbps RMC	23.65	23.52	23.63	23.63	23.66	23.70
12.2 kbps AMR	23.58	23.50	23.57	23.63	23.44	23.61

FCC ID: ZNFH950	PCTEST ENGINEERING LABORATORY, INC.	HAC (RF EMISSIONS) TEST REPORT	LG	Reviewed by: Quality Manager
Filename: OY1501120071-R1.ZNF	Test Dates: January 12-15, 2015	EUT Type: Portable Handset	Page 19 of 76	



## VI. LTE Conducted Powers

**Table 8-2**  
**LTE Band 12 (700 MHz) Conducted Powers - 10 MHz Bandwidth**

Frequency [MHz]	Channel	Bandwidth [MHz]	Modulation	RB Size	RB Offset	Conducted Power [dBm]	MPR Allowed per 3GPP [dB]	MPR [dB]
707.5	23095	10	QPSK	1	0	24.64	0	0
707.5	23095	10	QPSK	1	25	24.60	0	0
707.5	23095	10	QPSK	1	49	24.59	0	0
707.5	23095	10	QPSK	25	0	23.21	0-1	1
707.5	23095	10	QPSK	25	12	23.25	0-1	1
707.5	23095	10	QPSK	25	25	23.21	0-1	1
707.5	23095	10	QPSK	50	0	23.20	0-1	1
707.5	23095	10	16QAM	1	0	23.61	0-1	1
707.5	23095	10	16QAM	1	25	23.55	0-1	1
707.5	23095	10	16QAM	1	49	23.56	0-1	1
707.5	23095	10	16QAM	25	0	22.20	0-2	2
707.5	23095	10	16QAM	25	12	22.22	0-2	2
707.5	23095	10	16QAM	25	25	22.28	0-2	2
707.5	23095	10	16QAM	50	0	22.24	0-2	2

**Table 8-3**  
**LTE Band 12 (700 MHz) Conducted Powers - 5 MHz Bandwidth**

Frequency [MHz]	Channel	Bandwidth [MHz]	Modulation	RB Size	RB Offset	Conducted Power [dBm]	MPR Allowed per 3GPP [dB]	MPR [dB]
701.5	23035	5	QPSK	1	0	24.58	0	0
701.5	23035	5	QPSK	1	12	24.40	0	0
701.5	23035	5	QPSK	1	24	24.49	0	0
701.5	23035	5	QPSK	12	0	23.31	0-1	1
701.5	23035	5	QPSK	12	6	23.28	0-1	1
701.5	23035	5	QPSK	12	13	23.20	0-1	1
701.5	23035	5	QPSK	25	0	23.28	0-1	1
701.5	23035	5	16-QAM	1	0	23.55	0-1	1
701.5	23035	5	16-QAM	1	12	23.45	0-1	1
701.5	23035	5	16-QAM	1	24	23.53	0-1	1
701.5	23035	5	16-QAM	12	0	22.28	0-2	2
701.5	23035	5	16-QAM	12	6	22.21	0-2	2
701.5	23035	5	16-QAM	12	13	22.29	0-2	2
701.5	23035	5	16-QAM	25	0	22.31	0-2	2
707.5	23095	5	QPSK	1	0	24.50	0	0
707.5	23095	5	QPSK	1	12	24.40	0	0
707.5	23095	5	QPSK	1	24	24.38	0	0
707.5	23095	5	QPSK	12	0	23.22	0-1	1
707.5	23095	5	QPSK	12	6	23.29	0-1	1
707.5	23095	5	QPSK	12	13	23.38	0-1	1
707.5	23095	5	QPSK	25	0	23.30	0-1	1
707.5	23095	5	16-QAM	1	0	23.40	0-1	1
707.5	23095	5	16-QAM	1	12	23.48	0-1	1
707.5	23095	5	16-QAM	1	24	23.37	0-1	1
707.5	23095	5	16-QAM	12	0	22.20	0-2	2
707.5	23095	5	16-QAM	12	6	22.47	0-2	2
707.5	23095	5	16-QAM	12	13	22.21	0-2	2
707.5	23095	5	16-QAM	25	0	22.23	0-2	2
713.5	23155	5	QPSK	1	0	24.66	0	0
713.5	23155	5	QPSK	1	12	24.54	0	0
713.5	23155	5	QPSK	1	24	24.58	0	0
713.5	23155	5	QPSK	12	0	23.31	0-1	1
713.5	23155	5	QPSK	12	6	23.38	0-1	1
713.5	23155	5	QPSK	12	13	23.30	0-1	1
713.5	23155	5	QPSK	25	0	23.24	0-1	1
713.5	23155	5	16-QAM	1	0	23.55	0-1	1
713.5	23155	5	16-QAM	1	12	23.49	0-1	1
713.5	23155	5	16-QAM	1	24	23.58	0-1	1
713.5	23155	5	16-QAM	12	0	22.21	0-2	2
713.5	23155	5	16-QAM	12	6	22.28	0-2	2
713.5	23155	5	16-QAM	12	13	22.22	0-2	2
713.5	23155	5	16-QAM	25	0	22.27	0-2	2



FCC ID: ZNFH950	 <b>PCTEST</b> ENGINEERING LABORATORY, INC.	<b>HAC (RF EMISSIONS) TEST REPORT</b>	 <b>LG</b>	Reviewed by: Quality Manager
Filename: OY1501120071-R1.ZNF	Test Dates: January 12-15, 2015	EUT Type: Portable Handset		Page 20 of 76

**Table 8-4**  
**LTE Band 5 (835 MHz) Conducted Powers - 10 MHz Bandwidth**

Frequency [MHz]	Channel	Bandwidth [MHz]	Modulation	RB Size	RB Offset	Conducted Power [dBm]	MPR Allowed per 3GPP [dB]	MPR [dB]
836.5	20525	10	QPSK	1	0	23.81	0	0
836.5	20525	10	QPSK	1	25	23.84	0	0
836.5	20525	10	QPSK	1	49	24.00	0	0
836.5	20525	10	QPSK	25	0	22.84	0-1	1
836.5	20525	10	QPSK	25	12	22.95	0-1	1
836.5	20525	10	QPSK	25	25	22.97	0-1	1
836.5	20525	10	QPSK	50	0	22.89	0-1	1
836.5	20525	10	16QAM	1	0	23.13	0-1	1
836.5	20525	10	16QAM	1	25	23.14	0-1	1
836.5	20525	10	16QAM	1	49	23.18	0-1	1
836.5	20525	10	16QAM	25	0	21.98	0-2	2
836.5	20525	10	16QAM	25	12	22.11	0-2	2
836.5	20525	10	16QAM	25	25	22.06	0-2	2
836.5	20525	10	16QAM	50	0	21.91	0-2	2

**Table 8-5**  
**LTE Band 5 (835 MHz) Conducted Powers - 5 MHz Bandwidth**

Frequency [MHz]	Channel	Bandwidth [MHz]	Modulation	RB Size	RB Offset	Conducted Power [dBm]	MPR Allowed per 3GPP [dB]	MPR [dB]
826.5	20425	5	QPSK	1	0	23.85	0	0
826.5	20425	5	QPSK	1	12	23.84	0	0
826.5	20425	5	QPSK	1	24	23.98	0	0
826.5	20425	5	QPSK	12	0	22.92	0-1	1
826.5	20425	5	QPSK	12	6	23.00	0-1	1
826.5	20425	5	QPSK	12	13	22.98	0-1	1
826.5	20425	5	QPSK	25	0	22.89	0-1	1
826.5	20425	5	16-QAM	1	0	23.19	0-1	1
826.5	20425	5	16-QAM	1	12	23.10	0-1	1
826.5	20425	5	16-QAM	1	24	23.20	0-1	1
826.5	20425	5	16-QAM	12	0	22.06	0-2	2
826.5	20425	5	16-QAM	12	6	22.07	0-2	2
826.5	20425	5	16-QAM	12	13	22.11	0-2	2
826.5	20425	5	16-QAM	25	0	21.93	0-2	2
836.5	20525	5	QPSK	1	0	23.87	0	0
836.5	20525	5	QPSK	1	12	23.89	0	0
836.5	20525	5	QPSK	1	24	24.08	0	0
836.5	20525	5	QPSK	12	0	22.81	0-1	1
836.5	20525	5	QPSK	12	6	23.00	0-1	1
836.5	20525	5	QPSK	12	13	23.00	0-1	1
836.5	20525	5	QPSK	25	0	22.97	0-1	1
836.5	20525	5	16-QAM	1	0	23.09	0-1	1
836.5	20525	5	16-QAM	1	12	23.19	0-1	1
836.5	20525	5	16-QAM	1	24	23.13	0-1	1
836.5	20525	5	16-QAM	12	0	22.02	0-2	2
836.5	20525	5	16-QAM	12	6	22.11	0-2	2
836.5	20525	5	16-QAM	12	13	22.09	0-2	2
836.5	20525	5	16-QAM	25	0	21.93	0-2	2
846.5	20625	5	QPSK	1	0	23.78	0	0
846.5	20625	5	QPSK	1	12	23.90	0	0
846.5	20625	5	QPSK	1	24	23.95	0	0
846.5	20625	5	QPSK	12	0	22.89	0-1	1
846.5	20625	5	QPSK	12	6	22.91	0-1	1
846.5	20625	5	QPSK	12	13	23.05	0-1	1
846.5	20625	5	QPSK	25	0	22.85	0-1	1
846.5	20625	5	16-QAM	1	0	23.14	0-1	1
846.5	20625	5	16-QAM	1	12	23.13	0-1	1
846.5	20625	5	16-QAM	1	24	23.20	0-1	1
846.5	20625	5	16-QAM	12	0	22.06	0-2	2
846.5	20625	5	16-QAM	12	6	22.16	0-2	2
846.5	20625	5	16-QAM	12	13	22.07	0-2	2
846.5	20625	5	16-QAM	25	0	21.86	0-2	2

FCC ID: ZNFH950	 PCTEST ENGINEERING LABORATORY, INC.	HAC (RF EMISSIONS) TEST REPORT	 LG	Reviewed by: Quality Manager
Filename: OY1501120071-R1.ZNF	Test Dates: January 12-15, 2015	EUT Type: Portable Handset		Page 21 of 76

**Table 8-6**  
**LTE Band 4 (1700 MHz) Conducted Powers - 20 MHz Bandwidth**



Frequency [MHz]	Channel	Bandwidth [MHz]	Modulation	RB Size	RB Offset	Conducted Power [dBm]	MPR Allowed per 3GPP [dB]	MPR [dB]	Deviation [dB]
1732.5	20175	20	QPSK	1	0	23.99	0	0	0.29
1732.5	20175	20	QPSK	1	50	23.99	0	0	0.29
1732.5	20175	20	QPSK	1	99	23.81	0	0	0.11
1732.5	20175	20	QPSK	50	0	22.89	0-1	1	0.19
1732.5	20175	20	QPSK	50	25	22.95	0-1	1	0.25
1732.5	20175	20	QPSK	50	50	22.85	0-1	1	0.15
1732.5	20175	20	QPSK	100	0	22.89	0-1	1	0.19
1732.5	20175	20	16QAM	1	0	22.97	0-1	1	0.27
1732.5	20175	20	16QAM	1	50	23.01	0-1	1	0.31
1732.5	20175	20	16QAM	1	99	23.04	0-1	1	0.34
1732.5	20175	20	16QAM	50	0	21.72	0-2	2	0.02
1732.5	20175	20	16QAM	50	25	21.79	0-2	2	0.09
1732.5	20175	20	16QAM	50	50	21.80	0-2	2	0.10
1732.5	20175	20	16QAM	100	0	21.79	0-2	2	0.09

**Table 8-7**  
**LTE Band 4 (1700 MHz) Conducted Powers - 15 MHz Bandwidth**

Frequency [MHz]	Channel	Bandwidth [MHz]	Modulation	RB Size	RB Offset	Conducted Power [dBm]	MPR Allowed per 3GPP [dB]	MPR [dB]	Deviation [dB]
1717.5	20025	15	QPSK	1	0	23.80	0	0	0.10
1717.5	20025	15	QPSK	1	36	23.88	0	0	0.18
1717.5	20025	15	QPSK	1	74	23.78	0	0	0.08
1717.5	20025	15	QPSK	36	0	22.75	0-1	1	0.05
1717.5	20025	15	QPSK	36	18	22.71	0-1	1	0.01
1717.5	20025	15	QPSK	36	37	22.80	0-1	1	0.10
1717.5	20025	15	QPSK	75	0	22.89	0-1	1	0.19
1717.5	20025	15	16QAM	1	0	22.91	0-1	1	0.21
1717.5	20025	15	16QAM	1	36	22.99	0-1	1	0.29
1717.5	20025	15	16QAM	1	74	22.98	0-1	1	0.28
1717.5	20025	15	16QAM	36	0	21.89	0-2	2	0.19
1717.5	20025	15	16QAM	36	18	21.87	0-2	2	0.17
1717.5	20025	15	16QAM	36	37	21.88	0-2	2	0.18
1717.5	20025	15	16QAM	75	0	21.78	0-2	2	0.08
1732.5	20175	15	QPSK	1	0	23.90	0	0	0.20
1732.5	20175	15	QPSK	1	36	23.86	0	0	0.16
1732.5	20175	15	QPSK	1	74	23.88	0	0	0.18
1732.5	20175	15	QPSK	36	0	22.91	0-1	1	0.21
1732.5	20175	15	QPSK	36	18	22.97	0-1	1	0.27
1732.5	20175	15	QPSK	36	37	23.04	0-1	1	0.34
1732.5	20175	15	QPSK	75	0	23.00	0-1	1	0.30
1732.5	20175	15	16QAM	1	0	22.80	0-1	1	0.10
1732.5	20175	15	16QAM	1	36	22.70	0-1	1	0.00
1732.5	20175	15	16QAM	1	74	22.89	0-1	1	0.19
1732.5	20175	15	16QAM	36	0	21.76	0-2	2	0.06
1732.5	20175	15	16QAM	36	18	21.86	0-2	2	0.16
1732.5	20175	15	16QAM	36	37	21.75	0-2	2	0.05
1732.5	20175	15	16QAM	75	0	21.76	0-2	2	0.06
1747.5	20325	15	QPSK	1	0	23.85	0	0	0.15
1747.5	20325	15	QPSK	1	36	23.88	0	0	0.18
1747.5	20325	15	QPSK	1	74	23.75	0	0	0.05
1747.5	20325	15	QPSK	36	0	22.70	0-1	1	0.00
1747.5	20325	15	QPSK	36	18	22.74	0-1	1	0.04
1747.5	20325	15	QPSK	36	37	22.71	0-1	1	0.01
1747.5	20325	15	QPSK	75	0	22.84	0-1	1	0.14
1747.5	20325	15	16QAM	1	0	22.88	0-1	1	0.18
1747.5	20325	15	16QAM	1	36	22.86	0-1	1	0.16
1747.5	20325	15	16QAM	1	74	22.79	0-1	1	0.09
1747.5	20325	15	16QAM	36	0	21.89	0-2	2	0.19
1747.5	20325	15	16QAM	36	18	21.90	0-2	2	0.20
1747.5	20325	15	16QAM	36	37	22.00	0-2	2	0.30
1747.5	20325	15	16QAM	75	0	21.87	0-2	2	0.17



**Table 8-8  
LTE Band 4 (1700 MHz) Conducted Powers - 10 MHz Bandwidth**

Frequency [MHz]	Channel	Bandwidth [MHz]	Modulation	RB Size	RB Offset	Conducted Power [dBm]	MPR Allowed per 3GPP [dB]	MPR [dB]
1715	20000	10	QPSK	1	0	23.77	0	0
1715	20000	10	QPSK	1	25	23.89	0	0
1715	20000	10	QPSK	1	49	23.77	0	0
1715	20000	10	QPSK	25	0	22.95	0-1	1
1715	20000	10	QPSK	25	12	22.76	0-1	1
1715	20000	10	QPSK	25	25	22.75	0-1	1
1715	20000	10	QPSK	50	0	22.70	0-1	1
1715	20000	10	16QAM	1	0	22.79	0-1	1
1715	20000	10	16QAM	1	25	22.78	0-1	1
1715	20000	10	16QAM	1	49	22.83	0-1	1
1715	20000	10	16QAM	25	0	21.88	0-2	2
1715	20000	10	16QAM	25	12	21.75	0-2	2
1715	20000	10	16QAM	25	25	21.79	0-2	2
1715	20000	10	16QAM	50	0	21.76	0-2	2
1732.5	20175	10	QPSK	1	0	23.90	0	0
1732.5	20175	10	QPSK	1	25	23.78	0	0
1732.5	20175	10	QPSK	1	49	23.87	0	0
1732.5	20175	10	QPSK	25	0	22.77	0-1	1
1732.5	20175	10	QPSK	25	12	22.76	0-1	1
1732.5	20175	10	QPSK	25	25	22.79	0-1	1
1732.5	20175	10	QPSK	50	0	22.76	0-1	1
1732.5	20175	10	16QAM	1	0	22.89	0-1	1
1732.5	20175	10	16QAM	1	25	22.92	0-1	1
1732.5	20175	10	16QAM	1	49	22.91	0-1	1
1732.5	20175	10	16QAM	25	0	21.78	0-2	2
1732.5	20175	10	16QAM	25	12	21.87	0-2	2
1732.5	20175	10	16QAM	25	25	21.88	0-2	2
1732.5	20175	10	16QAM	50	0	21.85	0-2	2
1750	20350	10	QPSK	1	0	23.79	0	0
1750	20350	10	QPSK	1	25	23.80	0	0
1750	20350	10	QPSK	1	49	23.81	0	0
1750	20350	10	QPSK	25	0	22.76	0-1	1
1750	20350	10	QPSK	25	12	22.91	0-1	1
1750	20350	10	QPSK	25	25	22.86	0-1	1
1750	20350	10	QPSK	50	0	22.85	0-1	1
1750	20350	10	16QAM	1	0	22.90	0-1	1
1750	20350	10	16QAM	1	25	22.97	0-1	1
1750	20350	10	16QAM	1	49	22.81	0-1	1
1750	20350	10	16QAM	25	0	21.85	0-2	2
1750	20350	10	16QAM	25	12	21.80	0-2	2
1750	20350	10	16QAM	25	25	21.78	0-2	2
1750	20350	10	16QAM	50	0	21.79	0-2	2

FCC ID: ZNFH950	 <b>PCTEST</b> ENGINEERING LABORATORY, INC.	<b>HAC (RF EMISSIONS) TEST REPORT</b>		Reviewed by: Quality Manager
Filename: OY1501120071-R1.ZNF	Test Dates: January 12-15, 2015	EUT Type: Portable Handset		Page 23 of 76

**Table 8-9**  
**LTE Band 4 (1700 MHz) Conducted Powers - 5 MHz Bandwidth**



Frequency [MHz]	Channel	Bandwidth [MHz]	Modulation	RB Size	RB Offset	Conducted Power [dBm]	MPR Allowed per 3GPP [dB]	MPR [dB]
1712.5	19975	5	QPSK	1	0	23.87	0	0
1712.5	19975	5	QPSK	1	12	23.85	0	0
1712.5	19975	5	QPSK	1	24	23.91	0	0
1712.5	19975	5	QPSK	12	0	22.85	0-1	1
1712.5	19975	5	QPSK	12	6	22.77	0-1	1
1712.5	19975	5	QPSK	12	13	22.71	0-1	1
1712.5	19975	5	QPSK	25	0	22.70	0-1	1
1712.5	19975	5	16-QAM	1	0	22.89	0-1	1
1712.5	19975	5	16-QAM	1	12	22.85	0-1	1
1712.5	19975	5	16-QAM	1	24	22.90	0-1	1
1712.5	19975	5	16-QAM	12	0	21.78	0-2	2
1712.5	19975	5	16-QAM	12	6	21.89	0-2	2
1712.5	19975	5	16-QAM	12	13	21.85	0-2	2
1712.5	19975	5	16-QAM	25	0	21.79	0-2	2
1732.5	20175	5	QPSK	1	0	23.89	0	0
1732.5	20175	5	QPSK	1	12	23.95	0	0
1732.5	20175	5	QPSK	1	24	23.79	0	0
1732.5	20175	5	QPSK	12	0	22.76	0-1	1
1732.5	20175	5	QPSK	12	6	22.89	0-1	1
1732.5	20175	5	QPSK	12	13	22.80	0-1	1
1732.5	20175	5	QPSK	25	0	22.90	0-1	1
1732.5	20175	5	16-QAM	1	0	23.05	0-1	1
1732.5	20175	5	16-QAM	1	12	23.00	0-1	1
1732.5	20175	5	16-QAM	1	24	22.99	0-1	1
1732.5	20175	5	16-QAM	12	0	21.89	0-2	2
1732.5	20175	5	16-QAM	12	6	21.79	0-2	2
1732.5	20175	5	16-QAM	12	13	21.86	0-2	2
1732.5	20175	5	16-QAM	25	0	21.84	0-2	2
1752.5	20375	5	QPSK	1	0	23.80	0	0
1752.5	20375	5	QPSK	1	12	23.89	0	0
1752.5	20375	5	QPSK	1	24	23.99	0	0
1752.5	20375	5	QPSK	12	0	22.85	0-1	1
1752.5	20375	5	QPSK	12	6	22.87	0-1	1
1752.5	20375	5	QPSK	12	13	22.83	0-1	1
1752.5	20375	5	QPSK	25	0	22.80	0-1	1
1752.5	20375	5	16-QAM	1	0	22.94	0-1	1
1752.5	20375	5	16-QAM	1	12	22.91	0-1	1
1752.5	20375	5	16-QAM	1	24	22.84	0-1	1
1752.5	20375	5	16-QAM	12	0	21.89	0-2	2
1752.5	20375	5	16-QAM	12	6	21.75	0-2	2
1752.5	20375	5	16-QAM	12	13	21.89	0-2	2
1752.5	20375	5	16-QAM	25	0	21.86	0-2	2

FCC ID: ZNFH950	 <b>PCTEST</b> ENGINEERING LABORATORY, INC.	<b>HAC (RF EMISSIONS) TEST REPORT</b>		Reviewed by: Quality Manager
Filename: OY1501120071-R1.ZNF	Test Dates: January 12-15, 2015	EUT Type: Portable Handset	Page 24 of 76	





**Table 8-10**  
**LTE Band 2 (1900 MHz) Conducted Powers - 20 MHz Bandwidth**

Frequency [MHz]	Channel	Bandwidth [MHz]	Modulation	RB Size	RB Offset	Conducted Power [dBm]	MPR Allowed per 3GPP [dB]	MPR [dB]
1860	18700	20	QPSK	1	0	23.90	0	0
1860	18700	20	QPSK	1	50	24.03	0	0
1860	18700	20	QPSK	1	99	23.89	0	0
1860	18700	20	QPSK	50	0	22.92	0-1	1
1860	18700	20	QPSK	50	25	22.81	0-1	1
1860	18700	20	QPSK	50	50	22.75	0-1	1
1860	18700	20	QPSK	100	0	22.77	0-1	1
1860	18700	20	16QAM	1	0	22.85	0-1	1
1860	18700	20	16QAM	1	50	22.83	0-1	1
1860	18700	20	16QAM	1	99	22.79	0-1	1
1860	18700	20	16QAM	50	0	21.91	0-2	2
1860	18700	20	16QAM	50	25	21.95	0-2	2
1860	18700	20	16QAM	50	50	21.76	0-2	2
1860	18700	20	16QAM	100	0	21.80	0-2	2
1880.0	18900	20	QPSK	1	0	23.88	0	0
1880.0	18900	20	QPSK	1	50	23.83	0	0
1880.0	18900	20	QPSK	1	99	23.91	0	0
1880.0	18900	20	QPSK	50	0	22.91	0-1	1
1880.0	18900	20	QPSK	50	25	22.86	0-1	1
1880.0	18900	20	QPSK	50	50	22.79	0-1	1
1880.0	18900	20	QPSK	100	0	22.74	0-1	1
1880.0	18900	20	16QAM	1	0	22.70	0-1	1
1880.0	18900	20	16QAM	1	50	22.79	0-1	1
1880.0	18900	20	16QAM	1	99	22.85	0-1	1
1880.0	18900	20	16QAM	50	0	21.77	0-2	2
1880.0	18900	20	16QAM	50	25	21.89	0-2	2
1880.0	18900	20	16QAM	50	50	21.88	0-2	2
1880.0	18900	20	16QAM	100	0	21.70	0-2	2
1900	19100	20	QPSK	1	0	24.11	0	0
1900	19100	20	QPSK	1	50	24.05	0	0
1900	19100	20	QPSK	1	99	23.94	0	0
1900	19100	20	QPSK	50	0	22.97	0-1	1
1900	19100	20	QPSK	50	25	22.83	0-1	1
1900	19100	20	QPSK	50	50	22.77	0-1	1
1900	19100	20	QPSK	100	0	22.76	0-1	1
1900	19100	20	16QAM	1	0	22.87	0-1	1
1900	19100	20	16QAM	1	50	22.85	0-1	1
1900	19100	20	16QAM	1	99	22.85	0-1	1
1900	19100	20	16QAM	50	0	21.97	0-2	2
1900	19100	20	16QAM	50	25	21.78	0-2	2
1900	19100	20	16QAM	50	50	21.83	0-2	2
1900	19100	20	16QAM	100	0	21.80	0-2	2

FCC ID: ZNFH950	 <b>PCTEST</b> ENGINEERING LABORATORY, INC.	<b>HAC (RF EMISSIONS) TEST REPORT</b>	 <b>LG</b>	Reviewed by: Quality Manager
Filename: OY1501120071-R1.ZNF	Test Dates: January 12-15, 2015	EUT Type: Portable Handset	Page 25 of 76	



**Table 8-11**  
**LTE Band 2 (1900 MHz) Conducted Powers - 15 MHz Bandwidth**

Frequency [MHz]	Channel	Bandwidth [MHz]	Modulation	RB Size	RB Offset	Conducted Power [dBm]	MPR Allowed per 3GPP [dB]	MPR [dB]
1857.5	18675	15	QPSK	1	0	23.93	0	0
1857.5	18675	15	QPSK	1	36	23.98	0	0
1857.5	18675	15	QPSK	1	74	23.90	0	0
1857.5	18675	15	QPSK	36	0	22.83	0-1	1
1857.5	18675	15	QPSK	36	18	22.83	0-1	1
1857.5	18675	15	QPSK	36	37	22.81	0-1	1
1857.5	18675	15	QPSK	75	0	22.86	0-1	1
1857.5	18675	15	16QAM	1	0	22.79	0-1	1
1857.5	18675	15	16QAM	1	36	22.85	0-1	1
1857.5	18675	15	16QAM	1	74	22.89	0-1	1
1857.5	18675	15	16QAM	36	0	21.82	0-2	2
1857.5	18675	15	16QAM	36	18	22.02	0-2	2
1857.5	18675	15	16QAM	36	37	21.81	0-2	2
1857.5	18675	15	16QAM	75	0	21.78	0-2	2
1880.0	18900	15	QPSK	1	0	23.81	0	0
1880.0	18900	15	QPSK	1	36	23.83	0	0
1880.0	18900	15	QPSK	1	74	23.90	0	0
1880.0	18900	15	QPSK	36	0	22.95	0-1	1
1880.0	18900	15	QPSK	36	18	22.80	0-1	1
1880.0	18900	15	QPSK	36	37	22.78	0-1	1
1880.0	18900	15	QPSK	75	0	22.82	0-1	1
1880.0	18900	15	16QAM	1	0	22.77	0-1	1
1880.0	18900	15	16QAM	1	36	22.83	0-1	1
1880.0	18900	15	16QAM	1	74	22.85	0-1	1
1880.0	18900	15	16QAM	36	0	21.80	0-2	2
1880.0	18900	15	16QAM	36	18	21.84	0-2	2
1880.0	18900	15	16QAM	36	37	21.89	0-2	2
1880.0	18900	15	16QAM	75	0	21.81	0-2	2
1902.5	19125	15	QPSK	1	0	24.03	0	0
1902.5	19125	15	QPSK	1	36	24.13	0	0
1902.5	19125	15	QPSK	1	74	23.84	0	0
1902.5	19125	15	QPSK	36	0	23.03	0-1	1
1902.5	19125	15	QPSK	36	18	22.91	0-1	1
1902.5	19125	15	QPSK	36	37	22.80	0-1	1
1902.5	19125	15	QPSK	75	0	22.79	0-1	1
1902.5	19125	15	16QAM	1	0	22.88	0-1	1
1902.5	19125	15	16QAM	1	36	22.86	0-1	1
1902.5	19125	15	16QAM	1	74	22.80	0-1	1
1902.5	19125	15	16QAM	36	0	21.90	0-2	2
1902.5	19125	15	16QAM	36	18	21.80	0-2	2
1902.5	19125	15	16QAM	36	37	21.92	0-2	2
1902.5	19125	15	16QAM	75	0	21.76	0-2	2

FCC ID: ZNFH950	 <b>PCTEST</b> ENGINEERING LABORATORY, INC.	<b>HAC (RF EMISSIONS) TEST REPORT</b>	 <b>LG</b>	Reviewed by: Quality Manager
Filename: OY1501120071-R1.ZNF	Test Dates: January 12-15, 2015	EUT Type: Portable Handset	Page 26 of 76	



**Table 8-12**  
**LTE Band 2 (1900 MHz) Conducted Powers - 10 MHz Bandwidth**

Frequency [MHz]	Channel	Bandwidth [MHz]	Modulation	RB Size	RB Offset	Conducted Power [dBm]	MPR Allowed per 3GPP [dB]	MPR [dB]
1855	18650	10	QPSK	1	0	23.99	0	0
1855	18650	10	QPSK	1	25	24.09	0	0
1855	18650	10	QPSK	1	49	23.82	0	0
1855	18650	10	QPSK	25	0	22.87	0-1	1
1855	18650	10	QPSK	25	12	22.80	0-1	1
1855	18650	10	QPSK	25	25	22.75	0-1	1
1855	18650	10	QPSK	50	0	22.77	0-1	1
1855	18650	10	16QAM	1	0	22.80	0-1	1
1855	18650	10	16QAM	1	25	22.88	0-1	1
1855	18650	10	16QAM	1	49	22.84	0-1	1
1855	18650	10	16QAM	25	0	21.83	0-2	2
1855	18650	10	16QAM	25	12	22.00	0-2	2
1855	18650	10	16QAM	25	25	21.74	0-2	2
1855	18650	10	16QAM	50	0	21.75	0-2	2
1880.0	18900	10	QPSK	1	0	23.81	0	0
1880.0	18900	10	QPSK	1	25	23.84	0	0
1880.0	18900	10	QPSK	1	49	23.92	0	0
1880.0	18900	10	QPSK	25	0	22.86	0-1	1
1880.0	18900	10	QPSK	25	12	22.89	0-1	1
1880.0	18900	10	QPSK	25	25	22.78	0-1	1
1880.0	18900	10	QPSK	50	0	22.78	0-1	1
1880.0	18900	10	16QAM	1	0	22.76	0-1	1
1880.0	18900	10	16QAM	1	25	22.81	0-1	1
1880.0	18900	10	16QAM	1	49	22.85	0-1	1
1880.0	18900	10	16QAM	25	0	21.81	0-2	2
1880.0	18900	10	16QAM	25	12	21.95	0-2	2
1880.0	18900	10	16QAM	25	25	21.85	0-2	2
1880.0	18900	10	16QAM	50	0	21.79	0-2	2
1905	19150	10	QPSK	1	0	24.03	0	0
1905	19150	10	QPSK	1	25	24.05	0	0
1905	19150	10	QPSK	1	49	23.87	0	0
1905	19150	10	QPSK	25	0	22.99	0-1	1
1905	19150	10	QPSK	25	12	22.81	0-1	1
1905	19150	10	QPSK	25	25	22.83	0-1	1
1905	19150	10	QPSK	50	0	22.74	0-1	1
1905	19150	10	16QAM	1	0	22.83	0-1	1
1905	19150	10	16QAM	1	25	22.88	0-1	1
1905	19150	10	16QAM	1	49	22.79	0-1	1
1905	19150	10	16QAM	25	0	21.88	0-2	2
1905	19150	10	16QAM	25	12	21.80	0-2	2
1905	19150	10	16QAM	25	25	21.81	0-2	2
1905	19150	10	16QAM	50	0	21.90	0-2	2

FCC ID: ZNFH950	 <b>PCTEST</b> ENGINEERING LABORATORY, INC.	<b>HAC (RF EMISSIONS) TEST REPORT</b>	 <b>LG</b>	Reviewed by: Quality Manager
Filename: OY1501120071-R1.ZNF	Test Dates: January 12-15, 2015	EUT Type: Portable Handset		Page 27 of 76



**Table 8-13**  
**LTE Band 2 (1900 MHz) Conducted Powers - 5 MHz Bandwidth**

Frequency [MHz]	Channel	Bandwidth [MHz]	Modulation	RB Size	RB Offset	Conducted Power [dBm]	MPR Allowed per 3GPP [dB]	MPR [dB]
1852.5	18625	5	QPSK	1	0	23.91	0	0
1852.5	18625	5	QPSK	1	12	24.10	0	0
1852.5	18625	5	QPSK	1	24	23.96	0	0
1852.5	18625	5	QPSK	12	0	23.01	0-1	1
1852.5	18625	5	QPSK	12	6	22.84	0-1	1
1852.5	18625	5	QPSK	12	13	22.74	0-1	1
1852.5	18625	5	QPSK	25	0	22.81	0-1	1
1852.5	18625	5	16-QAM	1	0	22.82	0-1	1
1852.5	18625	5	16-QAM	1	12	22.88	0-1	1
1852.5	18625	5	16-QAM	1	24	22.78	0-1	1
1852.5	18625	5	16-QAM	12	0	21.97	0-2	2
1852.5	18625	5	16-QAM	12	6	22.00	0-2	2
1852.5	18625	5	16-QAM	12	13	21.81	0-2	2
1852.5	18625	5	16-QAM	25	0	21.87	0-2	2
1880.0	18900	5	QPSK	1	0	23.87	0	0
1880.0	18900	5	QPSK	1	12	23.76	0	0
1880.0	18900	5	QPSK	1	24	23.95	0	0
1880.0	18900	5	QPSK	12	0	22.81	0-1	1
1880.0	18900	5	QPSK	12	6	22.92	0-1	1
1880.0	18900	5	QPSK	12	13	22.71	0-1	1
1880.0	18900	5	QPSK	25	0	22.82	0-1	1
1880.0	18900	5	16-QAM	1	0	22.77	0-1	1
1880.0	18900	5	16-QAM	1	12	22.75	0-1	1
1880.0	18900	5	16-QAM	1	24	22.83	0-1	1
1880.0	18900	5	16-QAM	12	0	21.76	0-2	2
1880.0	18900	5	16-QAM	12	6	21.83	0-2	2
1880.0	18900	5	16-QAM	12	13	21.98	0-2	2
1880.0	18900	5	16-QAM	25	0	21.79	0-2	2
1907.5	19175	5	QPSK	1	0	24.19	0	0
1907.5	19175	5	QPSK	1	12	24.08	0	0
1907.5	19175	5	QPSK	1	24	23.98	0	0
1907.5	19175	5	QPSK	12	0	23.07	0-1	1
1907.5	19175	5	QPSK	12	6	22.88	0-1	1
1907.5	19175	5	QPSK	12	13	22.81	0-1	1
1907.5	19175	5	QPSK	25	0	22.81	0-1	1
1907.5	19175	5	16-QAM	1	0	22.88	0-1	1
1907.5	19175	5	16-QAM	1	12	22.82	0-1	1
1907.5	19175	5	16-QAM	1	24	22.82	0-1	1
1907.5	19175	5	16-QAM	12	0	21.93	0-2	2
1907.5	19175	5	16-QAM	12	6	21.76	0-2	2
1907.5	19175	5	16-QAM	12	13	21.76	0-2	2
1907.5	19175	5	16-QAM	25	0	21.87	0-2	2

FCC ID: ZNFH950	 <b>PCTEST</b> ENGINEERING LABORATORY, INC.	<b>HAC (RF EMISSIONS) TEST REPORT</b>		Reviewed by: Quality Manager
Filename: OY1501120071-R1.ZNF	Test Dates: January 12-15, 2015	EUT Type: Portable Handset	Page 28 of 76	



**Table 8-14**  
**LTE Band 7 (2500 MHz) Conducted Powers - 20 MHz Bandwidth**

Frequency [MHz]	Channel	Bandwidth [MHz]	Modulation	RB Size	RB Offset	Conducted Power [dBm]	MPR Allowed per 3GPP [dB]	MPR [dB]
2510	20850	20	QPSK	1	0	23.49	0	0
2510	20850	20	QPSK	1	50	23.54	0	0
2510	20850	20	QPSK	1	99	23.41	0	0
2510	20850	20	QPSK	50	0	22.45	0-1	1
2510	20850	20	QPSK	50	25	22.33	0-1	1
2510	20850	20	QPSK	50	50	22.42	0-1	1
2510	20850	20	QPSK	100	0	22.29	0-1	1
2510	20850	20	16QAM	1	0	22.21	0-1	1
2510	20850	20	16QAM	1	50	22.20	0-1	1
2510	20850	20	16QAM	1	99	22.23	0-1	1
2510	20850	20	16QAM	50	0	21.36	0-2	2
2510	20850	20	16QAM	50	25	21.42	0-2	2
2510	20850	20	16QAM	50	50	21.35	0-2	2
2510	20850	20	16QAM	100	0	21.30	0-2	2
2535.0	21100	20	QPSK	1	0	23.35	0	0
2535.0	21100	20	QPSK	1	50	<b>23.62</b>	0	0
2535.0	21100	20	QPSK	1	99	23.54	0	0
2535.0	21100	20	QPSK	50	0	<b>22.53</b>	0-1	1
2535.0	21100	20	QPSK	50	25	22.33	0-1	1
2535.0	21100	20	QPSK	50	50	22.42	0-1	1
2535.0	21100	20	QPSK	100	0	22.31	0-1	1
2535.0	21100	20	16QAM	1	0	22.55	0-1	1
2535.0	21100	20	16QAM	1	50	22.59	0-1	1
2535.0	21100	20	16QAM	1	99	22.60	0-1	1
2535.0	21100	20	16QAM	50	0	21.48	0-2	2
2535.0	21100	20	16QAM	50	25	21.30	0-2	2
2535.0	21100	20	16QAM	50	50	21.33	0-2	2
2535.0	21100	20	16QAM	100	0	21.33	0-2	2
2560	21350	20	QPSK	1	0	23.60	0	0
2560	21350	20	QPSK	1	50	23.46	0	0
2560	21350	20	QPSK	1	99	23.30	0	0
2560	21350	20	QPSK	50	0	22.27	0-1	1
2560	21350	20	QPSK	50	25	22.31	0-1	1
2560	21350	20	QPSK	50	50	22.33	0-1	1
2560	21350	20	QPSK	100	0	22.30	0-1	1
2560	21350	20	16QAM	1	0	22.49	0-1	1
2560	21350	20	16QAM	1	50	22.40	0-1	1
2560	21350	20	16QAM	1	99	22.35	0-1	1
2560	21350	20	16QAM	50	0	21.45	0-2	2
2560	21350	20	16QAM	50	25	21.40	0-2	2
2560	21350	20	16QAM	50	50	21.33	0-2	2
2560	21350	20	16QAM	100	0	21.39	0-2	2

FCC ID: ZNFH950	 <b>PCTEST</b> ENGINEERING LABORATORY, INC.	<b>HAC (RF EMISSIONS) TEST REPORT</b>	 <b>LG</b>	Reviewed by: Quality Manager
Filename: OY1501120071-R1.ZNF	Test Dates: January 12-15, 2015	EUT Type: Portable Handset		Page 29 of 76



**Table 8-15  
LTE Band 7 (2500 MHz) Conducted Powers - 15 MHz Bandwidth**

Frequency [MHz]	Channel	Bandwidth [MHz]	Modulation	RB Size	RB Offset	Conducted Power [dBm]	MPR Allowed per 3GPP [dB]	MPR [dB]
2507.5	20825	15	QPSK	1	0	23.49	0	0
2507.5	20825	15	QPSK	1	36	23.51	0	0
2507.5	20825	15	QPSK	1	74	23.36	0	0
2507.5	20825	15	QPSK	36	0	22.52	0-1	1
2507.5	20825	15	QPSK	36	18	22.34	0-1	1
2507.5	20825	15	QPSK	36	37	22.42	0-1	1
2507.5	20825	15	QPSK	75	0	22.32	0-1	1
2507.5	20825	15	16QAM	1	0	22.20	0-1	1
2507.5	20825	15	16QAM	1	36	22.23	0-1	1
2507.5	20825	15	16QAM	1	74	22.22	0-1	1
2507.5	20825	15	16QAM	36	0	21.45	0-2	2
2507.5	20825	15	16QAM	36	18	21.38	0-2	2
2507.5	20825	15	16QAM	36	37	21.45	0-2	2
2507.5	20825	15	16QAM	75	0	21.36	0-2	2
2535.0	21100	15	QPSK	1	0	23.45	0	0
2535.0	21100	15	QPSK	1	36	23.68	0	0
2535.0	21100	15	QPSK	1	74	23.60	0	0
2535.0	21100	15	QPSK	36	0	22.59	0-1	1
2535.0	21100	15	QPSK	36	18	22.40	0-1	1
2535.0	21100	15	QPSK	36	37	22.38	0-1	1
2535.0	21100	15	QPSK	75	0	22.41	0-1	1
2535.0	21100	15	16QAM	1	0	22.57	0-1	1
2535.0	21100	15	16QAM	1	36	22.67	0-1	1
2535.0	21100	15	16QAM	1	74	22.67	0-1	1
2535.0	21100	15	16QAM	36	0	21.53	0-2	2
2535.0	21100	15	16QAM	36	18	21.32	0-2	2
2535.0	21100	15	16QAM	36	37	21.30	0-2	2
2535.0	21100	15	16QAM	75	0	21.36	0-2	2
2562.5	21375	15	QPSK	1	0	23.68	0	0
2562.5	21375	15	QPSK	1	36	23.56	0	0
2562.5	21375	15	QPSK	1	74	23.25	0	0
2562.5	21375	15	QPSK	36	0	22.36	0-1	1
2562.5	21375	15	QPSK	36	18	22.32	0-1	1
2562.5	21375	15	QPSK	36	37	22.28	0-1	1
2562.5	21375	15	QPSK	75	0	22.28	0-1	1
2562.5	21375	15	16QAM	1	0	22.51	0-1	1
2562.5	21375	15	16QAM	1	36	22.43	0-1	1
2562.5	21375	15	16QAM	1	74	22.39	0-1	1
2562.5	21375	15	16QAM	36	0	21.49	0-2	2
2562.5	21375	15	16QAM	36	18	21.47	0-2	2
2562.5	21375	15	16QAM	36	37	21.41	0-2	2
2562.5	21375	15	16QAM	75	0	21.42	0-2	2

FCC ID: ZNFH950	 <b>PCTEST</b> ENGINEERING LABORATORY, INC.	<b>HAC (RF EMISSIONS) TEST REPORT</b>		Reviewed by: Quality Manager
Filename: OY1501120071-R1.ZNF	Test Dates: January 12-15, 2015	EUT Type: Portable Handset		Page 30 of 76



**Table 8-16**  
**LTE Band 7 (2500 MHz) Conducted Powers - 10 MHz Bandwidth**

Frequency [MHz]	Channel	Bandwidth [MHz]	Modulation	RB Size	RB Offset	Conducted Power [dBm]	MPR Allowed per 3GPP [dB]	MPR [dB]
2505	20800	10	QPSK	1	0	23.49	0	0
2505	20800	10	QPSK	1	25	23.60	0	0
2505	20800	10	QPSK	1	49	23.51	0	0
2505	20800	10	QPSK	25	0	22.52	0-1	1
2505	20800	10	QPSK	25	12	22.28	0-1	1
2505	20800	10	QPSK	25	25	22.39	0-1	1
2505	20800	10	QPSK	50	0	22.36	0-1	1
2505	20800	10	16QAM	1	0	22.31	0-1	1
2505	20800	10	16QAM	1	25	22.23	0-1	1
2505	20800	10	16QAM	1	49	22.24	0-1	1
2505	20800	10	16QAM	25	0	21.39	0-2	2
2505	20800	10	16QAM	25	12	21.52	0-2	2
2505	20800	10	16QAM	25	25	21.40	0-2	2
2505	20800	10	16QAM	50	0	21.37	0-2	2
2535.0	21100	10	QPSK	1	0	23.34	0	0
2535.0	21100	10	QPSK	1	25	23.70	0	0
2535.0	21100	10	QPSK	1	49	23.59	0	0
2535.0	21100	10	QPSK	25	0	22.51	0-1	1
2535.0	21100	10	QPSK	25	12	22.34	0-1	1
2535.0	21100	10	QPSK	25	25	22.40	0-1	1
2535.0	21100	10	QPSK	50	0	22.31	0-1	1
2535.0	21100	10	16QAM	1	0	22.53	0-1	1
2535.0	21100	10	16QAM	1	25	22.60	0-1	1
2535.0	21100	10	16QAM	1	49	22.58	0-1	1
2535.0	21100	10	16QAM	25	0	21.54	0-2	2
2535.0	21100	10	16QAM	25	12	21.27	0-2	2
2535.0	21100	10	16QAM	25	25	21.37	0-2	2
2535.0	21100	10	16QAM	50	0	21.37	0-2	2
2565	21400	10	QPSK	1	0	23.64	0	0
2565	21400	10	QPSK	1	25	23.44	0	0
2565	21400	10	QPSK	1	49	23.31	0	0
2565	21400	10	QPSK	25	0	22.31	0-1	1
2565	21400	10	QPSK	25	12	22.32	0-1	1
2565	21400	10	QPSK	25	25	22.35	0-1	1
2565	21400	10	QPSK	50	0	22.29	0-1	1
2565	21400	10	16QAM	1	0	22.58	0-1	1
2565	21400	10	16QAM	1	25	22.42	0-1	1
2565	21400	10	16QAM	1	49	22.42	0-1	1
2565	21400	10	16QAM	25	0	21.43	0-2	2
2565	21400	10	16QAM	25	12	21.44	0-2	2
2565	21400	10	16QAM	25	25	21.31	0-2	2
2565	21400	10	16QAM	50	0	21.41	0-2	2

FCC ID: ZNFH950	 <b>PCTEST</b> ENGINEERING LABORATORY, INC.	<b>HAC (RF EMISSIONS) TEST REPORT</b>		Reviewed by: Quality Manager
Filename: OY1501120071-R1.ZNF	Test Dates: January 12-15, 2015	EUT Type: Portable Handset		Page 31 of 76

**Table 8-17**  
**LTE Band 7 (2500 MHz) Conducted Powers - 5 MHz Bandwidth**

Frequency [MHz]	Channel	Bandwidth [MHz]	Modulation	RB Size	RB Offset	Conducted Power [dBm]	MPR Allowed per 3GPP [dB]	MPR [dB]
2502.5	20775	5	QPSK	1	0	23.47	0	0
2502.5	20775	5	QPSK	1	12	23.49	0	0
2502.5	20775	5	QPSK	1	24	23.46	0	0
2502.5	20775	5	QPSK	12	0	22.52	0-1	1
2502.5	20775	5	QPSK	12	6	22.36	0-1	1
2502.5	20775	5	QPSK	12	13	22.42	0-1	1
2502.5	20775	5	QPSK	25	0	22.35	0-1	1
2502.5	20775	5	16-QAM	1	0	22.31	0-1	1
2502.5	20775	5	16-QAM	1	12	22.30	0-1	1
2502.5	20775	5	16-QAM	1	24	22.29	0-1	1
2502.5	20775	5	16-QAM	12	0	21.45	0-2	2
2502.5	20775	5	16-QAM	12	6	21.38	0-2	2
2502.5	20775	5	16-QAM	12	13	21.40	0-2	2
2502.5	20775	5	16-QAM	25	0	21.33	0-2	2
2535.0	21100	5	QPSK	1	0	23.36	0	0
2535.0	21100	5	QPSK	1	12	23.70	0	0
2535.0	21100	5	QPSK	1	24	23.58	0	0
2535.0	21100	5	QPSK	12	0	22.49	0-1	1
2535.0	21100	5	QPSK	12	6	22.28	0-1	1
2535.0	21100	5	QPSK	12	13	22.46	0-1	1
2535.0	21100	5	QPSK	25	0	22.40	0-1	1
2535.0	21100	5	16-QAM	1	0	22.57	0-1	1
2535.0	21100	5	16-QAM	1	12	22.61	0-1	1
2535.0	21100	5	16-QAM	1	24	22.59	0-1	1
2535.0	21100	5	16-QAM	12	0	21.57	0-2	2
2535.0	21100	5	16-QAM	12	6	21.30	0-2	2
2535.0	21100	5	16-QAM	12	13	21.33	0-2	2
2535.0	21100	5	16-QAM	25	0	21.28	0-2	2
2567.5	21425	5	QPSK	1	0	23.64	0	0
2567.5	21425	5	QPSK	1	12	23.46	0	0
2567.5	21425	5	QPSK	1	24	23.28	0	0
2567.5	21425	5	QPSK	12	0	22.32	0-1	1
2567.5	21425	5	QPSK	12	6	22.34	0-1	1
2567.5	21425	5	QPSK	12	13	22.32	0-1	1
2567.5	21425	5	QPSK	25	0	22.29	0-1	1
2567.5	21425	5	16-QAM	1	0	22.50	0-1	1
2567.5	21425	5	16-QAM	1	12	22.48	0-1	1
2567.5	21425	5	16-QAM	1	24	22.35	0-1	1
2567.5	21425	5	16-QAM	12	0	21.55	0-2	2
2567.5	21425	5	16-QAM	12	6	21.38	0-2	2
2567.5	21425	5	16-QAM	12	13	21.42	0-2	2
2567.5	21425	5	16-QAM	25	0	21.48	0-2	2

FCC ID: ZNFH950	 <b>PCTEST</b> ENGINEERING LABORATORY, INC.	<b>HAC (RF EMISSIONS) TEST REPORT</b>		Reviewed by: Quality Manager
Filename: OY1501120071-R1.ZNF	Test Dates: January 12-15, 2015	EUT Type: Portable Handset		Page 32 of 76



## 9. JUSTIFICATION OF HELD TO EAR MODES TESTED

### I. Analysis of RF Air Interface Technologies

- a. According to the April 2013 TCB workshop slides, WIFI and other OTT data services are outside the current definition of a managed CMRS service and are currently not required to be evaluated.
- b. VoLTE air interfaces were not tested in accordance with the guidance issued by OET in KDB publication 285076 D02 T-Coil testing for CMRS IP.
- c. An analysis was performed, following the guidance of §4.3 and §4.4 of the ANSI standard, of the RF air interface technologies being evaluated. The factors that will affect the RF interference potential were evaluated, and the worst case operating modes were identified and used in the evaluation. A WD's interference potential is a function both of the WD's average near-field field strength and of the signal's audio-frequency amplitude modulation characteristics. Per §4.4, RF air interface technologies that have low power have been found to produce sufficiently low RF interference potential, so it is possible to exempt them from the product testing specified in Clause 5 of the ANSI standard. An RF air interface technology of a device is exempt from testing when its average antenna input power plus its MIF is  $\leq 17$ dBm for all of its operating modes.

The worst case MIF plus the worst case average antenna input power for all modes are investigated below to determine the testing requirements for this device.

### II. Individual Mode Evaluations



Air Interface	Maximum Average Power (dBm)	Worst Case MIF (dB)	Total (Power + MIF, dB)	C63.19 Testing Required
GSM850	24.15*	3.51	27.66	Yes
GSM1900	21.12*	3.51	24.63	Yes
UMTS - RMC	23.70	-17.39	6.31	No
UMTS - AMR	23.63	-14.74	8.89	No
LTE - FDD	24.66	-9.96	14.70	No

**Table 9-1**  
Max Power + MIF calculations  
for Low Power Exemptions

\* Note: C63.19 Footnote 20 (pg.13) indicates the use of a long averaging time for measuring the antenna input power when using this method of exclusion. Therefore, the frame averaged power was calculated for these modes in this investigation.

### III. Low-Power Exemption Conclusions

Per ANSI C63.19-2011, RF Emissions testing for this device is required only for GSM voice modes. All other air interfaces are exempt.

FCC ID: ZNFH950		HAC (RF EMISSIONS) TEST REPORT	
Filename: OY1501120071-R1.ZNF	Test Dates: January 12-15, 2015	EUT Type: Portable Handset	Reviewed by: Quality Manager  Page 33 of 76

## 10. OVERALL MEASUREMENT SUMMARY

<b>FCC ID:</b>	ZNFH950
<b>Model:</b>	LG-H950, LGH950, H950
<b>S/N:</b>	1301-4

### I. E-FIELD EMISSIONS:

**Table 10-1  
HAC Data Summary for E-field**

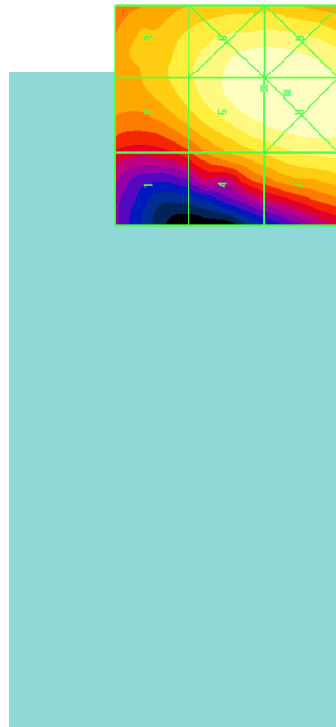

Mode	Channel	Backlight	Scan Center	Conducted Power at BS (dBm)	Time Avg. Field (V/m)	Time Avg. Field [dB(V/m)]	MIF (dB)	Audio Interference Level [dB(V/m)]	FCC Limit (dBV/m)	FCC MARGIN (dB)	RESULT	Excl Blocks per 5.5
<b>E-field Emissions</b>												
GSM850	128	Standard	Acoustic	33.17	51.94	34.31	3.51	37.82	45.00	-7.18	M4	none
GSM850	190	Standard	Acoustic	33.04	49.63	33.91	3.51	37.42	45.00	-7.58	M4	none
GSM850	251	Standard	Acoustic	33.18	53.85	34.62	3.51	38.13	45.00	-6.87	M4	none
GSM1900	512	Standard	Acoustic	30.01	25.65	28.18	3.50	31.68	35.00	-3.32	M3	6,8,9
GSM1900	661	Standard	Acoustic	29.82	28.20	29.00	3.50	32.50	35.00	-2.50	M3	6,8,9
GSM1900	810	Standard	Acoustic	30.15	24.19	27.67	3.51	31.18	35.00	-3.82	M3	6,8,9
GSM1900	661	Standard	T-coil	29.82	29.10	29.28	3.50	32.78	35.00	-2.22	M3	6,8,9



**Figure 10-1**

Sample E-field Scan Overlay

(T-Coil Centered Scan pictured. See Test Setup Photographs for Acoustic Scan Overlay and actual WD overlay)

<b>FCC ID:</b> ZNFH950	 <b>PCTEST</b> <small>ENGINEERING LABORATORY, INC.</small>	<b>HAC (RF EMISSIONS) TEST REPORT</b>	 <b>LG</b>	<b>Reviewed by:</b> Quality Manager
<b>Filename:</b> OY1501120071-R1.ZNF	<b>Test Dates:</b> January 12-15, 2015	<b>EUT Type:</b> Portable Handset		Page 34 of 76

FCC ID:	ZNFH950
Model:	LG-H950, LGH950, H950
S/N:	1301-4

## II. Worst-case Configuration Evaluation

**Table 10-2**  
**Peak Reading 360° Probe Rotation at Azimuth axis**

Mode	Channel	Battery Cover	Scan Center	Time Avg. Field (V/m)	Time Avg. Field [dB(V/m)]	MIF (dB)	Audio Interference Level [dB(V/m)]	FCC Limit (dBV/m)	FCC MARGIN (dB)	RESULT	Excl Blocks per 5.5
<b>Probe Rotation at Worst-Case</b>											
GSM1900	661	Standard	T-coil	30.03	29.55	3.50	33.05	35.00	-1.95	M3	6,8,9

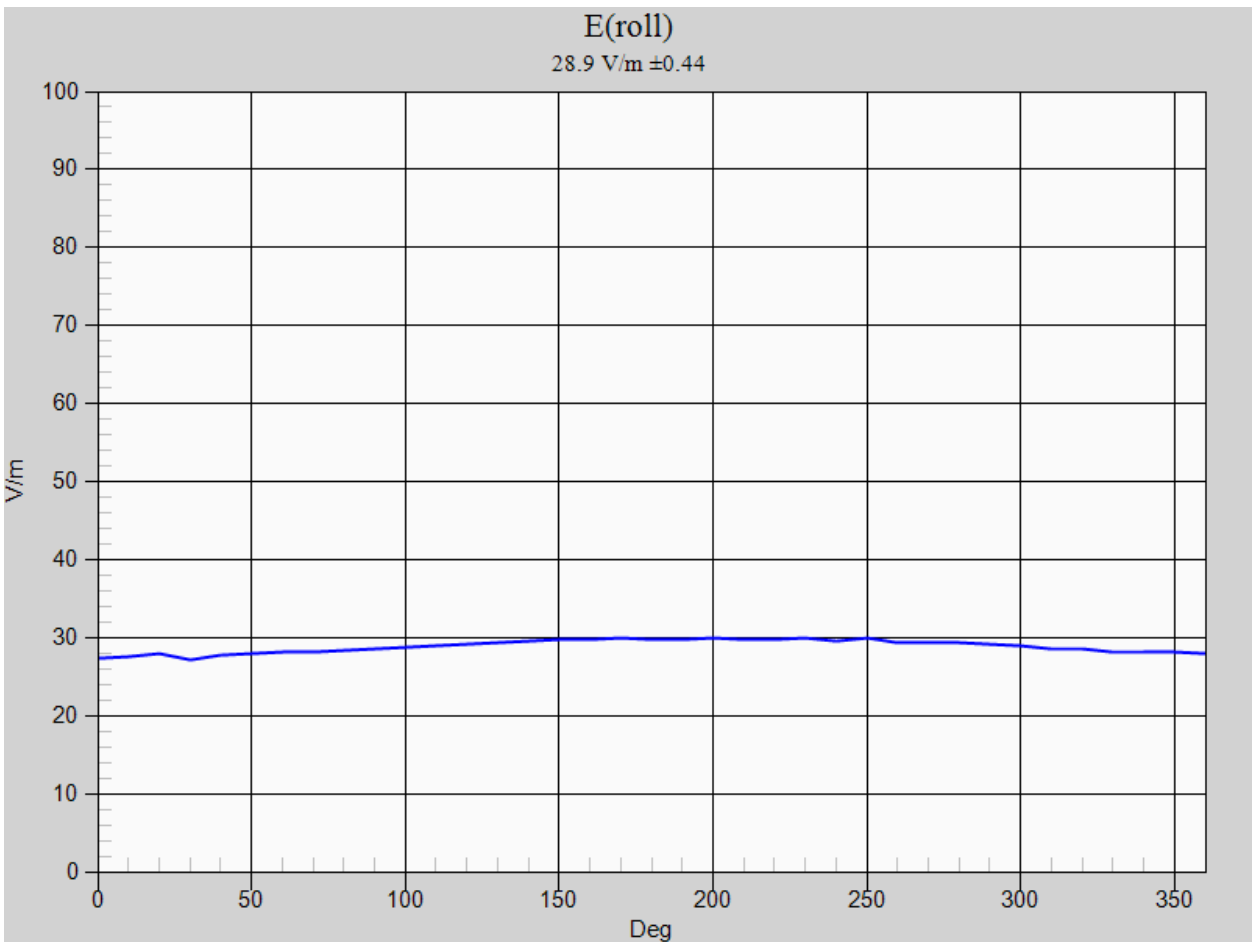

**Figure 10-2**  
**Worst-Case Probe Rotation about Azimuth axis**

\* Note: Locations of probe rotation (with and without exclusions) are shown in Figure 10-1 denoted by the green square markers.

FCC ID: ZNFH950	PCTEST ENGINEERING LABORATORY, INC.	HAC (RF EMISSIONS) TEST REPORT	LG	Reviewed by: Quality Manager
Filename: OY1501120071-R1.ZNF	Test Dates: January 12-15, 2015	EUT Type: Portable Handset	Page 35 of 76	



## 11. EQUIPMENT LIST

Manufacturer	Model	Description	Cal Date	Cal Interval	Cal Due	Serial Number
Agilent	E4407B	ESA Spectrum Analyzer	4/16/2014	Annual	4/16/2015	US39210313
Agilent	E4438C	ESG Vector Signal Generator	3/31/2014	Annual	3/31/2015	MY42082659
Agilent	E4432B	ESG-D Series Signal Generator	4/15/2014	Annual	4/15/2015	US40053896
Agilent	N5182A	MXG Vector Signal Generator	4/15/2014	Annual	4/15/2015	MY47420800
Agilent	N5182A	MXG Vector Signal Generator	4/15/2014	Annual	4/15/2015	MY47420651
Agilent	E5515C	Wireless Communications Test Set	3/28/2014	Annual	3/28/2015	GB42230325
Amplifier Research	15S1G6	Amplifier	N/A	CBT*	N/A	433971
Anritsu	ML2469A	Power Meter	3/14/2014	Annual	3/14/2015	1306009
Anritsu	MA24106A	USB Power Sensor	5/15/2014	Annual	5/15/2015	1244524
Anritsu	MA24106A	USB Power Sensor	5/15/2014	Annual	5/15/2015	1244512
Control Company	36934-158	Wall-Mounted Thermometer	4/29/2014	Biennial	4/29/2016	122014488
Mini-Circuits	NLP-1200+	Low Pass Filter DC to 1000 MHz	N/A	CBT*	N/A	N/A
Mini-Circuits	NLP-2950+	Low Pass Filter DC to 2700 MHz	N/A	CBT*	N/A	N/A
Mini-Circuits	BW-N20W5	Power Attenuator	N/A	CBT*	N/A	1226
Pasternack	PE2208-6	Bidirectional Coupler	N/A	CBT*	N/A	N/A
Pasternack	PE2209-10	Bidirectional Coupler	N/A	CBT*	N/A	N/A
Pasternack	PE2237-20	Bidirectional Coupler	N/A	CBT*	N/A	N/A
Rohde & Schwarz	CMU200	Base Station Simulator	4/24/2014	Annual	4/24/2015	836371/0079
Rohde & Schwarz	CMU200	Base Station Simulator	6/6/2014	Annual	6/6/2015	109892
Rohde & Schwarz	CMW500	Radio Communication Tester	2/20/2014	Annual	2/20/2015	128633
Seekonk	NC-100	Torque Wrench	3/18/2014	Biennial	3/18/2016	N/A
Speag	AIA	Audio Interference Analyzer	N/A	CBT*	N/A	1010
SPEAG	DAE4	Dasy Data Acquisition Electronics	9/19/2014	Annual	9/19/2015	1449
SPEAG	CD1880V3	Freespace 1880 MHz Dipole	2/5/2013	Biennial	2/5/2015	1137
SPEAG	CD835V3	Freespace 835 MHz Dipole	2/5/2013	Biennial	2/5/2015	1003
SPEAG	ER3DV6	Freespace E-field Probe	8/18/2014	Annual	8/18/2015	2335

**Table 11-1**  
Equipment List

Calibration traceable to the National Institute of Standards and Technology (NIST).

**\*Note: CBT (Calibrated Before Testing).** Prior to testing, the measurement paths containing a cable, attenuator, coupler or filter were connected to a calibrated source (i.e. a signal generator) to determine the losses of the measurement path. The power meter offset was then adjusted to compensate for the measurement system losses. This level offset is stored within the power meter before measurements are made. This calibration verification procedure applies to the system verification and output power measurements. The calibrated reading is then taken directly from the power meter after compensation of the losses for all final power measurements.

FCC ID: ZNFH950	 <b>PCTEST</b> ENGINEERING LABORATORY, INC.	<b>HAC (RF EMISSIONS) TEST REPORT</b>		Reviewed by: Quality Manager
Filename: OY1501120071-R1.ZNF	Test Dates: January 12-15, 2015	EUT Type: Portable Handset	Page 36 of 76	

## 12. MEASUREMENT UNCERTAINTY



Wireless Communications Device Near-Field Measurement Uncertainty Estimation							
Uncertainty Component	Data (dB)	Data Type	Prob. Dist.	Divisor	Ci (E)	Unc. (dB)	Notes/Comments
<b>Measurement System</b>							
RF System Reflections	0.50	Tolerance	N	1.00	1	0.50	* Refl. < -20 dB
Field Probe Calibration	0.21	Tolerance	N	1.00	1	0.21	
Field Probe Isotropy	0.01	Tolerance	N	1.00	1	0.01	
Field Probe Frequency Response	0.135	Tolerance	N	1.00	1	0.14	
Field Probe Linearity	0.013	Tolerance	N	1.00	1	0.01	
Modulation Interference Factor	0.20	Tolerance	R	1.73	1	0.12	Applicable for M-rating testing
Boundary Effects	0.105	Accuracy	R	1.73	1	0.06	*
Probe Positioning Accuracy	0.20	Accuracy	R	1.73	1	0.12	*
Probe Positioner	0.050	Accuracy	R	1.73	1	0.03	*
Extrapolation/Interpolation	0.045	Tolerance	R	1.73	1	0.03	*
Resolution to 2mm error	0.21	Tolerance	N	1.00	1	0.21	
System Detection Limit	0.05	Tolerance	R	1.73	1	0.03	*
Readout Electronics	0.015	Tolerance	N	1.00	1	0.02	*
Integration Time	0.11	Tolerance	R	1.73	1	0.06	*
Response Time	0.033	Tolerance	R	1.73	1	0.02	*
Phantom Thickness	0.10	Tolerance	R	1.73	1	0.06	*
System Repeatability (Field x 2=power)	0.17	Tolerance	N	1.00	1	0.17	*
<b>Test Sample Related</b>							
Device Positioning Vertical	0.2	Tolerance	R	1.73	1	0.12	*
Device Positioning Lateral	0.045	Tolerance	R	1.73	1	0.03	*
Device Holder and Phantom	0.1	Tolerance	R	1.73	1	0.06	*
Power Drift	0.21	Tolerance	R	1.73	1	0.12	
<i>Combined Standard Uncertainty (k=1)</i>						0.66	16.3%
<i>Expanded Uncertainty [95% confidence]</i>						1.31	32.6%
<i>Expanded Uncertainty [95% confidence] on Field</i>						0.66	16.3%

**Table 12-1**  
Uncertainty Estimation Table

Notes:



1. Test equipments are calibrated according to techniques outlined in NIS81, NIS3003 and NIST Tech Note 1297. All equipments have traceability according to NIST. Measurement Uncertainties are defined in further detail in NIS 81 and NIST Tech Note 1297 and UKAS M3003.
2. \* Uncertainty specifications from Schmidt & Partner Engineering AG (not site specific)

Measurement uncertainty reflects the quality and accuracy of a measured result as compared to the true value. Such statements are generally required when stating results of measurements so that it is clear to the intended audience that the results may differ when reproduced by different facilities. Measurement results vary due to the measurement uncertainty of the instrumentation, measurement technique, and test engineer. Most uncertainties are calculated using the tolerances of the instrumentation used in the measurement, the measurement setup variability, and the technique used in performing the test. While not generally included, the variability of the equipment under test also figures into the overall measurement uncertainty. Another component of the overall uncertainty is based on the variability of repeated measurements (so-called Type A uncertainty). This may mean that the Hearing Aid immunity tests may have to be repeated by taking down the test setup and resetting it up so that there are a statistically significant number of repeat measurements to identify the measurement uncertainty. By combining the repeat measurement results with that of the instrumentation chain using the technique contained in NIS 81 and NIS 3003, the overall measurement uncertainty was estimated.

FCC ID: ZNFH950	 <b>PCTEST</b> <small>ENGINEERING LABORATORY, INC.</small>	<b>HAC (RF EMISSIONS) TEST REPORT</b>	 <b>LG</b>	Reviewed by: Quality Manager
Filename: OY1501120071-R1.ZNF	Test Dates: January 12-15, 2015	EUT Type: Portable Handset	Page 37 of 76	

## 13. TEST DATA

See following Attached Pages for Test Data.

<b>FCC ID:</b> ZNFH950	 <b>PCTEST</b> ENGINEERING LABORATORY, INC.	<b>HAC (RF EMISSIONS) TEST REPORT</b>	 <b>LG</b>	<b>Reviewed by:</b> Quality Manager
<b>Filename:</b> 0Y1501120071-R1.ZNF	<b>Test Dates:</b> January 12-15, 2015	<b>EUT Type:</b> Portable Handset	Page 38 of 76	

  
**PCTEST Hearing-Aid Compatibility Facility**

**DUT: CD835V3 - SN1003**

Type: CD835V3  
Serial: 1003

**Communication System: CW; Frequency: 835 MHz;**

Measurement Standard: DASYS (IEEE/IEC/ANSI C63.19-2011)

DASY5 Configuration:



- Probe: ER3DV6 - SN2335; Calibrated: 08/18/2014
- Sensor-Surface: 0mm (Fix Surface)
- Electronics: DAE4 Sn1449; Calibrated: 09/19/2014
- Phantom: HAC Test Arch with AMCC, Center; Type: SD HAC P01 BA;
- Measurement SW: DASY52, Version 52.8 (7);

**835 MHz / 100mW HAC Dipole Validation at 15mm/Hearing Aid Compatibility Test (41x361x1):**

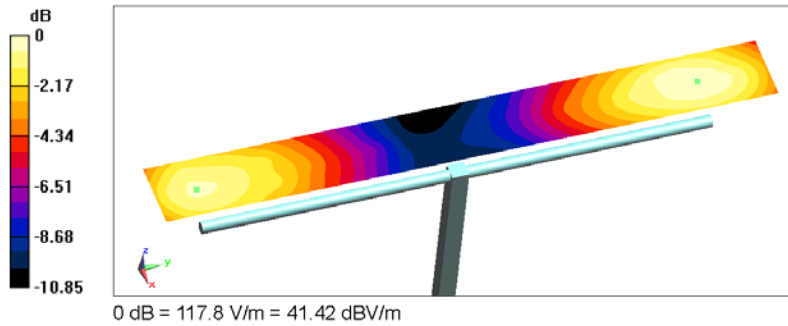
Interpolated grid: dx=0.5000 mm, dy=0.5000 mm  
 Device Reference Point: 0, 0, -6.3 mm  
 Reference Value = 137.6 V/m; Power Drift = -0.16 dB  
 Applied MIF = 0.00 dB  
 Average Value of Peak (interpolated) = 113.9 V/m



2015 PCTEST

<b>FCC ID:</b> ZNFH950		<b>HAC (RF EMISSIONS) TEST REPORT</b>	 <b>Reviewed by:</b> Quality Manager
<b>Filename:</b> 0Y1501120071-R1.ZNF	<b>Test Dates:</b> January 12-15, 2015	<b>EUT Type:</b> Portable Handset	Page 39 of 76

  
**PCTEST Hearing-Aid Compatibility Facility**

**DUT: CD1880V3 - SN1137**

Type: CD1880V3  
Serial: 1137

**Communication System: CW; Frequency: 1880 MHz;**

Measurement Standard: DASYS (IEEE/IEC/ANSI C63.19-2011)

DASY5 Configuration:



- Probe: ER3DV6 - SN2335; Calibrated: 08/18/2014
- Sensor-Surface: 0mm (Fix Surface)
- Electronics: DAE4 Sn1449; Calibrated: 09/19/2014
- Phantom: HAC Test Arch with AMCC, Center; Type: SD HAC P01 BA;
- Measurement SW: DASY52, Version 52.8 (7);

**1880 MHz / 100mW HAC Dipole Validation at 15mm/Hearing Aid Compatibility Test (41x181x1):**

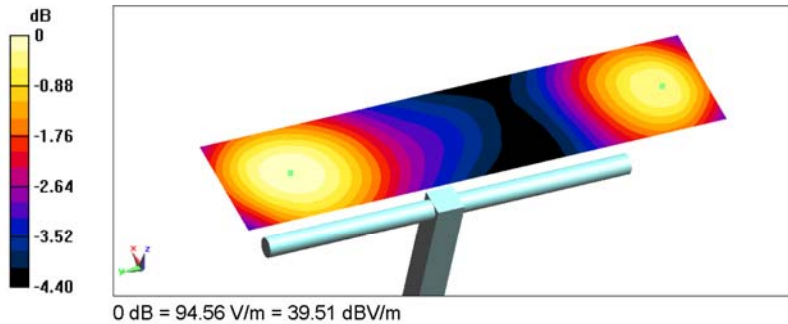
Interpolated grid: dx=0.5000 mm, dy=0.5000 mm  
 Device Reference Point: 0, 0, -6.3 mm  
 Reference Value = 149.5 V/m; Power Drift = 0.06 dB  
 Applied MIF = 0.00 dB  
 Average Value of Peak (interpolated) = 93.0 V/m



2015 PCTEST

<b>FCC ID:</b> ZNFH950	 <small>ENGINEERING LABORATORY, INC.</small>	<b>HAC (RF EMISSIONS) TEST REPORT</b>		<b>Reviewed by:</b> Quality Manager
<b>Filename:</b> 0Y1501120071-R1.ZNF	<b>Test Dates:</b> January 12-15, 2015	<b>EUT Type:</b> Portable Handset	Page 40 of 76	





**DUT: ZNFH950**

Type: Portable Handset  
 Serial: 1301-4  
 Backlight off  
 Duty Cycle: 1:8.3

**Communication System: GSM; Frequency: 848.8 MHz;**

Measurement Standard: DASYS (IEEE/IEC/ANSI C63.19-2011)

DASY5 Configuration:

- Probe: ER3DV6 - SN2335; Calibrated: 08/18/2014
- Sensor-Surface: (Fix Surface)
- Electronics: DAE4 Sn1449; Calibrated: 09/19/2014
- Phantom: HAC Test Arch with AMCC, Center; Type: SD HAC P01 BA;
- Measurement SW: DASYS2, Version 52.8 (7);

**GSM850 High Channel Acoustic Center Scan/Hearing Aid Compatibility Test (101x101x1):**

Interpolated grid: dx=0.5000 mm, dy=0.5000 mm  
 Device Reference Point: 0, 0, -6.3 mm  
 Reference Value = 59.48 V/m; Power Drift = 0.19 dB  
 Applied MIF = 3.51 dB  
 RF audio interference level = 38.13 dBV/m  
**Emission category: M4**

MIF scaled E-field

Grid 1 <b>M4</b> 37.37 dBV/m	Grid 2 <b>M4</b> 38.13 dBV/m	Grid 3 <b>M4</b> 37.9 dBV/m
Grid 4 <b>M4</b> 36.46 dBV/m	Grid 5 <b>M4</b> 37.67 dBV/m	Grid 6 <b>M4</b> 37.51 dBV/m
Grid 7 <b>M4</b> 35.68 dBV/m	Grid 8 <b>M4</b> 36.82 dBV/m	Grid 9 <b>M4</b> 36.65 dBV/m



2015 PCTEST

<b>FCC ID:</b> ZNFH950	<b>PCTEST</b> ENGINEERING LABORATORY, INC.	<b>HAC (RF EMISSIONS) TEST REPORT</b>	<b>LG</b>	<b>Reviewed by:</b> Quality Manager
<b>Filename:</b> OY1501120071-R1.ZNF	<b>Test Dates:</b> January 12-15, 2015	<b>EUT Type:</b> Portable Handset	Page 41 of 76	



**DUT: ZNFH950**

Type: Portable Handset  
 Serial: 1301-4  
 Backlight off  
 Duty Cycle: 1:8.3

**Communication System: GSM; Frequency: 1880 MHz;**

Measurement Standard: DASYS5 (IEEE/IEC/ANSI C63.19-2011)

DASY5 Configuration:

- Probe: ER3DV6 - SN2335; Calibrated: 08/18/2014
- Sensor-Surface: (Fix Surface)
- Electronics: DAE4 Sn1449; Calibrated: 09/19/2014
- Phantom: HAC Test Arch with AMCC, Center; Type: SD HAC P01 BA;
- Measurement SW: DASY52, Version 52.8 (7);

**GSM1900 Mid Channel T-Coil Center Scan/Hearing Aid Compatibility Test (101x101x1):**

Interpolated grid: dx=0.5000 mm, dy=0.5000 mm  
 Device Reference Point: 0, 0, -6.3 mm  
 Reference Value = 33.15 V/m; Power Drift = -0.14 dB  
 Applied MIF = 3.50 dB  
 RF audio interference level = 32.78 dBV/m  
**Emission category: M3**

MIF scaled E-field

Grid 1 M4	Grid 2 M3	Grid 3 M3
<b>27.45 dBV/m</b>	<b>30.67 dBV/m</b>	<b>30.71 dBV/m</b>
Grid 4 M3	Grid 5 M3	Grid 6 M3
<b>30.14 dBV/m</b>	<b>32.29 dBV/m</b>	<b>32.2 dBV/m</b>
Grid 7 M3	Grid 8 M3	Grid 9 M3
<b>31.06 dBV/m</b>	<b>32.39 dBV/m</b>	<b>32.26 dBV/m</b>





2015 PCTEST

FCC ID: ZNFH950	PCTEST ENGINEERING LABORATORY, INC.	HAC (RF EMISSIONS) TEST REPORT	LG	Reviewed by: Quality Manager
Filename: 0Y1501120071-R1.ZNF	Test Dates: January 12-15, 2015	EUT Type: Portable Handset	Page 42 of 76	

## 14. CALIBRATION CERTIFICATES

The following pages include the probe calibration used to evaluate HAC for the DUT.

<b>FCC ID:</b> ZNFH950	 <b>PCTEST</b> ENGINEERING LABORATORY, INC.	<b>HAC (RF EMISSIONS) TEST REPORT</b>	 <b>LG</b>	<b>Reviewed by:</b> Quality Manager
<b>Filename:</b> 0Y1501120071-R1.ZNF	<b>Test Dates:</b> January 12-15, 2015	<b>EUT Type:</b> Portable Handset	Page 43 of 76	

**Calibration Laboratory of  
Schmid & Partner  
Engineering AG**  
Zeughausstrasse 43, 8004 Zurich, Switzerland



**S** Schweizerischer Kalibrierdienst  
**S** Service suisse d'étalonnage  
**S** Servizio svizzero di taratura  
**S** Swiss Calibration Service

Accredited by the Swiss Accreditation Service (SAS)  
The Swiss Accreditation Service is one of the signatories to the EA  
Multilateral Agreement for the recognition of calibration certificates

Accreditation No.: **SCS 108**

Client **PC Test**

Certificate No: **ER3-2335\_Aug14**

**CALIBRATION CERTIFICATE**

Object: **ER3DV6 - SN:2335**

Calibration procedure(s): **QA CAL-02.v8, QA CAL-25.v6  
Calibration procedure for E-field probes optimized for close near field  
evaluations in air**

Calibration date: **August 18, 2014**

This calibration certificate documents the traceability to national standards, which realize the physical units of measurements (SI).  
The measurements and the uncertainties with confidence probability are given on the following pages and are part of the certificate.

All calibrations have been conducted in the closed laboratory facility: environment temperature (22 ± 3)°C and humidity < 70%.

Calibration Equipment used (M&TE critical for calibration)

*KOK  
7/31/14*

Primary Standards	ID	Cal Date (Certificate No.)	Scheduled Calibration
Power meter E4419B	GB41293874	03-Apr-14 (No. 217-01911)	Apr-15
Power sensor E4412A	MY41498087	03-Apr-14 (No. 217-01911)	Apr-15
Reference 3 dB Attenuator	SN: S5054 (3c)	03-Apr-14 (No. 217-01915)	Apr-15
Reference 20 dB Attenuator	SN: S5277 (20x)	03-Apr-14 (No. 217-01919)	Apr-15
Reference 30 dB Attenuator	SN: S5129 (30b)	03-Apr-14 (No. 217-01920)	Apr-15
Reference Probe ER3DV6	SN: 2328	10-Oct-13 (No. ER3-2328_Oct13)	Oct-14
DAE4	SN: 789	30-Apr-14 (No. DAE4-789_Apr14)	Apr-15
Secondary Standards	ID	Check Date (in house)	Scheduled Check
RF generator HP 8648C	US3642U01700	4-Aug-99 (in house check Apr-13)	In house check: Apr-16
Network Analyzer HP 8753E	US37390585	18-Oct-01 (in house check Oct-13)	In house check: Oct-14

Calibrated by:	Name: <b>Leif Klysner</b>	Function: <b>Laboratory Technician</b>	Signature: <i>Leif Klysner</i>
Approved by:	Name: <b>Katja Pokovic</b>	Function: <b>Technical Manager</b>	Signature: <i>Katja Pokovic</i>
			Issued: August 19, 2014

This calibration certificate shall not be reproduced except in full without written approval of the laboratory.

FCC ID: ZNFH950	PCTEST ENGINEERING LABORATORY, INC.	HAC (RF EMISSIONS) TEST REPORT	LG	Reviewed by: Quality Manager
Filename: OY1501120071-R1.ZNF	Test Dates: January 12-15, 2015	EUT Type: Portable Handset	Page 44 of 76	

**Calibration Laboratory of  
Schmid & Partner  
Engineering AG**  
Zeughausstrasse 43, 8004 Zurich, Switzerland



**S** Schweizerischer Kalibrierdienst  
**C** Service suisse d'étalonnage  
**S** Servizio svizzero di taratura  
**S** Swiss Calibration Service

Accredited by the Swiss Accreditation Service (SAS)  
The Swiss Accreditation Service is one of the signatories to the EA  
Multilateral Agreement for the recognition of calibration certificates

Accreditation No.: **SCS 108**

**Glossary:**

$NORM_{x,y,z}$  sensitivity in free space  
DCP diode compression point  
CF crest factor (1/duty\_cycle) of the RF signal  
A, B, C, D modulation dependent linearization parameters  
Polarization  $\phi$   $\phi$  rotation around probe axis  
Polarization  $\vartheta$   $\vartheta$  rotation around an axis that is in the plane normal to probe axis (at measurement center),  
i.e.,  $\vartheta = 0$  is normal to probe axis  
Connector Angle information used in DASY system to align probe sensor X to the robot coordinate system

**Calibration is Performed According to the Following Standards:**

- a) IEEE Std 1309-2005, "IEEE Standard for calibration of electromagnetic field sensors and probes, excluding antennas, from 9 kHz to 40 GHz", December 2005
- b) CTIA Test Plan for Hearing Aid Compatibility, April 2010.

**Methods Applied and Interpretation of Parameters:**

- $NORM_{x,y,z}$ : Assessed for E-field polarization  $\vartheta = 0$  for XY sensors and  $\vartheta = 90$  for Z sensor ( $f \leq 900$  MHz in TEM-cell;  $f > 1800$  MHz: R22 waveguide).
- $NORM(f)_{x,y,z} = NORM_{x,y,z} * frequency\_response$  (see Frequency Response Chart).
- $DCP_{x,y,z}$ : DCP are numerical linearization parameters assessed based on the data of power sweep with CW signal (no uncertainty required). DCP does not depend on frequency nor media.
- **PAR**: PAR is the Peak to Average Ratio that is not calibrated but determined based on the signal characteristics
- $A_{x,y,z}; B_{x,y,z}; C_{x,y,z}; D_{x,y,z}; VR_{x,y,z}$ : A, B, C, D are numerical linearization parameters assessed based on the data of power sweep for specific modulation signal. The parameters do not depend on frequency nor media. VR is the maximum calibration range expressed in RMS voltage across the diode.
- **Spherical isotropy (3D deviation from isotropy)**: in a locally homogeneous field realized using an open waveguide setup.
- **Sensor Offset**: The sensor offset corresponds to the offset of virtual measurement center from the probe tip (on probe axis). No tolerance required.
- **Connector Angle**: The angle is assessed using the information gained by determining the  $NORM_x$  (no uncertainty required).



<b>FCC ID:</b> ZNFH950	<b>PCTEST</b> ENGINEERING LABORATORY, INC.	<b>HAC (RF EMISSIONS) TEST REPORT</b>	<b>LG</b>	<b>Reviewed by:</b> Quality Manager
<b>Filename:</b> 0Y1501120071-R1.ZNF	<b>Test Dates:</b> January 12-15, 2015	<b>EUT Type:</b> Portable Handset	Page 45 of 76	

# Probe ER3DV6

## SN:2335

Manufactured: September 9, 2003  
Calibrated: August 18, 2014

Calibrated for DASY/EASY Systems  
(Note: non-compatible with DASY2 system!)

<b>FCC ID:</b> ZNFH950	 <b>PCTEST</b> ENGINEERING LABORATORY, INC.	<b>HAC (RF EMISSIONS) TEST REPORT</b>	 <b>LG</b>	<b>Reviewed by:</b> Quality Manager
<b>Filename:</b> 0Y1501120071-R1.ZNF	<b>Test Dates:</b> January 12-15, 2015	<b>EUT Type:</b> Portable Handset	Page 46 of 76	

**DASY/EASY - Parameters of Probe: ER3DV6 - SN:2335****Basic Calibration Parameters**

	Sensor X	Sensor Y	Sensor Z	Unc (k=2)
Norm ( $\mu\text{V}/(\text{V}/\text{m})^2$ )	1.65	1.68	1.87	$\pm 10.1\%$
DCP (mV) <sup>B</sup>	98.9	98.5	100.7	



**Modulation Calibration Parameters**

UID	Communication System Name		A dB	B dB/ $\mu\text{V}$	C	D dB	VR mV	Unc <sup>E</sup> (k=2)
0	CW	X	0.0	0.0	1.0	0.00	205.2	$\pm 2.2\%$
		Y	0.0	0.0	1.0		160.2	
		Z	0.0	0.0	1.0		192.1	

The reported uncertainty of measurement is stated as the standard uncertainty of measurement multiplied by the coverage factor  $k=2$ , which for a normal distribution corresponds to a coverage probability of approximately 95%.

<sup>B</sup> Numerical linearization parameter: uncertainty not required.



<sup>E</sup> Uncertainty is determined using the max. deviation from linear response applying rectangular distribution and is expressed for the square of the field value.

FCC ID: ZNFH950	 <b>PCTEST</b> ENGINEERING LABORATORY, INC.	<b>HAC (RF EMISSIONS) TEST REPORT</b>		Reviewed by: Quality Manager
Filename: 0Y1501120071-R1.ZNF	Test Dates: January 12-15, 2015	EUT Type: Portable Handset		Page 47 of 76

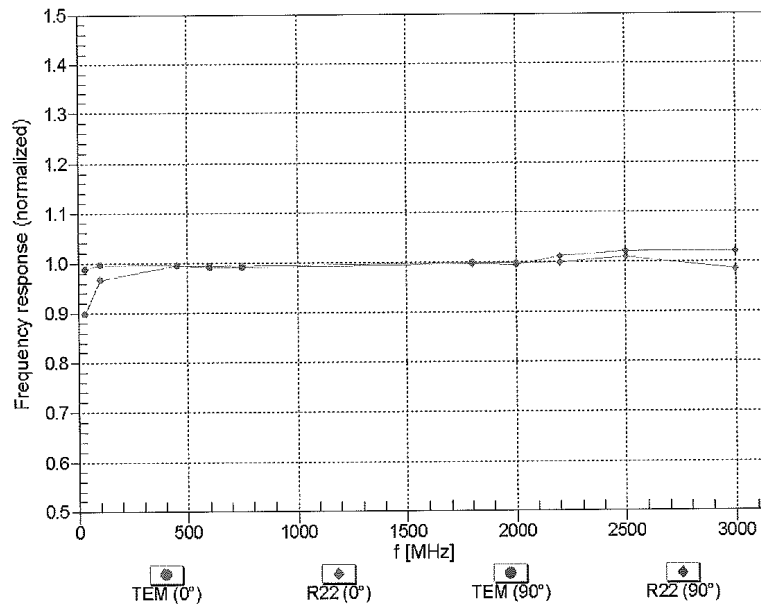
### Frequency Response of E-Field (TEM-Cell:ifi110 EXX, Waveguide: R22)



Uncertainty of Frequency Response of E-field:  $\pm 6.3\%$  (k=2)

<b>FCC ID:</b> ZNFH950		<b>HAC (RF EMISSIONS) TEST REPORT</b>	 <b>Reviewed by:</b> Quality Manager
<b>Filename:</b> 0Y1501120071-R1.ZNF	<b>Test Dates:</b> January 12-15, 2015	<b>EUT Type:</b> Portable Handset	Page 48 of 76



### Receiving Pattern ( $\phi$ ), $\vartheta = 0^\circ$

f=600 MHz,TEM,0°

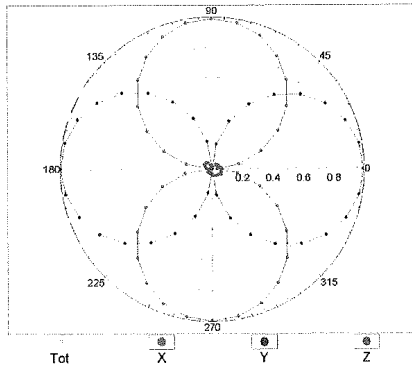

f=2500 MHz,R22,0°

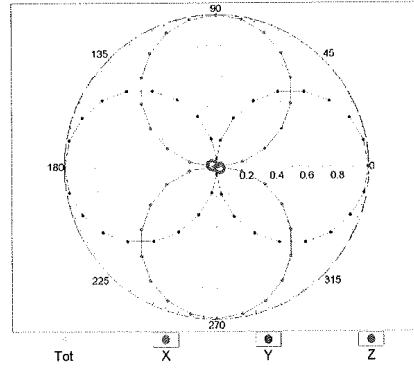

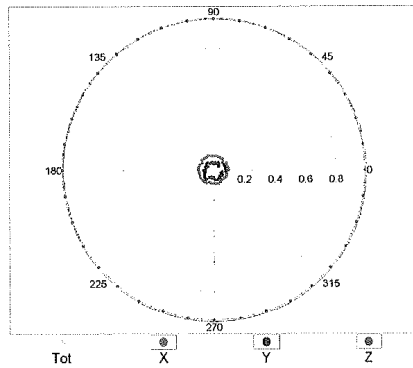

### Receiving Pattern ( $\phi$ ), $\vartheta = 90^\circ$

f=600 MHz,TEM,90°

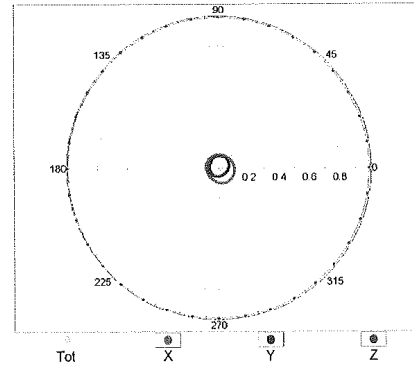

f=2500 MHz,R22,90°



<p>FCC ID: ZNFH950</p>		<p>HAC (RF EMISSIONS) TEST REPORT</p>	 <p>Reviewed by: Quality Manager</p>
<p>Filename: 0Y1501120071-R1.ZNF</p>	<p>Test Dates: January 12-15, 2015</p>	<p>EUT Type: Portable Handset</p>	<p>Page 49 of 76</p>

### Receiving Pattern ( $\phi$ ), $\vartheta = 0^\circ$

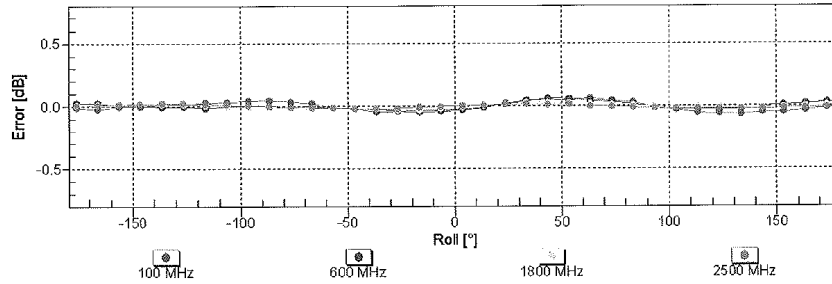

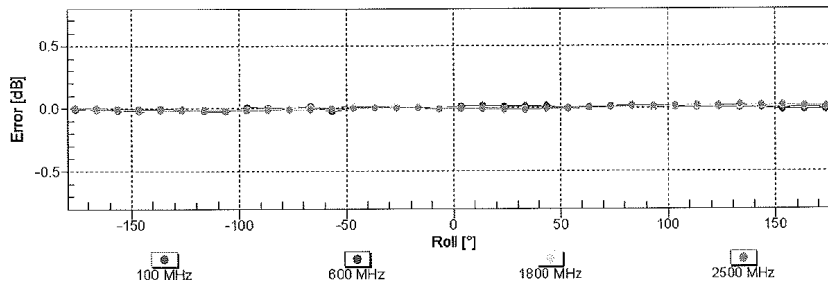

Uncertainty of Axial Isotropy Assessment:  $\pm 0.5\%$  ( $k=2$ )

### Receiving Pattern ( $\phi$ ), $\vartheta = 90^\circ$





Uncertainty of Axial Isotropy Assessment:  $\pm 0.5\%$  ( $k=2$ )

<p>FCC ID: ZNFH950</p>		<p>HAC (RF EMISSIONS) TEST REPORT</p>	 <p>Reviewed by: Quality Manager</p>
<p>Filename: 0Y1501120071-R1.ZNF</p>	<p>Test Dates: January 12-15, 2015</p>	<p>EUT Type: Portable Handset</p>	<p>Page 50 of 76</p>

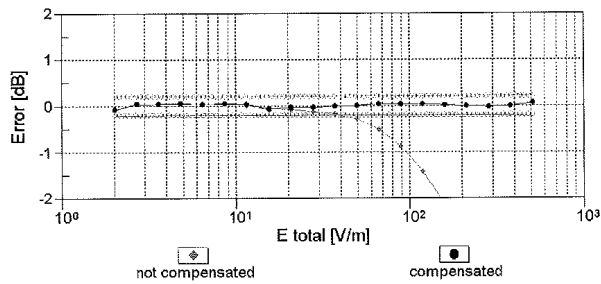
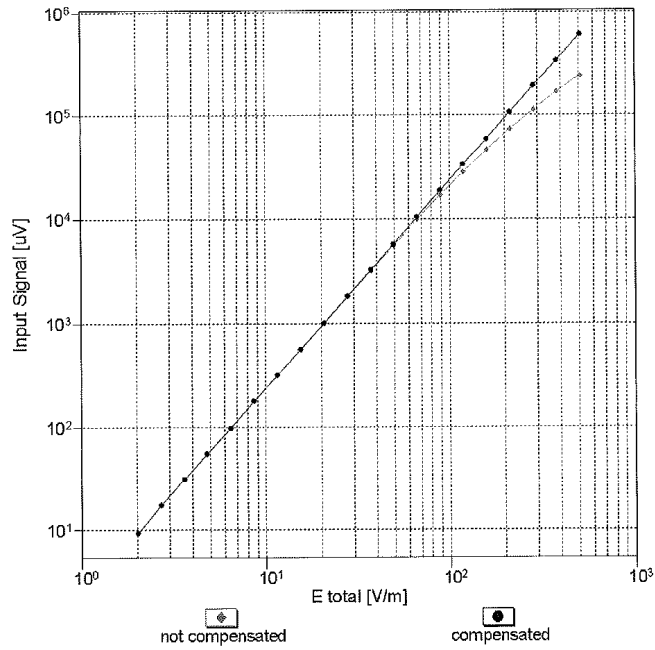
### Dynamic Range f(E-field) (TEM cell , f = 900 MHz)





Uncertainty of Linearity Assessment: ± 0.6% (k=2)

<p>FCC ID: ZNFH950</p>		<p>HAC (RF EMISSIONS) TEST REPORT</p>	 <p>Reviewed by: Quality Manager</p>
<p>Filename: 0Y1501120071-R1.ZNF</p>	<p>Test Dates: January 12-15, 2015</p>	<p>EUT Type: Portable Handset</p>	<p>Page 51 of 76</p>

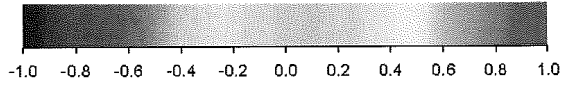
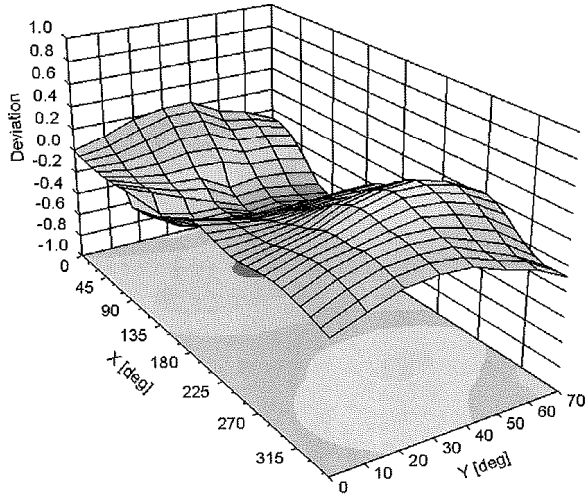
### Deviation from Isotropy in Air Error ( $\phi$ , $\theta$ ), $f = 900$ MHz





Uncertainty of Spherical Isotropy Assessment:  $\pm 2.6\%$  ( $k=2$ )

<b>FCC ID:</b> ZNFH950		<b>HAC (RF EMISSIONS) TEST REPORT</b>	 <b>Reviewed by:</b> Quality Manager
<b>Filename:</b> 0Y1501120071-R1.ZNF	<b>Test Dates:</b> January 12-15, 2015	<b>EUT Type:</b> Portable Handset	Page 52 of 76

**DASY/EASY - Parameters of Probe: ER3DV6 - SN:2335****Other Probe Parameters**

Sensor Arrangement	Rectangular
Connector Angle (°)	-96.5
Mechanical Surface Detection Mode	enabled
Optical Surface Detection Mode	disabled
Probe Overall Length	337 mm
Probe Body Diameter	10 mm
Tip Length	10 mm
Tip Diameter	8 mm
Probe Tip to Sensor X Calibration Point	2.5 mm
Probe Tip to Sensor Y Calibration Point	2.5 mm
Probe Tip to Sensor Z Calibration Point	2.5 mm

<b>FCC ID:</b> ZNFH950	 <b>PCTEST</b> ENGINEERING LABORATORY, INC.	<b>HAC (RF EMISSIONS) TEST REPORT</b>	 <b>LG</b>	<b>Reviewed by:</b> Quality Manager
<b>Filename:</b> 0Y1501120071-R1.ZNF	<b>Test Dates:</b> January 12-15, 2015	<b>EUT Type:</b> Portable Handset	Page 53 of 76	

**Calibration Laboratory of  
Schmid & Partner  
Engineering AG**  
Zeughausstrasse 43, 8004 Zurich, Switzerland



**S** Schweizerischer Kalibrierdienst  
**C** Service suisse d'étalonnage  
**S** Servizio svizzero di taratura  
Swiss Calibration Service

Accredited by the Swiss Accreditation Service (SAS)  
The Swiss Accreditation Service is one of the signatories to the EA  
Multilateral Agreement for the recognition of calibration certificates

Accreditation No.: **SCS 108**

Client **PC Test**

Certificate No: **CD835V3-1003\_Feb13**

## CALIBRATION CERTIFICATE

Object **CD835V3 - SN: 1003**

Calibration procedure(s) **QA CAL-20.v6  
Calibration procedure for dipoles in air**

Calibration date: **February 05, 2013**

*✓ KOK  
2/21/13*

This calibration certificate documents the traceability to national standards, which realize the physical units of measurements (SI).  
The measurements and the uncertainties with confidence probability are given on the following pages and are part of the certificate.

All calibrations have been conducted in the closed laboratory facility: environment temperature (22 ± 3)°C and humidity < 70%.

Calibration Equipment used (M&TE critical for calibration)

Primary Standards	ID #	Cal Date (Certificate No.)	Scheduled Calibration
Power meter EPM-442A	GB37480704	01-Nov-12 (No. 217-01640)	Oct-13
Power sensor HP 8481A	US37292783	01-Nov-12 (No. 217-01640)	Oct-13
Reference 10 dB Attenuator	SN: 5047.2 (10q)	27-Mar-12 (No. 217-01527)	Apr-13
Probe ER3DV6	SN: 2336	28-Dec-12 (No. ER3-2336_Dec12)	Dec-13
Probe H3DV6	SN: 6065	28-Dec-12 (No. H3-6065_Dec12)	Dec-13
DAE4	SN: 781	29-May-12 (No. DAE4-781_May12)	May-13

Secondary Standards	ID #	Check Date (in house)	Scheduled Check
Power meter Agilent 4419B	SN: GB42420191	09-Oct-09 (in house check Oct-12)	In house check: Oct-13
Power sensor HP E4412A	SN: MY41495277	01-Apr-08 (in house check Oct-12)	In house check: Oct-13
Power sensor HP 8482A	SN: US37295597	09-Oct-09 (in house check Oct-12)	In house check: Oct-13
Network Analyzer HP 8753E	US37390585	18-Oct-01 (in house check Oct-12)	In house check: Oct-13
RF generator R&S SMT-06	SN: 832283/011	27-Aug-12 (in house check Oct-12)	In house check: Oct-14

	Name	Function	Signature
Calibrated by:	Dimce Iliev	Laboratory Technician	<i>D. Iliev</i>
Approved by:	Katja Pokovic	Technical Manager	<i>K. Pokovic</i>

Issued: February 6, 2013

This calibration certificate shall not be reproduced except in full without written approval of the laboratory.

Certificate No: CD835V3-1003\_Feb13

Page 1 of 8

FCC ID: ZNFH950	PCTEST ENGINEERING LABORATORY, INC.	HAC (RF EMISSIONS) TEST REPORT	LG	Reviewed by: Quality Manager
Filename: OY1501120071-R1.ZNF	Test Dates: January 12-15, 2015	EUT Type: Portable Handset		Page 54 of 76

**Calibration Laboratory of  
Schmid & Partner  
Engineering AG**  
Zeughausstrasse 43, 8004 Zurich, Switzerland



**S** Schweizerischer Kalibrierdienst  
**S** Service suisse d'étalonnage  
**S** Servizio svizzero di taratura  
**S** Swiss Calibration Service

Accredited by the Swiss Accreditation Service (SAS)  
The Swiss Accreditation Service is one of the signatories to the EA  
Multilateral Agreement for the recognition of calibration certificates

Accreditation No.: **SCS 108**

**References**

- [1] ANSI-C63.19-2007  
American National Standard for Methods of Measurement of Compatibility between Wireless Communications Devices and Hearing Aids.
- [2] ANSI-C63.19-2011  
American National Standard, Methods of Measurement of Compatibility between Wireless Communications Devices and Hearing Aids.

**Methods Applied and Interpretation of Parameters:**

- *Coordinate System:* y-axis is in the direction of the dipole arms. z-axis is from the basis of the antenna (mounted on the table) towards its feed point between the two dipole arms. x-axis is normal to the other axes. In coincidence with the standards [1], the measurement planes (probe sensor center) are selected to be at a distance of 10 mm (15 mm for [2]) above the top metal edge of the dipole arms.
- *Measurement Conditions:* Further details are available from the hardcopies at the end of the certificate. All figures stated in the certificate are valid at the frequency indicated. The forward power to the dipole connector is set with a calibrated power meter connected and monitored with an auxiliary power meter connected to a directional coupler. While the dipole under test is connected, the forward power is adjusted to the same level.
- *Antenna Positioning:* The dipole is mounted on a HAC Test Arch phantom using the matching dipole positioner with the arms horizontal and the feeding cable coming from the floor. The measurements are performed in a shielded room with absorbers around the setup to reduce the reflections. It is verified before the mounting of the dipole under the Test Arch phantom, that its arms are perfectly in a line. It is installed on the HAC dipole positioner with its arms parallel below the dielectric reference wire and able to move elastically in vertical direction without changing its relative position to the top center of the Test Arch phantom. The vertical distance to the probe is adjusted after dipole mounting with a DASY5 Surface Check job. Before the measurement, the distance between phantom surface and probe tip is verified. The proper measurement distance is selected by choosing the matching section of the HAC Test Arch phantom with the proper device reference point (upper surface of the dipole) and the matching grid reference point (tip of the probe) considering the probe sensor offset. The vertical distance to the probe is essential for the accuracy.
- *Feed Point Impedance and Return Loss:* These parameters are measured using a HP 8753E Vector Network Analyzer. The impedance is specified at the SMA connector of the dipole. The influence of reflections was eliminated by applying the averaging function while moving the dipole in the air, at least 70cm away from any obstacles.
- *E-field distribution:* E field is measured in the x-y-plane with an isotropic ER3D-field probe with 100 mW forward power to the antenna feed point. In accordance with [1] and [2], the scan area is 20mm wide, its length exceeds the dipole arm length (180 or 90mm). The sensor center is 10 mm (15 mm for [2]) (in z) above the metal top of the dipole arms. Two 3D maxima are available near the end of the dipole arms. Assuming the dipole arms are perfectly in one line, the average of these two maxima (in subgrid 2 and subgrid 8) is determined to compensate for any non-parallelity to the measurement plane as well as the sensor displacement. The E-field value stated as calibration value represents the maximum of the interpolated 3D-E-field, in the plane above the dipole surface.
- *H-field distribution:* H-field is measured with an isotropic H-field probe with 100mW forward power to the antenna feed point, in the x-y-plane. The scan area and sensor distance is equivalent to the E-field scan. The maximum of the field is available at the center (subgrid 5) above the feed point. The H-field value stated as calibration value represents the maximum of the interpolated H-field, 10mm above the dipole surface at the feed point.

The reported uncertainty of measurement is stated as the standard uncertainty of measurement multiplied by the coverage factor k=2, which for a normal distribution corresponds to a coverage probability of approximately 95%.

FCC ID: ZNFH950	PCTEST ENGINEERING LABORATORY, INC.	HAC (RF EMISSIONS) TEST REPORT	LG	Reviewed by: Quality Manager
Filename: OY1501120071-R1.ZNF	Test Dates: January 12-15, 2015	EUT Type: Portable Handset	Page 55 of 76	

### Measurement Conditions

DASY system configuration, as far as not given on page 1.



<b>DASY Version</b>	DASY5	V52.8.5
<b>Extrapolation</b>	Advanced Extrapolation	
<b>Phantom</b>	HAC Test Arch	
<b>Distance Dipole Top - Probe Center</b>	10mm 15mm	
<b>Scan resolution</b>	dx, dy = 5 mm	
<b>Frequency</b>	835 MHz ± 1 MHz	
<b>Input power drift</b>	< 0.05 dB	

### Maximum Field values at 835 MHz

<b>H-field 10 mm above dipole surface</b>	condition	<b>interpolated maximum</b>
Maximum measured	100 mW input power	<b>0.470 A / m ± 8.2 % (k=2)</b>

<b>E-field 10 mm above dipole surface</b>	condition	<b>Interpolated maximum</b>
Maximum measured above high end	100 mW input power	169.8 V / m
Maximum measured above low end	100 mW input power	164.4 V / m
Averaged maximum above arm	100 mW input power	<b>167.1 V / m ± 12.8 % (k=2)</b>

<b>E-field 15 mm above dipole surface</b>	condition	<b>Interpolated maximum</b>
Maximum measured above high end	100 mW input power	108.3 V / m
Maximum measured above low end	100 mW input power	107.0 V / m
Averaged maximum above arm	100 mW input power	<b>107.7 V / m ± 12.8 % (k=2)</b>

<b>FCC ID:</b> ZNFH950	 <b>PCTEST</b> ENGINEERING LABORATORY, INC.	<b>HAC (RF EMISSIONS) TEST REPORT</b>	 <b>LG</b>	<b>Reviewed by:</b> Quality Manager
<b>Filename:</b> 0Y1501120071-R1.ZNF	<b>Test Dates:</b> January 12-15, 2015	<b>EUT Type:</b> Portable Handset	Page 56 of 76	



## Appendix

### Antenna Parameters

Frequency	Return Loss	Impedance
800 MHz	16.1 dB	41.2 $\Omega$ - 11.5 j $\Omega$
835 MHz	26.6 dB	51.6 $\Omega$ + 4.5 j $\Omega$
900 MHz	16.6 dB	57.8 $\Omega$ - 14.1 j $\Omega$
950 MHz	18.8 dB	52.6 $\Omega$ + 11.6 j $\Omega$
960 MHz	13.7 dB	63.4 $\Omega$ + 19.5 j $\Omega$



### 3.2 Antenna Design and Handling

The calibration dipole has a symmetric geometry with a built-in two stub matching network, which leads to the enhanced bandwidth.

The dipole is built of standard semirigid coaxial cable. The internal matching line is open ended. The antenna is therefore open for DC signals.



Do not apply force to dipole arms, as they are liable to bend. The soldered connections near the feedpoint may be damaged. After excessive mechanical stress or overheating, check the impedance characteristics to ensure that the internal matching network is not affected.

After long term use with 40W radiated power, only a slight warming of the dipole near the feedpoint can be measured.

<b>FCC ID:</b> ZNFH950		<b>HAC (RF EMISSIONS) TEST REPORT</b>		<b>Reviewed by:</b> Quality Manager
<b>Filename:</b> 0Y1501120071-R1.ZNF	<b>Test Dates:</b> January 12-15, 2015	<b>EUT Type:</b> Portable Handset	Page 57 of 76	

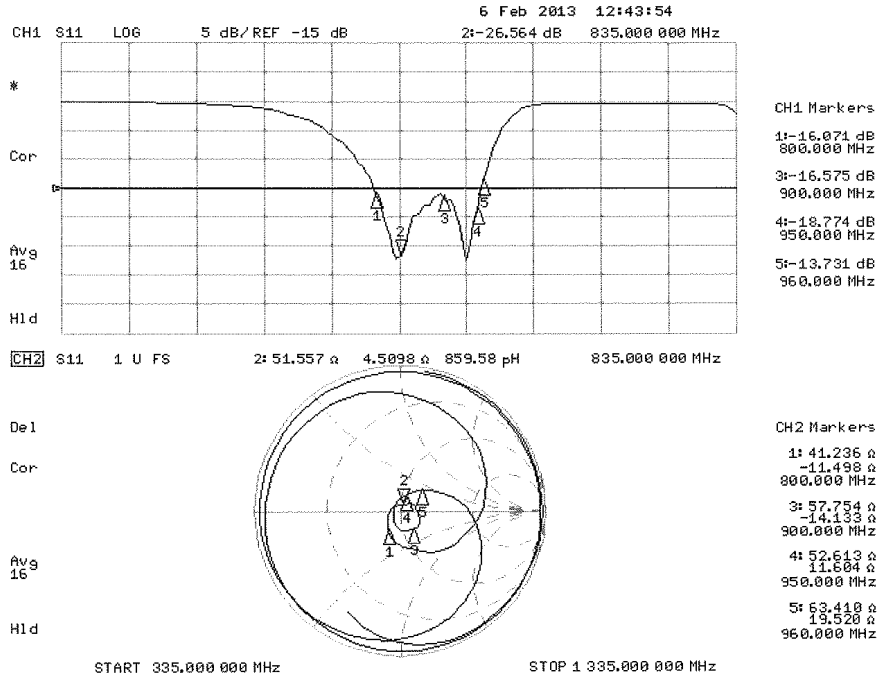
### Impedance Measurement Plot



FCC ID: ZNFH950	 PCTEST ENGINEERING LABORATORY, INC.	HAC (RF EMISSIONS) TEST REPORT	 LG	Reviewed by: Quality Manager
Filename: 0Y1501120071-R1.ZNF	Test Dates: January 12-15, 2015	EUT Type: Portable Handset		Page 58 of 76

**DASY5 H-field Result**

Date: 05.02.2013

Test Laboratory: SPEAG Lab2

**DUT: HAC-Dipole 835 MHz; Type: CD835V3; Serial: CD835V3 - SN: 1003**

Communication System: CW; Frequency: 835 MHz  
 Medium parameters used:  $\sigma = 0$  S/m,  $\epsilon_r = 1$ ;  $\rho = 1$  kg/m<sup>3</sup>  
 Phantom section: RF Section  
 Measurement Standard: DASY5 (IEEE/IEC/ANSI C63.19-2007)

DASY52 Configuration:

- Probe: H3DV6 - SN6065; ; Calibrated: 28.12.2012
- Sensor-Surface: (Fix Surface)
- Electronics: DAE4 Sn781; Calibrated: 29.05.2012
- Phantom: HAC Test Arch with AMCC; Type: SD HAC P01 BA; Serial: 1070
- DASY52 52.8.5(1059); SEMCAD X 14.6.8(7028)

**Dipole H-Field measurement @ 835MHz/H-Scan - 835MHz d=10mm/Hearing Aid Compatibility Test (41x361x1):**



Interpolated grid: dx=0.5000 mm, dy=0.5000 mm  
 Device Reference Point: 0, 0, -6.3 mm  
 Reference Value = 0.4980 A/m; Power Drift = -0.01 dB  
 PMR not calibrated. PMF = 1.000 is applied.  
 H-field emissions = 0.4697 A/m  
**Near-field category: M4 (AWF 0 dB)**

PMF scaled H-field

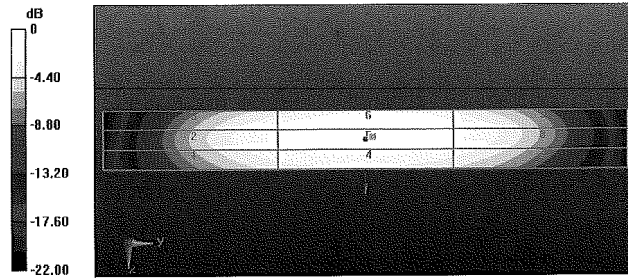
Grid 1 <b>M4</b> <b>0.380 A/m</b>	Grid 2 <b>M4</b> <b>0.413 A/m</b>	Grid 3 <b>M4</b> <b>0.399 A/m</b>
Grid 4 <b>M4</b> <b>0.427 A/m</b>	Grid 5 <b>M4</b> <b>0.470 A/m</b>	Grid 6 <b>M4</b> <b>0.460 A/m</b>
Grid 7 <b>M4</b> <b>0.369 A/m</b>	Grid 8 <b>M4</b> <b>0.413 A/m</b>	Grid 9 <b>M4</b> <b>0.406 A/m</b>



0 dB = 0.4697 A/m = -6.56 dBA/m

FCC ID: ZNFH950	 <b>PCTEST</b> ENGINEERING LABORATORY, INC.	<b>HAC (RF EMISSIONS) TEST REPORT</b>	 <b>LG</b>	<b>Reviewed by:</b> Quality Manager
<b>Filename:</b> OY1501120071-R1.ZNF	<b>Test Dates:</b> January 12-15, 2015	<b>EUT Type:</b> Portable Handset	Page 59 of 76	

**DASY5 E-field Result**

Date: 05.02.2013

Test Laboratory: SPEAG Lab2

**DUT: HAC-Dipole 835 MHz; Type: CD835V3; Serial: CD835V3 - SN: 1003**

Communication System: CW; Frequency: 835 MHz  
Medium parameters used:  $\sigma = 0 \text{ S/m}$ ,  $\epsilon_r = 1$ ;  $\rho = 1000 \text{ kg/m}^3$   
Phantom section: RF Section  
Measurement Standard: DASY5 (IEEE/IEC/ANSI C63.19-2007)

DASY52 Configuration:

- Probe: ER3DV6 - SN2336; ConvF(1, 1, 1); Calibrated: 28.12.2012;
- Sensor-Surface: (Fix Surface)
- Electronics: DAE4 Sn781; Calibrated: 29.05.2012
- Phantom: HAC Test Arch with AMCC; Type: SD HAC P01 BA; Serial: 1070
- DASY52 52.8.5(1059); SEMCAD X 14.6.8(7028)

**Dipole E-Field measurement @ 835MHz/E-Scan - 835MHz d=10mm/Hearing Aid Compatibility Test (41x361x1):**

Interpolated grid: dx=0.5000 mm, dy=0.5000 mm  
Device Reference Point: 0, 0, -6.3 mm  
Reference Value = 112.7 V/m; Power Drift = -0.01 dB  
PMR not calibrated. PMF = 1.000 is applied.  
E-field emissions = 169.8 V/m  
**Near-field category: M4 (AWF 0 dB)**



PMF scaled E-field

Grid 1 <b>M4</b> <b>159.6 V/m</b>	Grid 2 <b>M4</b> <b>164.4 V/m</b>	Grid 3 <b>M4</b> <b>159.2 V/m</b>
Grid 4 <b>M4</b> <b>86.08 V/m</b>	Grid 5 <b>M4</b> <b>89.03 V/m</b>	Grid 6 <b>M4</b> <b>87.03 V/m</b>
Grid 7 <b>M4</b> <b>155.8 V/m</b>	Grid 8 <b>M4</b> <b>169.8 V/m</b>	Grid 9 <b>M4</b> <b>169.5 V/m</b>

**Dipole E-Field measurement @ 835MHz/E-Scan - 835MHz d=15mm/Hearing Aid**

**Compatibility Test (41x361x1):** Interpolated grid: dx=0.5000 mm, dy=0.5000 mm

Device Reference Point: 0, 0, -6.3 mm  
Reference Value = 112.1 V/m; Power Drift = -0.03 dB  
PMR not calibrated. PMF = 1.000 is applied.  
E-field emissions = 108.3 V/m  
**Near-field category: M4 (AWF 0 dB)**



<b>FCC ID:</b> ZNFH950	 <b>PCTEST</b> ENGINEERING LABORATORY, INC.	<b>HAC (RF EMISSIONS) TEST REPORT</b>	 <b>LG</b>	<b>Reviewed by:</b> Quality Manager
<b>Filename:</b> 0Y1501120071-R1.ZNF	<b>Test Dates:</b> January 12-15, 2015	<b>EUT Type:</b> Portable Handset	Page 60 of 76	

PMF scaled E-field

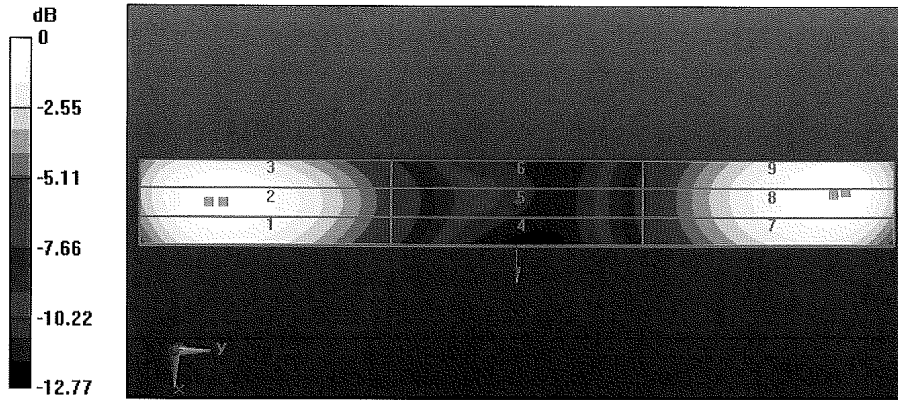
Grid 1 M4 105.2 V/m	Grid 2 M4 107.0 V/m	Grid 3 M4 105.3 V/m
Grid 4 M4 62.40 V/m	Grid 5 M4 63.62 V/m	Grid 6 M4 62.80 V/m
Grid 7 M4 104.3 V/m	Grid 8 M4 108.3 V/m	Grid 9 M4 107.9 V/m



0 dB = 169.8 V/m = 44.60 dBV/m

FCC ID: ZNFH950	 PCTEST ENGINEERING LABORATORY, INC.	HAC (RF EMISSIONS) TEST REPORT	 LG	Reviewed by: Quality Manager
Filename: 0Y1501120071-R1.ZNF	Test Dates: January 12-15, 2015	EUT Type: Portable Handset	Page 61 of 76	

**Calibration Laboratory of  
Schmid & Partner  
Engineering AG**  
Zeughausstrasse 43, 8004 Zurich, Switzerland



**S** Schweizerischer Kalibrierdienst  
**C** Service suisse d'étalonnage  
**S** Servizio svizzero di taratura  
Swiss Calibration Service

Accredited by the Swiss Accreditation Service (SAS)  
The Swiss Accreditation Service is one of the signatories to the EA  
Multilateral Agreement for the recognition of calibration certificates

Accreditation No.: **SCS 108**

Client **PC Test**

Certificate No: **CD1880V3-1137\_Feb13**

CALIBRATION CERTIFICATE																																																																			
Object	CD1880V3 - SN: 1137																																																																		
Calibration procedure(s)	QA CAL-20.v6 Calibration procedure for dipoles in air																																																																		
Calibration date:	February 05, 2013																																																																		
<p>This calibration certificate documents the traceability to national standards, which realize the physical units of measurements (SI). The measurements and the uncertainties with confidence probability are given on the following pages and are part of the certificate.</p> <p>All calibrations have been conducted in the closed laboratory facility: environment temperature (22 ± 3)°C and humidity &lt; 70%.</p> <p>Calibration Equipment used (M&amp;TE critical for calibration)</p> <table border="1"> <thead> <tr> <th>Primary Standards</th> <th>ID #</th> <th>Cal Date (Certificate No.)</th> <th>Scheduled Calibration</th> </tr> </thead> <tbody> <tr> <td>Power meter EPM-442A</td> <td>GB37480704</td> <td>01-Nov-12 (No. 217-01640)</td> <td>Oct-13</td> </tr> <tr> <td>Power sensor HP 8481A</td> <td>US37292783</td> <td>01-Nov-12 (No. 217-01640)</td> <td>Oct-13</td> </tr> <tr> <td>Reference 10 dB Attenuator</td> <td>SN: 5047.2 (10q)</td> <td>27-Mar-12 (No. 217-01527)</td> <td>Apr-13</td> </tr> <tr> <td>Probe ER3DV6</td> <td>SN: 2336</td> <td>28-Dec-12 (No. ER3-2336_Dec12)</td> <td>Dec-13</td> </tr> <tr> <td>Probe H3DV6</td> <td>SN: 6065</td> <td>28-Dec-12 (No. H3-6065_Dec12)</td> <td>Dec-13</td> </tr> <tr> <td>DAE4</td> <td>SN: 781</td> <td>29-May-12 (No. DAE4-781_May12)</td> <td>May-13</td> </tr> </tbody> </table> <table border="1"> <thead> <tr> <th>Secondary Standards</th> <th>ID #</th> <th>Check Date (in house)</th> <th>Scheduled Check</th> </tr> </thead> <tbody> <tr> <td>Power meter Agilent 4419B</td> <td>SN: GB42420191</td> <td>09-Oct-09 (in house check Oct-12)</td> <td>In house check: Oct-13</td> </tr> <tr> <td>Power sensor HP E4412A</td> <td>SN: MY41495277</td> <td>01-Apr-08 (in house check Oct-12)</td> <td>In house check: Oct-13</td> </tr> <tr> <td>Power sensor HP 8482A</td> <td>SN: US37295597</td> <td>09-Oct-09 (in house check Oct-12)</td> <td>In house check: Oct-13</td> </tr> <tr> <td>Network Analyzer HP 8753E</td> <td>US37390585</td> <td>18-Oct-01 (in house check Oct-12)</td> <td>In house check: Oct-13</td> </tr> <tr> <td>RF generator R&amp;S SMT-06</td> <td>SN: 832283/011</td> <td>27-Aug-12 (in house check Oct-12)</td> <td>In house check: Oct-14</td> </tr> </tbody> </table> <table border="1"> <thead> <tr> <th>Calibrated by:</th> <th>Name</th> <th>Function</th> <th>Signature</th> </tr> </thead> <tbody> <tr> <td></td> <td>Dimce Iliev</td> <td>Laboratory Technician</td> <td><i>D. Iliev</i></td> </tr> <tr> <td>Approved by:</td> <td>Katja Pokovic</td> <td>Technical Manager</td> <td><i>K. Pokovic</i></td> </tr> </tbody> </table> <p>Issued: February 6, 2013</p>				Primary Standards	ID #	Cal Date (Certificate No.)	Scheduled Calibration	Power meter EPM-442A	GB37480704	01-Nov-12 (No. 217-01640)	Oct-13	Power sensor HP 8481A	US37292783	01-Nov-12 (No. 217-01640)	Oct-13	Reference 10 dB Attenuator	SN: 5047.2 (10q)	27-Mar-12 (No. 217-01527)	Apr-13	Probe ER3DV6	SN: 2336	28-Dec-12 (No. ER3-2336_Dec12)	Dec-13	Probe H3DV6	SN: 6065	28-Dec-12 (No. H3-6065_Dec12)	Dec-13	DAE4	SN: 781	29-May-12 (No. DAE4-781_May12)	May-13	Secondary Standards	ID #	Check Date (in house)	Scheduled Check	Power meter Agilent 4419B	SN: GB42420191	09-Oct-09 (in house check Oct-12)	In house check: Oct-13	Power sensor HP E4412A	SN: MY41495277	01-Apr-08 (in house check Oct-12)	In house check: Oct-13	Power sensor HP 8482A	SN: US37295597	09-Oct-09 (in house check Oct-12)	In house check: Oct-13	Network Analyzer HP 8753E	US37390585	18-Oct-01 (in house check Oct-12)	In house check: Oct-13	RF generator R&S SMT-06	SN: 832283/011	27-Aug-12 (in house check Oct-12)	In house check: Oct-14	Calibrated by:	Name	Function	Signature		Dimce Iliev	Laboratory Technician	<i>D. Iliev</i>	Approved by:	Katja Pokovic	Technical Manager	<i>K. Pokovic</i>
Primary Standards	ID #	Cal Date (Certificate No.)	Scheduled Calibration																																																																
Power meter EPM-442A	GB37480704	01-Nov-12 (No. 217-01640)	Oct-13																																																																
Power sensor HP 8481A	US37292783	01-Nov-12 (No. 217-01640)	Oct-13																																																																
Reference 10 dB Attenuator	SN: 5047.2 (10q)	27-Mar-12 (No. 217-01527)	Apr-13																																																																
Probe ER3DV6	SN: 2336	28-Dec-12 (No. ER3-2336_Dec12)	Dec-13																																																																
Probe H3DV6	SN: 6065	28-Dec-12 (No. H3-6065_Dec12)	Dec-13																																																																
DAE4	SN: 781	29-May-12 (No. DAE4-781_May12)	May-13																																																																
Secondary Standards	ID #	Check Date (in house)	Scheduled Check																																																																
Power meter Agilent 4419B	SN: GB42420191	09-Oct-09 (in house check Oct-12)	In house check: Oct-13																																																																
Power sensor HP E4412A	SN: MY41495277	01-Apr-08 (in house check Oct-12)	In house check: Oct-13																																																																
Power sensor HP 8482A	SN: US37295597	09-Oct-09 (in house check Oct-12)	In house check: Oct-13																																																																
Network Analyzer HP 8753E	US37390585	18-Oct-01 (in house check Oct-12)	In house check: Oct-13																																																																
RF generator R&S SMT-06	SN: 832283/011	27-Aug-12 (in house check Oct-12)	In house check: Oct-14																																																																
Calibrated by:	Name	Function	Signature																																																																
	Dimce Iliev	Laboratory Technician	<i>D. Iliev</i>																																																																
Approved by:	Katja Pokovic	Technical Manager	<i>K. Pokovic</i>																																																																
<p>This calibration certificate shall not be reproduced except in full without written approval of the laboratory.</p>																																																																			

*✓  
Kok  
2/21/13*

Certificate No: CD1880V3-1137\_Feb13

Page 1 of 9

FCC ID: ZNFH950	PCTEST ENGINEERING LABORATORY, INC.	HAC (RF EMISSIONS) TEST REPORT	LG	Reviewed by: Quality Manager
Filename: OY1501120071-R1.ZNF	Test Dates: January 12-15, 2015	EUT Type: Portable Handset		Page 62 of 76

**Calibration Laboratory of  
Schmid & Partner  
Engineering AG**  
Zeughausstrasse 43, 8004 Zurich, Switzerland



**S** Schweizerischer Kalibrierdienst  
**C** Service suisse d'étalonnage  
**S** Servizio svizzero di taratura  
**S** Swiss Calibration Service

Accredited by the Swiss Accreditation Service (SAS)  
The Swiss Accreditation Service is one of the signatories to the EA  
Multilateral Agreement for the recognition of calibration certificates

Accreditation No.: **SCS 108**

**References**

- [1] ANSI-C63.19-2007  
American National Standard for Methods of Measurement of Compatibility between Wireless Communications Devices and Hearing Aids.
- [2] ANSI-C63.19-2011  
American National Standard, Methods of Measurement of Compatibility between Wireless Communications Devices and Hearing Aids.

**Methods Applied and Interpretation of Parameters:**

- *Coordinate System:* y-axis is in the direction of the dipole arms. z-axis is from the basis of the antenna (mounted on the table) towards its feed point between the two dipole arms. x-axis is normal to the other axes. In coincidence with the standards [1], the measurement planes (probe sensor center) are selected to be at a distance of 10 mm (15 mm for [2]) above the top metal edge of the dipole arms.
- *Measurement Conditions:* Further details are available from the hardcopies at the end of the certificate. All figures stated in the certificate are valid at the frequency indicated. The forward power to the dipole connector is set with a calibrated power meter connected and monitored with an auxiliary power meter connected to a directional coupler. While the dipole under test is connected, the forward power is adjusted to the same level.
- *Antenna Positioning:* The dipole is mounted on a HAC Test Arch phantom using the matching dipole positioner with the arms horizontal and the feeding cable coming from the floor. The measurements are performed in a shielded room with absorbers around the setup to reduce the reflections. It is verified before the mounting of the dipole under the Test Arch phantom, that its arms are perfectly in a line. It is installed on the HAC dipole positioner with its arms parallel below the dielectric reference wire and able to move elastically in vertical direction without changing its relative position to the top center of the Test Arch phantom. The vertical distance to the probe is adjusted after dipole mounting with a DASY5 Surface Check job. Before the measurement, the distance between phantom surface and probe tip is verified. The proper measurement distance is selected by choosing the matching section of the HAC Test Arch phantom with the proper device reference point (upper surface of the dipole) and the matching grid reference point (tip of the probe) considering the probe sensor offset. The vertical distance to the probe is essential for the accuracy.
- *Feed Point Impedance and Return Loss:* These parameters are measured using a HP 8753E Vector Network Analyzer. The impedance is specified at the SMA connector of the dipole. The influence of reflections was eliminated by applying the averaging function while moving the dipole in the air, at least 70cm away from any obstacles.
- *E-field distribution:* E field is measured in the x-y-plane with an isotropic ER3D-field probe with 100 mW forward power to the antenna feed point. In accordance with [1] and [2], the scan area is 20mm wide, its length exceeds the dipole arm length (180 or 90mm). The sensor center is 10 mm (15 mm for [2]) (in z) above the metal top of the dipole arms. Two 3D maxima are available near the end of the dipole arms. Assuming the dipole arms are perfectly in one line, the average of these two maxima (in subgrid 2 and subgrid 8) is determined to compensate for any non-parallelity to the measurement plane as well as the sensor displacement. The E-field value stated as calibration value represents the maximum of the interpolated 3D-E-field, in the plane above the dipole surface.
- *H-field distribution:* H-field is measured with an isotropic H-field probe with 100mW forward power to the antenna feed point, in the x-y-plane. The scan area and sensor distance is equivalent to the E-field scan. The maximum of the field is available at the center (subgrid 5) above the feed point. The H-field value stated as calibration value represents the maximum of the interpolated H-field, 10mm above the dipole surface at the feed point.

The reported uncertainty of measurement is stated as the standard uncertainty of measurement multiplied by the coverage factor k=2, which for a normal distribution corresponds to a coverage probability of approximately 95%.

FCC ID: ZNFH950	PCTEST ENGINEERING LABORATORY, INC.	HAC (RF EMISSIONS) TEST REPORT	LG	Reviewed by: Quality Manager
Filename: OY1501120071-R1.ZNF	Test Dates: January 12-15, 2015	EUT Type: Portable Handset		Page 63 of 76

### Measurement Conditions

DASY system configuration, as far as not given on page 1.

<b>DASY Version</b>	DASY5	V52.8.5
<b>Extrapolation</b>	Advanced Extrapolation	
<b>Phantom</b>	HAC Test Arch	
<b>Distance Dipole Top - Probe Center</b>	10mm 15mm	
<b>Scan resolution</b>	dx, dy = 5 mm	
<b>Frequency</b>	1730 MHz $\pm$ 1 MHz 1880 MHz $\pm$ 1 MHz	
<b>Input power drift</b>	< 0.05 dB	

### Maximum Field values at 1730 MHz

H-field 10 mm above dipole surface	condition	interpolated maximum
Maximum measured	100 mW input power	0.493 A / m $\pm$ 8.2 % (k=2)

E-field 10 mm above dipole surface	condition	Interpolated maximum
Maximum measured above high end	100 mW input power	154.1 V / m
Maximum measured above low end	100 mW input power	150.3 V / m
Averaged maximum above arm	100 mW input power	152.2 V / m $\pm$ 12.8 % (k=2)



E-field 15 mm above dipole surface	condition	Interpolated maximum
Maximum measured above high end	100 mW input power	98.6 V / m
Maximum measured above low end	100 mW input power	97.6 V / m
Averaged maximum above arm	100 mW input power	98.1 V / m $\pm$ 12.8 % (k=2)

### Maximum Field values at 1880 MHz

H-field 10 mm above dipole surface	condition	interpolated maximum
Maximum measured	100 mW input power	0.467 A / m $\pm$ 8.2 % (k=2)

E-field 10 mm above dipole surface	condition	Interpolated maximum
Maximum measured above high end	100 mW input power	140.1 V / m
Maximum measured above low end	100 mW input power	139.2 V / m
Averaged maximum above arm	100 mW input power	139.7 V / m $\pm$ 12.8 % (k=2)

E-field 15 mm above dipole surface	condition	Interpolated maximum
Maximum measured above high end	100 mW input power	91.7 V / m
Maximum measured above low end	100 mW input power	88.7 V / m
Averaged maximum above arm	100 mW input power	90.2 V / m $\pm$ 12.8 % (k=2)

<b>FCC ID:</b> ZNFH950	 <b>PCTEST</b> ENGINEERING LABORATORY, INC.	<b>HAC (RF EMISSIONS) TEST REPORT</b>	 <b>LG</b>	<b>Reviewed by:</b> Quality Manager
<b>Filename:</b> 0Y1501120071-R1.ZNF	<b>Test Dates:</b> January 12-15, 2015	<b>EUT Type:</b> Portable Handset	Page 64 of 76	



## Appendix

### Antenna Parameters

#### Nominal Frequencies

Frequency	Return Loss	Impedance
1730 MHz	22.1 dB	48.6 $\Omega$ + 7.7 j $\Omega$
1880 MHz	20.4 dB	50.2 $\Omega$ + 9.6 j $\Omega$
1900 MHz	21.0 dB	53.6 $\Omega$ + 8.5 j $\Omega$
1950 MHz	27.3 dB	54.5 $\Omega$ + 0.0 j $\Omega$
2000 MHz	20.1 dB	41.0 $\Omega$ - 1.2 j $\Omega$

#### Additional Frequencies

Frequency	Return Loss	Impedance
1730 MHz	22.1 dB	48.6 $\Omega$ + 7.7 j $\Omega$



### 3.2 Antenna Design and Handling

The calibration dipole has a symmetric geometry with a built-in two stub matching network, which leads to the enhanced bandwidth.

The dipole is built of standard semirigid coaxial cable. The internal matching line is open ended. The antenna is therefore open for DC signals.

Do not apply force to dipole arms, as they are liable to bend. The soldered connections near the feedpoint may be damaged. After excessive mechanical stress or overheating, check the impedance characteristics to ensure that the internal matching network is not affected.

After long term use with 40W radiated power, only a slight warming of the dipole near the feedpoint can be measured.

<b>FCC ID:</b> ZNFH950	 <b>PCTEST</b> ENGINEERING LABORATORY, INC.	<b>HAC (RF EMISSIONS) TEST REPORT</b>	 <b>LG</b>	<b>Reviewed by:</b> Quality Manager
<b>Filename:</b> 0Y1501120071-R1.ZNF	<b>Test Dates:</b> January 12-15, 2015	<b>EUT Type:</b> Portable Handset	Page 65 of 76	

### Impedance Measurement Plot

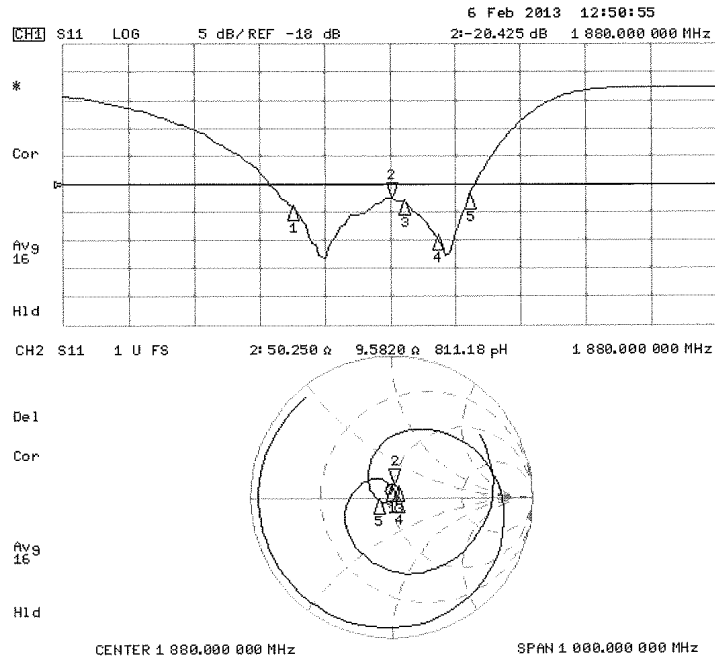

FCC ID: ZNFH950	PCTEST ENGINEERING LABORATORY, INC.	HAC (RF EMISSIONS) TEST REPORT	LG	Reviewed by: Quality Manager
Filename: 0Y1501120071-R1.ZNF	Test Dates: January 12-15, 2015	EUT Type: Portable Handset		Page 66 of 76

**DASY5 H-field Result**

Date: 05.02.2013

Test Laboratory: SPEAG Lab2

**DUT: HAC Dipole 1880 MHz; Type: CD1880V3; Serial: CD1880V3 - SN: 1137**

Communication System: CW; Frequency: 1730 MHz, Frequency: 1880 MHz  
 Medium parameters used:  $\sigma = 0 \text{ S/m}$ ,  $\epsilon_r = 1$ ;  $\rho = 1 \text{ kg/m}^3$   
 Phantom section: RF Section  
 Measurement Standard: DASY5 (IEEE/IEC/ANSI C63.19-2007)

DASY52 Configuration:

- Probe: H3DV6 - SN6065; ; Calibrated: 28.12.2012
- Sensor-Surface: (Fix Surface)
- Electronics: DAE4 Sn781; Calibrated: 29.05.2012
- Phantom: HAC Test Arch with AMCC; Type: SD HAC P01 BA; Serial: 1070
- DASY52 52.8.5(1059); SEMCAD X 14.6.8(7028)

**Dipole H-Field measurement @ 1880MHz/H-Scan - 1730MHz d=10mm/Hearing Aid Compatibility Test (41x181x1):**



Interpolated grid: dx=0.5000 mm, dy=0.5000 mm  
 Device Reference Point: 0, 0, -6.3 mm  
 Reference Value = 0.5230 A/m; Power Drift = -0.02 dB  
 PMR not calibrated. PMF = 1.000 is applied.  
 H-field emissions = 0.4933 A/m  
**Near-field category: M2 (AWF 0 dB)**

PMF scaled H-field

Grid 1 <b>M2</b> <b>0.406 A/m</b>	Grid 2 <b>M2</b> <b>0.437 A/m</b>	Grid 3 <b>M2</b> <b>0.425 A/m</b>
Grid 4 <b>M2</b> <b>0.453 A/m</b>	Grid 5 <b>M2</b> <b>0.493 A/m</b>	Grid 6 <b>M2</b> <b>0.482 A/m</b>
Grid 7 <b>M2</b> <b>0.394 A/m</b>	Grid 8 <b>M2</b> <b>0.434 A/m</b>	Grid 9 <b>M2</b> <b>0.425 A/m</b>

**Dipole H-Field measurement @ 1880MHz/H-Scan - 1880MHz d=10mm/Hearing Aid Compatibility Test (41x181x1):**

Interpolated grid: dx=0.5000 mm, dy=0.5000 mm  
 Device Reference Point: 0, 0, -6.3 mm  
 Reference Value = 0.4940 A/m; Power Drift = 0.02 dB  
 PMR not calibrated. PMF = 1.000 is applied.  
 H-field emissions = 0.4674 A/m  
**Near-field category: M2 (AWF 0 dB)**



<b>FCC ID:</b> ZNFH950	 <b>PCTEST</b> ENGINEERING LABORATORY, INC.	<b>HAC (RF EMISSIONS) TEST REPORT</b>	 <b>LG</b>	<b>Reviewed by:</b> Quality Manager
<b>Filename:</b> OY1501120071-R1.ZNF	<b>Test Dates:</b> January 12-15, 2015	<b>EUT Type:</b> Portable Handset	Page 67 of 76	

PMF scaled H-field

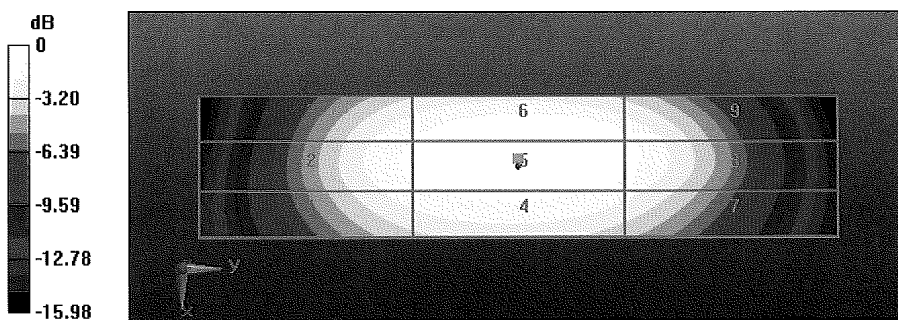
Grid 1 M2 <b>0.404 A/m</b>	Grid 2 M2 <b>0.431 A/m</b>	Grid 3 M2 <b>0.418 A/m</b>
Grid 4 M2 <b>0.436 A/m</b>	Grid 5 M2 <b>0.467 A/m</b>	Grid 6 M2 <b>0.455 A/m</b>
Grid 7 M2 <b>0.393 A/m</b>	Grid 8 M2 <b>0.428 A/m</b>	Grid 9 M2 <b>0.417 A/m</b>



0 dB = 0.4933 A/m = -6.14 dBA/m

<b>FCC ID:</b> ZNFH950	 <b>PCTEST</b> ENGINEERING LABORATORY, INC.	<b>HAC (RF EMISSIONS) TEST REPORT</b>	 <b>LG</b>	<b>Reviewed by:</b> Quality Manager
<b>Filename:</b> 0Y1501120071-R1.ZNF	<b>Test Dates:</b> January 12-15, 2015	<b>EUT Type:</b> Portable Handset	Page 68 of 76	

**DASY5 E-field Result**

Date: 05.02.2013

Test Laboratory: SPEAG Lab2

**DUT: HAC Dipole 1880 MHz; Type: CD1880V3; Serial: CD1880V3 - SN: 1137**

Communication System: CW; Frequency: 1730 MHz, Frequency: 1880 MHz  
 Medium parameters used:  $\sigma = 0$  S/m,  $\epsilon_r = 1$ ;  $\rho = 1000$  kg/m<sup>3</sup>  
 Phantom section: RF Section  
 Measurement Standard: DASY5 (IEEE/IEC/ANSI C63.19-2007)

DASY52 Configuration:

- Probe: ER3DV6 - SN2336; ConvF(1, 1, 1); Calibrated: 28.12.2012;
- Sensor-Surface: (Fix Surface)
- Electronics: DAE4 Sn781; Calibrated: 29.05.2012
- Phantom: HAC Test Arch with AMCC; Type: SD HAC P01 BA; Serial: 1070
- DASY52 52.8.5(1059); SEMCAD X 14.6.8(7028)

**Dipole E-Field measurement @ 1880MHz/E-Scan - 1730MHz d=10mm/Hearing Aid Compatibility Test (41x181x1):**

Interpolated grid: dx=0.5000 mm, dy=0.5000 mm  
 Device Reference Point: 0, 0, -6.3 mm  
 Reference Value = 167.8 V/m; Power Drift = -0.03 dB  
 PMR not calibrated. PMF = 1.000 is applied.  
 E-field emissions = 154.1 V/m  
**Near-field category: M2 (AWF 0 dB)**

PMF scaled E-field



Grid 1 <b>M2</b> <b>143.6 V/m</b>	Grid 2 <b>M2</b> <b>150.3 V/m</b>	Grid 3 <b>M2</b> <b>148.3 V/m</b>
Grid 4 <b>M3</b> <b>99.24 V/m</b>	Grid 5 <b>M3</b> <b>103.5 V/m</b>	Grid 6 <b>M3</b> <b>100.7 V/m</b>
Grid 7 <b>M2</b> <b>141.6 V/m</b>	Grid 8 <b>M2</b> <b>154.1 V/m</b>	Grid 9 <b>M2</b> <b>153.3 V/m</b>

**Dipole E-Field measurement @ 1880MHz/E-Scan - 1730MHz d=15mm/Hearing Aid Compatibility Test (41x181x1):**

Interpolated grid: dx=0.5000 mm, dy=0.5000 mm  
 Device Reference Point: 0, 0, -6.3 mm  
 Reference Value = 167.4 V/m; Power Drift = 0.00 dB  
 PMR not calibrated. PMF = 1.000 is applied.  
 E-field emissions = 98.59 V/m  
**Near-field category: M3 (AWF 0 dB)**

PMF scaled E-field

Grid 1 <b>M3</b> <b>95.62 V/m</b>	Grid 2 <b>M3</b> <b>98.59 V/m</b>	Grid 3 <b>M3</b> <b>97.71 V/m</b>
Grid 4 <b>M3</b> <b>75.59 V/m</b>	Grid 5 <b>M3</b> <b>77.10 V/m</b>	Grid 6 <b>M3</b> <b>76.15 V/m</b>
Grid 7 <b>M3</b> <b>93.67 V/m</b>	Grid 8 <b>M3</b> <b>97.64 V/m</b>	Grid 9 <b>M3</b> <b>97.16 V/m</b>

FCC ID: ZNFH950	 <b>PCTEST</b> ENGINEERING LABORATORY, INC.	<b>HAC (RF EMISSIONS) TEST REPORT</b>	 <b>LG</b>	<b>Reviewed by:</b> Quality Manager
<b>Filename:</b> OY1501120071-R1.ZNF	<b>Test Dates:</b> January 12-15, 2015	<b>EUT Type:</b> Portable Handset	Page 69 of 76	

**Dipole E-Field measurement @ 1880MHz/E-Scan - 1880MHz d=10mm/Hearing Aid Compatibility Test (41x181x1):**

Interpolated grid: dx=0.5000 mm, dy=0.5000 mm  
 Device Reference Point: 0, 0, -6.3 mm  
 Reference Value = 152.4 V/m; Power Drift = -0.01 dB  
 PMR not calibrated. PMF = 1.000 is applied.  
 E-field emissions = 140.1 V/m  
**Near-field category: M2 (AWF 0 dB)**

PMF scaled E-field

Grid 1 M2	Grid 2 M2	Grid 3 M2
<b>133.0 V/m</b>	<b>139.2 V/m</b>	<b>137.5 V/m</b>
Grid 4 M3	Grid 5 M3	Grid 6 M3
<b>87.01 V/m</b>	<b>90.38 V/m</b>	<b>87.88 V/m</b>
Grid 7 M2	Grid 8 M2	Grid 9 M2
<b>128.4 V/m</b>	<b>140.1 V/m</b>	<b>139.5 V/m</b>

**Dipole E-Field measurement @ 1880MHz/E-Scan - 1880MHz d=15mm/Hearing Aid Compatibility Test (41x181x1):**



Interpolated grid: dx=0.5000 mm, dy=0.5000 mm  
 Device Reference Point: 0, 0, -6.3 mm  
 Reference Value = 152.6 V/m; Power Drift = -0.03 dB  
 PMR not calibrated. PMF = 1.000 is applied.  
 E-field emissions = 91.71 V/m  
**Near-field category: M3 (AWF 0 dB)**

PMF scaled E-field

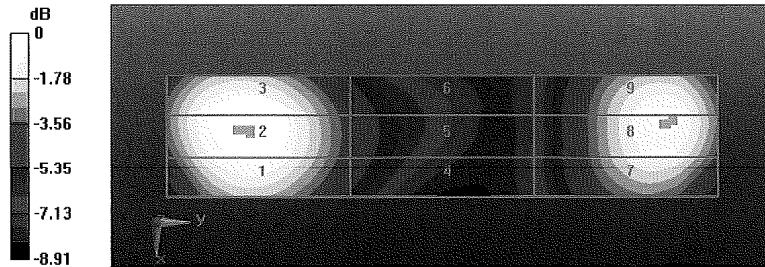
Grid 1 M3	Grid 2 M3	Grid 3 M3
<b>89.14 V/m</b>	<b>91.70 V/m</b>	<b>90.76 V/m</b>
Grid 4 M3	Grid 5 M3	Grid 6 M3
<b>69.64 V/m</b>	<b>70.74 V/m</b>	<b>69.97 V/m</b>
Grid 7 M3	Grid 8 M3	Grid 9 M3
<b>85.07 V/m</b>	<b>88.71 V/m</b>	<b>88.36 V/m</b>





0 dB = 154.1 V/m = 43.76 dBV/m

FCC ID: ZNFH950	 <b>PCTEST</b> ENGINEERING LABORATORY, INC.	<b>HAC (RF EMISSIONS) TEST REPORT</b>	 <b>LG</b>	<b>Reviewed by:</b> Quality Manager
<b>Filename:</b> 0Y1501120071-R1.ZNF	<b>Test Dates:</b> January 12-15, 2015	<b>EUT Type:</b> Portable Handset	Page 70 of 76	

## 15. CONCLUSION



The measurements indicate that the wireless communications device complies with the HAC limits specified in accordance with the ANSI C63.19 Standard and FCC WT Docket No. 01-309 RM-8658. Precise laboratory measures were taken to assure repeatability of the tests. The tested device complies with the requirements in respect to all parameters specific to the test. The test results and statements relate only to the item(s) tested.

Please note that the M-rating for this equipment only represents the field interference possible against a hypothetical and typical hearing aid. The measurement system and techniques presented in this evaluation are proposed in the ANSI standard as a means of best approximating wireless device compatibility with a hearing-aid. The literature is under continual re-construction.

<b>FCC ID:</b> ZNFH950	 <b>PCTEST</b> ENGINEERING LABORATORY, INC.	<b>HAC (RF EMISSIONS) TEST REPORT</b>	 <b>LG</b>	<b>Reviewed by:</b> Quality Manager
<b>Filename:</b> 0Y1501120071-R1.ZNF	<b>Test Dates:</b> January 12-15, 2015	<b>EUT Type:</b> Portable Handset	Page 71 of 76	



## 16. REFERENCES

1. ANSI/IEEE C63.19-2011, American National Standard for Methods of Measurement of Compatibility between Wireless Communication Devices and Hearing Aids.”, New York, NY, IEEE, May 2011
2. FCC Office of Engineering and Technology KDB, “285076 D01 HAC Guidance v04,” October 31, 2013
3. FCC Office of Engineering and Technology KDB, “285076 D02 T-Coil Testing for CMRS IP v01r01,” October 31, 2013
4. FCC Public Notice DA 06-1215, *Wireless Telecommunications Bureau and Office of Engineering and Technology Clarify Use of Revised Wireless Phone Hearing Aid Compatibility Standard*, June 6, 2006
5. Berger, H. S., “Compatibility Between Hearing Aids and Wireless Devices,” Electronic Industries Forum, Boston, MA, May, 1997
6. Berger, H. S., “Hearing Aid and Cellular Phone Compatibility: Working Toward Solutions,” *Wireless Telephones and Hearing Aids: New Challenges for Audiology*, Gallaudet University, Washington, D.C., May, 1997 (To be reprinted in the American Journal of Audiology).
7. Berger, H. S., “Hearing Aid Compatibility with Wireless Communications Devices,” IEEE International Symposium on Electromagnetic Compatibility, Austin, TX, August, 1997.
8. Bronaugh, E. L., “Simplifying EMI Immunity (Susceptibility) Tests in TEM Cells,” in the 1990 IEEE International Symposium on Electromagnetic Compatibility Symposium Record, Washington, D.C., August 1990, pp. 488-491
9. Byrne, D. and Dillon, H., The National Acoustics Laboratory (NAL) New Procedure for Selecting the Gain and Frequency Response of a Hearing Aid, *Ear and Hearing* 7:257-265, 1986.
10. Crawford, M. L., “Measurement of Electromagnetic Radiation from Electronic Equipment using TEM Transmission Cells,” U.S. Department of Commerce, National Bureau of Standards, NBSIR 73-306, Feb. 1973.
11. Crawford, M. L., and Workman, J. L., “Using a TEM Cell for EMC Measurements of Electronic Equipment,” U.S. Department of Commerce, National Bureau of Standards. Technical Note 1013, July 1981.
12. EHIMA GSM Project, Development phase, Project Report (1<sup>st</sup> part) Revision A. Technical-Audiological Laboratory and Telecom Denmark, October 1993.
13. EHIMA GSM Project, Development phase, Part II Project Report. Technical-Audiological Laboratory and Telecom Denmark, June 1994.
14. EHIMA GSM Project Final Report, Hearing Aids and GSM Mobile Telephones: Interference Problems, Methods of Measurement and Levels of Immunity. Technical-Audiological Laboratory and Telecom Denmark, 1995.

FCC ID: ZNFH950	 <b>PCTEST</b> ENGINEERING LABORATORY, INC.	HAC (RF EMISSIONS) TEST REPORT	 LG	Reviewed by: Quality Manager
Filename: OY1501120071-R1.ZNF	Test Dates: January 12-15, 2015	EUT Type: Portable Handset	Page 72 of 76	



15. HAMPIS Report, Comparison of Mobile phone electromagnetic near field with an upscaled electromagnetic far field, using hearing aid as reference, 21 October 1999.
16. Hearing Aids/GSM, Report from OTWIDAM, Technical-Audiological Laboratory and Telecom Denmark, April 1993.
17. IEEE 100, The Authoritative Dictionary of IEEE Standards Terms, Seventh Edition.
18. Joyner, K. H., et. al., Interference to Hearing Aids by the New Digital Mobile Telephone System, Global System for Mobile (GSM) Communication Standard, National Acoustic Laboratory, Australian Hearing Series, Sydney 1993.
19. Joyner, K. H., et. al., Interference to Hearing Aids by the Digital Mobile Telephone System, Global System for Mobile Communications (GSM), NAL Report #131, National Acoustic Laboratory, Australian Hearing Series, Sydney, 1995.
20. Kecker, W. T., Crawford, M. L., and Wilson, W. A., "Construction of a Transverse Electromagnetic Cell", U.S. Department of Commerce, National Bureau of Standards, Technical Note 1011, Nov. 1978.
21. Konigstein, D., and Hansen, D., "A New Family of TEM Cells with enlarged bandwidth and Optimized working Volume," in the Proceedings of the 7<sup>th</sup> International Symposium on EMC, Zurich, Switzerland, March 1987; 50:9, pp. 127-132.
22. Kuk, F., and Hjorstgaard, N. K., "Factors affecting interference from digital cellular telephones," Hearing Journal, 1997; 50:9, pp 32-34.
23. Ma, M. A., and Kanda, M., "Electromagnetic Compatibility and Interference Metrology," U.S. Department of Commerce, National Bureau of Standards, Technical Note 1099, July 1986, pp. 17-43.
24. Ma, M. A., Sreenivashiah, I. , and Chang, D. C., "A Method of Determining the Emission and Susceptibility Levels of Electrically Small Objects Using a TEM Cell," U.S. Department of Commerce, National Bureau of Standards, Technial Note 1040, July 1981.
25. McCandless, G. A., and Lyregaard, P. E., Prescription of Gain/Output (POGO) for Hearing Aids, Hearing Instruments 1:16-21, 1983
26. Skopec, M., "Hearing Aid Electromagnetic Interference from Digital Wireless Telephones, "IEEE Transactions on Rehabilitation Engineering, vol. 6, no. 2, pp. 235-239, June 1998.
27. Technical Report, GSM 05.90, GSM EMC Considerations, European Telecommunications Standards Institute, January 1993.
28. Victorian, T. A., "Digital Cellular Telephone Interference and Hearing Aid Compatibility—an Update," Hearing Journal 1998; 51:10, pp. 53-60
29. Wong, G. S. K., and Embleton, T. F. W., eds., AIP Handbook of Condenser Microphones: Theory, Calibration and Measurements, AIP Press.

<b>FCC ID:</b> ZNFH950	 <b>PCTEST</b> ENGINEERING LABORATORY, INC.	<b>HAC (RF EMISSIONS) TEST REPORT</b>	 <b>LG</b>	<b>Reviewed by:</b> Quality Manager
<b>Filename:</b> OY1501120071-R1.ZNF	<b>Test Dates:</b> January 12-15, 2015	<b>EUT Type:</b> Portable Handset	Page 73 of 76	