

USER GUIDE

LG-H830

User Guide

ENGLISH

- Some content and illustrations may differ from your device depending on the region, service provider, software version, or OS version, and are subject to change without prior notice.
- Always use genuine LG accessories. The supplied items are designed only for this device and may not be compatible with other devices.
- Available accessories may vary depending on your region, country or service provider.
- This device is not suitable for people who have a visual impairment due to the touchscreen keyboard.
- Copyright ©2015 LG Electronics, Inc. All rights reserved. LG and the LG logo are registered trademarks of LG Group and its related entities. All other trademarks are the property of their respective owners.
- Google™, Google Maps™, Gmail™, YouTube™, Hangouts™ and Play Store™ are trademarks of Google, Inc.

SERVICE ACTIVATION

If you are a new T-Mobile® customer and your service has not been activated, simply call Customer Care at **1-800-937-8997** from your landline phone and a T-Mobile Activations representative will assist you. You will need the following information when activating service:

- Service Agreement and agent code on your Agreement.
- Your name, home address, home phone, and billing address.

NOTE: For business and government accounts, please provide the name of your company or government agency, address, and tax ID.

- Your Social Security number, current driver's license number, and date of birth for credit check purposes.
- Your choice of T-Mobile rate plan and services (see www.t-mobile.com for the latest plan information).
- SIM serial number and IMEI number (located on the box bar code label).

By activating service, you acknowledge that you have read, understand, and agree to be bound by each of T-Mobile's Terms and Conditions and your Service Agreement.

About this user guide

Please read this user guide carefully before you use your phone and keep it handy for future reference.

Should your phone fails to operate correctly, refer to the FAQ section.

- Some features and service may vary by area, phone, carrier, plan and version of phone software.
- Screen displays and illustrations on this user manual may differ from those you see on the actual phone.
- Designs and specifications of the phone and other accessories are subject to change without any notice.

Table of contents

Important notice	8	Connecting to Networks and Devices	34
Getting to know your phone	11	Wi-Fi	34
Phone layout.....	11	Bluetooth.....	35
Installing the SIM or USIM card	13	Wi-Fi Direct	36
Charging the phone	15	Transferring data between a PC and your device.....	37
Unlocking the screen	16	Calls	38
Smart Lock.....	16	Making a call	38
Your Home screen	17	Calling your contacts	38
Touch screen tips	17	Answering and rejecting a call	38
Home screen	18	Making a second call.....	39
Customizing the Home screen	19	Viewing your call logs	39
Returning to recently-used applications	20	Call settings.....	39
Notifications panel.....	21	Contacts	40
On-screen keyboard	24	Searching for a contact.....	40
Special Features	25	Adding a new contact.....	40
Gesture shot.....	25	Favorites contacts.....	41
Gesture View	26	Creating a group.....	41
Glance View.....	27	Messaging	42
KnockON	27	Sending a message	42
Knock Code	28	Conversation view	43
Dual window.....	29	Changing message settings.....	43
Capture+	30	Email	44
QSlide.....	31	Managing email accounts.....	44
QuickRemote.....	32	Working with account folders.....	44
Google account setup	33	Composing and sending email.....	45

Camera and Video	46	LG Bridge	79
Camera options on the viewfinder.....	46	LG Bridge Features	79
Using the advanced settings	47	To download the LG Bridge software.....	79
Using the mode settings	48	Phone software update	80
Manual mode on the viewfinder.....	48	Phone software update.....	80
Taking a photo	49	About this user guide	82
Once you have taken a photo.....	50	About this user guide.....	82
Recording a video.....	51	Trademarks	83
After recording a video.....	51	DivX HD	83
Gallery.....	53	Dolby Digital Plus.....	83
Multimedia	57	Troubleshooting	84
Music	57	FAQ	88
Utilities	59	Anti-Theft Guide	94
Clock.....	59	Safety	95
Calculator.....	60		
Calendar.....	61		
Voice Recorder	61		
Voice Search.....	61		
Downloads	62		
LG Health	62		
Browsing the Web	63		
Chrome	63		
Settings	64		
Networks.....	64		
Sound & notification	68		
Display	69		
General.....	72		

 **Warning** Violation of the instructions may cause serious injury or death.

WARNING: This product contains chemicals known to the State of California to cause cancer and birth defects or other reproductive harm. ***Wash hands after handling.***



- Never use an unapproved battery since this could damage the phone and/or battery and could cause the battery to explode.



- Never place your phone in a microwave oven as it will cause the battery to explode.
- Do not dispose of your battery near fire or with hazardous or flammable materials.



- When riding in a car, do not leave your phone or set up the hands-free kit near the air bag. If wireless equipment is improperly installed and the air bag is deployed, you may be seriously injured.



- Do not use the phone in areas where its use is prohibited. (For example: aircraft)



- Do not expose the battery charger or adapter to direct sunlight or use it in places with high humidity, such as a bathroom.



- Do not use harsh chemicals (such as alcohol, benzene, thinners, etc.) or detergents to clean your phone. This could cause a fire.



- Do not drop, strike, or shake your phone severely. It may harm the internal circuit boards of the phone.



- Do not use your phone in high explosive areas as the phone may generate sparks.



- Do not damage the power cord by bending, twisting, pulling, or heating. Do not use the plug if it is loose as it may cause electric shock or fire.
- Do not place any heavy items on the power cord. Do not allow the power cord to be crimped as it may cause electric shock or fire.
- Do not handle the phone with wet hands while it is being charged. It may cause an electric shock or seriously damage your phone.



- Do not disassemble the phone.
- Do not place or answer calls while charging the phone as it may short-circuit the phone and/or cause electric shock or fire.



- Make sure that no sharp-edged items, such as animal's teeth or nails, come into contact with the battery. This could cause a fire.



- Store the battery out of reach of children.
- Be careful that children do not swallow any parts (such as earphone, connection parts of the phone, etc.) This could cause asphyxiation or suffocation resulting in serious injury or death.



- Unplug the power cord and charger during lightning storms to avoid electric shock or fire.



- Only use the batteries and chargers provided by LG. The warranty will not be applied to products provided by other suppliers.
- Only authorized personnel should service the phone and its accessories. Faulty installation or service may result in accidents and consequently invalidate the warranty.



- An emergency call can be made only within a service area. For an emergency call, make sure that you are within a service area and that the phone is turned on.
- Your phone is an electronic device that generates heat during normal operation. Extremely prolonged, direct skin contact in the absence of adequate ventilation may result in discomfort or minor burns. Therefore, use care when handling your phone during or immediately after operation.
- Use and store your phone in temperatures between 0°C/32°F and 45°C/113°F, if possible. Exposing your phone to extremely low or high temperatures may result in damage, malfunction, or even explosion.



Please read this before you start using your phone!

Please check to see whether any problems you encountered with your phone are described in this section before taking the phone in for service or calling a service representative.

1. Phone memory

When there is less than 10MB of space available in your phone memory, your phone cannot receive new messages. You must check your phone memory and delete some data, such as applications or messages, to make more memory available.

To uninstall applications:

- 1 Tap  >  >  > **General** tab > **Apps**.
- 2 Once all applications appear, scroll to and select the application you want to uninstall.
- 3 Tap **Uninstall**, then tap **OK** to confirm.

2. Optimizing battery life

Extend your battery's power by turning off features that you do not need to run constantly in the background. You can monitor how applications and system resources consume battery power.

Extending your phone's battery life:

- Turn off radio communications when you are not using. If you are not using Wi-Fi, Bluetooth® or Location services (including GPS), turn them off.
- Reduce screen brightness and set a shorter screen timeout.
- Turn off automatic syncing for Gmail, Calendar, Contacts and other applications.

NOTE:

- Some applications you download may consume battery power.
- While using downloaded applications, check the battery charge level.

3. Before installing an open source application and OS

WARNING

If you install and use an OS other than the one provided by the manufacturer it may cause your phone to malfunction. In addition, your phone will no longer be covered by the warranty.



WARNING

To protect your phone and personal data, only download applications from trusted sources, such as Play Store™. If there are improperly installed applications on your phone, the phone may not work normally or a serious error may occur. You must uninstall those applications and all associated data and settings from the phone.

4. Opening and switching applications

Multitasking is easy with Android; you can keep more than one application running at the same time. There is no need to quit an application before opening another. Use and switch between several open applications. Android manages each application, stopping and starting them as needed to make sure that idle applications don't consume resources unnecessarily.

To stop applications:

- 1 Tap . App previews of recently used applications will be displayed.
- 2 Tap the application you want to access. This does not stop the previous app from running in the background. Make sure to tap  to back out of a window after using it.
 - To close an app from the recent apps list, swipe the app preview to the left or right.
To clear all apps, tap **Clear all**.

5. If the screen freezes

If the screen freezes or the phone does not respond when you try to operate it, remove the battery and reinsert it. Then power the phone back on.

Getting to know your phone

Phone layout

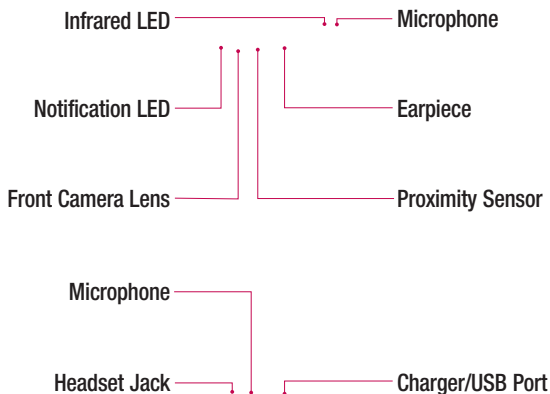

NOTE: Proximity Sensor

When receiving and making calls, the proximity sensor automatically turns the backlight off and locks the touch screen by sensing when the phone is near your ear. This extends battery life and prevents you from unintentionally activating the touch screen during calls.



WARNING

Placing a heavy object on the phone or sitting on it can damage the display and touch screen functions. Do not cover the proximity sensor with screen protectors or any other type of protective film. This could cause the sensor to malfunction.

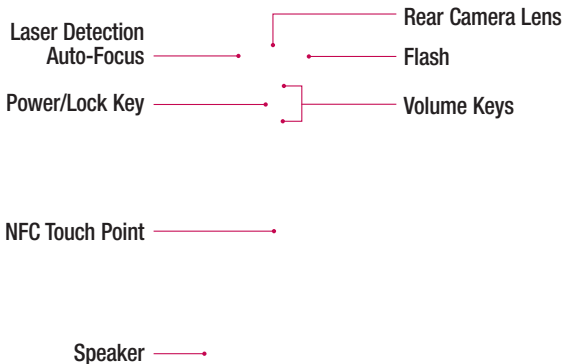

Power/Lock Key	<ul style="list-style-type: none"> • Press and hold to access the menu to turn your phone off, restart it, or turn airplane mode on and off. • Press once quickly to wake or lock the screen.
Volume Keys	<p>On the Home screen</p> <ul style="list-style-type: none"> • Control ringer volume. <p>During a call</p> <ul style="list-style-type: none"> • Control your earpiece volume. <p>When playing audio/video</p> <ul style="list-style-type: none"> • Control volume continuously. <p>While screen is off</p> <ul style="list-style-type: none"> • Press the Volume Up Key twice to launch Capture+. • Press the Volume Down Key twice to launch the Camera.

 **WARNING**

Be careful not to damage the NFC touch point on the phone, as this is part of the NFC antenna.

NOTE: Laser Detection Auto-Focus Sensor

Detects the distance between the rear camera and nearby objects using laser technology. This feature helps the camera to focus quickly and accurately at short or long distances.

Installing the SIM or USIM card

Before you can start exploring your new phone, you need to set it up.

- 1 To remove the back cover, hold the phone firmly in one hand. With your other hand, lift off the back cover with your thumbnail as shown in the figure below.

- 2 Slide the SIM card into the lower slot for the SIM card as shown in the figure. Make sure the gold contact area on the card is facing downward.

NOTE: Only microSIM cards work with this device.

- 3 Insert the battery.

- 4 To replace the cover onto the device, align the cover over the back of the phone **1** and press it down until it clicks into place **2**.

Charging the phone

Charge the battery before using it for first time. Use the charger to charge the battery.

WARNING

Use only LG-approved chargers, batteries and cables. If you use unapproved chargers, batteries or cables, it may cause a battery charging delay or display a pop-up message regarding slow charging. It can also cause the battery to explode or damage the device, which are not covered by the warranty.

The Charger/USB Port is located at the bottom of the phone. Insert the charger and plug it into a power outlet.

NOTE: Do not open the back cover while your phone is charging.

Unlocking the screen

By default, your screen will lock after a period of inactivity, then turn off.

Unlocking the screen

- 1 Press the **Power/Lock Key** or double-tap on the screen.
- 2 Swipe the screen in any direction to unlock it.

Smart Lock

You can use Smart Lock to make unlocking your phone easier. You can configure it to keep your phone unlocked when you have a trusted Bluetooth device connected to it, when it's in a familiar location, like your home or work, or when it recognizes your face.

Setting up Smart Lock

Before you activate Smart Lock, you need to set up a screen lock (Knock Code, Pattern, PIN, or Password).

- 1 Tap  >  > .
- 2 Tap the **Display** tab > **Lock screen** > **Smart Lock**.
- 3 Enter your current screen lock.
- 4 Tap one of the options and add trusted devices, locations or facial recognition.

Touch screen tips

Here are some tips on how to navigate on your phone.

- **Tap or touch** – A single finger tap selects items, links, shortcuts and letters on the on-screen keyboard.
- **Touch and hold** – Touch and hold an item on the screen by tapping it and not lifting your finger until an action occurs.
- **Drag** – Touch and hold an item for a moment and then, without lifting your finger, move your finger on the screen until you reach the target position. You can drag items on the Home screen to reposition them.
- **Swipe or slide** – To swipe or slide, quickly move your finger across the surface of the screen, without pausing when you first tap it (so you don't drag an item instead).
- **Double-tap** – Double-tap to zoom on a webpage or a map (if the feature is supported by the application).
- **Pinch-to-Zoom** – Use your index finger and thumb in a pinching or spreading motion to zoom in or out when using the browser or maps, or when browsing pictures (if the feature is supported by the application).
- **Rotate the screen** – From many applications and menus, the screen orientation adjusts to the device's physical orientation.

NOTE:

- Do not press too hard; the tap screen is sensitive enough to pick up a light, yet firm tap.
- Use the tip of your finger to tap the option you want. Be careful not to tap any other buttons.

Home screen

The Home screen is the starting point for many and functions. It allows you to add items like app shortcuts and Google widgets to give you instant access to information and applications. This is the default canvas and accessible from any menu by tapping .

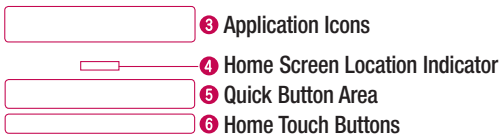
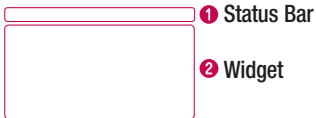

- 1** Shows the phone's status information, including the time, signal strength, battery status, and notification icons.
- 2** Widgets are self-contained applications that can be accessed through the Apps screen or on the Home screen. Unlike a shortcut, the Widget can function as an on-screen application.
- 3** Tap an icon (application, folder, etc.) to open and use it.
- 4** Indicates which Home screen canvas you are currently viewing.
- 5** Provides one-touch access to the function in any Home screen canvas.

6 ◀ Back Button	Returns to the previous screen. Also closes pop-up items, such as menus, dialog boxes and the on-screen keyboard.
○ Home Button	Return to the Home screen from any screen. Touch and hold to access the Google Now shortcut.
□ Recent Apps Button	Displays recently used applications. If you touch and hold this key, it opens a menu of available options.

Extended Home screen

The operating system provides multiple Home screen canvases to provide more space for adding icons, widgets and more.

- Slide your finger left or right across the Home screen to access additional canvases.

Customizing the Home screen

You can customize your Home screen by adding apps and widgets and changing wallpapers.

Adding items on your Home screen

- 1 Touch and hold the empty part of the Home screen.
- 2 Choose the **Apps** or **Widgets** tab and tap the desired item.
- 3 Drag it to the desired location and lift your finger.

TIP! To add an application icon to the Home screen from the Apps screen, touch and hold the application you want to add.

Removing an item from the Home screen

- While on the Home screen, touch and hold the icon you want to remove, then drag it to  and release it.

Adding an app as a Quick Button

- From the Apps screen or on the Home screen, touch and hold an application icon and drag it to the Quick Button area. Then release it in the desired location. Up to 6 apps can be added.

Removing an app from the Quick Button area

- Touch and hold the desired Quick Button, drag it to , and release it.

NOTE: The **Apps** Button  cannot be removed.

Customizing app icons on the Home screen

- 1 Touch and hold an application icon until it is unlocked from its current position, then release it. The editing icon  will appear in the upper right corner of the application.
- 2 Tap the application icon again and select the desired icon design and size.
- 3 Tap **OK** to save the change.

Returning to recently-used applications

- 1 Tap . App previews of recently used applications will be displayed.
- 2 Tap an app preview to open the application. Or tap  to return to the previous screen.

Notifications panel

Notifications alert you to the arrival of new messages, calendar events and alarms, as well as ongoing events, such as when you are using turn-by-turn navigation.

When a notification arrives, its icon appears at the top of the screen. Icons for pending notifications appear on the left, and system icons, such as Wi-Fi and battery strength are shown on the right.

NOTE: The available options may vary depending on the region or service provider.

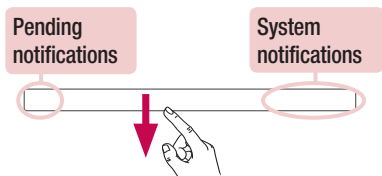

Opening the Notifications panel

Swipe down from the Status Bar to open the Notifications panel. To close the Notifications panel, swipe the screen upwards or tap .

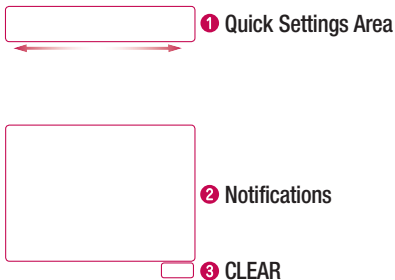











- 1** Tap each Quick Setting key to toggle it on/off. Touch and hold the desired key to directly access the function's settings menu. To see more Quick Setting keys, swipe left or right. Tap  to remove, add, or rearrange Quick Setting keys.
- 2** The current notifications are listed, each with a brief description. Tap a notification to open the corresponding application that manages it.
- 3** Tap to clear all of the notifications.











Indicator icons on the Status Bar



Indicator icons appear on the Status Bar at the top of the screen to report missed calls, new messages, calendar events, device status and more.





The icons displayed at the top of the screen provide information about the status of the device. The icons listed in the table below are some of the most common ones.

Icon	Description
	No SIM card inserted
	Ringer is silenced
	Vibrate mode is on
	Battery fully charged
	Battery is charging
	Phone is connected to PC via USB cable
	Downloading data
	Uploading data
	GPS is on
	Choose input method
	Media server content sharing is on

Icon	Description
	No network signal available
	Airplane mode is on
	Connected to a Wi-Fi network
	Wired headset (with mic) connected
	Call in progress
	Missed call
	Bluetooth is on
	System warning
	An alarm is set
	New voicemail available
	New text or multimedia message

	Wi-Fi hotspot is active
	LG AirDrive connected

	NFC is on
	Miracast connected

NOTE: The icon's location in the Status Bar may differ depending on the function or service.

On-screen keyboard

You can enter text using the on-screen keyboard. The on-screen keyboard appears on the screen when you tap an available text entry field.

Using the keypad and entering text

 Tap once to capitalize the next letter you type. Tap twice for all caps.

 Tap to enter text by voice. Touch and hold to enter text by manual handwriting, access the Clip Tray, and access the keyboard settings.

 Tap to enter a space.

 Tap to create a new line in the message field.

 Tap to delete the previous character.

Entering special characters

The LG Keyboard allows you to enter special characters (e.g. "á") when entering text. For example, to enter "á", touch and hold the "a" key until the additional characters are displayed. Without lifting the finger, drag your finger to the desired special character and lift it off.

NOTE: A symbol at the top right corner of a key indicates that additional characters are available for that key.

Special Features

Gesture shot

The Gesture shot feature allows you to take a picture with a hand gesture using the front camera.

To take photo

There are two methods for using the Gesture shot feature.

- Raise your hand, with an open palm, until the front camera detects it and a box appears on the screen. Then close your hand into a fist to start the timer, allowing you time to get ready.
- Raise your hand, in a clenched fist, until the front camera detects it and a box appears on the screen. Then unclench your fist to start the timer, allowing you time to get ready.

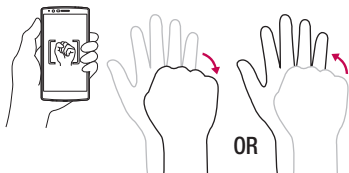



TIP! Interval shot

If you make a fist twice or touch and hold , the camera consecutively takes 4 photos at a time.

Gesture View

After taking a photo with the front camera lens, you can automatically check the captured photo with this gesture.

- 1 Tap  >  > .
- 2 Take a picture with the front camera.
- 3 After taking the picture, bring the phone close to your face. The captured photo will be displayed.

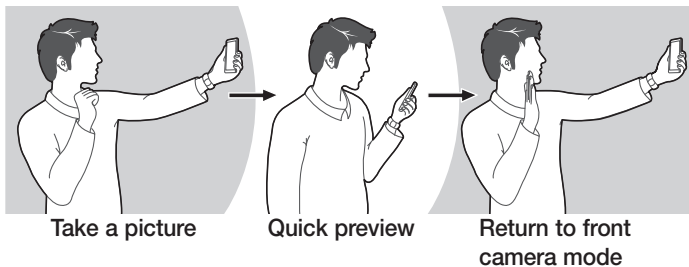

NOTE:

- Depending on the speed and angle of the gesture, this feature may not work properly.
- When the angle is changed after the Quick preview, your phone will go back to camera mode. You must go to Gallery to view the picture again.

Glance View

When the phone screen is off, you can see the Status Bar, time and date by dragging your finger down from the top of the screen.



KnockON

You can wake up, or turn off, the screen as easily as double-tapping the screen. While the screen is off, and idle, double-tap the center screen quickly to wake the screen. To turn the screen off, double-tap the Status Bar in any screen (except on the camera viewfinder) or empty area on the Home screen.



NOTE: When using KnockOn to wake the screen, make sure you do not cover the proximity sensor. Doing so will prevent the screen from turning on. This feature is designed to prevent the device from turning on inadvertently in your pocket or storage location.

Knock Code

The Knock Code feature allows you to wake and unlock the screen with your own Knock Code pattern. When enabled, Knock Code divides the screen into 4 parts and uses your unique combination of taps to secure your device. You can disable this feature in the Lock screen settings.

NOTE:

- If you enter an incorrect Knock Code combination 6 times, it will be necessary to use your Google account log in or backup PIN.
- Use the fingertip instead of finger nail to tap the screen when using Knock Code.

- 1 Tap  >  >  > **Display tab > Lock screen > Select screen lock > Knock Code.**
- 2 Follow the on-screen steps to set your Knock Code. You have to create a Backup PIN as a safety measure in case you forget your Knock Code.

Unlocking the screen using the Knock Code

You can wake up and unlock the screen by tapping the Knock Code, set up in the previous section, when the screen is off.

Dual window

This feature allows you to multi-task by splitting up the screen into two, allowing you to use two compatible applications at the same time.

1 Tap  > **Dual window**.

2 Tap or drag the app icon for the corresponding application you wish to use.

 : Tap to view the Dual window menu options, or drag to resize the split screens.



 : Switch the two screens.

 : View the app list.

 : Change the selected window to full screen.

 : Close the currently selected app window.

NOTE: Dual window is enabled by default. You can enable or disable Dual window through the Settings menu.



1 Tap  >  >  > **General** tab > **Dual window**.

2 Slide the toggle button to **On** or **Off**.

Capture+

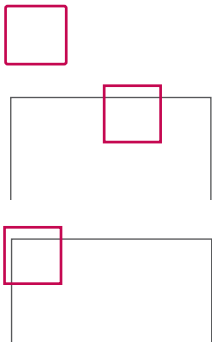
The Capture+ feature allows you to capture screen shots and use them to create memos. You can use Capture+ to easily create memos during a call, with a saved picture or on the current phone screen and share them with family and friends.



- 1 While the screen is on, slide the Status Bar downward and tap .
- 2 Use the toolbar to create a memo.
- 3 Tap  to save the memo. To exit Capture+ at any time, tap .





QSlide

From any screen, use the Notifications panel to easily access and use the Calendar, Calculator, and more with QSlide.



1 2 3

4

1		Tap to expand the window to full window size.
2		Tap to adjust the window's transparency.
3		Tap to close the QSlide window.
4		Drag to adjust the window's size.

- 1 Touch and slide the Status Bar downward and tap **QSlide** to view the available QSlide apps.

TIP! Also, while using applications that support QSlide, tap  > **QSlide**. The function is displayed as a small window on your screen.

- 2 You can use and tap the screen under the **QSlide** windows when the transparency bar is not full .

NOTE: QSlide can support up to two windows at the same time.

QuickRemote

QuickRemote turns your phone into a Universal Remote for your home TV, cable box and audio system, and more.

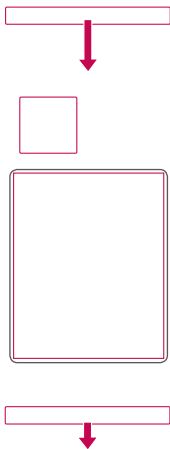

- 1 Touch and slide the Status Bar downward and tap  > **ADD REMOTE**.

OR

Tap  >  >  > .

- 2 Select the type and brand of the device, then follow the on-screen instructions to configure the device.

- 3 Once you have completed the initial set up, you can easily access the QuickRemote from the Notifications panel. Open the Notifications panel and use the QuickRemote functions.

NOTE: The QuickRemote operates the same way as an ordinary remote control infrared (IR) signals. Be careful not to cover the infrared sensor at the top of the phone when you use the QuickRemote function. This function may not be supported depending on the model, the manufacturer or service company.

Google account setup

When you first turn on your phone, you have the opportunity to sign into your Google Account and select how you want to use certain Google services.

Setting up your Google account

- During the initial boot up of your device, ensure your device is connected to the Web. Then, sign into a Google Account from the prompted setup screen.

OR

- After having exited the Startup Wizard, tap  >  >  > **General** tab > **Accounts & sync** > **ADD ACCOUNT** > **Google**.

If you already have a Google account, enter your email address and tap **NEXT**.

Once you have set up your Google account on your phone, your phone will automatically synchronize with your Google account on the Web (if data connection is available).

Depending on your synchronization settings, your contacts, Gmail messages, Calendar events and other information from these applications and services on the Web are synchronized with your phone.





After signing in, you can use Gmail™ and take advantage of Google services on your phone.

Connecting to Networks and Devices

Wi-Fi

You can use high-speed Internet access while within the coverage of the wireless access point (AP).





Connecting to Wi-Fi networks

- 1 Tap  >  >  > **Networks** tab > **Wi-Fi**.
- 2 Tap  to turn Wi-Fi on and start scanning for available Wi-Fi networks.
- 3 Tap a network to connect to it.
 - If the network is secured with a lock icon, you will need to enter a security key or password.

NOTE:

- The Status Bar displays icons that indicate Wi-Fi status.
- If you are out of the Wi-Fi zone or have set Wi-Fi to Off, the device may automatically connect to the Web using mobile data, which may incur data charges.

TIP! How to obtain the phone's MAC address

Tap  >  >  > **Networks** tab > **Wi-Fi** >  > **Advanced Wi-Fi** > **MAC address**.





Bluetooth

You can use Bluetooth to connect with headsets, sound systems, or even to exchange data between nearby devices.

NOTE:

- LG is not responsible for the loss, interception or misuse of data sent or received via the Bluetooth feature.
- Always ensure that you share and receive data with devices that are trusted and properly secured.
- If there are obstacles between the devices, the operating distance may be reduced.
- Some devices, especially those that are not tested or approved by Bluetooth SIG, may be incompatible with your device.

Pairing your phone with another Bluetooth device

- 1 Tap  >  >  > **Networks** tab > **Bluetooth**.
- 2 Tap  to turn Bluetooth on.
- 3 Tap **SEARCH** to view the visible devices in range.
- 4 Choose the device you want to pair with from the list and follow any subsequent instructions to complete pairing. Once the pairing is successful, your phone connects to the other device.

NOTE: Some devices, especially headsets or hands-free car kits, may have a default Bluetooth PIN, such as 0000.

Sending data via Bluetooth

- 1 Using an application that supports sharing, locate the data, or file, that you want to share.
- 2 Select the **Share** option.
- 3 Select **Bluetooth**.
- 4 Select the paired Bluetooth device (or pair with a new device).

NOTE: The method for selecting an option may vary by data type.

Receiving data via Bluetooth

- 1 Tap  >  >  > **Networks** tab > **Bluetooth**.
- 2 Tap  to turn Bluetooth on.
- 3 You will receive a request to accept a pairing attempt from the sending device. Be sure to select **ACCEPT**.

Wi-Fi Direct

Wi-Fi Direct provides a direct connection between Wi-Fi enabled devices without requiring an access point.

Turning on Wi-Fi Direct

- 1 Tap  >  >  > **Networks** tab > **Wi-Fi**.
- 2 Tap  > **Advanced Wi-Fi** > **Wi-Fi Direct**.

NOTE: When in this menu, your device is visible to other visible Wi-Fi Direct devices nearby.

Transferring data between a PC and your device

You can copy or move data between a PC and the device.





Transferring data

- 1 Connect your device to a PC using the USB cable that came with your phone.
- 2 Open the Notifications panel and select **Media device (MTP)**.
- 3 A window will pop up on your PC, allowing you to transfer the desired data.

NOTE: The LG Android Platform Driver is required to be installed on your PC to be able to detect the phone.



Items	Requirement
OS	Microsoft Windows XP SP3, Vista or higher
Window Media Player version	Windows Media Player 10 or higher

Making a call

- 1 Tap  >  to open the dialer.
- 2 Enter the number using the dialer. To delete a digit, tap .
- 3 After entering the desired number, tap  to place the call.
- 4 To end the call, tap .

TIP! To enter "+" to make international calls, touch and hold .

Calling your contacts





- 1 Tap  >  to open your contacts.
- 2 Scroll through the contact list. You can also enter the contact's name in the Search field or scroll along the alphabet letters on the right edge of the screen.
- 3 To place the call, tap  next to the contact you want to call.

Answering and rejecting a call

When you receive a call, swipe  in any direction to answer the call.

Swipe  in any direction to decline the call.

Making a second call

- 1 During your first call, tap  > **Add call**.
- 2 Enter the number and tap  to place the call.
- 3 Both calls are displayed on the call screen. Your initial call is locked and put on hold.
- 4 To toggle between numbers, tap the number displayed on the screen. You can also tap  to start a conference call.
- 5 To end all calls, tap .

NOTE: You may be charged for each call you make.

Viewing your call logs

- Tap  >  and select the **Call logs** tab.



A list of all dialed, received and missed calls is displayed.

TIP!

- Tap any call log entry to view the date, time and duration of the call.
- Tap  > **Clear all** to delete all of the recorded items.

Call settings



You can configure phone call settings, such as call forwarding, as well as other special features offered by your carrier.

- 1 Tap  >  to open the dialer.
- 2 Tap  > **Call settings** and configure the desired options.



Contacts

Add contacts to your phone and synchronize them with the contacts in your Google account or other accounts that support contact syncing.

Searching for a contact

- 1 Tap  >  to open your contacts.
- 2 Tap **Search contacts** and enter the contact name using the keyboard. You can also scroll along the alphabet letters on the right edge of the screen.



Adding a new contact

- 1 Tap  >  and enter the new contact's number.
- 2 Tap  > **Add to Contacts**.
- 3 If you want to add a picture to the new contact, tap the image icon. Choose **Take photo** or **Select from Gallery**.
- 4 Enter the desired information for the contact.
- 5 Tap **SAVE**.



Favorites contacts

You can classify frequently called contacts as favorites.



Adding a contact to your favorites

- 1 Tap  >  to open your contacts.
- 2 Tap a contact to view its details.
- 3 Tap the star at the top right corner of the screen. The star turns gold.

Removing a contact from your favorites list

- 1 Tap  >  to open your contacts.
- 2 Tap the **Favorites** tab and choose a contact to view its details.
- 3 Tap the gold star at the top right corner of the screen. The star turns a dark color and the contact is removed from your favorites.

Creating a group





- 1 Tap  >  to open your contacts.
- 2 Tap **Groups** >  > **New group**.
- 3 Enter a name for the new group. You can also set a distinct ringtone for the group and the account to save the group to.
- 4 Tap **Add members** to add contacts to the group.
- 5 Tap **SAVE** to save the group.

NOTE: If you delete a group, the contacts assigned to that group are not lost. They remain in your contact list.

Messaging

Your phone combines text and multimedia messages into one intuitive, easy-to-use menu.

Sending a message

- 1 Tap  >  >  >  to create a new message.
- 2 Enter a contact name or contact number into the **To** field. As you enter the contact name, matching contacts appear. You can tap a suggested recipient and add more than one contact.

NOTE: You may be charged for each text message you send. Please consult with your service provider.

- 3 Tap the text field and begin composing your message.
- 4 Tap  to open the messaging options.

TIP! You can tap  to attach a file that you want to share.

- 5 Tap **Send** to send your message.

TIP!

- The 160-character limit may vary from country to country, depending on the language and how the text message is coded.
- If an image, video or audio file is added to a text message, it is automatically converted into a multimedia message and you may be charged accordingly.

Conversation view

Text and multimedia messages exchanged with another party are displayed in chronological order so that you can conveniently see and find your conversations.

Changing message settings

Your phone's messaging settings are predefined to allow you to send messages immediately. You can change the settings based on your preferences.

- Tap  >  >  >  > **Settings**.

You can use the Email application to read emails from services like Gmail. The Email application supports the following account types: POP3, IMAP and Exchange. Your service provider or system administrator can provide you with the account settings you need.





Managing email accounts

The first time you open the Email application, a setup wizard opens to help you to set up an email account.

Adding another email account:

- Tap  >  >  >  > **Settings** > .

Changing the email general settings:

- Tap  >  >  >  > **Settings** > **General settings**.







Deleting an email account:

- Tap  >  >  >  > **Settings** >  > **Remove account** > Select the account you want to delete > **REMOVE** > **YES**.

Working with account folders

To access your email account's folders, open the **Email** app and tap  > **Show all folders**. Each account has an Inbox, Outbox, Sent and Drafts folder. Depending on the features supported by your account's service provider, you may have additional folders.

Composing and sending email

- 1 Tap  >  >  >  to create a new email.
- 2 Enter an address for the message's intended recipient. As you enter text, matching addresses will be offered from your contacts. Separate multiple addresses with semicolons.
- 3 Tap the **Cc/Bcc** field to copy or blind copy to other contacts/email addresses.
- 4 Tap the text field and enter your message.
- 5 Tap  to attach the file you want to send with your message.
- 6 Tap  to send the message.

Camera options on the viewfinder

You can use the camera or camcorder to take and share pictures and videos.

- Tap  >  >  >  >  > .









- 1 Camera mode** – Tap to select the camera mode. Choose from **Simple**, **Auto**, and **Manual**.
- 2 Flash** – Allows you to manage the camera's flash.
- 3 Swap camera** – Tap to swap between the rear camera lens and the front camera lens.
- 4 Shot mode** – Allows you to select the shot mode for the picture.
- 5 Settings** – Tap this icon to open the camera settings menu.
- 6 Gallery** – Tap to view the last photo or video you recorded.
- 7 Record** – Tap to start recording.
- 8 Capture** – Tap to take a photo.
- 9 Exit** – Tap to exit the camera.

NOTE Be sure to clean the protective lens cover with a microfiber cloth before taking pictures. A lens cover with smudges from fingers can cause blurry pictures with a "halo" effect.



Using the advanced settings

In the camera viewfinder, tap  to show the advanced options. Tap each icon to adjust the following camera settings.

	Combines photos taken at multiple exposures into one optimal photo to get a better photo in difficult lighting situations.
	Selects the photo and video resolution.
	Allows you to say a voice command to take pictures. You can say LG, Cheese, Smile, or any other available command.
	Sets a delay after the capture key is pressed. This is ideal if you want to be a part of the picture or video.
	Allows you to take better pictures and record better videos by displaying a grid line for help with alignment.
	Set the storage location for your pictures and videos. This menu appears only when the SD card is inserted.
	Allows you to learn how a function works. This icon will provide you with a help guide.

Using the mode settings

In the camera viewfinder, tap **Mode** to show the mode options. Tap each icon to use the following mode settings.

	Allows you to take a panoramic picture.
	The Dual feature allows you to take a picture or record a video with the front and rear cameras at the same time.
	Recording a video for viewing it in slow motion.





Manual mode on the viewfinder

You can control every detail option manually.

- Tap  >  >  >  > .





-  – Tap to select a file format between JPEG and DNG.
-  – Tap to improve color quality in various lighting conditions.





- 3  – Tap to use the manual focus mode.
- 4  – Tap to adjust the brightness.
- 5  – Tap to adjust the ISO.
- 6  – Tap to adjust the shutter speed.
- 7  – Tap to use the auto expose lock.
- 8 Display the manual status information.

Using the advanced settings for the manual mode

In the camera viewfinder, tap  to show the advanced options. Tap each icon to adjust the following camera settings.







	Tap to display a incline or a grid line for help with alignment.
	Tap to display a histogram.

Taking a photo

- 1 Tap  >  > .
- 2 Frame your subject on the screen.
- 3 The green squares (Auto mode) or green lines (Manual mode) indicate that the camera has focused.
- 4 Tap  to take a photo. Your picture will be automatically saved to the Gallery.

Once you have taken a photo

Tap the image thumbnail on the screen to view the last photo you took.

	Tap to edit the photo.
	Tap to take another photo immediately.
	Tap to open the available sharing options.
	Tap to delete the photo.
	Tap to access additional options.
	Tap to add the photo to your favorites.

Multi-point Auto-focus

When you take a picture, the Multi-point Auto-focus (AF) function operates automatically and will allow you to see a clear image.

Burst shot

Allows you to take multiple shots quickly. Touch and hold . This feature is only available in Auto mode.

3X Zooming





When using the front camera lens, you can zoom in or out to 3x.

8X Zooming



When using the rear camera lens, you can zoom in or out to 8x.

NOTE Use a steady hand. This feature does not work with some functions. Objects may be overlapped when taking a picture of fast-moving subjects.

Recording a video





- 1 Tap  >  > .
- 2 Frame your subject on the screen.
- 3 Tap  to start recording the video.
- 4 The length of the recording is displayed at the top of the screen.

NOTE Tap  to take pictures while recording video.

- 5 Tap  to pause the recording. You can resume recording again by tapping .
- OR
- Tap  to stop recording. Your video will be automatically saved to the Gallery.

After recording a video

Tap the video thumbnail on the screen to view the last video you recorded.

	Tap to record another video immediately.
	Tap to open the available sharing options (such as Messaging or Bluetooth) to share.
	Tap to delete the video.
	Tap to access additional options.
	Tap to add the video to your favorites

Live Zoom

Live Zoom allows you to zoom in or out on a portion of a video that is being played to make the desired section appear larger or smaller.

When viewing a video, use your index finger and thumb in a pinching or spreading motion to zoom in or out.

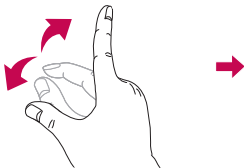

NOTE Do not press too hard; the touch screen is sensitive enough to pick up a light, but firm touch.



Dual Play

Dual Play connects two devices using a USB cable or a wireless connection, allowing you to view content on a different screen. The connectable device can be a TV or a monitor. Viewable content can come from the Gallery and Video apps, however not all videos are supported by Dual Play.

NOTE Tap  once when two displays are a different status (i.e. the monitor is playing a video and your phone's video applications is displaying an empty screen), then Dual Play will start. Dual Play operates at 1280X720 or higher display resolution.

Gallery

The Gallery application presents the pictures and videos in your storage, including those you've taken with the Camera application and those you downloaded from the web or other locations.

1 Tap  >  > .

NOTE



- Depending on the software installed, some file formats may not be supported.
- Some files may not play properly due to their encoding.

Viewing pictures

The Gallery displays your pictures in folders. When an application, such as E-mail, saves a picture, a folder is automatically created to contain the picture. Pictures are displayed by the date they were created. Select a picture to view it full screen. Scroll left or right to view the next or previous image.

Timeline view

The Gallery automatically sorts and displays a lot of photos in chronological order to see at a glance.

1 Tap  >  > .

2 Tap  > **Timeline**.

3 Select from **Year**, **Month** and **Day**.

Memories view

The Gallery automatically organizes and displays the memories albums depending on the region and time information of saved photos.

- 1 Tap  >  > .
- 2 Tap  > **Memories**.
- 3 Select the desired albums.

NOTE This feature is a location based service. Take photos and videos with their locations.

Zooming in and out









Use one of the following methods to zoom in and out on an image:

- Double-tap anywhere to zoom in and out.
- Spread two fingers apart on any place in the picture zoom in. Pinch in to zoom out.

Video options

- 1 Tap  >  > .
- 2 Select the video you want to watch.



1		Touch to pause/resume video playback.
2		Touch to fast-forward 10 seconds.
3		Touch to rewind 10 seconds.
4		Touch to adjust the video volume.
5		Touch to lock/unlock the screen.
6		Touch to use QSlide for the Videos app.
7		Tap to share your video using the SmartShare function.
8		Tap to access additional options.

NOTE



- While playing a video, slide the right side of the screen up or down to adjust the sound.
- While playing a video, slide the left side of the screen up or down to adjust the brightness.
- While playing a video, slide your finger from left to right (or vice versa) to fast-forward and rewind.

Editing photos

While viewing a photo, tap .

Deleting photos/videos

Use one of the following methods:

- While in a folder, tap , select the photos/videos and then tap **DELETE**.
- While viewing a photo, tap .



Setting wallpaper

While viewing a photo, tap  > **Set image as** to set the image as wallpaper or assign it to a contact.



NOTE

- Depending on the software installed, some file formats may not be supported.
- If the file size exceeds the available memory, an error can occur when you open files.



Music





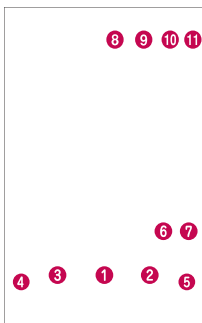



Your phone has a music player that lets you play all your favorite tracks. To access the music player, tap  >  > .

Playing a song

- 1 Tap  >  > .
- 2 Tap the **Songs** tab.
- 3 Select the song you want to play.
- 4 The following options are available.



1		Tap to pause playback.
		Tap to resume playback.
2		Tap to skip to the next track in the album, playlist or shuffle list. Touch and hold to fast-forward.

3		Tap to restart the current track or skip to the previous track in the album, playlist or shuffle list. Touch and hold to rewind.
4		Tap to adjust the volume.
5		Tap to set audio effects.
6		Tap to play the current playlist in shuffle mode (tracks are played in random order).
7		Tap to toggle through repeat all songs, repeat current song and repeat off.
8		Tap to share your music using the SmartShare function.
9		Tap to add the song to your favorites.
10		Tap to open the current playlist.
11		Tap to access additional options.



To change the volume while listening to music, press the Volume Up/Down Keys on the back side of the phone.

NOTE:

- Depending on the software installed, some file formats may not be supported.
- If the file size exceeds the available memory, an error can occur when you open files.
- Music file copyrights may be protected by international treaties and national copyright laws. Therefore, it may be necessary to obtain permission or a license to reproduce or copy music. In some countries, national laws prohibit private copying of copyrighted material. Before downloading or copying the file, check the national laws of the relevant country concerning the use of such material.

Clock

The Clock application gives you access to the Alarms, Timer, World clock and Stopwatch functions. Access these functions by tapping the tabs across the top of the screen or swiping horizontally across the screen.

- Tap  >  > .

Alarms

The Alarms tab allows you to set alarms.

- 1 Tap  >  >  > **Alarms** tab.
- 2 Tap  to add a new alarm.
- 3 Adjust the settings as necessary and tap **SAVE**.

NOTE You can also tap an existing alarm to edit it.

Timer

The Timer tab can alert you with an audible signal when a set amount of time has passed.

- 1 Tap  >  >  > **Timer** tab.
- 2 Set the desired time on the timer.
- 3 Tap **Start** to start the timer.
- 4 Tap **Stop** to stop the timer.



World clock

The World clock tab allows you to easily check the current time in other cities around the world.

- 1 Tap  >  >  > **World clock** tab.
- 2 Tap  and select the desired city.



Stopwatch

The Stopwatch tab allows you to use your phone as a stopwatch.

- 1 Tap  >  >  > **Stopwatch** tab.
- 2 Tap **Start** to initiate the stopwatch.
 - Tap **Lap** to record lap times.
- 3 Tap **Stop** to stop stopwatch.

Calculator





The Calculator application allows you to perform mathematical calculations using a standard or scientific calculator.

- 1 Tap  >  > .
- 2 Tap the number buttons to enter numbers.
- 3 For simple calculations, tap the function you want to perform (+, -, x or ÷) followed by =.

NOTE For more complex calculations, tap  > **Scientific calculator**.

Calendar







The Calendar application allows you to track your schedule of events.

- 1 Tap  >  > .
- 2 Tap the date you want to add an event to. Then tap .
- 3 Enter the event details and tap **SAVE** to save the event.

Voice Recorder

The Voice Recorder application records audible files for you to use in a variety of ways.





Recording a sound or voice

- 1 Tap  >  > .
- 2 Tap  to begin recording.
- 3 Tap  to end the recording.
- 4 Tap  to listen to the recording.

NOTE Tap  to access your recordings. You can listen to your saved recordings.

Voice Search



Use this application to search webpages using voice.

- 1 Tap  >  >  > .
- 2 Say a keyword or phrase when **Listening...** appears on the screen. Select one of the suggested keywords that appear.

NOTE This application may not be available depending on the region or service provider.



Downloads

Use this application to see what files have been downloaded through the applications.

- Tap  >  > .

LG Health

The LG Health helps you manage your health and maintain good exercise habits by tracking logs and competing with people.



- 1 Tap  >  > .
- 2 Read and agree to the terms and conditions.
- 3 On the Profile and goal page, enter your profile information and tap **SAVE**.
- 4 Use the options below to begin tracking activity.

NOTE: This feature is provided for user convenience. Please use for reference only.

Browsing the Web

Chrome

Use Chrome to search for information and browse webpages.

- Tap  >  > .



NOTE: This application may not be available, depending on your region and service provider.

Viewing webpages

In the Chrome browser, tap the address field, and then enter a web address or search criteria and tap **Go** on the keyboard.

Opening a page

To open a new page, tap  > **New tab**.

To go to another webpage, tap  (if tabs are merged with apps) or  at the top right corner of the browser (if tabs are not merged with apps). Then tap the desired page to view it.



Settings

This section provides an overview of items you can change using your phone's System Settings menus.

Accessing the Settings menu:

- From the Home screen, touch and hold  > **System settings**.

OR

- Tap  >  > .

Networks

< WIRELESS NETWORKS >

Airplane mode

Airplane Mode (flight mode) allows you to use many of your phone's features, such as games, and music, when you are in an area where making or receiving calls or data use is prohibited. When you set your phone to Airplane Mode, it cannot send or receive any calls or access online data.

Wi-Fi

Allows you to manage your Wi-Fi connections and connect to available Wi-Fi networks.

Bluetooth

Allows you to manage your the Bluetooth wireless feature.

Mobile data

Displays the data usage and allows you to set a mobile data usage limit.

Call

Configure phone call settings such as call forwarding and other special features offered by your carrier.

- **Voicemail** – Allows you to manage your voicemail settings.
- **VoLTE** – Allows you to turn the VoLTE feature on and off.
- **Wi-Fi Calling** – Wi-Fi Calling can improve your coverage and allows you to make phone calls over a Wi-Fi network (when a Wi-Fi network is available).

Important! Wi-Fi Calling requires that you use the SIM card that is shipped with your phone. Also, you must register your address for 9-1-1. Wi-Fi Calling will not work until you have registered for 9-1-1 by logging into your account at www.T-Mobile.com. Go to your profile and click **Customer Info** and continue on to enter your address.

- **Fixed dialing numbers** – Turn on and compile a list of numbers that can be called from your phone. You'll need your PIN2, which is available from your operator. Only numbers within the fixed dial list can be called from your phone.
- **Incoming voice call pop-up** – Displays a pop-up for an incoming call when an app is in use.
- **Call reject** – Allows you to set call rejection and manage the reject list.
- **Decline with message** – When you want to reject a call, you can send a quick message instead. This is useful if you need to reject a call during a meeting. This menu allows you to manage the messages you can send.
- **Call forwarding** – Allows you to set the call forwarding options.
- **Auto answer** – Automatically answer after the set time, when a hands-free device is connected.
- **Connection vibration** – Vibrates your phone when the other party answers the call.
- **TTY mode** – Allows you to activate TTY mode.

- **Hearing aids** – Allows you to turn on hearing aid compatibility.
- **Noise suppression** – Suppresses background noise on your device during a call.
- **Voice clarity** – Enable to enhance voice clarity in noisy environments, allowing you to hear more clearly.
- **Power key ends call** – Allows you to end the call by pressing the Power/Lock Key.
- **Answer an incoming call** – Enable to allow you to bring the device to your ear to automatically answer the incoming call.
- **Silence incoming calls** – Enable to allow you to flip the device to silence incoming calls.
- **Call barring** – Tap to lock incoming and/or outgoing international calls.
- **Call duration** – View the duration of calls, including Last call, Outgoing calls, Incoming calls and All calls.
- **Additional settings** – Allows you to manage the caller ID and call waiting settings.
- **Speaker** – Allows the speakerphone to turn on when a video call starts.

< CONNECTIVITY >

Share & connect

- **NFC** – Your device is an NFC-enabled mobile phone. NFC (Near Field Communication) is a wireless connectivity technology that enables two-way communication between electronic devices. It operates over a distance of a few centimeters. You can share your content with an NFC tag or another NFC support device by simply tapping it with your device. If you tap an NFC tag with your device, it displays the tag content on your device.
- **Android Beam** – When this feature is turned on, you can transfer app content to another NFC-capable device by holding the devices close together. Just bring the device together (typically back to back) and then tap your screen. The app determines what gets beamed.
- **SmartShare Beam** – Allows you to receive multimedia content via LG phones and tablets.

- **Media server** – Share media content with nearby DLNA-compatible devices.
- **Miracast** – Allows you to wirelessly mirror the phone screen and sound onto a Miracast dongle or TV.
- **LG AirDrive** – Allows you to connect to your PC to manage your phone. Download LG Bridge from the LG Electronics website on your PC before use. When you sign in to the same LG Account on your phone and PC, you can use the LG AirDrive function.
- **Printing**
 - **Cloud Print** – Allows you to manage your Google Cloud Print settings and print jobs.

Tethering

- **USB tethering** – Allows you to share the internet connection with your computer via a USB cable.
- **Mobile HotSpot** – Allows you to create a hotspot and share your connection.
- **Help** – Displays Help information about USB tethering and Wi-Fi hotspot.

More

- **Wi-Fi Calling** – Wi-Fi Calling can improve your coverage and allows you to make phone calls over a Wi-Fi network (when a Wi-Fi network is available).
- **Mobile networks** – This menu allows you to configure various mobile network settings.
- **VPN** – From your phone, you can add, set up, and manage virtual private networks (VPNs) that allow you to connect and access resources inside a secured local network, such as your corporate network.

NOTE: You must set a screen lock before you can use VPN.

Sound & notification

< BASIC >

Sound profile

Allows you to set your phone's sound profile. Choose from **Sound**, **Vibrate only** and **Silent**.

< SOUND >

Volume

Adjust the phone's volume settings to suit your needs and environment.

Ringtone

Allows you to set the ringtones for calls. You can also add a ringtone by tapping  in the upper-right corner of the screen.

Ringtone ID

Allows to compose ringtones automatically based on phone number of the incoming call.

< VIBRATION >

Vibration strength

Allows you to set the vibration strength for calls, notifications and touch feedback.

Sound with vibration

Allows you to set the phone to vibrate in addition to the ringtone when you receive calls.

Vibration type

Allows you to choose the type of vibration.

< NOTIFICATIONS >

Do not disturb

Allows you to set a schedule when to prevent interruptions from notifications. You can set to allow certain features to interrupt when Priority only is set.

Lock screen

Allows you to choose if you want to show or hide notifications on the lock screen.

Apps



Allows you to prevent apps from displaying notifications. You can also set apps to show notifications with priority when Interruptions is set to Priority only.

Notification LED

Tap the switch to toggle it On or Off. On activates the LED light for the notifications you select, in the color you set for each.

< ADVANCED SETTINGS >

More

- **Notification sound** – Allows you to set the notification sound. You can also add a notification sound by tapping  in the upper-right corner of the screen.
- **Vibrate on tap** – Enable to vibrate when tapping the Home touch buttons and during other UI interactions.
- **Sound effects** – Tap to set the dial pad touch tones, touch sounds and screen lock sound. You can also set the behavior when an emergency call is made.
- **Message/call voice notifications** – Tap  toggle it On or Off. On allows your device to read out incoming calls and message events automatically.

Display

< HOME & LOCK >

Home screen

- **Select Home** – Allows you to select the home interface you would like to use. Choose **Home** for users experienced with Android's layout or **EasyHome** for an easier interface for beginners.

- **Smart Bulletin** – Tap  to toggle it On or Off. Activating this feature adds an additional Home screen showing customized information.
- **Theme** – Allows you to select a theme for your phone. You can download more themes from LG SmartWorld.
- **Wallpaper** – Allows you to set the desired wallpaper for your Home screen.
- **Screen swipe effect** – Choose the desired type of effect to display when you swipe from one Home screen canvas to the next.
- **Allow Home screen looping** – Displays the first screen after the last screen when scrolling the Home screen.
- **Help** – Displays help information for the Home screen.

Lock screen

- **Select screen lock** – Allows you to set the screen lock for your phone.
- **Smart Lock** – Allows you to set to keep your phone unlocked when you have a trusted Bluetooth device connected to it, when it's in a familiar location like your home or work, or when it recognizes your face.
- **Screen swipe effect** – Sets the effect used when swiping across the lock screen.
- **Wallpaper** – Allows you to set your Lock screen wallpaper.
- **Shortcuts** – Allows you to choose the shortcuts available on the lock screen.
- **Weather animation** – Enable to show weather animation on the lock screen for the current location.
- **Contact info for lost phone** – Allows you to display the owner information on the lock screen in case the phone is lost.
- **Lock timer** – Allows you to set the amount of time before the screen automatically locks after the screen has timed-out.
- **Power button instantly locks** – Allows you to instantly lock the screen when the Power/Lock Key is pressed. This setting overrides the Lock timer setting.

Home touch buttons

Set the Home touch buttons displayed at the bottom of all screens. Set which keys are displayed, their position on the bar and what they look like. You can also choose to hide them while using certain apps.

< **FONT** >

Font type

Allows you to set the type of font used for the phone and menus.

Font size

Allows you to set the size of the font displayed in the phone and menus.

< **BASIC SETTINGS** >

Brightness

Adjusts the brightness of the screen. For best battery performance, use the dimmest comfortable brightness.

Auto-rotate screen

Allows you to set to switch the screen orientation automatically when you physically rotate the phone.

Screen timeout

Allows you to set the amount of time before the screen times out.

< **ADVANCED SETTINGS** >

More

- **Daydream** – Tap  to toggle it On or Off. On allows you to set a screensaver to be displayed when the phone is sleeping while docked and/or charging.
- **Motion sensor calibration** – Allows you to improve the accuracy of the tilt and speed of the sensor.

General

< PERSONAL >

Language & keyboard

Use the Language & keyboard settings to select the language for the text on your phone and to configure the on-screen keyboard.

- **Language** – Sets the language to use on your device.
- **Current keyboard** – Allows you to set the default keyboard to use when entering text.
- **LG Keyboard** – Allows you to enable the LG Keyboard to enter text.
- **Google voice typing** – Allows you to enable Google voice typing to enter text.
- **Text-to-speech output** – Sets the preferred speech engine and speech rate (slow vs. fast). Also plays a short demonstration of speech synthesis.
- **Pointer speed** – Allows you to set the pointer speed using a slide bar.
- **Reverse buttons** – Reverse the mouse buttons to use the primary button on the right side.

Location

Allows you to manage location services to determine your approximate location using GPS, Wi-Fi and mobile networks.

- **Mode** – Sets the how your current location information is determined.
- **My place** - Allows your device to locate your home for the Smart settings.
- **Camera** – Enable to tag photos or videos with their locations.
- **Google Location History** – Allows you to choose your location information settings as accessed by Google and its products.

Accounts & sync

Permits applications to synchronize data in the background, whether or not you are actively using them. Deactivating the **Auto-sync data** option can save battery power and lower (but not eliminate) data usage.

Cloud

Allows you to add a cloud account to quickly and easily use a cloud service.

Accessibility

Use the Accessibility settings to configure accessibility plug-ins you have installed on your phone.

• Vision

- **TalkBack** – Allows you to set up the TalkBack function which assists people with impaired vision by providing verbal feedback.
- **Message/call voice notifications** – Tap  to toggle it On or Off. On allows you to hear automatic spoken alerts for incoming calls and messages.
- **Screen shade** – Enable to set the screen to a darker contrast.
- **Font size** – Sets the font size.
- **Touch zoom** – Allows you to zoom in and out by triple-tapping the screen.
- **Screen color inversion** – Enable to invert the colors of the screen and content.
- **Screen color adjustment** – Allows you to view the screen with greater color contrast.
- **Screen color filter** – Allows you to set color filters for the screen.
- **Power key ends call** – Enable so that you can end voice calls by pressing the Power/Lock Key.

• Hearing

- **Captions** – Allows you to customize caption settings for those with hearing impairments.
- **Notification LED** – Allows you to activate the LED light for incoming calls and notifications.
- **Flash alerts** – Enable to set the flash to blink for incoming calls and notifications.
- **Turn off all sounds** – Enable to turn off all device sounds.
- **Audio type** – Sets the audio type.
- **Sound balance** – Sets the audio route. Move the slider on the slide bar to set it.

• **Motor & cognition**

- **Touch feedback time** – Sets the touch feedback time.
- **Touch assistant** – Show a touch board with easy access to common actions.
- **Screen timeout** – Sets the amount of time before the backlight turns off automatically.
- **Touch control areas** – Allows you to select an area of the screen to limit touch activation to just that area of the screen.

• **Accessibility features shortcut**

Allow you to access selected features quickly when triple-tapping the Home button.

• **Auto-rotate screen**

Enable to allow the phone to rotate the screen depending on the physical phone orientation (portrait or landscape).

• **Switch Access**

Allows you to interact with your device using one or more switches that work like keyboard keys. This menu can be helpful for users with mobility limitations that prevent them from interacting directly with the your device.

Shortcut key

Get quick access to apps by pressing twice the Volume Keys when the screen is off or locked. Tap  in the upper-right corner of the screen to toggle it **On** or **Off**.

Google

Use the Google Settings to manage your Google apps and account settings.

< **PRIVACY** >

Security

- **Content lock** – Select lock types to lock files in Gallery and QuickMemo+. Choose from **Password** or **Pattern**.
- **Encrypt phone** – Opens a screen that encrypts data on the phone for security. You will be required to enter a PIN or password to decrypt your phone each time you power it on.

- **Encrypt SD card storage** – Allows you to encrypt the SD card and keep data unavailable for other devices.
- **Set up SIM card lock** – Sets the PIN to lock your SIM card and allows you to change the PIN.
- **Password typing visible** – Enable to briefly show each character of passwords as you enter them so that you can see what you enter.
- **Phone administrators** – Allows you to view or deactivate phone administrators.
- **Unknown sources** – Allows you to install non-Play store applications.
- **Verify apps** – Disallow or warn before installation of apps that may cause harm.
- **Storage type** – Displays the storage type for credentials.
- **Certificate management**
 - **Trusted credentials** – Enable to allow applications to access your phone's encrypted store of secure certificates and related passwords and other credentials. You use credential storage to establish some types of VPN and Wi-Fi connections. If you have not set a password for the secure credential storage, this setting is dimmed.
 - **Install from storage** – Tap to install a secure certificate.
 - **Clear credentials** – Deletes all secure certificates and related credentials and erases the secure storage's own password.
- **Trust agents** – Select apps to use without unlocking the screen.
- **Screen pin** – This feature allows you to lock your device so that the current user can only access the pinned app. This is useful for users with children.
- **App usage access** – Allows you to view usage information of applications on your phone.

< SMART FUNCTIONS >

Smart settings

Allows you to turn on/off, open or change settings according to where you are or what you do.

QuickCircle case

This menu allows you to select apps to be used directly on the cover in small view using QuickCircle.

Dual window

Allows you to configure the Dual Window feature.

- **Auto-open** – Enable to allow you to tap a link on the full screen or attachments from emails to open Dual window.
- **Help** – Display tips for using Dual window.

< PHONE MANAGEMENT >

Date & time

Use the Date & time settings to set how dates will be displayed. You can also use these settings to set your own time and time zone rather than obtaining the current time from the mobile network.

Storage & USB

- **Internal storage** – Allows you to view information about the internal storage usage.
- **SD card** – Allows you to view information about storage use on the SD card. You can also mount and unmount an SD card or erase its contents.

Battery & power saving

- **Battery usage** – Displays the battery usage level and battery use details.
- **Battery percentage on status bar** – Enable to display the battery level percentage on the Status Bar next to the Battery icon.
- **Battery saver** – Tap the Battery Saver switch to toggle it on or off. Sets the battery charge percent level that automatically turns on Battery Saver. You can also restrict apps in the background.
- **Game optimizer** – Allows you to adjust the video quality in games to save battery.

Memory

You can monitor the memory used on average and the memory used by apps in the device.

Smart cleaning

Allows you to manage unused apps and data.

Apps

This menu lets you view details about the applications installed on your phone, manage their data, force them to stop.

Default message app

This menu allows you to set your default messaging app as desired.

Backup & reset

This menu allows you to back-up your data, automatically restore data, and erase all the data on your phone.

- **LG Backup** – Backs up all information on the device and restores it in the event of data loss or replacement.
- **Back up my data** – Back up application data, Wi-Fi passwords, and other settings to Google servers.
- **Backup account** – Displays the account that is currently being used to back up information.
- **Automatic restore** – When reinstalling an application, restore backed up settings and data.
- **Network settings reset** – Reset all network settings.
- **Factory data reset** – Reset your settings to the factory default values and delete all your data. If you reset the phone this way, you are prompted to re-enter the same information as when you first started Android.
- **Collect diagnostics** – Collect diagnostics data for troubleshooting.

About phone

Display information about the network, phone identity, battery, hardware, software, legal, and patent information.

LG Bridge

LG Bridge is an application that helps you conveniently manage images, music, videos, documents, etc. saved on a LG mobile device on your PC. Also, you can back up your files such as contacts and images to your PC or update software of a mobile device.

NOTE

- You can see detailed instructions on how to use LG Bridge in Help menu after installing and opening the program.
- Supported features may vary depending on the device.
- The LG unified USB driver is a program required to connect an LG mobile phone to a PC. It is automatically installed when installing LG Bridge.

LG Bridge Features

- Manage contents from your phone on PC via Wi-Fi or mobile data.
- Back up and restore the data of your mobile device via USB.
- Update software of a mobile device on your PC via USB.

To download the LG Bridge software

- 1 Go to www.lg.com.
- 2 Click on **Support > Software & Firmware > LG Bridge**.
- 3 Scroll down and select the **Windows PC** or **Mac OS** download link to download LG Bridge.

Phone software update

Phone software update

LG Mobile phone software update from the Internet

For more information about using this function, please visit <http://www.lg.com/common/index.jsp> → select your country and language.

This feature allows you to conveniently update the firmware on your phone to a newer version from the Internet without needing to visit a service center. This feature will only be available if and when LG makes a newer firmware version available for your device. Because the mobile phone firmware update requires the user's full attention for the duration of the update process, please make sure you check all instructions and notes that appear at each step before proceeding. Please note that removing the USB data cable during the upgrade may seriously damage your mobile phone.

NOTE: LG reserves the right to make firmware updates available only for selected models at its own discretion and does not guarantee the availability of the newer version of the firmware for all handset models.

LG Mobile Phone software update via Over-the-Air (OTA)

This feature allows you to conveniently update your phone's software to a newer version via OTA, without connecting using a USB data cable. This feature will only be available if and when LG makes a newer firmware version available for your device. You should first check the software version on your mobile phone: **Settings > General tab > About phone > Update Center > System updates > CHECK FOR UPDATE.**

NOTE: Your personal data from internal phone storage—including information about your Google account and any other accounts, your system/application data and settings, any downloaded applications and your DRM licence—might be lost in the process of updating your phone's software. Therefore, LG recommends that you backup your personal data before updating your phone's software. LG does not take responsibility for any loss of personal data.

NOTE: This feature depends on your network service provider, region and country.

Notice: Open Source Software

To obtain the source code under GPL, LGPL, MPL, and other open source licenses, that is contained in this product, please visit <http://opensource.lge.com>.

In addition to the source code, all referred license terms, warranty disclaimers and copyright notices are available for download.

LG Electronics will also provide open source code to you on CD-ROM for a charge covering the cost of performing such distribution (such as the cost of media, shipping, and handling) upon email request to opensource@lge.com. This offer is valid for three (3) years from the date on which you purchased the product.

About this user guide

- Before using your device, please carefully read this guide. This ensures that you use your phone safely and correctly.
- Some of the images and screenshots provided in this guide may appear differently on your phone.
- Your content may differ from the final product or from software supplied by service providers or carriers. This content is subject to change without prior notice. For the latest version of this guide, please visit the LG website at www.lg.com.
- Your phone's applications and their functions may vary by country, region or hardware specifications. LG cannot be held liable for any performance issues resulting from the use of applications developed by providers other than LG.
- LG cannot be held liable for performance or incompatibility issues resulting from edited registry settings or modified operating system software. Any attempt to customize your operating system may cause the device or its applications to work incorrectly.
- Software, audio, wallpaper, images, and other media supplied with your device are licensed for limited use. If you extract and use these materials for commercial or other purposes, you may be infringing copyright laws. As a user, you are fully and entirely responsible for the illegal use of media.
- Additional charges may apply for data services, such as messaging, uploading, downloading, auto-syncing and location services. To avoid additional charges, select a data plan suitable to your needs. Contact your service provider to obtain additional details.

Trademarks

- Copyright ©2015 LG Electronics, Inc. All rights reserved. LG and the LG logo are registered trademarks of LG Group and its related entities.
- Google™, Google Maps™, Gmail™, YouTube™, Hangouts™ and Play Store™ are trademarks of Google, Inc.
- Bluetooth® is a registered trademark of Bluetooth SIG, Inc. worldwide.
- Wi-Fi® and the Wi-Fi logo are registered trademarks of the Wi-Fi Alliance.
- All other trademarks and copyrights are the property of their respective owners.

DivX HD

This DivX Certified® device has passed rigorous testing to ensure it plays DivX® video. To play purchased DivX movies, first register your device at vod.divx.com. Find your registration code in the DivX VOD section of your device setup menu.

DivX Certified® to play DivX® video up to HD 720p, including premium content.
DivX®, DivX Certified® and associated logos are trademarks of DivX, LLC and are used under license.

Dolby Digital Plus **DOLBY** DIGITAL PLUS

Manufactured under license from Dolby Laboratories. Dolby, Dolby Digital Plus, and the double-D symbol are trademarks of Dolby Laboratories.

Troubleshooting

This chapter lists some problems you might encounter when using your phone. Some problems require you to call your service provider, but most are easy to fix yourself.



Message	Possible causes	Possible corrective measures
SIM or USIM card error	There is no SIM or USIM card in the phone or it is inserted incorrectly.	Make sure that the SIM card is correctly inserted.
No network connection/ Dropped network	Signal is weak or you are outside the carrier network.	Move toward a window or into an open area. Check the network operator coverage map.
	Operator applied new services.	Check whether the SIM card is more than 6~12 months old. If so, change your SIM card at your network provider's nearest branch. Contact your service provider.
Codes do not match	To change a security code, must confirm the new code by re-entering it.	If you forget the code, contact your service provider.
	The two codes you entered do not match.	

Message	Possible causes	Possible corrective measures
No applications can be set	Not supported by service provider or registration required.	Contact your service provider.
Calls not available	Dialing error	New network not authorized.
	New SIM or USIM card inserted.	Check for new restrictions.
	Pre-paid charge limit reached.	Contact service provider or reset limit with PIN2.
Phone cannot be turned on	On/Off key pressed too briefly.	Press the On/Off key for at least two seconds.
	Battery is not charged.	Charge battery. Check the charging indicator on the display.

Message	Possible causes	Possible corrective measures
Charging error	Battery is not charged.	Charge battery.
	Outside temperature is too hot or cold.	Make sure phone is charging at a normal temperature.
	Contact problem	Check the charger and its connection to the phone.
	No voltage	Plug the charger into a different outlet.
	Charger defective	Replace the charger.
	Wrong charger	Use only original LG accessories.
Number not allowed.	The Fixed dialing number function is on.	Check the Settings menu and turn the function off.
Impossible to receive/send text messages & photos	Memory full	Delete some messages from your phone.
Files do not open	Unsupported file format	Check the supported file formats.

Message	Possible causes	Possible corrective measures
The screen does not turn on when I receive a call.	Proximity sensor problem	If you use a protection tape or case, make sure it has not covered the area around the proximity sensor. Make sure that the area around the proximity sensor is clean.
No sound	Vibration mode	Check the settings status in the sound menu to make sure you are not in vibration or silent mode.
Hangs up or freezes	Intermittent software problem	Try to perform a software update through the website.

Category	Question	Answer
Bluetooth Devices	What functions are available via Bluetooth?	You can connect a Bluetooth audio device, such as a Stereo/Mono headset or car kit.
Contacts Backup	How can I back up Contacts?	Contacts data can be synchronized between your phone and Gmail™.
Synchronization	Is it possible to set up one-way sync with Gmail?	Only two-way synchronization is available.
Synchronization	Is it possible to synchronize all email folders?	The Inbox is automatically synchronized. You can view other folders by tapping the  icon and selecting Show all folders to choose a folder.
Gmail Log-In	Do I have to log into Gmail whenever I want to access Gmail?	Once you have logged into Gmail, there is no need to log into Gmail again.
Google Account	Is it possible to filter emails?	No, the phone does not support email filtering.
Email	What happens when I execute another application while writing an email?	Your email is automatically saved as a draft.
Ringtone	Is there a file size limit for using MP3 files as ringtones?	There is no file size limit.

Category	Question	Answer
Message Time	My phone does not display the time of receipt for messages older than 24 hrs. How can I change this?	Open the conversation and touch and hold the desired message to see the details.
Navigation	Is it possible to install another navigation application on my phone?	Any application that is available at Play Store™ and is compatible with the hardware can be installed and used.
Synchronization	Is it possible to synchronize my contacts from all my email accounts?	Only Gmail and MS Exchange server (company email server) contacts can be synchronized.
Wait and Pause	Is it possible to save a contact with Wait and Pause in the numbers?	<p>If you transferred a contact using the Wait & Pause functions saved into the number, you cannot use those features. You must save each number again.</p> <p>How to save with Wait and Pause:</p> <ol style="list-style-type: none"> 1. From the Home screen, tap . 2. Dial the number, then tap . 3. Tap Add 2-sec pause or Add wait.
Security	What are the phone's security functions?	You can set the phone to require an Unlock Pattern to be entered before the phone can be accessed or used.

Category	Question	Answer
Unlock Pattern	How do I create the Unlock Pattern?	<ol style="list-style-type: none"> 1. From the Home screen, touch and hold . 2. Tap System settings > Display tab > Lock screen. 3. Tap Select screen lock > Pattern. The first time you do this, a short tutorial about creating an Unlock Pattern appears. 4. Set up your pattern by drawing it then drawing it a second time for confirmation. <p>Precautions to take when using the pattern lock.</p> <p>It is very important to remember the unlock pattern you set. You can no longer access your phone if you use an incorrect pattern five times. You have five chances to enter your unlock pattern, PIN or password. If you have used all 5 opportunities, you can try again after 30 seconds. (Or, if you preset the backup PIN, you can use it to unlock the pattern.)</p>

Category	Question	Answer
Unlock Pattern	What should I do if I forget the unlock pattern and I did not create my Google account on the phone?	<p>If you forgot your pattern:</p> <p>If you logged into your Google account on the phone but failed to enter the correct pattern 5 times, tap the Forgot pattern button. You are then required to log in with your Google account to unlock your phone. If you have not created a Google account on the phone or you have forgotten it, you must perform a hard reset.</p> <p>Caution: If you perform a factory reset, all user applications and user data are deleted. Please remember to back up any important data before performing a factory reset.</p>
Memory	Will I know when my memory is full?	Yes, you will receive a notification.
Language Support	Is it possible to change my phone's language?	<p>The phone has multilingual capabilities. To change the language:</p> <ol style="list-style-type: none"> 1. From the Home screen, touch and hold  and tap System settings. 2. Tap General tab > Language & keyboard > Language. 3. Tap the desired language.
VPN	How do I set up a VPN?	VPN access configuration is different for each company. To configure VPN access on your phone, you must obtain the details from your company's network administrator.

Category	Question	Answer
Screen time out	My screen turns off after only 15 seconds. How can I change the amount of time for the backlight to turn off?	<ol style="list-style-type: none"> 1. From the Home screen, touch and hold <input type="checkbox"/>. 2. Tap System settings > Display tab. 3. Tap Screen timeout. 4. Tap the preferred screen backlight timeout time.
Wi-Fi & mobile network	When the Wi-Fi and mobile networks are both available, which service does my phone use?	<p>When using data, your phone may default to the Wi-Fi connection (if Wi-Fi connectivity on your phone is set to On). However, there is no notification when your phone switches from one to the other.</p> <p>To know which data connection is being used, view the mobile network or Wi-Fi icon at the top of your screen.</p>
Home screen	Is it possible to remove an application from the Home screen?	Yes. Just touch and hold the icon until the trash can icon appears at the top and center of the screen. Then, without lifting your finger, drag the icon to the trash can.
Application	I downloaded an application and it causes a lot of errors. How do I remove it?	<ol style="list-style-type: none"> 1. From the Home screen, touch and hold <input type="checkbox"/>. 2. Tap System settings > General tab > Apps. 3. Tap the application, then tap Uninstall.

Category	Question	Answer
Charger	Is it possible to charge my phone using a USB cable without installing the necessary USB driver?	Yes, the phone is charged through the USB cable regardless of whether the necessary drivers are installed.
Alarm	Can I use music files for my alarm?	Yes. After saving a music file as a ringtone, you can use it as an alarm. 1. Touch and hold a song in a library list. In the menu that opens, tap Set as ringtone > Phone ringtone or Caller ringtones . 2. On the Alarm Clock Setting screen, select the song as a ringtone.
Alarm	Will my alarm be audible or will it go off if the phone is turned off?	No, this is not supported.
Alarm	If my ringer volume is set to Off or Vibrate, will I hear my alarm?	Your alarm is programmed to be audible even in these scenarios.
Hard Reset (Factory Reset)	How can I perform a factory reset if I cannot access the phone's Settings menu?	If your phone does not restore to its original condition, use a hard reset (factory reset) to initialize it.

Anti-Theft Guide

You can set up your device to prevent other people from using it if it's been reset to factory settings without your permission. For example, if your device is lost, stolen, or wiped, only someone with your Google account or screen lock information can use the device.

All you need to make sure your device is protected is:

- **Set a screen lock:** If your device is lost or stolen but you have a screen lock set, the device can't be erased using the Settings menu unless your screen is unlocked.
- **Add your Google account on your device:** If your device is wiped but you have your Google account on it, the device can't finish the setup process until your Google account information is entered again.

After your device is protected, you'll need to either unlock your screen or enter your Google account password if you need to do a factory reset. This ensures that you or someone you trust is doing the reset.

NOTE: Do not forget your Google account and password you had added to your device prior to performing a factory reset. If you can't provide the account information during the setup process, you won't be able to use the device at all after performing the factory reset.

HAC

This phone has been tested and rated for use with hearing aids for some of the wireless technologies that it uses. However, there may be some newer wireless technologies used in this phone that have not been tested yet for use with hearing aids. It is important to try the different features of this phone thoroughly and in different locations, using your hearing aid or cochlear implant, to determine if you hear any interfering noise. Consult your service provider or the manufacturer of this phone for information on hearing aid compatibility. If you have questions about return or exchange policies, consult your service provider or phone retailer.

FCC RF Exposure Information

WARNING! Read this information before operating the phone.

In August 1996, the Federal Communications Commission (FCC) of the United States, with its action in Report and Order FCC 96-326, adopted an updated safety standard for human exposure to Radio Frequency (RF) electromagnetic energy emitted by FCC regulated transmitters. Those guidelines are consistent with the safety standard previously set by both U.S. and international standards bodies. The design of this phone complies with the FCC guidelines and these international standards.

Body-worn Operation

This device was tested for typical body-worn operations with the back of the phone kept 0.39 inches (1cm) between the user's body and the back of the phone. To comply with FCC RF exposure requirements, a minimum separation distance of 0.39 inches (1cm) must be maintained between the user's body and the back of the phone. Any belt-clips, holsters, and similar accessories containing metallic components may not be used. Body-worn accessories that cannot maintain 0.39 inches (1cm) separation distance between the user's body and the back of the phone, and have not been tested for

typical body-worn operations may not comply with FCC RF exposure limits and should be avoided.

Part 15.19 statement

This device complies with part 15 of the FCC Rules. Operation is subject to the following two conditions:

- (1) This device may not cause harmful interference.
- (2) This device must accept any interference received, including interference that may cause undesired operation.

Part 15.21 statement

Changes or modifications that are not expressly approved by the manufacturer for compliance could void the user's authority to operate the equipment.

Part 15.105 statement

This equipment has been tested and found to comply with the limits for a class B digital device, pursuant to Part 15 of the FCC rules. These limits are designed to provide reasonable protection against harmful interference in a residential installation. This equipment generates, uses, and can radiate radio frequency energy and, if not installed and used in accordance with the instructions, may cause harmful interference to radio communications. However, there is no guarantee that interference will not occur in a particular installation. If this equipment does cause harmful interference to radio or television reception, which can be determined by turning the equipment off and on, the

user is encouraged to try to correct the interference by one or more of the following measures:

- Reorient or relocate the receiving antenna.
- Increase the separation between the equipment and receiver.
- Connect the equipment into an outlet on a circuit different from that to which the receiver is connected.
- Consult the dealer or an experienced radio/TV technician for help.

Consumer Information About Radio Frequency Emissions

Your wireless phone, which contains a radio transmitter and receiver, emits radio frequency energy during use. The following consumer information addresses commonly asked questions about the health effects of wireless phones. Are wireless phones safe?

Scientific research on the subject of wireless phones and radio frequency (“RF”) energy has been conducted worldwide for many years, and continues. In the United States, the Food and Drug Administration (“FDA”) and the Federal Communications Commission (“FCC”) set policies and procedures for wireless phones. The FDA issued a website publication on health issues related to cell phone usage where it states, “The scientific community at large . . . believes that the weight of scientific evidence does not show an association between exposure to radiofrequency (RF) from cell phones and adverse health outcomes. Still the scientific community does recommend conducting additional research to address gaps in knowledge. That research is being conducted around the world and FDA continues to monitor developments in this field. You can access the joint FDA/FCC website at <http://www.fda.gov> (under “c” in the subject index, select Cell Phones > Research). You can also contact the FDA toll-free at (888) 463-6332 or (888) INFO-FDA. In June 2000, the FDA entered into a cooperative research and development agreement through which additional scientific research is being conducted. The FCC

issued its own website publication stating that “there is no scientific evidence that proves that wireless phone usage can lead to cancer or a variety of other problems, including headaches, dizziness or memory loss.” This publication is available at <http://www.fcc.gov/cgb/cellular.html> or through the FCC at (888) 225-5322 or (888) CALL-FCC.

What does “SAR” mean?

In 1996, the FCC, working with the FDA, the U.S. Environmental Protection Agency, and other agencies, established RF exposure safety guidelines for wireless phones in the United States. Before a wireless phone model is available for sale to the public, it must be tested by the manufacturer and certified to the FCC that it does not exceed limits established by the FCC. One of these limits is expressed as a Specific Absorption Rate, or “SAR.” SAR is a measure of the rate of absorption of RF energy in the body. Tests for SAR are conducted with the phone transmitting at its highest power level in all tested frequency bands. Since 1996, the FCC has required that the SAR of handheld wireless phones not exceed 1.6 watts per kilogram, averaged over one gram of tissue. Although the SAR is determined at the highest power level, the actual SAR value of a wireless phone while operating can be less than the reported SAR value. This is because the SAR value may vary from call to call, depending on factors such as proximity to a cell site, the proximity of the phone to the body while in use, and the use of hands-free devices. For more information about SARs, see the FCC’s OET

Bulletins 56 and 65 at <https://www.fcc.gov/general/oet-bulletins-line>

or visit the Cellular Telecommunications Industry Association website at http://www.ctia.org/consumer_info/index.cfm/AID/10371. You may also wish to contact the manufacturer of your phone.

Can I minimize my RF exposure?

If you are concerned about RF, there are several simple steps you can take to minimize your RF exposure. You can, of course, reduce your talk time. You can place more distance between your body and the source of the RF, as the exposure level drops off dramatically with distance. The FDA/FCC website states that “hands-free kits can be

used with wireless phones for convenience and comfort. These systems reduce the absorption of RF energy in the head because the phone, which is the source of the RF emissions, will not be placed against the head. On the other hand, if the phone is mounted against the waist or other part of the body during use, then that part of the body will absorb more RF energy. Wireless phones marketed in the U.S. are required to meet safety requirements regardless of whether they are used against the head or against the body. Either configuration should result in compliance with the safety limit. "Also, if you use your wireless phone while in a car, you can use a phone with an antenna on the outside of the vehicle. You should also read and follow your wireless phone manufacturer's instructions for the safe operation of your phone.

Do wireless phones pose any special risks to children?

The FDA/FCC website states that "the scientific evidence does not show a danger to users of wireless communication devices, including children." The FDA/FCC website further states that "some groups sponsored by other national governments have advised that children be discouraged from using wireless phones at all". For example, the Stewart Report from the United Kingdom ["UK"] made such a recommendation in December 2000. In this report a group of independent experts noted that no evidence exists that using a cell phone causes brain tumors or other ill effects. [The UK's] recommendation to limit cell phone use by children was strictly precautionary; it was not based on scientific evidence that any health hazard exists. A copy of the UK's leaflet is available at <http://www.dh.gov.uk> (search "mobile"), or you can write to: NRPB, Chilton, Didcot, Oxon OX11 0RQ, United Kingdom. Copies of the UK's annual reports on mobile phones and RF are available online at www.iegmp.org.uk and <http://www.hpa.org.uk/radiation/> (search "mobile"). Parents who wish to reduce their children's RF exposure may choose to restrict their children's wireless phone use.

Where can I get further information about RF emissions?

For further information, see the following additional resources (websites current as of April 2005):

U.S. Food and Drug Administration

FDA Consumer magazine November-December 2000

Telephone: (888) INFO-FDA

<http://www.fda.gov> (Under "c" in the subject index, select Cell Phones > Research.)

U.S. Federal Communications Commission

445 12th Street, S.W. Washington, D.C. 20554

Telephone: (888) 225-5322

<http://www.fcc.gov/oet/rfsafety>

Independent Expert Group on Mobile Phones

<http://www.iegmp.org.uk>

Royal Society of Canada Expert Panels on Potential Health Risks of Radio Frequency Fields from Wireless Telecommunication Devices

283 Sparks Street Ottawa, Ontario K1R 7X9 Canada

Telephone: (613) 991-6990

http://www.rsc.ca/index.php?page=Expert_Panels_RF&Lang_id=120

World Health Organization

Avenue Appia 20 1211 Geneva 27 Switzerland

Telephone: 011 41 22 791 21 11

<http://www.who.int/mediacentre/factsheets/fs193/en/>

International Commission on Non-Ionizing Radiation Protection

c/o Bundesamt für Strahlenschutz

Ingolstaedter Landstr. 1

85764 Oberschleissheim Germany

Telephone: 011 49 1888 333 2156

<http://www.icnirp.de>

American National Standards Institute

1819 L Street, N.W., 6th Floor Washington, D.C. 20036

Telephone: (202) 293-8020

<http://www.ansi.org>

National Council on Radiation Protection and Measurements

7910 Woodmont Avenue, Suite 800

Bethesda, MD 20814-3095

Telephone: (301) 657-2652

<http://www.ncrponline.org>

Engineering in Medicine and Biology Society, Committee on Man and Radiation (COMAR) of the Institute of Electrical and Electronics Engineers

<http://ewh.ieee.org/soc/embs/comar/>

Consumer Information on SAR

(Specific Absorption Rate)

This model phone meets the government's requirements for exposure to radio waves. Your wireless phone is a radio transmitter and receiver. It is designed and manufactured not to exceed the emission limits for exposure to Radio Frequency (RF) energy set by the Federal Communications Commission of the U.S. Government. These limits are part of comprehensive guidelines and establish permitted levels of RF energy for the general population. The guidelines are based on standards that were developed by independent scientific organizations through periodic and thorough evaluation of scientific studies. The standards include a substantial safety margin designed to assure the safety of all persons, regardless of age and health. The exposure standard for wireless mobile phones employs a unit of measurement known as the Specific Absorption Rate, or SAR. The SAR limit set by the FCC is 1.6 W/kg. Tests for SAR are conducted using standard operating positions specified by the FCC with the phone transmitting at its highest certified power level in all tested frequency bands. Although SAR is determined at the highest certified power level, the actual SAR level of the phone while operating can be well below the maximum value. Because the phone is designed to operate at multiple power levels to use only the power required to reach the network, in general, the closer you are to a wireless base station antenna, the lower the power output. Before a phone

model is available for sale to the public, it must be tested and certified to the FCC that it does not exceed the limit established by the government-adopted requirement for safe exposure. The tests are performed in positions and locations (e.g., at the ear and worn on the body) as required by the FCC for each model.

While there may be differences between SAR levels of various phones and at various positions, they all meet the government requirement for safe exposure. The FCC has granted an Equipment Authorization for this model phone with all reported SAR levels evaluated as in compliance with the FCC RF emission guidelines. SAR information on this model phone is on file with the FCC and can be found under the Display Grant section of <http://www.fcc.gov/oet/ea/fccid> after searching on **FCC ID ZNFH830**.

Additional information on Specific Absorption Rates (SAR) can be found on the Cellular Telecommunications Industry Association (CTIA) website at <http://www.ctia.org/>.

* In the United States and Canada, the SAR limit for mobile phones used by the public is 1.6 watts/kg (W/kg) averaged over one gram of tissue. The standard incorporates a substantial margin of safety to give additional protection for the public and to account for any variations in measurements.

FCC Hearing-Aid Compatibility (HAC) Regulations for Wireless Devices

On July 10, 2003, the U.S. Federal Communications Commission (FCC) Report and Order in WT Docket 01-309 modified the exception of wireless phones under the Hearing Aid Compatibility Act of 1988 (HAC Act) to require digital wireless phones be compatible with hearing-aids. The intent of the HAC Act is to ensure reasonable access to telecommunications services for persons with hearing disabilities. While some wireless phones are used near some hearing devices (hearing aids and cochlear implants), users may detect a buzzing, humming, or whining noise. Some hearing devices are more immune than others to this interference noise, and phones also vary in the amount of interference they generate. The wireless telephone industry has developed a rating system for wireless phones, to assist hearing device users to find phones that may be compatible with their hearing devices. Not all phones have been rated. Phones that are rated have the rating on their box or a label located on the box. The ratings are not guarantees. Results will vary depending on the user's hearing device and hearing loss. If your hearing device happens to be vulnerable to interference, you may not be able to use a rated phone successfully. Trying out the phone with your hearing device is the best way to evaluate it for your personal needs.

M-Ratings: Phones rated M3 or M4 meet FCC requirements and are likely to generate less interference to hearing devices than phones that are not labeled. M4 is the better/higher of the two ratings.

T-Ratings: Phones rated T3 or T4 meet FCC requirements and are likely to generate less interference to hearing devices than phones that are not labeled. T4 is the better/higher of the two ratings.

Hearing devices may also be rated. Your hearing device manufacturer or hearing health professional may help you find this rating. Higher ratings mean that the hearing device is relatively immune to interference noise. The hearing aid and wireless phone rating values are then added together. A sum of 5 is considered acceptable for normal use. A sum of 6 is considered for best use.



In the above example, if a hearing aid meets the M2 level rating and the wireless phone meets the M3 level rating, the sum of the two values equal M5. This should provide the hearing aid user with “normal usage” while using their hearing aid with the particular wireless phone. “Normal usage” in this context is defined as a signal quality that’s acceptable for normal operation. The M mark is intended to be synonymous with the U mark. The T mark is intended to be synonymous with the UT mark. The M and T marks are recommended by the Alliance for Telecommunications Industries Solutions (ATIS). The U and UT marks are referenced in Section 20.19 of the FCC Rules. The HAC rating and measurement procedure are described in the American National Standards Institute (ANSI) C63.19 standard.

To ensure that the Hearing Aid Compatibility rating for your phone is maintained, secondary transmitters such as Bluetooth and WLAN components must be disabled during a call.

For information about hearing aids and digital wireless phones:

Wireless Phones and Hearing Aid Accessibility

<http://www.accesswireless.org/>

Gallaudet University, RERC

<http://tap.gallaudet.edu/Voice/>

FCC Hearing Aid Compatibility and Volume Control

<http://www.fcc.gov/cgb/dro/hearing.html>

The Hearing Aid Compatibility FCC Order

http://hraunfoss.fcc.gov/edocs_public/attachmatch/FCC-03-168A1.pdf

Hearing Loss Association of America [HLAA]

<http://hearingloss.org/content/telephones-and-mobile-devices>

Caution: Avoid potential hearing loss.

Prolonged exposure to loud sounds (including music) is the most common cause of preventable hearing loss. Some scientific research suggests that using portable audio devices, such as portable music players and cellular telephones, at high volume settings for long durations may lead to permanent noise-induced hearing loss. This includes the use of headphones (including headsets, earbuds and Bluetooth® or other wireless devices). Exposure to very loud sound has also been associated in some studies with tinnitus (a ringing in the ear), hypersensitivity to sound and distorted hearing. Individual susceptibility to noise-induced hearing loss and other potential hearing problems varies. The amount of sound produced by a portable audio device varies depending on the nature of the sound, the device, the device settings and the headphones. You should follow some commonsense recommendations when using any portable audio device:

- Set the volume in a quiet environment and select the lowest volume at which you can hear adequately.
- When using headphones, turn the volume down if you cannot hear the people speaking near you or if the person sitting next to you can hear what you are listening to.
- Do not turn the volume up to block out noisy surroundings. If you choose to listen to your portable device in a noisy environment, use noise-cancelling headphones to block out background environmental noise.
- Limit the amount of time you listen. As the volume increases, less time is required before your hearing could be affected.
- Avoid using headphones after exposure to extremely loud noises, such as rock concerts, that might cause temporary hearing loss. Temporary hearing loss might cause unsafe volumes to sound normal.
- Do not listen at any volume that causes you discomfort. If you experience ringing in your ears, hear muffled speech or experience any temporary hearing difficulty after listening to your portable audio device, discontinue use and consult your doctor.

TIA Safety Information

The following is the complete TIA Safety Information for wireless handheld phones.

Exposure to Radio Frequency Signal

Your wireless handheld portable phone is a low power radio transmitter and receiver. When ON, it receives and sends out Radio Frequency (RF) signals. In August, 1996, the Federal Communications Commissions (FCC) adopted RF exposure guidelines with safety levels for handheld wireless phones. Those guidelines are consistent with the safety standards previously set by both U.S. and international standards bodies:

ANSI C95.1 (1992) *

NCRP Report 86 (1986)

ICNIRP (1996)

* American National Standards Institute; National Council on Radiation Protection and Measurements; International Commission on Non-Ionizing Radiation Protection Those standards were based on comprehensive and periodic evaluations of the relevant scientific literature. For example, over 120 scientists, engineers, and physicians from universities, government health agencies, and industry reviewed the available body of research to develop the ANSI Standard (C95.1). The design of your phone complies with the FCC guidelines (and those standards).

Antenna Care

Use only the supplied or an approved replacement antenna. Unauthorized antennas, modifications, or attachments could damage the phone and may violate FCC regulations.

Tips on Efficient Operation

For your phone to operate most efficiently: Don't touch the antenna unnecessarily when the phone is in use. Contact with the antenna affects call quality and may cause the phone to operate at a higher power level than otherwise needed.

Electronic Devices

Most modern electronic equipment is shielded from RF signals. However, certain

electronic equipment may not be shielded against the RF signals from your wireless phone.

Pacemakers

The Health Industry Manufacturers Association recommends that a minimum separation of six (6) inches be maintained between a handheld wireless phone and a pacemaker to avoid potential interference with the pacemaker. These recommendations are consistent with the independent research by and recommendations of Wireless Technology Research. Persons with pacemakers:

- Should ALWAYS keep the phone more than six (6) inches from their pacemaker when the phone is turned ON;
- Should not carry the phone in a breast pocket;
- Should use the ear opposite the pacemaker to minimize the potential for interference;
- Should turn the phone OFF immediately if there is any reason to suspect that interference is taking place.

Hearing Aids

Some digital wireless phones may interfere with some hearing aids. In the event of such interference, you may want to consult your service provider (or call the customer service line to discuss alternatives).

Other Medical Devices

If you use any other personal medical device, consult the manufacturer of your device to determine if it is adequately shielded from external RF energy. Your physician may be able to assist you in obtaining this information.

Health Care Facilities

Turn your phone OFF in health care facilities when any regulations posted in these areas instruct you to do so. Hospitals or health care facilities may use equipment that could be sensitive to external RF energy.

Vehicles

RF signals may affect improperly installed or inadequately shielded electronic systems

in motor vehicles. Check with the manufacturer or its representative regarding your vehicle. You should also consult the manufacturer of any equipment that has been added to your vehicle.

Posted Facilities

Turn your phone OFF in any facility where posted notices so require.

Aircraft

FCC regulations prohibit using your phone while in the air. Switch OFF your phone before boarding an aircraft.

Blasting Areas

To avoid interfering with blasting operations, turn your phone OFF when in a “blasting area” or in areas posted: “Turn off two-way radio”. Obey all signs and instructions.

Potentially Explosive Atmosphere

Turn your phone OFF when in any area with a potentially explosive atmosphere and obey all signs and instructions. Sparks in such areas could cause an explosion or fire resulting in bodily injury or even death. Areas with a potentially explosive atmosphere are often, but not always marked clearly. Potential areas may include: fueling areas (such as gasoline stations); below deck on boats; fuel or chemical transfer or storage facilities; vehicles using liquefied petroleum gas (such as propane or butane); areas where the air contains chemicals or particles (such as grain, dust, or metal powders); and any other area where you would normally be advised to turn off your vehicle engine.

For Vehicles Equipped with an Air Bag

An air bag inflates with great force. DO NOT place objects, including either installed or portable wireless equipment, in the area over the air bag or in the air bag deployment area. If in-vehicle wireless equipment is improperly installed and the air bag inflates, serious injury could result.

Safety Information

Please read and observe the following information for safe and proper use of your phone and to prevent damage.

Caution

Violation of the instructions may cause minor or serious damage to the product.

- Do not disassemble or open crush, bend or deform, puncture or shred.
- Do not modify or remanufacture, attempt to insert foreign objects into the battery, immerse or expose to water or other liquids, expose to fire, explosion or other hazard.
- Only use the battery for the system for which it is specified.
- Only use the battery with a charging system that has been qualified with the system per CTIA Certification Requirements for Battery System Compliance to IEEE1725. Use of an unqualified battery or charger may present a risk of fire, explosion, leakage, or other hazard.
- Do not short circuit a battery or allow metallic conductive objects to contact battery terminals.
- Replace the battery only with another battery that has been qualified with the system per this standard, IEEE-Std-1725. Use of an unqualified battery may present a risk of fire, explosion, leakage or other hazard. Only authorized service providers shall replace battery (If the battery is non-user replaceable)
- Promptly dispose of used batteries in accordance with local regulations
- Battery usage by children should be supervised.
- Avoid dropping the phone or battery. If the phone or battery is dropped, especially on a hard surface, and the user suspects damage, take it to a service center for inspection.
- Improper battery use may result in a fire, explosion or other hazard.

Charger and Adapter Safety

- The charger and adapter are intended for indoor use only.
- Insert the battery pack charger vertically into the wall power socket.
- Only use the LG-approved battery charger. Otherwise, you may cause serious damage to your phone.
- Use the correct adapter for your phone when using the battery pack charger abroad.

Battery Information and Care

- Always unplug the charger from the wall socket after the phone is fully charged to save unnecessary power consumption of the charger.
- Please read the manual of proper installation and removal of the battery.
- Please read the manual of specified charger about charging method.
- Do not damage the power cord by bending, twisting, or heating. Do not use the plug if it is loose as it may cause electric shock or fire. Do not place any heavy items on the power cord. Do not allow the power cord to be crimped as it may cause electric shock or fire.
- Unplug the power cord prior to cleaning your phone, and clean the power plug pin when it's dirty. When using the power plug, ensure that it's firmly connected. If not, it may cause excessive heat or fire. If you put your phone in a pocket or bag without covering the receptacle of the phone (power plug pin), metallic articles (such as a coin, paperclip or pen) may short-circuit the phone. Always cover the receptacle when not in use.
- Recharge the battery after long periods of non-use to maximize battery life. Battery life will vary due to usage pattern and environmental conditions.
- Please use only an LG-approved charging accessory to charge your LG phone. Improper handling of the charging port, as well as the use of an incompatible charger, may cause damage to your phone and void the warranty.
- Charging temperature range is regulated between 32°F (0°C) and 113°F (45°C). Do not charge the battery out of recommended temperature range. Charging out of

- recommended range might cause the generating heat or serious damage of battery. And also, it might cause the deterioration of battery's characteristics and cycle life.
- Do not use or leave the battery under the blazing sun or in heated car by sunshine. The battery may generate heat, smoke or flame. And also, it might cause the deterioration of battery's characteristics or cycle life.
 - The battery pack has protection circuit to avoid the danger. Do not use nearby the place where generates static electricity more than 100V which gives damage to the protection circuit. If the protection circuit were broken, the battery would generate smoke, rupture or flame.
 - When the battery has rust, bad smell or something abnormal at first-time-using, do not use the equipment and go to bring the battery to the shop which it was bought.
 - In case younger children use the battery, their parents should teach them how to use batteries according to the manual with care.
 - If the skin or cloth is smeared with liquid from the battery, wash with fresh water. It may cause the skin inflammation. Remove and do not use the battery.
 - Do not handle the phone with wet hands while it is being charged. It may cause an electric shock or seriously damage your phone.
 - Do not place or answer calls while charging the phone as it may short-circuit the phone and/or cause electric shock or fire.
 - The charger and adapter are intended for indoor use only.
 - Insert the battery pack charger vertically into the wall power socket.
 - Only use the LG-approved battery charger. Otherwise, you may cause serious damage to your phone and risk of overheating, fire or explosion may occur.
 - Use the correct adapter for your phone when using the battery pack charger abroad.
 - Talking on your phone for a long period of time may reduce call quality due to heat generated during use.
 - Do not use harsh chemicals (such as alcohol, benzene, thinners, etc.) or detergents to clean your phone. This could cause a fire. Do not place or answer calls while charging

the phone as it may short-circuit the phone and/or cause electric shock or fire. Don't short-circuit the battery. Metallic articles such as a coin, paperclip or pen in your pocket or bag may short-circuit the + and – terminals of the battery (metal strips on the battery) upon moving. Short-circuit of the terminal may damage the battery and cause an explosion.

- Never use an unapproved battery since this could damage the phone and/or battery and could cause the battery to explode. Only use the batteries and chargers provided by LG. The warranty will not be applied to products provided by other suppliers. Only authorized personnel should service the phone and its accessories. Faulty installation or service may result in accidents and consequently invalidate the warranty.

Explosion, Shock, and Fire Hazards

- Do not put your phone in a place subject to excessive dust and keep the minimum required distance between the power cord and heat sources.
- Unplug the power cord prior to cleaning your phone, and clean the power plug pin when it's dirty.
- When using the power plug, ensure that it's firmly connected. If not, it may cause excessive heat or fire.
- If you put your phone in a pocket or bag without covering the receptacle of the phone (power plug pin), metallic articles (such as a coin, paperclip or pen) may short-circuit the phone and may cause an explosion. Always cover the receptacle when not in use.
- Don't short-circuit the battery. Metallic articles such as a coin, paperclip or pen in your pocket or bag or contact with sharp objects including animal bites may short-circuit the + and – terminals of the battery (metal strips on the battery) upon moving. Shortcircuit of the terminal may damage the battery and cause an explosion.

General Notice

- Using a damaged battery or placing a battery in your mouth or animal's mouth may cause serious injury including a fire or explosion.
- Do not place items containing magnetic components such as a credit card, phone card, bank book, or subway ticket near your phone. The magnetism of the phone may damage the data stored in the magnetic strip.
- Talking on your phone for a long period of time may reduce call quality due to heat generated during use.
- When the phone is not used for a long period time, store it in a safe place with the power cord unplugged.
- Using the phone in proximity to receiving equipment (i.e., TV or radio) may cause interference to the phone.
- Do not use the phone if the antenna is damaged. If a damaged antenna contacts skin, it may cause a slight burn. Please contact an LG Authorized Service Center to replace the damaged antenna.
- Do not immerse your phone in water, liquid, or expose to high humidity. If this happens, turn it off immediately and remove the battery. Immediately, take it to an LG Authorized Service Center.
- Do not paint your phone.
- The data saved in your phone might be deleted due to careless use, repair of the phone, or upgrade of the software. Please backup your important phone numbers. (Ringtones, text messages, voice messages, pictures, and videos could also be deleted.) The manufacturer is not liable for damage due to the loss of data.
- When you use the phone in public places, set the ringtone to vibration so you don't disturb others.
- Do not turn your phone on or off when putting it to your ear.
- Use accessories, such as earphones and headsets, with caution. Ensure that cables are tucked away safely and do not touch the antenna unnecessarily.

FDA Consumer Update



The U.S. Food and Drug Administration's Center for Devices and Radiological Health Consumer Update on Mobile Phones:

1. Do wireless phones pose a health hazard?

The available scientific evidence does not show that any health problems are associated with using wireless phones. There is no proof, however, that wireless phones are absolutely safe. Wireless phones emit low levels of Radio Frequency (RF) energy in the microwave range while being used. They also emit very low levels of RF when in standby mode. Whereas high levels of RF can produce health effects (by heating tissue), exposure to low level RF that does not produce heating effects causes no known adverse health effects. Many studies of low level RF exposures have not found any biological effects. Some studies have suggested that some biological effects may occur, but such findings have not been confirmed by additional research. In some cases, other researchers have had difficulty in reproducing those studies, or in determining the reasons for inconsistent results.

2. What is the FDA's role concerning the safety of wireless phones?

Under the law, the FDA does not review the safety of radiation-emitting consumer products such as wireless phones before they can be sold, as it does with new drugs or medical devices. However, the agency has authority to take action if wireless phones are shown to emit Radio Frequency (RF) energy at a level that is hazardous to the user. In such a case, the FDA could require the manufacturers of wireless phones to notify users of the health hazard and to repair, replace, or recall the phones so that the hazard no longer exists. Although the existing scientific data do not justify FDA regulatory actions, the FDA has urged the wireless phone industry to take a number of steps, including the following:

- Support needed research into possible biological effects of RF of the type emitted by wireless phones;
- Design wireless phones in a way that minimizes any RF exposure to the user that is not necessary for device function; and

- Cooperate in providing users of wireless phones with the best possible information on possible effects of wireless phone use on human health.

The FDA belongs to an interagency working group of the federal agencies that have responsibility for different aspects of RF safety to ensure coordinated efforts at the federal level. The following agencies belong to this working group:

- National Institute for Occupational Safety and Health
- Environmental Protection Agency
- Occupational Safety and Health Administration
- National Telecommunications and Information Administration

The National Institutes of Health participates in some interagency working group activities, as well. The FDA shares regulatory responsibilities for wireless phones with the Federal Communications Commission (FCC). All phones that are sold in the United States must comply with FCC safety guidelines that limit RF exposure.

The FCC relies on the FDA and other health agencies for safety questions about wireless phones.

The FCC also regulates the base stations that the wireless phone networks rely upon. While these base stations operate at higher power than do the wireless phones themselves, the RF exposures that people get from these base stations are typically thousands of times lower than those they can get from wireless phones. Base stations are thus not the subject of the safety questions discussed in this document.

3. What kinds of phones are the subject of this update?

The term “wireless phone” refers here to handheld wireless phones with built-in antennas, often called “cell”, “mobile”, or “PCS” phones. These types of wireless phones can expose the user to measurable Radio Frequency (RF) energy because of the short distance between the phone and the user’s head.

These RF exposures are limited by FCC safety guidelines that were developed with the advice of the FDA and other federal health and safety agencies. When the phone is located at greater distances from the user, the exposure to RF is drastically lower because a person’s RF exposure decreases rapidly with increasing distance from

the source. The so-called “cordless phones,” which have a base unit connected to the telephone wiring in a house, typically operate at far lower power levels, and thus produce RF exposures far below the FCC safety limits.

4. What are the results of the research done already?

The research done thus far has produced conflicting results, and many studies have suffered from flaws in their research methods. Animal experiments investigating the effects of Radio Frequency (RF) energy exposures characteristic of wireless phones have yielded conflicting results that often cannot be repeated in other laboratories. A few animal studies, however, have suggested that low levels of RF could accelerate the development of cancer in laboratory animals. However, many of the studies that showed increased tumor development used animals that had been genetically engineered or treated with cancer-causing chemicals so as to be pre-disposed to develop cancer in the absence of RF exposure. Other studies exposed the animals to RF for up to 22 hours per day. These conditions are not similar to the conditions under which people use wireless phones, so we do not know with certainty what the results of such studies mean for human health. Three large epidemiology studies have been published since December 2000. Between them, the studies investigated any possible association between the use of wireless phones and primary brain cancer, glioma, meningioma, or acoustic neuroma, tumors of the brain or salivary gland, leukemia, or other cancers. None of the studies demonstrated the existence of any harmful health effects from wireless phone RF exposures. However, none of the studies can answer questions about long-term exposures, since the average period of phone use in these studies was around three years.

5. What research is needed to decide whether RF exposure from wireless phones poses a health risk?

A combination of laboratory studies and epidemiological studies of people actually using wireless phones would provide some of the data that are needed. Lifetime animal exposure studies could be completed in a few years. However, very large numbers of animals would be needed to provide reliable proof of a cancer promoting effect if one

exists. Epidemiological studies can provide data that is directly applicable to human populations, but ten or more years follow-up may be needed to provide answers about some health effects, such as cancer. This is because the interval between the time of exposure to a cancer-causing agent and the time tumors develop — if they do — may be many, many years. The interpretation of epidemiological studies is hampered by difficulties in measuring actual RF exposure during day-to-day use of wireless phones. Many factors affect this measurement, such as the angle at which the phone is held, or which model of phone is used.

6. What is the FDA doing to find out more about the possible health effects of wireless phone RF?

The FDA is working with the U.S. National Toxicology Program and with groups of investigators around the world to ensure that high priority animal studies are conducted to address important questions about the effects of exposure to Radio Frequency (RF) energy. The FDA has been a leading participant in the World Health Organization International Electro Magnetic Fields (EMF) Project since its inception in 1996. An influential result of this work has been the development of a detailed agenda of research needs that has driven the establishment of new research programs around the world. The project has also helped develop a series of public information documents on EMF issues. The FDA and the Cellular Telecommunications & Internet Association (CTIA) have a formal Cooperative Research And Development Agreement (CRADA) to do research on wireless phone safety. The FDA provides the scientific oversight, obtaining input from experts in government, industry, and academic organizations. CTIA-funded research is conducted through contracts with independent investigators. The initial research will include both laboratory studies and studies of wireless phone users. The CRADA will also include a broad assessment of additional research needs in the context of the latest research developments around the world.

7. How can I find out how much Radio Frequency energy exposure I can get by using my wireless phone?

All phones sold in the United States must comply with Federal Communications

Commission (FCC) guidelines that limit Radio Frequency (RF) energy exposures. The FCC established these guidelines in consultation with the FDA and the other federal health and safety agencies. The FCC limit for RF exposure from wireless phones is set at a Specific Absorption Rate (SAR) of 1.6 watts per kilogram (1.6 W/kg). The FCC limit is consistent with the safety standards developed by the Institute of Electrical and Electronic Engineering (IEEE) and the National Council on Radiation Protection and Measurement. The exposure limit takes into consideration the body's ability to remove heat from the tissues that absorb energy from the wireless phone and is set well below levels known to have effects. Manufacturers of wireless phones must report the RF exposure level for each model of phone to the FCC. The FCC website (<http://www.fcc.gov/oet/rfsafety>) gives directions for locating the FCC identification number on your phone so you can find your phone's RF exposure level in the online listing.

8. What has the FDA done to measure the Radio Frequency energy coming from wireless phones?

The Institute of Electrical and Electronic Engineers (IEEE) is developing a technical standard for measuring the Radio Frequency (RF) energy exposure from wireless phones and other wireless handsets with the participation and leadership of FDA scientists and engineers. The standard, "Recommended Practice for Determining the Spatial-Peak Specific Absorption Rate (SAR) in the Human Body Due to Wireless Communications Devices: Experimental Techniques", sets forth the first consistent test methodology for measuring the rate at which RF is deposited in the heads of wireless phone users. The test method uses a tissue-simulating model of the human head. Standardized SAR test methodology is expected to greatly improve the consistency of measurements made at different laboratories on the same phone. SAR is the measurement of the amount of energy absorbed in tissue, either by the whole body or a small part of the body. It is measured in watts/kg (or milliwatts/g) of matter. This measurement is used to determine whether a wireless phone complies with safety guidelines.

9. What steps can I take to reduce my exposure to Radio Frequency energy from my wireless phone?

If there is a risk from these products — and at this point we do not know that there is — it is probably very small. But if you are concerned about avoiding even potential risks, you can take a few simple steps to minimize your exposure to Radio Frequency (RF) energy. Since time is a key factor in how much exposure a person receives, reducing the amount of time spent using a wireless phone will reduce RF exposure. If you must conduct extended conversations by wireless phone every day, you could place more distance between your body and the source of the RF, since the exposure level drops off dramatically with distance. For example, you could use a headset and carry the wireless phone away from your body or use a wireless phone connected to a remote antenna. Again, the scientific data does not demonstrate that wireless phones are harmful. But if you are concerned about the RF exposure from these products, you can use measures like those described above to reduce your RF exposure from wireless phone use.

10. What about children using wireless phones?

The scientific evidence does not show a danger to users of wireless phones, including children and teenagers. If you want to take steps to lower exposure to Radio Frequency (RF) energy, the measures described above would apply to children and teenagers using wireless phones. Reducing the time of wireless phone use and increasing the distance between the user and the RF source will reduce RF exposure. Some groups sponsored by other national governments have advised that children be discouraged from using wireless phones at all. For example, the government in the United Kingdom distributed leaflets containing such a recommendation in December 2000. They noted that no evidence exists that using a wireless phone causes brain tumors or other ill effects. Their recommendation to limit wireless phone use by children was strictly precautionary; it was not based on scientific evidence that any health hazard exists.

11. What about wireless phone interference with medical equipment?

Radio Frequency (RF) energy from wireless phones can interact with some electronic

devices. For this reason, the FDA helped develop a detailed test method to measure Electro Magnetic Interference (EMI) of implanted cardiac pacemakers and defibrillators from wireless telephones. This test method is now part of a standard sponsored by the Association for the Advancement of Medical Instrumentation (AAMI). The final draft, a joint effort by the FDA, medical device manufacturers, and many other groups, was completed in late 2000. This standard will allow manufacturers to ensure that cardiac pacemakers and defibrillators are safe from wireless phone EMI. The FDA has tested hearing aids for interference from handheld wireless phones and helped develop a voluntary standard sponsored by the Institute of Electrical and Electronic Engineers (IEEE). This standard specifies test methods and performance requirements for hearing aids and wireless phones so that no interference occurs when a person uses a “compatible” phone and a “compatible” hearing aid at the same time. This standard was approved by the IEEE in 2000.

The FDA continues to monitor the use of wireless phones for possible interactions with other medical devices. Should harmful interference be found to occur, the FDA will conduct testing to assess the interference and work to resolve the problem.

12. Where can I find additional information?

For additional information, please refer to the following resources: FDA web page on wireless phones (<http://www.fda.gov/cellphones/>) Federal Communications Commission (FCC) RF Safety Program (<http://www.fcc.gov/oet/rfsafety>) International Commission on Non-Ionizing Radiation Protection (<http://www.icnirp.de>) World Health Organization (WHO) International EMF Project (<http://www.who.int/emf>) National Radiological Protection Board (UK) (<http://www.hpa.org.uk/radiation/>)

Driving

Check the laws and regulations on the use of wireless phones in the areas where you drive and always obey them. Also, if using your phone while driving, please observe the following:

- Give full attention to driving – driving safely is your first responsibility;
- Use hands-free operation, if available;
- Pull off the road and park before making or answering a call if driving conditions or the law require it.

10 Driver Safety Tips

Your wireless phone gives you the powerful ability to communicate by voice almost anywhere, anytime. An important responsibility accompanies the benefits of wireless phones, one that every user must uphold. When operating a car, driving is your first responsibility. When using your wireless phone behind the wheel of a car, practice good common sense and remember the following tips:

- 1 Get to know your wireless phone and its features such as speed dial and redial. Carefully read your instruction manual and learn to take advantage of valuable features most phones offer, including automatic redial and memory. Also, work to memorize the phone keypad so you can use the speed dial function without taking your attention off the road.
- 2 When available, use a hands-free device. A number of hands-free wireless phone accessories are readily available today. Whether you choose an installed mounted device for your wireless phone or a speaker phone accessory, take advantage of these devices if available to you.
- 3 Make sure you place your wireless phone within easy reach and where you can reach it without removing your eyes from the road. If you get an incoming call at an inconvenient time, if possible, let your voicemail answer it for you.
- 4 Suspend conversations during hazardous driving conditions or situations. Let the person you are speaking with know you are driving; if necessary, suspend the call in heavy traffic or hazardous weather conditions. Rain, sleet, snow, and ice can be hazardous, but so is heavy traffic. As a driver, your first responsibility is to pay attention to the road.

- 5 Don't take notes or look up phone numbers while driving. If you are reading an address book or business card, or writing a "to-do" list while driving a car, you are not watching where you are going. It is common sense. Do not get caught in a dangerous situation because you are reading or writing and not paying attention to the road or nearby vehicles.
- 6 Dial sensibly and assess the traffic; if possible, place calls when you are not moving or before pulling into traffic. Try to plan your calls before you begin your trip or attempt to coincide your calls with times you may be stopped at a stop sign, red light, or otherwise stationary. But if you need to dial while driving, follow this simple tip – dial only a few numbers, check the road and your mirrors, then continue.
- 7 Do not engage in stressful or emotional conversations that may be distracting. Stressful or emotional conversations and driving do not mix; they are distracting and even dangerous when you are behind the wheel of a car. Make people you are talking with aware you are driving and if necessary, suspend conversations which have the potential to divert your attention from the road.
- 8 Use your wireless phone to call for help. Your wireless phone is one of the greatest tools you can own to protect yourself and your family in dangerous situations – with your phone at your side, help is only three numbers away. Dial 911 or other local emergency number in the case of fire, traffic accident, road hazard, or medical emergency. Remember, it's a free call on your wireless phone!
- 9 Use your wireless phone to help others in emergencies. Your wireless phone provides you a perfect opportunity to be a "Good Samaritan" in your community. If you see an auto accident, crime in progress or other serious emergency where lives are in danger, call 911 or other local emergency number, as you would want others to do for you.
- 10 Call roadside assistance or a special wireless nonemergency assistance number when necessary. Certain situations you encounter while driving may require attention, but are not urgent enough to merit a call for emergency services. But you can still use your wireless phone to lend a hand. If you see a broken-down vehicle

posing no serious hazard, a broken traffic signal, a minor traffic accident where no one appears injured or a vehicle you know to be stolen, call roadside assistance or other special nonemergency wireless number.

The above tips are meant as general guidelines. Before deciding to use your mobile device while operating a vehicle, it is recommended that you consult your applicable jurisdiction's local laws or other regulations regarding such use. Such laws or other regulations may prohibit or otherwise restrict the manner in which a driver may use his or her phone while operating a vehicle.

Precautions for use of leather back cover

- This product is made of cattle hide and may have different creases and patterns due to the properties of natural leather. If the product gets wet with any liquid (water, soda, seawater, rain, sweat, sunscreen, cosmetics, moisture, etc.), it may lose color, change color, or deform in shape.
- When this product gets wet or contaminated, get rid of the water by pressing it gently with a dry towel, or wipe it with leather cream and leave it to dry in shade. When the product is exposed to a wet environment for a long time, it may cause creases or mold. The shape of the leather may not be restored to its original state after cleaning because of the properties of leather, and any contamination or deformity may get worse when using regular detergent or an organic solvent.
- When the leather is wet with rain or sweat, use caution and avoid contact with clothes. It can cause any dye to become a stain.
- Due to the nature of leather, friction for long periods of time or excessive force may damage the surface of the leather.

NOTE: Some illustrations and the back cover type may differ from your device depending on the region, service provider without prior notice.

Laser Safety Statement

CDRH Compliance

THIS PRODUCT COMPLIES WITH APPLICABLE REQUIREMENT OF THE DHHS PERFORMANCE STANDARD FOR LASER PRODUCT, 21 CFR SUBCHAPTER J.

Caution!

This product employs a laser system. To ensure proper use of this product, please read this owner's manual carefully and retain for future reference. Should the unit require maintenance, contact an authorized service center.

Use of controls, adjustments, or the performance of procedures other than those specified herein may result in hazardous radiation exposure.

To prevent direct exposure to laser beam, do not try to open the enclosure or make direct contact with the laser.



CLASS 1	LASER PRODUCT
KLASSE 1	LASER PRODUKT
LUOKAN 1	LASER LAITE
KLASS 1	LASER APPARAT
CLASSE 1	PRODUIT LASER

Limited Warranty Statement

ARBITRATION NOTICE: THIS LIMITED WARRANTY CONTAINS AN ARBITRATION PROVISION THAT REQUIRES YOU AND LG TO RESOLVE DISPUTES BY BINDING ARBITRATION INSTEAD OF IN COURT, UNLESS YOU CHOOSE TO OPT OUT. IN ARBITRATION, CLASS ACTIONS AND JURY TRIALS ARE NOT PERMITTED. PLEASE SEE THE SECTION TITLED "PROCEDURE FOR RESOLVING DISPUTES" BELOW.

Warranty Laws

The following laws govern warranties that arise in retail sales of consumer goods:

- The California Song-Beverly Consumer Warranty Act [CC §§1790 et seq],
- The California Uniform Commercial Code, Division Two [Com C §§2101 et seq], and
- The federal Magnuson-Moss Warranty Federal Trade Commission Improvement Act [15 USC §§2301 et seq; 16 CFR Parts 701– 703]. A typical Magnuson-Moss Act warranty is a written promise that the product is free of defects or a written promise to refund, repair, or replace defective goods. [See 15 USC §2301(6).] Remedies include damages for failing to honor a written warranty or service contract or for violating disclosure provisions. [See 15 USC §2310(d).] Except for some labeling and disclosure requirements, the federal Act does not preempt state law. [See 15 USC §2311.]

1. WHAT THIS WARRANTY COVERS:

LG offers you a limited warranty that the enclosed subscriber unit and its enclosed accessories will be free from defects in material and workmanship, according to the following terms and conditions:

- (1) The limited warranty for the product extends for TWELVE (12) MONTHS beginning on the date of purchase of the product with valid proof of purchase, or absent valid proof of purchase, FIFTEEN (15) MONTHS from date of manufacture as determined by the unit's manufacture date code.
- (2) The limited warranty extends only to the original purchaser of the product and is not assignable or transferable to any subsequent purchaser/end user.
- (3) This warranty is good only to the original purchaser of the product during the warranty period as long as it is in the U.S., including Alaska, Hawaii, U.S. Territories and Canada.
- (4) The external housing and cosmetic parts shall be free of defects at the time of shipment and, therefore, shall not be covered under these limited warranty terms.
- (5) Upon request from LG, the consumer must provide information to reasonably prove the date of purchase.

(6) The customer shall bear the cost of shipping the product to the Customer Service Department of LG. LG shall bear the cost of shipping the product back to the consumer after the completion of service under this limited warranty.

2. WHAT THIS WARRANTY DOES NOT COVER:

- (1) Defects or damages resulting from use of the product in other than its normal and customary manner.
- (2) Defects or damages from abnormal use, abnormal conditions, improper storage, exposure to moisture or dampness, unauthorized modifications, unauthorized connections, unauthorized repair, misuse, neglect, abuse, accident, alteration, improper installation, or other acts which are not the fault of LG, including damage caused by shipping, blown fuses, spills of food or liquid.
- (3) Breakage or damage to antennas unless caused directly by defects in material or workmanship.
- (4) That the Customer Service Department at LG was not notified by consumer of the alleged defect or malfunction of the product during the applicable limited warranty period.
- (5) Products which have had the serial number removed or made illegible.
- (6) This limited warranty is in lieu of all other warranties, express or implied either in fact or by operations of law, statutory or otherwise, including, but not limited to any implied warranty of marketability or fitness for a particular use.
- (7) Damage resulting from use of non LG approved accessories.
- (8) All plastic surfaces and all other externally exposed parts that are scratched or damaged due to normal customer use.
- (9) Products operated outside published maximum ratings.
- (10) Products used or obtained in a rental program.
- (11) Consumables (such as fuses).

3. WHAT LG WILL DO:

LG will, at its sole option, either repair, replace or refund the purchase price of any

unit that is covered under this limited warranty. LG may choose at its option to use functionally equivalent re-conditioned, refurbished or new units or parts or any units. In addition, LG will not re-install or back-up any data, applications or software that you have added to your phone. It is therefore recommended that you back-up any such data or information prior to sending the unit to LG to avoid the permanent loss of such information.

4. STATE LAW RIGHTS:

No other express warranty is applicable to this product. THE DURATION OF ANY IMPLIED WARRANTIES, INCLUDING THE IMPLIED WARRANTY OF MARKETABILITY OR MERCHANTABILITY OR FITNESS FOR A PARTICULAR PURPOSE, IS LIMITED TO THE DURATION OF THE EXPRESS WARRANTY HEREIN. LG SHALL NOT BE LIABLE FOR THE LOSS OF THE USE OF THE PRODUCT, INCONVENIENCE, LOSS OR ANY OTHER DAMAGES, DIRECT OR CONSEQUENTIAL, ARISING OUT OF THE USE OF, OR INABILITY TO USE, THIS PRODUCT OR FOR ANY BREACH OF ANY EXPRESS OR IMPLIED WARRANTY, INCLUDING THE IMPLIED WARRANTY OF MARKETABILITY OR MERCHANTABILITY OR FITNESS FOR A PARTICULAR PURPOSE APPLICABLE TO THIS PRODUCT. Some states do not allow the exclusive limitation of incidental or consequential damages or limitations on how long an implied warranty lasts; so these limitations or exclusions may not apply to you. This warranty gives you specific legal rights and you may also have other rights which vary from state to state.

5. HOW TO GET WARRANTY SERVICE:

To obtain warranty service, please call or fax to the following telephone numbers from anywhere in the continental United States:

Tel. 1-800-793-8896 or Fax. 1-800-448-4026

Or visit <http://www.lg.com/us/support>. Correspondence may also be mailed to:

LG Electronics Service- Mobile Handsets, P.O. Box 240007, Huntsville, AL 35824

DO NOT RETURN YOUR PRODUCT TO THE ABOVE ADDRESS. Please call or write for the location of the LG authorized service center nearest you and for the procedures for obtaining warranty claims.

PROCEDURE FOR RESOLVING DISPUTES:

ALL DISPUTES BETWEEN YOU AND LG ARISING OUT OF OR RELATING IN ANY WAY TO THIS LIMITED WARRANTY OR THE PRODUCT SHALL BE RESOLVED EXCLUSIVELY THROUGH BINDING ARBITRATION, AND NOT IN A COURT OF GENERAL JURISDICTION. BINDING ARBITRATION MEANS THAT YOU AND LG ARE EACH WAIVING THE RIGHT TO A JURY TRIAL AND TO BRING OR PARTICIPATE IN A CLASS ACTION.

Definitions. For the purposes of this section, references to “LG” mean LG Electronics MobileComm U.S.A., Inc., its parents, subsidiaries and affiliates, and each of their officers, directors, employees, agents, beneficiaries, predecessors in interest, successors, assigns and suppliers; references to “dispute” or “claim” shall include any dispute, claim or controversy of any kind whatsoever (whether based in contract, tort, statute, regulation, ordinance, fraud, misrepresentation or any other legal or equitable theory) arising out of or relating in any way to the sale, condition or performance of the product or this Limited Warranty.

Agreement to Binding Arbitration and Class Action Waiver. You and LG agree to resolve any claims between us only by binding arbitration on an individual basis, unless you opt out as provided below. Any dispute between you and LG shall not be combined or consolidated with a dispute involving any other person’s or entity’s product or claim. More specifically, without limitation of the foregoing, any dispute between you and LG shall not under any circumstances proceed as part of a class or representative action. Instead of arbitration, either party may bring an individual action in small claims court, but that small claims court action may not be brought on a class or representative basis.

Arbitration Rules and Procedures. To begin arbitration of a claim, either you or LG must make a written demand for arbitration. The arbitration will be administered by the American Arbitration Association (AAA) and will be conducted before a single arbitrator under the AAA’s Consumer Arbitration Rules that are in effect at the time

the arbitration is initiated (referred to as the “AAA Rules”) and under the procedures set forth in this section. The AAA Rules are available online at www.adr.org/consumer. Send a copy of your written demand for arbitration, as well as a copy of this provision, to the AAA in the manner described in the AAA Rules. You must also send a copy of your written demand to LG at LG Electronics, USA, Inc. Attn: Legal Department-Arbitration 1000 Sylvan Avenue Englewood Cliffs, NJ 07632. If there is a conflict between the AAA Rules and the rules set forth in this section, the rules set forth in this section will govern. This arbitration provision is governed by the Federal Arbitration Act. Judgment may be entered on the arbitrator’s award in any court of competent jurisdiction. All issues are for the arbitrator to decide, except that issues relating to the scope and enforceability of the arbitration provision and to the arbitrability of the dispute are for the court to decide. The arbitrator is bound by the terms of this provision.

Governing Law: The law of the state of your residence shall govern this Limited Warranty and any disputes between us except to the extent that such law is preempted by or inconsistent with applicable federal law.

Fees/Costs. You do not need to pay any fee to begin an arbitration. Upon receipt of your written demand for arbitration, LG will promptly pay all arbitration filing fees to the AAA unless you seek more than \$25,000 in damages, in which case the payment of these fees will be governed by the AAA Rules. Except as otherwise provided for herein, LG will pay all AAA filing, administration and arbitrator fees for any arbitration initiated in accordance with the AAA Rules and this arbitration provision. If you prevail in the arbitration, LG will pay your reasonable attorneys’ fees and expenses to the extent required by applicable law. If the arbitrator finds either the substance of your claim or the relief sought in the demand is frivolous or brought for an improper purpose (as measured by the standards set forth in Federal Rule of Civil Procedure 11(b)), then the payment of all arbitration fees will be governed by the AAA Rules. In such a situation, you agree to reimburse LG for

all monies previously disbursed by it that are otherwise your obligation to pay under the AAA Rules. Except as otherwise provided for, LG waives any rights it may have to seek attorneys' fees and expenses from you if LG prevails in the arbitration.

Hearings and Location. If your claim is for \$25,000 or less, you may choose to have the arbitration conducted solely on the basis of (1) documents submitted to the arbitrator, (2) through a telephonic hearing, or (3) by an in-person hearing as established by the AAA Rules. If your claim exceeds \$25,000, the right to a hearing will be determined by the AAA Rules. Any in-person arbitration hearings will be held at a location within the federal judicial district in which you reside unless we both agree to another location or we agree to a telephonic arbitration.

Opt Out. You may opt out of this dispute resolution procedure. If you opt out, neither you nor LG can require the other to participate in an arbitration proceeding. To opt out, you must send notice to LG no later than 30 calendar days from the date of the first consumer purchaser's purchase of the product by either: (i) sending an e-mail to optout@lge.com, with the subject line: "Arbitration Opt Out" or (ii) calling 1-800-980-2973. You must include in the opt out e-mail or provide by telephone: (a) your name and address; (b) the date on which the product was purchased; (c) the product model name or model number; and (d) the IMEI or MEID or Serial Number, as applicable (the IMEI or MEID or Serial Number can be found (i) on the product box; (ii) on a label on the back of the product beneath the battery, if the battery is removable; or (iii) from the settings menu via the following path: Settings > General > About phone > Status). You may only opt out of the dispute resolution procedure in the manner described above (that is, by e-mail or telephone); no other form of notice will be effective to opt out of this dispute resolution procedure. Opting out of this dispute resolution procedure will not affect the coverage of the Limited Warranty in any way, and you will continue to enjoy the full benefits of the Limited Warranty. If you keep this product and do not opt out, then you accept all terms and conditions of the arbitration provision described above.

Regulatory information

To view regulatory marks and related information on your phone, go to **Settings General > Regulatory and Safety**.

