



PCTEST ENGINEERING LABORATORY, INC.

7185 Oakland Mills Road, Columbia, MD 21046 USA
Tel. +1.410.290.6652 / Fax +1.410.290.6654
http://www.pctestlab.com



SAR EVALUATION REPORT

Applicant Name:
LG Electronics MobileComm U.S.A., Inc.
1000 Sylvan Avenue
Englewood Cliffs, NJ 07632
United States

Date of Testing:
01/28/16 - 03/03/16
Test Site/Location:
PCTEST Lab, Columbia, MD, USA
Document Serial No.:
0Y1601290203-R5.ZNF

FCC ID: ZNFH820

APPLICANT: LG ELECTRONICS MOBILECOMM U.S.A., INC.

DUT Type: Portable Handset
Application Type: Certification
FCC Rule Part(s): CFR §2.1093
Model(s): LG-H820, LGH820, H820, LG-H831, LGH831, H831, LG-H820PR, LGH820PR, H820PR

Equipment Class	Band & Mode	Tx Frequency	SAR			
			1 gm Head (W/kg)	1 gm Body-Worn (W/kg)	1 gm Hotspot (W/kg)	10 gm Hotspot Mode 0 mm (W/kg)
PCE	GSM/GPRS/EDGE 850	824.20 - 848.80 MHz	0.75	1.03	1.08	0.42
PCE	UMTS 850	826.40 - 846.60 MHz	0.41	0.52	0.62	0.45
PCE	UMTS 1750	1712.4 - 1752.6 MHz	0.64	0.72	0.79	1.83
PCE	GSM/GPRS/EDGE 1900	1850.20 - 1909.80 MHz	0.25	0.31	0.30	0.30
PCE	UMTS 1900	1852.4 - 1907.6 MHz	0.63	1.07	1.07	0.89
PCE	LTE Band 12	699.7 - 715.3 MHz	0.23	0.51	0.51	0.43
PCE	LTE Band 17	706.5 - 713.5 MHz	N/A*	N/A*	N/A*	N/A*
PCE	LTE Band 5 (Cell)	824.7 - 848.3 MHz	0.38	0.51	0.54	0.44
PCE	LTE Band 4 (AWS)	1710.7 - 1754.3 MHz	0.76	1.12	1.12	2.34
PCE	LTE Band 2 (PCS)	1850.7 - 1909.3 MHz	0.82	1.03	1.06	0.83
PCE	LTE Band 30	2307.5 - 2312.5 MHz	0.16	0.32	0.46	1.01
PCE	LTE Band 7	2502.5 - 2567.5 MHz	0.23	0.57	0.57	1.30
DTS	2.4 GHz WLAN	2412 - 2462 MHz	1.02	0.14	0.14	N/A*
Nil	U-NII-1	5180 - 5240 MHz	N/A*	N/A*	N/A*	N/A*
Nil	U-NII-2A	5280 - 5320 MHz	0.54	< 0.1	N/A*	N/A*
Nil	U-NII-2C	5500 - 5720 MHz	0.69	< 0.1	N/A*	N/A*
Nil	U-NII-3	5745 - 5825 MHz	0.91	< 0.1	< 0.1	N/A*
DSS/DTS	Bluetooth	2402 - 2480 MHz	N/A	< 0.1	N/A*	N/A*
Simultaneous SAR per KDB 690783 D01v01r03:			1.56	1.25	1.25	N/A*

* Not all modes were required to be evaluated for SAR per FCC procedures. See Section 1.7 for details of SAR Test Exclusions.
Note: This revised Test Report (S/N: 0Y1601290203-R5.ZNF) supersedes and replaces the previously issued test report on the same subject device for the same type of testing as indicated. Please discard or destroy the previously issued test report(s) and dispose of it accordingly.

This wireless portable device has been shown to be capable of compliance for localized specific absorption rate (SAR) for uncontrolled environment/general population exposure limits specified in ANSI/IEEE C95.1-1992 and has been tested in accordance with the measurement procedures specified in Section 1.8 of this report; for North American frequency bands only.

I attest to the accuracy of data. All measurements reported herein were performed by me or were made under my supervision and are correct to the best of my knowledge and belief. I assume full responsibility for the completeness of these measurements and vouch for the qualifications of all persons taking them. Test results reported herein relate only to the item(s) tested.

The highest reported SAR values per equipment class and exposure condition are highlighted in the table above per KDB 865664 D02v01r02.

Randy Ortanez
President





The SAR Tick is an initiative of the Mobile Manufacturers Forum (MMF). While a product may be considered eligible, use of the SAR Tick logo requires an agreement with the MMF. Further details can be obtained by emailing: sartick@mmfai.info.

FCC ID: ZNFH820		SAR EVALUATION REPORT		Reviewed by: Quality Manager
Document S/N: 0Y1601290203-R5.ZNF	Test Dates: 01/28/16 - 03/03/16	DUT Type: Portable Handset	Page 1 of 82	

TABLE OF CONTENTS

1	DEVICE UNDER TEST	3
2	LTE INFORMATION	10
3	INTRODUCTION.....	11
4	DOSIMETRIC ASSESSMENT	12
5	DEFINITION OF REFERENCE POINTS	13
6	TEST CONFIGURATION POSITIONS	14
7	RF EXPOSURE LIMITS.....	18
8	FCC MEASUREMENT PROCEDURES	19
9	RF CONDUCTED POWERS	24
10	SYSTEM VERIFICATION	43
11	SAR DATA SUMMARY	48
12	FCC MULTI-TX AND ANTENNA SAR CONSIDERATIONS	69
13	SAR MEASUREMENT VARIABILITY	77
14	EQUIPMENT LIST	78
15	MEASUREMENT UNCERTAINTIES	79
16	CONCLUSION	80
17	REFERENCES.....	81
APPENDIX A:	SAR TEST PLOTS	
APPENDIX B:	SAR DIPOLE VERIFICATION PLOTS	
APPENDIX C:	PROBE AND DIPOLE CALIBRATION CERTIFICATES	
APPENDIX D:	SAR TISSUE SPECIFICATIONS	
APPENDIX E:	SAR SYSTEM VALIDATION	
APPENDIX F:	DUT ANTENNA DIAGRAM & SAR TEST SETUP PHOTOGRAPHS	
APPENDIX G:	SENSOR TRIGGERING DATA SUMMARY	

FCC ID: ZNFH820		SAR EVALUATION REPORT		Reviewed by: Quality Manager
Document S/N: 0Y1601290203-R5.ZNF	Test Dates: 01/28/16 - 03/03/16	DUT Type: Portable Handset	Page 2 of 82	



1 DEVICE UNDER TEST

1.1 Device Overview

Band & Mode	Operating Modes	Tx Frequency
GSM/GPRS/EDGE 850	Voice/Data	824.20 - 848.80 MHz
UMTS 850	Voice/Data	826.40 - 846.60 MHz
UMTS 1750	Voice/Data	1712.4 - 1752.6 MHz
GSM/GPRS/EDGE 1900	Voice/Data	1850.20 - 1909.80 MHz
UMTS 1900	Voice/Data	1852.4 - 1907.6 MHz
LTE Band 12	Voice/Data	699.7 - 715.3 MHz
LTE Band 17	Voice/Data	706.5 - 713.5 MHz
LTE Band 5 (Cell)	Voice/Data	824.7 - 848.3 MHz
LTE Band 4 (AWS)	Voice/Data	1710.7 - 1754.3 MHz
LTE Band 2 (PCS)	Voice/Data	1850.7 - 1909.3 MHz
LTE Band 30	Voice/Data	2307.5 - 2312.5 MHz
LTE Band 7	Voice/Data	2502.5 - 2567.5 MHz
2.4 GHz WLAN	Voice/Data	2412 - 2462 MHz
U-NII-1	Voice/Data	5180 - 5240 MHz
U-NII-2A	Voice/Data	5260 - 5320 MHz
U-NII-2C	Voice/Data	5500 - 5720 MHz
U-NII-3	Voice/Data	5745 - 5825 MHz
Bluetooth	Data	2402 - 2480 MHz
NFC	Data	13.56 MHz

1.2 Power Reduction for SAR

There is no power reduction used for any band/mode implemented in this device for SAR purposes.

FCC ID: ZNFH820		SAR EVALUATION REPORT		Reviewed by: Quality Manager
Document S/N: 0Y1601290203-R5.ZNF	Test Dates: 01/28/16 - 03/03/16	DUT Type: Portable Handset		Page 3 of 82



1.3 Nominal and Maximum Output Power Specifications

This device operates using the following maximum and nominal output power specifications. SAR values were scaled to the maximum allowed power to determine compliance per KDB Publication 447498 D01v06.

Mode / Band		Voice (dBm)	Burst Average GMSK (dBm)				Burst Average 8-PSK (dBm)			
		1 TX Slot	1 TX Slots	2 TX Slots	3 TX Slots	4 TX Slots	1 TX Slots	2 TX Slots	3 TX Slots	4 TX Slots
GSM/GPRS/EDGE 850	Maximum	33.2	33.2	31.7	29.7	27.7	27.2	27.2	26.7	25.7
	Nominal	32.7	32.7	31.2	29.2	27.2	26.7	26.7	26.2	25.2
GSM/GPRS/EDGE 1900	Maximum	30.7	30.7	28.7	26.7	25.7	26.2	26.2	25.7	24.7
	Nominal	30.2	30.2	28.2	26.2	25.2	25.7	25.7	25.2	24.2

Mode / Band		Modulated Average (dBm)			
		3GPP WCDMA	3GPP HSDPA	3GPP HSUPA	3GPP DC-HSDPA
UMTS Band 5 (850 MHz)	Maximum	24.2	24.2	24.2	24.2
	Nominal	23.7	23.7	23.7	23.7
UMTS Band 4 (1750 MHz)	Maximum	24.2	24.2	24.2	24.2
	Nominal	23.7	23.7	23.7	23.7
UMTS Band 2 (1900 MHz)	Maximum	24.7	24.7	24.7	24.7
	Nominal	24.2	24.2	24.2	24.2



Mode / Band		Modulated Average (dBm)
LTE Band 12	Maximum	24.7
	Nominal	24.2
LTE Band 17	Maximum	24.7
	Nominal	24.2
LTE Band 5 (Cell)	Maximum	24.2
	Nominal	23.7
LTE Band 4 (AWS)	Maximum	24.7
	Nominal	24.2
LTE Band 2 (PCS)	Maximum	24.7
	Nominal	24.2
LTE Band 30	Maximum	23.7
	Nominal	23.2
LTE Band 7	Maximum	24.7
	Nominal	24.2

FCC ID: ZNFH820		SAR EVALUATION REPORT		Reviewed by: Quality Manager
Document S/N: 0Y1601290203-R5.ZNF	Test Dates: 01/28/16 - 03/03/16	DUT Type: Portable Handset	Page 4 of 82	

Mode / Band		Modulated Average (dBm)		
		Ch. 1	Ch 2-10	Ch. 11
IEEE 802.11b (2.4 GHz)	Maximum	17.5	18.5	17.5
	Nominal	17.0	18.0	17.0
IEEE 802.11g (2.4 GHz)	Maximum	15.5	16.5	15.5
	Nominal	15.0	16.0	15.0
IEEE 802.11n (2.4 GHz)	Maximum	14.5	15.5	14.5
	Nominal	14.0	15.0	14.0
IEEE 802.11ac (2.4 GHz)	Maximum	14.5	15.5	14.5
	Nominal	14.0	15.0	14.0
Mode / Band		Modulated Average (dBm)		
Bluetooth	Maximum	8.9		
	Nominal	7.9		
Bluetooth LE (Peak)	Maximum	5.5		



Mode / Band		Modulated Average (dBm)									
		20 MHz Bandwidth				40 MHz Bandwidth			80 MHz Bandwidth		
		Ch. 36-48, 52-64	Ch. 100-116	Ch. 132-144	Ch. 149-165	N/A ¹			N/A ¹		
IEEE 802.11a (5 GHz)	Maximum	13.5	13.0	12.5	13.25	N/A ¹			N/A ¹		
	Nominal	12.5	12.0	11.5	12.25	N/A ¹			N/A ¹		
IEEE 802.11n (5 GHz)	Maximum	13.5	13.0	12.5	13.25	12.5	12.0	12.5	N/A ¹		
	Nominal	12.5	12.0	11.5	12.25	11.5	11.0	11.5	N/A ¹		
IEEE 802.11ac (5 GHz)	Maximum	13.5	13.0	12.5	13.25	12.5	12.0	12.5	11.5	12.5	12.0
	Nominal	12.5	12.0	11.5	12.25	11.5	11.0	11.5	10.5	11.5	11.0

1) Configuration not supported for indicated 802.11 mode and bandwidth.

FCC ID: ZNFH820		SAR EVALUATION REPORT		Reviewed by: Quality Manager
Document S/N: 0Y1601290203-R5.ZNF	Test Dates: 01/28/16 - 03/03/16	DUT Type: Portable Handset	Page 5 of 82	

1.4 DUT Antenna Locations

The overall dimensions of this device are > 9 x 5 cm. The overall diagonal dimension of the device is

FCC ID: ZNFH820		SAR EVALUATION REPORT		Reviewed by: Quality Manager
Document S/N: 0Y1601290203-R5.ZNF	Test Dates: 01/28/16 - 03/03/16	DUT Type: Portable Handset		Page 6 of 82

**Table 1-2
Simultaneous Transmission Scenarios**

No.	Capable Transmit Configuration	Head	Body-Worn Accessory	Wireless Router	Notes
1	GSM voice + 2.4 GHz Wl-Fi	Yes	Yes	N/A	
2	GSM voice + 5 GHz Wl-Fi	Yes	Yes	N/A	
3	GSM voice + 2.4 GHz Bluetooth	N/A	Yes	N/A	
4	UMTS + 2.4 GHz Wl-Fi	Yes	Yes	Yes	
5	UMTS + 5 GHz Wl-Fi	Yes	Yes	Yes	
6	UMTS + 2.4 GHz Bluetooth	N/A	Yes	N/A	
7	LTE + 2.4 GHz Wl-Fi	Yes	Yes	Yes	
8	LTE + 5 GHz Wl-Fi	Yes	Yes	Yes	
9	LTE + 2.4 GHz Bluetooth	N/A	Yes	N/A	
10	GPRS/EDGE + 2.4 GHz Wl-Fi	Yes*	Yes*	Yes	*-Pre-installed VOIP applications are considered.
11	GPRS/EDGE + 5 GHz Wl-Fi	Yes*	Yes*	Yes	*-Pre-installed VOIP applications are considered.
12	GPRS/EDGE + 2.4 GHz Bluetooth	N/A	Yes*	N/A	*-Pre-installed VOIP applications are considered.

- 2.4 GHz WLAN, 5 GHz WLAN, and 2.4 GHz Bluetooth share the same antenna path and cannot transmit simultaneously.
- All licensed modes share the same antenna path and cannot transmit simultaneously. Ant 2 and Ant 3 operate in a switched condition only and cannot transmit simultaneously.
- When the user utilizes multiple services in UMTS 3G mode it uses multi-Radio Access Bearer or multi-RAB. The power control is based on a physical control channel (Dedicated Physical Control Channel [DPCCH]) and power control will be adjusted to meet the needs of both services. Therefore, the UMTS+WLAN scenario also represents the UMTS Voice/DATA + WLAN Hotspot scenario.
- Per the manufacturer, WIFI Direct is expected to be used in conjunction with a held-to-ear or body-worn accessory voice call.
- 5 GHz Wireless Router is only supported for the U-NII-3 by S/W, therefore U-NII-1, U-NII2A, and U-NII2C were not evaluated for wireless router conditions.
- This device supports VoLTE.
- This device supports VoWIFI

1.7 Miscellaneous SAR Test Considerations

(A) WIFI/BT



Since Wireless Router operations are not allowed by the chipset firmware using U-NII-1, U-NII-2A & U-NII-2C WIFI, only 2.4 GHz and U-NII-3 WIFI Hotspot SAR tests and combinations are considered for SAR with respect to Wireless Router configurations according to FCC KDB 941225 D06v02r01.

Since U-NII-1 and U-NII-2A bands have the same maximum output power and the highest reported SAR for U-NII-2A is less than 1.2 W/kg for 1g SAR, SAR is not required for U-NII-1 band according to FCC KDB 248227 D01v02r01.

BT/WLAN SAR testing was not required for 10g Hotspot SAR at 0 mm per FCC Guidance. Therefore, no further analysis was required to determine that possible simultaneous scenarios for 10g Hotspot SAR would not exceed the SAR limit.

This device supports IEEE 802.11ac with the following features:

- Up to 80 MHz Bandwidth only
- No aggregate channel configurations
- 1 Tx antenna output
- 256 QAM is supported
- Band gap channels are supported

FCC ID: ZNFH820		SAR EVALUATION REPORT		Reviewed by: Quality Manager
Document S/N: 0Y1601290203-R5.ZNF	Test Dates: 01/28/16 - 03/03/16	DUT Type: Portable Handset		Page 7 of 82

(B) Licensed Transmitter(s)

GSM/GPRS/EDGE DTM is not supported for US bands. Therefore, the GSM Voice modes in this report do not transmit simultaneously with GPRS/EDGE Data.

This device is only capable of QPSK HSUPA in the uplink. Therefore, no additional SAR tests are required beyond that described for devices with HSUPA in KDB 941225 D01v03r01.

This device supports both LTE Band 12 and LTE Band 17. Since the supported frequency span for LTE Band 17 falls completely within the supported frequency span for LTE Band 12, both LTE bands have the same target power, and both LTE bands share the same transmission path, SAR was only assessed for LTE Band 12.

LTE SAR for the higher modulations and lower bandwidths were not tested since the maximum average output power of all required channels and configurations was not more than 0.5 dB higher than the highest bandwidth; and the reported LTE SAR for the highest bandwidth was less than 1.45 W/kg for all configurations according to FCC KDB 941225 D05v02r04.

This device supports LTE Carrier Aggregation (CA) in the downlink only. All uplink communications are identical to Release 8 specifications. Per FCC KDB Publication 941225 D05A v01r02, SAR for LTE CA operations was not needed since the maximum average output power in LTE CA mode was not >0.25 dB higher than the maximum output power when downlink carrier aggregation was inactive.



1.8 Guidance Applied

- IEEE 1528-2013
- FCC KDB Publication 941225 D01v03r01, D05v02r04, D05Av01r02, D06v02r01 (2G/3G/4G and Hotspot)
- FCC KDB Publication 248227 D01v02r02 (SAR Considerations for 802.11 Devices)
- FCC KDB Publication 447498 D01v06 (General SAR Guidance)
- FCC KDB Publication 865664 D01v01r04, D02v01r02 (SAR Measurements up to 6 GHz)
- October 2013 TCB Workshop Notes (GPRS Testing Considerations)
- FCC Guidance (SAR Testing for Camera Module Accessory)
- FCC Guidance (SAR Testing for Transmit Diversity Configurations)

1.9 Device Accessory Testing Considerations

1.9.1 Camera Module (CM) Accessory

This device supports an optional camera module (CM) accessory (Model: CBG-720) that replaces the bottom part of the device below the screen. Only the standard battery can be used with either the standard device configuration or with the camera module accessory. SAR tests with the accessory were additionally performed for all exposure conditions for the antennas located at the bottom of the device. Per FCC guidance, the back side with the camera module accessory was additionally evaluated for 10g SAR for each band and mode at 0mm. With the camera module accessory attached, the diagonal dimension of the device is 161.8 mm. Based on guidance from the FCC, phablet testing procedures were not applied to this device. The operational description contains additional information.

FCC ID: ZNFH820		SAR EVALUATION REPORT		Reviewed by: Quality Manager
Document S/N: 0Y1601290203-R5.ZNF	Test Dates: 01/28/16 - 03/03/16	DUT Type: Portable Handset		Page 8 of 82



1.9.2 Transmit Diversity Implementation

This device supports transmit diversity for LTE B2/4 and UMTS B2/4 from Antenna 3 (a diagram showing the location of the device antennas can be found in Appendix F). When the device is held-to-ear, transmission from the diversity antenna is always permanently disabled via a proximity sensor mechanism. The transmission from Antenna 3 is disabled for all held-to-ear voice and VOIP data calls (including VOLTE). A summary of the sensor triggering data is included in Appendix G. Per FCC guidance, held-to-ear SAR for the diversity antenna was not required. Section 11 of the SAR Report contains full test data for body-worn and hotspot configurations.

1.10 Device Serial Numbers



Several samples with identical hardware were used to support SAR testing. The manufacturer has confirmed that the device(s) tested have the same physical, mechanical and thermal characteristics and are within operational tolerances expected for production units.

	Head Serial Number	Body-Worn Serial Number	Hotspot Serial Number	10g Hotspot Mode at 0mm Serial Number
GSM/GPRS/EDGE 850	08129	08103	08103	08103
UMTS 850	08129	08103	08103	08103
UMTS 1750 Ant 2	08103	08103	08103	08103
UMTS 1750 Ant 3	-	08079	08079	-
GSM/GPRS/EDGE 1900	08129	08103	08103	08103
UMTS 1900 Ant 2	08129	08103	08103	08103
UMTS 1900 Ant 3	-	08046	08046	-
LTE Band 12	08038	08038	08038	08038
LTE Band 5 (Cell)	08038	08137	08137	08137
LTE Band 4 (AWS) Ant 2	08038	08137	08137	08137
LTE Band 4 (AWS) Ant 3	-	08046	08046	-
LTE Band 2 (PCS) Ant 2	08137	08137	08137	08137
LTE Band 2 (PCS) Ant 3	-	08046	08046	-
LTE Band 30	08038	08038	08038	08038
LTE Band 7	08137	08137	08137	08137
2.4 GHz WLAN	08202	08202	08202	-
5 GHz WLAN	08202	08210	08210	-
Bluetooth	-	08202	-	-

FCC ID: ZNFH820		SAR EVALUATION REPORT		Reviewed by: Quality Manager
Document S/N: 0Y1601290203-R5.ZNF	Test Dates: 01/28/16 - 03/03/16	DUT Type: Portable Handset		Page 9 of 82

2 LTE INFORMATION

LTE Information			
FCC ID	ZNFH820		
Form Factor	Portable Handset		
Frequency Range of each LTE transmission band	LTE Band 12 (699.7 - 715.3 MHz)		
	LTE Band 17 (706.5 - 713.5 MHz)		
	LTE Band 5 (Cell) (824.7 - 848.3 MHz)		
	LTE Band 4 (AWS) (1710.7 - 1754.3 MHz)		
	LTE Band 2 (PCS) (1850.7 - 1909.3 MHz)		
	LTE Band 30 (2307.5 - 2312.5 MHz)		
	LTE Band 7 (2502.5 - 2567.5 MHz)		
Channel Bandwidths	LTE Band 12: 1.4 MHz, 3 MHz, 5 MHz, 10 MHz		
	LTE Band 17: 5 MHz, 10 MHz		
	LTE Band 5 (Cell): 1.4 MHz, 3 MHz, 5 MHz, 10 MHz		
	LTE Band 4 (AWS): 1.4 MHz, 3 MHz, 5 MHz, 10 MHz, 15 MHz, 20 MHz		
	LTE Band 2 (PCS): 1.4 MHz, 3 MHz, 5 MHz, 10 MHz, 15 MHz, 20 MHz		
	LTE Band 30: 5 MHz, 10 MHz		
	LTE Band 7: 5 MHz, 10 MHz, 15 MHz, 20 MHz		
Channel Numbers and Frequencies (MHz)	Low	Mid	High
LTE Band 12: 1.4 MHz	699.7 (23017)	707.5 (23095)	715.3 (23173)
LTE Band 12: 3 MHz	700.5 (23025)	707.5 (23095)	714.5 (23165)
LTE Band 12: 5 MHz	701.5 (23035)	707.5 (23095)	713.5 (23155)
LTE Band 12: 10 MHz	704 (23060)	707.5 (23095)	711 (23130)
LTE Band 17: 5 MHz	706.5 (23755)	710 (23790)	713.5 (23825)
LTE Band 17: 10 MHz	709 (23780)	710 (23790)	711 (23800)
LTE Band 5 (Cell): 1.4 MHz	824.7 (20407)	836.5 (20525)	848.3 (20643)
LTE Band 5 (Cell): 3 MHz	825.5 (20415)	836.5 (20525)	847.5 (20635)
LTE Band 5 (Cell): 5 MHz	826.5 (20425)	836.5 (20525)	846.5 (20625)
LTE Band 5 (Cell): 10 MHz	829 (20450)	836.5 (20525)	844 (20600)
LTE Band 4 (AWS): 1.4 MHz	1710.7 (19957)	1732.5 (20175)	1754.3 (20393)
LTE Band 4 (AWS): 3 MHz	1711.5 (19965)	1732.5 (20175)	1753.5 (20385)
LTE Band 4 (AWS): 5 MHz	1712.5 (19975)	1732.5 (20175)	1752.5 (20375)
LTE Band 4 (AWS): 10 MHz	1715 (20000)	1732.5 (20175)	1750 (20350)
LTE Band 4 (AWS): 15 MHz	1717.5 (20025)	1732.5 (20175)	1747.5 (20325)
LTE Band 4 (AWS): 20 MHz	1720 (20050)	1732.5 (20175)	1745 (20300)
LTE Band 2 (PCS): 1.4 MHz	1850.7 (18607)	1880 (18900)	1909.3 (19193)
LTE Band 2 (PCS): 3 MHz	1851.5 (18615)	1880 (18900)	1908.5 (19185)
LTE Band 2 (PCS): 5 MHz	1852.5 (18625)	1880 (18900)	1907.5 (19175)
LTE Band 2 (PCS): 10 MHz	1855 (18650)	1880 (18900)	1905 (19150)
LTE Band 2 (PCS): 15 MHz	1857.5 (18675)	1880 (18900)	1902.5 (19125)
LTE Band 2 (PCS): 20 MHz	1860 (18700)	1880 (18900)	1900 (19100)
LTE Band 30: 5 MHz	2307.5 (27685)	2310 (27710)	2312.5 (27735)
LTE Band 30: 10 MHz	N/A	2310 (27710)	N/A
LTE Band 7: 5 MHz	2502.5 (20775)	2535 (21100)	2567.5 (21425)
LTE Band 7: 10 MHz	2505 (20800)	2535 (21100)	2565 (21400)
LTE Band 7: 15 MHz	2507.5 (20825)	2535 (21100)	2562.5 (21375)
LTE Band 7: 20 MHz	2510 (20850)	2535 (21100)	2560 (21350)
UE Category	6		
Modulations Supported in UL	QPSK, 16QAM		
LTE MPR Permanently implemented per 3GPP TS 36.101 section 6.2.3~6.2.5? (manufacturer attestation to be provided)	YES		
A-MPR (Additional MPR) disabled for SAR Testing?	YES		
LTE Carrier Aggregation Possible Combinations	The technical description includes all the possible carrier aggregation combinations		
LTE Release 10 Additional Information	This device does not support full CA features on 3GPP Release 10. It supports a maximum of 2 carriers in the downlink. All uplink communications are identical to the Release 8 Specifications. Uplink communications are done on the PCC. The following LTE Release 10 Features are not supported: Relay, HetNet, Enhanced MIMO, eICI, WIFI Offloading, MDH, eMBMA, Cross-Carrier Scheduling, Enhanced SC-FDMA.		

FCC ID: ZNFH820		SAR EVALUATION REPORT		Reviewed by: Quality Manager
Document S/N: 0Y1601290203-R5.ZNF	Test Dates: 01/28/16 - 03/03/16	DUT Type: Portable Handset		Page 10 of 82

3 INTRODUCTION

The FCC and Industry Canada have adopted the guidelines for evaluating the environmental effects of radio frequency (RF) radiation in ET Docket 93-62 on Aug. 6, 1996 and Health Canada Safety Code 6 to protect the public and workers from the potential hazards of RF emissions due to FCC-regulated portable devices. [1]

The safety limits used for the environmental evaluation measurements are based on the criteria published by the American National Standards Institute (ANSI) for localized specific absorption rate (SAR) in IEEE/ANSI C95.1-1992 Standard for Safety Levels with Respect to Human Exposure to Radio Frequency Electromagnetic Fields, 3 kHz to 300 GHz [3] and Health Canada RF Exposure Guidelines Safety Code 6 [22]. The measurement procedure described in IEEE/ANSI C95.3-2002 Recommended Practice for the Measurement of Potentially Hazardous Electromagnetic Fields - RF and Microwave [4] is used for guidance in measuring the Specific Absorption Rate (SAR) due to the RF radiation exposure from the Equipment Under Test (EUT). These criteria for SAR evaluation are similar to those recommended by the International Committee for Non-Ionizing Radiation Protection (ICNIRP) in Biological Effects and Exposure Criteria for Radiofrequency Electromagnetic Fields,” Report No. Vol 74. SAR is a measure of the rate of energy absorption due to exposure to an RF transmitting source. SAR values have been related to threshold levels for potential biological hazards.

3.1 SAR Definition

Specific Absorption Rate is defined as the time derivative (rate) of the incremental energy (dU) absorbed by (dissipated in) an incremental mass (dm) contained in a volume element (dV) of a given density (ρ). It is also defined as the rate of RF energy absorption per unit mass at a point in an absorbing body (see Equation 3-1).

Equation 3-1
SAR Mathematical Equation

$$SAR = \frac{d}{dt} \left(\frac{dU}{dm} \right) = \frac{d}{dt} \left(\frac{dU}{\rho dv} \right)$$



SAR is expressed in units of Watts per Kilogram (W/kg).

$$SAR = \frac{\sigma \cdot E^2}{\rho}$$

where:

- σ = conductivity of the tissue-simulating material (S/m)
- ρ = mass density of the tissue-simulating material (kg/m³)
- E = Total RMS electric field strength (V/m)

NOTE: The primary factors that control rate of energy absorption were found to be the wavelength of the incident field in relation to the dimensions and geometry of the irradiated organism, the orientation of the organism in relation to the polarity of field vectors, the presence of reflecting surfaces, and whether conductive contact is made by the organism with a ground plane.[6]

FCC ID: ZNFH820		SAR EVALUATION REPORT		Reviewed by: Quality Manager
Document S/N: 0Y1601290203-R5.ZNF	Test Dates: 01/28/16 - 03/03/16	DUT Type: Portable Handset	Page 11 of 82	

4 DOSIMETRIC ASSESSMENT

4.1 Measurement Procedure

The evaluation was performed using the following procedure compliant to FCC KDB Publication 865664 D01v01r04 and IEEE 1528-2013:

1. The SAR distribution at the exposed side of the head or body was measured at a distance no greater than 5.0 mm from the inner surface of the shell. The area covered the entire dimension of the device-head and body interface and the horizontal grid resolution was determined per FCC KDB Publication 865664 D01v01r04 (See Table 4-1) and IEEE 1528-2013.
2. The point SAR measurement was taken at the maximum SAR region determined from Step 1 to enable the monitoring of SAR fluctuations/drifts during the 1g/10g cube evaluation. SAR at this fixed point was measured and used as a reference value.
3. Based on the area scan data, the peak of the region with maximum SAR was determined by spline interpolation. Around this point, a volume was assessed according to the measurement resolution and volume size requirements of FCC KDB Publication 865664 D01v01r04 (See Table 4-1) and IEEE 1528-2013. On the basis of this data set, the spatial peak SAR value was evaluated with the following procedure (see references or the DASY manual online for more details):
 - a. SAR values at the inner surface of the phantom are extrapolated from the measured values along the line away from the surface with spacing no greater than that in Table 4-1. The extrapolation was based on a least-squares algorithm. A polynomial of the fourth order was calculated through the points in the z-axis (normal to the phantom shell).
 - b. After the maximum interpolated values were calculated between the points in the cube, the SAR was averaged over the spatial volume (1g or 10g) using a 3D-Spline interpolation algorithm. The 3D-spline is composed of three one-dimensional splines with the “Not a knot” condition (in x, y, and z directions). The volume was then integrated with the trapezoidal algorithm. One thousand points (10 x 10 x 10) were obtained through interpolation, in order to calculate the averaged SAR.
 - c. All neighboring volumes were evaluated until no neighboring volume with a higher average value was found.
4. The SAR reference value, at the same location as step 2, was re-measured after the zoom scan was complete to calculate the SAR drift. If the drift deviated by more than 5%, the SAR test and drift measurements were repeated.

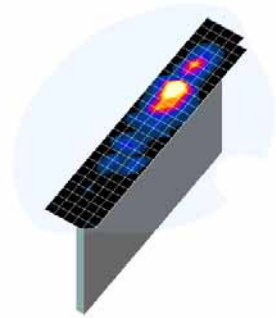



Figure 4-1
Sample SAR Area
Scan

Table 4-1
Area and Zoom Scan Resolutions per FCC KDB Publication 865664 D01v01r04*

Frequency	Maximum Area Scan Resolution (mm) ($\Delta x_{area}, \Delta y_{area}$)	Maximum Zoom Scan Resolution (mm) ($\Delta x_{zoom}, \Delta y_{zoom}$)	Maximum Zoom Scan Spatial Resolution (mm)			Minimum Zoom Scan Volume (mm) (x, y, z)
			Uniform Grid		Graded Grid	
			$\Delta z_{zoom}(n)$	$\Delta z_{zoom}(1)^*$		
≤ 2 GHz	≤ 15	≤ 8	≤ 5	≤ 4	≤ 1.5* $\Delta z_{zoom}(n-1)$	≥ 30
2-3 GHz	≤ 12	≤ 5	≤ 5	≤ 4	≤ 1.5* $\Delta z_{zoom}(n-1)$	≥ 30
3-4 GHz	≤ 12	≤ 5	≤ 4	≤ 3	≤ 1.5* $\Delta z_{zoom}(n-1)$	≥ 28
4-5 GHz	≤ 10	≤ 4	≤ 3	≤ 2.5	≤ 1.5* $\Delta z_{zoom}(n-1)$	≥ 25
5-6 GHz	≤ 10	≤ 4	≤ 2	≤ 2	≤ 1.5* $\Delta z_{zoom}(n-1)$	≥ 22

*Also compliant to IEEE 1528-2013 Table 6

FCC ID: ZNFH820		SAR EVALUATION REPORT		Reviewed by: Quality Manager
Document S/N: 0Y1601290203-R5_ZNF	Test Dates: 01/28/16 - 03/03/16	DUT Type: Portable Handset	Page 12 of 82	

5 DEFINITION OF REFERENCE POINTS

5.1 EAR REFERENCE POINT

Figure 5-2 shows the front, back and side views of the SAM Twin Phantom. The point “M” is the reference point for the center of the mouth, “LE” is the left ear reference point (ERP), and “RE” is the right ERP. The ERP is 15mm posterior to the entrance to the ear canal (EEC) along the B-M line (Back-Mouth), as shown in Figure 5-1. The plane passing through the two ear canals and M is defined as the Reference Plane. The line N-F (Neck-Front), also called the Reference Pivoting Line, is not perpendicular to the reference plane (see Figure 5-1). Line B-M is perpendicular to the N-F line. Both N-F and B-M lines are marked on the external phantom shell to facilitate handset positioning [5].

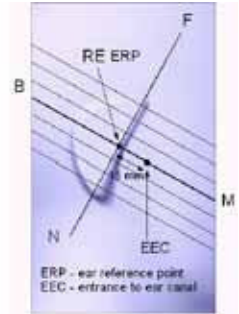

Figure 5-1
Close-Up Side view of ERP

5.2 HANDSET REFERENCE POINTS

Two imaginary lines on the handset were established: the vertical centerline and the horizontal line. The test device was placed in a normal operating position with the acoustic output located along the “vertical centerline” on the front of the device aligned to the “ear reference point” (See Figure 5-3). The acoustic output was then located at the same level as the center of the ear reference point. The test device was positioned so that the “vertical centerline” was bisecting the front surface of the handset at its top and bottom edges, positioning the “ear reference point” on the outer surface of the both the left and right head phantoms on the ear reference point.



Figure 5-2
Front, back and side view of SAM Twin Phantom

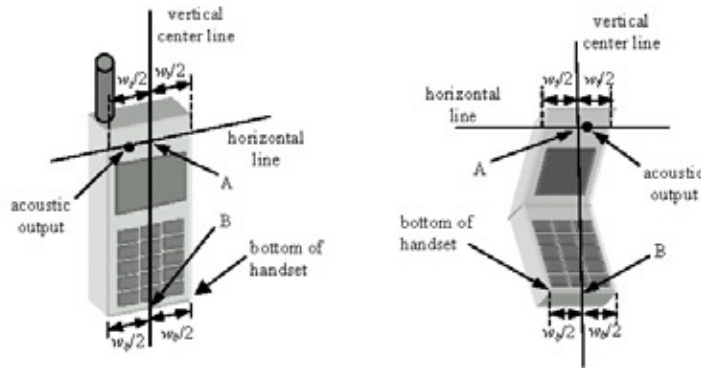



Figure 5-3
Handset Vertical Center & Horizontal Line Reference Points

FCC ID: ZNFH820		SAR EVALUATION REPORT		Reviewed by: Quality Manager
Document S/N: 0Y1601290203-R5.ZNF	Test Dates: 01/28/16 - 03/03/16	DUT Type: Portable Handset		Page 13 of 82

6 TEST CONFIGURATION POSITIONS

6.1 Device Holder

The device holder is made out of low-loss POM material having the following dielectric parameters: relative permittivity $\epsilon = 3$ and loss tangent $\delta = 0.02$.

6.2 Positioning for Cheek

1. The test device was positioned with the device close to the surface of the phantom such that point A is on the (virtual) extension of the line passing through points RE and LE on the phantom (see Figure 6-1), such that the plane defined by the vertical center line and the horizontal line of the phone is approximately parallel to the sagittal plane of the phantom.

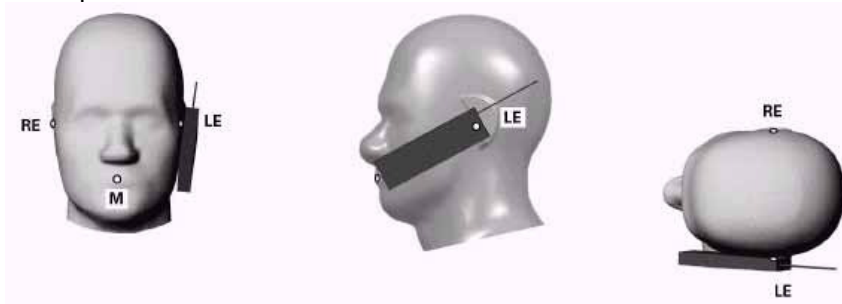

Figure 6-1 Front, Side and Top View of Cheek Position

2. The handset was translated towards the phantom along the line passing through RE & LE until the handset touches the pinna.
3. While maintaining the handset in this plane, the handset was rotated around the LE-RE line until the vertical centerline was in the reference plane.
4. The phone was then rotated around the vertical centerline until the phone (horizontal line) was symmetrical with respect to the line NF.
5. While maintaining the vertical centerline in the reference plane, keeping point A on the line passing through RE and LE, and maintaining the device contact with the ear, the device was rotated about the NF line until any point on the handset made contact with a phantom point below the ear (cheek) (See Figure 6-2).

6.3 Positioning for Ear / 15° Tilt

With the test device aligned in the “Cheek Position”:

1. While maintaining the orientation of the phone, the phone was retracted parallel to the reference plane far enough to enable a rotation of the phone by 15 degrees.
2. The phone was then rotated around the horizontal line by 15 degrees.
3. While maintaining the orientation of the phone, the phone was moved parallel to the reference plane until any part of the handset touched the head. (In this position, point A was located on the line RE-LE). The tilted position is obtained when the contact is on the pinna. If the contact was at any location other than the pinna, the angle of the phone would then be reduced. In this situation, the tilted position was obtained when any part of the phone was in contact of the ear as well as a second part of the phone was in contact with the head (see Figure 6-2).



FCC ID: ZNFH820		SAR EVALUATION REPORT		Reviewed by: Quality Manager
Document S/N: 0Y1601290203-R5.ZNF	Test Dates: 01/28/16 - 03/03/16	DUT Type: Portable Handset		Page 14 of 82



Figure 6-2 Front, Side and Top View of Ear/15° Tilt Position

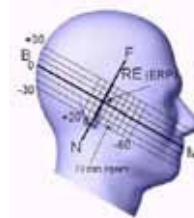

Figure 6-3 Side view w/ relevant markings

6.4 SAR Evaluations near the Mouth/Jaw Regions of the SAM Phantom

Antennas located near the bottom of a phone may require SAR measurements around the mouth and jaw regions of the SAM head phantom. This typically applies to clam-shell style phones that are generally longer in the unfolded normal use positions or to certain older style long rectangular phones. Per IEEE 1528-2013, a rotated SAM phantom is necessary to allow probe access to such regions. Both SAM heads of the TwinSAM-Chin20 are rotated 20 degrees around the NF line. Each head can be removed from the table for emptying and cleaning.

Under these circumstances, the following procedures apply, adopted from the FCC guidance on SAR handsets document FCC KDB Publication 648474 D04v01r03. The SAR required in these regions of SAM should be measured using a flat phantom. The phone should be positioned with a separation distance of 4 mm between the ear reference point (ERP) and the outer surface of the flat phantom shell. While maintaining this distance at the ERP location, the low (bottom) edge of the phone should be lowered from the phantom to establish the same separation distance between the peak SAR location identified by the truncated partial SAR distribution measured with the SAM phantom. The distance from the peak SAR location to the phone is determined by the straight line passing perpendicularly through the phantom surface. When it is not feasible to maintain 4 mm separation at the ERP while also establishing the required separation at the peak SAR location, the top edge of the phone will be allowed to touch the phantom with a separation < 4 mm at the ERP. The phone should not be tilted to the left or right while placed in this inclined position to the flat phantom.

6.5 Body-Worn Accessory Configurations

Body-worn operating configurations are tested with the belt-clips and holsters attached to the device and positioned against a flat phantom in a normal use configuration (see Figure 6-4). Per FCC KDB Publication 648474 D04v01r03, Body-worn accessory exposure is typically related to voice mode operations when handsets are carried in body-worn accessories. The body-worn accessory procedures in FCC KDB Publication 447498 D01v06 should be used to test for body-worn accessory SAR compliance, without a headset connected to it. This enables the test results for such configuration to be compatible with that required for hotspot mode when the body-worn accessory test separation distance is greater than or equal to that required for hotspot mode, when applicable. When the reported SAR for a body-worn accessory, measured without a headset connected to the handset, is > 1.2 W/kg, the highest reported SAR configuration for that wireless mode and frequency band should be repeated for that body-worn accessory with a headset attached to the handset.

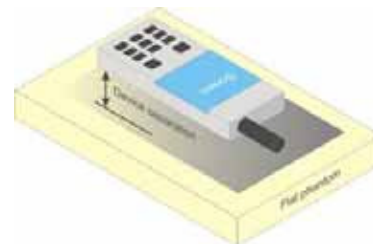



Figure 6-4 Sample Body-Worn Diagram

Accessories for Body-worn operation configurations are divided into two categories: those that do not contain metallic components and those that do contain metallic components. When multiple accessories that do not contain metallic components are supplied with the device, the device is tested with only the accessory that dictates the closest spacing to the body. Then multiple accessories that contain metallic components are tested with the device with each accessory. If multiple accessories share an identical metallic component (i.e. the same metallic belt-clip used with different holsters with no other metallic components) only the accessory that dictates the closest spacing to the body is tested.

FCC ID: ZNFH820	 SAR EVALUATION REPORT 		Reviewed by: Quality Manager
Document S/N: 0Y1601290203-R5.ZNF	Test Dates: 01/28/16 - 03/03/16	DUT Type: Portable Handset	Page 15 of 82

Body-worn accessories may not always be supplied or available as options for some devices intended to be authorized for body-worn use. In this case, a test configuration with a separation distance between the back of the device and the flat phantom is used. Test position spacing was documented.

Transmitters that are designed to operate in front of a person's face, as in push-to-talk configurations, are tested for SAR compliance with the front of the device positioned to face the flat phantom in head fluid. For devices that are carried next to the body such as a shoulder, waist or chest-worn transmitters, SAR compliance is tested with the accessories, including headsets and microphones, attached to the device and positioned against a flat phantom in a normal use configuration.

6.6 Extremity Exposure Configurations



Devices that are designed or intended for use on extremities or mainly operated in extremity only exposure conditions; i.e., hands, wrists, feet and ankles, may require extremity SAR evaluation. When the device also operates in close proximity to the user's body, SAR compliance for the body is also required. The 1-g body and 10-g extremity SAR Exclusion Thresholds found in KDB Publication 447498 D01v06 should be applied to determine SAR test requirements.

Per KDB Publication 447498 D01v06, Cell phones (handsets) are not normally designed to be used on extremities or operated in extremity only exposure conditions. The maximum output power levels of handsets generally do not require extremity SAR testing to show compliance. Therefore, extremity SAR was not evaluated for this device.

6.7 Wireless Router Configurations

Some battery-operated handsets have the capability to transmit and receive user data through simultaneous transmission of WIFI simultaneously with a separate licensed transmitter. The FCC has provided guidance in FCC KDB Publication 941225 D06v02r01 where SAR test considerations for handsets ($L \times W \geq 9 \text{ cm} \times 5 \text{ cm}$) are based on a composite test separation distance of 10 mm from the front, back and edges of the device containing transmitting antennas within 2.5 cm of their edges, determined from general mixed use conditions for this type of devices. Since the hotspot SAR results may overlap with the body-worn accessory SAR requirements, the more conservative configurations can be considered, thus excluding some body-worn accessory SAR tests.

When the user enables the personal wireless router functions for the handset, actual operations include simultaneous transmission of both the WIFI transmitter and another licensed transmitter. Both transmitters often do not transmit at the same transmitting frequency and thus cannot be evaluated for SAR under actual use conditions due to the limitations of the SAR assessment probes. Therefore, SAR must be evaluated for each frequency transmission and mode separately and spatially summed with the WIFI transmitter according to FCC KDB Publication 447498 D01v06 procedures. The "Portable Hotspot" feature on the handset was NOT activated during SAR assessments, to ensure the SAR measurements were evaluated for a single transmission frequency RF signal at a time.

FCC ID: ZNFH820		SAR EVALUATION REPORT		Reviewed by: Quality Manager
Document S/N: 0Y1601290203-R5.ZNF	Test Dates: 01/28/16 - 03/03/16	DUT Type: Portable Handset	Page 16 of 82	

6.8 Wireless Router Configuration with the Camera Module Accessory

For this device without the accessory, the back side SAR was evaluated in the standard configuration with 10 mm measured from the back of the device.

Per FCC Guidance, for the camera module, for the back side test, a test separation distance of 10 mm was measured from an imaginary plane, parallel to the flat phantom, connecting a point near the upper portion of the back side of the device and a point near the lower portion of the back side of the device. Due to the protrusion of the camera module from the rear surface of the back side, it was required to angle the device (see Figure 6-5). This data was used to address the applicable simultaneous transmission scenarios shown in Section 12.

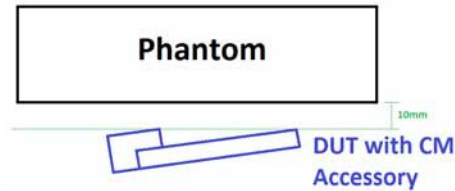

Figure 6-5

Test Setup Diagram for Back Side Hotspot SAR at 10 mm with Camera Module Accessory

The camera module SAR was additionally evaluated for 10-g hotspot SAR for the back side of the device using a test separation distance of 0 mm (touching), for each frequency band and wireless mode (see Figure 6-6). The device was not angled for this test and the protrusion was directly touching the phantom. The flat surface of the back side was parallel to the flat phantom.

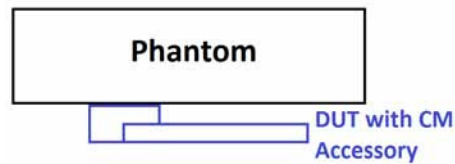



Figure 6-6

Test Setup Diagram for 10g Hotspot SAR at 0 mm with Camera Module Accessory

FCC ID: ZNFH820		SAR EVALUATION REPORT		Reviewed by: Quality Manager
Document S/N: 0Y1601290203-R5.ZNF	Test Dates: 01/28/16 - 03/03/16	DUT Type: Portable Handset	Page 17 of 82	

7 RF EXPOSURE LIMITS

7.1 Uncontrolled Environment

UNCONTROLLED ENVIRONMENTS are defined as locations where there is the exposure of individuals who have no knowledge or control of their exposure. The general population/uncontrolled exposure limits are applicable to situations in which the general public may be exposed or in which persons who are exposed as a consequence of their employment may not be made fully aware of the potential for exposure or cannot exercise control over their exposure. Members of the general public would come under this category when exposure is not employment-related; for example, in the case of a wireless transmitter that exposes persons in its vicinity.



7.2 Controlled Environment

CONTROLLED ENVIRONMENTS are defined as locations where there is exposure that may be incurred by persons who are aware of the potential for exposure, (i.e. as a result of employment or occupation). In general, occupational/controlled exposure limits are applicable to situations in which persons are exposed as a consequence of their employment, who have been made fully aware of the potential for exposure and can exercise control over their exposure. This exposure category is also applicable when the exposure is of a transient nature due to incidental passage through a location where the exposure levels may be higher than the general population/uncontrolled limits, but the exposed person is fully aware of the potential for exposure and can exercise control over his or her exposure by leaving the area or by some other appropriate means.

**Table 7-1
SAR Human Exposure Specified in ANSI/IEEE C95.1-1992 and Health Canada Safety Code 6**

HUMAN EXPOSURE LIMITS		
	UNCONTROLLED ENVIRONMENT <i>General Population</i> (W/kg) or (mW/g)	CONTROLLED ENVIRONMENT <i>Occupational</i> (W/kg) or (mW/g)
Peak Spatial Average SAR Head	1.6	8.0
Whole Body SAR	0.08	0.4
Peak Spatial Average SAR Hands, Feet, Ankle, Wrists, etc.	4.0	20

1. The Spatial Peak value of the SAR averaged over any 1 gram of tissue (defined as a tissue volume in the shape of a cube) and over the appropriate averaging time.
2. The Spatial Average value of the SAR averaged over the whole body.
3. The Spatial Peak value of the SAR averaged over any 10 grams of tissue (defined as a tissue volume in the shape of a cube) and over the appropriate averaging time.

FCC ID: ZNFH820		SAR EVALUATION REPORT		Reviewed by: Quality Manager
Document S/N: 0Y1601290203-R5.ZNF	Test Dates: 01/28/16 - 03/03/16	DUT Type: Portable Handset	Page 18 of 82	

8 FCC MEASUREMENT PROCEDURES



Power measurements for licensed transmitters are performed using a base station simulator under digital average power.

8.1 Measured and Reported SAR

Per FCC KDB Publication 447498 D01v06, when SAR is not measured at the maximum power level allowed for production units, the results must be scaled to the maximum tune-up tolerance limit according to the power applied to the individual channels tested to determine compliance. For simultaneous transmission, the measured aggregate SAR must be scaled according to the sum of the differences between the maximum tune-up tolerance and actual power used to test each transmitter. When SAR is measured at or scaled to the maximum tune-up tolerance limit, the results are referred to as *reported* SAR. The highest *reported* SAR results are identified on the grant of equipment authorization according to procedures in KDB 690783 D01v01r03.

8.2 3G SAR Test Reduction Procedure

In FCC KDB Publication 941225 D01v03r01, certain transmission modes within a frequency band and wireless mode evaluated for SAR are defined as primary modes. The equivalent modes considered for SAR test reduction are denoted as secondary modes. When the maximum output power including tune-up tolerance specified for production units in a secondary mode is

FCC ID: ZNFH820		SAR EVALUATION REPORT		Reviewed by: Quality Manager
Document S/N: 0Y1601290203-R5.ZNF	Test Dates: 01/28/16 - 03/03/16	DUT Type: Portable Handset	Page 19 of 82	

8.4.3 Body SAR Measurements

SAR for body exposure configurations is measured using the 12.2 kbps RMC with the TPC bits all “1s”. The 3G SAR test reduction procedure is applied to other spreading codes and multiple DPDCH_n configurations supported by the handset with 12.2 kbps RMC as the primary mode. Otherwise, SAR is measured using an applicable RMC configuration with the corresponding spreading code or DPDCH_n, for the highest reported SAR configuration in 12.2 kbps RMC.

8.4.4 SAR Measurements with Rel 5 HSDPA

The 3G SAR test reduction procedure is applied to HSDPA body configurations with 12.2 kbps RMC as the primary mode. Otherwise, Body SAR for HSDPA is measured using an FRC with H-Set 1 in Sub-test 1 and a 12.2 kbps RMC configured in Test Loop Mode 1, for the highest reported SAR configuration in 12.2 kbps RMC without HSDPA. Handsets with both HSDPA and HSUPA are tested according to Release 6 HSPA test procedures.

8.4.5 SAR Measurements with Rel 6 HSUPA

The 3G SAR test reduction procedure is applied to HSPA (HSUPA/HSDPA with RMC) body configurations with 12.2 kbps RMC as the primary mode. Otherwise, Body SAR for HSPA is measured with E-DCH Sub-test 5, using H-Set 1 and QPSK for FRC and a 12.2 kbps RMC configured in Test Loop Mode 1 and power control algorithm 2, according to the highest reported body SAR configuration in 12.2 kbps RMC without HSPA.

When VOIP applies to head exposure, the 3G SAR test reduction procedure is applied with 12.2 kbps RMC as the primary mode; otherwise, the same HSPA configuration used for body SAR measurements are applied to head exposure testing.

8.4.6 SAR Measurement Conditions for DC-HSDPA

SAR is required for Rel. 8 DC-HSDPA when SAR is required for Rel. 5 HSDPA; otherwise, the 3G SAR test reduction procedure is applied to DC-HSDPA with 12.2 kbps RMC as the primary mode. Power is measured for DC-HSDPA according to the H-Set 12, FRC configuration in Table C.8.1.12 of 3GPP TS 34.121-1 to determine SAR test reduction. A primary and a secondary serving HS-DSCH Cell are required to perform the power measurement and for the results to be acceptable.

8.5 SAR Measurement Conditions for LTE

LTE modes are tested according to FCC KDB 941225 D05v02r04 publication. Establishing connections with base station simulators ensure a consistent means for testing SAR and are recommended for evaluating SAR [4]. The R&S CMW500 or Anritsu MT8820C simulators are used for LTE output power measurements and SAR testing. Closed loop power control was used so the UE transmits with maximum output power during SAR testing. SAR tests were performed with the same number of RB and RB offsets transmitting on all TTI frames (maximum TTI).

8.5.1 Spectrum Plots for RB Configurations



A properly configured base station simulator was used for SAR tests and power measurements. Therefore, spectrum plots for RB configurations were not required to be included in this report.

8.5.2 MPR

MPR is permanently implemented for this device by the manufacturer. The specific manufacturer target MPR is indicated alongside the SAR results. MPR is enabled for this device, according to 3GPP TS36.101 Section 6.2.3 – 6.2.5 under Table 6.2.3-1.

8.5.3 A-MPR

A-MPR (Additional MPR) has been disabled for all SAR tests by setting NS=01 on the base station simulator.

FCC ID: ZNFH820		SAR EVALUATION REPORT		Reviewed by: Quality Manager
Document S/N: 0Y1601290203-R5.ZNF	Test Dates: 01/28/16 - 03/03/16	DUT Type: Portable Handset		Page 20 of 82

8.5.4 Required RB Size and RB Offsets for SAR Testing

According to FCC KDB 941225 D05v02r04:

- a. Per Section 5.2.1, SAR is required for QPSK 1 RB Allocation for the largest bandwidth
 - i. The required channel and offset combination with the highest maximum output power is required for SAR.
 - ii. When the reported SAR is ≤ 0.8 W/kg, testing of the remaining RB offset configurations and required test channels is not required. Otherwise, SAR is required for the remaining required test channels using the RB offset configuration with highest output power for that channel.
 - iii. When the reported SAR for a required test channel is > 1.45 W/kg, SAR is required for all RB offset configurations for that channel.
- b. Per Section 5.2.2, SAR is required for 50% RB allocation using the largest bandwidth following the same procedures outlined in Section 5.2.1.
- c. Per Section 5.2.3, QPSK SAR is not required for the 100% allocation when the highest maximum output power for the 100% allocation is less than the highest maximum output power of the 1 RB and 50% RB allocations and the reported SAR for the 1 RB and 50% RB allocations is < 0.8 W/kg.
- d. Per Section 5.2.4 and 5.3, SAR tests for higher order modulations and lower bandwidths configurations are not required when the conducted power of the required test configurations determined by Sections 5.2.1 through 5.2.3 is less than or equal to $\frac{1}{2}$ dB higher than the equivalent configuration using QPSK modulation and when the QPSK SAR for those configurations is < 1.45 W/kg.

8.5.5 Downlink Only Carrier Aggregation

Conducted power measurements with LTE Carrier Aggregation (CA) (downlink only) active are made in accordance to KDB Publication 941225 D05Av01r02. The RRC connection is only handled by one cell, the primary component carrier (PCC) for downlink and uplink communications. After making a data connection to the PCC, the UE device adds secondary component carrier(s) (SCC) on the downlink only. All uplink communications and acknowledgements remain identical to specifications when downlink carrier aggregation is inactive on the PCC. For every supported combination of downlink only carrier aggregation, additional conducted output powers are measured with the downlink carrier aggregation active for the configuration with highest measured maximum conducted power with downlink carrier aggregation inactive measured among the channel bandwidth, modulation, and RB combinations in each frequency band. Per FCC KDB Publication 941225 D05Av01r02, no SAR measurements are required for carrier aggregation configurations when the average output power with downlink only carrier aggregation active is not more than 0.25 dB higher than the average output power with downlink only carrier aggregation inactive.



8.6 SAR Testing with 802.11 Transmitters

The normal network operating configurations of 802.11 transmitters are not suitable for SAR measurements. Unpredictable fluctuations in network traffic and antenna diversity conditions can introduce undesirable variations in SAR results. The SAR for these devices should be measured using chipset based test mode software to ensure the results are consistent and reliable. See KDB Publication 248227 D01v02r02 for more details.

8.6.1 General Device Setup

Chipset based test mode software is hardware dependent and generally varies among manufacturers. The device operating parameters established in test mode for SAR measurements must be identical to those programmed in production units, including output power levels, amplifier gain settings and other RF performance tuning parameters.

A periodic duty factor is required for current generation SAR systems to measure SAR. When 802.11 frame gaps are accounted for in the transmission, a maximum transmission duty factor of 92 - 96% is typically achievable in most test mode configurations. A minimum transmission duty factor of 85% is required to avoid certain hardware and device implementation issues related to wide range SAR scaling. The reported SAR is scaled to 100% transmission duty factor to determine compliance at the maximum tune-up tolerance limit.

FCC ID: ZNFH820		SAR EVALUATION REPORT		Reviewed by: Quality Manager
Document S/N: 0Y1601290203-R5.ZNF	Test Dates: 01/28/16 - 03/03/16	DUT Type: Portable Handset		Page 21 of 82

8.6.2 U-NII-1 and U-NII-2A

For devices that operate in both U-NII-1 and U-NII-2A bands, when the same maximum output power is specified for both bands, SAR measurement using OFDM SAR test procedures is not required for U-NII-1 unless the highest reported SAR for U-NII-2A is > 1.2 W/kg. When different maximum output powers are specified for the bands, SAR measurement for the U-NII band with the lower maximum output power is not required unless the highest reported SAR for the U-NII band with the higher maximum output power, adjusted by the ratio of lower to higher specified maximum output power for the two bands, is > 1.2 W/kg.

8.6.3 U-NII-2C and U-NII-3

The frequency range covered by U-NII-2C and U-NII-3 is 380 MHz (5.47 – 5.85 GHz), which requires a minimum of at least two SAR probe calibration frequency points to support SAR measurements. When Terminal Doppler Weather Radar (TDWR) restriction applies, the channels at 5.60 – 5.65 GHz in U-NII-2C band must be disabled with acceptable mechanisms and documented in the equipment certification. Unless band gap channels are permanently disabled, SAR must be considered for these channels. Each band is tested independently according to the normally required OFDM SAR measurement and probe calibration frequency points requirements.

8.6.4 Initial Test Position Procedure

For exposure conditions with multiple test positions, such as handset operating next to the ear, devices with hotspot mode or UMPC mini-tablet, procedures for initial test position can be applied. Using the transmission mode determined by the DSSS procedure or initial test configuration, area scans are measured for all positions in an exposure condition. The test position with the highest extrapolated (peak) SAR is used as the initial test position. When reported SAR for the initial test position is ≤ 0.4 W/kg, no additional testing for the remaining test positions is required. Otherwise, SAR is evaluated at the subsequent highest peak SAR positions until the reported SAR result is ≤ 0.8 W/kg or all test positions are measured.

8.6.5 2.4 GHz SAR Test Requirements



SAR is measured for 2.4 GHz 802.11b DSSS using either the fixed test position or, when applicable, the initial test position procedure. SAR test reduction is determined according to the following:

- 1) When the reported SAR of the highest measured maximum output power channel for the exposure configuration is ≤ 0.8 W/kg, no further SAR testing is required for 802.11b DSSS in that exposure configuration.
- 2) When the reported SAR is > 0.8 W/kg, SAR is required for that position using the next highest measured output power channel. When any reported SAR is > 1.2 W/kg, SAR is required for the third channel; i.e., all channels require testing.

2.4 GHz 802.11 g/n/ac OFDM are additionally evaluated for SAR if the highest reported SAR for 802.11b, adjusted by the ratio of the OFDM to DSSS specified maximum output power, is >1.2 W/kg. When SAR is required for OFDM modes in 2.4 GHz band, the Initial Test Configuration Procedures should be followed.

8.6.6 OFDM Transmission Mode and SAR Test Channel Selection

For the 2.4 GHz and 5 GHz bands, when the same maximum output power was specified for multiple OFDM transmission mode configurations in a frequency band or aggregated band, SAR is measured using the configuration with the largest channel bandwidth, lowest order modulation and lowest data rate. When the maximum output power of a channel is the same for equivalent OFDM configurations; for example, 802.11a, 802.11n and 802.11ac or 802.11g and 802.11n with the same channel bandwidth, modulation and data rate etc., the lower order 802.11 mode i.e., 802.11a, then 802.11n and 802.11ac or 802.11g then 802.11n, is used for SAR measurement. When the maximum output power are the same for multiple test channels, either according to the default or additional power

FCC ID: ZNFH820		SAR EVALUATION REPORT		Reviewed by: Quality Manager
Document S/N: 0Y1601290203-R5.ZNF	Test Dates: 01/28/16 - 03/03/16	DUT Type: Portable Handset	Page 22 of 82	

measurement requirements, SAR is measured using the channel closest to the middle of the frequency band or aggregated band. When there are multiple channels with the same maximum output power, SAR is measured using the higher number channel.



8.6.7 Initial Test Configuration Procedure

For OFDM, in both 2.4 and 5 GHz bands, an initial test configuration is determined for each frequency band and aggregated band, according to the transmission mode with the highest maximum output power specified for SAR measurements. When the same maximum output power is specified for multiple OFDM transmission mode configurations in a frequency band or aggregated band, SAR is measured using the configuration(s) with the largest channel bandwidth, lowest order modulation, lowest data rate and lowest order IEEE 802.11 mode. The channel of the transmission mode with the highest average RF output conducted power will be the initial test configuration.

When the reported SAR is ≤ 0.8 W/kg, no additional measurements on other test channels are required. Otherwise, SAR is evaluated using the subsequent highest average RF output channel until the reported SAR result is ≤ 1.2 W/kg or all channels are measured. When there are multiple untested channels having the same subsequent highest average RF output power, the channel with higher frequency from the lowest 802.11 mode is considered for SAR measurements (See Section 8.6.6).

8.6.8 Subsequent Test Configuration Procedures

For OFDM configurations in each frequency band and aggregated band, SAR is evaluated for initial test configuration using the fixed test position or the initial test position procedure. When the highest reported SAR (for the initial test configuration), adjusted by the ratio of the specified maximum output power of the subsequent test configuration to initial test configuration, is ≤ 1.2 W/kg, no additional SAR tests for the subsequent test configurations are required.

FCC ID: ZNFH820		SAR EVALUATION REPORT		Reviewed by: Quality Manager
Document S/N: 0Y1601290203-R5.ZNF	Test Dates: 01/28/16 - 03/03/16	DUT Type: Portable Handset	Page 23 of 82	

9 RF CONDUCTED POWERS

9.1 GSM Conducted Powers

		Maximum Burst-Averaged Output Power								
		Voice	GPRS/EDGE Data (GMSK)				EDGE Data (8-PSK)			
Band	Channel	GSM [dBm] CS (1 Slot)	GPRS [dBm] 1 Tx Slot	GPRS [dBm] 2 Tx Slot	GPRS [dBm] 3 Tx Slot	GPRS [dBm] 4 Tx Slot	EDGE [dBm] 1 Tx Slot	EDGE [dBm] 2 Tx Slot	EDGE [dBm] 3 Tx Slot	EDGE [dBm] 4 Tx Slot
GSM 850	128	33.17	33.18	31.60	29.67	27.70	26.88	27.12	26.70	25.70
	190	33.16	33.15	31.66	29.60	27.61	26.89	27.10	26.65	25.68
	251	32.94	33.14	31.68	29.70	27.61	26.93	27.00	26.68	25.66
GSM 1900	512	30.70	30.65	28.61	26.70	25.70	26.20	26.12	25.60	24.68
	661	30.68	30.61	28.70	26.64	25.66	26.12	26.18	25.70	24.66
	810	30.70	30.60	28.63	26.66	25.63	26.19	26.20	25.65	24.70
		Calculated Maximum Frame-Averaged Output Power								
		Voice	GPRS/EDGE Data (GMSK)				EDGE Data (8-PSK)			
Band	Channel	GSM [dBm] CS (1 Slot)	GPRS [dBm] 1 Tx Slot	GPRS [dBm] 2 Tx Slot	GPRS [dBm] 3 Tx Slot	GPRS [dBm] 4 Tx Slot	EDGE [dBm] 1 Tx Slot	EDGE [dBm] 2 Tx Slot	EDGE [dBm] 3 Tx Slot	EDGE [dBm] 4 Tx Slot
GSM 850	128	24.14	24.15	25.58	25.41	24.69	17.85	21.10	22.44	22.69
	190	24.13	24.12	25.64	25.34	24.60	17.86	21.08	22.39	22.67
	251	23.91	24.11	25.66	25.44	24.60	17.90	20.98	22.42	22.65
GSM 1900	512	21.67	21.62	22.59	22.44	22.69	17.17	20.10	21.34	21.67
	661	21.65	21.58	22.68	22.38	22.65	17.09	20.16	21.44	21.65
	810	21.67	21.57	22.61	22.40	22.62	17.16	20.18	21.39	21.69
GSM 850	Frame	23.67	23.67	25.18	24.94	24.19	17.67	20.68	21.94	22.19
GSM 1900	Avg.Targets:	21.17	21.17	22.18	21.94	22.19	16.67	19.68	20.94	21.19

Note:

- Both burst-averaged and calculated frame-averaged powers are included. Frame-averaged power was calculated from the measured burst-averaged power by converting the slot powers into linear units and calculating the energy over 8 timeslots.
- GPRS/EDGE (GMSK) output powers were measured with coding scheme setting of 1 (CS1) on the base station simulator. CS1 was configured to measure GPRS output power measurements and SAR to ensure GMSK modulation in the signal. Our Investigation has shown that CS1 - CS4 settings do not have any impact on the output levels or modulation in the GPRS modes.
- EDGE (8-PSK) output powers were measured with MCS7 on the base station simulator. MCS7 coding scheme was used to measure the output powers for EDGE since investigation has shown that choosing MCS7 coding scheme will ensure 8-PSK modulation. It has been shown that MCS levels that produce 8PSK modulation do not have an impact on output power.

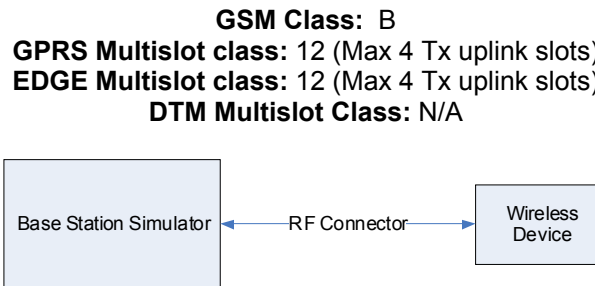

Figure 9-1
Power Measurement Setup

FCC ID: ZNFH820		SAR EVALUATION REPORT		Reviewed by: Quality Manager
Document S/N: 0Y1601290203-R5.ZNF	Test Dates: 01/28/16 - 03/03/16	DUT Type: Portable Handset		Page 24 of 82

9.2 UMTS Conducted Powers



3GPP Release Version	Mode	3GPP 34.121 Subtest	Cellular Band [dBm]			AWS Band [dBm]			PCS Band [dBm]			3GPP MPR [dB]
			4132	4183	4233	1312	1412	1513	9262	9400	9538	
99	WCDMA	12.2 kbps RMC	24.20	24.11	24.05	24.12	24.20	24.14	24.66	24.59	24.63	-
99		12.2 kbps AMR	24.13	24.09	24.08	24.08	24.13	24.18	24.61	24.54	24.62	-
6	HSDPA	Subtest 1	24.18	24.09	24.05	24.19	24.18	24.11	24.59	24.51	24.53	0
6		Subtest 2	24.17	24.07	24.12	24.13	24.20	24.16	24.54	24.50	24.57	0
6		Subtest 3	23.61	23.55	23.52	23.70	23.68	23.69	24.02	24.05	24.01	0.5
6		Subtest 4	23.54	23.59	23.48	23.66	23.68	23.70	24.03	23.98	23.95	0.5
6	HSUPA	Subtest 1	24.07	24.05	24.15	24.13	24.18	24.15	24.53	24.54	24.59	0
6		Subtest 2	22.57	22.61	22.67	23.16	23.15	23.11	23.11	23.18	23.14	2
6		Subtest 3	23.09	23.13	23.14	23.52	23.55	23.58	23.45	23.58	23.52	1
6		Subtest 4	22.92	22.97	23.01	23.57	23.58	23.52	23.58	23.52	23.62	2
6		Subtest 5	23.14	23.12	23.05	23.53	23.48	23.44	23.62	23.61	23.56	0
8	DC-HSDPA	Subtest 1	24.13	24.12	24.09	24.11	24.20	24.19	24.65	24.63	24.68	0
8		Subtest 2	24.04	24.09	24.07	24.13	24.18	24.18	24.63	24.59	24.54	0
8		Subtest 3	23.49	23.58	23.62	23.58	23.66	23.62	23.95	23.98	24.02	0.5
8		Subtest 4	23.58	23.52	23.47	23.59	23.61	23.64	23.97	23.99	24.01	0.5

DC-HSDPA considerations

- 3GPP Specification 34.121-1 Release 8 Ver 8.10.0 was used for DC-HSDPA guidance
- H-Set 12 (QPSK) was confirmed to be used during DC-HSDPA measurements
- The DUT supports UE category 24 for HSDPA



Figure 9-2
Power Measurement Setup

FCC ID: ZNFH820	 SAR EVALUATION REPORT 		Reviewed by: Quality Manager
Document S/N: 0Y1601290203-R5.ZNF	Test Dates: 01/28/16 - 03/03/16	DUT Type: Portable Handset	Page 25 of 82

9.3 LTE Conducted Powers

Note: Some columns are marked in gray for the purpose of legibility.

9.3.1 LTE Band 12



Table 9-1
LTE Band 12 Conducted Powers - 10 MHz Bandwidth

LTE Band 12 10 MHz Bandwidth					
Modulation	RB Size	RB Offset	Mid Channel	MPR Allowed per 3GPP [dB]	MPR [dB]
			23095 (707.5 MHz)		
			Conducted Power [dBm]		
QPSK	1	0	24.67	0	0
	1	25	24.65		0
	1	49	24.60		0
	25	0	23.45	0-1	1
	25	12	23.65		1
	25	25	23.54		1
	50	0	23.62		1
16QAM	1	0	23.63	0-1	1
	1	25	23.50		1
	1	49	23.62		1
	25	0	22.54	0-2	2
	25	12	22.60		2
	25	25	22.64		2
	50	0	22.41		2

Note: LTE Band 12 at 10 MHz bandwidth does not support three non-overlapping channels. Per KDB Publication 941225 D05v02, when a device supports overlapping channel assignment in a channel bandwidth configuration, the middle channel of the group of overlapping channels should be selected for testing.

Table 9-2
LTE Band 12 Conducted Powers - 5 MHz Bandwidth

LTE Band 12 5 MHz Bandwidth							
Modulation	RB Size	RB Offset	Low Channel	Mid Channel	High Channel	MPR Allowed per 3GPP [dB]	MPR [dB]
			23035 (701.5 MHz)	23095 (707.5 MHz)	23155 (713.5 MHz)		
			Conducted Power [dBm]	Conducted Power [dBm]	Conducted Power [dBm]		
QPSK	1	0	24.60	24.45	24.60	0	0
	1	12	24.50	24.50	24.60		0
	1	24	24.65	24.60	24.50		0
	12	0	23.60	23.54	23.49	0-1	1
	12	6	23.54	23.70	23.56		1
	12	13	23.50	23.40	23.54		1
	25	0	23.53	23.54	23.60		1
16QAM	1	0	23.56	23.70	23.59	0-1	1
	1	12	23.65	23.40	23.51		1
	1	24	23.60	23.50	23.66		1
	12	0	22.50	22.50	22.59	0-2	2
	12	6	22.60	22.65	22.54		2
	12	13	22.56	22.56	22.54		2
	25	0	22.57	22.58	22.64		2



FCC ID: ZNFH820		SAR EVALUATION REPORT		Reviewed by: Quality Manager
Document S/N: 0Y1601290203-R5.ZNF	Test Dates: 01/28/16 - 03/03/16	DUT Type: Portable Handset		Page 26 of 82

**Table 9-3
LTE Band 12 Conducted Powers - 3 MHz Bandwidth**

LTE Band 12 3 MHz Bandwidth							
Modulation	RB Size	RB Offset	Low Channel	Mid Channel	High Channel	MPR Allowed per 3GPP [dB]	MPR [dB]
			23025 (700.5 MHz)	23095 (707.5 MHz)	23165 (714.5 MHz)		
			Conducted Power [dBm]				
QPSK	1	0	24.60	24.70	24.65	0	0
	1	7	24.50	24.60	24.56		0
	1	14	24.65	24.54	24.58		0
	8	0	23.60	23.56	23.68	0-1	1
	8	4	23.56	23.50	23.59		1
	8	7	23.50	23.60	23.68		1
	15	0	23.60	23.45	23.49		1
16QAM	1	0	23.50	23.40	23.50	0-1	1
	1	7	23.65	23.58	23.60		1
	1	14	23.54	23.55	23.55		1
	8	0	22.56	22.48	22.54	0-2	2
	8	4	22.70	22.59	22.50		2
	8	7	22.54	22.64	22.59		2
	15	0	22.61	22.65	22.60		2

**Table 9-4
LTE Band 12 Conducted Powers -1.4 MHz Bandwidth**

LTE Band 12 1.4 MHz Bandwidth							
Modulation	RB Size	RB Offset	Low Channel	Mid Channel	High Channel	MPR Allowed per 3GPP [dB]	MPR [dB]
			23017 (699.7 MHz)	23095 (707.5 MHz)	23173 (715.3 MHz)		
			Conducted Power [dBm]				
QPSK	1	0	24.40	24.50	24.50	0	0
	1	2	24.45	24.50	24.62		0
	1	5	24.56	24.55	24.56		0
	3	0	24.60	24.65	24.56		0
	3	2	24.65	24.60	24.61		0
	3	3	24.60	24.56	24.50	0	
	6	0	23.40	23.45	23.54	0-1	1
16QAM	1	0	23.55	23.65	23.52	0-1	1
	1	2	23.50	23.67	23.45		1
	1	5	23.56	23.60	23.56		1
	3	0	23.60	23.60	23.40		1
	3	2	23.50	23.66	23.46		1
	3	3	23.60	23.60	23.65		1
	6	0	22.60	22.65	22.56	0-2	2

FCC ID: ZNFH820		SAR EVALUATION REPORT		Reviewed by: Quality Manager
Document S/N: 0Y1601290203-R5.ZNF	Test Dates: 01/28/16 - 03/03/16	DUT Type: Portable Handset		Page 27 of 82

9.3.2

LTE Band 5 (Cell)

Table 9-5
LTE Band 5 (Cell) Conducted Powers - 10 MHz Bandwidth

LTE Band 5 (Cell) 10 MHz Bandwidth					
Modulation	RB Size	RB Offset	Mid Channel	MPR Allowed per 3GPP [dB]	MPR [dB]
			20525 (836.5 MHz)		
			Conducted Power [dBm]		
QPSK	1	0	24.10	0	0
	1	25	24.11		0
	1	49	24.09		0
	25	0	23.18	0-1	1
	25	12	23.12		1
	25	25	23.05		1
	50	0	23.16		1
16QAM	1	0	23.16	0-1	1
	1	25	23.15		1
	1	49	23.14		1
	25	0	22.10	0-2	2
	25	12	22.13		2
	25	25	22.16		2
	50	0	22.07		2

Note: LTE Band 5 (Cell) at 10 MHz bandwidth does not support three non-overlapping channels. Per KDB Publication 941225 D05v02, when a device supports overlapping channel assignment in a channel bandwidth configuration, the middle channel of the group of overlapping channels should be selected for testing.

Table 9-6
LTE Band 5 (Cell) Conducted Powers - 5 MHz Bandwidth

LTE Band 5 (Cell) 5 MHz Bandwidth								
Modulation	RB Size	RB Offset	Low Channel	Mid Channel	High Channel	MPR Allowed per 3GPP [dB]	MPR [dB]	
			20425 (826.5 MHz)	20525 (836.5 MHz)	20625 (846.5 MHz)			
			Conducted Power [dBm]					
QPSK	1	0	24.10	24.20	24.13	0	0	
	1	12	24.09	24.13	24.18		0	0
	1	24	24.11	24.20	24.09		0	0
	12	0	23.18	23.13	23.15	0-1	1	
	12	6	23.20	23.18	23.12		1	
	12	13	23.20	23.11	23.16		1	
	25	0	23.18	23.18	23.10		1	
16QAM	1	0	23.09	23.15	23.08	0-1	1	
	1	12	23.07	23.14	23.15		1	
	1	24	23.07	23.14	23.10		1	
	12	0	22.14	22.15	22.14	0-2	2	
	12	6	22.16	22.14	22.15		2	
	12	13	22.10	22.04	22.20		2	
	25	0	22.04	22.11	22.08		2	





FCC ID: ZNFH820		SAR EVALUATION REPORT			Reviewed by: Quality Manager
Document S/N: 0Y1601290203-R5.ZNF	Test Dates: 01/28/16 - 03/03/16	DUT Type: Portable Handset			Page 28 of 82

Table 9-7
LTE Band 5 (Cell) Conducted Powers - 3 MHz Bandwidth

LTE Band 5 (Cell) 3 MHz Bandwidth							
Modulation	RB Size	RB Offset	Low Channel	Mid Channel	High Channel	MPR Allowed per 3GPP [dB]	MPR [dB]
			20415 (825.5 MHz)	20525 (836.5 MHz)	20635 (847.5 MHz)		
			Conducted Power [dBm]				
QPSK	1	0	24.10	24.20	24.12	0	0
	1	7	24.19	24.19	24.20		0
	1	14	24.05	24.10	24.10		0
	8	0	23.13	23.20	23.11	0-1	1
	8	4	23.19	23.12	23.18		1
	8	7	23.11	23.20	23.12		1
16QAM	15	0	23.01	23.11	23.11	0-1	1
	1	0	23.20	23.18	23.18		1
	1	7	23.14	23.10	23.14		1
	1	14	23.18	23.13	23.13	0-2	1
	8	0	22.14	22.18	22.13		2
	8	4	22.08	22.10	22.11		2
	8	7	22.03	22.20	22.20	2	
	15	0	22.14	22.18	22.12	2	

Table 9-8
LTE Band 5 (Cell) Conducted Powers -1.4 MHz Bandwidth

LTE Band 5 (Cell) 1.4 MHz Bandwidth							
Modulation	RB Size	RB Offset	Low Channel	Mid Channel	High Channel	MPR Allowed per 3GPP [dB]	MPR [dB]
			20407 (824.7 MHz)	20525 (836.5 MHz)	20643 (848.3 MHz)		
			Conducted Power [dBm]				
QPSK	1	0	24.19	24.13	24.12	0	0
	1	2	24.18	24.20	24.02		0
	1	5	24.10	24.16	24.19		0
	3	0	24.15	24.15	24.09		0
	3	2	24.14	24.10	24.14		0
	3	3	24.15	24.13	24.09	0	
16QAM	6	0	23.19	23.20	23.20	0-1	1
	1	0	23.02	23.18	23.02	0-1	1
	1	2	23.10	23.14	23.18		1
	1	5	23.06	23.14	23.09		1
	3	0	23.13	23.11	23.01		1
	3	2	23.04	23.19	23.14		1
3	3	23.14	23.07	23.10	1		
	6	0	22.20	22.20	22.11	0-2	2

FCC ID: ZNFH820		SAR EVALUATION REPORT		Reviewed by: Quality Manager
Document S/N: 0Y1601290203-R5.ZNF	Test Dates: 01/28/16 - 03/03/16	DUT Type: Portable Handset		Page 29 of 82

9.3.3

LTE Band 4 (AWS)



Table 9-9
LTE Band 4 (AWS) Conducted Powers - 20 MHz Bandwidth

LTE Band 4 (AWS) 20 MHz Bandwidth					
Modulation	RB Size	RB Offset	Mid Channel	MPR Allowed per 3GPP [dB]	MPR [dB]
			20175 (1732.5 MHz)		
			Conducted Power [dBm]		
QPSK	1	0	24.60	0	0
	1	50	24.50		0
	1	99	24.45		0
	50	0	23.47	0-1	1
	50	25	23.63		1
	50	50	23.50		1
	100	0	23.60		1
16QAM	1	0	23.50	1	1
	1	50	23.66		1
	1	99	23.54		1
	50	0	22.57	0-2	2
	50	25	22.55		2
	50	50	22.67		2
	100	0	22.60		2

Note: LTE Band 4 (AWS) at 20 MHz bandwidth does not support three non-overlapping channels. Per KDB Publication 941225 D05v02, when a device supports overlapping channel assignment in a channel bandwidth configuration, the middle channel of the group of overlapping channels should be selected for testing.

Table 9-10
LTE Band 4 (AWS) Conducted Powers - 15 MHz Bandwidth

LTE Band 4 (AWS) 15 MHz Bandwidth							
Modulation	RB Size	RB Offset	Low Channel	Mid Channel	Frequency [MHz]	MPR Allowed per 3GPP [dB]	MPR [dB]
			20025 (1717.5 MHz)	20175 (1732.5 MHz)	20325 (1747.5 MHz)		
			Conducted Power [dBm]				
QPSK	1	0	24.60	24.65	24.70	0	0
	1	36	24.50	24.60	24.60		0
	1	74	24.70	24.56	24.57		0
	36	0	23.50	23.57	23.62	0-1	1
	36	18	23.65	23.68	23.66		1
	36	37	23.65	23.60	23.53		1
	75	0	23.62	23.64	23.62		1
16QAM	1	0	23.67	23.57	23.60	0-1	1
	1	36	23.70	23.50	23.64		1
	1	74	23.60	23.55	23.54		1
	36	0	22.50	22.58	22.40	0-2	2
	36	18	22.62	22.52	22.60		2
	36	37	22.63	22.59	22.57		2
	75	0	22.50	22.60	22.70		2

FCC ID: ZNFH820		SAR EVALUATION REPORT		Reviewed by: Quality Manager
Document S/N: 0Y1601290203-R5.ZNF	Test Dates: 01/28/16 - 03/03/16	DUT Type: Portable Handset		Page 30 of 82

**Table 9-11
LTE Band 4 (AWS) Conducted Powers - 10 MHz Bandwidth**

LTE Band 4 (AWS) 10 MHz Bandwidth								
Modulation	RB Size	RB Offset	Low Channel	Mid Channel	High Channel	MPR Allowed per 3GPP [dB]	MPR [dB]	
			20000 (1715.0 MHz)	20175 (1732.5 MHz)	20350 (1750.0 MHz)			
			Conducted Power [dBm]					
QPSK	1	0	24.60	24.60	24.56	0	0	
	1	25	24.68	24.50	24.60		0	
	1	49	24.58	24.58	24.54		0	
	25	0	23.45	23.67	23.70	0-1	1	
	25	12	23.58	23.63	23.65		1	
	25	25	23.63	23.60	23.50		1	
16QAM	50	0	23.55	23.56	23.65	0-1	1	
	1	0	23.59	23.59	23.50		0-1	1
	1	25	23.57	23.65	23.62			1
	1	49	23.60	23.62	23.47	0-2		1
	25	0	22.57	22.58	22.60		2	
	25	12	22.60	22.45	22.62		2	
	25	25	22.68	22.57	22.58	0-2	2	
	50	0	22.56	22.50	22.50		2	

**Table 9-12
LTE Band 4 (AWS) Conducted Powers - 5 MHz Bandwidth**

LTE Band 4 (AWS) 5 MHz Bandwidth								
Modulation	RB Size	RB Offset	Low Channel	Mid Channel	High Channel	MPR Allowed per 3GPP [dB]	MPR [dB]	
			19975 (1712.5 MHz)	20175 (1732.5 MHz)	20375 (1752.5 MHz)			
			Conducted Power [dBm]					
QPSK	1	0	24.56	24.56	24.70	0	0	
	1	12	24.65	24.65	24.60		0	
	1	24	24.53	24.54	24.56		0	
	12	0	23.58	23.62	23.70	0-1	1	
	12	6	23.66	23.52	23.56		1	
	12	13	23.60	23.54	23.45		1	
16QAM	25	0	23.60	23.58	23.58	0-1	1	
	1	0	23.50	23.54	23.57		0-1	1
	1	12	23.60	23.64	23.64			1
	1	24	23.66	23.65	23.50	0-2		1
	12	0	22.62	22.70	22.57		2	
	12	6	22.50	22.56	22.51		2	
	12	13	22.63	22.60	22.54	0-2	2	
	25	0	22.55	22.65	22.58		2	

**Table 9-13
LTE Band 4 (AWS) Conducted Powers - 3 MHz Bandwidth**

LTE Band 4 (AWS) 3 MHz Bandwidth								
Modulation	RB Size	RB Offset	Frequency [MHz]	Frequency [MHz]	Frequency [MHz]	MPR Allowed per 3GPP [dB]	MPR [dB]	
			19965 (1711.5 MHz)	20175 (1732.5 MHz)	20385 (1753.5 MHz)			
			Conducted Power [dBm]					
QPSK	1	0	24.60	24.60	24.70	0	0	
	1	7	24.65	24.70	24.67		0	
	1	14	24.62	24.55	24.60		0	
	8	0	23.66	23.57	23.60	0-1	1	
	8	4	23.56	23.60	23.66		1	
	8	7	23.60	23.63	23.55		1	
16QAM	15	0	23.60	23.56	23.54	0-1	1	
	1	0	23.57	23.60	23.70		0-1	1
	1	7	23.55	23.70	23.70			1
	1	14	23.63	23.65	23.54	0-2		1
	8	0	22.57	22.67	22.66		2	
	8	4	22.60	22.64	22.50		2	
	8	7	22.65	22.63	22.65	0-2	2	
	15	0	22.62	22.56	22.56		2	





FCC ID: ZNFH820		SAR EVALUATION REPORT		Reviewed by: Quality Manager
Document S/N: 0Y1601290203-R5.ZNF	Test Dates: 01/28/16 - 03/03/16	DUT Type: Portable Handset		Page 31 of 82

Table 9-14
LTE Band 4 (AWS) Conducted Powers -1.4 MHz Bandwidth

LTE Band 4 (AWS) 1.4 MHz Bandwidth							
Modulation	RB Size	RB Offset	Low Channel	Mid Channel	Frequency [MHz]	MPR Allowed per 3GPP [dB]	MPR [dB]
			19957 (1710.7 MHz)	20175 (1732.5 MHz)	20393 (1754.3 MHz)		
Conducted Power [dBm]							
QPSK	1	0	24.50	24.70	24.60	0	0
	1	2	24.65	24.56	24.64		0
	1	5	24.54	24.50	24.55		0
	3	0	24.55	24.56	24.70		0
	3	2	24.50	24.51	24.64		0
	3	3	24.57	24.54	24.62		0
	6	0	23.45	23.57	23.60	0-1	1
16QAM	1	0	23.56	23.55	23.55	0-1	1
	1	2	23.70	23.70	23.46		1
	1	5	23.70	23.70	23.56		1
	3	0	23.56	23.65	23.50		1
	3	2	23.58	23.62	23.65		1
	3	3	23.67	23.58	23.66		1
	6	0	22.60	22.54	22.56	0-2	2

FCC ID: ZNFH820		SAR EVALUATION REPORT		Reviewed by: Quality Manager
Document S/N: 0Y1601290203-R5.ZNF	Test Dates: 01/28/16 - 03/03/16	DUT Type: Portable Handset	Page 32 of 82	

9.3.4

LTE Band 2 (PCS)

Table 9-15
LTE Band 2 (PCS) Conducted Powers - 20 MHz Bandwidth

LTE Band 2 (PCS) 20 MHz Bandwidth							
Modulation	RB Size	RB Offset	Low Channel	Mid Channel	High Channel	MPR Allowed per 3GPP [dB]	MPR [dB]
			18700 (1860.0 MHz)	18900 (1880.0 MHz)	19100 (1900.0 MHz)		
			Conducted Power [dBm]				
QPSK	1	0	24.58	24.65	24.65	0	0
	1	50	24.60	24.56	24.63		0
	1	99	24.60	24.58	24.70		0
	50	0	23.56	23.59	23.60	0-1	1
	50	25	23.65	23.56	23.63		1
	50	50	23.60	23.57	23.67		1
16QAM	100	0	23.60	23.51	23.63	0-1	1
	1	0	23.64	23.58	23.57		1
	1	50	23.61	23.68	23.58		1
	1	99	23.67	23.62	23.55	0-2	1
	50	0	22.64	22.60	22.67		2
	50	25	22.56	22.70	22.65		2
	50	50	22.52	22.50	22.60		2
100	0	22.54	22.56	22.56	2		

Table 9-16
LTE Band 2 (PCS) Conducted Powers - 15 MHz Bandwidth

LTE Band 2 (PCS) 15 MHz Bandwidth								
Modulation	RB Size	RB Offset	Low Channel	Mid Channel	Frequency [MHz]	MPR Allowed per 3GPP [dB]	MPR [dB]	
			18675 (1857.5 MHz)	18900 (1880.0 MHz)	19125 (1902.5 MHz)			
			Conducted Power [dBm]					
QPSK	1	0	24.56	24.70	24.70	0	0	
	1	36	24.65	24.67	24.70		0	
	1	74	24.60	24.68	24.62		0	
	16QAM	36	0	23.65	23.57	23.64	0-1	1
		36	18	23.61	23.51	23.56		1
		36	37	23.64	23.67	23.60		1
		75	0	23.60	23.68	23.60		1
16QAM	1	0	23.60	23.60	23.62	0-1	1	
	1	36	23.65	23.65	23.56		1	
	1	74	23.64	23.61	23.60		1	
	16QAM	36	0	22.56	22.60	22.56	0-2	2
		36	18	22.70	22.54	22.65		2
		36	37	22.64	22.57	22.65		2
		75	0	22.46	22.60	22.50		2



FCC ID: ZNFH820		SAR EVALUATION REPORT		Reviewed by: Quality Manager
Document S/N: 0Y1601290203-R5.ZNF	Test Dates: 01/28/16 - 03/03/16	DUT Type: Portable Handset		Page 33 of 82

Table 9-17
LTE Band 2 (PCS) Conducted Powers - 10 MHz Bandwidth

LTE Band 2 (PCS) 10 MHz Bandwidth							
Modulation	RB Size	RB Offset	Low Channel	Frequency [MHz]	Frequency [MHz]	MPR Allowed per 3GPP [dB]	MPR [dB]
			18650 (1855.0 MHz)	18900 (1880.0 MHz)	19150 (1905.0 MHz)		
			Conducted Power [dBm]				
QPSK	1	0	24.65	24.70	24.65	0	0
	1	25	24.62	24.63	24.60		0
	1	49	24.60	24.50	24.62		0
	25	0	23.60	23.60	23.65	0-1	1
	25	12	23.65	23.65	23.60		1
	25	25	23.62	23.60	23.60		1
16QAM	50	0	23.60	23.62	23.64		1
	1	0	23.65	23.70	23.59	0-1	1
	1	25	23.61	23.70	23.57		1
	1	49	23.57	23.60	23.65		1
	25	0	22.57	22.67	22.60	0-2	2
	25	12	22.70	22.60	22.63		2
25	25	22.65	22.62	22.56	2		
	50	0	22.60	22.64	22.50		2

Table 9-18
LTE Band 2 (PCS) Conducted Powers - 5 MHz Bandwidth

LTE Band 2 (PCS) 5 MHz Bandwidth							
Modulation	RB Size	RB Offset	Low Channel	Mid Channel	Frequency [MHz]	MPR Allowed per 3GPP [dB]	MPR [dB]
			18625 (1852.5 MHz)	18900 (1880.0 MHz)	19175 (1907.5 MHz)		
			Conducted Power [dBm]				
QPSK	1	0	24.60	24.65	24.62	0	0
	1	12	24.65	24.56	24.56		0
	1	24	24.65	24.60	24.70		0
	12	0	23.51	23.54	23.65	0-1	1
	12	6	23.63	23.60	23.62		1
	12	13	23.60	23.70	23.60		1
16QAM	25	0	23.70	23.55	23.61		1
	1	0	23.45	23.60	23.65	0-1	1
	1	12	23.56	23.63	23.60		1
	1	24	23.60	23.62	23.50		1
	12	0	22.57	22.56	22.56	0-2	2
	12	6	22.56	22.67	22.56		2
12	13	22.65	22.60	22.60	2		
	25	0	22.51	22.57	22.65		2

Table 9-19
LTE Band 2 (PCS) Conducted Powers - 3 MHz Bandwidth

LTE Band 2 (PCS) 3 MHz Bandwidth							
Modulation	RB Size	RB Offset	Low Channel	Mid Channel	High Channel	MPR Allowed per 3GPP [dB]	MPR [dB]
			18615 (1851.5 MHz)	18900 (1880.0 MHz)	19185 (1908.5 MHz)		
			Conducted Power [dBm]				
QPSK	1	0	24.67	24.60	24.59	0	0
	1	7	24.57	24.63	24.56		0
	1	14	24.56	24.60	24.64		0
	8	0	23.51	23.67	23.56	0-1	1
	8	4	23.56	23.63	23.59		1
	8	7	23.61	23.62	23.59		1
16QAM	15	0	23.68	23.70	23.59		1
	1	0	23.61	23.49	23.69	0-1	1
	1	7	23.46	23.57	23.52		1
	1	14	23.63	23.48	23.59		1
	8	0	22.59	22.61	22.60	0-2	2
	8	4	22.60	22.70	22.67		2
8	7	22.70	22.61	22.51	2		
	15	0	22.53	22.70	22.66		2





FCC ID: ZNFH820		SAR EVALUATION REPORT		Reviewed by: Quality Manager
Document S/N: 0Y1601290203-R5.ZNF	Test Dates: 01/28/16 - 03/03/16	DUT Type: Portable Handset		Page 34 of 82

Table 9-20
LTE Band 2 (PCS) Conducted Powers -1.4 MHz Bandwidth

LTE Band 2 (PCS) 1.4 MHz Bandwidth							
Modulation	RB Size	RB Offset	Low Channel	Mid Channel	High Channel	MPR Allowed per 3GPP [dB]	MPR [dB]
			18607 (1850.7 MHz)	18900 (1880.0 MHz)	19193 (1909.3 MHz)		
			Conducted Power [dBm]				
QPSK	1	0	24.53	24.61	24.60	0	0
	1	2	24.63	24.56	24.52		0
	1	5	24.60	24.53	24.59		0
	3	0	24.69	24.43	24.51		0
	3	2	24.61	24.40	24.54		0
	3	3	24.58	24.61	24.59		0
	6	0	23.42	23.59	23.53	0-1	1
16QAM	1	0	23.49	23.63	23.70	0-1	1
	1	2	23.63	23.63	23.70		1
	1	5	23.59	23.70	23.64		1
	3	0	23.48	23.54	23.59		1
	3	2	23.63	23.49	23.52		1
	3	3	23.50	23.63	23.38		1
	6	0	22.42	22.65	22.52	0-2	2

FCC ID: ZNFH820		SAR EVALUATION REPORT		Reviewed by: Quality Manager
Document S/N: 0Y1601290203-R5.ZNF	Test Dates: 01/28/16 - 03/03/16	DUT Type: Portable Handset	Page 35 of 82	

9.3.5

LTE Band 30



Table 9-21
LTE Band 30 Conducted Powers - 10 MHz Bandwidth

LTE Band 30 10 MHz Bandwidth						
Modulation	RB Size	RB Offset	Mid Channel	MPR Allowed per 3GPP [dB]	MPR [dB]	
			27710 (2310.0 MHz)			
			Conducted Power [dBm]			
QPSK	1	0	23.70	0	0	
		25	23.50		0	
		49	23.60		0	
	25	0	22.54	0-1	1	
		12	22.40		1	
		25	22.62		1	
50	0	22.51	1			
	1	0	22.63		0-2	1
		25	22.64			1
49		22.56	1			
25	0	21.54	2			
	12	21.49	2			
	25	21.66	2			
50	0	21.57	2			

Table 9-22
LTE Band 30 Conducted Powers - 5 MHz Bandwidth

LTE Band 30 5 MHz Bandwidth						
Modulation	RB Size	RB Offset	Mid Channel	MPR Allowed per 3GPP [dB]	MPR [dB]	
			27710 (2310.0 MHz)			
			Conducted Power [dBm]			
QPSK	1	0	23.50	0	0	
		12	22.90		0	
		24	23.40		0	
	12	0	22.50	0-1	1	
		6	22.59		1	
		13	22.65		1	
25	0	22.45	1			
	1	0	22.50		0-2	1
		12	22.59			1
24		22.69	1			
12	0	21.53	2			
	6	21.54	2			
	13	21.60	2			
25	0	21.50	2			

Note: LTE Band 30 at 5 MHz bandwidth does not support three non-overlapping channels. Per KDB Publication 941225 D05v02, when a device supports overlapping channel assignment in a channel bandwidth configuration, the middle channel of the group of overlapping channels should be selected for testing.

FCC ID: ZNFH820		SAR EVALUATION REPORT		Reviewed by: Quality Manager
Document S/N: 0Y1601290203-R5.ZNF	Test Dates: 01/28/16 - 03/03/16	DUT Type: Portable Handset		Page 36 of 82

9.3.6

LTE Band 7

Table 9-23
LTE Band 7 Conducted Powers - 20 MHz Bandwidth

LTE Band 7 20 MHz Bandwidth							
Modulation	RB Size	RB Offset	Low Channel	Mid Channel	High Channel	MPR Allowed per 3GPP [dB]	MPR [dB]
			20850 (2510.0 MHz)	21100 (2535.0 MHz)	21350 (2560.0 MHz)		
			Conducted Power [dBm]				
QPSK	1	0	24.50	24.59	24.54	0	0
		50	24.58	24.58	24.59		0
		99	24.70	24.52	24.65		0
	50	0	23.69	23.59	23.45	0-1	1
		25	23.50	23.54	23.58		1
		50	23.56	23.58	23.68		1
100	0	23.60	23.65	23.59		1	
16QAM	1	0	23.55	23.55	23.50	0-1	1
		50	23.51	23.59	23.60		1
		99	23.41	23.60	23.70		1
	50	0	22.54	22.50	22.53	0-2	2
		25	22.64	22.60	22.58		2
		50	22.69	22.58	22.42		2
	100	0	22.56	22.59	22.50		2

Table 9-24
LTE Band 7 Conducted Powers - 15 MHz Bandwidth

LTE Band 7 15 MHz Bandwidth							
Modulation	RB Size	RB Offset	Low Channel	Mid Channel	High Channel	MPR Allowed per 3GPP [dB]	MPR [dB]
			20825 (2507.5 MHz)	21100 (2535.0 MHz)	21375 (2562.5 MHz)		
			Conducted Power [dBm]				
QPSK	1	0	24.55	24.60	24.56	0	0
		36	24.58	24.59	24.50		0
		74	24.60	24.70	24.50		0
	36	0	23.50	23.60	23.55	0-1	1
		18	23.60	23.53	23.59		1
		37	23.50	23.50	23.70		1
75	0	23.60	23.43	23.65		1	
16QAM	1	0	23.66	23.48	23.58	0-1	1
		36	23.55	23.45	23.60		1
		74	23.46	23.42	23.62		1
	36	0	22.58	22.50	22.55	0-2	2
		18	22.60	22.56	22.66		2
		37	22.58	22.59	22.58		2
	75	0	22.60	22.70	22.50		2





FCC ID: ZNFH820		SAR EVALUATION REPORT			Reviewed by: Quality Manager
Document S/N: 0Y1601290203-R5.ZNF	Test Dates: 01/28/16 - 03/03/16	DUT Type: Portable Handset			Page 37 of 82

Table 9-25
LTE Band 7 Conducted Powers - 10 MHz Bandwidth

LTE Band 7 10 MHz Bandwidth							
Modulation	RB Size	RB Offset	Low Channel	Mid Channel	High Channel	MPR Allowed per 3GPP [dB]	MPR [dB]
			20800 (2505.0 MHz)	21100 (2535.0 MHz)	21400 (2565.0 MHz)		
			Conducted Power [dBm]				
QPSK	1	0	24.54	24.56	24.60	0	0
	1	25	24.58	24.59	24.58		0
	1	49	24.70	24.50	24.67		0
	25	0	23.50	23.59	23.48	0-1	1
	25	12	23.56	23.70	23.55		1
	25	25	23.55	23.62	23.56		1
	50	0	23.59	23.66	23.69		1
16QAM	1	0	23.64	23.62	23.51	0-1	1
	1	25	23.60	23.51	23.58		1
	1	49	23.62	23.50	23.55		1
	25	0	22.59	22.56	22.40	0-2	2
	25	12	22.58	22.50	22.50		2
	25	25	22.63	22.56	22.65		2
	50	0	22.63	22.60	22.60		2

Table 9-26
LTE Band 7 Conducted Powers - 5 MHz Bandwidth

LTE Band 7 5 MHz Bandwidth							
Modulation	RB Size	RB Offset	Low Channel	Mid Channel	High Channel	MPR Allowed per 3GPP [dB]	MPR [dB]
			20775 (2502.5 MHz)	21100 (2535.0 MHz)	21425 (2567.5 MHz)		
			Conducted Power [dBm]				
QPSK	1	0	24.45	24.60	24.50	0	0
	1	12	24.60	24.50	24.40		0
	1	24	24.65	24.44	24.60		0
	12	0	23.56	23.50	23.56	0-1	1
	12	6	23.55	23.54	23.48		1
	12	13	23.68	23.57	23.49		1
	25	0	23.63	23.55	23.59		1
16QAM	1	0	23.64	23.51	23.54	0-1	1
	1	12	23.70	23.59	23.58		1
	1	24	23.55	23.60	23.70		1
	12	0	22.45	22.54	22.54	0-2	2
	12	6	22.52	22.46	22.56		2
	12	13	22.58	22.45	22.59		2
	25	0	22.50	22.60	22.64		2

FCC ID: ZNFH820		SAR EVALUATION REPORT		Reviewed by: Quality Manager
Document S/N: 0Y1601290203-R5.ZNF	Test Dates: 01/28/16 - 03/03/16	DUT Type: Portable Handset		Page 38 of 82

9.3.7



LTE Carrier Aggregation Conducted Powers

Table 9-27

LTE Carrier Aggregation Information per FCC KDB Publication 941225 D05Av01r02, C (3)

3) When Carrier Aggregation applies, explanations of Inter-band and Intra-band aggregation Capabilities					
a)	Intra-band and inter-band carrier aggregation for both downlink and uplink, including Wi-Fi offloading using LTE-U, LAA or LWA protocols?	Down-link inter-band downlink carrier aggregation is supported per the combinations below. Uplink Carrier Aggregation is not supported. Wi-Fi offloading using LTE-U, LAA and LWA is not supported.			
i)	Support of contiguous and non-contiguous component carriers for intra-band aggregation:	All inter-band combinations are non-contiguous. Intra-band carrier aggregation is not supported.			
ii)	Frequency band combinations supported for intra-band and inter-band carrier aggregation:	LTE B2 (PCC) + LTE B4 (SCC)	LTE B2 (PCC) + LTE B5 (SCC)	LTE B2 (PCC) + LTE B12 (SCC)	LTE B2 (PCC) + LTE B17 (SCC)
		LTE B2 (PCC) + LTE B29 (SCC)	LTE B2 (PCC) + LTE B30 (SCC)	LTE B4 (PCC) + LTE B2 (SCC)	LTE B4 (PCC) + LTE B5 (SCC)
		LTE B4 (PCC) + LTE B7 (SCC)	LTE B4 (PCC) + LTE B12 (SCC)	LTE B4 (PCC) + LTE B17 (SCC)	LTE B4 (PCC) + LTE B29 (SCC)
		LTE B4 (PCC) + LTE B30 (SCC)	LTE B5 (PCC) + LTE B2 (SCC)	LTE B5 (PCC) + LTE B4 (SCC)	LTE B5 (PCC) + LTE B30 (SCC)
		LTE B7 (PCC) + LTE B4 (SCC)	LTE B12 (PCC) + LTE B2 (SCC)	LTE B12 (PCC) + LTE B4 (SCC)	LTE B12 (PCC) + LTE B30 (SCC)
		LTE B17 (PCC) + LTE B2 (SCC)	LTE B17 (PCC) + LTE B4 (SCC)	LTE B30 (PCC) + LTE B2 (SCC)	LTE B30 (PCC) + LTE B4 (SCC)
		LTE B30 (PCC) + LTE B5 (SCC)	LTE B30 (PCC) + LTE B12 (SCC)	LTE B30 (PCC) + LTE B29 (SCC)	
iii)	Number of component carriers, including all combinations, supported for intra-band and inter-band carrier aggregation in the uplink and downlink:	A maximum of 2 component carriers is supported on the DL. Carrier Aggregation is not supported on the uplink.			
iv)	The channel bandwidth configurations applicable to each carrier aggregation configuration and the applicable carrier aggregation (CA) Bandwidth Classes; A ... F, etc.:	See Section 3)b)iii)			
v)	Restrictions on certain channel combinations:	None			
vi)	RB combinations supported by the carrier aggregation configurations:	All RB configurations supported.			
b) Carrier Aggregation is supported for downlink only:					
i)	Frequency bands and channel bandwidths allowed for the uplink and downlink configuration combinations?	LTE B2 (PCC) + LTE B4 (SCC) CA_2A-4A	LTE B2 (PCC) + LTE B5 (SCC) CA_2A-5A	LTE B2 (PCC) + LTE B12 (SCC) CA_2A-12A	LTE B2 (PCC) + LTE B17 (SCC) CA_2A-17A
		B2 (PCC): 5, 10, 15, 20 MHz	B2 (PCC): 5, 10, 15, 20 MHz	B2 (PCC): 5, 10, 15, 20 MHz	B2 (PCC): 5, 10 MHz
		B4 (SCC): 5, 10, 15, 20 MHz	B5 (SCC): 5, 10 MHz	B12 (SCC): 5, 10 MHz	B17 (SCC): 5, 10 MHz
		LTE B2 (PCC) + LTE B29 (SCC) CA_2A-29A	LTE B2 (PCC) + LTE B30 (SCC) CA_2A-30A	LTE B4 (PCC) + LTE B2 (SCC) CA_2A-4A	LTE B4 (PCC) + LTE B5 (SCC) CA_4A-5A
		B2 (PCC): 5, 10, 15, 20 MHz	B2 (PCC): 5, 10, 15, 20 MHz	B4 (PCC): 5, 10, 15, 20 MHz	B4 (PCC): 5, 10, 15, 20 MHz
		B29 (SCC): 5, 10 MHz	B30 (SCC): 5, 10 MHz	B2 (SCC): 5, 10, 15, 20 MHz	B5 (SCC): 5, 10 MHz
		LTE B4 (PCC) + LTE B7 (SCC) CA_4A-7A	LTE B4 (PCC) + LTE B12 (SCC) CA_4A-12A	LTE B4 (PCC) + LTE B17 (SCC) CA_4A-17A	LTE B4 (PCC) + LTE B29 (SCC) CA_4A-29A
		B4 (PCC): 5, 10 MHz	B4 (PCC): 5, 10, 15, 20 MHz	B4 (PCC): 5, 10 MHz	B4 (PCC): 5, 10, 15, 20 MHz
		B7 (SCC): 5, 10, 15, 20 MHz	B12 (SCC): 5, 10 MHz	B17 (SCC): 5, 10 MHz	B29 (SCC): 3, 5, 10 MHz
		LTE B4 (PCC) + LTE B30 (SCC) CA_4A-30A	LTE B5 (PCC) + LTE B2 (SCC) CA_2A-5A	LTE B5 (PCC) + LTE B4 (SCC) CA_4A-5A	LTE B5 (PCC) + LTE B30 (SCC) CA_5A-30A
		B4 (PCC): 5, 10, 15, 20 MHz	B5 (PCC): 5, 10 MHz	B5 (PCC): 5, 10 MHz	B5 (PCC): 5, 10 MHz
		B30 (SCC): 5, 10 MHz	B2 (SCC): 5, 10, 15, 20 MHz	B4 (SCC): 5, 10, 15, 20 MHz	B30 (SCC): 5, 10 MHz
		LTE B7 (PCC) + LTE B4 (SCC) CA_4A-7A	LTE B12 (PCC) + LTE B2 (SCC) CA_2A-12A	LTE B12 (PCC) + LTE B4 (SCC) CA_4A-12A	LTE B12 (PCC) + LTE B30 (SCC) CA_12A-30A
		B7 (PCC): 5, 10, 15, 20 MHz	B12 (PCC): 5, 10 MHz	B12 (PCC): 5, 10 MHz	B12 (PCC): 5, 10 MHz
		B4 (SCC): 5, 10 MHz	B2 (SCC): 5, 10, 15, 20 MHz	B4 (SCC): 1, 4, 3, 5, 10, 15, 20 MHz	B30 (SCC): 5, 10 MHz
		LTE B17 (PCC) + LTE B2 (SCC) CA_2A-17A	LTE B17 (PCC) + LTE B4 (SCC) CA_4A-17A	LTE B30 (PCC) + LTE B2 (SCC) CA_2A-30A	LTE B30 (PCC) + LTE B4 (SCC) CA_4A-30A
		B17 (PCC): 5, 10 MHz	B17 (PCC): 5, 10 MHz	B30 (PCC): 5, 10 MHz	B30 (PCC): 5, 10 MHz
B2 (SCC): 5, 10 MHz	B4 (SCC): 5, 10 MHz	B2 (SCC): 5, 10, 15, 20 MHz	B4 (SCC): 5, 10, 15, 20 MHz		
LTE B30 (PCC) + LTE B5 (SCC) CA_5A-30A	LTE B30 (PCC) + LTE B12 (SCC) CA_12A-30A	LTE B30 (PCC) + LTE B29 (SCC) CA_29A-30A			
B30 (PCC): 5, 10 MHz	B30 (PCC): 5, 10 MHz	B30 (PCC): 5, 10 MHz			
B5 (SCC): 5, 10 MHz	B12 (SCC): 5, 10 MHz	B29 (SCC): 5, 10 MHz			
ii)	Uplink maximum output power measurement with downlink carrier aggregation active measured, using the highest output channel measured without downlink carrier aggregation and not more than 1/4 dB higher than the maximum output power measured when downlink carrier aggregation inactive?	Yes, Please see Table 9-28			
iii)	SAR measurements required for downlink carrier aggregation per 3)b)ii)?	No			
c)	If Carrier Aggregation is supported for uplink, maximum output power and tune-up tolerance specified for each component carrier in each carrier aggregation configuration are required to determine the SAR test configurations:	Uplink Carrier Aggregation not supported.			
i)	When power reduction applies, the maximum output power specifications and measured results with and without carrier aggregation in the reduced power configurations are included?	N/A			
ii)	Does the maximum output power specified for production units, including tune up tolerance, varies across channel bandwidth, modulationm RB allocation, channels etc.?	N/A			
d)	Description of Test Equipment and Setup for power and SAR measurements?	Yes, See Section 8.5.5			
e)	Other restrictions or limitations associated with the carrier aggregation implementation?	No			

Note: Down-link LTE Carrier Aggregation is supported for all combinations of the PCC and SCC bandwidths listed above. While some additional bandwidths may be supported in 3GPP 36.101, only the above bandwidth combinations will be implemented in this device.



FCC ID: ZNFH820		SAR EVALUATION REPORT		Reviewed by: Quality Manager
Document S/N: 0Y1601290203-R5.ZNF	Test Dates: 01/28/16 - 03/03/16	DUT Type: Portable Handset	Page 39 of 82	

**Table 9-28
LTE Carrier Aggregation Conducted Powers**

PCC								SCC				Power	
PCC Band	PCC Bandwidth [MHz]	PCC (UL) Channel	PCC (UL) Frequency [MHz]	PCC UL# RB	PCC UL RB Offset	PCC (DL) Channel	PCC (DL) Frequency [MHz]	SCC Band	SCC Bandwidth [MHz]	SCC (DL) Channel	SCC (DL) Frequency [MHz]	LTE Rel 10 Tx.Power (dBm)	LTE Rel. 8 Tx.Power (dBm)
LTE B2	20	19100	1900	1	99	600	1930	LTE B12	10	5095	737.5	24.59	24.70
LTE B4	15	20025	1717.5	1	74	2025	2117.5	LTE B12	10	5095	737.5	24.66	24.70
LTE B2	20	19100	1900	1	99	600	1930	LTE B29	10	9715	722.5	24.61	24.70
LTE B4	15	20025	1717.5	1	74	2025	2117.5	LTE B29	10	9715	722.5	24.60	24.70
LTE B5	5	20525	836.5	1	0	2525	881.5	LTE B2	20	900	1960	24.20	24.20
LTE B5	5	20525	836.5	1	0	2525	881.5	LTE B4	20	2175	2132.5	24.20	24.20
LTE B7	20	20850	2510	1	99	2850	2630	LTE B4	10	2175	2132.5	24.69	24.70
LTE B12	10	23095	707.5	1	0	5095	737.5	LTE B4	20	2175	2132.5	24.68	24.67
LTE B12	10	23095	707.5	1	0	5095	737.5	LTE B2	20	900	1960	24.53	24.67
LTE B30	10	27710	2310	1	0	9820	2355	LTE B4	20	2175	2132.5	23.70	23.70
LTE B30	10	27710	2310	1	0	9820	2355	LTE B2	20	900	1960	23.61	23.70
LTE B2	20	19100	1900	1	99	600	1930	LTE B5	10	2525	881.5	24.64	24.70
LTE B2	20	19100	1900	1	99	600	1930	LTE B30	10	9820	2355	24.70	24.70
LTE B4	15	20025	1717.5	1	74	2025	2117.5	LTE B5	10	2525	881.5	24.55	24.70
LTE B4	15	20025	1717.5	1	74	2025	2117.5	LTE B30	10	9820	2355	24.70	24.70
LTE B4	5	20375	1752.5	1	0	2375	2152.5	LTE B7	20	3100	2655	24.69	24.70
LTE B2	20	19100	1900	1	99	600	1930	LTE B4	20	2175	2132.5	24.63	24.70
LTE B4	15	20025	1717.5	1	74	2025	2117.5	LTE B2	20	900	1960	24.67	24.70
LTE B5	5	20525	836.5	1	0	2525	881.5	LTE B30	10	9820	2355	24.18	24.20
LTE B12	10	23095	707.5	1	0	5095	737.5	LTE B30	10	9820	2355	24.52	24.67
LTE B30	10	27710	2310	1	0	9820	2355	LTE B5	10	2525	881.5	23.65	23.70
LTE B30	10	27710	2310	1	0	9820	2355	LTE B12	10	5095	737.5	23.70	23.70
LTE B30	10	27710	2310	1	0	9820	2355	LTE B29	10	9715	722.5	23.50	23.70

Notes:

1. The device does not support all Rel. 10 Carrier Aggregation features due to modem chipset limitation.
2. The device only supports LTE downlink Carrier Aggregation. Uplink Carrier Aggregation is not supported. Power measurements were performed with two DL carriers for the Release 8 configuration that had the highest output power (across all bandwidths, channels and RB Configurations) for each band
3. All control and acknowledgment data is sent on uplink channels that operate identical to release 8 specifications.
4. This device supports both LTE Band 12 and LTE Band 17. Since the supported frequency span for LTE Band 17 falls completely within the supported frequency span for LTE band 12, LTE Band 17 has same or lower target power as LTE Band 12, and both LTE bands share the same transmission path, LTE CA SAR combinations were only assessed for LTE Band 12.

FCC ID: ZNFH820		SAR EVALUATION REPORT		Reviewed by: Quality Manager
Document S/N: 0Y1601290203-R5.ZNF	Test Dates: 01/28/16 - 03/03/16	DUT Type: Portable Handset	Page 40 of 82	

9.4 WLAN Conducted Powers

Table 9-29
2.4 GHz WLAN Average RF Power

Freq [MHz]	Channel	2.4GHz Conducted Power [dBm]	
		IEEE Transmission Mode	
		802.11b	802.11g
2417	2	17.55	15.64
2437	6	18.05	16.34
2457	10	17.81	15.92

Table 9-30
5 GHz WLAN Average RF Power

Freq [MHz]	Channel	5GHz (20MHz) Conducted Power [dBm]		
		IEEE Transmission Mode		
		802.11a	802.11n	802.11ac
5180	36	13.22	13.06	12.99
5200	40	13.29	13.05	13.04
5220	44	13.34	13.21	13.22
5240	48	13.26	13.25	13.22
5260	52	12.95	12.69	12.61
5280	56	12.94	12.74	12.65
5300	60	12.96	12.80	12.65
5320	64	12.91	12.63	12.59
5500	100	12.53	12.19	12.11
5580	116	12.29	12.22	12.10
5660	132	12.23	11.87	11.83
5720	144	12.15	12.04	11.85
5745	149	12.76	12.54	12.52
5785	157	12.70	12.66	12.55
5825	165	12.67	12.62	12.53

Justification for test configurations for WLAN per KDB Publication 248227 D01v02r02:

- Power measurements were performed for the transmission mode configuration with the highest maximum output power specified for production units.
- For transmission modes with the same maximum output power specification, powers were measured for the largest channel bandwidth, lowest order modulation and lowest data rate.
- For transmission modes with identical maximum specified output power, channel bandwidth, modulation and data rates, power measurements were required for all identical configurations.
- For each transmission mode configuration, powers were measured for the highest and lowest channels; and at the mid-band channel(s) when there were at least 3 channels supported. For configurations with multiple mid-band channels, due to an even number of channels, both channels were measured.
- The bolded data rate and channel above were tested for SAR.

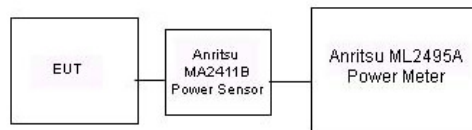



Figure 9-3
Power Measurement Setup for Bandwidths < 50 MHz

FCC ID: ZNFH820		SAR EVALUATION REPORT		Reviewed by: Quality Manager
Document S/N: 0Y1601290203-R5_ZNF	Test Dates: 01/28/16 - 03/03/16	DUT Type: Portable Handset	Page 41 of 82	

9.5 Bluetooth Conducted Powers

Table 9-31
Bluetooth RF Conducted Powers

Frequency [MHz]	Data Rate [Mbps]	Channel No.	Avg Conducted Power	
			[dBm]	[mW]
2402	1.0	0	7.27	5.336
2441	1.0	39	8.85	7.667
2480	1.0	78	6.19	4.161
2402	2.0	0	2.59	1.814
2441	2.0	39	4.64	2.908
2480	2.0	78	2.39	1.733
2402	3.0	0	2.65	1.840
2441	3.0	39	4.70	2.950
2480	3.0	78	2.45	1.758

Notes:

- The bolded data rate and channel above were tested for SAR.

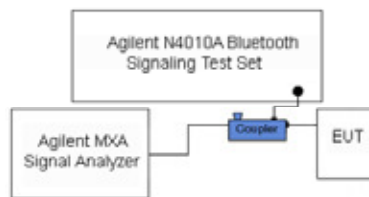



Figure 9-4
Power Measurement Setup



FCC ID: ZNFH820		SAR EVALUATION REPORT		Reviewed by: Quality Manager
Document S/N: 0Y1601290203-R5.ZNF	Test Dates: 01/28/16 - 03/03/16	DUT Type: Portable Handset		Page 42 of 82

10 SYSTEM VERIFICATION

10.1 Tissue Verification



**Table 10-1
Measured Head Tissue Properties**

Calibrated for Tests Performed on:	Tissue Type	Tissue Temp During Calibration (C°)	Measured Frequency (MHz)	Measured Conductivity, σ (S/m)	Measured Dielectric Constant, ϵ	TARGET Conductivity, σ (S/m)	TARGET Dielectric Constant, ϵ	% dev σ	% dev ϵ
2/7/2016	750H	20.0	700	0.857	43.735	0.889	42.201	-3.60%	3.63%
			710	0.863	43.526	0.890	42.149	-3.03%	3.27%
			720	0.874	43.481	0.891	42.097	-1.91%	3.29%
			725	0.880	43.378	0.891	42.071	-1.23%	3.11%
			740	0.892	43.180	0.893	41.994	-0.11%	2.82%
1/28/2016	835H	22.5	820	0.872	40.902	0.899	41.578	-3.00%	-1.63%
			835	0.885	40.687	0.900	41.500	-1.67%	-1.96%
			850	0.900	40.465	0.916	41.500	-1.75%	-2.49%
2/4/2016	1750H	22.5	1710	1.294	39.763	1.348	40.142	-4.01%	-0.94%
			1750	1.332	39.530	1.371	40.079	-2.84%	-1.37%
			1790	1.381	39.369	1.394	40.016	-0.93%	-1.62%
1/29/2016	1900H	22.6	1850	1.343	38.804	1.400	40.000	-4.07%	-2.99%
			1880	1.374	38.662	1.400	40.000	-1.86%	-3.35%
			1910	1.408	38.583	1.400	40.000	0.57%	-3.54%
2/1/2016	1900H	22.1	1850	1.381	39.098	1.400	40.000	-1.36%	-2.26%
			1880	1.411	38.938	1.400	40.000	0.79%	-2.65%
			1910	1.448	38.822	1.400	40.000	3.43%	-2.94%
2/22/2016	2300H	23.4	2300	1.651	38.624	1.670	39.500	-1.14%	-2.22%
			2310	1.660	38.615	1.679	39.480	-1.13%	-2.19%
			2320	1.666	38.612	1.687	39.460	-1.24%	-2.15%
2/1/2016	2450H	24.2	2400	1.751	40.614	1.756	39.289	-0.28%	3.37%
			2450	1.808	40.413	1.800	39.200	0.44%	3.09%
			2500	1.871	40.235	1.855	39.136	0.86%	2.81%
2/22/2016	2450H	23.4	2400	1.759	38.329	1.756	39.289	0.17%	-2.44%
			2450	1.812	38.112	1.800	39.200	0.67%	-2.78%
			2500	1.871	37.941	1.855	39.136	0.86%	-3.05%
			2550	1.923	37.757	1.909	39.073	0.73%	-3.37%
02/10/2016	5200H-5800H	22.5	5300	4.585	37.537	4.758	35.871	-3.64%	4.64%
			5500	4.762	37.292	4.963	35.643	-4.05%	4.63%
			5745	5.040	37.022	5.214	35.363	-3.34%	4.69%
			5800	5.087	36.958	5.270	35.300	-3.47%	4.70%

FCC ID: ZNFH820		SAR EVALUATION REPORT			Reviewed by: Quality Manager
Document S/N: 0Y1601290203-R5.ZNF	Test Dates: 01/28/16 - 03/03/16	DUT Type: Portable Handset		Page 43 of 82	

**Table 10-2
Measured Body Tissue Properties**



Calibrated for Tests Performed on:	Tissue Type	Tissue Temp During Calibration (C°)	Measured Frequency (MHz)	Measured Conductivity, σ (S/m)	Measured Dielectric Constant, ϵ	TARGET Conductivity, σ (S/m)	TARGET Dielectric Constant, ϵ	% dev σ	% dev ϵ
2/8/2016	750B	20.4	700	0.921	55.133	0.959	55.726	-3.96%	-1.06%
			710	0.922	55.020	0.960	55.687	-3.96%	-1.20%
			720	0.932	55.009	0.961	55.648	-3.02%	-1.15%
			725	0.937	54.853	0.961	55.629	-2.50%	-1.39%
			740	0.955	54.906	0.963	55.570	-0.83%	-1.19%
2/2/2016	835B	22.8	755	0.972	54.607	0.964	55.512	0.83%	-1.63%
			820	0.990	55.592	0.969	55.258	2.17%	0.60%
			835	1.004	55.452	0.970	55.200	3.51%	0.46%
2/1/2016	1750B	22.5	850	1.018	55.321	0.988	55.154	3.04%	0.30%
			1710	1.467	51.695	1.463	53.537	0.27%	-3.44%
			1750	1.512	51.539	1.488	53.432	1.61%	-3.54%
2/10/2016	1750B	22.6	1790	1.557	51.370	1.514	53.326	2.84%	-3.67%
			1710	1.435	51.538	1.463	53.537	-1.91%	-3.73%
2/8/2016	1900B	22.0	1750	1.484	51.369	1.488	53.432	-0.27%	-3.86%
			1790	1.527	51.173	1.514	53.326	0.86%	-4.04%
			1850	1.520	51.526	1.520	53.300	0.00%	-3.33%
2/11/2016	2300B	23.0	1880	1.551	51.378	1.520	53.300	2.04%	-3.61%
			1910	1.585	51.289	1.520	53.300	4.28%	-3.77%
			2300	1.826	52.675	1.809	52.900	0.94%	-0.43%
2/22/2016	2300B	22.1	2310	1.834	52.655	1.816	52.887	0.99%	-0.44%
			2320	1.852	52.592	1.826	52.873	1.42%	-0.53%
			2300	1.809	51.639	1.809	52.900	0.00%	-2.38%
2/3/2016	2450B	23.0	2310	1.822	51.601	1.816	52.887	0.33%	-2.43%
			2320	1.833	51.559	1.826	52.873	0.38%	-2.49%
			2400	1.916	51.963	1.902	52.767	0.74%	-1.52%
2/16/2016	2450B	23.4	2450	1.984	51.839	1.950	52.700	1.74%	-1.63%
			2500	2.049	51.617	2.021	52.636	1.39%	-1.94%
			2400	1.887	50.928	1.902	52.767	-0.79%	-3.49%
			2450	1.952	50.779	1.950	52.700	0.10%	-3.65%
02/08/2016	5200B-5800B	24.0	2500	2.018	50.594	2.021	52.636	-0.15%	-3.88%
			2500	2.018	50.594	2.021	52.636	-0.15%	-3.88%
			5240	5.481	48.168	5.346	48.960	2.53%	-1.62%
			5260	5.505	48.144	5.369	48.933	2.53%	-1.61%
			5300	5.567	48.071	5.416	48.879	2.79%	-1.65%
			5500	5.833	47.678	5.650	48.607	3.24%	-1.91%
			5600	5.983	47.544	5.766	48.471	3.76%	-1.91%
5745	6.193	47.219	5.936	48.275	4.33%	-2.19%			
5765	6.215	47.211	5.959	48.248	4.30%	-2.15%			

FCC ID: ZNFH820		SAR EVALUATION REPORT		Reviewed by: Quality Manager
Document S/N: 0Y1601290203-R5.ZNF	Test Dates: 01/28/16 - 03/03/16	DUT Type: Portable Handset	Page 44 of 82	

**Table 10-3
Measured Body 10g Tissue Properties**

Calibrated for Tests Performed on:	Tissue Type	Tissue Temp During Calibration (C°)	Measured Frequency (MHz)	Measured Conductivity, σ (S/m)	Measured Dielectric Constant, ϵ	TARGET Conductivity, σ (S/m)	TARGET Dielectric Constant, ϵ	% dev σ	% dev ϵ
2/27/2016	750B	20.8	700	0.913	55.608	0.959	55.726	-4.80%	-0.21%
			710	0.918	55.510	0.960	55.687	-4.37%	-0.32%
			720	0.927	55.422	0.961	55.648	-3.54%	-0.41%
			725	0.932	55.374	0.961	55.629	-3.02%	-0.46%
			740	0.946	55.219	0.963	55.570	-1.77%	-0.63%
			755	0.961	55.068	0.964	55.512	-0.31%	-0.80%
2/27/2016	835B	19.2	820	0.982	54.021	0.969	55.258	1.34%	-2.24%
			835	0.996	53.964	0.970	55.200	2.68%	-2.24%
			850	1.012	53.791	0.988	55.154	2.43%	-2.47%
2/27/2016	1750B	20.5	1710	1.438	52.253	1.463	53.537	-1.71%	-2.40%
			1750	1.483	52.104	1.488	53.432	-0.34%	-2.49%
			1790	1.528	51.931	1.514	53.326	0.92%	-2.62%
3/3/2016	1750B	22.0	1710	1.429	52.426	1.463	53.537	-2.32%	-2.08%
			1750	1.473	52.270	1.488	53.432	-1.01%	-2.17%
			1790	1.520	52.137	1.514	53.326	0.40%	-2.23%
3/3/2016	1900B	21.8	1850	1.508	53.061	1.520	53.300	-0.79%	-0.45%
			1880	1.540	53.005	1.520	53.300	1.32%	-0.55%
			1910	1.574	52.874	1.520	53.300	3.55%	-0.80%
3/3/2016	2300B	20.5	2300	1.813	51.561	1.809	52.900	0.22%	-2.53%
			2310	1.827	51.527	1.816	52.887	0.61%	-2.57%
			2320	1.840	51.489	1.826	52.873	0.77%	-2.62%
2/26/2016	2450B	24.1	2450	1.989	50.648	1.950	52.700	2.00%	-3.89%
			2500	2.057	50.397	2.021	52.636	1.78%	-4.25%
			2550	2.125	50.249	2.092	52.573	1.58%	-4.42%

The above measured tissue parameters were used in the DASY software. The DASY software was used to perform interpolation to determine the dielectric parameters at the SAR test device frequencies (per KDB Publication 865664 D01v01r04 and IEEE 1528-2013 6.6.1.2). The tissue parameters listed in the SAR test plots may slightly differ from the table above due to significant digit rounding in the software.



FCC ID: ZNFH820	 SAR EVALUATION REPORT		Reviewed by: Quality Manager
Document S/N: 0Y1601290203-R5.ZNF	Test Dates: 01/28/16 - 03/03/16	DUT Type: Portable Handset	Page 45 of 82

10.2 Test System Verification

Prior to SAR assessment, the system is verified to $\pm 10\%$ of the SAR measurement on the reference dipole at the time of calibration by the calibration facility. Full system validation status and result summary can be found in Appendix E.

Table 10-4
System Verification Results – 1g

SAR System #	Tissue Frequency (MHz)	Tissue Type	Date:	Amb. Temp (°C)	Liquid Temp (°C)	Input Power (W)	Dipole SN	Probe SN	Measured SAR _{1g} (W/kg)	1 W Target SAR _{1g} (W/kg)	1 W Normalized SAR _{1g} (W/kg)	Deviation _{1g} (%)
I	750	HEAD	02/07/2016	20.7	20.4	0.200	1054	3333	1.690	8.280	8.450	2.05%
J	835	HEAD	01/28/2016	21.6	22.5	0.200	4d133	3319	1.910	9.130	9.550	4.60%
K	1750	HEAD	02/04/2016	23.5	21.7	0.100	1051	3022	3.440	36.200	34.400	-4.97%
G	1900	HEAD	01/29/2016	24.3	23.0	0.100	5d149	3334	3.860	40.700	38.600	-5.16%
G	1900	HEAD	02/01/2016	24.5	22.8	0.100	5d149	3334	4.340	40.700	43.400	6.63%
E	2300	HEAD	02/22/2016	23.8	23.4	0.100	1064	3351	4.420	47.600	44.200	-7.14%
H	2450	HEAD	02/01/2016	22.5	22.5	0.100	719	3263	5.480	54.200	54.800	1.11%
E	2450	HEAD	02/22/2016	23.8	23.4	0.100	719	3351	5.200	54.200	52.000	-4.06%
D	5300	HEAD	02/10/2016	22.1	22.7	0.050	1120	7357	3.820	81.100	76.400	-5.80%
D	5500	HEAD	02/10/2016	22.1	22.7	0.050	1120	7357	3.770	81.700	75.400	-7.71%
D	5800	HEAD	02/10/2016	22.1	22.7	0.050	1120	7357	3.750	77.300	75.000	-2.98%
K	750	BODY	02/08/2016	20.6	21.1	0.200	1054	3022	1.790	8.530	8.950	4.92%
G	835	BODY	02/02/2016	24.3	22.8	0.200	4d119	3334	1.990	9.200	9.950	8.15%
K	1750	BODY	02/01/2016	23.2	22.5	0.100	1051	3022	4.030	37.100	40.300	8.63%
K	1750	BODY	02/10/2016	24.0	22.6	0.100	1051	3022	3.840	37.100	38.400	3.50%
G	1900	BODY	02/08/2016	22.0	21.2	0.100	5d149	3334	4.180	40.400	41.800	3.47%
H	2300	BODY	02/11/2016	23.1	22.2	0.100	1064	3263	4.670	45.500	46.700	2.64%
G	2300	BODY	02/22/2016	23.1	22.6	0.100	1064	3334	4.710	45.500	47.100	3.52%
J	2450	BODY	02/03/2016	22.5	23.0	0.100	719	3319	5.260	51.900	52.600	1.35%
G	2450	BODY	02/16/2016	24.1	23.4	0.100	719	3334	5.060	51.900	50.600	-2.50%
E	5250	BODY	02/08/2016	23.6	22.3	0.050	1191	7308	3.550	77.200	71.000	-8.03%
E	5600	BODY	02/08/2016	23.6	22.3	0.050	1191	7308	4.130	81.900	82.600	0.85%
E	5750	BODY	02/08/2016	23.6	22.3	0.050	1191	7308	3.600	77.100	72.000	-6.61%

FCC ID: ZNFH820		SAR EVALUATION REPORT		Reviewed by: Quality Manager
Document S/N: 0Y1601290203-R5.ZNF	Test Dates: 01/28/16 - 03/03/16	DUT Type: Portable Handset		Page 46 of 82

**Table 10-5
System Verification Results – 10g**

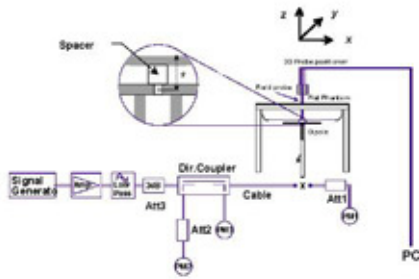

System Verification TARGET & MEASURED												
SAR System #	Tissue Frequency (MHz)	Tissue Type	Date:	Amb. Temp (°C)	Liquid Temp (°C)	Input Power (W)	Dipole SN	Probe SN	Measured SAR _{10g} (W/kg)	1 W Target SAR _{10g} (W/kg)	1 W Normalized SAR _{10g} (W/kg)	Deviation _{10g} (%)
I	750	BODY	02/27/2016	19.8	20.8	0.200	1054	3333	1.140	5.680	5.700	0.35%
J	835	BODY	02/27/2016	20.3	19.2	0.200	4d119	3319	1.210	6.060	6.050	-0.17%
K	1750	BODY	02/27/2016	20.8	20.5	0.100	1051	3022	1.950	20.000	19.500	-2.50%
E	1750	BODY	03/03/2016	24.3	22.2	0.100	1051	3351	2.050	20.000	20.500	2.50%
G	1900	BODY	03/03/2016	22.2	21.4	0.100	5d149	3334	1.990	21.800	19.900	-8.72%
K	2300	BODY	03/03/2016	22.5	21.5	0.100	1064	3022	2.360	22.000	23.600	7.27%
H	2450	BODY	02/26/2016	21.5	22.5	0.100	719	3263	2.310	24.300	23.100	-4.94%



**Figure 10-1
System Verification Setup Diagram**

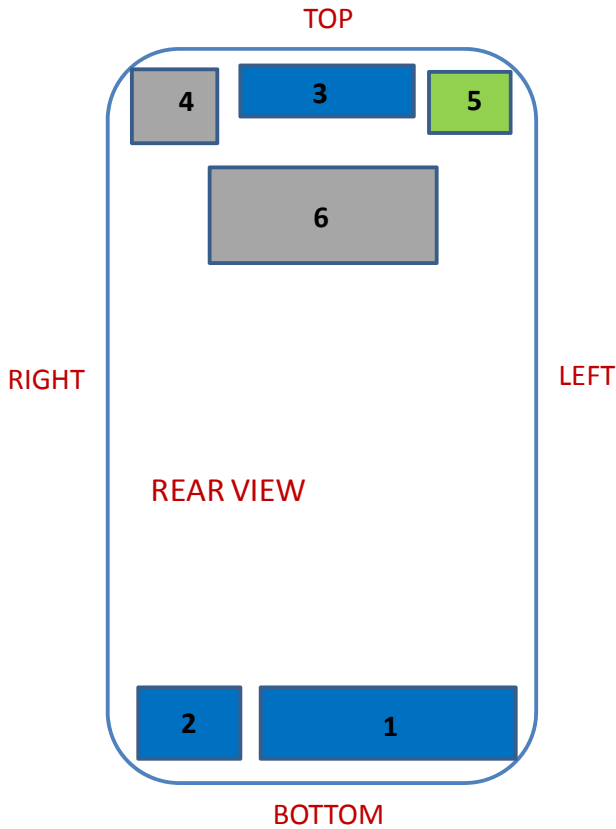

**Figure 10-2
System Verification Setup Photo**



FCC ID: ZNFH820		SAR EVALUATION REPORT		Reviewed by: Quality Manager
Document S/N: 0Y1601290203-R5.ZNF	Test Dates: 01/28/16 - 03/03/16	DUT Type: Portable Handset		Page 47 of 82

11 SAR DATA SUMMARY

11.1 Antenna Locations



1. Antenna 1 (Tx/Rx)
 - GSM/GPRS/EDGE 850 MHz
 - UMTS Band 5
 - LTE Band 5/7/12/17/30
2. Antenna 2 (Tx/Rx)
 - GSM/GPRS/EDGE 1900 MHz
 - UMTS Band 2/4
 - LTE Band 2/4
3. Antenna 3
 - LTE Band 5/12/17/29 (Rx Only)
 - UMTS Band 2/4 (Tx/Rx) (head SAR limited by proximity sensor)
 - LTE Band 2/4 (Tx/Rx) (head SAR limited by proximity sensor)
4. Antenna 4 (Rx only)
 - GPS
 - LTE 7/30
5. Antenna 5 (Tx/Rx)
 - 2.4/5 GHz WIFI
 - 2.4 GHz BT
6. Antenna 6 (Tx/Rx)
 - NFC

FCC ID: ZNFH820		SAR EVALUATION REPORT		Reviewed by: Quality Manager
Document S/N: 0Y1601290203-R5.ZNF	Test Dates: 01/28/16 - 03/03/16	DUT Type: Portable Handset		Page 48 of 82

11.2 Standalone Head SAR Data

**Table 11-1
GSM 850 Head SAR – Ant 1**

MEASUREMENT RESULTS															
FREQUENCY		Mode/Band	Service	Maximum Allowed Power [dBm]	Conducted Power [dBm]	Power Drift [dB]	Side	Test Position	Device Serial Number	# of Time Slots	Duty Cycle	SAR (1g)	Scaling Factor	Reported SAR (1g)	Plot #
MHz	Ch.											(W/kg)		(W/kg)	
836.60	190	GSM 850	GSM	33.2	33.16	0.09	Right	Cheek	08129	1	1:8.3	0.388	1.009	0.391	
836.60	190	GSM 850	GSM	33.2	33.16	-0.01	Right	Tilt	08129	1	1:8.3	0.190	1.009	0.192	
836.60	190	GSM 850	GSM	33.2	33.16	0.04	Left	Cheek	08129	1	1:8.3	0.493	1.009	0.497	
836.60	190	GSM 850	GSM	33.2	33.16	0.21	Left	Tilt	08129	1	1:8.3	0.232	1.009	0.234	
836.60	190	GSM 850	GPRS	29.7	29.60	-0.10	Right	Cheek	08129	3	1:2.76	0.526	1.023	0.538	
836.60	190	GSM 850	GPRS	29.7	29.60	-0.09	Right	Tilt	08129	3	1:2.76	0.365	1.023	0.373	
836.60	190	GSM 850	GPRS	29.7	29.60	-0.04	Left	Cheek	08129	3	1:2.76	0.730	1.023	0.747	A1
836.60	190	GSM 850	GPRS	29.7	29.60	-0.07	Left	Tilt	08129	3	1:2.76	0.325	1.023	0.332	
ANSI / IEEE C95.1 1992 - SAFETY LIMIT Spatial Peak Uncontrolled Exposure/General Population							Head 1.6 W/kg (mW/g) averaged over 1 gram								

**Table 11-2
GSM 850 Head SAR with CM Accessory – Ant 1**

MEASUREMENT RESULTS																
FREQUENCY		Mode/Band	Service	Maximum Allowed Power [dBm]	Conducted Power [dBm]	Power Drift [dB]	Side	Test Position	Accessory	Device Serial Number	# of Time Slots	Duty Cycle	SAR (1g)	Scaling Factor	Reported SAR (1g)	Plot #
MHz	Ch.												(W/kg)		(W/kg)	
836.60	190	GSM 850	GSM	33.2	33.16	0.13	Right	Cheek	Camera Module	08129	1	1:8.3	0.027	1.009	0.027	
836.60	190	GSM 850	GSM	33.2	33.16	0.13	Right	Tilt	Camera Module	08129	1	1:8.3	0.013	1.009	0.013	
836.60	190	GSM 850	GSM	33.2	33.16	0.15	Left	Cheek	Camera Module	08129	1	1:8.3	0.024	1.009	0.024	
836.60	190	GSM 850	GSM	33.2	33.16	0.13	Left	Tilt	Camera Module	08129	1	1:8.3	0.010	1.009	0.010	
836.60	190	GSM 850	GPRS	29.7	29.60	0.19	Right	Cheek	Camera Module	08129	3	1:2.76	0.025	1.023	0.026	
836.60	190	GSM 850	GPRS	29.7	29.60	0.12	Right	Tilt	Camera Module	08129	3	1:2.76	0.013	1.023	0.013	
836.60	190	GSM 850	GPRS	29.7	29.60	0.12	Left	Cheek	Camera Module	08129	3	1:2.76	0.026	1.023	0.027	
836.60	190	GSM 850	GPRS	29.7	29.60	0.19	Left	Tilt	Camera Module	08129	3	1:2.76	0.012	1.023	0.012	
ANSI / IEEE C95.1 1992 - SAFETY LIMIT Spatial Peak Uncontrolled Exposure/General Population							Head 1.6 W/kg (mW/g) averaged over 1 gram									

**Table 11-3
UMTS 850 Head SAR – Ant 1**

MEASUREMENT RESULTS															
FREQUENCY		Mode/Band	Service	Maximum Allowed Power [dBm]	Conducted Power [dBm]	Power Drift [dB]	Side	Test Position	Device Serial Number	Duty Cycle	SAR (1g)	Scaling Factor	Reported SAR (1g)	Plot #	
MHz	Ch.										(W/kg)		(W/kg)		
836.60	4183	UMTS 850	RMC	24.2	24.11	-0.01	Right	Cheek	08129	1:1	0.275	1.021	0.281		
836.60	4183	UMTS 850	RMC	24.2	24.11	0.04	Right	Tilt	08129	1:1	0.236	1.021	0.241		
836.60	4183	UMTS 850	RMC	24.2	24.11	0.01	Left	Cheek	08129	1:1	0.397	1.021	0.405	A2	
836.60	4183	UMTS 850	RMC	24.2	24.11	0.07	Left	Tilt	08129	1:1	0.186	1.021	0.190		
ANSI / IEEE C95.1 1992 - SAFETY LIMIT Spatial Peak Uncontrolled Exposure/General Population							Head 1.6 W/kg (mW/g) averaged over 1 gram								



FCC ID: ZNFH820		SAR EVALUATION REPORT		Reviewed by: Quality Manager
Document S/N: 0Y1601290203-R5.ZNF	Test Dates: 01/28/16 - 03/03/16	DUT Type: Portable Handset		Page 49 of 82

Table 11-4
UMTS 850 Head SAR with CM Accessory – Ant 1

MEASUREMENT RESULTS															
FREQUENCY		Mode/Band	Service	Maximum Allowed Power [dBm]	Conducted Power [dBm]	Power Drift [dB]	Side	Test Position	Accessory	Device Serial Number	Duty Cycle	SAR (1g)	Scaling Factor	Reported SAR (1g)	Plot #
MHz	Ch.											(W/kg)		(W/kg)	
836.60	4183	UMTS 850	RMC	24.2	24.11	0.11	Right	Cheek	Camera Module	08129	1:1	0.022	1.021	0.022	
836.60	4183	UMTS 850	RMC	24.2	24.11	0.10	Right	Tilt	Camera Module	08129	1:1	0.010	1.021	0.010	
836.60	4183	UMTS 850	RMC	24.2	24.11	0.13	Left	Cheek	Camera Module	08129	1:1	0.024	1.021	0.025	
836.60	4183	UMTS 850	RMC	24.2	24.11	0.13	Left	Tilt	Camera Module	08129	1:1	0.006	1.021	0.006	
ANSI / IEEE C95.1 1992 - SAFETY LIMIT Spatial Peak Uncontrolled Exposure/General Population						Head 1.6 W/kg (mW/g) averaged over 1 gram									

Table 11-5
UMTS 1750 Head SAR – Ant 2



MEASUREMENT RESULTS															
FREQUENCY		Mode/Band	Service	Maximum Allowed Power [dBm]	Conducted Power [dBm]	Power Drift [dB]	Side	Test Position	Device Serial Number	Duty Cycle	SAR (1g)	Scaling Factor	Reported SAR (1g)	Plot #	
MHz	Ch.										(W/kg)		(W/kg)		
1732.40	1412	UMTS 1750	RMC	24.2	24.20	-0.04	Right	Cheek	08103	1:1	0.638	1.000	0.638	A3	
1732.40	1412	UMTS 1750	RMC	24.2	24.20	0.02	Right	Tilt	08103	1:1	0.217	1.000	0.217		
1732.40	1412	UMTS 1750	RMC	24.2	24.20	0.07	Left	Cheek	08103	1:1	0.345	1.000	0.345		
1732.40	1412	UMTS 1750	RMC	24.2	24.20	0.07	Left	Tilt	08103	1:1	0.248	1.000	0.248		
ANSI / IEEE C95.1 1992 - SAFETY LIMIT Spatial Peak Uncontrolled Exposure/General Population						Head 1.6 W/kg (mW/g) averaged over 1 gram									

Note: All voice/data transmission from diversity antenna 3 is always disabled for all held-to-ear conditions. Per FCC Guidance, held-to-ear SAR was not required for Antenna 3.

Table 11-6
UMTS 1750 Head SAR with CM Accessory – Ant 2

MEASUREMENT RESULTS															
FREQUENCY		Mode/Band	Service	Maximum Allowed Power [dBm]	Conducted Power [dBm]	Power Drift [dB]	Side	Test Position	Accessory	Device Serial Number	Duty Cycle	SAR (1g)	Scaling Factor	Reported SAR (1g)	Plot #
MHz	Ch.											(W/kg)		(W/kg)	
1732.40	1412	UMTS 1750	RMC	24.2	24.20	0.09	Right	Cheek	Camera Module	08103	1:1	0.311	1.000	0.311	
1732.40	1412	UMTS 1750	RMC	24.2	24.20	0.02	Right	Tilt	Camera Module	08103	1:1	0.189	1.000	0.189	
1732.40	1412	UMTS 1750	RMC	24.2	24.20	0.06	Left	Cheek	Camera Module	08103	1:1	0.263	1.000	0.263	
1732.40	1412	UMTS 1750	RMC	24.2	24.20	0.04	Left	Tilt	Camera Module	08103	1:1	0.168	1.000	0.168	
ANSI / IEEE C95.1 1992 - SAFETY LIMIT Spatial Peak Uncontrolled Exposure/General Population						Head 1.6 W/kg (mW/g) averaged over 1 gram									

Note: All voice/data transmission from diversity antenna 3 is always disabled for all held-to-ear conditions. Per FCC Guidance, held-to-ear SAR was not required for Antenna 3.

FCC ID: ZNFH820		SAR EVALUATION REPORT		Reviewed by: Quality Manager
Document S/N: 0Y1601290203-R5.ZNF	Test Dates: 01/28/16 - 03/03/16	DUT Type: Portable Handset	Page 50 of 82	

**Table 11-7
GSM 1900 Head SAR – Ant 1**

MEASUREMENT RESULTS															
FREQUENCY		Mode/Band	Service	Maximum Allowed Power [dBm]	Conducted Power [dBm]	Power Drift [dB]	Side	Test Position	Device Serial Number	# of Time Slots	Duty Cycle	SAR (1g)	Scaling Factor	Reported SAR (1g)	Plot #
MHz	Ch.											(W/kg)		(W/kg)	
1880.00	661	GSM 1900	GSM	30.7	30.68	0.07	Right	Cheek	08129	1	1:8.3	0.247	1.005	0.248	A4
1880.00	661	GSM 1900	GSM	30.7	30.68	0.00	Right	Tilt	08129	1	1:8.3	0.068	1.005	0.068	
1880.00	661	GSM 1900	GSM	30.7	30.68	0.01	Left	Cheek	08129	1	1:8.3	0.137	1.005	0.138	
1880.00	661	GSM 1900	GSM	30.7	30.68	-0.06	Left	Tilt	08129	1	1:8.3	0.073	1.005	0.073	
1880.00	661	GSM 1900	GPRS	25.7	25.66	-0.14	Right	Cheek	08129	4	1:2.076	0.239	1.009	0.241	
1880.00	661	GSM 1900	GPRS	25.7	25.66	0.01	Right	Tilt	08129	4	1:2.076	0.068	1.009	0.069	
1880.00	661	GSM 1900	GPRS	25.7	25.66	-0.15	Left	Cheek	08129	4	1:2.076	0.116	1.009	0.117	
1880.00	661	GSM 1900	GPRS	25.7	25.66	0.02	Left	Tilt	08129	4	1:2.076	0.060	1.009	0.061	
ANSI / IEEE C95.1 1992 - SAFETY LIMIT Spatial Peak Uncontrolled Exposure/General Population							Head 1.6 W/kg (mW/g) averaged over 1 gram								

**Table 11-8
GSM 1900 Head SAR with CM Accessory – Ant 1**

MEASUREMENT RESULTS																
FREQUENCY		Mode/Band	Service	Maximum Allowed Power [dBm]	Conducted Power [dBm]	Power Drift [dB]	Side	Test Position	Accessory	Device Serial Number	# of Time Slots	Duty Cycle	SAR (1g)	Scaling Factor	Reported SAR (1g)	Plot #
MHz	Ch.												(W/kg)		(W/kg)	
1880.00	661	GSM 1900	GSM	30.7	30.68	0.08	Right	Cheek	Camera Module	08129	1	1:8.3	0.066	1.005	0.066	
1880.00	661	GSM 1900	GSM	30.7	30.68	-0.09	Right	Tilt	Camera Module	08129	1	1:8.3	0.041	1.005	0.041	
1880.00	661	GSM 1900	GSM	30.7	30.68	0.12	Left	Cheek	Camera Module	08129	1	1:8.3	0.063	1.005	0.063	
1880.00	661	GSM 1900	GSM	30.7	30.68	0.16	Left	Tilt	Camera Module	08129	1	1:8.3	0.024	1.005	0.024	
1880.00	661	GSM 1900	GPRS	25.7	25.66	-0.01	Right	Cheek	Camera Module	08129	4	1:2.076	0.062	1.009	0.063	
1880.00	661	GSM 1900	GPRS	25.7	25.66	0.12	Right	Tilt	Camera Module	08129	4	1:2.076	0.043	1.009	0.043	
1880.00	661	GSM 1900	GPRS	25.7	25.66	0.00	Left	Cheek	Camera Module	08129	4	1:2.076	0.062	1.009	0.063	
1880.00	661	GSM 1900	GPRS	25.7	25.66	0.18	Left	Tilt	Camera Module	08129	4	1:2.076	0.022	1.009	0.022	
ANSI / IEEE C95.1 1992 - SAFETY LIMIT Spatial Peak Uncontrolled Exposure/General Population							Head 1.6 W/kg (mW/g) averaged over 1 gram									

**Table 11-9
UMTS 1900 Head SAR – Ant 2**

MEASUREMENT RESULTS														
FREQUENCY		Mode/Band	Service	Maximum Allowed Power [dBm]	Conducted Power [dBm]	Power Drift [dB]	Side	Test Position	Device Serial Number	Duty Cycle	SAR (1g)	Scaling Factor	Reported SAR (1g)	Plot #
MHz	Ch.										(W/kg)		(W/kg)	
1880.00	9400	UMTS 1900	RMC	24.7	24.59	0.07	Right	Cheek	08129	1:1	0.614	1.026	0.630	A5
1880.00	9400	UMTS 1900	RMC	24.7	24.59	-0.02	Right	Tilt	08129	1:1	0.191	1.026	0.196	
1880.00	9400	UMTS 1900	RMC	24.7	24.59	0.01	Left	Cheek	08129	1:1	0.336	1.026	0.345	
1880.00	9400	UMTS 1900	RMC	24.7	24.59	0.07	Left	Tilt	08129	1:1	0.186	1.026	0.191	
ANSI / IEEE C95.1 1992 - SAFETY LIMIT Spatial Peak Uncontrolled Exposure/General Population							Head 1.6 W/kg (mW/g) averaged over 1 gram							

Note: All voice/data transmission from diversity antenna 3 is always disabled for all held-to-ear conditions. Per FCC Guidance, held-to-ear SAR was not required for Antenna 3.



FCC ID: ZNFH820		SAR EVALUATION REPORT		Reviewed by: Quality Manager
Document S/N: 0Y1601290203-R5.ZNF	Test Dates: 01/28/16 - 03/03/16	DUT Type: Portable Handset	Page 51 of 82	

Table 11-10
UMTS 1900 Head SAR with CM Accessory – Ant 2

MEASUREMENT RESULTS															
FREQUENCY		Mode/Band	Service	Maximum Allowed Power [dBm]	Conducted Power [dBm]	Power Drift [dB]	Side	Test Position	Accessory	Device Serial Number	Duty Cycle	SAR (1g)	Scaling Factor	Reported SAR (1g)	Plot #
MHz	Ch.											(W/kg)		(W/kg)	
1880.00	9400	UMTS 1900	RMC	24.7	24.59	0.00	Right	Cheek	Camera Module	08129	1:1	0.211	1.026	0.216	
1880.00	9400	UMTS 1900	RMC	24.7	24.59	-0.12	Right	Tilt	Camera Module	08129	1:1	0.149	1.026	0.153	
1880.00	9400	UMTS 1900	RMC	24.7	24.59	-0.01	Left	Cheek	Camera Module	08129	1:1	0.202	1.026	0.207	
1880.00	9400	UMTS 1900	RMC	24.7	24.59	0.19	Left	Tilt	Camera Module	08129	1:1	0.089	1.026	0.091	
ANSI / IEEE C95.1 1992 - SAFETY LIMIT Spatial Peak Uncontrolled Exposure/General Population							Head 1.6 W/kg (mW/g) averaged over 1 gram								

Note: All voice/data transmission from diversity antenna 3 is always disabled for all held-to-ear conditions. Per FCC Guidance, held-to-ear SAR was not required for Antenna 3.

Table 11-11
LTE Band 12 Head SAR – Ant 1

MEASUREMENT RESULTS																			
FREQUENCY		Mode	Bandwidth [MHz]	Maximum Allowed Power [dBm]	Conducted Power [dBm]	Power Drift [dB]	MPR [dB]	Side	Test Position	Modulation	RB Size	RB Offset	Device Serial Number	Duty Cycle	SAR (1g)	Scaling Factor	Reported SAR (1g)	Plot #	
MHz	Ch.														(W/kg)		(W/kg)		
707.50	23095	Mid	LTE Band 12	10	24.7	24.67	-0.10	0	Right	Cheek	QPSK	1	0	08038	1:1	0.176	1.007	0.177	
707.50	23095	Mid	LTE Band 12	10	23.7	23.65	0.07	1	Right	Cheek	QPSK	25	12	08038	1:1	0.138	1.012	0.140	
707.50	23095	Mid	LTE Band 12	10	24.7	24.67	-0.08	0	Right	Tilt	QPSK	1	0	08038	1:1	0.155	1.007	0.156	
707.50	23095	Mid	LTE Band 12	10	23.7	23.65	0.07	1	Right	Tilt	QPSK	25	12	08038	1:1	0.118	1.012	0.119	
707.50	23095	Mid	LTE Band 12	10	24.7	24.67	0.00	0	Left	Cheek	QPSK	1	0	08038	1:1	0.231	1.007	0.233	A6
707.50	23095	Mid	LTE Band 12	10	23.7	23.65	0.03	1	Left	Cheek	QPSK	25	12	08038	1:1	0.172	1.012	0.174	
707.50	23095	Mid	LTE Band 12	10	24.7	24.67	0.04	0	Left	Tilt	QPSK	1	0	08038	1:1	0.087	1.007	0.088	
707.50	23095	Mid	LTE Band 12	10	23.7	23.65	0.09	1	Left	Tilt	QPSK	25	12	08038	1:1	0.069	1.012	0.070	
ANSI / IEEE C95.1 1992 - SAFETY LIMIT Spatial Peak Uncontrolled Exposure/General Population							Head 1.6 W/kg (mW/g) averaged over 1 gram												

This device supports both LTE Band 12 and LTE Band 17. Since the supported frequency span for LTE Band 17 falls completely within the supported frequency span for LTE Band 12, both LTE bands have the same target power, and both LTE bands share the same transmission path, SAR was only assessed for LTE Band 12.

Table 11-12
LTE Band 12 Head SAR with CM Accessory – Ant 1

MEASUREMENT RESULTS																				
FREQUENCY		Mode	Bandwidth [MHz]	Maximum Allowed Power [dBm]	Conducted Power [dBm]	Power Drift [dB]	MPR [dB]	Side	Test Position	Accessory	Modulation	RB Size	RB Offset	Device Serial Number	Duty Cycle	SAR (1g)	Scaling Factor	Reported SAR (1g)	Plot #	
MHz	Ch.															(W/kg)		(W/kg)		
707.50	23095	Mid	LTE Band 12	10	24.7	24.67	0.14	0	Right	Cheek	Camera Module	QPSK	1	0	08038	1:1	0.086	1.007	0.087	
707.50	23095	Mid	LTE Band 12	10	23.7	23.65	0.07	1	Right	Cheek	Camera Module	QPSK	25	12	08038	1:1	0.070	1.012	0.071	
707.50	23095	Mid	LTE Band 12	10	24.7	24.67	-0.02	0	Right	Tilt	Camera Module	QPSK	1	0	08038	1:1	0.060	1.007	0.060	
707.50	23095	Mid	LTE Band 12	10	23.7	23.65	0.09	1	Right	Tilt	Camera Module	QPSK	25	12	08038	1:1	0.044	1.012	0.045	
707.50	23095	Mid	LTE Band 12	10	24.7	24.67	0.02	0	Left	Cheek	Camera Module	QPSK	1	0	08038	1:1	0.087	1.007	0.088	
707.50	23095	Mid	LTE Band 12	10	23.7	23.65	0.14	1	Left	Cheek	Camera Module	QPSK	25	12	08038	1:1	0.068	1.012	0.069	
707.50	23095	Mid	LTE Band 12	10	24.7	24.67	0.06	0	Left	Tilt	Camera Module	QPSK	1	0	08038	1:1	0.048	1.007	0.048	
707.50	23095	Mid	LTE Band 12	10	23.7	23.65	0.08	1	Left	Tilt	Camera Module	QPSK	25	12	08038	1:1	0.034	1.012	0.034	
ANSI / IEEE C95.1 1992 - SAFETY LIMIT Spatial Peak Uncontrolled Exposure/General Population							Head 1.6 W/kg (mW/g) averaged over 1 gram													

This device supports both LTE Band 12 and LTE Band 17. Since the supported frequency span for LTE Band 17 falls completely within the supported frequency span for LTE Band 12, both LTE bands have the same target power, and both LTE bands share the same transmission path, SAR was only assessed for LTE Band 12.



FCC ID: ZNFH820		SAR EVALUATION REPORT		Reviewed by: Quality Manager
Document S/N: 0Y1601290203-R5.ZNF	Test Dates: 01/28/16 - 03/03/16	DUT Type: Portable Handset	Page 52 of 82	

Table 11-13
LTE Band 5 (Cell) Head SAR – Ant 1

MEASUREMENT RESULTS																			
FREQUENCY		Mode	Bandwidth [MHz]	Maximum Allowed Power [dBm]	Conducted Power [dBm]	Power Drift [dB]	MPR [dB]	Side	Test Position	Modulation	RB Size	RB Offset	Device Serial Number	Duty Cycle	SAR (1g)	Scaling Factor	Reported SAR (1g)	Plot #	
MHz	Ch.														(W/kg)		(W/kg)		
836.50	20525	Mid	LTE Band 5 (Cell)	10	24.2	24.11	0.02	0	Right	Cheek	QPSK	1	25	08038	1:1	0.276	1.021	0.282	
836.50	20525	Mid	LTE Band 5 (Cell)	10	23.2	23.18	-0.02	1	Right	Cheek	QPSK	25	0	08038	1:1	0.214	1.005	0.215	
836.50	20525	Mid	LTE Band 5 (Cell)	10	24.2	24.11	0.10	0	Right	Tilt	QPSK	1	25	08038	1:1	0.101	1.021	0.103	
836.50	20525	Mid	LTE Band 5 (Cell)	10	23.2	23.18	0.04	1	Right	Tilt	QPSK	25	0	08038	1:1	0.104	1.005	0.105	
836.50	20525	Mid	LTE Band 5 (Cell)	10	24.2	24.11	-0.01	0	Left	Cheek	QPSK	1	25	08038	1:1	0.376	1.021	0.384	A7
836.50	20525	Mid	LTE Band 5 (Cell)	10	23.2	23.18	-0.08	1	Left	Cheek	QPSK	25	0	08038	1:1	0.293	1.005	0.294	
836.50	20525	Mid	LTE Band 5 (Cell)	10	24.2	24.11	-0.01	0	Left	Tilt	QPSK	1	25	08038	1:1	0.123	1.021	0.126	
836.50	20525	Mid	LTE Band 5 (Cell)	10	23.2	23.18	0.07	1	Left	Tilt	QPSK	25	0	08038	1:1	0.096	1.005	0.096	
ANSI / IEEE C95.1 1992 - SAFETY LIMIT Spatial Peak Uncontrolled Exposure/General Population											Head 1.6 W/kg (mW/g) averaged over 1 gram								



Table 11-14
LTE Band 5 (Cell) Head SAR with CM Accessory – Ant 1

MEASUREMENT RESULTS																				
FREQUENCY		Mode	Bandwidth [MHz]	Maximum Allowed Power [dBm]	Conducted Power [dBm]	Power Drift [dB]	MPR [dB]	Side	Test Position	Accessory	Modulation	RB Size	RB Offset	Device Serial Number	Duty Cycle	SAR (1g)	Scaling Factor	Reported SAR (1g)	Plot #	
MHz	Ch.															(W/kg)		(W/kg)		
836.50	20525	Mid	LTE Band 5 (Cell)	10	24.2	24.11	0.16	0	Right	Cheek	Camera Module	QPSK	1	25	08038	1:1	0.020	1.021	0.020	
836.50	20525	Mid	LTE Band 5 (Cell)	10	23.2	23.18	0.11	1	Right	Cheek	Camera Module	QPSK	25	0	08038	1:1	0.015	1.005	0.015	
836.50	20525	Mid	LTE Band 5 (Cell)	10	24.2	24.11	0.15	0	Right	Tilt	Camera Module	QPSK	1	25	08038	1:1	0.008	1.021	0.008	
836.50	20525	Mid	LTE Band 5 (Cell)	10	23.2	23.18	0.19	1	Right	Tilt	Camera Module	QPSK	25	0	08038	1:1	0.006	1.005	0.006	
836.50	20525	Mid	LTE Band 5 (Cell)	10	24.2	24.11	0.19	0	Left	Cheek	Camera Module	QPSK	1	25	08038	1:1	0.022	1.021	0.022	
836.50	20525	Mid	LTE Band 5 (Cell)	10	23.2	23.18	0.18	1	Left	Cheek	Camera Module	QPSK	25	0	08038	1:1	0.018	1.005	0.018	
836.50	20525	Mid	LTE Band 5 (Cell)	10	24.2	24.11	0.19	0	Left	Tilt	Camera Module	QPSK	1	25	08038	1:1	0.007	1.021	0.007	
836.50	20525	Mid	LTE Band 5 (Cell)	10	23.2	23.18	0.15	1	Left	Tilt	Camera Module	QPSK	25	0	08038	1:1	0.006	1.005	0.006	
ANSI / IEEE C95.1 1992 - SAFETY LIMIT Spatial Peak Uncontrolled Exposure/General Population											Head 1.6 W/kg (mW/g) averaged over 1 gram									

Table 11-15
LTE Band 4 (AWS) Head SAR – Ant 2

MEASUREMENT RESULTS																			
FREQUENCY		Mode	Bandwidth [MHz]	Maximum Allowed Power [dBm]	Conducted Power [dBm]	Power Drift [dB]	MPR [dB]	Side	Test Position	Modulation	RB Size	RB Offset	Device Serial Number	Duty Cycle	SAR (1g)	Scaling Factor	Reported SAR (1g)	Plot #	
MHz	Ch.														(W/kg)		(W/kg)		
1732.50	20175	Mid	LTE Band 4 (AWS)	20	24.7	24.60	0.16	0	Right	Cheek	QPSK	1	0	08038	1:1	0.740	1.023	0.757	A8
1732.50	20175	Mid	LTE Band 4 (AWS)	20	23.7	23.63	0.01	1	Right	Cheek	QPSK	50	25	08038	1:1	0.484	1.016	0.492	
1732.50	20175	Mid	LTE Band 4 (AWS)	20	24.7	24.60	0.09	0	Right	Tilt	QPSK	1	0	08038	1:1	0.227	1.023	0.232	
1732.50	20175	Mid	LTE Band 4 (AWS)	20	23.7	23.63	0.04	1	Right	Tilt	QPSK	50	25	08038	1:1	0.154	1.016	0.156	
1732.50	20175	Mid	LTE Band 4 (AWS)	20	24.7	24.60	0.15	0	Left	Cheek	QPSK	1	0	08038	1:1	0.388	1.023	0.397	
1732.50	20175	Mid	LTE Band 4 (AWS)	20	23.7	23.63	0.05	1	Left	Cheek	QPSK	50	25	08038	1:1	0.240	1.016	0.244	
1732.50	20175	Mid	LTE Band 4 (AWS)	20	24.7	24.60	-0.03	0	Left	Tilt	QPSK	1	0	08038	1:1	0.247	1.023	0.253	
1732.50	20175	Mid	LTE Band 4 (AWS)	20	23.7	23.63	0.09	1	Left	Tilt	QPSK	50	25	08038	1:1	0.154	1.016	0.156	
ANSI / IEEE C95.1 1992 - SAFETY LIMIT Spatial Peak Uncontrolled Exposure/General Population											Head 1.6 W/kg (mW/g) averaged over 1 gram								

Note: All voice/data transmission from diversity antenna 3 is always disabled for all held-to-ear conditions. Per FCC Guidance, held-to-ear SAR was not required for Antenna 3.

FCC ID: ZNFH820		SAR EVALUATION REPORT		Reviewed by: Quality Manager
Document S/N: 0Y1601290203-R5.ZNF	Test Dates: 01/28/16 - 03/03/16	DUT Type: Portable Handset		Page 53 of 82

**Table 11-16
LTE Band 4 (AWS) Head SAR with CM Accessory – Ant 2**

MEASUREMENT RESULTS																				
FREQUENCY		Mode	Bandwidth [MHz]	Maximum Allowed Power [dBm]	Conducted Power [dBm]	Power Drift [dB]	MPR [dB]	Side	Test Position	Accessory	Modulation	RB Size	RB Offset	Device Serial Number	Duty Cycle	SAR (1g) (W/kg)	Scaling Factor	Reported SAR (1g) (W/kg)	Plot #	
MHz	Ch.																			
1732.50	20175	Mid	LTE Band 4 (AWS)	20	24.7	24.60	-0.06	0	Right	Cheek	Camera Module	QPSK	1	0	08038	1:1	0.444	1.023	0.454	
1732.50	20175	Mid	LTE Band 4 (AWS)	20	23.7	23.63	0.00	1	Right	Cheek	Camera Module	QPSK	50	25	08038	1:1	0.271	1.016	0.275	
1732.50	20175	Mid	LTE Band 4 (AWS)	20	24.7	24.60	-0.06	0	Right	Tilt	Camera Module	QPSK	1	0	08038	1:1	0.252	1.023	0.258	
1732.50	20175	Mid	LTE Band 4 (AWS)	20	23.7	23.63	-0.09	1	Right	Tilt	Camera Module	QPSK	50	25	08038	1:1	0.164	1.016	0.167	
1732.50	20175	Mid	LTE Band 4 (AWS)	20	24.7	24.60	0.06	0	Left	Cheek	Camera Module	QPSK	1	0	08038	1:1	0.340	1.023	0.348	
1732.50	20175	Mid	LTE Band 4 (AWS)	20	23.7	23.63	-0.04	1	Left	Cheek	Camera Module	QPSK	50	25	08038	1:1	0.215	1.016	0.218	
1732.50	20175	Mid	LTE Band 4 (AWS)	20	24.7	24.60	-0.01	0	Left	Tilt	Camera Module	QPSK	1	0	08038	1:1	0.205	1.023	0.210	
1732.50	20175	Mid	LTE Band 4 (AWS)	20	23.7	23.63	-0.03	1	Left	Tilt	Camera Module	QPSK	50	25	08038	1:1	0.124	1.016	0.126	
ANSI / IEEE C95.1 1992 - SAFETY LIMIT Spatial Peak Uncontrolled Exposure/General Population										Head 1.6 W/kg (mW/g) averaged over 1 gram										

Note: All voice/data transmission from diversity antenna 3 is always disabled for all held-to-ear conditions. Per FCC Guidance, held-to-ear SAR was not required for Antenna 3.

**Table 11-17
LTE Band 2 (PCS) Head SAR – Ant 2**



MEASUREMENT RESULTS																			
FREQUENCY		Mode	Bandwidth [MHz]	Maximum Allowed Power [dBm]	Conducted Power [dBm]	Power Drift [dB]	MPR [dB]	Side	Test Position	Modulation	RB Size	RB Offset	Device Serial Number	Duty Cycle	SAR (1g) (W/kg)	Scaling Factor	Reported SAR (1g) (W/kg)	Plot #	
MHz	Ch.																		
1860.00	18700	Low	LTE Band 2 (PCS)	20	24.7	24.60	0.04	0	Right	Cheek	QPSK	1	50	08137	1:1	0.753	1.023	0.770	
1880.00	18900	Mid	LTE Band 2 (PCS)	20	24.7	24.65	0.06	0	Right	Cheek	QPSK	1	0	08137	1:1	0.793	1.012	0.803	
1900.00	19100	High	LTE Band 2 (PCS)	20	24.7	24.70	0.05	0	Right	Cheek	QPSK	1	99	08137	1:1	0.821	1.000	0.821	A9
1900.00	19100	High	LTE Band 2 (PCS)	20	23.7	23.67	-0.10	1	Right	Cheek	QPSK	50	50	08137	1:1	0.618	1.007	0.622	
1900.00	19100	High	LTE Band 2 (PCS)	20	23.7	23.63	-0.03	1	Right	Cheek	QPSK	100	0	08137	1:1	0.632	1.016	0.642	
1900.00	19100	High	LTE Band 2 (PCS)	20	24.7	24.70	-0.19	0	Right	Tilt	QPSK	1	99	08137	1:1	0.269	1.000	0.269	
1900.00	19100	High	LTE Band 2 (PCS)	20	23.7	23.67	0.02	1	Right	Tilt	QPSK	50	50	08137	1:1	0.218	1.007	0.220	
1900.00	19100	High	LTE Band 2 (PCS)	20	24.7	24.70	0.17	0	Left	Cheek	QPSK	1	99	08137	1:1	0.387	1.000	0.387	
1900.00	19100	High	LTE Band 2 (PCS)	20	23.7	23.67	-0.03	1	Left	Cheek	QPSK	50	50	08137	1:1	0.289	1.007	0.291	
1900.00	19100	High	LTE Band 2 (PCS)	20	24.7	24.70	-0.03	0	Left	Tilt	QPSK	1	99	08137	1:1	0.257	1.000	0.257	
1900.00	19100	High	LTE Band 2 (PCS)	20	23.7	23.67	0.00	1	Left	Tilt	QPSK	50	50	08137	1:1	0.204	1.007	0.205	
ANSI / IEEE C95.1 1992 - SAFETY LIMIT Spatial Peak Uncontrolled Exposure/General Population										Head 1.6 W/kg (mW/g) averaged over 1 gram									

Note: All voice/data transmission from diversity antenna 3 is always disabled for all held-to-ear conditions. Per FCC Guidance, held-to-ear SAR was not required for Antenna 3.
Note: SAR highlighted in orange above is the highest SAR per exposure condition and equipment class to be listed on the grants.

**Table 11-18
LTE Band 2 (PCS) Head SAR with CM Accessory – Ant 2**

MEASUREMENT RESULTS																				
FREQUENCY		Mode	Bandwidth [MHz]	Maximum Allowed Power [dBm]	Conducted Power [dBm]	Power Drift [dB]	MPR [dB]	Side	Test Position	Accessory	Modulation	RB Size	RB Offset	Device Serial Number	Duty Cycle	SAR (1g) (W/kg)	Scaling Factor	Reported SAR (1g) (W/kg)	Plot #	
MHz	Ch.																			
1900.00	19100	High	LTE Band 2 (PCS)	20	24.7	24.70	-0.05	0	Right	Cheek	Camera Module	QPSK	1	99	08137	1:1	0.379	1.000	0.379	
1900.00	19100	High	LTE Band 2 (PCS)	20	23.7	23.67	-0.03	1	Right	Cheek	Camera Module	QPSK	50	50	08137	1:1	0.277	1.007	0.279	
1900.00	19100	High	LTE Band 2 (PCS)	20	24.7	24.70	0.02	0	Right	Tilt	Camera Module	QPSK	1	99	08137	1:1	0.187	1.000	0.187	
1900.00	19100	High	LTE Band 2 (PCS)	20	23.7	23.67	0.01	1	Right	Tilt	Camera Module	QPSK	50	50	08137	1:1	0.139	1.007	0.140	
1900.00	19100	High	LTE Band 2 (PCS)	20	24.7	24.70	0.17	0	Left	Cheek	Camera Module	QPSK	1	99	08137	1:1	0.224	1.000	0.224	
1900.00	19100	High	LTE Band 2 (PCS)	20	23.7	23.67	0.10	1	Left	Cheek	Camera Module	QPSK	50	50	08137	1:1	0.179	1.007	0.180	
1900.00	19100	High	LTE Band 2 (PCS)	20	24.7	24.70	0.04	0	Left	Tilt	Camera Module	QPSK	1	99	08137	1:1	0.126	1.000	0.126	
1900.00	19100	High	LTE Band 2 (PCS)	20	23.7	23.67	0.09	1	Left	Tilt	Camera Module	QPSK	50	50	08137	1:1	0.086	1.007	0.087	
ANSI / IEEE C95.1 1992 - SAFETY LIMIT Spatial Peak Uncontrolled Exposure/General Population										Head 1.6 W/kg (mW/g) averaged over 1 gram										

Note: All voice/data transmission from diversity antenna 3 is always disabled for all held-to-ear conditions. Per FCC Guidance, held-to-ear SAR was not required for Antenna 3.

FCC ID: ZNFH820		SAR EVALUATION REPORT		Reviewed by: Quality Manager
Document S/N: 0Y1601290203-R5.ZNF	Test Dates: 01/28/16 - 03/03/16	DUT Type: Portable Handset	Page 54 of 82	

**Table 11-19
LTE Band 30 Head SAR – Ant 1**



MEASUREMENT RESULTS																			
FREQUENCY		Mode	Bandwidth [MHz]	Maximum Allowed Power [dBm]	Conducted Power [dBm]	Power Drift [dB]	MPR [dB]	Side	Test Position	Modulation	RB Size	RB Offset	Device Serial Number	Duty Cycle	SAR (1g)	Scaling Factor	Reported SAR (1g)	Plot #	
MHz	Ch.														(W/kg)		(W/kg)		
2310.00	27710	Mid	LTE Band 30	10	23.7	23.70	0.15	0	Right	Cheek	QPSK	1	0	08038	1:1	0.053	1.000	0.053	
2310.00	27710	Mid	LTE Band 30	10	22.7	22.62	0.02	1	Right	Cheek	QPSK	25	25	08038	1:1	0.040	1.019	0.041	
2310.00	27710	Mid	LTE Band 30	10	23.7	23.70	0.07	0	Right	Tilt	QPSK	1	0	08038	1:1	0.057	1.000	0.057	
2310.00	27710	Mid	LTE Band 30	10	22.7	22.62	0.06	1	Right	Tilt	QPSK	25	25	08038	1:1	0.041	1.019	0.042	
2310.00	27710	Mid	LTE Band 30	10	23.7	23.70	0.06	0	Left	Cheek	QPSK	1	0	08038	1:1	0.120	1.000	0.120	
2310.00	27710	Mid	LTE Band 30	10	22.7	22.62	0.06	1	Left	Cheek	QPSK	25	25	08038	1:1	0.096	1.019	0.098	
2310.00	27710	Mid	LTE Band 30	10	23.7	23.70	-0.01	0	Left	Tilt	QPSK	1	0	08038	1:1	0.037	1.000	0.037	
2310.00	27710	Mid	LTE Band 30	10	22.7	22.62	0.12	1	Left	Tilt	QPSK	25	25	08038	1:1	0.030	1.019	0.031	
ANSI / IEEE C95.1 1992 - SAFETY LIMIT Spatial Peak Uncontrolled Exposure/General Population										Head 1.6 W/kg (mW/g) averaged over 1 gram									

**Table 11-20
LTE Band 30 Head SAR with CM Accessory – Ant 1**

MEASUREMENT RESULTS																				
FREQUENCY		Mode	Bandwidth [MHz]	Maximum Allowed Power [dBm]	Conducted Power [dBm]	Power Drift [dB]	MPR [dB]	Side	Test Position	Accessory	Modulation	RB Size	RB Offset	Device Serial Number	Duty Cycle	SAR (1g)	Scaling Factor	Reported SAR (1g)	Plot #	
MHz	Ch.															(W/kg)		(W/kg)		
2310.00	27710	Mid	LTE Band 30	10	23.7	23.70	-0.01	0	Right	Cheek	Camera Module	QPSK	1	0	08038	1:1	0.156	1.000	0.156	A10
2310.00	27710	Mid	LTE Band 30	10	22.7	22.62	0.14	1	Right	Cheek	Camera Module	QPSK	25	25	08038	1:1	0.108	1.019	0.110	
2310.00	27710	Mid	LTE Band 30	10	23.7	23.70	0.20	0	Right	Tilt	Camera Module	QPSK	1	0	08038	1:1	0.081	1.000	0.081	
2310.00	27710	Mid	LTE Band 30	10	22.7	22.62	0.19	1	Right	Tilt	Camera Module	QPSK	25	25	08038	1:1	0.067	1.019	0.068	
2310.00	27710	Mid	LTE Band 30	10	23.7	23.70	0.19	0	Left	Cheek	Camera Module	QPSK	1	0	08038	1:1	0.123	1.000	0.123	
2310.00	27710	Mid	LTE Band 30	10	22.7	22.62	0.11	1	Left	Cheek	Camera Module	QPSK	25	25	08038	1:1	0.094	1.019	0.096	
2310.00	27710	Mid	LTE Band 30	10	23.7	23.70	0.11	0	Left	Tilt	Camera Module	QPSK	1	0	08038	1:1	0.061	1.000	0.061	
2310.00	27710	Mid	LTE Band 30	10	22.7	22.62	0.16	1	Left	Tilt	Camera Module	QPSK	25	25	08038	1:1	0.049	1.019	0.050	
ANSI / IEEE C95.1 1992 - SAFETY LIMIT Spatial Peak Uncontrolled Exposure/General Population										Head 1.6 W/kg (mW/g) averaged over 1 gram										

**Table 11-21
LTE Band 7 Head SAR – Ant 1**

MEASUREMENT RESULTS																			
FREQUENCY		Mode	Bandwidth [MHz]	Maximum Allowed Power [dBm]	Conducted Power [dBm]	Power Drift [dB]	MPR [dB]	Side	Test Position	Modulation	RB Size	RB Offset	Device Serial Number	Duty Cycle	SAR (1g)	Scaling Factor	Reported SAR (1g)	Plot #	
MHz	Ch.														(W/kg)		(W/kg)		
2510.00	20850	Low	LTE Band 7	20	24.7	24.70	-0.02	0	Right	Cheek	QPSK	1	99	08137	1:1	0.136	1.000	0.136	
2510.00	20850	Low	LTE Band 7	20	23.7	23.69	0.16	1	Right	Cheek	QPSK	50	0	08137	1:1	0.110	1.002	0.110	
2510.00	20850	Low	LTE Band 7	20	24.7	24.70	0.06	0	Right	Tilt	QPSK	1	99	08137	1:1	0.087	1.000	0.087	
2510.00	20850	Low	LTE Band 7	20	23.7	23.69	0.04	1	Right	Tilt	QPSK	50	0	08137	1:1	0.068	1.002	0.068	
2510.00	20850	Low	LTE Band 7	20	24.7	24.70	0.16	0	Left	Cheek	QPSK	1	99	08137	1:1	0.130	1.000	0.130	
2510.00	20850	Low	LTE Band 7	20	23.7	23.69	0.18	1	Left	Cheek	QPSK	50	0	08137	1:1	0.130	1.002	0.130	
2510.00	20850	Low	LTE Band 7	20	24.7	24.70	0.21	0	Left	Tilt	QPSK	1	99	08137	1:1	0.057	1.000	0.057	
2510.00	20850	Low	LTE Band 7	20	23.7	23.69	0.11	1	Left	Tilt	QPSK	50	0	08137	1:1	0.043	1.002	0.043	
ANSI / IEEE C95.1 1992 - SAFETY LIMIT Spatial Peak Uncontrolled Exposure/General Population										Head 1.6 W/kg (mW/g) averaged over 1 gram									

FCC ID: ZNFH820		SAR EVALUATION REPORT		Reviewed by: Quality Manager
Document S/N: 0Y1601290203-R5_ZNF	Test Dates: 01/28/16 - 03/03/16	DUT Type: Portable Handset		Page 55 of 82

**Table 11-22
LTE Band 7 Head SAR with CM Accessory – Ant 1**

MEASUREMENT RESULTS																				
FREQUENCY		Mode	Bandwidth [MHz]	Maximum Allowed Power [dBm]	Conducted Power [dBm]	Power Drift [dB]	MPR [dB]	Side	Test Position	Accessory	Modulation	RB Size	RB Offset	Device Serial Number	Duty Cycle	SAR (1g)	Scaling Factor	Reported SAR (1g)	Plot #	
MHz	Ch.															(W/kg)		(W/kg)		
2510.00	20850	Low	LTE Band 7	20	24.7	24.70	0.07	0	Right	Cheek	Camera Module	QPSK	1	99	08137	1:1	0.233	1.000	0.233	A11
2510.00	20850	Low	LTE Band 7	20	23.7	23.69	0.07	1	Right	Cheek	Camera Module	QPSK	50	0	08137	1:1	0.178	1.002	0.178	
2510.00	20850	Low	LTE Band 7	20	24.7	24.70	0.05	0	Right	Tilt	Camera Module	QPSK	1	99	08137	1:1	0.109	1.000	0.109	
2510.00	20850	Low	LTE Band 7	20	23.7	23.69	0.08	1	Right	Tilt	Camera Module	QPSK	50	0	08137	1:1	0.091	1.002	0.091	
2510.00	20850	Low	LTE Band 7	20	24.7	24.70	0.14	0	Left	Cheek	Camera Module	QPSK	1	99	08137	1:1	0.200	1.000	0.200	
2510.00	20850	Low	LTE Band 7	20	23.7	23.69	0.13	1	Left	Cheek	Camera Module	QPSK	50	0	08137	1:1	0.155	1.002	0.155	
2510.00	20850	Low	LTE Band 7	20	24.7	24.70	0.00	0	Left	Tilt	Camera Module	QPSK	1	99	08137	1:1	0.174	1.000	0.174	
2510.00	20850	Low	LTE Band 7	20	23.7	23.69	-0.13	1	Left	Tilt	Camera Module	QPSK	50	0	08137	1:1	0.130	1.002	0.130	
ANSI / IEEE C95.1 1992 - SAFETY LIMIT Spatial Peak Uncontrolled Exposure/General Population											Head 1.6 W/kg (mW/g) averaged over 1 gram									

**Table 11-23
DTS Head SAR**



MEASUREMENT RESULTS																		
FREQUENCY		Mode	Service	Bandwidth [MHz]	Maximum Allowed Power [dBm]	Conducted Power [dBm]	Power Drift [dB]	Side	Test Position	Device Serial Number	Data Rate (Mbps)	Duty Cycle (%)	Peak SAR of Area Scan	SAR (1g)	Scaling Factor (Power)	Scaling Factor (Duty Cycle)	Reported SAR (1g)	Plot #
MHz	Ch.												(W/kg)	(W/kg)			(W/kg)	
2437	6	802.11b	DSSS	22	19.0	18.05	-0.06	Right	Cheek	08202	1	99.2	0.900	0.690	1.245	1.008	0.866	
2457	10	802.11b	DSSS	22	19.0	17.81	0.04	Right	Cheek	08202	1	99.2	1.016	0.773	1.315	1.008	1.024	A12
2437	6	802.11b	DSSS	22	19.0	18.05	-0.09	Right	Tilt	08202	1	99.2	0.983	0.722	1.245	1.008	0.906	
2457	10	802.11b	DSSS	22	19.0	17.81	0.02	Right	Tilt	08202	1	99.2	1.004	0.740	1.315	1.008	0.981	
2437	6	802.11b	DSSS	22	19.0	18.05	-0.01	Left	Cheek	08202	1	99.2	0.404	0.314	1.245	1.008	0.394	
2437	6	802.11b	DSSS	22	19.0	18.05	0.03	Left	Tilt	08202	1	99.2	0.387	-	1.245	1.008	-	
ANSI / IEEE C95.1 1992 - SAFETY LIMIT Spatial Peak Uncontrolled Exposure/General Population											Head 1.6 W/kg (mW/g) averaged over 1 gram							

Note: SAR highlighted in orange above is the highest SAR per exposure condition and equipment class to be listed on the grants.
Note: "-" in the table above indicates that the position was not required to be measured per the initial test position procedures in FCC KDB Publication 248227 D01v02r02.

**Table 11-24
NII Head SAR**

MEASUREMENT RESULTS																		
FREQUENCY		Mode	Service	Bandwidth [MHz]	Maximum Allowed Power [dBm]	Conducted Power [dBm]	Power Drift [dB]	Side	Test Position	Device Serial Number	Data Rate (Mbps)	Duty Cycle (%)	Peak SAR of Area Scan	SAR (1g)	Scaling Factor (Power)	Scaling Factor (Duty Cycle)	Reported SAR (1g)	Plot #
MHz	Ch.												(W/kg)	(W/kg)			(W/kg)	
5300	60	802.11a	OFDM	20	13.50	12.96	0.21	Right	Cheek	08202	6	99.3	0.677	0.396	1.132	1.007	0.451	
5300	60	802.11a	OFDM	20	13.50	12.96	0.11	Right	Tilt	08202	6	99.3	0.956	0.475	1.132	1.007	0.542	
5300	60	802.11a	OFDM	20	13.50	12.96	0.14	Left	Cheek	08202	6	99.3	0.386	0.177	1.132	1.007	0.201	
5300	60	802.11a	OFDM	20	13.50	12.96	0.14	Left	Tilt	08202	6	99.3	0.355	-	1.132	1.007	-	
5500	100	802.11a	OFDM	20	13.00	12.53	0.06	Right	Cheek	08202	6	99.3	1.094	0.447	1.114	1.007	0.501	
5500	100	802.11a	OFDM	20	13.00	12.53	0.10	Right	Tilt	08202	6	99.3	1.295	0.613	1.114	1.007	0.688	
5500	100	802.11a	OFDM	20	13.00	12.53	0.13	Left	Cheek	08202	6	99.3	0.383	0.204	1.114	1.007	0.229	
5500	100	802.11a	OFDM	20	13.00	12.53	0.06	Left	Tilt	08202	6	99.3	0.491	-	1.114	1.007	-	
5745	149	802.11a	OFDM	20	13.25	12.76	-0.06	Right	Cheek	08202	6	99.3	1.333	0.592	1.119	1.007	0.667	
5745	149	802.11a	OFDM	20	13.25	12.76	0.15	Right	Tilt	08202	6	99.3	1.393	0.798	1.119	1.007	0.899	A13
5785	157	802.11a	OFDM	20	13.25	12.70	-0.13	Right	Tilt	08202	6	99.3	1.490	0.795	1.135	1.007	0.908	
5745	149	802.11a	OFDM	20	13.25	12.76	-0.12	Left	Cheek	08202	6	99.3	0.661	0.331	1.119	1.007	0.373	
5745	149	802.11a	OFDM	20	13.25	12.76	0.11	Left	Tilt	08202	6	99.3	0.798	-	1.119	1.007	-	
ANSI / IEEE C95.1 1992 - SAFETY LIMIT Spatial Peak Uncontrolled Exposure/General Population											Head 1.6 W/kg (mW/g) averaged over 1 gram							

Note: SAR highlighted in orange above is the highest SAR per exposure condition and equipment class to be listed on the grants.
Note: Since U-NII-1 and U-NII-2A bands have the same maximum output power and the highest reported SAR for U-NII-2A is less than 1.2 W/kg for 1g SAR, SAR is not required for U-NII-1 band according to FCC KDB 248227 D01v02r01.
Note: "-" in the table above indicates that the position was not required to be measured per the initial test position procedures in FCC KDB Publication 248227 D01v02r02.

FCC ID: ZNFH820		SAR EVALUATION REPORT		Reviewed by: Quality Manager
Document S/N: 0Y1601290203-R5.ZNF	Test Dates: 01/28/16 - 03/03/16	DUT Type: Portable Handset	Page 56 of 82	

11.3 Standalone Body-Worn SAR Data

**Table 11-25
GSM/UMTS Body-Worn SAR Data – Ant 1,2,3**

MEASUREMENT RESULTS																
FREQUENCY		Mode	Service	Maximum Allowed Power [dBm]	Conducted Power [dBm]	Power Drift [dB]	Spacing	Antenna Config.	Device Serial Number	# of Time Slots	Duty Cycle	Side	SAR (1g)	Scaling Factor	Reported SAR (1g)	Plot #
MHz	Ch.												(W/kg)		(W/kg)	
836.60	190	GSM 850	GSM	33.2	33.16	-0.02	10 mm	Ant 1	08103	1	1:8.3	back	0.661	1.009	0.667	
824.20	128	GSM 850	GPRS	29.7	29.67	-0.02	10 mm	Ant 1	08103	3	1:2.76	back	0.993	1.007	1.000	
836.60	190	GSM 850	GPRS	29.7	29.60	-0.03	10 mm	Ant 1	08103	3	1:2.76	back	1.010	1.023	1.033	A14
848.80	251	GSM 850	GPRS	29.7	29.70	-0.05	10 mm	Ant 1	08103	3	1:2.76	back	0.900	1.000	0.900	
836.60	4183	UMTS 850	RMC	24.2	24.11	-0.02	10 mm	Ant 1	08103	N/A	1:1	back	0.507	1.021	0.518	A16
1732.40	1412	UMTS 1750	RMC	24.2	24.20	0.07	10 mm	Ant 2	08103	N/A	1:1	back	0.721	1.000	0.721	A18
1732.40	1412	UMTS 1750	RMC	24.2	24.20	-0.04	10 mm	Ant 3	08079	N/A	1:1	back	0.470	1.000	0.470	
1880.00	661	GSM 1900	GSM	30.7	30.68	-0.06	10 mm	Ant 2	08103	1	1:8.3	back	0.307	1.005	0.309	A20
1880.00	661	GSM 1900	GPRS	25.7	25.66	-0.08	10 mm	Ant 2	08103	4	1:2.076	back	0.294	1.009	0.297	
1852.40	9262	UMTS 1900	RMC	24.7	24.66	0.03	10 mm	Ant 2	08103	N/A	1:1	back	0.864	1.009	0.872	
1880.00	9400	UMTS 1900	RMC	24.7	24.59	0.05	10 mm	Ant 2	08103	N/A	1:1	back	0.877	1.026	0.900	
1907.60	9538	UMTS 1900	RMC	24.7	24.63	0.02	10 mm	Ant 2	08103	N/A	1:1	back	1.050	1.016	1.067	A22
1880.00	9400	UMTS 1900	RMC	24.7	24.59	0.01	10 mm	Ant 3	08046	N/A	1:1	back	0.338	1.026	0.347	
1907.60	9538	UMTS 1900	RMC	24.7	24.63	0.04	10 mm	Ant 2	08103	N/A	1:1	back	1.050	1.016	1.067	
ANSI / IEEE C95.1 1992 - SAFETY LIMIT Spatial Peak Uncontrolled Exposure/General Population							Body 1.6 W/kg (mW/g) averaged over 1 gram									



Note: Blue entry represents variability measurement.

**Table 11-26
GSM/UMTS Body-Worn SAR Data with CM Accessory – Ant 1,2**

MEASUREMENT RESULTS																	
FREQUENCY		Mode	Service	Maximum Allowed Power [dBm]	Conducted Power [dBm]	Power Drift [dB]	Spacing	Antenna Config.	Accessory	Device Serial Number	# of Time Slots	Duty Cycle	Side	SAR (1g)	Scaling Factor	Reported SAR (1g)	Plot #
MHz	Ch.													(W/kg)		(W/kg)	
836.60	190	GSM 850	GSM	33.2	33.16	-0.04	10 mm	Ant 1	Camera Module	08103	1	1:8.3	back	0.041	1.009	0.041	
836.60	190	GSM 850	GPRS	29.7	29.60	-0.12	10 mm	Ant 1	Camera Module	08103	3	1:2.76	back	0.049	1.023	0.050	
836.60	4183	UMTS 850	RMC	24.2	24.11	0.02	10 mm	Ant 1	Camera Module	08103	N/A	1:1	back	0.049	1.021	0.050	
1732.40	1412	UMTS 1750	RMC	24.2	24.20	0.03	10 mm	Ant 2	Camera Module	08103	N/A	1:1	back	0.318	1.000	0.318	
1880.00	661	GSM 1900	GSM	30.7	30.68	0.17	10 mm	Ant 2	Camera Module	08103	1	1:8.3	back	0.064	1.005	0.064	
1880.00	661	GSM 1900	GPRS	25.7	25.66	-0.02	10 mm	Ant 2	Camera Module	08103	4	1:2.076	back	0.077	1.009	0.078	
1880.00	9400	UMTS 1900	RMC	24.7	24.59	0.02	10 mm	Ant 2	Camera Module	08103	N/A	1:1	back	0.177	1.026	0.182	
ANSI / IEEE C95.1 1992 - SAFETY LIMIT Spatial Peak Uncontrolled Exposure/General Population							Body 1.6 W/kg (mW/g) averaged over 1 gram										

Note: Please see Section 6.8 for details on device positioning for back side with the camera module accessory.

Note: The camera module accessory replaces the bottom of the device below the screen where Antennas 1 and 2 are located. Therefore, additional SAR tests were performed with the camera module accessory attached for these antennas. Due to the location at the top of the device, no additional SAR measurements were needed for Antenna 3 with the camera module accessory attached.

FCC ID: ZNFH820		SAR EVALUATION REPORT		Reviewed by: Quality Manager
Document S/N: 0Y1601290203-R5.ZNF	Test Dates: 01/28/16 - 03/03/16	DUT Type: Portable Handset	Page 57 of 82	

**Table 11-27
LTE Body-Worn SAR – Ant 1,2,3**

MEASUREMENT RESULTS																				
FREQUENCY		Mode	Bandwidth [MHz]	Maximum Allowed Power [dBm]	Conducted Power [dBm]	Power Drift [dB]	MPR [dB]	Antenna Config.	Device Serial Number	Modulation	RB Size	RB Offset	Spacing	Side	Duty Cycle	SAR (1g)	Scaling Factor	Reported SAR (1g)	Plot #	
MHz	Ch.															(W/kg)		(W/kg)		
707.50	23095	Mid	LTE Band 12	10	24.7	24.67	-0.03	0	Ant 1	08038	QPSK	1	0	10 mm	back	1:1	0.505	1.007	0.509	A23
707.50	23095	Mid	LTE Band 12	10	23.7	23.65	0.00	1	Ant 1	08038	QPSK	25	12	10 mm	back	1:1	0.408	1.012	0.413	
836.50	20525	Mid	LTE Band 5 (Cell)	10	24.2	24.11	-0.04	0	Ant 1	08137	QPSK	1	25	10 mm	back	1:1	0.498	1.021	0.508	A24
836.50	20525	Mid	LTE Band 5 (Cell)	10	23.2	23.18	-0.03	1	Ant 1	08137	QPSK	25	0	10 mm	back	1:1	0.406	1.005	0.408	
1732.50	20175	Mid	LTE Band 4 (AWS)	20	24.7	24.60	0.02	0	Ant 2	08137	QPSK	1	0	10 mm	back	1:1	1.090	1.023	1.115	A26
1732.50	20175	Mid	LTE Band 4 (AWS)	20	23.7	23.63	0.05	1	Ant 2	08137	QPSK	50	25	10 mm	back	1:1	0.813	1.016	0.826	
1732.50	20175	Mid	LTE Band 4 (AWS)	20	23.7	23.60	0.03	1	Ant 2	08137	QPSK	100	0	10 mm	back	1:1	0.736	1.023	0.753	
1732.50	20175	Mid	LTE Band 4 (AWS)	20	24.7	24.60	-0.06	0	Ant 3	08046	QPSK	1	0	10 mm	back	1:1	0.356	1.023	0.364	
1732.50	20175	Mid	LTE Band 4 (AWS)	20	23.7	23.63	-0.01	1	Ant 3	08046	QPSK	50	25	10 mm	back	1:1	0.286	1.016	0.291	
1732.50	20175	Mid	LTE Band 4 (AWS)	20	24.7	24.60	0.03	0	Ant 2	08137	QPSK	1	0	10 mm	back	1:1	1.040	1.023	1.064	
1860.00	18700	Low	LTE Band 2 (PCS)	20	24.7	24.60	0.10	0	Ant 2	08137	QPSK	1	50	10 mm	back	1:1	0.747	1.023	0.764	
1880.00	18900	Mid	LTE Band 2 (PCS)	20	24.7	24.65	0.04	0	Ant 2	08137	QPSK	1	0	10 mm	back	1:1	1.020	1.012	1.032	
1900.00	19100	High	LTE Band 2 (PCS)	20	24.7	24.70	-0.01	0	Ant 2	08137	QPSK	1	99	10 mm	back	1:1	1.020	1.000	1.020	A27
1860.00	18700	Low	LTE Band 2 (PCS)	20	23.7	23.65	0.01	1	Ant 2	08137	QPSK	50	25	10 mm	back	1:1	0.623	1.012	0.630	
1880.00	18900	Mid	LTE Band 2 (PCS)	20	23.7	23.59	0.02	1	Ant 2	08137	QPSK	50	0	10 mm	back	1:1	0.726	1.026	0.745	
1900.00	19100	High	LTE Band 2 (PCS)	20	23.7	23.67	-0.01	1	Ant 2	08137	QPSK	50	50	10 mm	back	1:1	0.797	1.007	0.803	
1900.00	19100	High	LTE Band 2 (PCS)	20	23.7	23.63	0.01	1	Ant 2	08137	QPSK	100	0	10 mm	back	1:1	0.798	1.016	0.811	
1900.00	19100	High	LTE Band 2 (PCS)	20	24.7	24.70	-0.07	0	Ant 3	08046	QPSK	1	99	10 mm	back	1:1	0.343	1.000	0.343	
1900.00	19100	High	LTE Band 2 (PCS)	20	23.7	23.67	-0.08	1	Ant 3	08046	QPSK	50	50	10 mm	back	1:1	0.287	1.007	0.289	
2310.00	27710	Mid	LTE Band 30	10	23.7	23.70	-0.03	0	Ant 1	08038	QPSK	1	0	10 mm	back	1:1	0.324	1.000	0.324	A29
2310.00	27710	Mid	LTE Band 30	10	22.7	22.62	0.01	1	Ant 1	08038	QPSK	25	25	10 mm	back	1:1	0.226	1.019	0.230	
2510.00	20850	Low	LTE Band 7	20	24.7	24.70	-0.07	0	Ant 1	08137	QPSK	1	99	10 mm	back	1:1	0.306	1.000	0.306	
2510.00	20850	Low	LTE Band 7	20	23.7	23.69	-0.08	1	Ant 1	08137	QPSK	50	0	10 mm	back	1:1	0.246	1.002	0.246	
ANSI / IEEE C95.1 1992 - SAFETY LIMIT										Body										
Spatial Peak										1.6 W/kg (mW/g)										
Uncontrolled Exposure/General Population										averaged over 1 gram										

Note: Blue entry represents variability measurement.

Note: SAR highlighted in orange above is the highest SAR per exposure condition and equipment class to be listed on the grants.

Note: This device supports both LTE Band 12 and LTE Band 17. Since the supported frequency span for LTE Band 17 falls completely within the supported frequency span for LTE Band 12, both LTE bands have the same target power, and both LTE bands share the same transmission path, SAR was only assessed for LTE Band 12.



**Table 11-28
LTE Body-Worn SAR with CM Accessory – Ant 1,2**

MEASUREMENT RESULTS																					
FREQUENCY		Mode	Bandwidth [MHz]	Maximum Allowed Power [dBm]	Conducted Power [dBm]	Accessory	Power Drift [dB]	MPR [dB]	Antenna Config.	Device Serial Number	Modulation	RB Size	RB Offset	Spacing	Side	Duty Cycle	SAR (1g)	Scaling Factor	Reported SAR (1g)	Plot #	
MHz	Ch.																(W/kg)		(W/kg)		
707.50	23095	Mid	LTE Band 12	10	24.7	24.67	Camera Module	-0.01	0	Ant 1	08038	QPSK	1	0	10 mm	back	1:1	0.258	1.007	0.260	
707.50	23095	Mid	LTE Band 12	10	23.7	23.65	Camera Module	-0.01	1	Ant 1	08038	QPSK	25	12	10 mm	back	1:1	0.175	1.012	0.177	
836.50	20525	Mid	LTE Band 5 (Cell)	10	24.2	24.11	Camera Module	0.08	0	Ant 1	08137	QPSK	1	25	10 mm	back	1:1	0.049	1.021	0.050	
836.50	20525	Mid	LTE Band 5 (Cell)	10	23.2	23.18	Camera Module	0.01	1	Ant 1	08137	QPSK	25	0	10 mm	back	1:1	0.041	1.005	0.041	
1732.50	20175	Mid	LTE Band 4 (AWS)	20	24.7	24.60	Camera Module	-0.02	0	Ant 2	08137	QPSK	1	0	10 mm	back	1:1	0.360	1.023	0.368	
1732.50	20175	Mid	LTE Band 4 (AWS)	20	23.7	23.63	Camera Module	0.01	1	Ant 2	08137	QPSK	50	25	10 mm	back	1:1	0.248	1.016	0.252	
1900.00	19100	High	LTE Band 2 (PCS)	20	24.7	24.70	Camera Module	0.01	0	Ant 2	08137	QPSK	1	99	10 mm	back	1:1	0.395	1.000	0.395	
1900.00	19100	High	LTE Band 2 (PCS)	20	23.7	23.67	Camera Module	0.00	1	Ant 2	08137	QPSK	50	50	10 mm	back	1:1	0.279	1.007	0.281	
2310.00	27710	Mid	LTE Band 30	10	23.7	23.70	Camera Module	0.05	0	Ant 1	08038	QPSK	1	0	10 mm	back	1:1	0.274	1.000	0.274	
2310.00	27710	Mid	LTE Band 30	10	22.7	22.62	Camera Module	0.05	1	Ant 1	08038	QPSK	25	25	10 mm	back	1:1	0.211	1.019	0.215	
2510.00	20850	Low	LTE Band 7	20	24.7	24.70	Camera Module	-0.09	0	Ant 1	08137	QPSK	1	99	10 mm	back	1:1	0.571	1.000	0.571	A31
2510.00	20850	Low	LTE Band 7	20	23.7	23.69	Camera Module	0.04	1	Ant 1	08137	QPSK	50	0	10 mm	back	1:1	0.491	1.002	0.492	
ANSI / IEEE C95.1 1992 - SAFETY LIMIT										Body											
Spatial Peak										1.6 W/kg (mW/g)											
Uncontrolled Exposure/General Population										averaged over 1 gram											

Note: Please see Section 6.8 for details on device positioning for back side with the camera module accessory.

Note: This device supports both LTE Band 12 and LTE Band 17. Since the supported frequency span for LTE Band 17 falls completely within the supported frequency span for LTE Band 12, both LTE bands have the same target power, and both LTE bands share the same transmission path, SAR was only assessed for LTE Band 12.

Note: The camera module accessory replaces the bottom of the device below the screen where Antennas 1 and 2 are located. Therefore, additional SAR tests were performed with the camera module accessory attached for these antennas. Due to the location at the top of the device, no additional SAR measurements were needed for Antenna 3 with the camera module accessory attached.

FCC ID: ZNFH820		SAR EVALUATION REPORT		Reviewed by: Quality Manager
Document S/N: 0Y1601290203-R5.ZNF	Test Dates: 01/28/16 - 03/03/16	DUT Type: Portable Handset	Page 58 of 82	

**Table 11-29
DTS Body-Worn SAR**

MEASUREMENT RESULTS																		
FREQUENCY		Mode	Service	Bandwidth [MHz]	Maximum Allowed Power [dBm]	Conducted Power [dBm]	Power Drift [dB]	Spacing	Device Serial Number	Data Rate (Mbps)	Side	Duty Cycle (%)	Peak SAR of Area Scan	SAR (1g)	Scaling Factor (Power)	Scaling Factor (Duty Cycle)	Reported SAR (1g)	Plot #
MHz	Ch.												W/kg	(W/kg)			(W/kg)	
2437	6	802.11b	DSSS	22	19.0	18.05	0.06	10 mm	08202	1	back	99.2	0.126	0.108	1.245	1.008	0.135	A32
ANSI / IEEE C95.1 1992 - SAFETY LIMIT Spatial Peak Uncontrolled Exposure/General Population								Body 1.6 W/kg (mW/g) averaged over 1 gram										

Note: SAR highlighted in orange above is the highest SAR per exposure condition and equipment class to be listed on the grants.

**Table 11-30
NII Body-Worn SAR**

MEASUREMENT RESULTS																		
FREQUENCY		Mode	Service	Bandwidth [MHz]	Maximum Allowed Power [dBm]	Conducted Power [dBm]	Power Drift [dB]	Spacing	Device Serial Number	Data Rate (Mbps)	Side	Duty Cycle (%)	Peak SAR of Area Scan	SAR (1g)	Scaling Factor (Power)	Scaling Factor (Duty Cycle)	Reported SAR (1g)	Plot #
MHz	Ch.												W/kg	(W/kg)			(W/kg)	
5300	80	802.11a	OFDM	20	13.5	12.96	0.12	10 mm	08210	6	back	99.3	0.087	0.042	1.132	1.007	0.048	
5500	100	802.11a	OFDM	20	13.0	12.53	0.18	10 mm	08210	6	back	99.3	0.100	0.050	1.114	1.007	0.056	A34
5745	149	802.11a	OFDM	20	13.3	12.76	0.17	10 mm	08210	6	back	99.3	0.116	0.049	1.119	1.007	0.055	
ANSI / IEEE C95.1 1992 - SAFETY LIMIT Spatial Peak Uncontrolled Exposure/General Population								Body 1.6 W/kg (mW/g) averaged over 1 gram										



Note: SAR highlighted in orange above is the highest SAR per exposure condition and equipment class to be listed on the grants.

Note: Since U-NII-1 and U-NII-2A bands have the same maximum output power and the highest reported SAR for U-NII-2A is less than 1.2 W/kg for 1g SAR, SAR is not required for U-NII-1 band according to FCC KDB 248227 D01v02r01.

**Table 11-31
Bluetooth SAR**

MEASUREMENT RESULTS																	
FREQUENCY		Mode	Service	Maximum Allowed Power [dBm]	Conducted Power [dBm]	Power Drift [dB]	Spacing	Device Serial Number	Data Rate (Mbps)	Side	Duty Cycle	SAR (1g)	Scaling Factor	Reported SAR (1g)	Plot #		
MHz	Ch.											(W/kg)		(W/kg)			
2441	39	Bluetooth	FHSS	8.9	8.85	-0.01	10 mm	08202	1	back	1:1	0.005	1.012	0.005	A36		
ANSI / IEEE C95.1 1992 - SAFETY LIMIT Spatial Peak Uncontrolled Exposure/General Population								Body 1.6 W/kg (mW/g) averaged over 1 gram									

Note: SAR highlighted in orange above is the highest SAR per exposure condition and equipment class to be listed on the grants.



FCC ID: ZNFH820		SAR EVALUATION REPORT		Reviewed by: Quality Manager
Document S/N: 0Y1601290203-R5.ZNF	Test Dates: 01/28/16 - 03/03/16	DUT Type: Portable Handset		Page 59 of 82

11.4 Standalone Hotspot SAR Data

**Table 11-32
GPRS/UMTS Hotspot SAR Data – Ant 1,2,3**

MEASUREMENT RESULTS																
FREQUENCY		Mode	Service	Maximum Allowed Power [dBm]	Conducted Power [dBm]	Power Drift [dB]	Spacing	Antenna Config.	Device Serial Number	# of GPRS Slots	Duty Cycle	Side	SAR (1g)	Scaling Factor	Reported SAR (1g)	Plot #
MHz	Ch.												(W/kg)		(W/kg)	
824.20	128	GSM 850	GPRS	29.7	29.67	-0.02	10 mm	Ant 1	08103	3	1.2.76	back	0.993	1.007	1.000	
836.60	190	GSM 850	GPRS	29.7	29.60	-0.03	10 mm	Ant 1	08103	3	1.2.76	back	1.010	1.023	1.033	
848.80	251	GSM 850	GPRS	29.7	29.70	-0.05	10 mm	Ant 1	08103	3	1.2.76	back	0.900	1.000	0.900	
824.20	128	GSM 850	GPRS	29.7	29.67	-0.13	10 mm	Ant 1	08103	3	1.2.76	front	0.833	1.007	0.839	
836.60	190	GSM 850	GPRS	29.7	29.60	0.03	10 mm	Ant 1	08103	3	1.2.76	front	0.789	1.023	0.807	
848.80	251	GSM 850	GPRS	29.7	29.70	-0.03	10 mm	Ant 1	08103	3	1.2.76	front	0.769	1.000	0.769	
836.60	190	GSM 850	GPRS	29.7	29.60	0.13	10 mm	Ant 1	08103	3	1.2.76	bottom	0.232	1.023	0.237	
836.60	190	GSM 850	GPRS	29.7	29.60	0.01	10 mm	Ant 1	08103	3	1.2.76	right	0.700	1.023	0.716	
824.20	128	GSM 850	GPRS	29.7	29.67	-0.04	10 mm	Ant 1	08103	3	1.2.76	left	0.953	1.007	0.960	
836.60	190	GSM 850	GPRS	29.7	29.60	-0.03	10 mm	Ant 1	08103	3	1.2.76	left	1.030	1.023	1.054	
848.80	251	GSM 850	GPRS	29.7	29.70	0.13	10 mm	Ant 1	08103	3	1.2.76	left	0.978	1.000	0.978	
836.60	190	GSM 850	GPRS	29.7	29.60	-0.03	10 mm	Ant 1	08103	3	1.2.76	left	1.060	1.023	1.084	A15
836.60	4183	UMTS 850	RMC	24.2	24.11	-0.02	10 mm	Ant 1	08103	N/A	1:1	back	0.507	1.021	0.518	
836.60	4183	UMTS 850	RMC	24.2	24.11	-0.04	10 mm	Ant 1	08103	N/A	1:1	front	0.465	1.021	0.475	
836.60	4183	UMTS 850	RMC	24.2	24.11	-0.04	10 mm	Ant 1	08103	N/A	1:1	bottom	0.149	1.021	0.152	
836.60	4183	UMTS 850	RMC	24.2	24.11	-0.06	10 mm	Ant 1	08103	N/A	1:1	right	0.250	1.021	0.255	
836.60	4183	UMTS 850	RMC	24.2	24.11	0.01	10 mm	Ant 1	08103	N/A	1:1	left	0.611	1.021	0.624	A17
1732.40	1412	UMTS 1750	RMC	24.2	24.20	0.07	10 mm	Ant 2	08103	N/A	1:1	back	0.721	1.000	0.721	
1732.40	1412	UMTS 1750	RMC	24.2	24.20	0.06	10 mm	Ant 2	08103	N/A	1:1	front	0.540	1.000	0.540	
1732.40	1412	UMTS 1750	RMC	24.2	24.20	0.01	10 mm	Ant 2	08103	N/A	1:1	bottom	0.457	1.000	0.457	
1732.40	1412	UMTS 1750	RMC	24.2	24.20	0.01	10 mm	Ant 2	08103	N/A	1:1	right	0.589	1.000	0.589	
1732.40	1412	UMTS 1750	RMC	24.2	24.20	-0.04	10 mm	Ant 3	08079	N/A	1:1	back	0.470	1.000	0.470	
1732.40	1412	UMTS 1750	RMC	24.2	24.20	-0.02	10 mm	Ant 3	08079	N/A	1:1	front	0.527	1.000	0.527	
1732.40	1412	UMTS 1750	RMC	24.2	24.20	-0.03	10 mm	Ant 3	08079	N/A	1:1	top	0.785	1.000	0.785	A19
1732.40	1412	UMTS 1750	RMC	24.2	24.20	0.04	10 mm	Ant 3	08079	N/A	1:1	right	0.053	1.000	0.053	
1732.40	1412	UMTS 1750	RMC	24.2	24.20	0.09	10 mm	Ant 3	08079	N/A	1:1	left	0.049	1.000	0.049	
1880.00	661	GSM 1900	GPRS	25.7	25.66	-0.08	10 mm	Ant 2	08103	4	1.2.076	back	0.294	1.009	0.297	A21
1880.00	661	GSM 1900	GPRS	25.7	25.66	-0.09	10 mm	Ant 2	08103	4	1.2.076	front	0.197	1.009	0.199	
1880.00	661	GSM 1900	GPRS	25.7	25.66	0.00	10 mm	Ant 2	08103	4	1.2.076	bottom	0.175	1.009	0.177	
1880.00	661	GSM 1900	GPRS	25.7	25.66	0.04	10 mm	Ant 2	08103	4	1.2.076	right	0.279	1.009	0.282	
1852.40	9262	UMTS 1900	RMC	24.7	24.66	0.03	10 mm	Ant 2	08103	N/A	1:1	back	0.864	1.009	0.872	
1880.00	9400	UMTS 1900	RMC	24.7	24.59	0.05	10 mm	Ant 2	08103	N/A	1:1	back	0.877	1.026	0.900	
1907.60	9538	UMTS 1900	RMC	24.7	24.63	0.02	10 mm	Ant 2	08103	N/A	1:1	back	1.050	1.016	1.067	A22
1880.00	9400	UMTS 1900	RMC	24.7	24.59	0.03	10 mm	Ant 2	08103	N/A	1:1	front	0.574	1.026	0.589	
1880.00	9400	UMTS 1900	RMC	24.7	24.59	-0.08	10 mm	Ant 2	08103	N/A	1:1	bottom	0.522	1.026	0.536	
1880.00	9400	UMTS 1900	RMC	24.7	24.59	0.00	10 mm	Ant 2	08103	N/A	1:1	right	0.674	1.026	0.692	
1880.00	9400	UMTS 1900	RMC	24.7	24.59	0.01	10 mm	Ant 3	08046	N/A	1:1	back	0.338	1.026	0.347	
1880.00	9400	UMTS 1900	RMC	24.7	24.59	-0.04	10 mm	Ant 3	08046	N/A	1:1	front	0.439	1.026	0.450	
1880.00	9400	UMTS 1900	RMC	24.7	24.59	-0.09	10 mm	Ant 3	08046	N/A	1:1	top	0.703	1.026	0.721	
1880.00	9400	UMTS 1900	RMC	24.7	24.59	-0.01	10 mm	Ant 3	08046	N/A	1:1	right	0.034	1.026	0.035	
1880.00	9400	UMTS 1900	RMC	24.7	24.59	0.08	10 mm	Ant 3	08046	N/A	1:1	left	0.043	1.026	0.044	
1907.60	9538	UMTS 1900	RMC	24.7	24.63	0.04	10 mm	Ant 2	08103	N/A	1:1	back	1.050	1.016	1.067	
ANSI / IEEE C95.1 1992 - SAFETY LIMIT Spatial Peak							Body 1.6 W/kg (mW/g) averaged over 1 gram									
Uncontrolled Exposure/General Population																

Blue entry represents variability measurement.

FCC ID: ZNFH820		SAR EVALUATION REPORT		Reviewed by: Quality Manager
Document S/N: 0Y1601290203-R5.ZNF	Test Dates: 01/28/16 - 03/03/16	DUT Type: Portable Handset	Page 60 of 82	

**Table 11-33
GPRS/UMTS Hotspot SAR Data with CM Accessory – Ant 1,2**

MEASUREMENT RESULTS																	
FREQUENCY		Mode	Service	Maximum Allowed Power [dBm]	Conducted Power [dBm]	Power Drift [dB]	Spacing	Antenna Config.	Accessory	Device Serial Number	# of GPRS Slots	Duty Cycle	Side	SAR (1g)	Scaling Factor	Reported SAR (1g)	Plot #
MHz	Ch.													(W/kg)		(W/kg)	
836.60	190	GSM850	GPRS	29.7	29.60	-0.12	10 mm	Ant 1	Camera Module	08103	3	1:2.76	back	0.049	1.023	0.050	
836.60	190	GSM850	GPRS	29.7	29.60	-0.04	10 mm	Ant 1	Camera Module	08103	3	1:2.76	front	0.020	1.023	0.020	
836.60	190	GSM850	GPRS	29.7	29.60	0.17	10 mm	Ant 1	Camera Module	08103	3	1:2.76	bottom	0.033	1.023	0.034	
836.60	190	GSM850	GPRS	29.7	29.60	0.07	10 mm	Ant 1	Camera Module	08103	3	1:2.76	right	0.029	1.023	0.030	
836.60	190	GSM850	GPRS	29.7	29.60	-0.18	10 mm	Ant 1	Camera Module	08103	3	1:2.76	left	0.042	1.023	0.043	
836.60	4183	UMTS 850	RMC	24.2	24.11	0.02	10 mm	Ant 1	Camera Module	08103	N/A	1:1	back	0.049	1.021	0.050	
836.60	4183	UMTS 850	RMC	24.2	24.11	0.03	10 mm	Ant 1	Camera Module	08103	N/A	1:1	front	0.021	1.021	0.021	
836.60	4183	UMTS 850	RMC	24.2	24.11	0.11	10 mm	Ant 1	Camera Module	08103	N/A	1:1	bottom	0.035	1.021	0.036	
836.60	4183	UMTS 850	RMC	24.2	24.11	0.08	10 mm	Ant 1	Camera Module	08103	N/A	1:1	right	0.024	1.021	0.025	
836.60	4183	UMTS 850	RMC	24.2	24.11	0.05	10 mm	Ant 1	Camera Module	08103	N/A	1:1	left	0.036	1.021	0.037	
1732.40	1412	UMTS 1750	RMC	24.2	24.20	0.03	10 mm	Ant 2	Camera Module	08103	N/A	1:1	back	0.318	1.000	0.318	
1732.40	1412	UMTS 1750	RMC	24.2	24.20	-0.05	10 mm	Ant 2	Camera Module	08103	N/A	1:1	front	0.341	1.000	0.341	
1732.40	1412	UMTS 1750	RMC	24.2	24.20	0.00	10 mm	Ant 2	Camera Module	08103	N/A	1:1	bottom	0.164	1.000	0.164	
1732.40	1412	UMTS 1750	RMC	24.2	24.20	0.01	10 mm	Ant 2	Camera Module	08103	N/A	1:1	right	0.253	1.000	0.253	
1880.00	661	GSM 1900	GPRS	25.7	25.66	-0.02	10 mm	Ant 2	Camera Module	08103	4	1:2.076	back	0.077	1.009	0.078	
1880.00	661	GSM 1900	GPRS	25.7	25.66	0.03	10 mm	Ant 2	Camera Module	08103	4	1:2.076	front	0.103	1.009	0.104	
1880.00	661	GSM 1900	GPRS	25.7	25.66	-0.01	10 mm	Ant 2	Camera Module	08103	4	1:2.076	bottom	0.076	1.009	0.077	
1880.00	661	GSM 1900	GPRS	25.7	25.66	-0.05	10 mm	Ant 2	Camera Module	08103	4	1:2.076	right	0.096	1.009	0.097	
1880.00	9400	UMTS 1900	RMC	24.7	24.59	0.02	10 mm	Ant 2	Camera Module	08103	N/A	1:1	back	0.177	1.026	0.182	
1880.00	9400	UMTS 1900	RMC	24.7	24.59	-0.04	10 mm	Ant 2	Camera Module	08103	N/A	1:1	front	0.312	1.026	0.320	
1880.00	9400	UMTS 1900	RMC	24.7	24.59	-0.01	10 mm	Ant 2	Camera Module	08103	N/A	1:1	bottom	0.234	1.026	0.240	
1880.00	9400	UMTS 1900	RMC	24.7	24.59	-0.05	10 mm	Ant 2	Camera Module	08103	N/A	1:1	right	0.316	1.026	0.324	
ANSI / IEEE C95.1 1992 - SAFETY LIMIT Spatial Peak										Body 1.6 W/kg (mW/g) averaged over 1 gram							
Uncontrolled Exposure/General Population																	



Note: Please see Section 6.8 for details on device positioning for back side with the camera module accessory.

Note: The camera module accessory replaces the bottom of the device below the screen where Antennas 1 and 2 are located. Therefore, additional SAR tests were performed with the camera module accessory attached for these antennas. Due to the location at the top of the device, no additional SAR measurements were needed for Antenna 3 with the camera module accessory attached.

**Table 11-34
LTE Band 12 Hotspot SAR – Ant 1**

MEASUREMENT RESULTS																			
FREQUENCY		Mode	Bandwidth [MHz]	Maximum Allowed Power [dBm]	Conducted Power [dBm]	Power Drift [dB]	MPR [dB]	Device Serial Number	Modulation	RB Size	RB Offset	Spacing	Side	Duty Cycle	SAR (1g)	Scaling Factor	Reported SAR (1g)	Plot #	
MHz	Ch.														(W/kg)		(W/kg)		
707.50	23095	Mid	LTE Band 12	10	24.7	24.67	-0.03	0	08038	QPSK	1	0	10 mm	back	1:1	0.505	1.007	0.509	A23
707.50	23095	Mid	LTE Band 12	10	23.7	23.65	0.00	1	08038	QPSK	25	12	10 mm	back	1:1	0.408	1.012	0.413	
707.50	23095	Mid	LTE Band 12	10	24.7	24.67	0.02	0	08038	QPSK	1	0	10 mm	front	1:1	0.407	1.007	0.410	
707.50	23095	Mid	LTE Band 12	10	23.7	23.65	0.01	1	08038	QPSK	25	12	10 mm	front	1:1	0.312	1.012	0.316	
707.50	23095	Mid	LTE Band 12	10	24.7	24.67	-0.06	0	08038	QPSK	1	0	10 mm	bottom	1:1	0.112	1.007	0.113	
707.50	23095	Mid	LTE Band 12	10	23.7	23.65	-0.06	1	08038	QPSK	25	12	10 mm	bottom	1:1	0.097	1.012	0.098	
707.50	23095	Mid	LTE Band 12	10	24.7	24.67	0.04	0	08038	QPSK	1	0	10 mm	right	1:1	0.242	1.007	0.244	
707.50	23095	Mid	LTE Band 12	10	23.7	23.65	0.04	1	08038	QPSK	25	12	10 mm	right	1:1	0.157	1.012	0.159	
707.50	23095	Mid	LTE Band 12	10	24.7	24.67	0.01	0	08038	QPSK	1	0	10 mm	left	1:1	0.479	1.007	0.482	
707.50	23095	Mid	LTE Band 12	10	23.7	23.65	-0.03	1	08038	QPSK	25	12	10 mm	left	1:1	0.357	1.012	0.361	
ANSI / IEEE C95.1 1992 - SAFETY LIMIT Spatial Peak										Body 1.6 W/kg (mW/g) averaged over 1 gram									
Uncontrolled Exposure/General Population																			

This device supports both LTE Band 12 and LTE Band 17. Since the supported frequency span for LTE Band 17 falls completely within the supported frequency span for LTE Band 12, both LTE bands have the same target power, and both LTE bands share the same transmission path, SAR was only assessed for LTE Band 12.

FCC ID: ZNFH820		SAR EVALUATION REPORT		Reviewed by: Quality Manager
Document S/N: 0Y1601290203-R5.ZNF	Test Dates: 01/28/16 - 03/03/16	DUT Type: Portable Handset	Page 61 of 82	

**Table 11-35
LTE Band 12 Hotspot SAR with CM Accessory – Ant 1**

MEASUREMENT RESULTS																				
FREQUENCY		Mode	Bandwidth [MHz]	Maximum Allowed Power [dBm]	Conducted Power [dBm]	Power Drift [dB]	MPR [dB]	Accessory	Device Serial Number	Modulation	RB Size	RB Offset	Spacing	Side	Duty Cycle	SAR (1g) (W/kg)	Scaling Factor	Reported SAR (1g) (W/kg)	Plot #	
MHz	Ch.																			
707.50	23095	Mid	LTE Band 12	10	24.7	24.67	-0.01	0	Camera Module	08038	QPSK	1	0	10 mm	back	1:1	0.258	1.007	0.260	
707.50	23095	Mid	LTE Band 12	10	23.7	23.65	-0.01	1	Camera Module	08038	QPSK	25	12	10 mm	back	1:1	0.175	1.012	0.177	
707.50	23095	Mid	LTE Band 12	10	24.7	24.67	0.11	0	Camera Module	08038	QPSK	1	0	10 mm	front	1:1	0.113	1.007	0.114	
707.50	23095	Mid	LTE Band 12	10	23.7	23.65	0.00	1	Camera Module	08038	QPSK	25	12	10 mm	front	1:1	0.077	1.012	0.078	
707.50	23095	Mid	LTE Band 12	10	24.7	24.67	-0.02	0	Camera Module	08038	QPSK	1	0	10 mm	bottom	1:1	0.022	1.007	0.022	
707.50	23095	Mid	LTE Band 12	10	23.7	23.65	0.08	1	Camera Module	08038	QPSK	25	12	10 mm	bottom	1:1	0.016	1.012	0.016	
707.50	23095	Mid	LTE Band 12	10	24.7	24.67	-0.11	0	Camera Module	08038	QPSK	1	0	10 mm	right	1:1	0.258	1.007	0.260	
707.50	23095	Mid	LTE Band 12	10	23.7	23.65	-0.03	1	Camera Module	08038	QPSK	25	12	10 mm	right	1:1	0.186	1.012	0.188	
707.50	23095	Mid	LTE Band 12	10	24.7	24.67	-0.02	0	Camera Module	08038	QPSK	1	0	10 mm	left	1:1	0.201	1.007	0.202	
707.50	23095	Mid	LTE Band 12	10	23.7	23.65	0.01	1	Camera Module	08038	QPSK	25	12	10 mm	left	1:1	0.142	1.012	0.144	
ANSI / IEEE C95.1 1992 - SAFETY LIMIT Spatial Peak Uncontrolled Exposure/General Population										Body 1.6 W/kg (mW/g) averaged over 1 gram										

Note: Please see Section 6.8 for details on device positioning for back side with the camera module accessory.

Note: This device supports both LTE Band 12 and LTE Band 17. Since the supported frequency span for LTE Band 17 falls completely within the supported frequency span for LTE Band 12, both LTE bands have the same target power, and both LTE bands share the same transmission path, SAR was only assessed for LTE Band 12.

**Table 11-36
LTE Band 5 (Cell) Hotspot SAR – Ant 1**

MEASUREMENT RESULTS																			
FREQUENCY		Mode	Bandwidth [MHz]	Maximum Allowed Power [dBm]	Conducted Power [dBm]	Power Drift [dB]	MPR [dB]	Accessory	Device Serial Number	Modulation	RB Size	RB Offset	Spacing	Side	Duty Cycle	SAR (1g) (W/kg)	Scaling Factor	Reported SAR (1g) (W/kg)	Plot #
MHz	Ch.																		
836.50	20525	Mid	LTE Band 5 (Cell)	10	24.2	24.11	-0.04	0	08137	QPSK	1	25	10 mm	back	1:1	0.498	1.021	0.508	
836.50	20525	Mid	LTE Band 5 (Cell)	10	23.2	23.18	-0.03	1	08137	QPSK	25	0	10 mm	back	1:1	0.406	1.005	0.408	
836.50	20525	Mid	LTE Band 5 (Cell)	10	24.2	24.11	0.01	0	08137	QPSK	1	25	10 mm	front	1:1	0.427	1.021	0.436	
836.50	20525	Mid	LTE Band 5 (Cell)	10	23.2	23.18	0.01	1	08137	QPSK	25	0	10 mm	front	1:1	0.349	1.005	0.351	
836.50	20525	Mid	LTE Band 5 (Cell)	10	24.2	24.11	-0.14	0	08137	QPSK	1	25	10 mm	bottom	1:1	0.127	1.021	0.130	
836.50	20525	Mid	LTE Band 5 (Cell)	10	23.2	23.18	-0.06	1	08137	QPSK	25	0	10 mm	bottom	1:1	0.104	1.005	0.105	
836.50	20525	Mid	LTE Band 5 (Cell)	10	24.2	24.11	0.03	0	08137	QPSK	1	25	10 mm	right	1:1	0.217	1.021	0.222	
836.50	20525	Mid	LTE Band 5 (Cell)	10	23.2	23.18	0.00	1	08137	QPSK	25	0	10 mm	right	1:1	0.177	1.005	0.178	
836.50	20525	Mid	LTE Band 5 (Cell)	10	24.2	24.11	-0.01	0	08137	QPSK	1	25	10 mm	left	1:1	0.533	1.021	0.544	A25
836.50	20525	Mid	LTE Band 5 (Cell)	10	23.2	23.18	-0.07	1	08137	QPSK	25	0	10 mm	left	1:1	0.445	1.005	0.447	
ANSI / IEEE C95.1 1992 - SAFETY LIMIT Spatial Peak Uncontrolled Exposure/General Population										Body 1.6 W/kg (mW/g) averaged over 1 gram									

**Table 11-37
LTE Band 5 (Cell) Hotspot SAR with CM Accessory – Ant 1**

MEASUREMENT RESULTS																				
FREQUENCY		Mode	Bandwidth [MHz]	Maximum Allowed Power [dBm]	Conducted Power [dBm]	Power Drift [dB]	MPR [dB]	Accessory	Device Serial Number	Modulation	RB Size	RB Offset	Spacing	Side	Duty Cycle	SAR (1g) (W/kg)	Scaling Factor	Reported SAR (1g) (W/kg)	Plot #	
MHz	Ch.																			
836.50	20525	Mid	LTE Band 5 (Cell)	10	24.2	24.11	0.08	0	Camera Module	08137	QPSK	1	25	10 mm	back	1:1	0.049	1.021	0.050	
836.50	20525	Mid	LTE Band 5 (Cell)	10	23.2	23.18	0.01	1	Camera Module	08137	QPSK	25	0	10 mm	back	1:1	0.041	1.005	0.041	
836.50	20525	Mid	LTE Band 5 (Cell)	10	24.2	24.11	0.12	0	Camera Module	08137	QPSK	1	25	10 mm	front	1:1	0.023	1.021	0.023	
836.50	20525	Mid	LTE Band 5 (Cell)	10	23.2	23.18	0.08	1	Camera Module	08137	QPSK	25	0	10 mm	front	1:1	0.018	1.005	0.018	
836.50	20525	Mid	LTE Band 5 (Cell)	10	24.2	24.11	0.19	0	Camera Module	08137	QPSK	1	25	10 mm	bottom	1:1	0.038	1.021	0.039	
836.50	20525	Mid	LTE Band 5 (Cell)	10	23.2	23.18	0.08	1	Camera Module	08137	QPSK	25	0	10 mm	bottom	1:1	0.032	1.005	0.032	
836.50	20525	Mid	LTE Band 5 (Cell)	10	24.2	24.11	0.16	0	Camera Module	08137	QPSK	1	25	10 mm	right	1:1	0.015	1.021	0.015	
836.50	20525	Mid	LTE Band 5 (Cell)	10	23.2	23.18	0.00	1	Camera Module	08137	QPSK	25	0	10 mm	right	1:1	0.014	1.005	0.014	
836.50	20525	Mid	LTE Band 5 (Cell)	10	24.2	24.11	0.13	0	Camera Module	08137	QPSK	1	25	10 mm	left	1:1	0.022	1.021	0.022	
836.50	20525	Mid	LTE Band 5 (Cell)	10	23.2	23.18	0.15	1	Camera Module	08137	QPSK	25	0	10 mm	left	1:1	0.021	1.005	0.021	
ANSI / IEEE C95.1 1992 - SAFETY LIMIT Spatial Peak Uncontrolled Exposure/General Population										Body 1.6 W/kg (mW/g) averaged over 1 gram										

Note: Please see Section 6.8 for details on device positioning for back side with the camera module accessory.



FCC ID: ZNFH820		SAR EVALUATION REPORT		Reviewed by: Quality Manager
Document S/N: 0Y1601290203-R5.ZNF	Test Dates: 01/28/16 - 03/03/16	DUT Type: Portable Handset	Page 62 of 82	

Table 11-38
LTE Band 4 (AWS) Hotspot SAR – Ant 2,3

MEASUREMENT RESULTS																				
FREQUENCY		Mode	Bandwidth [MHz]	Maximum Allowed Power [dBm]	Conducted Power [dBm]	Power Drift [dB]	MPR [dB]	Antenna Config.	Device Serial Number	Modulation	RB Size	RB Offset	Spacing	Side	Duty Cycle	SAR (1g)	Scaling Factor	Reported SAR (1g)	Plot #	
MHz	Ch.															(W/kg)		(W/kg)		
1732.50	20175	Mid	LTE Band 4 (AWS)	20	24.7	24.60	0.02	0	Ant 2	08137	QPSK	1	0	10 mm	back	1:1	1.090	1.023	1.115	A26
1732.50	20175	Mid	LTE Band 4 (AWS)	20	23.7	23.63	0.05	1	Ant 2	08137	QPSK	50	25	10 mm	back	1:1	0.813	1.016	0.826	
1732.50	20175	Mid	LTE Band 4 (AWS)	20	23.7	23.60	0.03	1	Ant 2	08137	QPSK	100	0	10 mm	back	1:1	0.736	1.023	0.753	
1732.50	20175	Mid	LTE Band 4 (AWS)	20	24.7	24.60	-0.08	0	Ant 2	08137	QPSK	1	0	10 mm	front	1:1	0.786	1.023	0.804	
1732.50	20175	Mid	LTE Band 4 (AWS)	20	23.7	23.63	-0.02	1	Ant 2	08137	QPSK	50	25	10 mm	front	1:1	0.614	1.016	0.624	
1732.50	20175	Mid	LTE Band 4 (AWS)	20	23.7	23.60	-0.07	1	Ant 2	08137	QPSK	100	0	10 mm	front	1:1	0.541	1.023	0.553	
1732.50	20175	Mid	LTE Band 4 (AWS)	20	24.7	24.60	0.06	0	Ant 2	08137	QPSK	1	0	10 mm	bottom	1:1	0.586	1.023	0.599	
1732.50	20175	Mid	LTE Band 4 (AWS)	20	23.7	23.63	0.13	1	Ant 2	08137	QPSK	50	25	10 mm	bottom	1:1	0.468	1.016	0.475	
1732.50	20175	Mid	LTE Band 4 (AWS)	20	24.7	24.60	-0.06	0	Ant 2	08137	QPSK	1	0	10 mm	right	1:1	0.724	1.023	0.741	
1732.50	20175	Mid	LTE Band 4 (AWS)	20	23.7	23.63	-0.05	1	Ant 2	08137	QPSK	50	25	10 mm	right	1:1	0.525	1.016	0.533	
1732.50	20175	Mid	LTE Band 4 (AWS)	20	24.7	24.60	-0.06	0	Ant 3	08046	QPSK	1	0	10 mm	back	1:1	0.356	1.023	0.364	
1732.50	20175	Mid	LTE Band 4 (AWS)	20	23.7	23.63	-0.01	1	Ant 3	08046	QPSK	50	25	10 mm	back	1:1	0.286	1.016	0.291	
1732.50	20175	Mid	LTE Band 4 (AWS)	20	24.7	24.60	0.06	0	Ant 3	08046	QPSK	1	0	10 mm	front	1:1	0.456	1.023	0.466	
1732.50	20175	Mid	LTE Band 4 (AWS)	20	23.7	23.63	0.16	1	Ant 3	08046	QPSK	50	25	10 mm	front	1:1	0.378	1.016	0.384	
1732.50	20175	Mid	LTE Band 4 (AWS)	20	24.7	24.60	-0.06	0	Ant 3	08046	QPSK	1	0	10 mm	top	1:1	0.673	1.023	0.688	
1732.50	20175	Mid	LTE Band 4 (AWS)	20	23.7	23.63	0.03	1	Ant 3	08046	QPSK	50	25	10 mm	top	1:1	0.525	1.016	0.533	
1732.50	20175	Mid	LTE Band 4 (AWS)	20	24.7	24.60	-0.01	0	Ant 3	08046	QPSK	1	0	10 mm	right	1:1	0.038	1.023	0.039	
1732.50	20175	Mid	LTE Band 4 (AWS)	20	23.7	23.63	0.21	1	Ant 3	08046	QPSK	50	25	10 mm	right	1:1	0.031	1.016	0.031	
1732.50	20175	Mid	LTE Band 4 (AWS)	20	24.7	24.60	0.12	0	Ant 3	08046	QPSK	1	0	10 mm	left	1:1	0.035	1.023	0.036	
1732.50	20175	Mid	LTE Band 4 (AWS)	20	23.7	23.63	0.07	1	Ant 3	08046	QPSK	50	25	10 mm	left	1:1	0.030	1.016	0.030	
1732.50	20175	Mid	LTE Band 4 (AWS)	20	24.7	24.60	0.03	0	Ant 2	08137	QPSK	1	0	10 mm	back	1:1	1.040	1.023	1.064	
ANSI / IEEE C95.1 1992 - SAFETY LIMIT										Body										
Spatial Peak										1.6 W/kg (mW/g)										
Uncontrolled Exposure/General Population										averaged over 1 gram										

Note: Blue entry represents variability measurement.



Note: SAR highlighted in orange above is the highest SAR per exposure condition and equipment class to be listed on the grants.

Table 11-39
LTE Band 4 (AWS) Hotspot SAR with CM Accessory – Ant 2

MEASUREMENT RESULTS																					
FREQUENCY		Mode	Bandwidth [MHz]	Maximum Allowed Power [dBm]	Conducted Power [dBm]	Accessory	Power Drift [dB]	MPR [dB]	Antenna Config.	Device Serial Number	Modulation	RB Size	RB Offset	Spacing	Side	Duty Cycle	SAR (1g)	Scaling Factor	Reported SAR (1g)	Plot #	
MHz	Ch.																(W/kg)		(W/kg)		
1732.50	20175	Mid	LTE Band 4 (AWS)	20	24.7	24.60	Camera Module	-0.02	0	Ant 2	08137	QPSK	1	0	10 mm	back	1:1	0.360	1.023	0.368	
1732.50	20175	Mid	LTE Band 4 (AWS)	20	23.7	23.63	Camera Module	0.01	1	Ant 2	08137	QPSK	50	25	10 mm	back	1:1	0.248	1.016	0.252	
1732.50	20175	Mid	LTE Band 4 (AWS)	20	24.7	24.60	Camera Module	0.00	0	Ant 2	08137	QPSK	1	0	10 mm	front	1:1	0.360	1.023	0.368	
1732.50	20175	Mid	LTE Band 4 (AWS)	20	23.7	23.63	Camera Module	0.06	1	Ant 2	08137	QPSK	50	25	10 mm	front	1:1	0.253	1.016	0.257	
1732.50	20175	Mid	LTE Band 4 (AWS)	20	24.7	24.60	Camera Module	0.00	0	Ant 2	08137	QPSK	1	0	10 mm	bottom	1:1	0.195	1.023	0.199	
1732.50	20175	Mid	LTE Band 4 (AWS)	20	23.7	23.63	Camera Module	0.03	1	Ant 2	08137	QPSK	50	25	10 mm	bottom	1:1	0.125	1.016	0.127	
1732.50	20175	Mid	LTE Band 4 (AWS)	20	24.7	24.60	Camera Module	-0.05	0	Ant 2	08137	QPSK	1	0	10 mm	right	1:1	0.287	1.023	0.294	
1732.50	20175	Mid	LTE Band 4 (AWS)	20	23.7	23.63	Camera Module	-0.03	1	Ant 2	08137	QPSK	50	25	10 mm	right	1:1	0.187	1.016	0.190	
ANSI / IEEE C95.1 1992 - SAFETY LIMIT										Body											
Spatial Peak										1.6 W/kg (mW/g)											
Uncontrolled Exposure/General Population										averaged over 1 gram											

Note: Please see Section 6.8 for details on device positioning for back side with the camera module accessory.

Note: The camera module accessory replaces the bottom of the device below the screen where Antennas 1 and 2 are located. Therefore, additional SAR tests were performed with the camera module accessory attached for these antennas. Due to the location at the top of the device, no additional SAR measurements were needed for Antenna 3 with the camera module accessory attached.

FCC ID: ZNFH820		SAR EVALUATION REPORT		Reviewed by: Quality Manager
Document S/N: 0Y1601290203-R5.ZNF	Test Dates: 01/28/16 - 03/03/16	DUT Type: Portable Handset	Page 63 of 82	

**Table 11-40
LTE Band 2 (PCS) Hotspot SAR – Ant 2,3**



MEASUREMENT RESULTS																				
FREQUENCY		Mode	Bandwidth [MHz]	Maximum Allowed Power [dBm]	Conducted Power [dBm]	Power Drift [dB]	MPR [dB]	Antenna Config.	Device Serial Number	Modulation	RB Size	RB Offset	Spacing	Side	Duty Cycle	SAR (1g) (W/kg)	Scaling Factor	Reported SAR (1g) (W/kg)	Plot #	
MHz	Ch.																			
1860.00	18700	Low	LTE Band 2 (PCS)	20	24.7	24.60	0.10	0	Ant 2	08137	QPSK	1	50	10 mm	back	1:1	0.747	1.023	0.764	
1880.00	18900	Mid	LTE Band 2 (PCS)	20	24.7	24.65	0.04	0	Ant 2	08137	QPSK	1	0	10 mm	back	1:1	1.020	1.012	1.032	
1900.00	19100	High	LTE Band 2 (PCS)	20	24.7	24.70	-0.01	0	Ant 2	08137	QPSK	1	99	10 mm	back	1:1	1.020	1.000	1.020	
1860.00	18700	Low	LTE Band 2 (PCS)	20	23.7	23.65	0.01	1	Ant 2	08137	QPSK	50	25	10 mm	back	1:1	0.623	1.012	0.630	
1880.00	18900	Mid	LTE Band 2 (PCS)	20	23.7	23.59	0.02	1	Ant 2	08137	QPSK	50	0	10 mm	back	1:1	0.726	1.026	0.745	
1900.00	19100	High	LTE Band 2 (PCS)	20	23.7	23.67	-0.01	1	Ant 2	08137	QPSK	50	50	10 mm	back	1:1	0.797	1.007	0.803	
1900.00	19100	High	LTE Band 2 (PCS)	20	23.7	23.63	0.01	1	Ant 2	08137	QPSK	100	0	10 mm	back	1:1	0.798	1.016	0.811	
1900.00	19100	High	LTE Band 2 (PCS)	20	24.7	24.70	-0.02	0	Ant 2	08137	QPSK	1	99	10 mm	front	1:1	0.595	1.000	0.595	
1900.00	19100	High	LTE Band 2 (PCS)	20	23.7	23.67	-0.10	1	Ant 2	08137	QPSK	50	50	10 mm	front	1:1	0.460	1.007	0.463	
1900.00	19100	High	LTE Band 2 (PCS)	20	24.7	24.70	0.02	0	Ant 2	08137	QPSK	1	99	10 mm	bottom	1:1	0.641	1.000	0.641	
1900.00	19100	High	LTE Band 2 (PCS)	20	23.7	23.67	-0.02	1	Ant 2	08137	QPSK	50	50	10 mm	bottom	1:1	0.458	1.007	0.461	
1860.00	18700	Low	LTE Band 2 (PCS)	20	24.7	24.60	0.02	0	Ant 2	08137	QPSK	1	50	10 mm	right	1:1	0.653	1.023	0.668	
1880.00	18900	Mid	LTE Band 2 (PCS)	20	24.7	24.65	-0.07	0	Ant 2	08137	QPSK	1	0	10 mm	right	1:1	0.885	1.012	0.896	
1900.00	19100	High	LTE Band 2 (PCS)	20	24.7	24.70	0.02	0	Ant 2	08137	QPSK	1	99	10 mm	right	1:1	0.830	1.000	0.830	
1900.00	19100	High	LTE Band 2 (PCS)	20	23.7	23.67	0.01	1	Ant 2	08137	QPSK	50	50	10 mm	right	1:1	0.634	1.007	0.638	
1900.00	19100	High	LTE Band 2 (PCS)	20	23.7	23.63	0.04	1	Ant 2	08137	QPSK	100	0	10 mm	right	1:1	0.657	1.016	0.668	
1900.00	19100	High	LTE Band 2 (PCS)	20	24.7	24.70	-0.07	0	Ant 3	08046	QPSK	1	99	10 mm	back	1:1	0.343	1.000	0.343	
1900.00	19100	High	LTE Band 2 (PCS)	20	23.7	23.67	-0.08	1	Ant 3	08046	QPSK	50	50	10 mm	back	1:1	0.287	1.007	0.289	
1900.00	19100	High	LTE Band 2 (PCS)	20	24.7	24.70	0.12	0	Ant 3	08046	QPSK	1	99	10 mm	front	1:1	0.440	1.000	0.440	
1900.00	19100	High	LTE Band 2 (PCS)	20	23.7	23.67	0.02	1	Ant 3	08046	QPSK	50	50	10 mm	front	1:1	0.361	1.007	0.364	
1860.00	18700	Low	LTE Band 2 (PCS)	20	24.7	24.60	-0.05	0	Ant 3	08046	QPSK	1	50	10 mm	top	1:1	0.881	1.023	0.901	
1880.00	18900	Mid	LTE Band 2 (PCS)	20	24.7	24.65	0.00	0	Ant 3	08046	QPSK	1	0	10 mm	top	1:1	1.050	1.012	1.063	A28
1900.00	19100	High	LTE Band 2 (PCS)	20	24.7	24.70	0.00	0	Ant 3	08046	QPSK	1	99	10 mm	top	1:1	0.845	1.000	0.845	
1900.00	19100	High	LTE Band 2 (PCS)	20	23.7	23.67	-0.04	1	Ant 3	08046	QPSK	50	50	10 mm	top	1:1	0.671	1.007	0.676	
1900.00	19100	High	LTE Band 2 (PCS)	20	23.7	23.63	-0.17	1	Ant 3	08046	QPSK	100	0	10 mm	top	1:1	0.704	1.016	0.715	
1900.00	19100	High	LTE Band 2 (PCS)	20	24.7	24.70	-0.08	0	Ant 3	08046	QPSK	1	99	10 mm	right	1:1	0.036	1.000	0.036	
1900.00	19100	High	LTE Band 2 (PCS)	20	23.7	23.67	0.08	1	Ant 3	08046	QPSK	50	50	10 mm	right	1:1	0.031	1.007	0.031	
1900.00	19100	High	LTE Band 2 (PCS)	20	24.7	24.70	0.08	0	Ant 3	08046	QPSK	1	99	10 mm	left	1:1	0.043	1.000	0.043	
1900.00	19100	High	LTE Band 2 (PCS)	20	23.7	23.67	0.06	1	Ant 3	08046	QPSK	50	50	10 mm	left	1:1	0.031	1.007	0.031	
ANSI / IEEE C95.1 1992 - SAFETY LIMIT Spatial Peak Uncontrolled Exposure/General Population										Body 1.6 W/kg (mW/g) averaged over 1 gram										

**Table 11-41
LTE Band 2 (PCS) Hotspot SAR with CM Accessory – Ant 2**

MEASUREMENT RESULTS																					
FREQUENCY		Mode	Bandwidth [MHz]	Maximum Allowed Power [dBm]	Conducted Power [dBm]	Accessory	Power Drift [dB]	MPR [dB]	Antenna Config.	Device Serial Number	Modulation	RB Size	RB Offset	Spacing	Side	Duty Cycle	SAR (1g) (W/kg)	Scaling Factor	Reported SAR (1g) (W/kg)	Plot #	
MHz	Ch.																				
1900.00	19100	High	LTE Band 2 (PCS)	20	24.7	24.70	Camera Module	0.01	0	Ant 2	08137	QPSK	1	99	10 mm	back	1:1	0.395	1.000	0.395	
1900.00	19100	High	LTE Band 2 (PCS)	20	23.7	23.67	Camera Module	0.00	1	Ant 2	08137	QPSK	50	50	10 mm	back	1:1	0.279	1.007	0.281	
1900.00	19100	High	LTE Band 2 (PCS)	20	24.7	24.70	Camera Module	-0.01	0	Ant 2	08137	QPSK	1	99	10 mm	front	1:1	0.349	1.000	0.349	
1900.00	19100	High	LTE Band 2 (PCS)	20	23.7	23.67	Camera Module	0.01	1	Ant 2	08137	QPSK	50	50	10 mm	front	1:1	0.280	1.007	0.282	
1900.00	19100	High	LTE Band 2 (PCS)	20	24.7	24.70	Camera Module	-0.02	0	Ant 2	08137	QPSK	1	99	10 mm	bottom	1:1	0.371	1.000	0.371	
1900.00	19100	High	LTE Band 2 (PCS)	20	23.7	23.67	Camera Module	-0.04	1	Ant 2	08137	QPSK	50	50	10 mm	bottom	1:1	0.274	1.007	0.276	
1900.00	19100	High	LTE Band 2 (PCS)	20	24.7	24.70	Camera Module	0.01	0	Ant 2	08137	QPSK	1	99	10 mm	right	1:1	0.478	1.000	0.478	
1900.00	19100	High	LTE Band 2 (PCS)	20	23.7	23.67	Camera Module	0.03	1	Ant 2	08137	QPSK	50	50	10 mm	right	1:1	0.363	1.007	0.366	
ANSI / IEEE C95.1 1992 - SAFETY LIMIT Spatial Peak Uncontrolled Exposure/General Population										Body 1.6 W/kg (mW/g) averaged over 1 gram											

Note: Please see Section 6.8 for details on device positioning for back side with the camera module accessory.

Note: The camera module accessory replaces the bottom of the device below the screen where Antennas 1 and 2 are located. Therefore, additional SAR tests were performed with the camera module accessory attached for these antennas. Due to the location at the top of the device, no additional SAR measurements were needed for Antenna 3 with the camera module accessory attached.

FCC ID: ZNFH820		SAR EVALUATION REPORT		Reviewed by: Quality Manager
Document S/N: 0Y1601290203-R5.ZNF	Test Dates: 01/28/16 - 03/03/16	DUT Type: Portable Handset	Page 64 of 82	

**Table 11-42
LTE Band 30 Hotspot SAR – Ant 1**

MEASUREMENT RESULTS																			
FREQUENCY		Mode	Bandwidth [MHz]	Maximum Allowed Power [dBm]	Conducted Power [dBm]	Power Drift [dB]	MPR [dB]	Device Serial Number	Modulation	RB Size	RB Offset	Spacing	Side	Duty Cycle	SAR (1g)	Scaling Factor	Reported SAR (1g)	Plot #	
MHz	Ch.														(W/kg)		(W/kg)		
2310.00	27710	Mid	LTE Band 30	10	23.7	23.70	-0.03	0	08038	QPSK	1	0	10 mm	back	1:1	0.324	1.000	0.324	
2310.00	27710	Mid	LTE Band 30	10	22.7	22.62	0.01	1	08038	QPSK	25	25	10 mm	back	1:1	0.226	1.019	0.230	
2310.00	27710	Mid	LTE Band 30	10	23.7	23.70	-0.01	0	08038	QPSK	1	0	10 mm	front	1:1	0.139	1.000	0.139	
2310.00	27710	Mid	LTE Band 30	10	22.7	22.62	-0.01	1	08038	QPSK	25	25	10 mm	front	1:1	0.107	1.019	0.109	
2310.00	27710	Mid	LTE Band 30	10	23.7	23.70	-0.03	0	08038	QPSK	1	0	10 mm	bottom	1:1	0.064	1.000	0.064	
2310.00	27710	Mid	LTE Band 30	10	22.7	22.62	-0.02	1	08038	QPSK	25	25	10 mm	bottom	1:1	0.046	1.019	0.047	
2310.00	27710	Mid	LTE Band 30	10	23.7	23.70	-0.16	0	08038	QPSK	1	0	10 mm	right	1:1	0.006	1.000	0.006	
2310.00	27710	Mid	LTE Band 30	10	22.7	22.62	-0.10	1	08038	QPSK	25	25	10 mm	right	1:1	0.004	1.019	0.004	
2310.00	27710	Mid	LTE Band 30	10	23.7	23.70	0.02	0	08038	QPSK	1	0	10 mm	left	1:1	0.155	1.000	0.155	
2310.00	27710	Mid	LTE Band 30	10	22.7	22.62	-0.05	1	08038	QPSK	25	25	10 mm	left	1:1	0.120	1.019	0.122	
ANSI / IEEE C95.1 1992 - SAFETY LIMIT Spatial Peak Uncontrolled Exposure/General Population							Body 1.6 W/kg (mW/g) averaged over 1 gram												

**Table 11-43
LTE Band 30 Hotspot SAR with CM Accessory – Ant 1**

MEASUREMENT RESULTS																				
FREQUENCY		Mode	Bandwidth [MHz]	Maximum Allowed Power [dBm]	Conducted Power [dBm]	Accessory	Power Drift [dB]	MPR [dB]	Device Serial Number	Modulation	RB Size	RB Offset	Spacing	Side	Duty Cycle	SAR (1g)	Scaling Factor	Reported SAR (1g)	Plot #	
MHz	Ch.															(W/kg)		(W/kg)		
2310.00	27710	Mid	LTE Band 30	10	23.7	23.70	Camera Module	0.05	0	08038	QPSK	1	0	10 mm	back	1:1	0.274	1.000	0.274	
2310.00	27710	Mid	LTE Band 30	10	22.7	22.62	Camera Module	0.05	1	08038	QPSK	25	25	10 mm	back	1:1	0.211	1.019	0.215	
2310.00	27710	Mid	LTE Band 30	10	23.7	23.70	Camera Module	0.10	0	08038	QPSK	1	0	10 mm	front	1:1	0.191	1.000	0.191	
2310.00	27710	Mid	LTE Band 30	10	22.7	22.62	Camera Module	-0.06	1	08038	QPSK	25	25	10 mm	front	1:1	0.140	1.019	0.143	
2310.00	27710	Mid	LTE Band 30	10	23.7	23.70	Camera Module	0.08	0	08038	QPSK	1	0	10 mm	bottom	1:1	0.455	1.000	0.455	A30
2310.00	27710	Mid	LTE Band 30	10	22.7	22.62	Camera Module	0.01	1	08038	QPSK	25	25	10 mm	bottom	1:1	0.369	1.019	0.376	
2310.00	27710	Mid	LTE Band 30	10	23.7	23.70	Camera Module	-0.11	0	08038	QPSK	1	0	10 mm	right	1:1	0.055	1.000	0.055	
2310.00	27710	Mid	LTE Band 30	10	22.7	22.62	Camera Module	0.08	1	08038	QPSK	25	25	10 mm	right	1:1	0.037	1.019	0.038	
2310.00	27710	Mid	LTE Band 30	10	23.7	23.70	Camera Module	0.12	0	08038	QPSK	1	0	10 mm	left	1:1	0.062	1.000	0.062	
2310.00	27710	Mid	LTE Band 30	10	22.7	22.62	Camera Module	-0.09	1	08038	QPSK	25	25	10 mm	left	1:1	0.044	1.019	0.045	
ANSI / IEEE C95.1 1992 - SAFETY LIMIT Spatial Peak Uncontrolled Exposure/General Population							Body 1.6 W/kg (mW/g) averaged over 1 gram													

Note: Please see Section 6.8 for details on device positioning for back side with the camera module accessory.

**Table 11-44
LTE Band 7 Hotspot SAR – Ant 1**

MEASUREMENT RESULTS																			
FREQUENCY		Mode	Bandwidth [MHz]	Maximum Allowed Power [dBm]	Conducted Power [dBm]	Power Drift [dB]	MPR [dB]	Device Serial Number	Modulation	RB Size	RB Offset	Spacing	Side	Duty Cycle	SAR (1g)	Scaling Factor	Reported SAR (1g)	Plot #	
MHz	Ch.														(W/kg)		(W/kg)		
2510.00	20850	Low	LTE Band 7	20	24.7	24.70	-0.07	0	08137	QPSK	1	99	10 mm	back	1:1	0.306	1.000	0.306	
2510.00	20850	Low	LTE Band 7	20	23.7	23.69	-0.08	1	08137	QPSK	50	0	10 mm	back	1:1	0.246	1.002	0.246	
2510.00	20850	Low	LTE Band 7	20	24.7	24.70	-0.02	0	08137	QPSK	1	99	10 mm	front	1:1	0.108	1.000	0.108	
2510.00	20850	Low	LTE Band 7	20	23.7	23.69	0.02	1	08137	QPSK	50	0	10 mm	front	1:1	0.083	1.002	0.083	
2510.00	20850	Low	LTE Band 7	20	24.7	24.70	0.13	0	08137	QPSK	1	99	10 mm	bottom	1:1	0.085	1.000	0.085	
2510.00	20850	Low	LTE Band 7	20	23.7	23.69	0.05	1	08137	QPSK	50	0	10 mm	bottom	1:1	0.071	1.002	0.071	
2510.00	20850	Low	LTE Band 7	20	24.7	24.70	0.09	0	08137	QPSK	1	99	10 mm	right	1:1	0.045	1.000	0.045	
2510.00	20850	Low	LTE Band 7	20	23.7	23.69	0.21	1	08137	QPSK	50	0	10 mm	right	1:1	0.036	1.002	0.036	
2510.00	20850	Low	LTE Band 7	20	24.7	24.70	0.08	0	08137	QPSK	1	99	10 mm	left	1:1	0.122	1.000	0.122	
2510.00	20850	Low	LTE Band 7	20	23.7	23.69	0.13	1	08137	QPSK	50	0	10 mm	left	1:1	0.084	1.002	0.084	
ANSI / IEEE C95.1 1992 - SAFETY LIMIT Spatial Peak Uncontrolled Exposure/General Population							Body 1.6 W/kg (mW/g) averaged over 1 gram												



FCC ID: ZNFH820		SAR EVALUATION REPORT		Reviewed by: Quality Manager
Document S/N: 0Y1601290203-R5.ZNF	Test Dates: 01/28/16 - 03/03/16	DUT Type: Portable Handset	Page 65 of 82	

Table 11-45
LTE Band 7 Hotspot SAR with CM Accessory – Ant 1

MEASUREMENT RESULTS																				
FREQUENCY		Mode	Bandwidth [MHz]	Maximum Allowed Power [dBm]	Conducted Power [dBm]	Accessory	Power Drift [dB]	MPR[dB]	Device Serial Number	Modulation	RB Size	RB Offset	Spacing	Side	Duty Cycle	SAR (1g)	Scaling Factor	Reported SAR (1g)	Plot #	
MHz	Ch.															(W/kg)		(W/kg)		
2510.00	20850	Low	LTE Band 7	20	24.7	24.70	Camera Module	-0.09	0	08137	QPSK	1	99	10 mm	back	1:1	0.571	1.000	0.571	A31
2510.00	20850	Low	LTE Band 7	20	23.7	23.69	Camera Module	0.04	1	08137	QPSK	50	0	10 mm	back	1:1	0.491	1.002	0.492	
2510.00	20850	Low	LTE Band 7	20	24.7	24.70	Camera Module	0.02	0	08137	QPSK	1	99	10 mm	front	1:1	0.330	1.000	0.330	
2510.00	20850	Low	LTE Band 7	20	23.7	23.69	Camera Module	-0.05	1	08137	QPSK	50	0	10 mm	front	1:1	0.276	1.002	0.277	
2510.00	20850	Low	LTE Band 7	20	24.7	24.70	Camera Module	-0.02	0	08137	QPSK	1	99	10 mm	bottom	1:1	0.412	1.000	0.412	
2510.00	20850	Low	LTE Band 7	20	23.7	23.69	Camera Module	0.02	1	08137	QPSK	50	0	10 mm	bottom	1:1	0.369	1.002	0.370	
2510.00	20850	Low	LTE Band 7	20	24.7	24.70	Camera Module	0.04	0	08137	QPSK	1	99	10 mm	right	1:1	0.123	1.000	0.123	
2510.00	20850	Low	LTE Band 7	20	23.7	23.69	Camera Module	0.10	1	08137	QPSK	50	0	10 mm	right	1:1	0.110	1.002	0.110	
2510.00	20850	Low	LTE Band 7	20	24.7	24.70	Camera Module	0.03	0	08137	QPSK	1	99	10 mm	left	1:1	0.205	1.000	0.205	
2510.00	20850	Low	LTE Band 7	20	23.7	23.69	Camera Module	0.00	1	08137	QPSK	50	0	10 mm	left	1:1	0.160	1.002	0.160	
ANSI / IEEE C95.1 1992 - SAFETY LIMIT Spatial Peak Uncontrolled Exposure/General Population											Body 1.6 W/kg (mW/g) averaged over 1 gram									

Note: Please see Section 6.8 for details on device positioning for back side with the camera module accessory.

Table 11-46
WLAN Hotspot SAR

MEASUREMENT RESULTS																		
FREQUENCY		Mode	Service	Bandwidth [MHz]	Maximum Allowed Power [dBm]	Conducted Power [dBm]	Power Drift [dB]	Spacing	Device Serial Number	Data Rate (Mbps)	Side	Duty Cycle (%)	Peak SAR of Area Scan	SAR (1g)	Scaling Factor (Power)	Scaling Factor (Duty Cycle)	Reported SAR (1g)	Plot #
MHz	Ch.												(W/kg)	(W/kg)			(W/kg)	
2437	6	802.11b	DSSS	22	19.00	18.05	0.05	10 mm	08202	1	back	99.2	0.126	-	1.245	1.008	-	
2437	6	802.11b	DSSS	22	19.00	18.05	0.06	10 mm	08202	1	front	99.2	0.132	0.111	1.245	1.008	0.139	A33
2437	6	802.11b	DSSS	22	19.00	18.05	0.07	10 mm	08202	1	top	99.2	0.118	-	1.245	1.008	-	
2437	6	802.11b	DSSS	22	19.00	18.05	0.06	10 mm	08202	1	left	99.2	0.102	-	1.245	1.008	-	
5745	149	802.11a	OFDM	20	13.25	12.76	-0.11	10 mm	08210	6	back	99.3	0.116	-	1.119	1.007	-	
5745	149	802.11a	OFDM	20	13.25	12.76	-0.12	10 mm	08210	6	front	99.3	0.179	0.070	1.119	1.007	0.079	A35
5745	149	802.11a	OFDM	20	13.25	12.76	0.03	10 mm	08210	6	top	99.3	0.122	-	1.119	1.007	-	
5745	149	802.11a	OFDM	20	13.25	12.76	0.04	10 mm	08210	6	left	99.3	0.032	-	1.119	1.007	-	
ANSI / IEEE C95.1 1992 - SAFETY LIMIT Spatial Peak Uncontrolled Exposure/General Population											Body 1.6 W/kg (mW/g) averaged over 1 gram							

Note: SAR highlighted in orange above is the highest SAR per exposure condition and equipment class to be listed on the grants.

Note: "-" in the table above indicates that the position was not required to be measured per the initial test position procedures in FCC KDB Publication 248227 D01v02r02.

11.5 Standalone 10g Hotspot Mode 0mm SAR Data

Table 11-47
GPRS/UMTS 10g Hotspot Mode 0mm SAR Data with CM Accessory – Ant 1,2

MEASUREMENT RESULTS																		
FREQUENCY		Mode	Service	Maximum Allowed Power [dBm]	Conducted Power [dBm]	Power Drift [dB]	Spacing	Antenna Config.	Accessory	Device Serial Number	# of GPRS Slots	Duty Cycle	Side	SAR (10g)	Scaling Factor	Reported SAR (10g)	Plot #	
MHz	Ch.													(W/kg)		(W/kg)		
836.60	190	GSM 850	GPRS	29.7	29.60	-0.06	0 mm	Ant1	Camera Module	08103	3	1:2.76	back	0.413	1.023	0.422	A37	
836.60	4183	UMTS 850	RMC	24.2	24.11	-0.04	0 mm	Ant1	Camera Module	08103	N/A	1:1	back	0.438	1.021	0.447	A38	
1732.40	1412	UMTS 1750	RMC	24.2	24.20	0.14	0 mm	Ant2	Camera Module	08103	N/A	1:1	back	1.830	1.000	1.830	A39	
1880.00	661	GSM 1900	GPRS	25.7	25.66	0.06	0 mm	Ant2	Camera Module	08103	4	1:2.076	back	0.294	1.009	0.297	A40	
1880.00	9400	UMTS 1900	RMC	24.7	24.59	0.01	0 mm	Ant2	Camera Module	08103	N/A	1:1	back	0.869	1.026	0.892	A41	
ANSI / IEEE C95.1 1992 - SAFETY LIMIT Spatial Peak Uncontrolled Exposure/General Population											10g Hotspot Mode at 0mm SAR 4.0 W/kg (mW/g) averaged over 10 grams							

Note: Please see Section 6.8 for details on device positioning for back side with the camera module accessory.



FCC ID: ZNFH820		SAR EVALUATION REPORT		Reviewed by: Quality Manager
Document S/N: 0Y1601290203-R5.ZNF	Test Dates: 01/28/16 - 03/03/16	DUT Type: Portable Handset		Page 66 of 82

Table 11-48
LTE 10g Hotspot Mode 0mm SAR with CM Accessory – Ant 1,2

MEASUREMENT RESULTS																					
FREQUENCY		Mode	Bandwidth [MHz]	Accessory	Maximum Allowed Power [dBm]	Conducted Power [dBm]	Power Drift [dB]	MPR [dB]	Antenna Config.	Device Serial Number	Modulation	RB Size	RB Offset	Spacing	Side	Duty Cycle	SAR (10g) (W/kg)	Scaling Factor	Reported SAR (10g) (W/kg)	Plot #	
MHz	Ch.																				
707.50	23095	Mid	LTE Band 12	10	Camera Module	24.7	24.67	0.01	0	Ant 1	08038	QPSK	1	0	0 mm	back	1:1	0.423	1.007	0.426	A42
836.50	20525	Mid	LTE Band 5 (Cell)	10	Camera Module	24.2	24.11	-0.06	0	Ant 1	08137	QPSK	1	25	0 mm	back	1:1	0.430	1.021	0.439	A43
1732.50	20175	Mid	LTE Band 4 (AWS)	20	Camera Module	24.7	24.60	0.20	0	Ant 2	08137	QPSK	1	0	0 mm	back	1:1	2.240	1.023	2.292	
1732.50	20175	Mid	LTE Band 4 (AWS)	20	Camera Module	24.7	24.60	0.05	0	Ant 2	08137	QPSK	1	0	0 mm	back	1:1	2.290	1.023	2.343	A44
1900.00	19100	High	LTE Band 2 (PCS)	20	Camera Module	24.7	24.70	0.01	0	Ant 2	08137	QPSK	1	99	0 mm	back	1:1	0.828	1.000	0.828	A45
2310.00	27710	Mid	LTE Band 30	10	Camera Module	23.7	23.70	0.02	0	Ant 1	08038	QPSK	1	0	0 mm	back	1:1	1.010	1.000	1.010	A46
2510.00	20850	Low	LTE Band 7	20	Camera Module	24.7	24.70	-0.13	0	Ant 1	08137	QPSK	1	99	0 mm	back	1:1	1.300	1.000	1.300	A47
ANSI / IEEE C95.1 1992 - SAFETY LIMIT Spatial Peak Uncontrolled Exposure/General Population										10g Hotspot Mode at 0mm SAR 4.0 W/kg (mW/g) averaged over 10 grams											

Note: Blue entry represents variability measurement.

Note: SAR highlighted in orange above is the highest SAR per exposure condition and equipment class to be listed on the grants.

Note: Please see Section 6.8 for details on device positioning for back side with the camera module accessory.

Note: This device supports both LTE Band 12 and LTE Band 17. Since the supported frequency span for LTE Band 17 falls completely within the supported frequency span for LTE Band 12, both LTE bands have the same target power, and both LTE bands share the same transmission path, SAR was only assessed for LTE Band 12.



11.6 SAR Test Notes

General Notes:

- The test data reported are the worst-case SAR values according to test procedures specified in IEEE 1528-2013, and FCC KDB Publication 447498 D01v06.
- Batteries are fully charged at the beginning of the SAR measurements.
- Liquid tissue depth was at least 15.0 cm for all frequencies.
- The manufacturer has confirmed that the device(s) tested have the same physical, mechanical and thermal characteristics and are within operational tolerances expected for production units.
- SAR results were scaled to the maximum allowed power to demonstrate compliance per FCC KDB Publication 447498 D01v06.
- Device was tested using a fixed spacing for body-worn accessory testing. A separation distance of 10 mm was considered because the manufacturer has determined that there will be body-worn accessories available in the marketplace for users to support this separation distance.
- Per FCC KDB Publication 648474 D04v01r03, body-worn SAR was evaluated without a headset connected to the device. Since the standalone reported body-worn SAR was ≤ 1.2 W/kg, no additional body-worn SAR evaluations using a headset cable were required.
- Per FCC KDB 865664 D01v01r04, variability SAR tests were performed when the measured SAR results for a frequency band were greater than or equal to 0.8 W/kg for 1g SAR and 2.0 W/kg for 10g SAR. Repeated SAR measurements are highlighted in the tables above for clarity. Please see Section 13 for variability analysis.
- During SAR Testing for the Wireless Router conditions per FCC KDB Publication 941225 D06v02r01, the actual Portable Hotspot operation (with actual simultaneous transmission of a transmitter with WIFI) was not activated (See Section 6.7 for more details).
- Due to the location of the camera module accessory, SAR was additionally evaluated for the antennas located at the bottom of the device for all exposure conditions.
- Per FCC guidance, the back side with the camera module accessory was additionally evaluated for 10g SAR for each band and mode at 0mm.

GSM Test Notes:

- Body-Worn accessory testing is typically associated with voice operations. Therefore, GSM voice was evaluated for body-worn SAR.
- Justification for reduced test configurations per KDB Publication 941225 D01v03r01 and October 2013 TCB Workshop Notes: The source-based frame-averaged output power was evaluated for all GPRS/EDGE slot configurations. The configuration with the highest target frame averaged output power was evaluated for hotspot SAR. When the maximum frame-averaged powers are equivalent across two or more slots (within 0.25 dB), the configuration with the most number of time slots was tested.
- Per FCC KDB Publication 447498 D01v06, if the reported (scaled) SAR measured at the middle channel or highest output power channel for each test configuration is ≤ 0.8 W/kg then testing at the other channels is not

FCC ID: ZNFH820		SAR EVALUATION REPORT		Reviewed by: Quality Manager
Document S/N: 0Y1601290203-R5.ZNF	Test Dates: 01/28/16 - 03/03/16	DUT Type: Portable Handset		Page 67 of 82

required for such test configuration(s). When the maximum output power variation across the required test channels is $> \frac{1}{2}$ dB, instead of the middle channel, the highest output power channel was used. GPRS was additionally evaluated for head and body-worn exposure conditions to address possible VoIP scenarios.

UMTS Notes:



1. UMTS mode in was tested under RMC 12.2 kbps with HSDPA Inactive per KDB Publication 941225 D01v03r01. AMR and HSPA SAR was not required per the 3G Test Reduction Procedure in KDB Publication 941225 D01v03r01.
2. Per FCC KDB Publication 447498 D01v06, if the reported (scaled) SAR measured at the middle channel or highest output power channel for each test configuration is ≤ 0.8 W/kg then testing at the other channels is not required for such test configuration(s). When the maximum output power variation across the required test channels is $> \frac{1}{2}$ dB, instead of the middle channel, the highest output power channel was used.

LTE Notes:

1. LTE Considerations: LTE test configurations are determined according to SAR Evaluation Considerations for LTE Devices in FCC KDB Publication 941225 D05v02r04. The general test procedures used for testing can be found in Section 8.5.4.
2. MPR is permanently implemented for this device by the manufacturer. The specific manufacturer target MPR is indicated alongside the SAR results. MPR is enabled for this device, according to 3GPP TS36.101 Section 6.2.3 – 6.2.5 under Table 6.2.3-1.
3. A-MPR was disabled for all SAR tests by setting NS=01 on the base station simulator. SAR tests were performed with the same number of RB and RB offsets transmitting on all TTI frames (maximum TTI).
4. Per KDB Publication 941225 D05Av01r02, SAR for LTE CA operations was not needed since the maximum average output power in LTE CA mode was not >0.25 dB higher than the maximum output power when downlink carrier aggregation was inactive.

WLAN Notes:

1. For held-to-ear and hotspot operations, the initial test position procedures were applied. The test position with the highest extrapolated peak SAR will be used as the initial test position. When reported SAR for the initial test position is ≤ 0.4 W/kg, no additional testing for the remaining test positions was required. Otherwise, SAR is evaluated at the subsequent highest peak SAR positions until the reported SAR result is ≤ 0.8 W/kg or all test positions are measured.
2. Justification for test configurations for WLAN per KDB Publication 248227 D01v02r02 for 2.4 GHz WIFI single transmission chain operations, the highest measured maximum output power channel for DSSS was selected for SAR measurement. SAR for OFDM modes (2.4 GHz 802.11g/n/ac) was not required due to the maximum allowed powers and the highest reported DSSS SAR. See Section 8.6.5 for more information.
3. Justification for test configurations for WLAN per KDB Publication 248227 D01v02r02 for 5 GHz WIFI single transmission chain operations, the initial test configuration was selected according to the transmission mode with the highest maximum allowed powers. Other transmission modes were not investigated since the highest reported SAR for initial test configuration adjusted by the ratio of maximum output powers is less than 1.2 W/kg. See Section 8.6.6 for more information.
4. When the maximum reported 1g averaged SAR is ≤ 0.8 W/kg, SAR testing on additional channels was not required. Otherwise, SAR for the next highest output power channel was required until the reported SAR result was ≤ 1.20 W/kg or all test channels were measured.
5. The device was configured to transmit continuously at the required data rate, channel bandwidth and signal modulation, using the highest transmission duty factor supported by the test mode tools. The reported SAR was scaled to the 100% transmission duty factor to determine compliance. Procedures used to measure the duty factor are identical to that in the associated EMC test reports.

FCC ID: ZNFH820		SAR EVALUATION REPORT		Reviewed by: Quality Manager
Document S/N: 0Y1601290203-R5.ZNF	Test Dates: 01/28/16 - 03/03/16	DUT Type: Portable Handset	Page 68 of 82	

12 FCC MULTI-TX AND ANTENNA SAR CONSIDERATIONS

12.1 Introduction

The following procedures adopted from FCC KDB Publication 447498 D01v06 are applicable to devices with built-in unlicensed transmitters such as 802.11 and Bluetooth devices which may simultaneously transmit with the licensed transmitter.

12.2 Simultaneous Transmission Procedures

This device contains transmitters that may operate simultaneously. Therefore simultaneous transmission analysis is required. Per FCC KDB Publication 447498 D01v06 4.3.2 and IEEE 1528-2013 Section 6.3.4.1.2, simultaneous transmission SAR test exclusion may be applied when the sum of the 1-g SAR for all the simultaneous transmitting antennas in a specific a physical test configuration is ≤ 1.6 W/kg. The different test positions in an exposure condition may be considered collectively to determine SAR test exclusion according to the sum of 1-g or 10-g SAR.

Notes:

1. Held-to ear configurations are not applicable to Bluetooth operations and therefore were not considered for simultaneous transmission.
2. BT/WLAN SAR testing was not required for 10g Hotspot Mode 0mmSAR exposure conditions per FCC Guidance. Therefore, no further analysis was required to determine that possible simultaneous scenarios would not exceed the SAR limit

12.3 Head SAR Simultaneous Transmission Analysis

Table 12-1
Simultaneous Transmission Scenario with 2.4 GHz WLAN (Held to Ear)

Exposure Condition	Mode	2G/3G/4G SAR (W/kg)	2.4 GHz WLAN SAR (W/kg)	Σ SAR (W/kg)
		1	2	1+2
Head SAR	GSM/GPRS 850	0.747	1.024	See Table 12-2
	UMTS 850	0.405	1.024	1.429
	UMTS 1750	0.638	1.024	See Table 12-2
	GSM/GPRS 1900	0.248	1.024	1.272
	UMTS 1900	0.630	1.024	See Table 12-2
	LTE Band 12	0.233	1.024	1.257
	LTE Band 5 (Cell)	0.384	1.024	1.408
	LTE Band 4 (AWS)	0.757	1.024	See Table 12-2
	LTE Band 2 (PCS)	0.821	1.024	See Table 12-2
	LTE Band 30	0.156	1.024	1.180
LTE Band 7	0.233	1.024	1.257	

Note: When possible, the highest reported SAR for each transmission modes for all test positions antennas and with and without the accessory were considered collectively to evaluate the worst case simultaneous transmission exclusion scenarios. Additional simultaneous transmission exclusion analysis at specific test positions was performed for some bands, see Table 12-2.



FCC ID: ZNFH820		SAR EVALUATION REPORT		Reviewed by: Quality Manager
Document S/N: 0Y1601290203-R5.ZNF	Test Dates: 01/28/16 - 03/03/16	DUT Type: Portable Handset	Page 69 of 82	

Table 12-2
Simultaneous Transmission Scenario with 2.4 GHz WLAN (Held to Ear)

Simult Tx	Configuration	GPRS 850 SAR (W/kg)	2.4 GHz WLAN SAR (W/kg)	Σ SAR (W/kg)	SPLSR
		1	2	1+2	1+2
Head SAR	Right Cheek	0.538	1.024	1.562	N/A
	Right Tilt	0.373	0.981	1.354	N/A
	Left Cheek	0.747	0.394	1.141	N/A
	Left Tilt	0.332	1.024*	1.356	N/A

Simult Tx	Configuration	UMTS 1750 SAR (W/kg)	2.4 GHz WLAN SAR (W/kg)	Σ SAR (W/kg)	SPLSR
		1	2	1+2	1+2
Head SAR	Right Cheek	0.638	1.024	See Note 1	0.02
	Right Tilt	0.217	0.981	1.198	N/A
	Left Cheek	0.345	0.394	0.739	N/A
	Left Tilt	0.248	1.024*	1.272	N/A

Simult Tx	Configuration	UMTS 1900 SAR (W/kg)	2.4 GHz WLAN SAR (W/kg)	Σ SAR (W/kg)	SPLSR
		1	2	1+2	1+2
Head SAR	Right Cheek	0.630	1.024	See Note 1	0.03
	Right Tilt	0.196	0.981	1.177	N/A
	Left Cheek	0.345	0.394	0.739	N/A
	Left Tilt	0.248	1.024*	1.272	N/A

Simult Tx	Configuration	LTE Band 4 (AWS) SAR (W/kg)	2.4 GHz WLAN SAR (W/kg)	Σ SAR (W/kg)	SPLSR
		1	2	1+2	1+2
Head SAR	Right Cheek	0.757	1.024	See Note 1	0.03
	Right Tilt	0.258	0.981	1.239	N/A
	Left Cheek	0.397	0.394	0.791	N/A
	Left Tilt	0.253	1.024*	1.277	N/A

Simult Tx	Configuration	LTE Band 2 (PCS) SAR (W/kg)	2.4 GHz WLAN SAR (W/kg)	Σ SAR (W/kg)	SPLSR
		1	2	1+2	1+2
Head SAR	Right Cheek	0.821	1.024	See Note 1	0.03
	Right Tilt	0.269	0.981	1.250	N/A
	Left Cheek	0.387	0.394	0.781	N/A
	Left Tilt	0.257	1.024*	1.281	N/A

Notes:

1: No evaluation was performed to determine the aggregate 1g SAR for these configurations as the SPLS ratio between the antenna pairs was not greater than 0.04 per FCC KDB 447498 D01v05. See Section 12.6 for detailed SPLS ratio analysis.

2: SAR highlighted in orange above is the highest simultaneous transmission SAR to be listed on the grants.

3: (*) For test positions that were not required to be evaluated for WLAN SAR per FCC KDB Publication 248227, the worst case WLAN head SAR result was used for simultaneous transmission analysis.



FCC ID: ZNFH820		SAR EVALUATION REPORT		Reviewed by: Quality Manager
Document S/N: 0Y1601290203-R5.ZNF	Test Dates: 01/28/16 - 03/03/16	DUT Type: Portable Handset		Page 70 of 82

Table 12-3
Simultaneous Transmission Scenario with 5 GHz WLAN (Held to Ear)

Exposure Condition	Mode	2G/3G/4G SAR (W/kg)	5 GHz WLAN SAR (W/kg)	Σ SAR (W/kg)
		1	2	
Head SAR	GSM/GPRS 850	0.747	0.908	See Table 12-4
	UMTS 850	0.405	0.908	1.313
	UMTS 1750	0.638	0.908	1.546
	GSM/GPRS 1900	0.248	0.908	1.156
	UMTS 1900	0.630	0.908	1.538
	LTE Band 12	0.233	0.908	1.141
	LTE Band 5 (Cell)	0.384	0.908	1.292
	LTE Band 4 (AWS)	0.757	0.908	See Table 12-4
	LTE Band 2 (PCS)	0.821	0.908	See Table 12-4
	LTE Band 30	0.156	0.908	1.064
	LTE Band 7	0.233	0.908	1.141



Note: When possible, the highest reported SAR for each transmission modes for all test positions antennas and with and without the accessory were considered collectively to evaluate the worst case simultaneous transmission exclusion scenarios. Additional simultaneous transmission exclusion analysis at specific test positions was performed for some bands, see Table 12-4.

Table 12-4
Simultaneous Transmission Scenario with 5 GHz WLAN (Held to Ear)

Simult Tx	Configuration	GPRS 850 SAR (W/kg)	5 GHz WLAN SAR (W/kg)	Σ SAR (W/kg)	Simult Tx	Configuration	LTE Band 4 (AWS) SAR (W/kg)	5 GHz WLAN SAR (W/kg)	Σ SAR (W/kg)
		1	2				1+2	1	
Head SAR	Right Cheek	0.538	0.667	1.205	Head SAR	Right Cheek	0.757	0.667	1.424
	Right Tilt	0.373	0.908	1.281		Right Tilt	0.258	0.908	1.166
	Left Cheek	0.747	0.373	1.120		Left Cheek	0.397	0.373	0.770
	Left Tilt	0.332	0.908*	1.240		Left Tilt	0.253	0.908*	1.161

Simult Tx	Configuration	LTE Band 2 (PCS) SAR (W/kg)	5 GHz WLAN SAR (W/kg)	Σ SAR (W/kg)
		1	2	
Head SAR	Right Cheek	0.821	0.667	1.488
	Right Tilt	0.269	0.908	1.177
	Left Cheek	0.387	0.373	0.760
	Left Tilt	0.257	0.908*	1.165

(*) For test positions that were not required to be evaluated for WLAN SAR per FCC KDB Publication 248227, the worst case WLAN head SAR result was used for simultaneous transmission analysis.

FCC ID: ZNFH820		SAR EVALUATION REPORT		Reviewed by: Quality Manager
Document S/N: 0Y1601290203-R5_ZNF	Test Dates: 01/28/16 - 03/03/16	DUT Type: Portable Handset	Page 71 of 82	

12.4 Body-Worn Simultaneous Transmission Analysis

Table 12-5
Simultaneous Transmission Scenario with 2.4 GHz WLAN (Body-Worn at 1.0 cm)

Exposure Condition	Mode	2G/3G/4G SAR (W/kg)	2.4 GHz WLAN SAR (W/kg)	Σ SAR (W/kg)
		1	2	1+2
Body-Worn	GSM/GPRS 850	1.033	0.135	1.168
	UMTS 850	0.518	0.135	0.653
	UMTS 1750	0.721	0.135	0.856
	GSM/GPRS 1900	0.309	0.135	0.444
	UMTS 1900	1.067	0.135	1.202
	LTE Band 12	0.509	0.135	0.644
	LTE Band 5 (Cell)	0.508	0.135	0.643
	LTE Band 4 (AWS)	1.115	0.135	1.250
	LTE Band 2 (PCS)	1.032	0.135	1.167
	LTE Band 30	0.324	0.135	0.459
	LTE Band 7	0.571	0.135	0.706

Note: The highest reported SAR for each transmission modes for all test positions, antennas and with and without the accessory were considered collectively to evaluate the worst case simultaneous transmission exclusion scenarios.

Table 12-6
Simultaneous Transmission Scenario with 5 GHz WLAN (Body-Worn at 1.0 cm)

Exposure Condition	Mode	2G/3G/4G SAR (W/kg)	5 GHz WLAN SAR (W/kg)	Σ SAR (W/kg)
		1	2	1+2
Body-Worn	GSM/GPRS 850	1.033	0.056	1.089
	UMTS 850	0.518	0.056	0.574
	UMTS 1750	0.721	0.056	0.777
	GSM/GPRS 1900	0.309	0.056	0.365
	UMTS 1900	1.067	0.056	1.123
	LTE Band 12	0.509	0.056	0.565
	LTE Band 5 (Cell)	0.508	0.056	0.564
	LTE Band 4 (AWS)	1.115	0.056	1.171
	LTE Band 2 (PCS)	1.032	0.056	1.088
	LTE Band 30	0.324	0.056	0.380
	LTE Band 7	0.571	0.056	0.627

Note: The highest reported SAR for each transmission modes for all test positions, antennas and with and without the accessory were considered collectively to evaluate the worst case simultaneous transmission exclusion scenarios.



FCC ID: ZNFH820		SAR EVALUATION REPORT		Reviewed by: Quality Manager
Document S/N: 0Y1601290203-R5.ZNF	Test Dates: 01/28/16 - 03/03/16	DUT Type: Portable Handset	Page 72 of 82	

Table 12-7
Simultaneous Transmission Scenario with Bluetooth (Body-Worn at 1.0 cm)

Exposure Condition	Mode	2G/3G/4G SAR (W/kg)	Bluetooth SAR (W/kg)	Σ SAR (W/kg)
		1	2	1+2
Body-Worn	GSM/GPRS 850	1.033	0.005	1.038
	UMTS 850	0.518	0.005	0.523
	UMTS 1750	0.721	0.005	0.726
	GSM/GPRS 1900	0.309	0.005	0.314
	UMTS 1900	1.067	0.005	1.072
	LTE Band 12	0.509	0.005	0.514
	LTE Band 5 (Cell)	0.508	0.005	0.513
	LTE Band 4 (AWS)	1.115	0.005	1.120
	LTE Band 2 (PCS)	1.032	0.005	1.037
	LTE Band 30	0.324	0.005	0.329
	LTE Band 7	0.571	0.005	0.576

Note: The highest reported SAR for each transmission modes for all test positions, antennas and with and without the accessory were considered collectively to evaluate the worst case simultaneous transmission exclusion scenarios.

12.5 Hotspot SAR Simultaneous Transmission Analysis

Table 12-8
Simultaneous Transmission Scenario (2.4 GHz Hotspot at 1.0 cm)

Exposure Condition	Mode	2G/3G/4G SAR (W/kg)	2.4 GHz WLAN SAR (W/kg)	Σ SAR (W/kg)
		1	2	1+2
Hotspot SAR	GPRS 850	1.084	0.139	1.223
	UMTS 850	0.624	0.139	0.763
	UMTS 1750	0.785	0.139	0.924
	GPRS 1900	0.297	0.139	0.436
	UMTS 1900	1.067	0.139	1.206
	LTE Band 12	0.509	0.139	0.648
	LTE Band 5 (Cell)	0.544	0.139	0.683
	LTE Band 4 (AWS)	1.115	0.139	1.254
	LTE Band 2 (PCS)	1.063	0.139	1.202
	LTE Band 30	0.455	0.139	0.594
	LTE Band 7	0.571	0.139	0.710

Note: The highest reported SAR for each transmission modes for all test positions, antennas and with and without the accessory were considered collectively to evaluate the worst case simultaneous transmission exclusion scenarios.





FCC ID: ZNFH820	 PCTEST Engineering Laboratory, Inc.	SAR EVALUATION REPORT	 LG	Reviewed by: Quality Manager
Document S/N: 0Y1601290203-R5.ZNF	Test Dates: 01/28/16 - 03/03/16	DUT Type: Portable Handset		Page 73 of 82

Table 12-9
Simultaneous Transmission Scenario (5 GHz Hotspot at 1.0 cm)

Note: The highest reported SAR for each transmission modes for all test positions, antennas and with and without the accessory were considered collectively to evaluate the worst case simultaneous transmission exclusion scenarios.

12.6 SPLSR Evaluation and Analysis

Per FCC KDB Publication 447498 D01v05r02, when the sum of the standalone transmitters is more than 1.6 W/kg for 1g and 4 W/kg for 10g, the SAR sum to peak locations can be analyzed to determine SAR distribution overlaps. When the SAR peak to location ratio (shown below) for each pair of antennas is

FCC ID: ZNFH820		SAR EVALUATION REPORT		Reviewed by: Quality Manager
Document S/N: 0Y1601290203-R5.ZNF	Test Dates: 01/28/16 - 03/03/16	DUT Type: Portable Handset	Page 74 of 82	

12.6.1

SPLSR Evaluation and Analysis

Table 12-10
Peak SAR Locations for Right Cheek



Mode/Band	x (mm)	y (mm)	z (mm)	Reported SAR (W/kg)
2.4 GHz WLAN Right Cheek	9.72	-329.77	-171.65	1.024
LTE Band 2 (PCS) Right Cheek	46.29	-252.99	-171.29	0.821
LTE Band 4 Right Cheek	49.27	-249.68	-169.27	0.757
UMTS 1750 Right Cheek	48.78	-251.62	-169.64	0.638
UMTS 1900 Right Cheek	43.00	-254.74	-172.72	0.630

Table 12-11
Right Cheek SAR Sum to Peak Location Separation Ratio Calculations

Antenna Pair		Standalone 1g SAR (W/kg)		Standalone SAR Sum (W/kg)	Peak SAR Separation Distance (mm)	SPLS Ratio	Plot Number
Ant "a"	Ant "b"	a	b	a+b	D _{a-b}	$(a+b)^{1.5}/D_{a-b}$	
2.4 GHz WLAN Right Cheek	LTE Band 2 (PCS) Right Cheek	1.024	0.821	1.845	85.05	0.03	1
2.4 GHz WLAN Right Cheek	LTE Band 4 Right Cheek	1.024	0.757	1.781	89.35	0.03	2
2.4 GHz WLAN Right Cheek	UMTS 1750 Right Cheek	1.024	0.638	1.662	87.39	0.02	3
2.4 GHz WLAN Right Cheek	UMTS 1900 Right Cheek	1.024	0.630	1.654	82.09	0.03	4

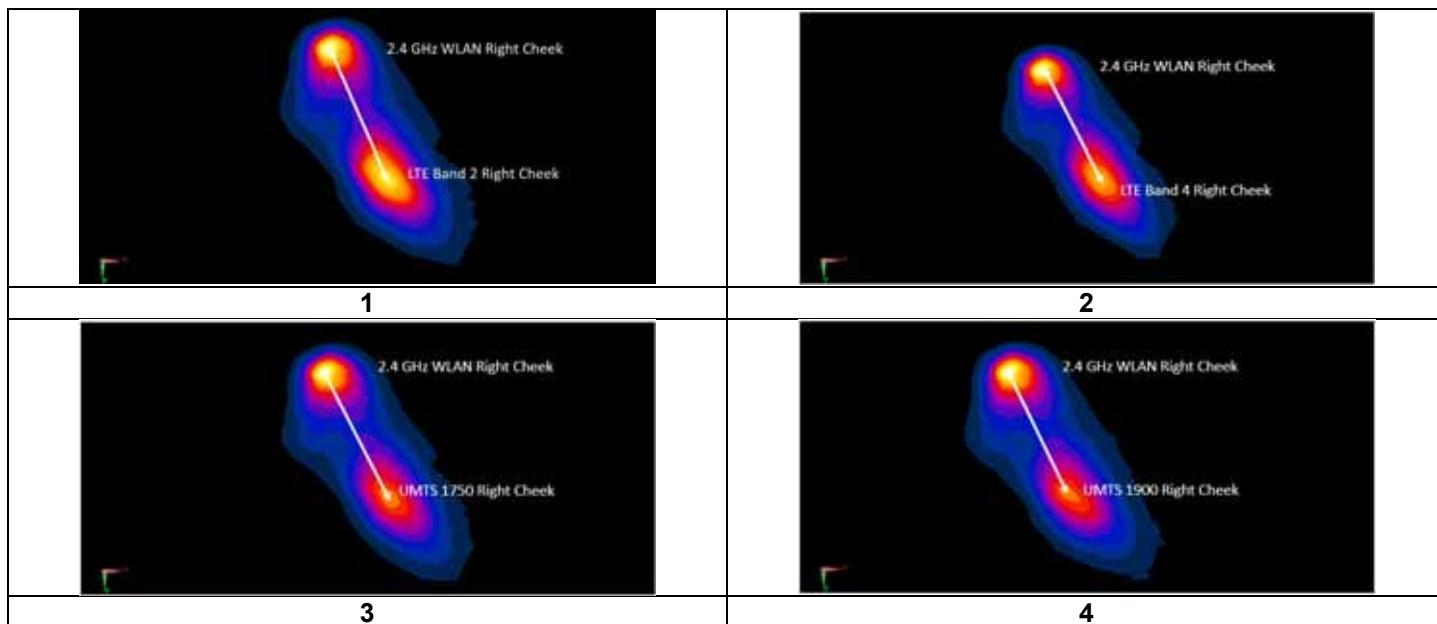

Table 12-12
Right Cheek SAR Sum to Peak Location Separation Ratio Plots



FCC ID: ZNFH820		SAR EVALUATION REPORT		Reviewed by: Quality Manager
Document S/N: 0Y1601290203-R5.ZNF	Test Dates: 01/28/16 - 03/03/16	DUT Type: Portable Handset		Page 75 of 82

12.7 Simultaneous Transmission Conclusion

The above numerical summed SAR results and SPLSR analysis are sufficient to determine that simultaneous transmission cases will not exceed the SAR limit and therefore no measured volumetric simultaneous SAR summation is required per FCC KDB Publication 447498 D01v06 and IEEE 1528-2013 Section 6.3.4.1.2.

FCC ID: ZNFH820		SAR EVALUATION REPORT		Reviewed by: Quality Manager
Document S/N: 0Y1601290203-R5.ZNF	Test Dates: 01/28/16 - 03/03/16	DUT Type: Portable Handset		Page 76 of 82

13 SAR MEASUREMENT VARIABILITY

13.1 Measurement Variability

Per FCC KDB Publication 865664 D01v01r04, SAR measurement variability was assessed for each frequency band, which was determined by the SAR probe calibration point and tissue-equivalent medium used for the device measurements. When both head and body tissue-equivalent media were required for SAR measurements in a frequency band, the variability measurement procedures were applied to the tissue medium with the highest measured SAR, using the highest measured SAR configuration for that tissue-equivalent medium. These additional measurements were repeated after the completion of all measurements requiring the same head or body tissue-equivalent medium in a frequency band. The test device was returned to ambient conditions (normal room temperature) with the battery fully charged before it was re-mounted on the device holder for the repeated measurement(s) to minimize any unexpected variations in the repeated results.

SAR Measurement Variability was assessed using the following procedures for each frequency band:

- 1) When the original highest measured SAR is ≥ 0.80 W/kg, the measurement was repeated once.
- 2) A second repeated measurement was performed only if the ratio of largest to smallest SAR for the original and first repeated measurements was > 1.20 or when the original or repeated measurement was ≥ 1.45 W/kg ($\sim 10\%$ from the 1-g SAR limit).
- 3) A third repeated measurement was performed only if the original, first or second repeated measurement was ≥ 1.5 W/kg and the ratio of largest to smallest SAR for the original, first and second repeated measurements is > 1.20 .
- 4) Repeated measurements are not required when the original highest measured SAR is < 0.80 W/kg
- 5) 10g SAR measurement variability analysis applies a factor of 2.5 to the procedures outlines above.

**Table 13-1
Body SAR Measurement Variability Results**



BODY VARIABILITY RESULTS														
Band	FREQUENCY		Mode	Service	# of Time Slots	Side	Spacing	Measured SAR (1g)	1st Repeated SAR (1g)	Ratio	2nd Repeated SAR (1g)	Ratio	3rd Repeated SAR (1g)	Ratio
	MHz	Ch.						(W/kg)	(W/kg)		(W/kg)		(W/kg)	
835	836.60	190	GSM 850	GPRS	3	left	10 mm	1.030	1.060	1.03	N/A	N/A	N/A	N/A
1900	1907.60	9538	UMTS 1900	RMC	N/A	back	10 mm	1.050	1.050	1.00	N/A	N/A	N/A	N/A
1750	1732.50	20175	LTE Band 4 (AWS), 20 MHz Bandwidth	QPSK, 1 RB, 0 RB Offset	N/A	back	10 mm	1.090	1.040	1.05	N/A	N/A	N/A	N/A
ANSI / IEEE C95.1 1992 - SAFETY LIMIT Spatial Peak Uncontrolled Exposure/General Population							Body 1.6 W/kg (mW/g) averaged over 1 gram							

**Table 13-2
10g Hotspot Mode 0mm SAR Measurement Variability Results**

10g Hotspot Mode 0mm VARIABILITY RESULTS													
Band	FREQUENCY		Mode	Service	Side	Spacing	Measured SAR (10g)	1st Repeated SAR (10g)	Ratio	2nd Repeated SAR (10g)	Ratio	3rd Repeated SAR (10g)	Ratio
	MHz	Ch.					(W/kg)	(W/kg)		(W/kg)		(W/kg)	
1750	1732.50	20175	LTE Band 4 (AWS), 20 MHz Bandwidth	QPSK, 1 RB, 0 RB Offset	back	0 mm	2.240	2.290	1.02	N/A	N/A	N/A	N/A
ANSI / IEEE C95.1 1992 - SAFETY LIMIT Spatial Peak Uncontrolled Exposure/General Population						10g Hotspot Mode 0mm SAR 4.0 W/kg (mW/g) averaged over 10 grams							

13.2 Measurement Uncertainty



The measured SAR was < 1.5 W/kg for 1g SAR and < 3.75 for 10g SAR all frequency bands. Therefore, per KDB Publication 865664 D01v01r04, the extended measurement uncertainty analysis per IEEE 1528-2013 was not required.

FCC ID: ZNFH820		SAR EVALUATION REPORT		Reviewed by: Quality Manager
Document S/N: 0Y1601290203-R5.ZNF	Test Dates: 01/28/16 - 03/03/16	DUT Type: Portable Handset	Page 77 of 82	

14 EQUIPMENT LIST



Manufacturer	Model	Description	Cal Date	Cal Interval	Cal Due	Serial Number
Agilent	8594A	(9kHz-2.9GHz) Spectrum Analyzer	N/A	N/A	N/A	3051A00187
Agilent	8648D	(9kHz-4GHz) Signal Generator	3/15/2015	Annual	3/15/2016	3629U00687
Agilent	8753ES	Network Analyzer	3/20/2015	Annual	3/20/2016	MY40001472
Agilent	8753ES	S-Parameter Network Analyzer	11/4/2015	Annual	11/4/2016	US39170118
Agilent	E4432B	ESG-D Series Signal Generator	3/16/2015	Annual	3/16/2016	US40053896
Agilent	E4438C	ESG Vector Signal Generator	4/1/2014	Biennial	4/1/2016	MY47270002
Agilent	E5515C	Wireless Communications Test Set	4/13/2015	Annual	4/13/2016	GB43460554
Agilent	E8257D	(250kHz-20GHz) Signal Generator	3/15/2015	Annual	3/15/2016	MY45470194
Agilent	N4010A	Wireless Connectivity Test Set	N/A	N/A	N/A	GB46170464
Agilent	N4010A	Wireless Connectivity Test Set	N/A	N/A	N/A	GB44450273
Agilent	N5182A	MXG Vector Signal Generator	11/6/2015	Annual	11/6/2016	MY47420603
Agilent	N9020A	MXA Signal Analyzer	11/5/2015	Annual	11/5/2016	US46470561
Amplifier Research	15S1G6	Amplifier	CBT	N/A	CBT	433971
Amplifier Research	15S1G6	Amplifier	CBT	N/A	CBT	433978
Anritsu	MA24106A	USB Power Sensor	5/29/2015	Annual	5/29/2016	1244512
Anritsu	MA24106A	USB Power Sensor	5/29/2015	Annual	5/29/2016	1248508
Anritsu	MA2411B	Pulse Power Sensor	12/7/2015	Annual	12/7/2016	1207364
Anritsu	MA2411B	Pulse Power Sensor	12/7/2015	Annual	12/7/2016	1339018
Anritsu	MA2481A	Power Sensor	3/10/2015	Annual	3/10/2016	5821
Anritsu	MA2481A	Power Sensor	3/10/2015	Annual	3/10/2016	5605
Anritsu	ML2495A	Power Meter	10/16/2015	Biennial	10/16/2017	1039008
Anritsu	ML2496A	Power Meter	3/13/2015	Annual	3/13/2016	1306009
Anritsu	MT8820C	Radio Communication Analyzer	11/12/2015	Annual	11/12/2016	6201144418
Anritsu	MT8820C	Radio Communication Analyzer	12/4/2015	Annual	12/4/2016	6201300731
COMTECH	AR85729-5	Solid State Amplifier	CBT	N/A	CBT	M155A00-009
COMTECH	AR85729-5/5759B	Solid State Amplifier	CBT	N/A	CBT	M3W1A00-1002
Control Company	4040	Digital Thermometer	3/18/2015	Biennial	3/18/2017	150194896
Control Company	4353	Long Stem Thermometer	1/22/2015	Biennial	1/22/2017	150053081
Gigatronics	80701A	(0.05-18GHz) Power Sensor	11/4/2015	Annual	11/4/2016	1833460
Gigatronics	8651A	Universal Power Meter	11/4/2015	Annual	11/4/2016	8650319
Intelligent Weigh	PD-3000	Electronic Balance	CBT	N/A	CBT	11081534
Keysight	772D	Dual Directional Coupler	CBT	N/A	CBT	MY52180215
MCL	BW-N6W5+	6dB Attenuator	CBT	N/A	CBT	1139
Mini-Circuits	VLF-6000+	Low Pass Filter	CBT	N/A	CBT	N/A
Mini-Circuits	BW-N20W5	Power Attenuator	CBT	N/A	CBT	1226
Mini-Circuits	BW-N20W5+	DC to 18 GHz Precision Fixed 20 dB Attenuator	CBT	N/A	CBT	N/A
Mini-Circuits	NLP-1200+	Low Pass Filter DC to 1000 MHz	CBT	N/A	CBT	N/A
Mini-Circuits	NLP-2950+	Low Pass Filter DC to 2700 MHz	CBT	N/A	CBT	N/A
Mitutoyo	CD-6°CSX	Digital Caliper	5/8/2014	Biennial	5/8/2016	13264162
Narda	4014C-6	4 - 8 GHz SMA 6 dB Directional Coupler	CBT	N/A	CBT	N/A
Narda	4772-3	Attenuator (3dB)	CBT	N/A	CBT	9406
Pasternack	NC-100	Torque Wrench	11/6/2015	Biennial	11/6/2017	N/A
Pasternack	PE2208-6	Bidirectional Coupler	CBT	N/A	CBT	N/A
Rohde & Schwarz	CMU200	Base Station Simulator	3/23/2015	Annual	3/23/2016	836371/0079
Rohde & Schwarz	CMW500	Radio Communication Tester	3/18/2015	Annual	3/18/2016	128633
Rohde & Schwarz	NRVD	Dual Channel Power Meter	CBT	N/A	CBT	101695
Rohde & Schwarz	NRV-Z32	Peak Power Sensor	CBT	N/A	CBT	836019/013
Rohde & Schwarz	SME06	Signal Generator	CBT	N/A	CBT	832026
Seekonk	NC-100	Torque Wrench 5/16", 8" lbs	3/18/2014	Biennial	3/18/2016	N/A
Seekonk	NC-100	Torque Wrench	3/18/2014	Biennial	3/18/2016	N/A
SPEAG	D1750V2	1750 MHz SAR Dipole	4/15/2015	Annual	4/15/2016	1051
SPEAG	D1900V2	1900 MHz SAR Dipole	7/14/2015	Annual	7/14/2016	5d149
SPEAG	D2300V2	SAR Dipole	12/8/2015	Annual	12/8/2016	1064
SPEAG	D2450V2	2450 MHz SAR Dipole	8/20/2015	Annual	8/20/2016	719
SPEAG	D5GHZV2	5 GHz SAR Dipole	2/17/2015	Annual	2/17/2016	1120
SPEAG	D5GHZV2	5 GHz SAR Dipole	9/16/2015	Annual	9/16/2016	1191
SPEAG	D750V3	750 MHz Dipole	3/11/2015	Annual	3/11/2016	1054
SPEAG	D835V2	835 MHz SAR Dipole	4/13/2015	Annual	4/13/2016	4d119
SPEAG	D835V2	835 MHz SAR Dipole	7/23/2015	Annual	7/23/2016	4d133
SPEAG	DAE4	Dasy Data Acquisition Electronics	2/18/2015	Annual	2/18/2016	665
SPEAG	DAE4	Dasy Data Acquisition Electronics	3/13/2015	Annual	3/13/2016	1368
SPEAG	DAE4	Dasy Data Acquisition Electronics	4/20/2015	Annual	4/20/2016	1407
SPEAG	DAE4	Dasy Data Acquisition Electronics	6/17/2015	Annual	6/17/2016	859
SPEAG	DAE4	Dasy Data Acquisition Electronics	8/24/2015	Annual	8/24/2016	1322
SPEAG	DAE4	Dasy Data Acquisition Electronics	9/16/2015	Annual	9/16/2016	1323
SPEAG	DAE4	Dasy Data Acquisition Electronics	10/27/2015	Annual	10/27/2016	1333
SPEAG	DAE4	Dasy Data Acquisition Electronics	11/11/2015	Annual	11/11/2016	1415
SPEAG	DAK-3.5	Dielectric Assessment Kit	5/12/2015	Annual	5/12/2016	1070
SPEAG	DAKS VNA R140	VNA for Portable DAK	8/16/2015	Annual	8/16/2016	80513
SPEAG	DAKS-3.5	Portable Dielectric Assessment Kit	7/14/2015	Annual	7/14/2016	1039
SPEAG	ES3DV2	SAR Probe	8/26/2015	Annual	8/26/2016	3022
SPEAG	ES3DV3	SAR Probe	3/19/2015	Annual	3/19/2016	3319
SPEAG	ES3DV3	SAR Probe	5/20/2015	Annual	5/20/2016	3263
SPEAG	ES3DV3	SAR Probe	6/22/2015	Annual	6/22/2016	3351
SPEAG	ES3DV3	SAR Probe	10/29/2015	Annual	10/29/2016	3333
SPEAG	ES3DV3	SAR Probe	11/17/2015	Annual	11/17/2016	3334
SPEAG	EX3DV4	SAR Probe	4/23/2015	Annual	4/23/2016	7357
SPEAG	EX3DV4	SAR Probe	7/21/2015	Annual	7/21/2016	7308
SPEAG	Planar R140	Reflectometer	8/2/2015	Annual	8/2/2016	50513

- Note:
- CBT (Calibrated Before Testing). Prior to testing, the measurement paths containing a cable, amplifier, attenuator, coupler or filter were connected to a calibrated source (i.e. a signal generator) to determine the losses of the measurement path. The power meter offset was then adjusted to compensate for the measurement system losses. This level offset is stored within the power meter before measurements are made. This calibration verification procedure applies to the system verification and output power measurements. The calibrated reading is then taken directly from the power meter after compensation of the losses for all final power measurements.
 - Each equipment item was used solely within its respective calibration period.

FCC ID: ZNFH820		SAR EVALUATION REPORT		Reviewed by: Quality Manager
Document S/N: 0Y1601290203-R5.ZNF	Test Dates: 01/28/16 - 03/03/16	DUT Type: Portable Handset		Page 78 of 82

15 MEASUREMENT UNCERTAINTIES

a	c	d	e= f(d,k)	f	g	h = c x f/e	i = c x g/e	k
Uncertainty Component	Tol. (± %)	Prob. Dist.	Div.	c _i 1gm	c _i 10 gms	1gm u _i (± %)	10gms u _i (± %)	v _i
Measurement System								
Probe Calibration	6.55	N	1	1.0	1.0	6.6	6.6	∞
Axial Isotropy	0.25	N	1	0.7	0.7	0.2	0.2	∞
Hemishperical Isotropy	1.3	N	1	0.7	0.7	0.9	0.9	∞
Boundary Effect	2.0	R	1.73	1.0	1.0	1.2	1.2	∞
Linearity	0.3	N	1	1.0	1.0	0.3	0.3	∞
System Detection Limits	0.25	R	1.73	1.0	1.0	0.1	0.1	∞
Readout Electronics	0.3	N	1	1.0	1.0	0.3	0.3	∞
Response Time	0.8	R	1.73	1.0	1.0	0.5	0.5	∞
Integration Time	2.6	R	1.73	1.0	1.0	1.5	1.5	∞
RF Ambient Conditions - Noise	3.0	R	1.73	1.0	1.0	1.7	1.7	∞
RF Ambient Conditions - Reflections	3.0	R	1.73	1.0	1.0	1.7	1.7	∞
Probe Positioner Mechanical Tolerance	0.4	R	1.73	1.0	1.0	0.2	0.2	∞
Probe Positioning w/ respect to Phantom	6.7	R	1.73	1.0	1.0	3.9	3.9	∞
Extrapolation, Interpolation & Integration algorithms for Max. SAR Evaluation	4.0	R	1.73	1.0	1.0	2.3	2.3	∞
Test Sample Related								
Test Sample Positioning	2.7	N	1	1.0	1.0	2.7	2.7	35
Device Holder Uncertainty	1.67	N	1	1.0	1.0	1.7	1.7	5
Output Power Variation - SAR drift measurement	5.0	R	1.73	1.0	1.0	2.9	2.9	∞
SAR Scaling	0.0	R	1.73	1.0	1.0	0.0	0.0	∞
Phantom & Tissue Parameters								
Phantom Uncertainty (Shape & Thickness tolerances)	7.6	R	1.73	1.0	1.0	4.4	4.4	∞
Liquid Conductivity - measurement uncertainty	4.2	N	1	0.78	0.71	3.3	3.0	10
Liquid Permittivity - measurement uncertainty	4.1	N	1	0.23	0.26	1.0	1.1	10
Liquid Conductivity - Temperature Uncertainty	3.4	R	1.73	0.78	0.71	1.5	1.4	∞
Liquid Permittivity - Temperature Uncertainty	0.6	R	1.73	0.23	0.26	0.1	0.1	∞
Liquid Conductivity - deviation from target values	5.0	R	1.73	0.64	0.43	1.8	1.2	∞
Liquid Permittivity - deviation from target values	5.0	R	1.73	0.60	0.49	1.7	1.4	∞
Combined Standard Uncertainty (k=1)	RSS					11.5	11.3	60
Expanded Uncertainty (95% CONFIDENCELEVEL)	k=2					23.0	22.6	



FCC ID: ZNFH820		SAR EVALUATION REPORT		Reviewed by: Quality Manager
Document S/N: 0Y1601290203-R5.ZNF	Test Dates: 01/28/16 - 03/03/16	DUT Type: Portable Handset		Page 79 of 82

16 CONCLUSION

16.1 Measurement Conclusion



The SAR evaluation indicates that the EUT complies with the RF radiation exposure limits of the FCC and Industry Canada, with respect to all parameters subject to this test. These measurements were taken to simulate the RF effects of RF exposure under worst-case conditions. Precise laboratory measures were taken to assure repeatability of the tests. The results and statements relate only to the item(s) tested.

Please note that the absorption and distribution of electromagnetic energy in the body are very complex phenomena that depend on the mass, shape, and size of the body, the orientation of the body with respect to the field vectors, and the electrical properties of both the body and the environment. Other variables that may play a substantial role in possible biological effects are those that characterize the environment (e.g. ambient temperature, air velocity, relative humidity, and body insulation) and those that characterize the individual (e.g. age, gender, activity level, debilitation, or disease). Because various factors may interact with one another to vary the specific biological outcome of an exposure to electromagnetic fields, any protection guide should consider maximal amplification of biological effects as a result of field-body interactions, environmental conditions, and physiological variables. [3]



FCC ID: ZNFH820		SAR EVALUATION REPORT		Reviewed by: Quality Manager
Document S/N: 0Y1601290203-R5.ZNF	Test Dates: 01/28/16 - 03/03/16	DUT Type: Portable Handset	Page 80 of 82	

17 REFERENCES

- [1] Federal Communications Commission, ET Docket 93-62, Guidelines for Evaluating the Environmental Effects of Radiofrequency Radiation, Aug. 1996.
- [2] ANSI/IEEE C95.1-2005, American National Standard safety levels with respect to human exposure to radio frequency electromagnetic fields, 3kHz to 300GHz, New York: IEEE, 2006.
- [3] ANSI/IEEE C95.1-1992, American National Standard safety levels with respect to human exposure to radio frequency electromagnetic fields, 3kHz to 300GHz, New York: IEEE, Sept. 1992.
- [4] ANSI/IEEE C95.3-2002, IEEE Recommended Practice for the Measurement of Potentially Hazardous Electromagnetic Fields - RF and Microwave, New York: IEEE, December 2002.
- [5] IEEE Standards Coordinating Committee 39 –Standards Coordinating Committee 34 – IEEE Std. 1528-2013, IEEE Recommended Practice for Determining the Peak Spatial-Average Specific Absorption Rate (SAR) in the Human Head from Wireless Communications Devices: Measurement Techniques.
- [6] NCRP, National Council on Radiation Protection and Measurements, Biological Effects and Exposure Criteria for RadioFrequency Electromagnetic Fields, NCRP Report No. 86, 1986. Reprinted Feb. 1995.
- [7] T. Schmid, O. Egger, N. Kuster, Automated E-field scanning system for dosimetric assessments, IEEE Transaction on Microwave Theory and Techniques, vol. 44, Jan. 1996, pp. 105-113.
- [8] K. Pokovic, T. Schmid, N. Kuster, Robust setup for precise calibration of E-field probes in tissue simulating liquids at mobile communications frequencies, ICECOM97, Oct. 1997, pp. 1 -124.
- [9] K. Pokovic, T. Schmid, and N. Kuster, E-field Probe with improved isotropy in brain simulating liquids, Proceedings of the ELMAR, Zadar, Croatia, June 23-25, 1996, pp. 172-175.
- [10] Schmid & Partner Engineering AG, Application Note: Data Storage and Evaluation, June 1998, p2.
- [11] V. Hombach, K. Meier, M. Burkhardt, E. Kuhn, N. Kuster, The Dependence of EM Energy Absorption upon Human Modeling at 900 MHz, IEEE Transaction on Microwave Theory and Techniques, vol. 44 no. 10, Oct. 1996, pp. 1865-1873.
- [12] N. Kuster and Q. Balzano, Energy absorption mechanism by biological bodies in the near field of dipole antennas above 300MHz, IEEE Transaction on Vehicular Technology, vol. 41, no. 1, Feb. 1992, pp. 17-23.
- [13] G. Hartsgrove, A. Kraszewski, A. Surowiec, Simulated Biological Materials for Electromagnetic Radiation Absorption Studies, University of Ottawa, Bioelectromagnetics, Canada: 1987, pp. 29-36.
- [14] Q. Balzano, O. Garay, T. Manning Jr., Electromagnetic Energy Exposure of Simulated Users of Portable Cellular Telephones, IEEE Transactions on Vehicular Technology, vol. 44, no.3, Aug. 1995.
- [15] W. Gander, Computermathematick, Birkhaeuser, Basel, 1992.
- [16] W.H. Press, S.A. Teukolsky, W.T. Vetterling, and B.P. Flannery, Numerical Recipes in C, The Art of Scientific Computing, Second edition, Cambridge University Press, 1992.
- [17] N. Kuster, R. Kastle, T. Schmid, Dosimetric evaluation of mobile communications equipment with known precision, IEEE Transaction on Communications, vol. E80-B, no. 5, May 1997, pp. 645-652.
- [18] CENELEC CLC/SC111B, European Prestandard (prENV 50166-2), Human Exposure to Electromagnetic Fields High-frequency: 10kHz-300GHz, Jan. 1995.
- [19] Prof. Dr. Niels Kuster, ETH, Eidgenössische Technische Hochschule Zürich, Dosimetric Evaluation of the Cellular Phone.

FCC ID: ZNFH820		SAR EVALUATION REPORT		Reviewed by: Quality Manager
Document S/N: 0Y1601290203-R5.ZNF	Test Dates: 01/28/16 - 03/03/16	DUT Type: Portable Handset	Page 81 of 82	

- [20] IEC 62209-1, Human exposure to radio frequency fields from hand-held and body-mounted wireless communication devices - Human models, instrumentation, and procedures - Part 1: Procedure to determine the specific absorption rate (SAR) for hand-held devices used in close proximity to the ear (frequency range of 300 MHz to 3 GHz), Feb. 2005.
- [21] Industry Canada RSS-102 Radio Frequency Exposure Compliance of Radiocommunication Apparatus (All Frequency Bands) Issue 5, March 2015.
- [22] Health Canada Safety Code 6 Limits of Human Exposure to Radio Frequency Electromagnetic Fields in the Frequency Range from 3 kHz – 300 GHz, 2015
- [23] FCC SAR Test Procedures for 2G-3G Devices, Mobile Hotspot and UMPC Devices KDB Publications 941225, D01-D07
- [24] SAR Measurement Guidance for IEEE 802.11 Transmitters, KDB Publication 248227 D01
- [25] FCC SAR Considerations for Handsets with Multiple Transmitters and Antennas, KDB Publications 648474 D03-D04
- [26] FCC SAR Evaluation Considerations for Laptop, Notebook, Netbook and Tablet Computers, FCC KDB Publication 616217 D04
- [27] FCC SAR Measurement and Reporting Requirements for 100MHz – 6 GHz, KDB Publications 865664 D01-D02
- [28] FCC General RF Exposure Guidance and SAR Procedures for Dongles, KDB Publication 447498, D01-D02
- [29] Anexo à Resolução No. 533, de 10 de Setembro de 2009.
- [30] IEC 62209-2, Human exposure to radio frequency fields from hand-held and body-mounted wireless communication devices - Human models, instrumentation, and procedures - Part 2: Procedure to determine the specific absorption rate (SAR) for wireless communication devices used in close proximity to the human body (frequency range of 30 MHz to 6 GHz), Mar. 2010.

FCC ID: ZNFH820		SAR EVALUATION REPORT		Reviewed by: Quality Manager
Document S/N: 0Y1601290203-R5.ZNF	Test Dates: 01/28/16 - 03/03/16	DUT Type: Portable Handset	Page 82 of 82	

APPENDIX A: SAR TEST DATA

PCTEST ENGINEERING LABORATORY, INC.

DUT: ZNFH820; Type: Portable Handset; Serial: 08129

Communication System: UID 0, GSM GPRS; 3 Tx slots; Frequency: 836.6 MHz; Duty Cycle: 1:2.76
Medium: 835 Head Medium parameters used (interpolated):
 $f = 836.6 \text{ MHz}$; $\sigma = 0.887 \text{ S/m}$; $\epsilon_r = 40.663$; $\rho = 1000 \text{ kg/m}^3$
Phantom section: Left Section

Test Date: 1-28-2016; Ambient Temp: 21.6°C; Tissue Temp: 22.5°C

Probe: ES3DV3 - SN3319; ConvF(6.41, 6.41, 6.41); Calibrated: 3/19/2015;
Sensor-Surface: 3mm (Mechanical Surface Detection)
Electronics: DAE4 Sn1368; Calibrated: 3/13/2015
Phantom: SAM with CRP v4.0; Type: QD000P40CD; Serial: TP:1800
Measurement SW: DASYS2, Version 52.8 (8);SEMCAD X Version 14.6.10 (7331)

Mode: GPRS 850, Left Head, Cheek, Mid.ch, 3 Tx slots

Area Scan (9x15x1): Measurement grid: dx=15mm, dy=15mm
Zoom Scan (5x5x7)/Cube 0: Measurement grid: dx=8mm, dy=8mm, dz=5mm
Reference Value = 29.61 V/m; Power Drift = -0.04 dB
Peak SAR (extrapolated) = 0.904 W/kg
SAR(1 g) = 0.730 W/kg

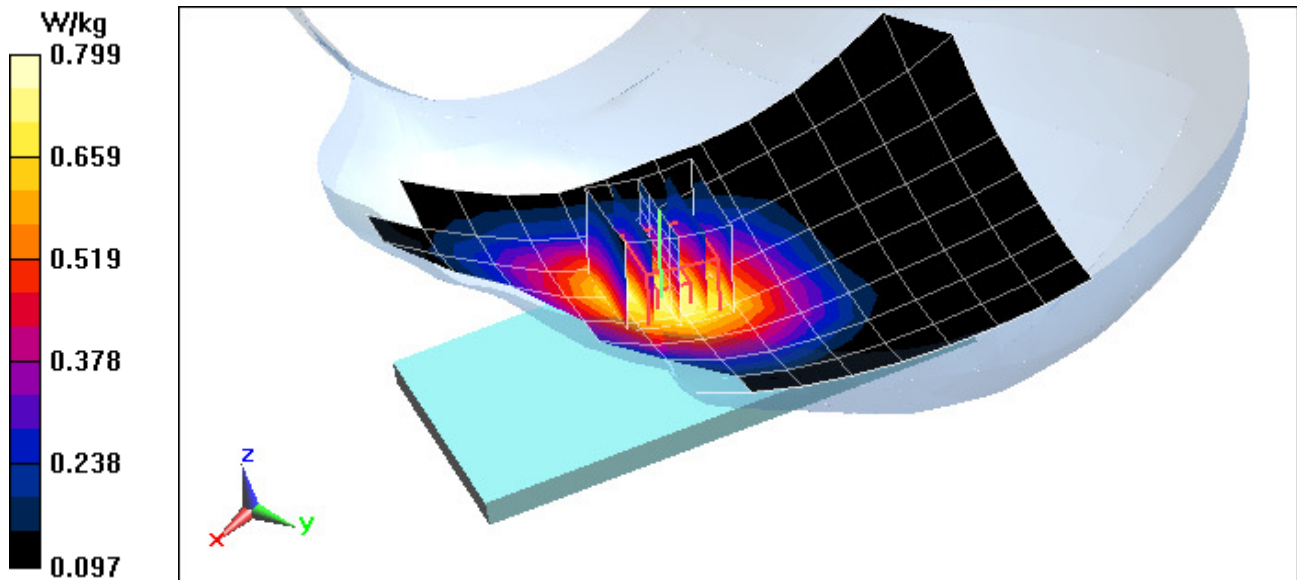

PCTEST ENGINEERING LABORATORY, INC.

DUT: ZNFH820; Type: Portable Handset; Serial: 08129

Communication System: UID 0, UMTS; Frequency: 836.6 MHz; Duty Cycle: 1:1
Medium: 835 Head Medium parameters used (interpolated):
 $f = 836.6 \text{ MHz}$; $\sigma = 0.887 \text{ S/m}$; $\epsilon_r = 40.663$; $\rho = 1000 \text{ kg/m}^3$
Phantom section: Left Section

Test Date: 1-28-2016; Ambient Temp: 21.6°C; Tissue Temp: 22.5°C

Probe: ES3DV3 - SN3319; ConvF(6.41, 6.41, 6.41); Calibrated: 3/19/2015;
Sensor-Surface: 3mm (Mechanical Surface Detection)
Electronics: DAE4 Sn1368; Calibrated: 3/13/2015
Phantom: SAM with CRP v4.0; Type: QD000P40CD; Serial: TP:1800
Measurement SW: DASY52, Version 52.8 (8); SEMCAD X Version 14.6.10 (7331)

Mode: UMTS 850, Left Head, Cheek, Mid.ch

Area Scan (9x15x1): Measurement grid: dx=15mm, dy=15mm
Zoom Scan (5x5x7)/Cube 0: Measurement grid: dx=8mm, dy=8mm, dz=5mm
Reference Value = 21.87 V/m; Power Drift = 0.01 dB
Peak SAR (extrapolated) = 0.495 W/kg
SAR(1 g) = 0.397 W/kg

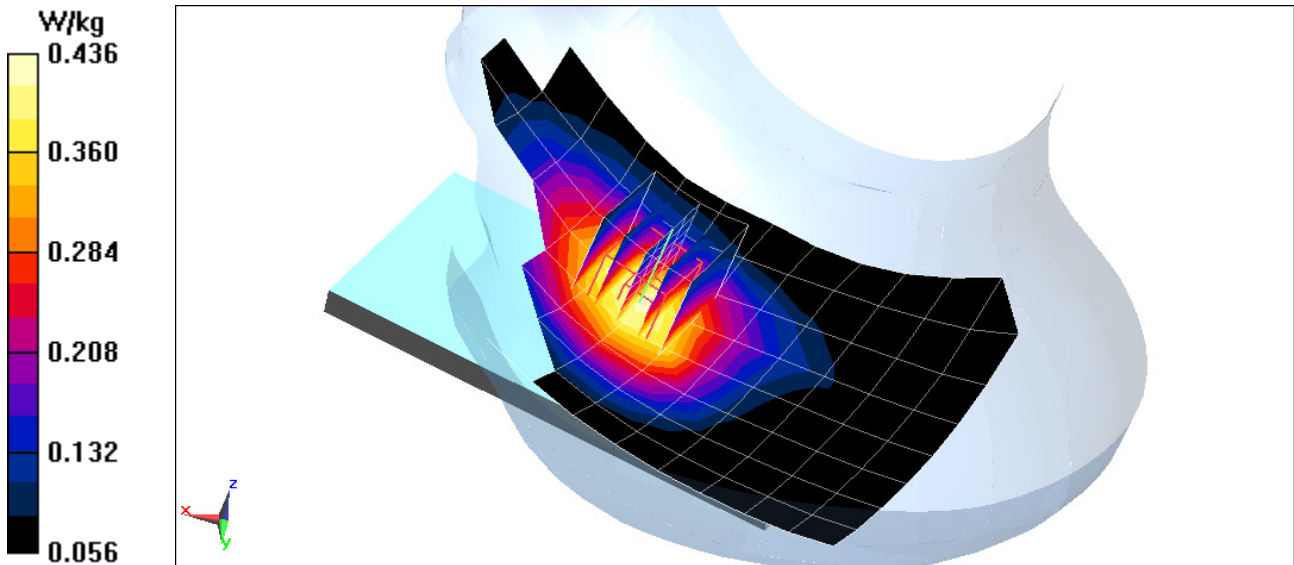

PCTEST ENGINEERING LABORATORY, INC.

DUT: ZNFH820; Type: Portable Handset; Serial: 08103

Communication System: UID 0, UMTS; Frequency: 1732.4 MHz; Duty Cycle: 1:1
Medium: 1750 Head Medium parameters used (interpolated):
 $f = 1732.4 \text{ MHz}$; $\sigma = 1.315 \text{ S/m}$; $\epsilon_r = 39.633$; $\rho = 1000 \text{ kg/m}^3$
Phantom section: Right Section

Test Date: 02-04-2016; Ambient Temp: 23.5°C; Tissue Temp: 21.7°C

Probe: ES3DV2 - SN3022; ConvF(5.08, 5.08, 5.08); Calibrated: 8/26/2015;
Sensor-Surface: 3mm (Mechanical Surface Detection)
Electronics: DAE4 Sn665; Calibrated: 2/18/2015
Phantom: SAM with CRP v4.0; Type: QD000P40CD; Serial: TP:1797
Measurement SW: DASY52, Version 52.8 (8);SEMCAD X Version 14.6.10 (7331)

Mode: AWS UMTS, Right Head, Cheek, Mid.ch

Area Scan (9x15x1): Measurement grid: dx=15mm, dy=15mm
Zoom Scan (5x5x7)/Cube 0: Measurement grid: dx=8mm, dy=8mm, dz=5mm
Reference Value = 23.09 V/m; Power Drift = -0.04 dB
Peak SAR (extrapolated) = 0.939 W/kg
SAR(1 g) = 0.638 W/kg

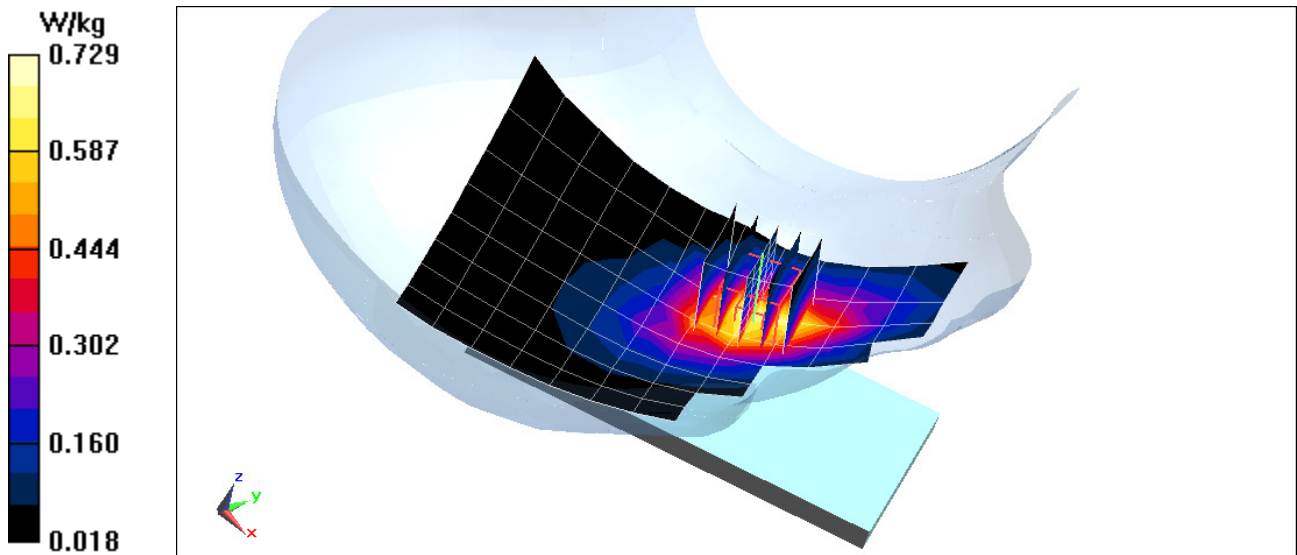

PCTEST ENGINEERING LABORATORY, INC.

DUT: ZNFH820; Type: Portable Handset; Serial: 08129

Communication System: UID 0, GSM; Frequency: 1880 MHz; Duty Cycle: 1:8.3
Medium: 1900 Head Medium parameters used:
 $f = 1880 \text{ MHz}$; $\sigma = 1.411 \text{ S/m}$; $\epsilon_r = 38.938$; $\rho = 1000 \text{ kg/m}^3$
Phantom section: Right Section

Test Date: 02-01-2016; Ambient Temp: 24.5°C; Tissue Temp: 22.8°C

Probe: ES3DV3 - SN3334; ConvF(5.18, 5.18, 5.18); Calibrated: 11/17/2015;
Sensor-Surface: 3mm (Mechanical Surface Detection)
Electronics: DAE4 Sn1415; Calibrated: 11/11/2015
Phantom: SAM Front; Type: SAM; Serial: 1686
Measurement SW: DASY52, Version 52.8 (8);SEMCAD X Version 14.6.10 (7331)

Mode: GSM 1900, Right Head, Cheek, Mid.ch

Area Scan (9x14x1): Measurement grid: dx=15mm, dy=15mm
Zoom Scan (5x5x7)/Cube 0: Measurement grid: dx=8mm, dy=8mm, dz=5mm
Reference Value = 13.86 V/m; Power Drift = 0.07 dB
Peak SAR (extrapolated) = 0.378 W/kg
SAR(1 g) = 0.247 W/kg

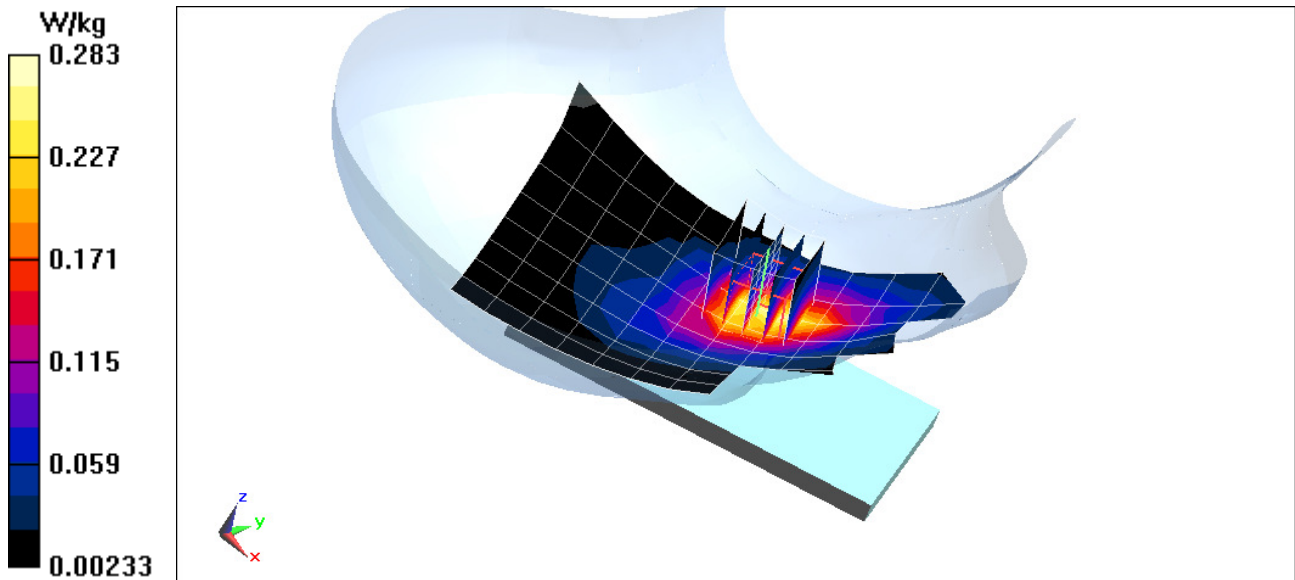

PCTEST ENGINEERING LABORATORY, INC.

DUT: ZNFH820; Type: Portable Handset; Serial: 08129

Communication System: UID 0, UMTS; Frequency: 1880 MHz; Duty Cycle: 1:1
Medium: 1900 Head Medium parameters used:
 $f = 1880 \text{ MHz}$; $\sigma = 1.411 \text{ S/m}$; $\epsilon_r = 38.938$; $\rho = 1000 \text{ kg/m}^3$
Phantom section: Right Section

Test Date: 02-01-2016; Ambient Temp: 24.5°C; Tissue Temp: 22.8°C

Probe: ES3DV3 - SN3334; ConvF(5.18, 5.18, 5.18); Calibrated: 11/17/2015;
Sensor-Surface: 3mm (Mechanical Surface Detection)
Electronics: DAE4 Sn1415; Calibrated: 11/11/2015
Phantom: SAM Front; Type: SAM; Serial: 1686
Measurement SW: DASY52, Version 52.8 (8);SEMCAD X Version 14.6.10 (7331)

Mode: UMTS 1900, Right Head, Cheek, Mid.ch

Area Scan (9x14x1): Measurement grid: dx=15mm, dy=15mm
Zoom Scan (5x5x7)/Cube 0: Measurement grid: dx=8mm, dy=8mm, dz=5mm
Reference Value = 21.82 V/m; Power Drift = 0.07 dB
Peak SAR (extrapolated) = 0.920 W/kg
SAR(1 g) = 0.614 W/kg

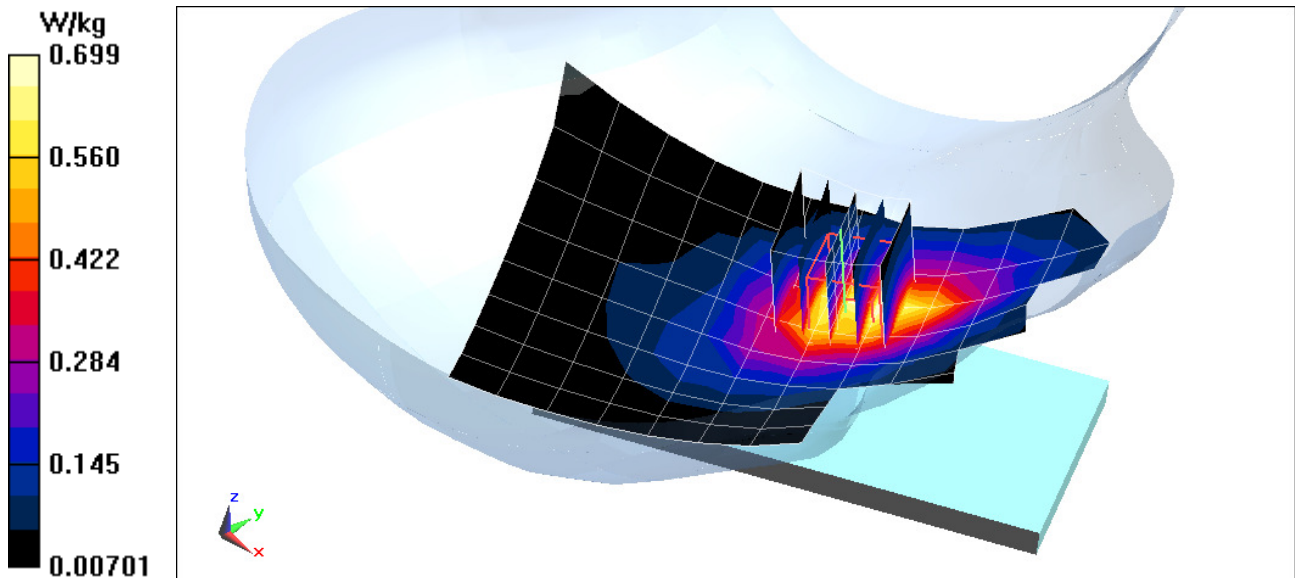

PCTEST ENGINEERING LABORATORY, INC.

DUT: ZNFH820; Type: Portable Handset; Serial: 08038

Communication System: UID 0, LTE Band 12; Frequency: 707.5 MHz; Duty Cycle: 1:1
Medium: 750 Head Medium parameters used (interpolated):
 $f = 707.5 \text{ MHz}$; $\sigma = 0.862 \text{ S/m}$; $\epsilon_r = 43.578$; $\rho = 1000 \text{ kg/m}^3$
Phantom section: Left Section

Test Date: 02-07-2016; Ambient Temp: 20.7°C; Tissue Temp: 20.4°C

Probe: ES3DV3 - SN3333; ConvF(6.46, 6.46, 6.46); Calibrated: 10/29/2015;
Sensor-Surface: 3mm (Mechanical Surface Detection)
Electronics: DAE4 Sn1333; Calibrated: 10/27/2015
Phantom: SAM Right; Type: QD000P40CD; Serial: 1757
Measurement SW: DASY52, Version 52.8 (8);SEMCAD X Version 14.6.10 (7331)

**Mode: LTE Band 12, Left Head, Cheek, Mid.ch, QPSK,
10 MHz Bandwidth, 1 RB, 0 RB Offset**

Area Scan (7x14x1): Measurement grid: dx=15mm, dy=15mm
Zoom Scan (5x5x7)/Cube 0: Measurement grid: dx=8mm, dy=8mm, dz=5mm
Reference Value = 17.29 V/m; Power Drift = 0.00 dB
Peak SAR (extrapolated) = 0.279 W/kg
SAR(1 g) = 0.231 W/kg

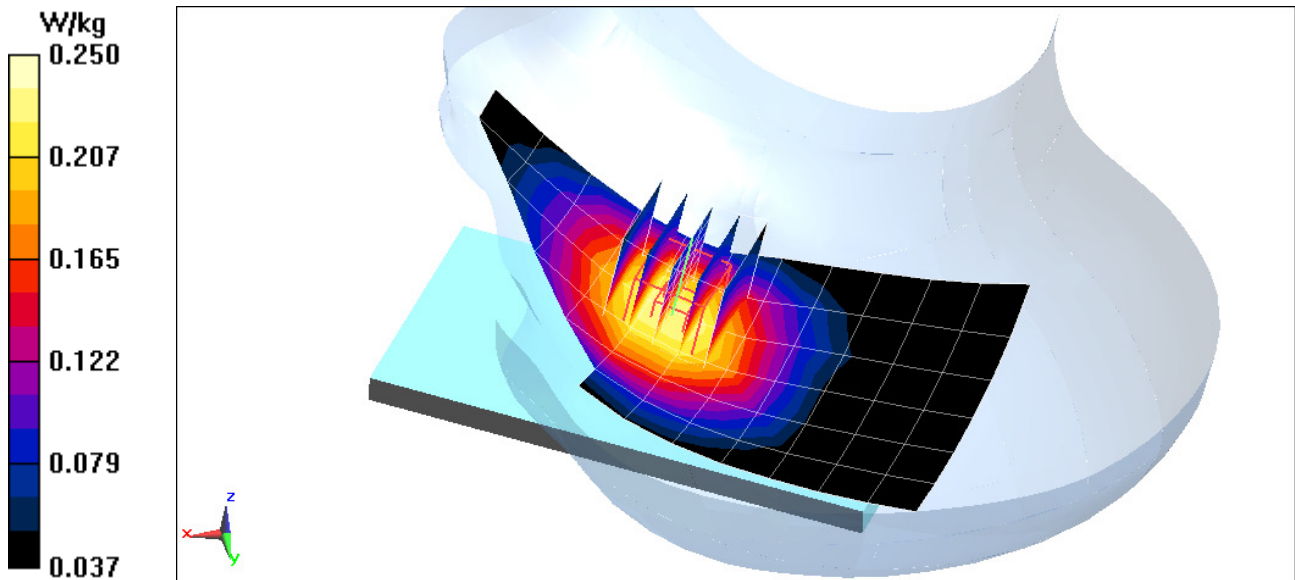

PCTEST ENGINEERING LABORATORY, INC.

DUT: ZNFH820; Type: Portable Handset; Serial: 08038

Communication System: UID 0, LTE Band 5 (Cell.); Frequency: 836.5 MHz; Duty Cycle: 1:1
Medium: 835 Head Medium parameters used (interpolated):
 $f = 836.5 \text{ MHz}$; $\sigma = 0.886 \text{ S/m}$; $\epsilon_r = 40.665$; $\rho = 1000 \text{ kg/m}^3$
Phantom section: Left Section

Test Date: 1-28-2016; Ambient Temp: 21.6°C; Tissue Temp: 22.5°C

Probe: ES3DV3 - SN3319; ConvF(6.41, 6.41, 6.41); Calibrated: 3/19/2015;
Sensor-Surface: 3mm (Mechanical Surface Detection)
Electronics: DAE4 Sn1368; Calibrated: 3/13/2015
Phantom: SAM with CRP v4.0; Type: QD000P40CD; Serial: TP:1800
Measurement SW: DASY52, Version 52.8 (8);SEMCAD X Version 14.6.10 (7331)

**Mode: LTE Band 5 (Cell.), Left Head, Cheek, Mid.ch,
10 MHz Bandwidth, QPSK, 1 RB, 25 RB Offset**

Area Scan (9x15x1): Measurement grid: $dx=15\text{mm}$, $dy=15\text{mm}$
Zoom Scan (5x5x7)/Cube 0: Measurement grid: $dx=8\text{mm}$, $dy=8\text{mm}$, $dz=5\text{mm}$
Reference Value = 22.21 V/m; Power Drift = -0.01 dB
Peak SAR (extrapolated) = 0.474 W/kg
SAR(1 g) = 0.376 W/kg

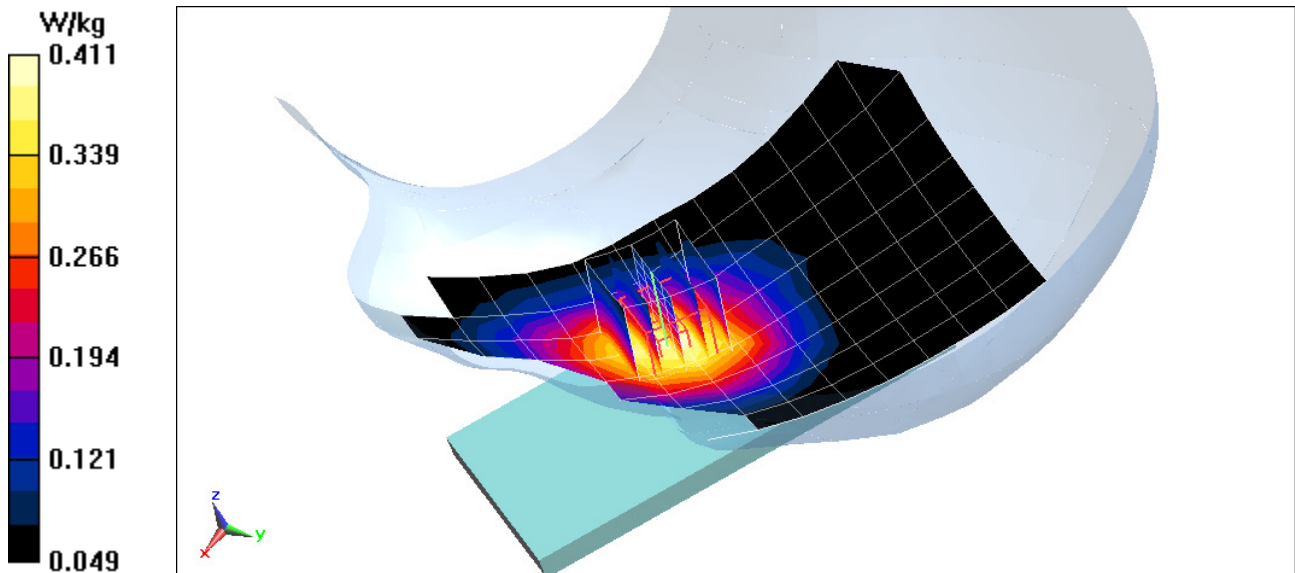

PCTEST ENGINEERING LABORATORY, INC.

DUT: ZNFH820; Type: Portable Handset; Serial: 08038

Communication System: UID 0, LTE Band 4 (AWS); Frequency: 1732.5 MHz; Duty Cycle: 1:1
Medium: 1750 Head Medium parameters used (interpolated):
 $f = 1732.5 \text{ MHz}$; $\sigma = 1.315 \text{ S/m}$; $\epsilon_r = 39.632$; $\rho = 1000 \text{ kg/m}^3$
Phantom section: Right Section

Test Date: 02-04-2016; Ambient Temp: 23.5°C; Tissue Temp: 21.7°C

Probe: ES3DV2 - SN3022; ConvF(5.08, 5.08, 5.08); Calibrated: 8/26/2015;
Sensor-Surface: 3mm (Mechanical Surface Detection)
Electronics: DAE4 Sn665; Calibrated: 2/18/2015

Phantom: SAM with CRP v4.0; Type: QD000P40CD; Serial: TP:1797
Measurement SW: DASY52, Version 52.8 (8); SEMCAD X Version 14.6.10 (7331)

**Mode: LTE Band 4 (AWS), Right Head, Cheek, Mid.ch,
20 MHz Bandwidth, QPSK, 1 RB, 0 RB Offset**

Area Scan (9x15x1): Measurement grid: $dx=15\text{mm}$, $dy=15\text{mm}$
Zoom Scan (5x5x7)/Cube 0: Measurement grid: $dx=8\text{mm}$, $dy=8\text{mm}$, $dz=5\text{mm}$
Reference Value = 25.82 V/m; Power Drift = 0.16 dB
Peak SAR (extrapolated) = 1.09 W/kg
SAR(1 g) = 0.740 W/kg

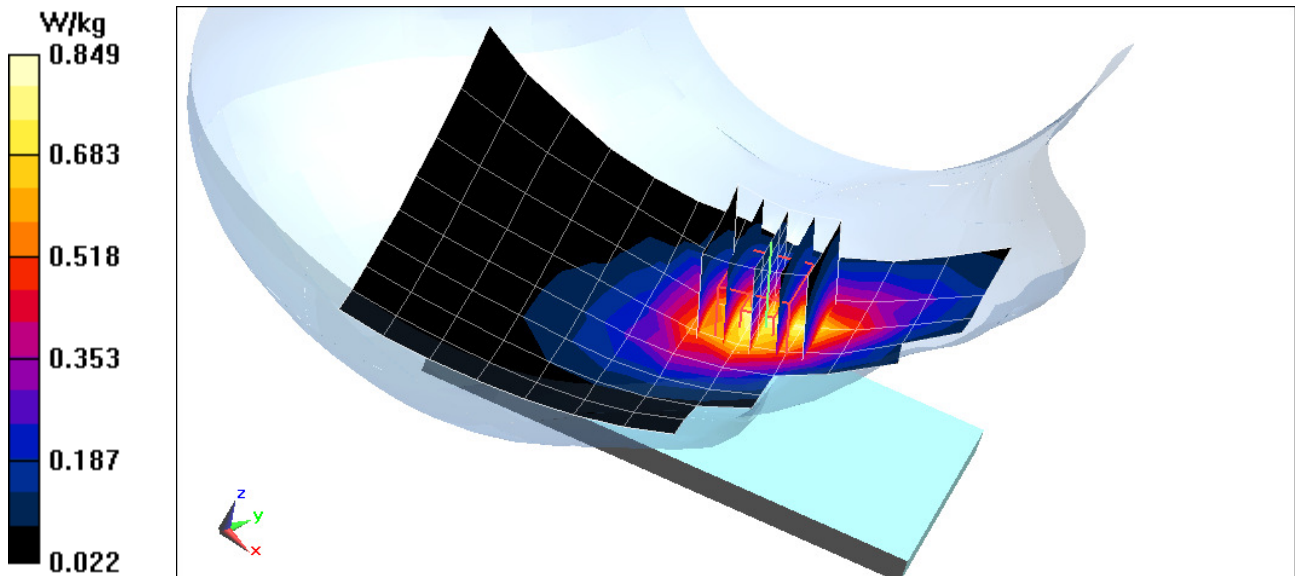

PCTEST ENGINEERING LABORATORY, INC.

DUT: ZNFH820; Type: Portable Handset; Serial: 08137

Communication System: UID 0, LTE Band 2 (PCS); Frequency: 1900 MHz; Duty Cycle: 1:1
Medium: 1900 Head Medium parameters used (interpolated):
 $f = 1900 \text{ MHz}$; $\sigma = 1.397 \text{ S/m}$; $\epsilon_r = 38.609$; $\rho = 1000 \text{ kg/m}^3$
Phantom section: Right Section

Test Date: 01-29-2016; Ambient Temp: 24.3°C; Tissue Temp: 23.0°C

Probe: ES3DV3 - SN3334; ConvF(5.18, 5.18, 5.18); Calibrated: 11/17/2015;
Sensor-Surface: 3mm (Mechanical Surface Detection)
Electronics: DAE4 Sn1415; Calibrated: 11/11/2015
Phantom: SAM Front; Type: SAM; Serial: 1686
Measurement SW: DASY52, Version 52.8 (8);SEMCAD X Version 14.6.10 (7331)

**Mode: LTE Band 2 (PCS), Right Head, Cheek, High.ch,
20 MHz Bandwidth, QPSK, 1 RB, 99 RB Offset**

Area Scan (9x15x1): Measurement grid: $dx=15\text{mm}$, $dy=15\text{mm}$
Zoom Scan (5x5x7)/Cube 0: Measurement grid: $dx=8\text{mm}$, $dy=8\text{mm}$, $dz=5\text{mm}$
Reference Value = 26.88 V/m; Power Drift = 0.05 dB
Peak SAR (extrapolated) = 1.25 W/kg
SAR(1 g) = 0.821 W/kg

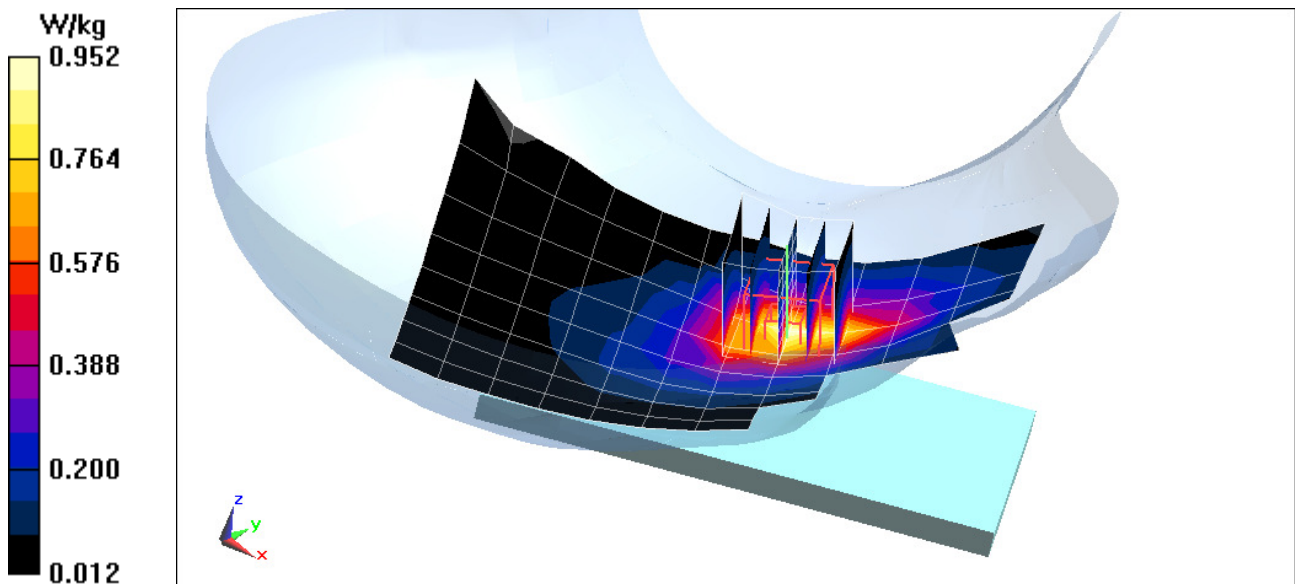

PCTEST ENGINEERING LABORATORY, INC.

DUT: ZNFH820; Type: Portable Handset; Serial: 08038

Communication System: UID 0, LTE Band 30; Frequency: 2310 MHz; Duty Cycle: 1:1

Medium: 2300 Head Medium parameters used:

$f = 2310 \text{ MHz}$; $\sigma = 1.66 \text{ S/m}$; $\epsilon_r = 38.615$; $\rho = 1000 \text{ kg/m}^3$

Phantom section: Right Section

Test Date: 02-22-2016; Ambient Temp: 23.8°C; Tissue Temp: 23.4°C

Probe: ES3DV3 - SN3351; ConvF(4.74, 4.74, 4.74); Calibrated: 6/22/2015;

Sensor-Surface: 3mm (Mechanical Surface Detection)

Electronics: DAE4 Sn1322; Calibrated: 8/24/2015

Phantom: SAM V5.0 Right; Type: QD000P40CD; Serial: 1647

Measurement SW: DASY52, Version 52.8 (8);SEMCAD X Version 14.6.10 (7331)

**Mode: LTE Band 30, Right Head, Cheek, Mid.ch,
10 MHz Bandwidth, QPSK, 1 RB, 0 RB Offset, Camera Module Accessory**

Area Scan (11x18x1): Measurement grid: dx=12mm, dy=12mm

Zoom Scan (7x7x7)/Cube 0: Measurement grid: dx=5mm, dy=5mm, dz=5mm

Reference Value = 11.07 V/m; Power Drift = -0.01 dB

Peak SAR (extrapolated) = 0.258 W/kg

SAR(1 g) = 0.156 W/kg

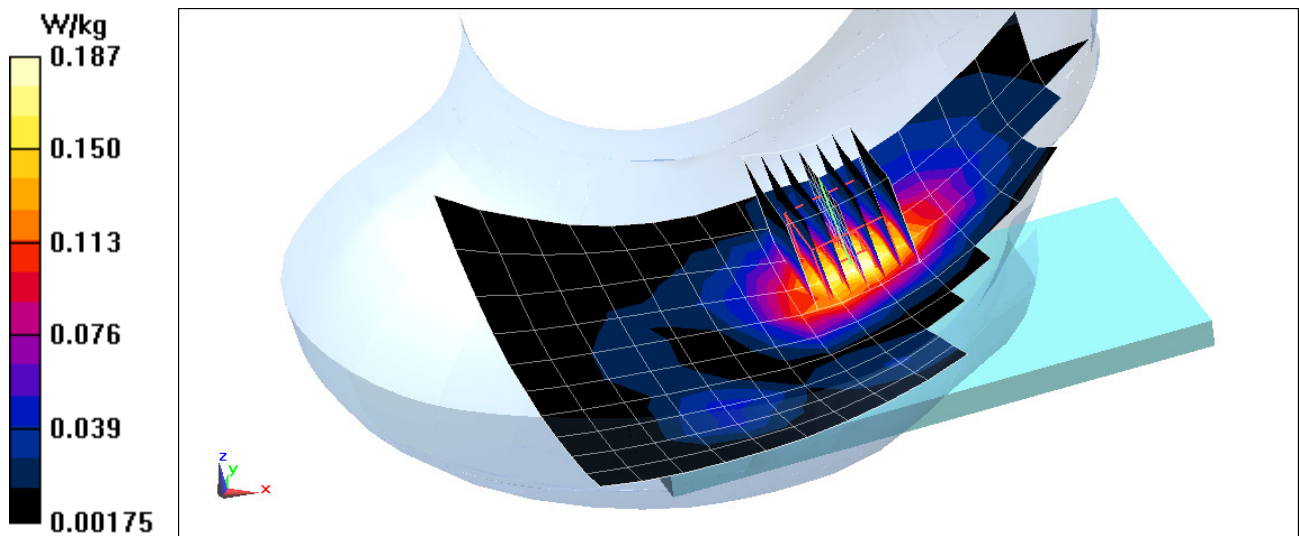

PCTEST ENGINEERING LABORATORY, INC.

DUT: ZNFH820; Type: Portable Handset; Serial: 08137

Communication System: UID 0, LTE Band 7; Frequency: 2510 MHz; Duty Cycle: 1:1
Medium: 2450 Head Medium parameters used (interpolated):
 $f = 2510 \text{ MHz}$; $\sigma = 1.881 \text{ S/m}$; $\epsilon_r = 37.904$; $\rho = 1000 \text{ kg/m}^3$
Phantom section: Right Section

Test Date: 02-22-2016; Ambient Temp: 23.8°C; Tissue Temp: 23.4°C

Probe: ES3DV3 - SN3351; ConvF(4.46, 4.46, 4.46); Calibrated: 6/22/2015;
Sensor-Surface: 3mm (Mechanical Surface Detection)
Electronics: DAE4 Sn1322; Calibrated: 8/24/2015
Phantom: SAM V5.0 Right; Type: QD000P40CD; Serial: 1647
Measurement SW: DASY52, Version 52.8 (8); SEMCAD X Version 14.6.10 (7331)

**Mode: LTE Band 7, Right Head, Cheek, Low.ch,
20 MHz Bandwidth, QPSK, 1 RB, 99 RB Offset, Camera Module Accessory**

Area Scan (11x18x1): Measurement grid: $dx=12\text{mm}$, $dy=12\text{mm}$
Zoom Scan (7x8x7)/Cube 0: Measurement grid: $dx=5\text{mm}$, $dy=5\text{mm}$, $dz=5\text{mm}$
Reference Value = 11.98 V/m; Power Drift = 0.07 dB
Peak SAR (extrapolated) = 0.404 W/kg
SAR(1 g) = 0.233 W/kg

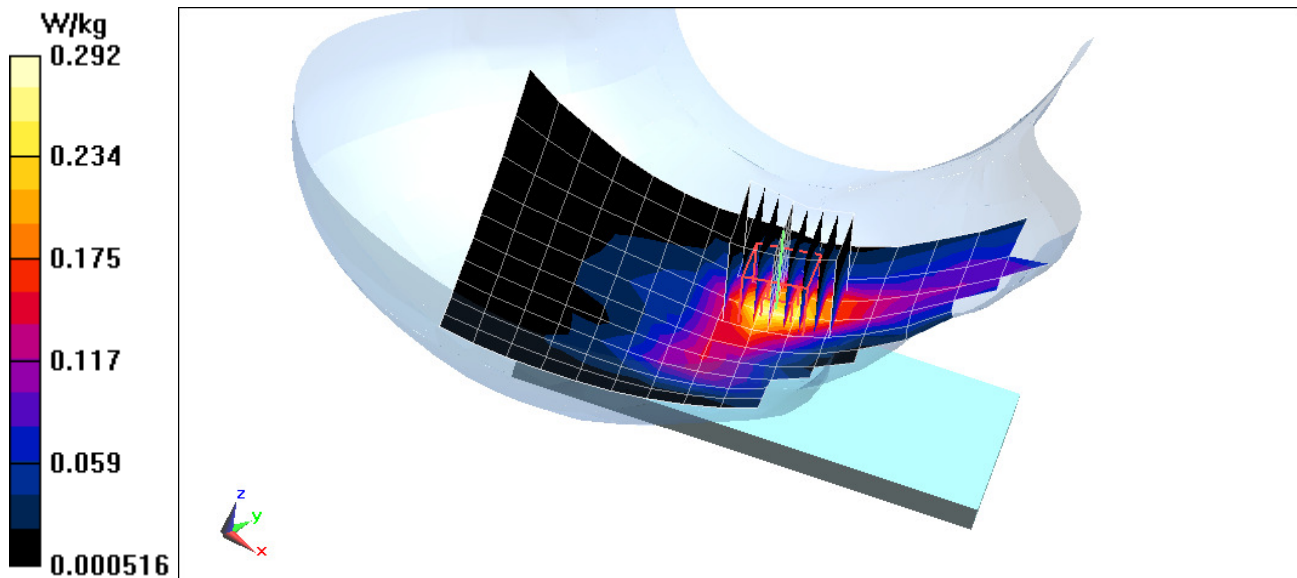

PCTEST ENGINEERING LABORATORY, INC.

DUT: ZNFH820; Type: Portable Handset; Serial: 08202

Communication System: UID 0, IEEE 802.11b; Frequency: 2457 MHz; Duty Cycle: 1:1
Medium: 2450 Head Medium parameters used (interpolated):
 $f = 2457 \text{ MHz}$; $\sigma = 1.817 \text{ S/m}$; $\epsilon_r = 40.388$; $\rho = 1000 \text{ kg/m}^3$
Phantom section: Right Section

Test Date: 02-01-2016; Ambient Temp: 22.5°C; Tissue Temp: 22.5°C

Probe: ES3DV3 - SN3263; ConvF(4.4, 4.4, 4.4); Calibrated: 5/20/2015;

Sensor-Surface: 3mm (Mechanical Surface Detection)

Electronics: DAE4 Sn859; Calibrated: 6/17/2015

Phantom: SAM with CRP (Left); Type: SAM; Serial: 1715

Measurement SW: DASY52, Version 52.8 (8);SEMCAD X Version 14.6.10 (7331)

Mode: IEEE 802.11b, 22 MHz Bandwidth, Right Head, Cheek, Ch 10, 1 Mbps

Area Scan (11x18x1): Measurement grid: dx=12mm, dy=12mm

Zoom Scan (7x8x7)/Cube 0: Measurement grid: dx=5mm, dy=5mm, dz=5mm

Reference Value = 22.09 V/m; Power Drift = 0.04 dB

Peak SAR (extrapolated) = 1.93 W/kg

SAR(1 g) = 0.773 W/kg

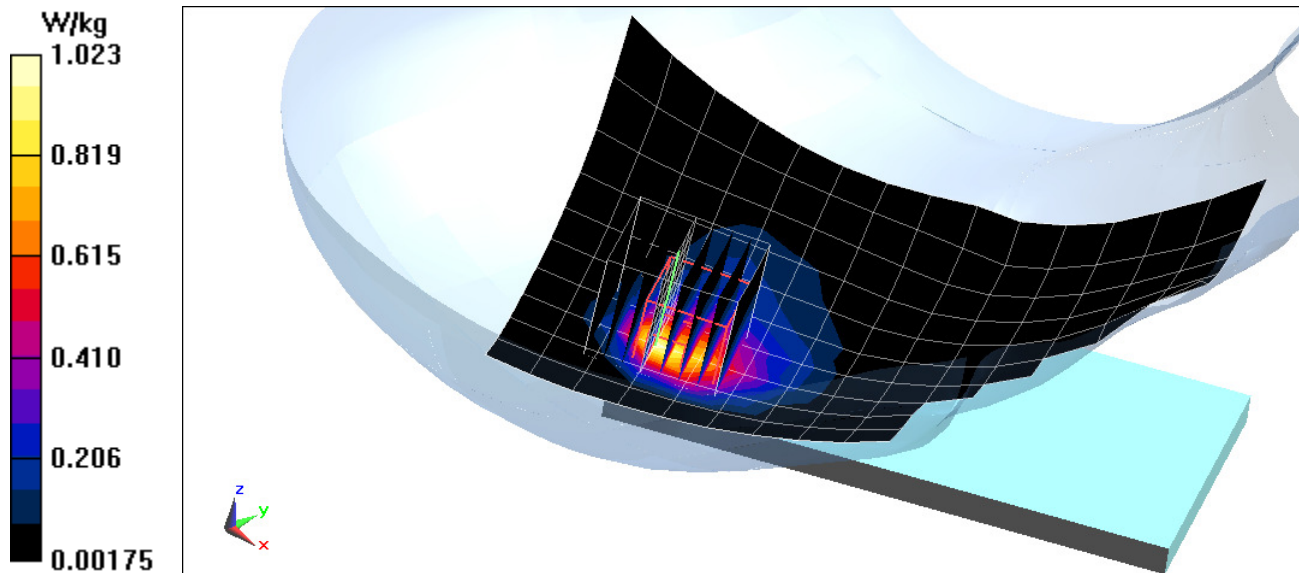

PCTEST ENGINEERING LABORATORY, INC.

DUT: ZNFH820; Type: Portable Handset; Serial: 08202

Communication System: UID 0, 802.11a 5.2-5.8 GHz Band; Frequency: 5745 MHz; Duty Cycle: 1:1
Medium: 5 GHz Head Medium parameters used:
 $f = 5745 \text{ MHz}$; $\sigma = 5.04 \text{ S/m}$; $\epsilon_r = 37.022$; $\rho = 1000 \text{ kg/m}^3$
Phantom section: Right Section

Test Date: 02-10-2016; Ambient Temp: 22.1°C; Tissue Temp: 22.7°C

Probe: EX3DV4 - SN7357; ConvF(4.41, 4.41, 4.41); Calibrated: 4/23/2015;

Sensor-Surface: 1.4mm (Mechanical Surface Detection)

Electronics: DAE4 Sn1407; Calibrated: 4/20/2015

Phantom: SAM v5.0 front; Type: QD000P40CD; Serial: TP-1646

Measurement SW: DASY52, Version 52.8 (8);SEMCAD X Version 14.6.10 (7331)

Mode: IEEE 802.11a, U-NII-3, 20 MHz Bandwidth, Right Head, Tilt, Ch 149, 6 Mbps

Area Scan (9x9x1): Measurement grid: dx=10mm, dy=10mm

Zoom Scan (7x7x7)/Cube 0: Measurement grid: dx=4mm, dy=4mm, dz=1.4mm; Graded Ratio: 1.4

Reference Value = 13.95 V/m; Power Drift = 0.15 dB

Peak SAR (extrapolated) = 4.43 W/kg

SAR(1 g) = 0.798 W/kg

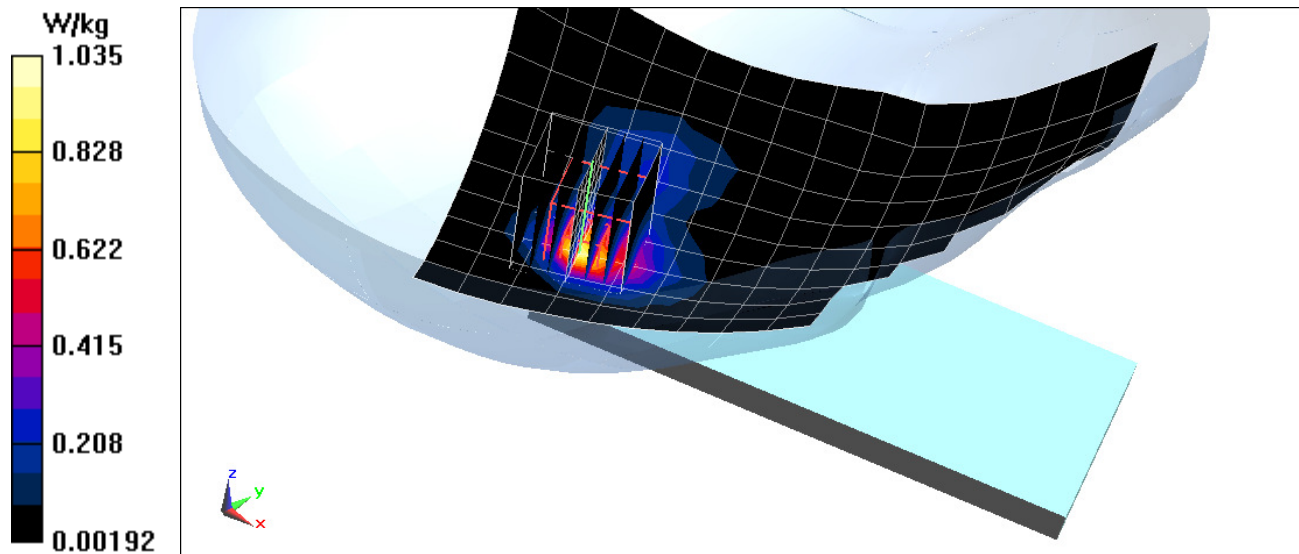

PCTEST ENGINEERING LABORATORY, INC.

DUT: ZNFH820; Type: Portable Handset; Serial: 08103

Communication System: UID 0, GSM GPRS; 3 Tx slot; Frequency: 836.6 MHz; Duty Cycle: 1:2.76
Medium: 835 Body Medium parameters used (interpolated):
 $f = 836.6 \text{ MHz}$; $\sigma = 1.005 \text{ S/m}$; $\epsilon_r = 55.438$; $\rho = 1000 \text{ kg/m}^3$
Phantom section: Flat Section ; Space: 1.0 cm

Test Date: 02-02-2016; Ambient Temp: 24.3°C; Tissue Temp: 22.8°C

Probe: ES3DV3 - SN3334; ConvF(6.24, 6.24, 6.24); Calibrated: 11/17/2015;
Sensor-Surface: 3mm (Mechanical Surface Detection)
Electronics: DAE4 Sn1415; Calibrated: 11/11/2015
Phantom: SAM Front; Type: SAM; Serial: 1686
Measurement SW: DASYS2, Version 52.8 (8);SEMCAD X Version 14.6.10 (7331)

Mode: GPRS 850, Body SAR, Back Side, Mid.ch, 3 Tx Slots

Area Scan (9x15x1): Measurement grid: dx=15mm, dy=15mm
Zoom Scan (5x5x7)/Cube 0: Measurement grid: dx=8mm, dy=8mm, dz=5mm
Reference Value = 32.05 V/m; Power Drift = -0.03 dB
Peak SAR (extrapolated) = 1.29 W/kg
SAR(1 g) = 1.01 W/kg

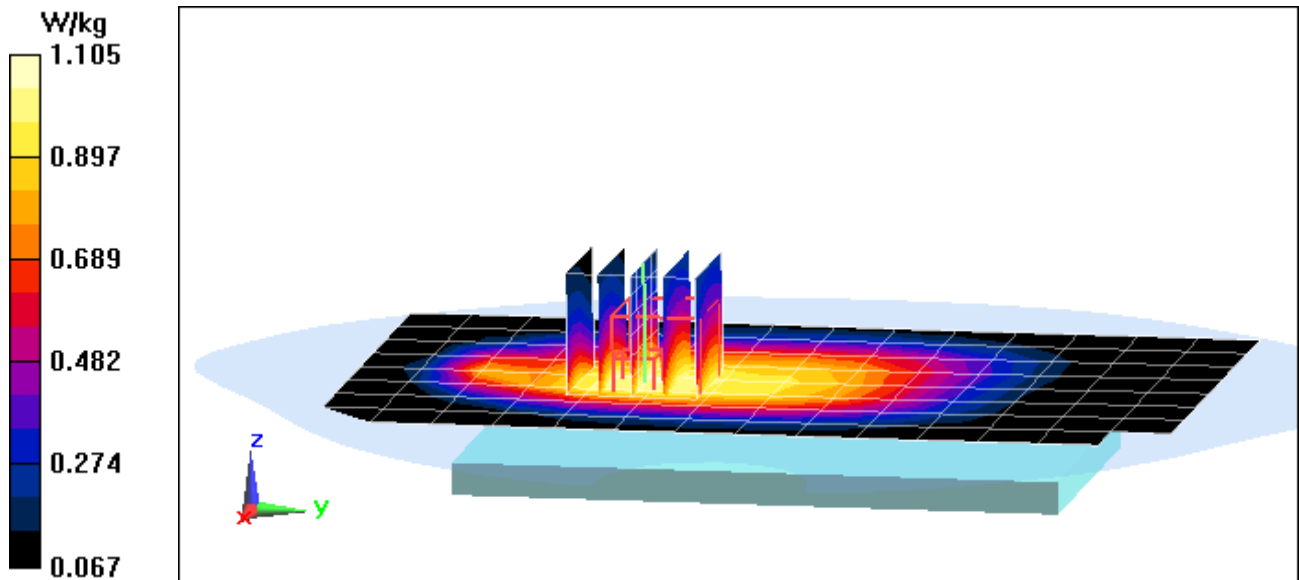

PCTEST ENGINEERING LABORATORY, INC.

DUT: ZNFH820; Type: Portable Handset; Serial: 08103

Communication System: UID 0, GSM GPRS; 3 Tx slots; Frequency: 836.6 MHz; Duty Cycle: 1:2.76
Medium: 835 Body Medium parameters used (interpolated):
 $f = 836.6 \text{ MHz}$; $\sigma = 1.005 \text{ S/m}$; $\epsilon_r = 55.438$; $\rho = 1000 \text{ kg/m}^3$
Phantom section: Flat Section ; Space: 1.0 cm

Test Date: 02-02-2016; Ambient Temp: 24.3°C; Tissue Temp: 22.8°C

Probe: ES3DV3 - SN3334; ConvF(6.24, 6.24, 6.24); Calibrated: 11/17/2015;
Sensor-Surface: 3mm (Mechanical Surface Detection)
Electronics: DAE4 Sn1415; Calibrated: 11/11/2015
Phantom: SAM Front; Type: SAM; Serial: 1686
Measurement SW: DASY52, Version 52.8 (8);SEMCAD X Version 14.6.10 (7331)

Mode: GPRS 850, Body SAR, Left Edge, Mid.ch, 3 Tx Slots

Area Scan (10x13x1): Measurement grid: dx=5mm, dy=15mm
Zoom Scan (5x5x7)/Cube 0: Measurement grid: dx=8mm, dy=8mm, dz=5mm
Reference Value = 34.18 V/m; Power Drift = -0.03 dB
Peak SAR (extrapolated) = 1.52 W/kg
SAR(1 g) = 1.06 W/kg

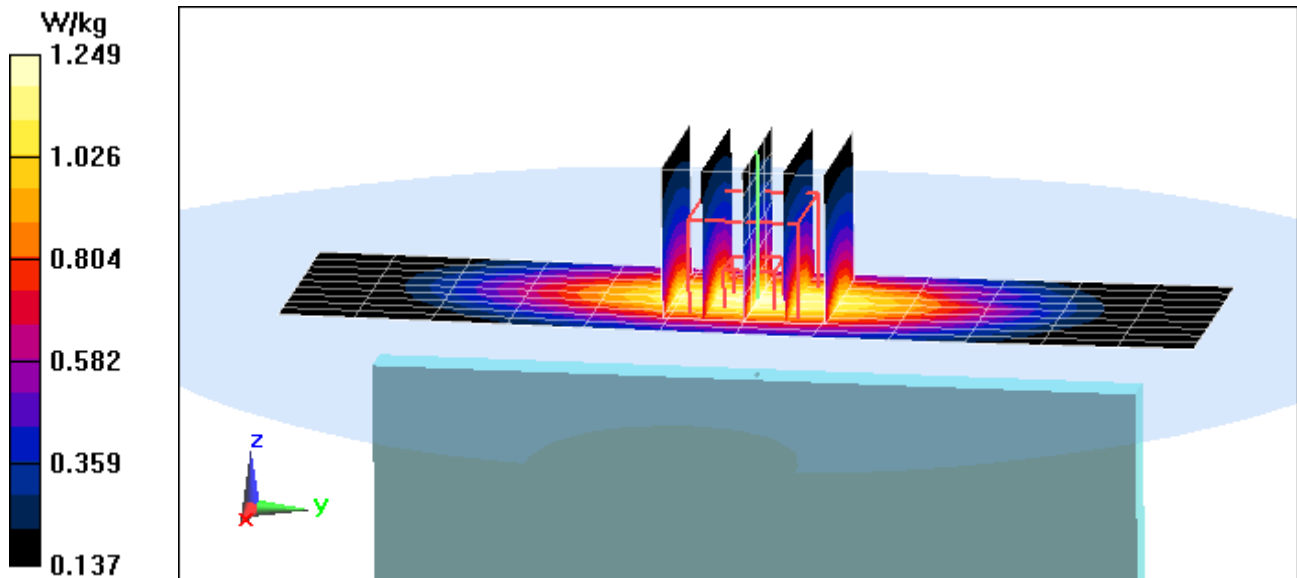

PCTEST ENGINEERING LABORATORY, INC.

DUT: ZNFH820; Type: Portable Handset; Serial: 08103

Communication System: UID 0, UMTS; Frequency: 836.6 MHz; Duty Cycle: 1:1
Medium: 835 Body Medium parameters used (interpolated):
 $f = 836.6 \text{ MHz}$; $\sigma = 1.005 \text{ S/m}$; $\epsilon_r = 55.438$; $\rho = 1000 \text{ kg/m}^3$
Phantom section: Flat Section; Space: 1.0 cm

Test Date: 02-02-2016; Ambient Temp: 24.3°C; Tissue Temp: 22.8°C

Probe: ES3DV3 - SN3334; ConvF(6.24, 6.24, 6.24); Calibrated: 11/17/2015;
Sensor-Surface: 3mm (Mechanical Surface Detection)
Electronics: DAE4 Sn1415; Calibrated: 11/11/2015
Phantom: SAM Front; Type: SAM; Serial: 1686
Measurement SW: DASY52, Version 52.8 (8);SEMCAD X Version 14.6.10 (7331)

Mode: UMTS 850, Body SAR, Back Side, Mid.ch

Area Scan (9x14x1): Measurement grid: dx=15mm, dy=15mm
Zoom Scan (5x5x7)/Cube 0: Measurement grid: dx=8mm, dy=8mm, dz=5mm
Reference Value = 22.47 V/m; Power Drift = -0.02 dB
Peak SAR (extrapolated) = 0.850 W/kg
SAR(1 g) = 0.507 W/kg

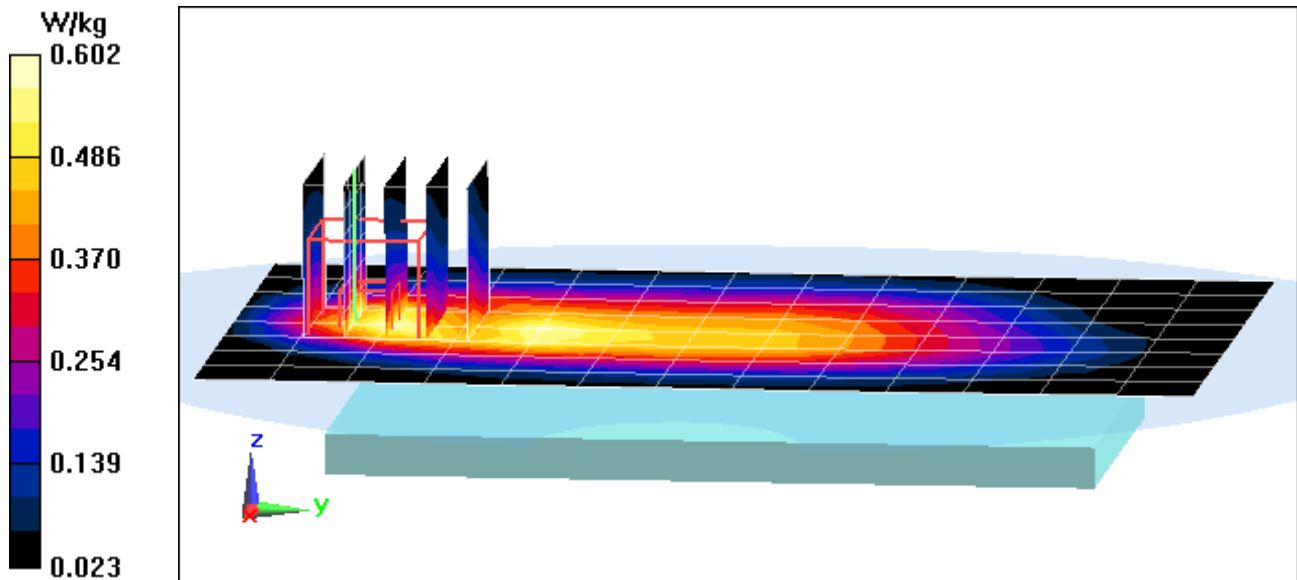

PCTEST ENGINEERING LABORATORY, INC.

DUT: ZNFH820; Type: Portable Handset; Serial: 08103

Communication System: UID 0, UMTS; Frequency: 836.6 MHz; Duty Cycle: 1:1
Medium: 835 Body Medium parameters used (interpolated):
 $f = 836.6 \text{ MHz}$; $\sigma = 1.005 \text{ S/m}$; $\epsilon_r = 55.438$; $\rho = 1000 \text{ kg/m}^3$
Phantom section: Flat Section; Space: 1.0 cm

Test Date: 02-02-2016; Ambient Temp: 24.3°C; Tissue Temp: 22.8°C

Probe: ES3DV3 - SN3334; ConvF(6.24, 6.24, 6.24); Calibrated: 11/17/2015;
Sensor-Surface: 3mm (Mechanical Surface Detection)
Electronics: DAE4 Sn1415; Calibrated: 11/11/2015
Phantom: SAM Front; Type: SAM; Serial: 1686
Measurement SW: DASY52, Version 52.8 (8);SEMCAD X Version 14.6.10 (7331)

Mode: UMTS 850, Body SAR, Left Edge, Mid.ch

Area Scan (10x14x1): Measurement grid: dx=5mm, dy=15mm
Zoom Scan (5x5x7)/Cube 0: Measurement grid: dx=8mm, dy=8mm, dz=5mm
Reference Value = 25.73 V/m; Power Drift = 0.01 dB
Peak SAR (extrapolated) = 0.858 W/kg
SAR(1 g) = 0.611 W/kg

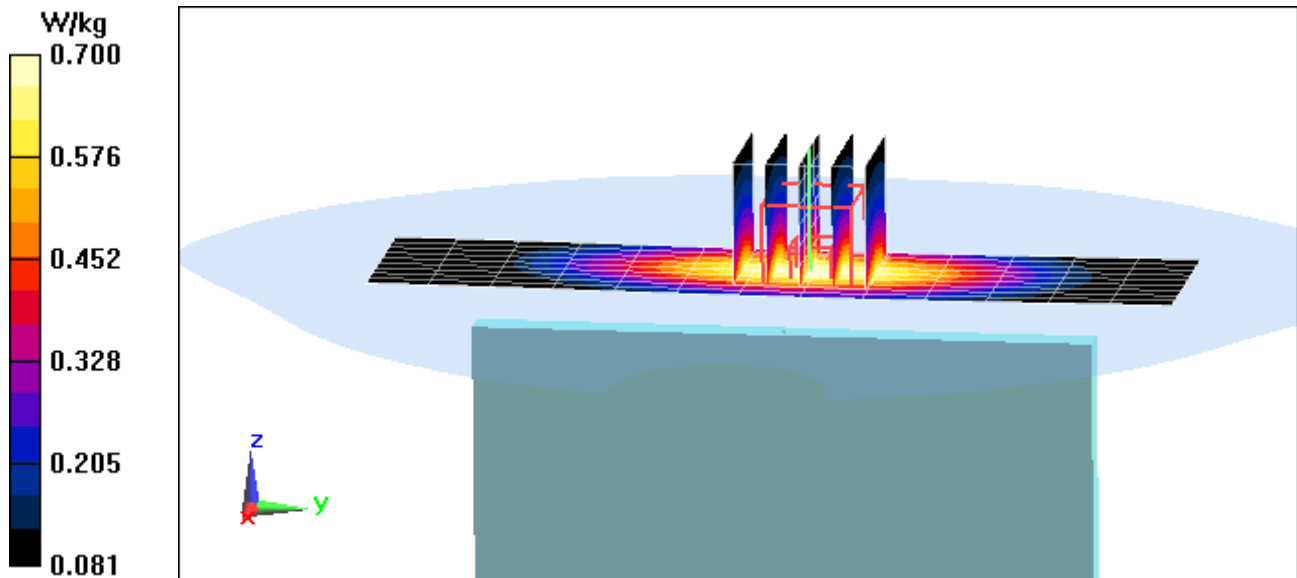

PCTEST ENGINEERING LABORATORY, INC.

DUT: ZNFH820; Type: Portable Handset; Serial: 08103

Communication System: UID 0, UMTS; Frequency: 1732.4 MHz; Duty Cycle: 1:1
Medium: 1750 Body Medium parameters used (interpolated):
 $f = 1732.4 \text{ MHz}$; $\sigma = 1.492 \text{ S/m}$; $\epsilon_r = 51.608$; $\rho = 1000 \text{ kg/m}^3$
Phantom section: Flat Section ; Space: 1.0 cm

Test Date: 02-01-2016; Ambient Temp: 23.2°C; Tissue Temp: 22.5°C

Probe: ES3DV2 - SN3022; ConvF(4.79, 4.79, 4.79); Calibrated: 8/26/2015;
Sensor-Surface: 3mm (Mechanical Surface Detection)
Electronics: DAE4 Sn665; Calibrated: 2/18/2015

Phantom: SAM with CRP v4.0; Type: QD000P40CD; Serial: TP:1797
Measurement SW: DASY52, Version 52.8 (8);SEMCAD X Version 14.6.10 (7331)

Mode: AWS UMTS, Body SAR, Back Side, Mid.ch, Ant 2

Area Scan (9x15x1): Measurement grid: dx=15mm, dy=15mm

Zoom Scan (5x5x7)/Cube 1: Measurement grid: dx=8mm, dy=8mm, dz=5mm

Reference Value = 22.97 V/m; Power Drift = 0.07 dB

Peak SAR (extrapolated) = 1.07 W/kg

SAR(1 g) = 0.721 W/kg

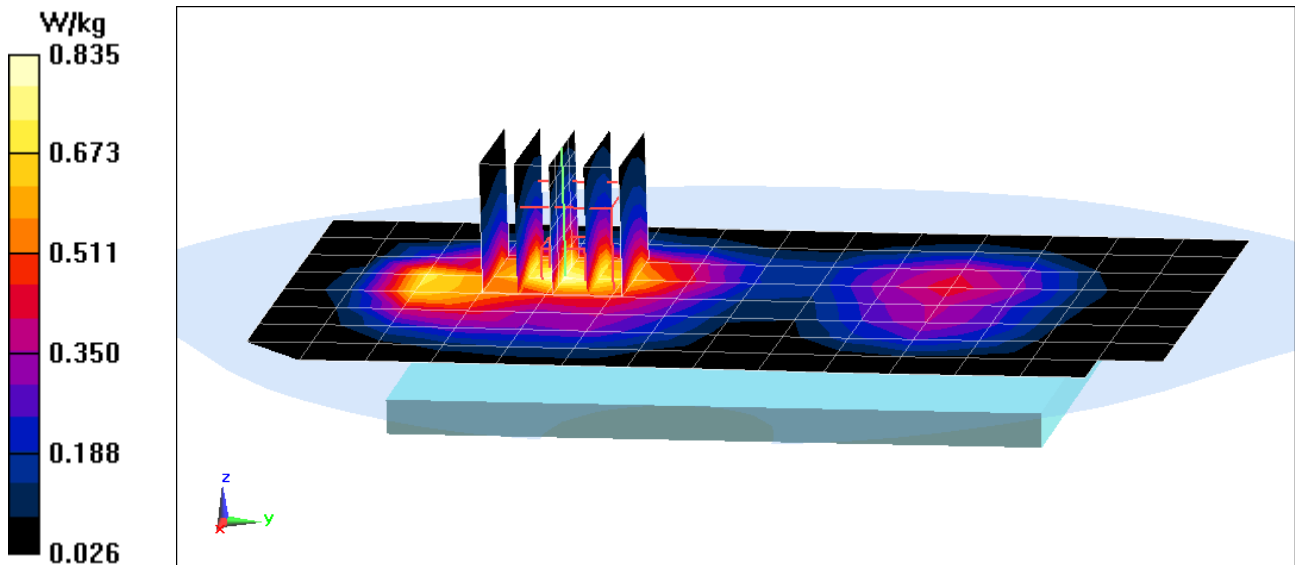

PCTEST ENGINEERING LABORATORY, INC.

DUT: ZNFH820; Type: Portable Handset; Serial: 08079

Communication System: UID 0, UMTS; Frequency: 1732.4 MHz; Duty Cycle: 1:1
Medium: 1750 Body Medium parameters used (interpolated):
 $f = 1732.4 \text{ MHz}$; $\sigma = 1.492 \text{ S/m}$; $\epsilon_r = 51.608$; $\rho = 1000 \text{ kg/m}^3$
Phantom section: Flat Section ; Space: 1.0 cm

Test Date: 02-01-2016; Ambient Temp: 23.2°C; Tissue Temp: 22.5°C

Probe: ES3DV2 - SN3022; ConvF(4.79, 4.79, 4.79); Calibrated: 8/26/2015;
Sensor-Surface: 3mm (Mechanical Surface Detection)
Electronics: DAE4 Sn665; Calibrated: 2/18/2015
Phantom: SAM with CRP v4.0; Type: QD000P40CD; Serial: TP:1797
Measurement SW: DASY52, Version 52.8 (8);SEMCAD X Version 14.6.10 (7331)

Mode: AWS UMTS, Body SAR, Top Edge, Mid.ch, Ant 3

Area Scan (10x7x1): Measurement grid: dx=5mm, dy=15mm
Zoom Scan (5x5x7)/Cube 0: Measurement grid: dx=8mm, dy=8mm, dz=5mm
Reference Value = 23.91 V/m; Power Drift = -0.03 dB
Peak SAR (extrapolated) = 1.37 W/kg
SAR(1 g) = 0.785 W/kg

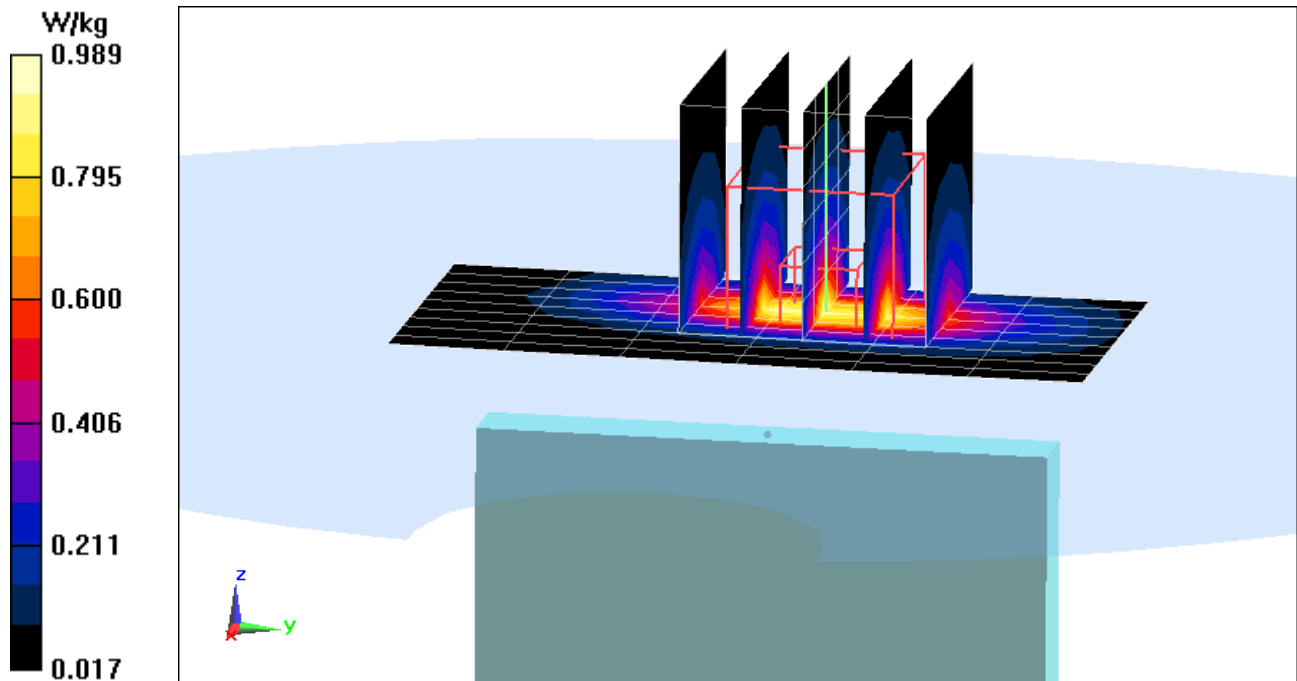

PCTEST ENGINEERING LABORATORY, INC.

DUT: ZNFH820; Type: Portable Handset; Serial: 08103

Communication System: UID 0, GSM; Frequency: 1880 MHz; Duty Cycle: 1:8.3
Medium: 1900 Body Medium parameters used:
 $f = 1880 \text{ MHz}$; $\sigma = 1.551 \text{ S/m}$; $\epsilon_r = 51.378$; $\rho = 1000 \text{ kg/m}^3$
Phantom section: Flat Section ; Space: 1.0 cm

Test Date: 02-08-2016; Ambient Temp: 22.0°C; Tissue Temp: 21.2°C

Probe: ES3DV3 - SN3334; ConvF(4.84, 4.84, 4.84); Calibrated: 11/17/2015;
Sensor-Surface: 3mm (Mechanical Surface Detection)
Electronics: DAE4 Sn1415; Calibrated: 11/11/2015
Phantom: SAM Front; Type: SAM; Serial: 1686
Measurement SW: DASY52, Version 52.8 (8);SEMCAD X Version 14.6.10 (7331)

Mode: GSM 1900, Body SAR, Back Side, Mid.ch

Area Scan (9x14x1): Measurement grid: dx=15mm, dy=15mm
Zoom Scan (5x5x7)/Cube 0: Measurement grid: dx=8mm, dy=8mm, dz=5mm
Reference Value = 14.45 V/m; Power Drift = -0.06 dB
Peak SAR (extrapolated) = 0.578 W/kg
SAR(1 g) = 0.307 W/kg

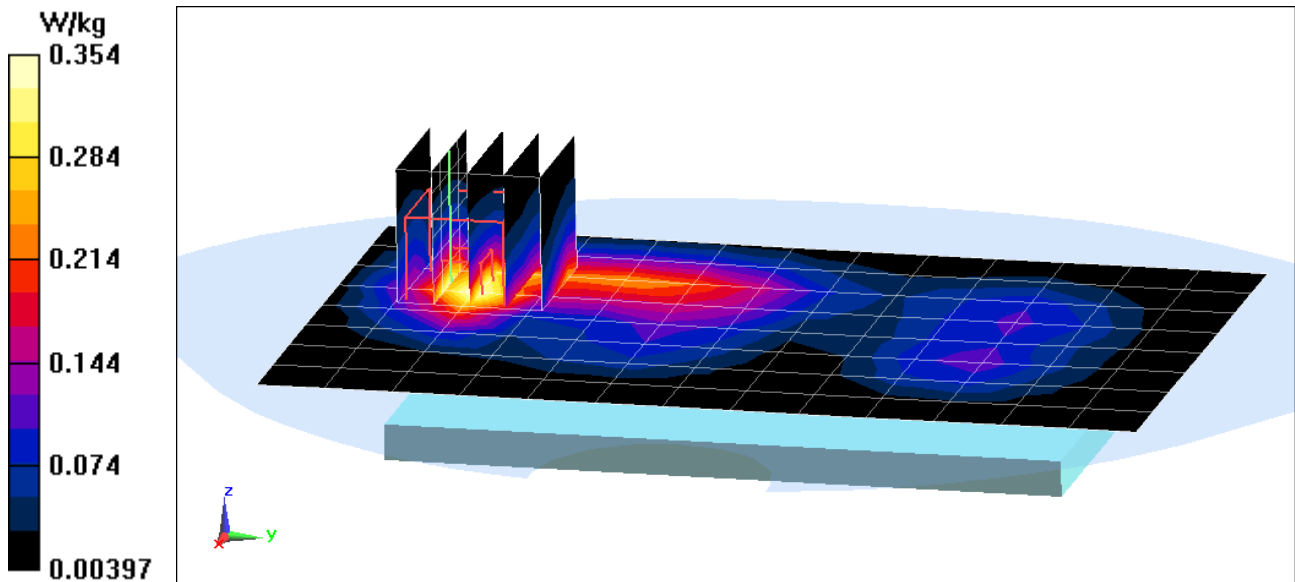

PCTEST ENGINEERING LABORATORY, INC.

DUT: ZNFH820; Type: Portable Handset; Serial: 08103

Communication System: UID 0, GSM GPRS; 4 Tx slots; Frequency: 1880 MHz; Duty Cycle: 1:2.076

Medium: 1900 Body Medium parameters used:

$f = 1880 \text{ MHz}$; $\sigma = 1.551 \text{ S/m}$; $\epsilon_r = 51.378$; $\rho = 1000 \text{ kg/m}^3$

Phantom section: Flat Section; Space: 1.0 cm

Test Date: 02-08-2016; Ambient Temp: 22.0°C; Tissue Temp: 21.2°C

Probe: ES3DV3 - SN3334; ConvF(4.84, 4.84, 4.84); Calibrated: 11/17/2015;

Sensor-Surface: 3mm (Mechanical Surface Detection)

Electronics: DAE4 Sn1415; Calibrated: 11/11/2015

Phantom: SAM Front; Type: SAM; Serial: 1686

Measurement SW: DASY52, Version 52.8 (8);SEMCAD X Version 14.6.10 (7331)

Mode: GPRS 1900, Body SAR, Back Side, Mid.ch, 4 Tx Slots

Area Scan (9x14x1): Measurement grid: dx=15mm, dy=15mm

Zoom Scan (5x5x7)/Cube 0: Measurement grid: dx=8mm, dy=8mm, dz=5mm

Reference Value = 13.90 V/m; Power Drift = -0.08 dB

Peak SAR (extrapolated) = 0.555 W/kg

SAR(1 g) = 0.294 W/kg

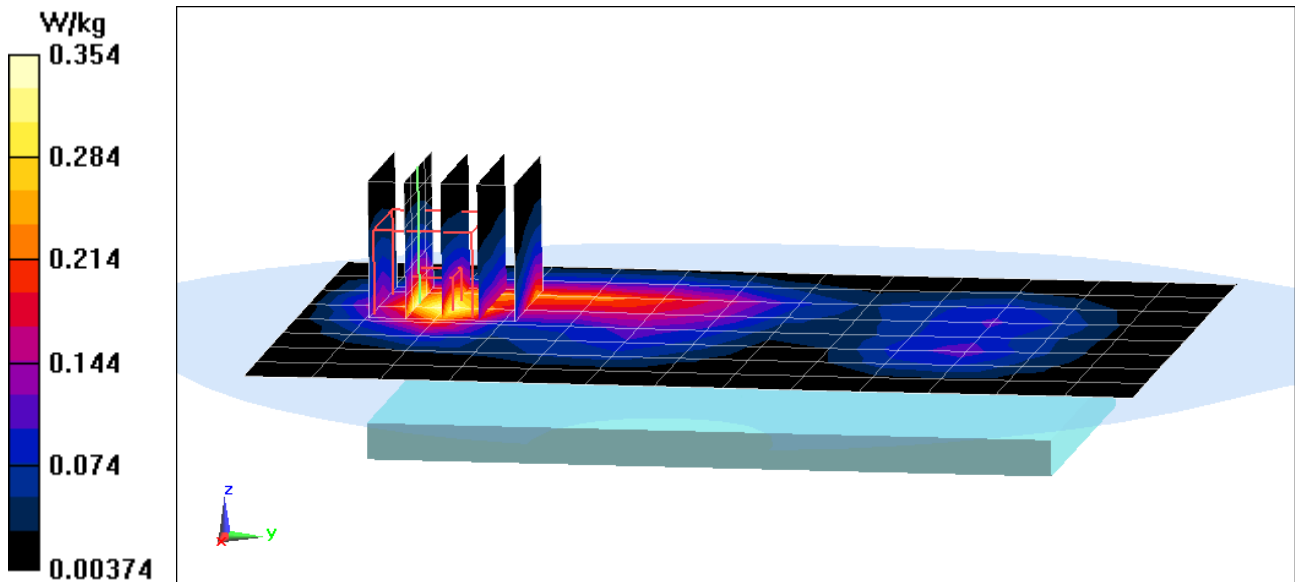

PCTEST ENGINEERING LABORATORY, INC.

DUT: ZNFH820; Type: Portable Handset; Serial: 08103

Communication System: UID 0, UMTS; Frequency: 1907.6 MHz; Duty Cycle: 1:1
Medium: 1900 Body Medium parameters used (interpolated):
 $f = 1907.6 \text{ MHz}$; $\sigma = 1.582 \text{ S/m}$; $\epsilon_r = 51.296$; $\rho = 1000 \text{ kg/m}^3$
Phantom section: Flat Section; Space: 1.0 cm

Test Date: 02-08-2016; Ambient Temp: 22.0°C; Tissue Temp: 21.2°C

Probe: ES3DV3 - SN3334; ConvF(4.84, 4.84, 4.84); Calibrated: 11/17/2015;
Sensor-Surface: 3mm (Mechanical Surface Detection)
Electronics: DAE4 Sn1415; Calibrated: 11/11/2015
Phantom: SAM Front; Type: SAM; Serial: 1686
Measurement SW: DASY52, Version 52.8 (8);SEMCAD X Version 14.6.10 (7331)

Mode: UMTS 1900, Body SAR, Back Side, High.ch, Ant 2

Area Scan (9x15x1): Measurement grid: dx=15mm, dy=15mm

Zoom Scan (5x6x7)/Cube 0: Measurement grid: dx=8mm, dy=8mm, dz=5mm

Reference Value = 24.22 V/m; Power Drift = 0.02 dB

Peak SAR (extrapolated) = 1.96 W/kg

SAR(1 g) = 1.05 W/kg

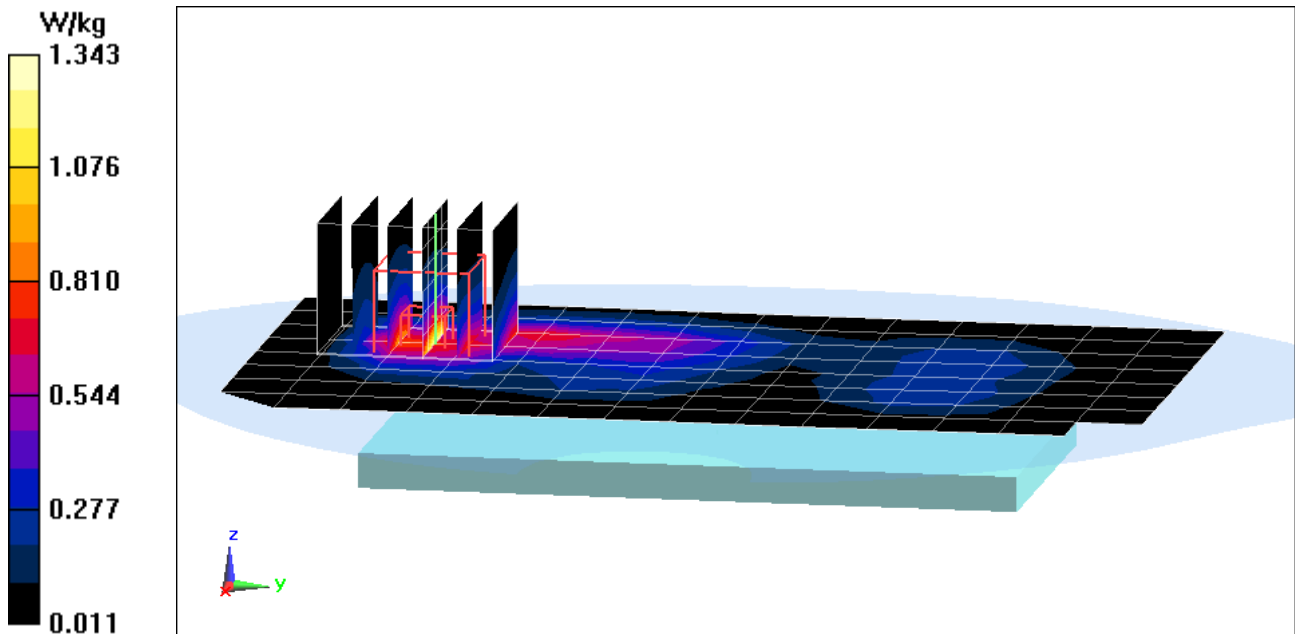

PCTEST ENGINEERING LABORATORY, INC.

DUT: ZNFH820; Type: Portable Handset; Serial: 08038

Communication System: UID 0, LTE Band 12; Frequency: 707.5 MHz; Duty Cycle: 1:1
Medium: 750 Body Medium parameters used (interpolated):
 $f = 707.5 \text{ MHz}$; $\sigma = 0.922 \text{ S/m}$; $\epsilon_r = 55.048$; $\rho = 1000 \text{ kg/m}^3$
Phantom section: Flat Section; Space: 1.0 cm

Test Date: 02-08-2016; Ambient Temp: 20.6°C; Tissue Temp: 21.1°C

Probe: ES3DV2 - SN3022; ConvF(6.16, 6.16, 6.16); Calibrated: 8/26/2015;
Sensor-Surface: 3mm (Mechanical Surface Detection)
Electronics: DAE4 Sn665; Calibrated: 2/18/2015

Phantom: SAM with CRP v4.0; Type: QD000P40CD; Serial: TP:1797
Measurement SW: DASY52, Version 52.8 (8);SEMCAD X Version 14.6.10 (7331)

**Mode: LTE Band 12, Body SAR, Back Side, Mid.ch,
10 MHz Bandwidth, QPSK, 1 RB, 0 RB Offset**

Area Scan (9x13x1): Measurement grid: dx=15mm, dy=15mm

Zoom Scan (7x9x7)/Cube 0: Measurement grid: dx=8mm, dy=8mm, dz=5mm

Reference Value = 23.93 V/m; Power Drift = -0.03 dB

Peak SAR (extrapolated) = 0.806 W/kg

SAR(1 g) = 0.505 W/kg

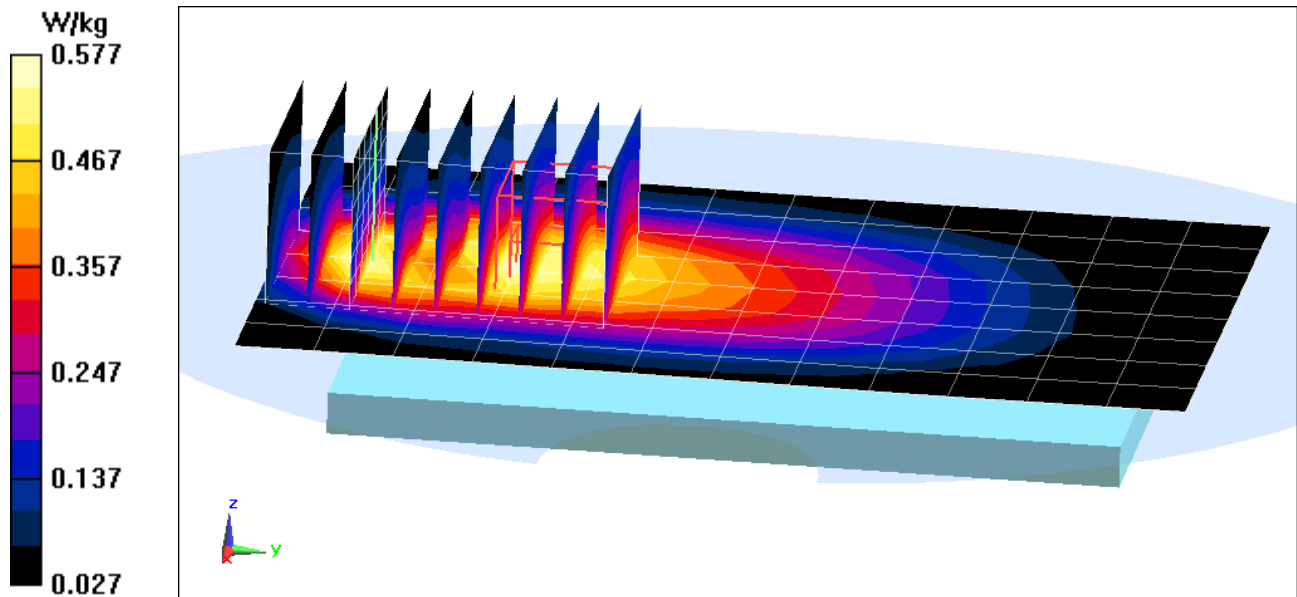

PCTEST ENGINEERING LABORATORY, INC.

DUT: ZNFH820; Type: Portable Handset; Serial: 08137

Communication System: UID 0, LTE Band 5; Frequency: 836.5 MHz; Duty Cycle: 1:1
Medium: 835 Body Medium parameters used (interpolated):
 $f = 836.5 \text{ MHz}$; $\sigma = 1.005 \text{ S/m}$; $\epsilon_r = 55.439$; $\rho = 1000 \text{ kg/m}^3$
Phantom section: Flat Section ; Space: 1.0 cm

Test Date: 02-02-2016; Ambient Temp: 24.3°C; Tissue Temp: 22.8°C

Probe: ES3DV3 - SN3334; ConvF(6.24, 6.24, 6.24); Calibrated: 11/17/2015;
Sensor-Surface: 3mm (Mechanical Surface Detection)
Electronics: DAE4 Sn1415; Calibrated: 11/11/2015
Phantom: SAM Front; Type: SAM; Serial: 1686
Measurement SW: DASYS2, Version 52.8 (8);SEMCAD X Version 14.6.10 (7331)

**Mode: LTE Band 5 (Cell.), Body SAR, Back Side, Mid.ch,
10 MHz Bandwidth, QPSK, 1 RB, 25 RB Offset**

Area Scan (9x14x1): Measurement grid: dx=15mm, dy=15mm
Zoom Scan (5x5x7)/Cube 0: Measurement grid: dx=8mm, dy=8mm, dz=5mm
Reference Value = 22.14 V/m; Power Drift = -0.04 dB
Peak SAR (extrapolated) = 0.830 W/kg
SAR(1 g) = 0.498 W/kg

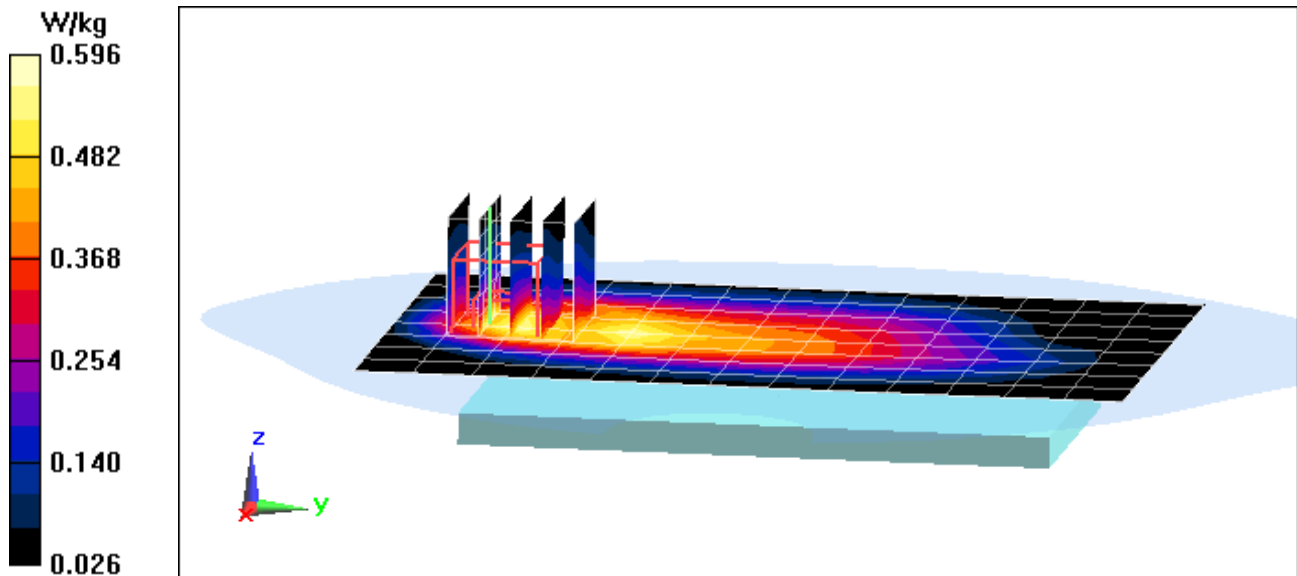

PCTEST ENGINEERING LABORATORY, INC.

DUT: ZNFH820; Type: Portable Handset; Serial: 08137

Communication System: UID 0, LTE Band 5; Frequency: 836.5 MHz; Duty Cycle: 1:1
Medium: 835 Body Medium parameters used (interpolated):
 $f = 836.5 \text{ MHz}$; $\sigma = 1.005 \text{ S/m}$; $\epsilon_r = 55.439$; $\rho = 1000 \text{ kg/m}^3$
Phantom section: Flat Section ; Space: 1.0 cm

Test Date: 02-02-2016; Ambient Temp: 24.3°C; Tissue Temp: 22.8°C

Probe: ES3DV3 - SN3334; ConvF(6.24, 6.24, 6.24); Calibrated: 11/17/2015;
Sensor-Surface: 3mm (Mechanical Surface Detection)
Electronics: DAE4 Sn1415; Calibrated: 11/11/2015
Phantom: SAM Front; Type: SAM; Serial: 1686
Measurement SW: DASY52, Version 52.8 (8);SEMCAD X Version 14.6.10 (7331)

**Mode: LTE Band 5 (Cell.), Body SAR, Left Edge, Mid.ch,
10 MHz Bandwidth, QPSK, 1 RB, 25 RB Offset**

Area Scan (11x14x1): Measurement grid: dx=5mm, dy=15mm
Zoom Scan (5x5x7)/Cube 0: Measurement grid: dx=8mm, dy=8mm, dz=5mm
Reference Value = 24.13 V/m; Power Drift = -0.01 dB
Peak SAR (extrapolated) = 0.753 W/kg
SAR(1 g) = 0.533 W/kg

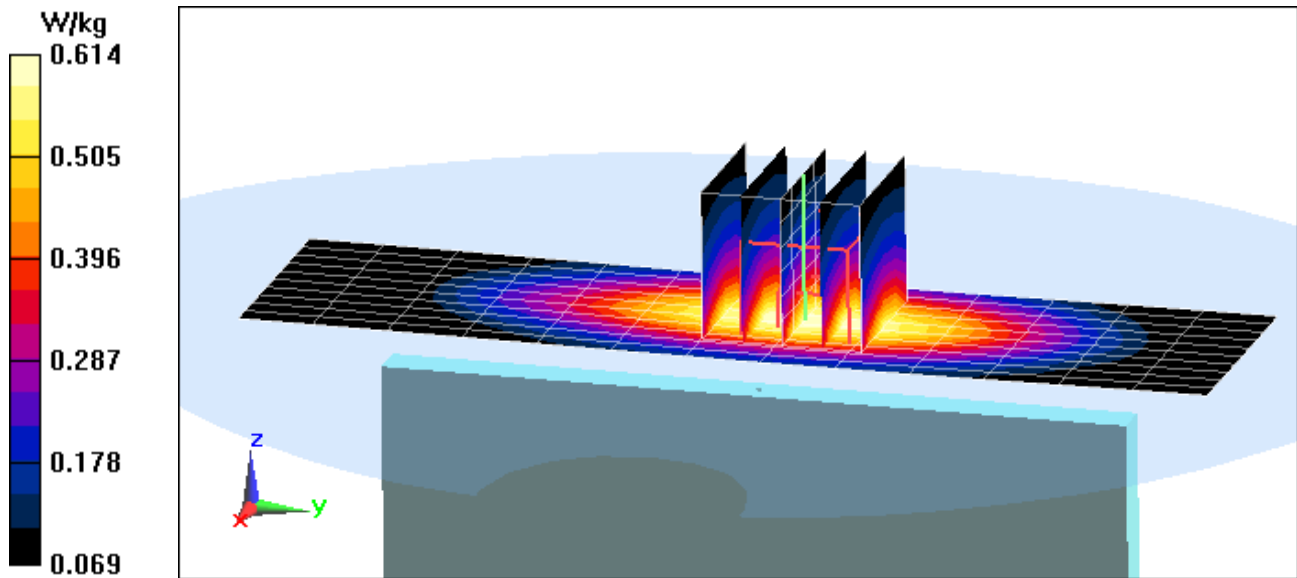

PCTEST ENGINEERING LABORATORY, INC.

DUT: ZNFH820; Type: Portable Handset; Serial: 08137

Communication System: UID 0, LTE Band 4 (AWS); Frequency: 1732.5 MHz; Duty Cycle: 1:1
Medium: 1750 Body Medium parameters used (interpolated):
 $f = 1732.5 \text{ MHz}$; $\sigma = 1.492 \text{ S/m}$; $\epsilon_r = 51.607$; $\rho = 1000 \text{ kg/m}^3$
Phantom section: Flat Section; Space: 1.0 cm

Test Date: 02-01-2016; Ambient Temp: 23.2°C; Tissue Temp: 22.5°C

Probe: ES3DV2 - SN3022; ConvF(4.79, 4.79, 4.79); Calibrated: 8/26/2015;
Sensor-Surface: 3mm (Mechanical Surface Detection)
Electronics: DAE4 Sn665; Calibrated: 2/18/2015
Phantom: SAM with CRP v4.0; Type: QD000P40CD; Serial: TP:1797
Measurement SW: DASY52, Version 52.8 (8);SEMCAD X Version 14.6.10 (7331)

**Mode: LTE Band 4 (AWS), Body SAR, Back Side, Mid.ch,
20 MHz Bandwidth, QPSK, 1 RB, 0 RB Offset, Ant 2**

Area Scan (9x13x1): Measurement grid: $dx=15\text{mm}$, $dy=15\text{mm}$
Zoom Scan (5x5x7)/Cube 0: Measurement grid: $dx=8\text{mm}$, $dy=8\text{mm}$, $dz=5\text{mm}$
Reference Value = 27.71 V/m; Power Drift = 0.02 dB
Peak SAR (extrapolated) = 1.98 W/kg
SAR(1 g) = 1.09 W/kg

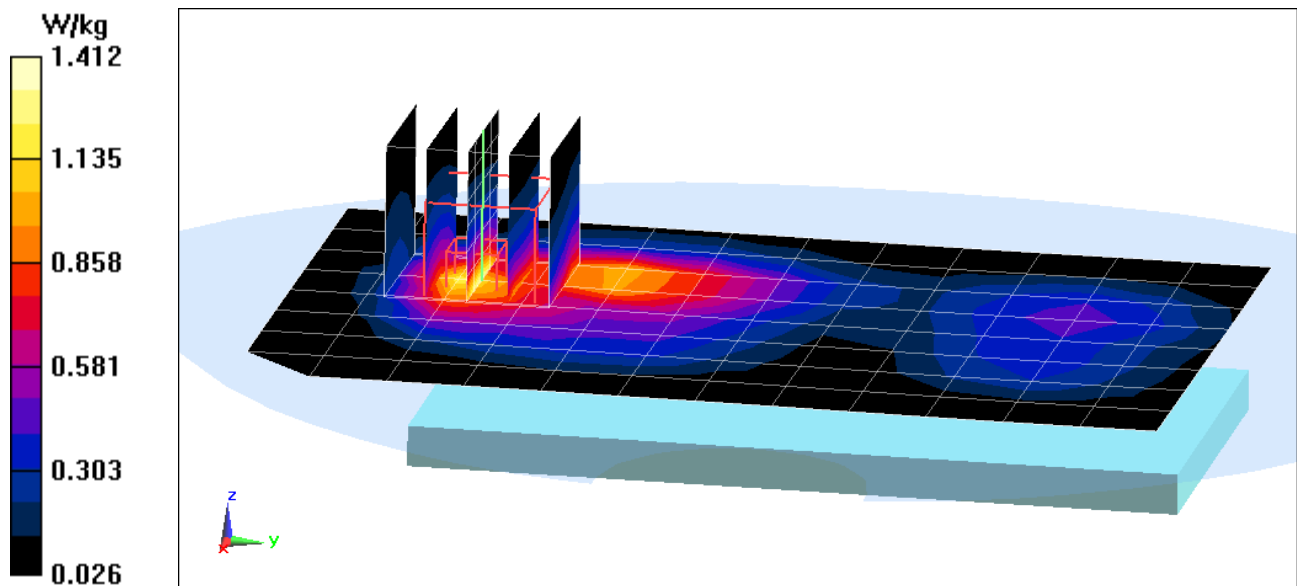

PCTEST ENGINEERING LABORATORY, INC.

DUT: ZNFH820; Type: Portable Handset; Serial: 08137

Communication System: UID 0, LTE Band 2 (PCS); Frequency: 1900 MHz; Duty Cycle: 1:1
Medium: 1900 Body Medium parameters used (interpolated):
 $f = 1900 \text{ MHz}$; $\sigma = 1.574 \text{ S/m}$; $\epsilon_r = 51.319$; $\rho = 1000 \text{ kg/m}^3$
Phantom section: Flat Section; Space: 1.0 cm

Test Date: 02-08-2016; Ambient Temp: 22.0°C; Tissue Temp: 21.2°C

Probe: ES3DV3 - SN3334; ConvF(4.84, 4.84, 4.84); Calibrated: 11/17/2015;
Sensor-Surface: 3mm (Mechanical Surface Detection)
Electronics: DAE4 Sn1415; Calibrated: 11/11/2015
Phantom: SAM Front; Type: SAM; Serial: 1686
Measurement SW: DASY52, Version 52.8 (8);SEMCAD X Version 14.6.10 (7331)

**Mode: LTE Band 2 (PCS), Body SAR, Back Side, High.ch,
20 MHz Bandwidth, QPSK, 1 RB, 99 RB Offset, Ant 2**

Area Scan (9x14x1): Measurement grid: dx=15mm, dy=15mm
Zoom Scan (5x5x7)/Cube 0: Measurement grid: dx=8mm, dy=8mm, dz=5mm
Reference Value = 27.16 V/m; Power Drift = -0.01 dB
Peak SAR (extrapolated) = 1.92 W/kg
SAR(1 g) = 1.02 W/kg

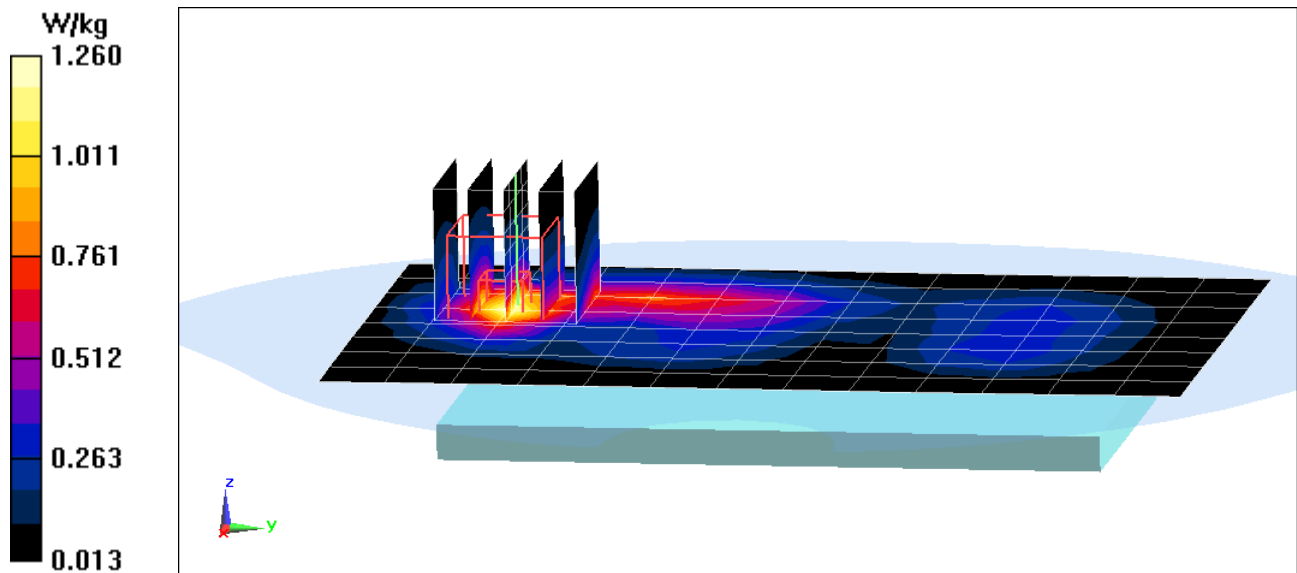

PCTEST ENGINEERING LABORATORY, INC.

DUT: ZNFH820; Type: Portable Handset; Serial: 08046

Communication System: UID 0, LTE Band 2 (PCS); Frequency: 1880 MHz; Duty Cycle: 1:1

Medium: 1900 Body Medium parameters used:

$f = 1880 \text{ MHz}$; $\sigma = 1.551 \text{ S/m}$; $\epsilon_r = 51.378$; $\rho = 1000 \text{ kg/m}^3$

Phantom section: Flat Section; Space: 1.0 cm

Test Date: 02-08-2016; Ambient Temp: 22.0°C; Tissue Temp: 21.2°C

Probe: ES3DV3 - SN3334; ConvF(4.84, 4.84, 4.84); Calibrated: 11/17/2015;

Sensor-Surface: 3mm (Mechanical Surface Detection)

Electronics: DAE4 Sn1415; Calibrated: 11/11/2015

Phantom: SAM Front; Type: SAM; Serial: 1686

Measurement SW: DASY52, Version 52.8 (8);SEMCAD X Version 14.6.10 (7331)

**Mode: LTE Band 2 (PCS), Body SAR, Top Edge, Mid.ch,
20 MHz Bandwidth, QPSK, 1 RB, 0 RB Offset, Ant 3**

Area Scan (10x9x1): Measurement grid: dx=5mm, dy=15mm

Zoom Scan (5x5x7)/Cube 0: Measurement grid: dx=8mm, dy=8mm, dz=5mm

Reference Value = 28.30 V/m; Power Drift = 0.00 dB

Peak SAR (extrapolated) = 1.85 W/kg

SAR(1 g) = 1.05 W/kg

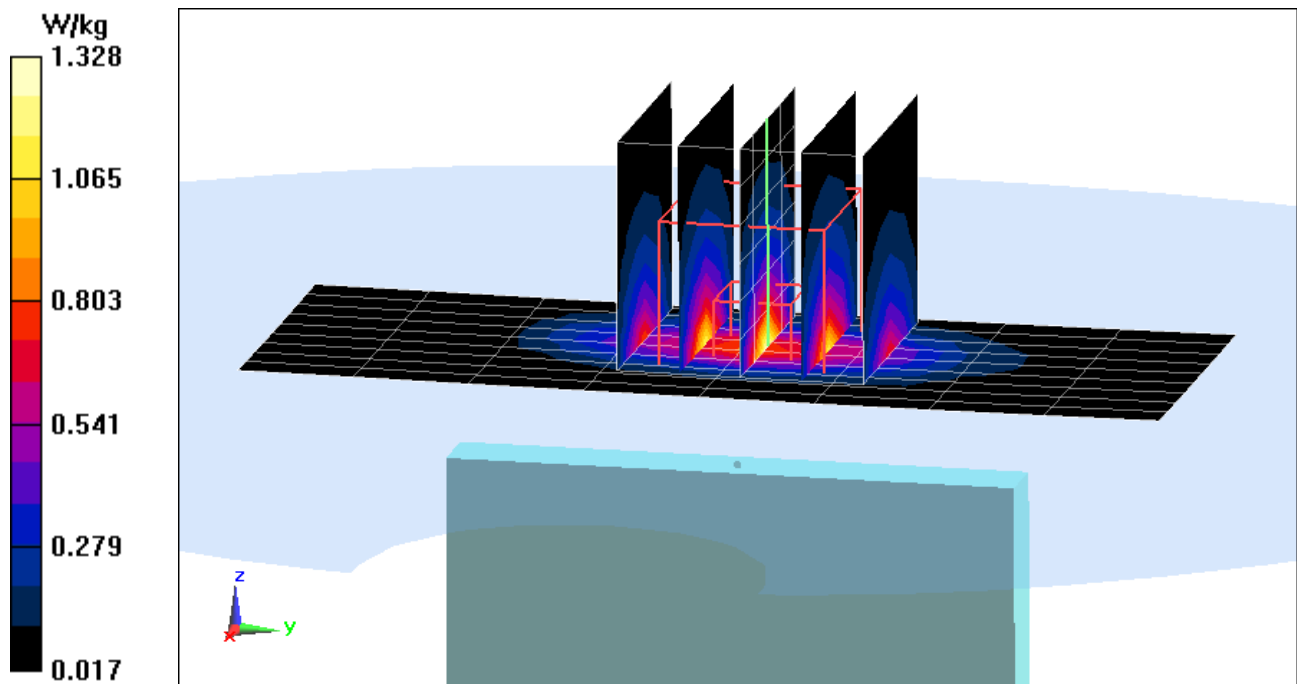

PCTEST ENGINEERING LABORATORY, INC.

DUT: ZNFH820; Type: Portable Handset; Serial: 08038

Communication System: UID 0, LTE Band 30; Frequency: 2310 MHz; Duty Cycle: 1:1

Medium: 2300 Body Medium parameters used:

$f = 2310 \text{ MHz}$; $\sigma = 1.834 \text{ S/m}$; $\epsilon_r = 52.655$; $\rho = 1000 \text{ kg/m}^3$

Phantom section: Flat Section; Space: 1.0 cm

Test Date: 02-11-2016; Ambient Temp: 23.1°C; Tissue Temp: 22.2°C

Probe: ES3DV3 - SN3263; ConvF(4.42, 4.42, 4.42); Calibrated: 5/20/2015;

Sensor-Surface: 3mm (Mechanical Surface Detection)

Electronics: DAE4 Sn859; Calibrated: 6/17/2015

Phantom: SAM with CRP v5.0 (Right); Type: QD000P40CD; Serial: TP:1759

Measurement SW: DASY52, Version 52.8 (8);SEMCAD X Version 14.6.10 (7331)

**Mode: LTE Band 30, Body SAR, Back Side, Mid.ch,
10 MHz Bandwidth, QPSK, 1 RB, 0 RB Offset**

Area Scan (11x18x1): Measurement grid: dx=12mm, dy=12mm

Zoom Scan (7x7x7)/Cube 0: Measurement grid: dx=5mm, dy=5mm, dz=5mm

Reference Value = 14.60 V/m; Power Drift = -0.03 dB

Peak SAR (extrapolated) = 0.691 W/kg

SAR(1 g) = 0.324 W/kg

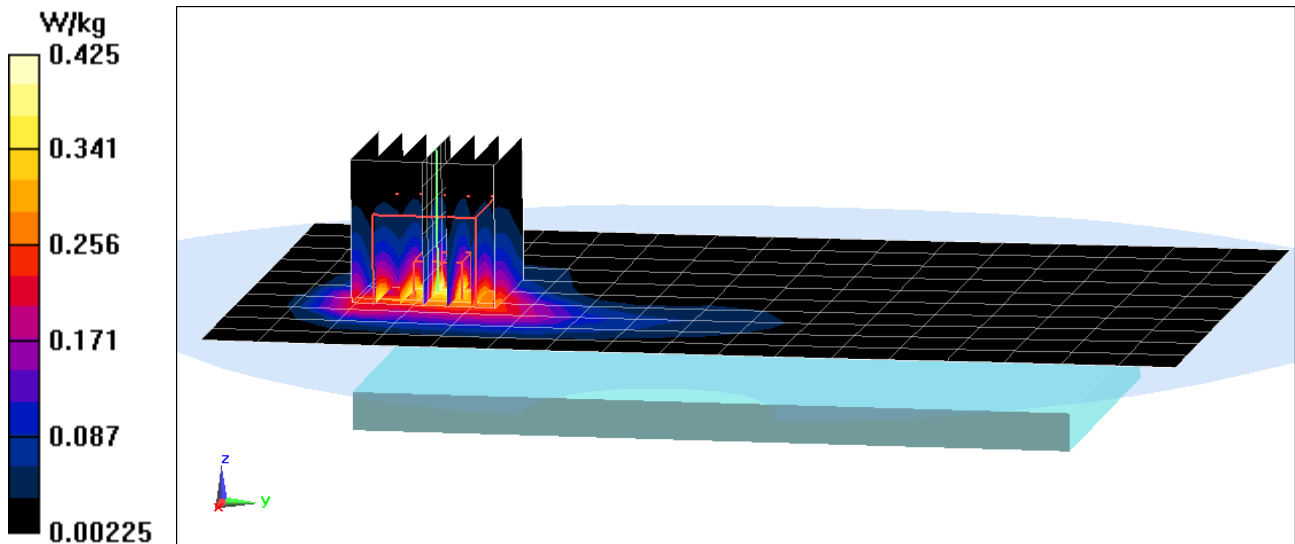

PCTEST ENGINEERING LABORATORY, INC.

DUT: ZNFH820; Type: Portable Handset; Serial: 08038

Communication System: UID 0, LTE Band 30; Frequency: 2310 MHz; Duty Cycle: 1:1

Medium: 2300 Body Medium parameters used:

$f = 2310$ MHz; $\sigma = 1.822$ S/m; $\epsilon_r = 51.601$; $\rho = 1000$ kg/m³

Phantom section: Flat Section; Space: 1.0 cm

Test Date: 02-22-2016; Ambient Temp: 23.1°C; Tissue Temp: 22.6°C

Probe: ES3DV3 - SN3334; ConvF(4.61, 4.61, 4.61); Calibrated: 11/17/2015;

Sensor-Surface: 3mm (Mechanical Surface Detection)

Electronics: DAE4 Sn1415; Calibrated: 11/11/2015

Phantom: SAM Front; Type: SAM; Serial: 1686

Measurement SW: DASY52, Version 52.8 (8); SEMCAD X Version 14.6.10 (7331)

**Mode: LTE Band 30, Body SAR, Bottom Edge, Mid.ch,
10 MHz Bandwidth, QPSK, 1 RB, 0 RB Offset, Camera Module Accessory**

Area Scan (11x10x1): Measurement grid: dx=5mm, dy=12mm

Zoom Scan (7x7x7)/Cube 0: Measurement grid: dx=5mm, dy=5mm, dz=5mm

Reference Value = 16.90 V/m; Power Drift = 0.08 dB

Peak SAR (extrapolated) = 0.853 W/kg

SAR(1 g) = 0.455 W/kg

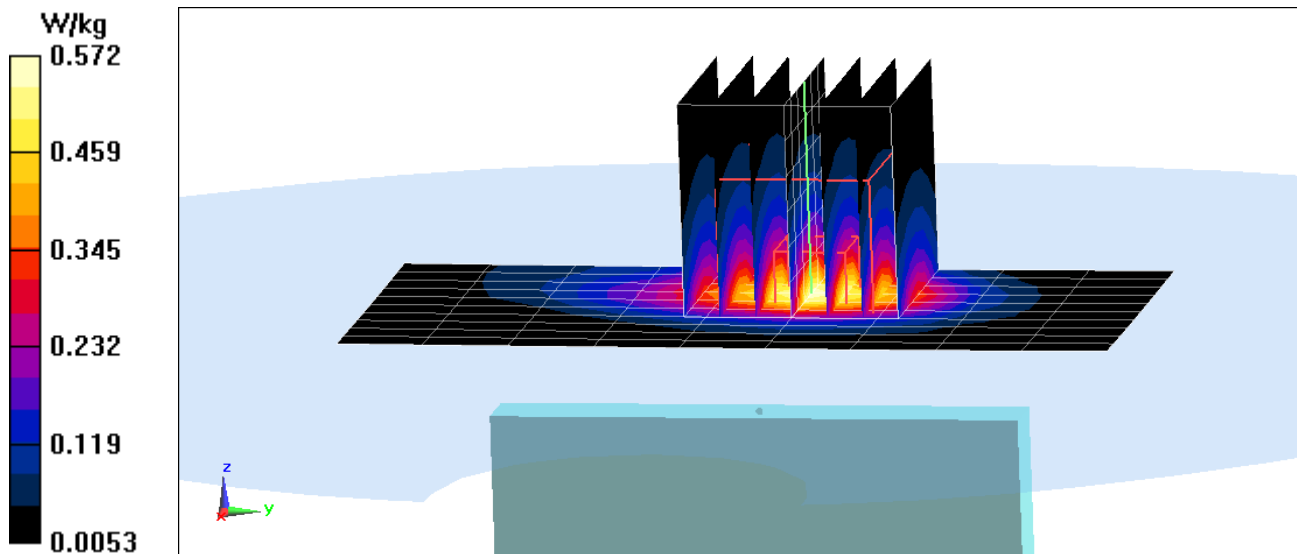

PCTEST ENGINEERING LABORATORY, INC.

DUT: ZNFH820; Type: Portable Handset; Serial: 08137

Communication System: UID 0, LTE Band 7; Frequency: 2510 MHz; Duty Cycle: 1:1
Medium: 2450 Body Medium parameters used (interpolated):
 $f = 2510 \text{ MHz}$; $\sigma = 2.031 \text{ S/m}$; $\epsilon_r = 50.559$; $\rho = 1000 \text{ kg/m}^3$
Phantom section: Flat Section ; Space: 1.0 cm

Test Date: 02-16-2016; Ambient Temp: 24.1°C; Tissue Temp: 23.4°C

Probe: ES3DV3 - SN3334; ConvF(4.45, 4.45, 4.45); Calibrated: 11/17/2015;
Sensor-Surface: 3mm (Mechanical Surface Detection)
Electronics: DAE4 Sn1415; Calibrated: 11/11/2015
Phantom: SAM Front; Type: SAM; Serial: 1686
Measurement SW: DASYS2, Version 52.8 (8); SEMCAD X Version 14.6.10 (7331)

**Mode: LTE Band 7, Body SAR, Back Side, Low.ch,
20 MHz Bandwidth, QPSK, 1 RB, 99 RB Offset, Camera Module Accessory**

Area Scan (11x17x1): Measurement grid: dx=12mm, dy=12mm
Zoom Scan (8x9x7)/Cube 0: Measurement grid: dx=5mm, dy=5mm, dz=5mm
Reference Value = 18.12 V/m; Power Drift = -0.09 dB
Peak SAR (extrapolated) = 1.20 W/kg
SAR(1 g) = 0.571 W/kg

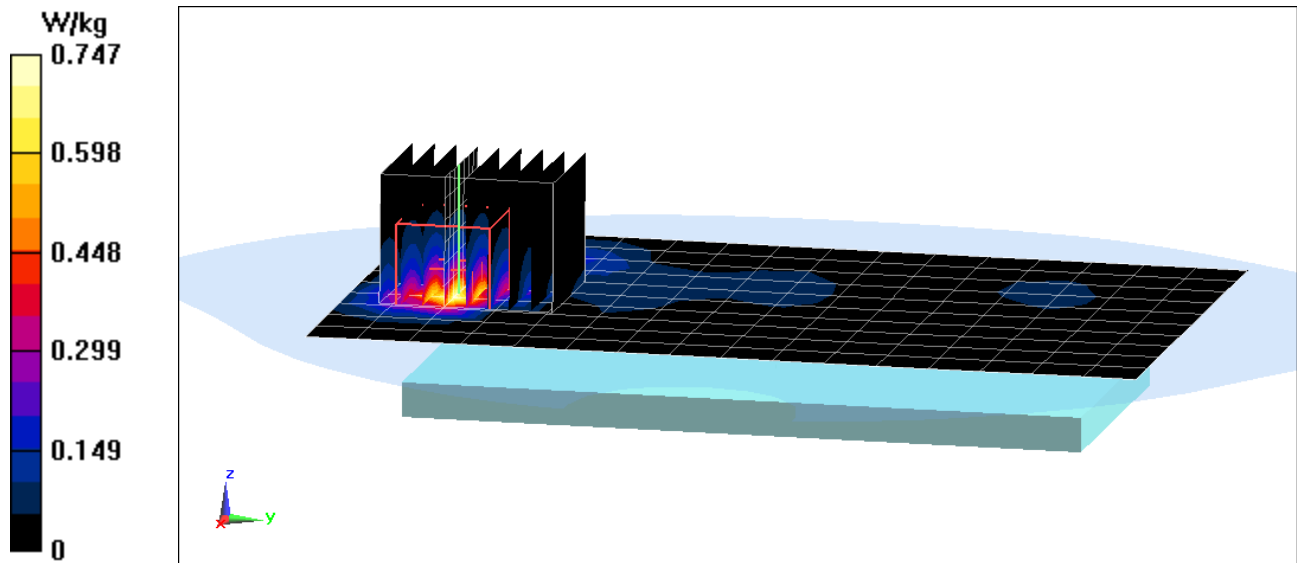

PCTEST ENGINEERING LABORATORY, INC.

DUT: ZNFH820; Type: Portable Handset; Serial: 08202

Communication System: UID 0, IEEE 802.11b; Frequency: 2437 MHz; Duty Cycle: 1:1
Medium: 2450 Body Medium parameters used (interpolated):
 $f = 2437 \text{ MHz}$; $\sigma = 1.966 \text{ S/m}$; $\epsilon_r = 51.871$; $\rho = 1000 \text{ kg/m}^3$
Phantom section: Flat Section; Space: 1.0 cm

Test Date: 02-03-2016; Ambient Temp: 22.5°C; Tissue Temp: 23.0°C

Probe: ES3DV3 - SN3319; ConvF(4.11, 4.11, 4.11); Calibrated: 3/19/2015;
Sensor-Surface: 3mm (Mechanical Surface Detection)
Electronics: DAE4 Sn1368; Calibrated: 3/13/2015
Phantom: SAM with CRP v4.0; Type: QD000P40CD; Serial: TP:1800
Measurement SW: DASY52, Version 52.8 (8);SEMCAD X Version 14.6.10 (7331)

Mode: IEEE 802.11b, 22 MHz Bandwidth, Body SAR, Ch 6, 1 Mbps, Back Side

Area Scan (11x17x1): Measurement grid: dx=12mm, dy=12mm

Zoom Scan (7x7x7)/Cube 0: Measurement grid: dx=5mm, dy=5mm, dz=5mm

Reference Value = 7.695 V/m; Power Drift = 0.06 dB

Peak SAR (extrapolated) = 0.202 W/kg

SAR(1 g) = 0.108 W/kg

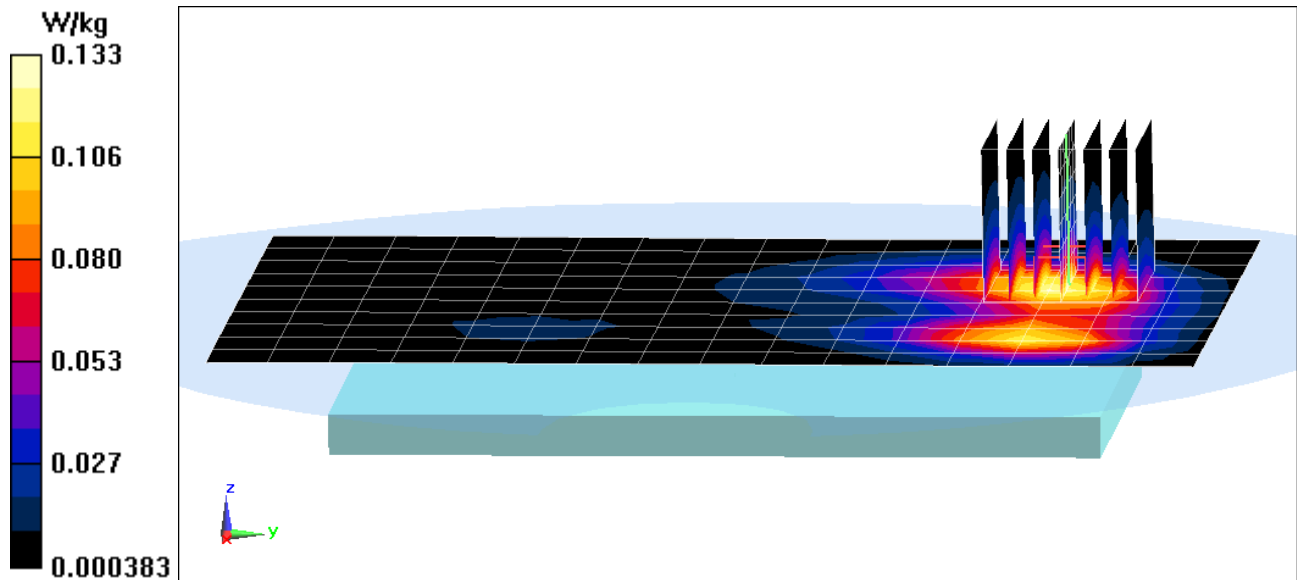

PCTEST ENGINEERING LABORATORY, INC.

DUT: ZNFH820; Type: Portable Handset; Serial: 08202

Communication System: UID 0, IEEE 802.11b; Frequency: 2437 MHz; Duty Cycle: 1:1
Medium: 2450 Body Medium parameters used (interpolated):
 $f = 2437 \text{ MHz}$; $\sigma = 1.966 \text{ S/m}$; $\epsilon_r = 51.871$; $\rho = 1000 \text{ kg/m}^3$
Phantom section: Flat Section; Space: 1.0 cm

Test Date: 02-03-2016; Ambient Temp: 22.5°C; Tissue Temp: 23.0°C

Probe: ES3DV3 - SN3319; ConvF(4.11, 4.11, 4.11); Calibrated: 3/19/2015;
Sensor-Surface: 3mm (Mechanical Surface Detection)
Electronics: DAE4 Sn1368; Calibrated: 3/13/2015
Phantom: SAM with CRP v4.0; Type: QD000P40CD; Serial: TP:1800
Measurement SW: DASY52, Version 52.8 (8);SEMCAD X Version 14.6.10 (7331)

Mode: IEEE 802.11b, 22 MHz Bandwidth, Body SAR, Ch 6, 1 Mbps, Front Side

Area Scan (11x17x1): Measurement grid: dx=12mm, dy=12mm
Zoom Scan (7x7x7)/Cube 0: Measurement grid: dx=5mm, dy=5mm, dz=5mm
Reference Value = 7.742 V/m; Power Drift = 0.06 dB
Peak SAR (extrapolated) = 0.215 W/kg
SAR(1 g) = 0.111 W/kg

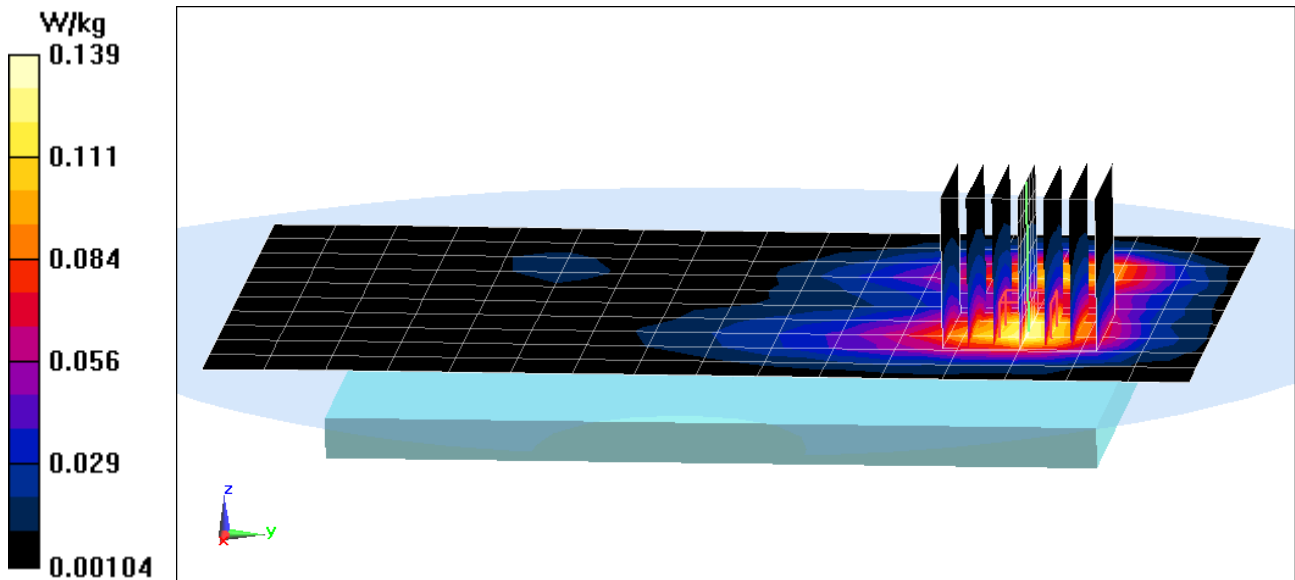

PCTEST ENGINEERING LABORATORY, INC.

DUT: ZNFH820; Type: Portable Handset; Serial: 08210

Communication System: UID 0, IEEE 802.11a; Frequency: 5500 MHz; Duty Cycle: 1:1

Medium: 5 GHz Body Medium parameters used:

$f = 5500 \text{ MHz}$; $\sigma = 5.833 \text{ S/m}$; $\epsilon_r = 47.678$; $\rho = 1000 \text{ kg/m}^3$

Phantom section: Flat Section; Space: 1.0 cm

Test Date: 02-08-2016; Ambient Temp: 23.6°C; Tissue Temp: 22.3°C

Probe: EX3DV4 - SN7308; ConvF(3.92, 3.92, 3.92); Calibrated: 7/21/2015;

Sensor-Surface: 1.4mm (Mechanical Surface Detection)

Electronics: DAE4 Sn1322; Calibrated: 8/24/2015

Phantom: SAM 5.0 front; Type: QD000P40CD; Serial: TP:-1648

Measurement SW: DASY52, Version 52.8 (8);SEMCAD X Version 14.6.10 (7331)

Mode: IEEE 802.11a, U-NII-2C, 20 MHz Bandwidth, Body SAR, Ch 100, 6 Mbps, Back Side

Area Scan (13x22x1): Measurement grid: dx=10mm, dy=10mm

Zoom Scan (7x7x7)/Cube 0: Measurement grid: dx=4mm, dy=4mm, dz=1.4mm; Graded Ratio: 1.4

Reference Value = 2.798 V/m; Power Drift = 0.18 dB

Peak SAR (extrapolated) = 0.180 W/kg

SAR(1 g) = 0.050 W/kg

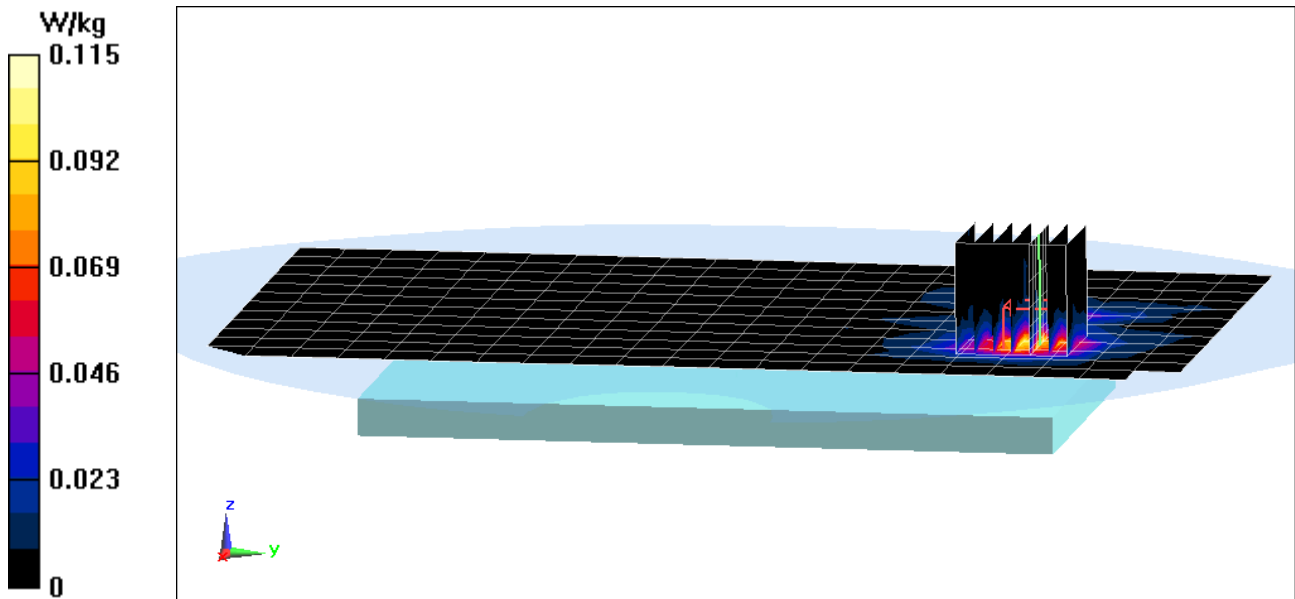

PCTEST ENGINEERING LABORATORY, INC.

DUT: ZNFH820; Type: Portable Handset; Serial: 08210

Communication System: UID 0, IEEE 802.11a; Frequency: 5745 MHz; Duty Cycle: 1:1

Medium: 5 GHz Body Medium parameters used:

$f = 5745 \text{ MHz}$; $\sigma = 6.193 \text{ S/m}$; $\epsilon_r = 47.219$; $\rho = 1000 \text{ kg/m}^3$

Phantom section: Flat Section; Space: 1.0 cm

Test Date: 02-08-2016; Ambient Temp: 23.6°C; Tissue Temp: 22.3°C

Probe: EX3DV4 - SN7308; ConvF(4.24, 4.24, 4.24); Calibrated: 7/21/2015;

Sensor-Surface: 1.4mm (Mechanical Surface Detection)

Electronics: DAE4 Sn1322; Calibrated: 8/24/2015

Phantom: SAM 5.0 front; Type: QD000P40CD; Serial: TP:-1648

Measurement SW: DASY52, Version 52.8 (8);SEMCAD X Version 14.6.10 (7331)

Mode: IEEE 802.11a, U-NII-3, 20 MHz Bandwidth, Body SAR, Ch 149, 6 Mbps, Front Side

Area Scan (13x22x1): Measurement grid: dx=10mm, dy=10mm

Zoom Scan (7x7x7)/Cube 0: Measurement grid: dx=4mm, dy=4mm, dz=1.4mm; Graded Ratio: 1.4

Reference Value = 3.509 V/m; Power Drift = -0.12 dB

Peak SAR (extrapolated) = 0.292 W/kg

SAR(1 g) = 0.070 W/kg

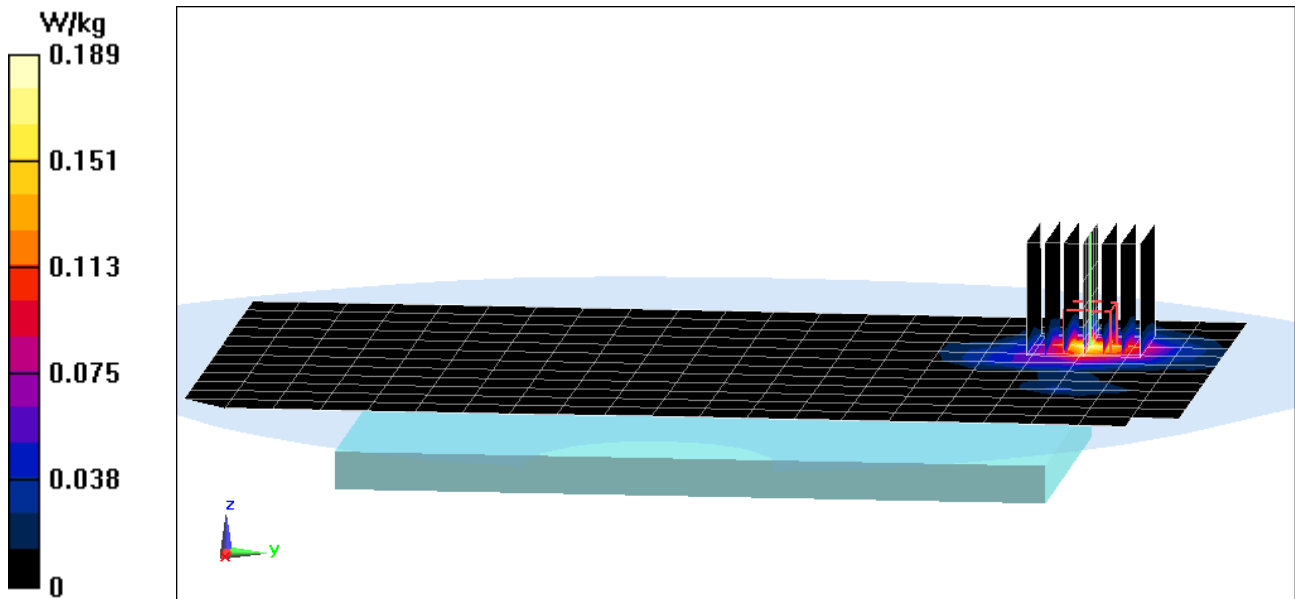

PCTEST ENGINEERING LABORATORY, INC.

DUT: ZNFH820; Type: Portable Handset; Serial: 08202

Communication System: UID 0, Bluetooth; Frequency: 2441 MHz; Duty Cycle: 1:1
Medium: 2450 Body Medium parameters used (interpolated):
 $f = 2441 \text{ MHz}$; $\sigma = 1.972 \text{ S/m}$; $\epsilon_r = 51.861$; $\rho = 1000 \text{ kg/m}^3$
Phantom section: Flat Section; Space: 1.0 cm

Test Date: 02-03-2016; Ambient Temp: 22.5°C; Tissue Temp: 23.0°C

Probe: ES3DV3 - SN3319; ConvF(4.11, 4.11, 4.11); Calibrated: 3/19/2015;
Sensor-Surface: 3mm (Mechanical Surface Detection)
Electronics: DAE4 Sn1368; Calibrated: 3/13/2015
Phantom: SAM with CRP v4.0; Type: QD000P40CD; Serial: TP:1800
Measurement SW: DASY52, Version 52.8 (8);SEMCAD X Version 14.6.10 (7331)

Mode: Bluetooth, Body SAR, Ch 39, 1 Mbps, Back Side

Area Scan (11x17x1): Measurement grid: dx=12mm, dy=12mm
Zoom Scan (7x7x7)/Cube 0: Measurement grid: dx=5mm, dy=5mm, dz=5mm
Reference Value = 1.426 V/m; Power Drift = -0.01 dB
Peak SAR (extrapolated) = 0.0120 W/kg
SAR(1 g) = 0.005 W/kg

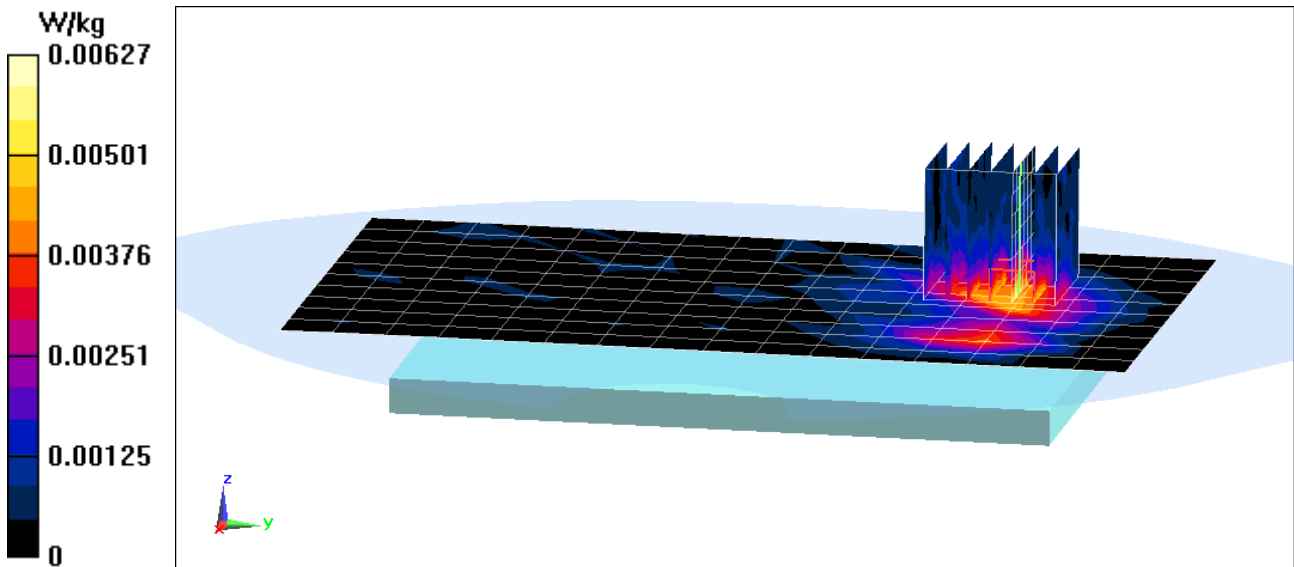

PCTEST ENGINEERING LABORATORY, INC.

DUT: ZNFH820; Type: Portable Handset; Serial: 08103

Communication System: UID 0, GSM GPRS; 3 Tx slots; Frequency: 836.6 MHz; Duty Cycle: 1:2.76
Medium: 835 Body, Medium parameters used (interpolated):
 $f = 836.6 \text{ MHz}$; $\sigma = 0.998 \text{ S/m}$; $\epsilon_r = 53.946$; $\rho = 1000 \text{ kg/m}^3$
Phantom section: Flat Section; Space: 0.0 cm

Test Date: 02-27-2016; Ambient Temp: 20.3°C; Tissue Temp: 19.2°C

Probe: ES3DV3 - SN3319; ConvF(6.07, 6.07, 6.07); Calibrated: 3/19/2015;
Sensor-Surface: 3mm (Mechanical Surface Detection)
Electronics: DAE4 Sn1368; Calibrated: 3/13/2015

Phantom: SAM with CRP v4.0; Type: QD000P40CD; Serial: TP:1800
Measurement SW: DASY52, Version 52.8 (8); SEMCAD X Version 14.6.10 (7331)

**Mode: GPRS 850, 10g Hotspot Mode at 0mm SAR, Back Side, Mid.ch, 3 Tx Slots,
Camera Module Accessory**

Area Scan (9x15x1): Measurement grid: dx=15mm, dy=15mm

Zoom Scan (5x5x7)/Cube 0: Measurement grid: dx=8mm, dy=8mm, dz=5mm

Reference Value = 27.12 V/m; Power Drift = -0.06 dB

Peak SAR (extrapolated) = 2.26 W/kg

SAR(10 g) = 0.413 W/kg

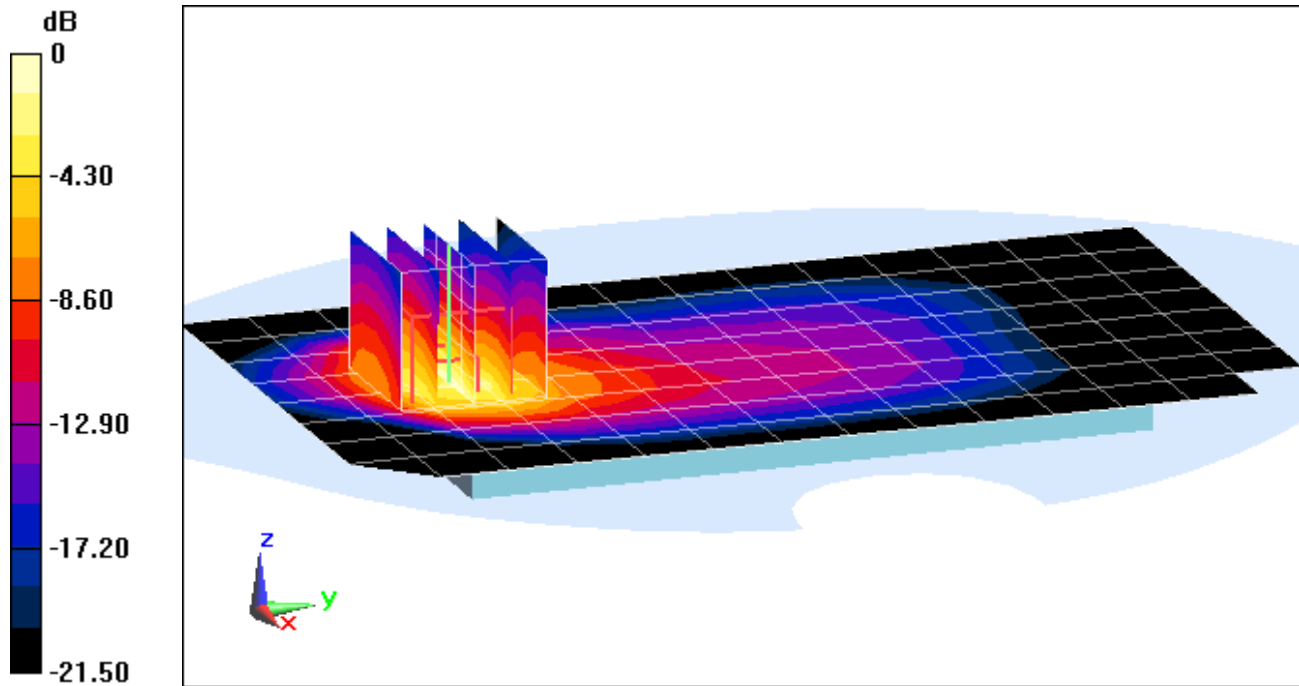

0 dB = 1.29 W/kg = 1.11 dBW/kg

PCTEST ENGINEERING LABORATORY, INC.

DUT: ZNFH820; Type: Portable Handset; Serial: 08103

Communication System: UID 0, UMTS; Frequency: 836.6 MHz; Duty Cycle: 1:1
Medium: 835 Body, Medium parameters used (interpolated):
 $f = 836.6 \text{ MHz}$; $\sigma = 0.998 \text{ S/m}$; $\epsilon_r = 53.946$; $\rho = 1000 \text{ kg/m}^3$
Phantom section: Flat Section; Space: 0.0 cm

Test Date: 02-27-2016; Ambient Temp: 20.3°C; Tissue Temp: 19.2°C

Probe: ES3DV3 - SN3319; ConvF(6.07, 6.07, 6.07); Calibrated: 3/19/2015;
Sensor-Surface: 3mm (Mechanical Surface Detection)
Electronics: DAE4 Sn1368; Calibrated: 3/13/2015
Phantom: SAM with CRP v4.0; Type: QD000P40CD; Serial: TP:1800
Measurement SW: DASY52, Version 52.8 (8); SEMCAD X Version 14.6.10 (7331)

**Mode: UMTS 850, 10g Hotspot Mode at 0mm SAR, Back Side, Mid.ch,
Camera Module Accessory**

Area Scan (9x15x1): Measurement grid: dx=15mm, dy=15mm
Zoom Scan (5x5x7)/Cube 0: Measurement grid: dx=8mm, dy=8mm, dz=5mm
Reference Value = 29.20 V/m; Power Drift = -0.04 dB
Peak SAR (extrapolated) = 2.28 W/kg
SAR(10 g) = 0.438 W/kg

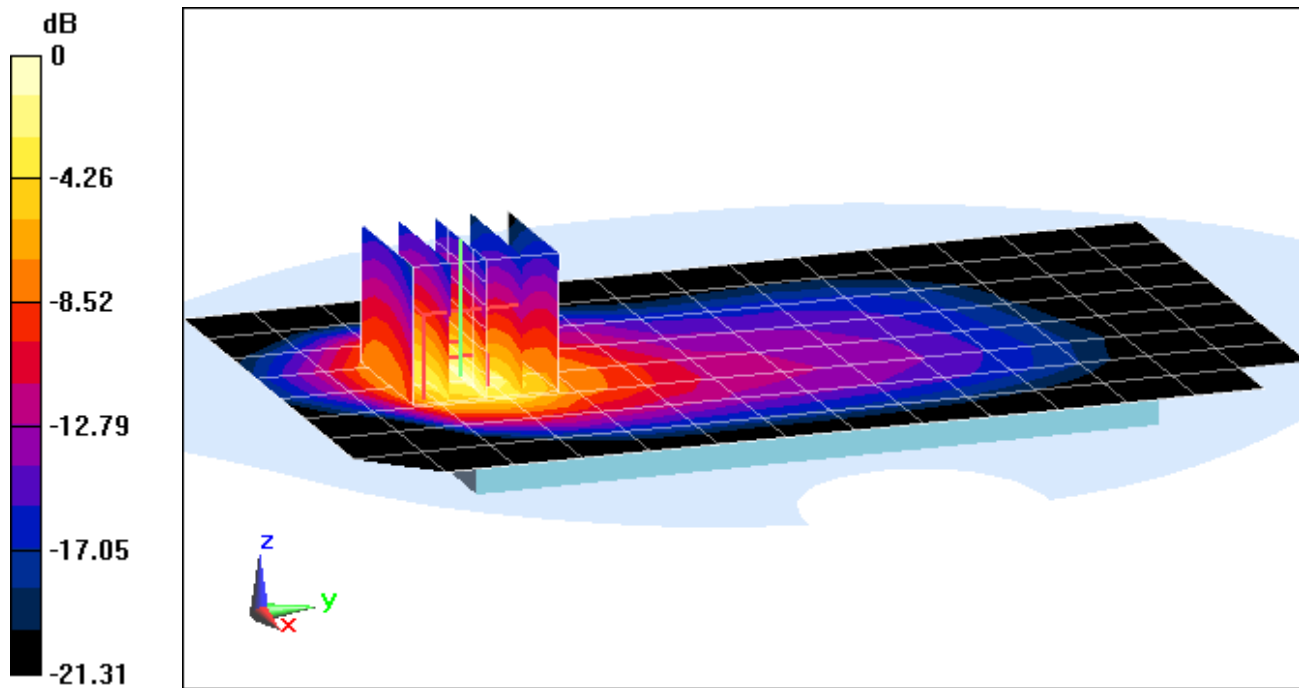

0 dB = 1.37 W/kg = 1.37 dBW/kg

PCTEST ENGINEERING LABORATORY, INC.

DUT: ZNFH820; Type: Portable Handset; Serial: 08103

Communication System: UID 0, UMTS (0); Frequency: 1732.4 MHz; Duty Cycle: 1:1
Medium: 1750 Body Medium parameters used (interpolated):
 $f = 1732.4 \text{ MHz}$; $\sigma = 1.454 \text{ S/m}$; $\epsilon_r = 52.339$; $\rho = 1000 \text{ kg/m}^3$
Phantom section: Flat Section; Space: 0.0 cm

Test Date: 03-03-2016; Ambient Temp: 24.3°C; Tissue Temp: 22.2°C

Probe: ES3DV3 - SN3351; ConvF(4.88, 4.88, 4.88); Calibrated: 6/22/2015;
Sensor-Surface: 3mm (Mechanical Surface Detection)
Electronics: DAE4 Sn1322; Calibrated: 8/24/2015
Phantom: SAM 5.0 front; Type: QD000P40CD; Serial: TP:-1648
Measurement SW: DASY52, Version 52.8 (8); SEMCAD X Version 14.6.10 (7331)

**Mode: UMTS 1750, 10g Hotspot Mode at 0mm SAR, Back side, Mid.ch, Ant
2, Camera Module Accessory**

Area Scan (9x15x1): Measurement grid: $dx=15\text{mm}$, $dy=15\text{mm}$
Zoom Scan (5x5x7)/Cube 0: Measurement grid: $dx=8\text{mm}$, $dy=8\text{mm}$, $dz=5\text{mm}$
Reference Value = 44.60 V/m; Power Drift = 0.14 dB
Peak SAR (extrapolated) = 8.93 W/kg
SAR(10 g) = 1.83 W/kg

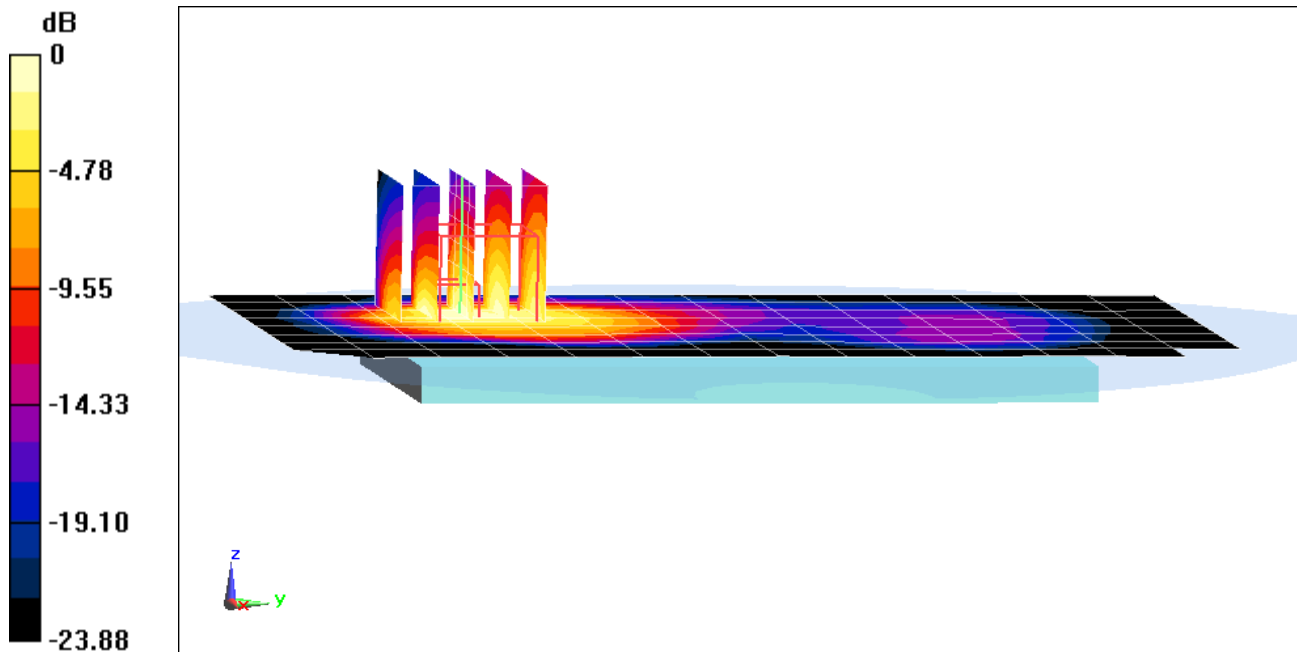

0 dB = 4.06 W/kg = 6.09 dBW/kg

PCTEST ENGINEERING LABORATORY, INC.

DUT: ZNFH820; Type: Portable Handset; Serial: 08103

Communication System: UID 0, GSM GPRS; 4 Tx slots (0); Frequency: 1880 MHz; Duty Cycle: 1:2.076

Medium: 1900 Body Medium parameters used:

$f = 1880 \text{ MHz}$; $\sigma = 1.54 \text{ S/m}$; $\epsilon_r = 53.005$; $\rho = 1000 \text{ kg/m}^3$

Phantom section: Flat Section; Space: 0.0 cm

Test Date: 03-03-2016; Ambient Temp: 22.2°C; Tissue Temp: 21.4°C

Probe: ES3DV3 - SN3334; ConvF(4.84, 4.84, 4.84); Calibrated: 11/17/2015;

Sensor-Surface: 3mm (Mechanical Surface Detection)

Electronics: DAE4 Sn1415; Calibrated: 11/11/2015

Phantom: SAM Front; Type: SAM; Serial: 1686

Measurement SW: DASY52, Version 52.8 (8); SEMCAD X Version 14.6.10 (7331)

**Mode: GPRS 1900, 10g Hotspot Mode at 0mm SAR, Back side, Mid.ch, 4 Tx Slots,
Ant 2, Camera Module Accessory**

Area Scan (9x15x1): Measurement grid: dx=15mm, dy=15mm

Zoom Scan (5x6x7)/Cube 0: Measurement grid: dx=8mm, dy=8mm, dz=5mm

Reference Value = 20.12 V/m; Power Drift = 0.06 dB

Peak SAR (extrapolated) = 1.19 W/kg

SAR(10 g) = 0.294 W/kg

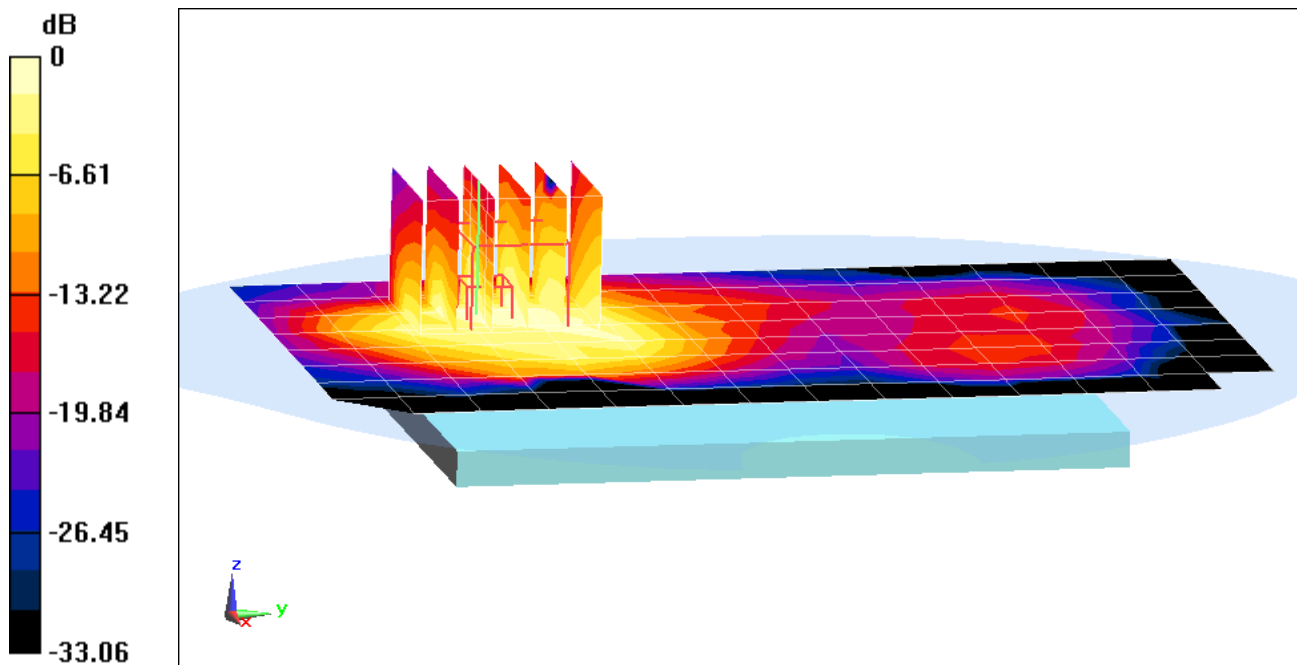

PCTEST ENGINEERING LABORATORY, INC.

DUT: ZNFH820 C2PC ; Type: Portable Handset; Serial: 08103

Communication System: UID 0, UMTS; Frequency: 1880 MHz; Duty Cycle: 1:1
Medium: 1900 Body Medium parameters used:
 $f = 1880 \text{ MHz}$; $\sigma = 1.54 \text{ S/m}$; $\epsilon_r = 53.005$; $\rho = 1000 \text{ kg/m}^3$
Phantom section: Flat Section; Space: 0.0 cm

Test Date: 03-03-2016; Ambient Temp: 22.2°C; Tissue Temp: 21.4°C

Probe: ES3DV3 - SN3334; ConvF(4.84, 4.84, 4.84); Calibrated: 11/17/2015;
Sensor-Surface: 3mm (Mechanical Surface Detection)
Electronics: DAE4 Sn1415; Calibrated: 11/11/2015
Phantom: SAM Front; Type: SAM; Serial: 1686
Measurement SW: DASY52, Version 52.8 (8); SEMCAD X Version 14.6.10 (7331)

**Mode: UMTS 1900, 10g Hotspot Mode at 0mm SAR, Back side, Mid.ch,
Ant 2, Camera Module Accessory**

Area Scan (9x15x1): Measurement grid: $dx=15\text{mm}$, $dy=15\text{mm}$
Zoom Scan (5x6x7)/Cube 0: Measurement grid: $dx=8\text{mm}$, $dy=8\text{mm}$, $dz=5\text{mm}$
Reference Value = 35.44 V/m; Power Drift = 0.01 dB
Peak SAR (extrapolated) = 3.57 W/kg
SAR(10 g) = 0.869 W/kg

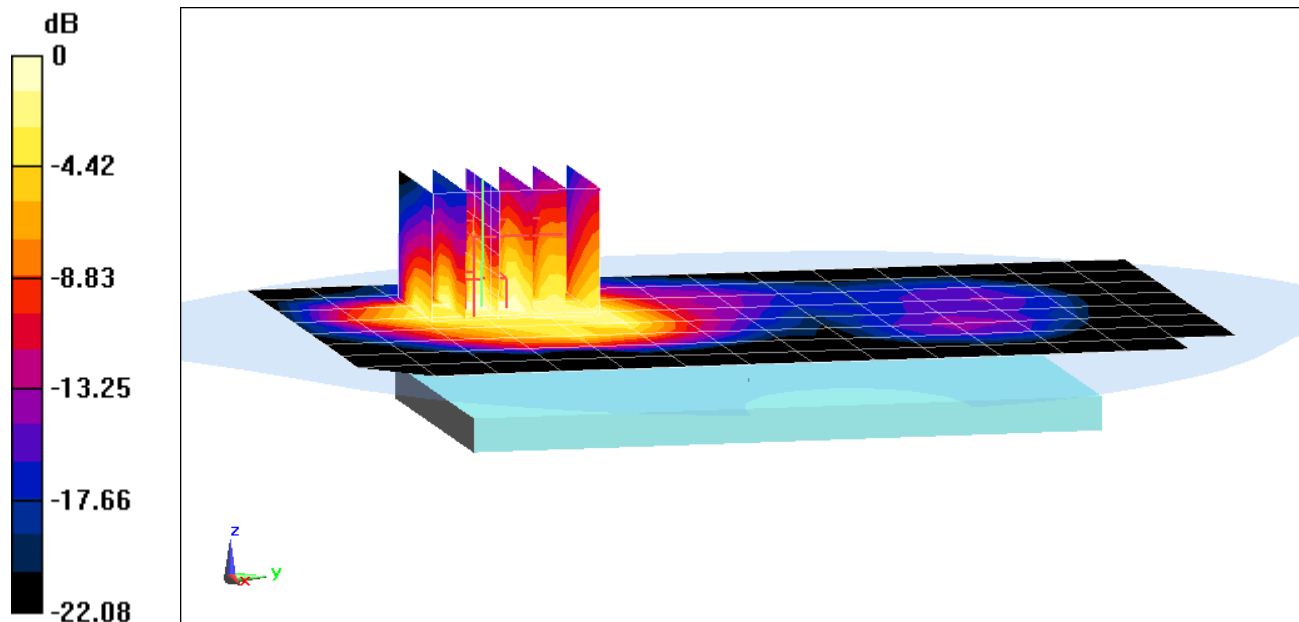

0 dB = 2.02 W/kg = 3.05 dBW/kg

PCTEST ENGINEERING LABORATORY, INC.

DUT: ZNFH820; Type: Portable Handset; Serial: 08038

Communication System: UID 0, LTE Band 12; Frequency: 707.5 MHz; Duty Cycle: 1:1
Medium: 750 Body, Medium parameters used (interpolated):
 $f = 707.5 \text{ MHz}$; $\sigma = 0.917 \text{ S/m}$; $\epsilon_r = 55.535$; $\rho = 1000 \text{ kg/m}^3$
Phantom section: Flat Section; Space: 0.0 cm

Test Date: 02-27-2016; Ambient Temp: 19.8°C; Tissue Temp: 20.8°C

Probe: ES3DV3 - SN3333; ConvF(6.31, 6.31, 6.31); Calibrated: 10/29/2015;
Sensor-Surface: 3mm (Mechanical Surface Detection)
Electronics: DAE4 Sn1333; Calibrated: 10/27/2015
Phantom: SAM Front; Type: QD000P40CD; Serial: TP:1758
Measurement SW: DASY52, Version 52.8 (8); SEMCAD X Version 14.6.10 (7331)

**Mode: LTE Band 12, 10g Hotspot Mode at 0mm SAR, Back Side, Mid.ch, 10 MHz
Bandwidth, QPSK, 1 RB, 0 RB Offset, Camera Module Accessory**

Area Scan (9x13x1): Measurement grid: dx=15mm, dy=15mm
Zoom Scan (5x6x7)/Cube 0: Measurement grid: dx=8mm, dy=8mm, dz=5mm
Reference Value = 29.83 V/m; Power Drift = 0.01 dB
Peak SAR (extrapolated) = 1.63 W/kg
SAR(10 g) = 0.423 W/kg

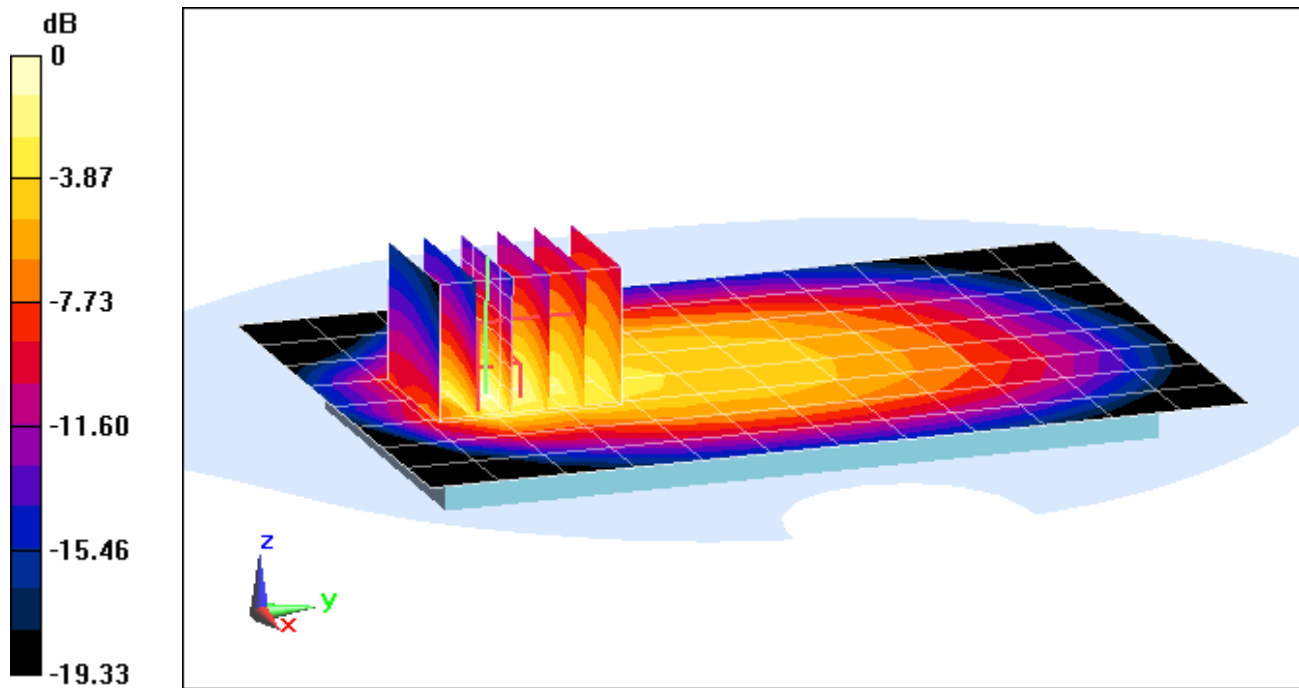

PCTEST ENGINEERING LABORATORY, INC.

DUT: ZNFH820; Type: Portable Handset; Serial: 08137

Communication System: UID 0, LTE Band 5; Frequency: 836.5 MHz; Duty Cycle: 1:1
Medium: 835 Body, Medium parameters used (interpolated):
 $f = 836.5 \text{ MHz}$; $\sigma = 0.998 \text{ S/m}$; $\epsilon_r = 53.947$; $\rho = 1000 \text{ kg/m}^3$
Phantom section: Flat Section; Space: 0.0 cm

Test Date: 02-27-2016; Ambient Temp: 20.3°C; Tissue Temp: 19.2°C

Probe: ES3DV3 - SN3319; ConvF(6.07, 6.07, 6.07); Calibrated: 3/19/2015;
Sensor-Surface: 3mm (Mechanical Surface Detection)
Electronics: DAE4 Sn1368; Calibrated: 3/13/2015
Phantom: SAM with CRP v4.0; Type: QD000P40CD; Serial: TP:1800
Measurement SW: DASY52, Version 52.8 (8); SEMCAD X Version 14.6.10 (7331)

Mode: LTE Band 5 (Cell.), 10g Hotspot Mode at 0mm SAR, Back Side, Mid.ch, 10 MHz Bandwidth,QPSK, 1 RB, 25 RB Offset, Camera Module Accessory

Area Scan (9x15x1): Measurement grid: dx=15mm, dy=15mm
Zoom Scan (5x5x7)/Cube 0: Measurement grid: dx=8mm, dy=8mm, dz=5mm
Reference Value = 30.86 V/m; Power Drift = -0.06 dB
Peak SAR (extrapolated) = 2.24 W/kg
SAR(10 g) = 0.430 W/kg

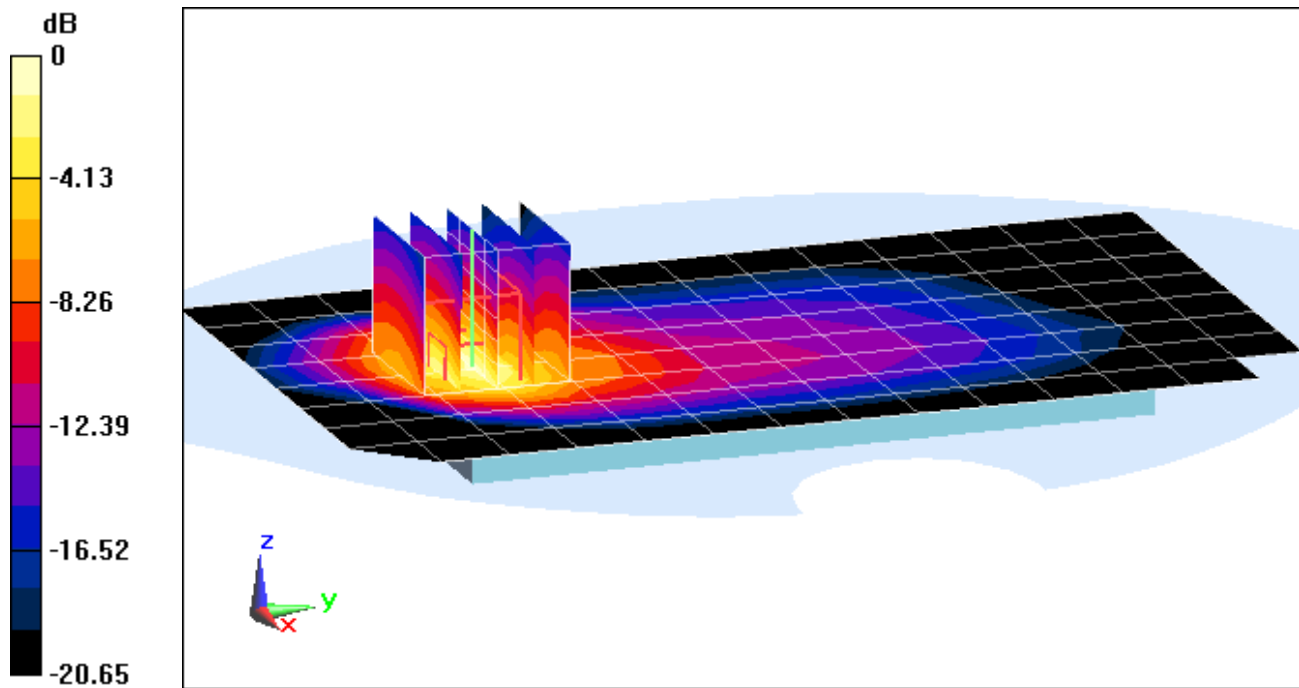

PCTEST ENGINEERING LABORATORY, INC.

DUT: ZNFH820; Type: Portable Handset; Serial: 08137

Communication System: UID 0, LTE Band 4 (AWS); Frequency: 1732.5 MHz; Duty Cycle: 1:1
Medium: 1750 Body, Medium parameters used (interpolated):
 $f = 1732.5 \text{ MHz}$; $\sigma = 1.463 \text{ S/m}$; $\epsilon_r = 52.169$; $\rho = 1000 \text{ kg/m}^3$
Phantom section: Flat Section; Space: 0.0 cm

Test Date: 02-27-2016; Ambient Temp: 20.8°C; Tissue Temp: 20.5°C

Probe: ES3DV2 - SN3022; ConvF(4.79, 4.79, 4.79); Calibrated: 8/26/2015;

Sensor-Surface: 3mm (Mechanical Surface Detection)

Electronics: DAE4 Sn1323; Calibrated: 9/16/2015

Phantom: SAM with CRP v4.0; Type: QD000P40CD; Serial: TP:1797

Measurement SW: DASY52, Version 52.8 (8); SEMCAD X Version 14.6.10 (7331)

Mode: LTE Band 4 (AWS), 10g Hotspot Mode at 0mm SAR, Back Side, Mid.ch, 20 MHz Bandwidth, QPSK, 1 RB, 0 RB Offset, Ant 2, Camera Module Accessory

Area Scan (9x14x1): Measurement grid: dx=15mm, dy=15mm

Zoom Scan (5x5x7)/Cube 0: Measurement grid: dx=8mm, dy=8mm, dz=5mm

Reference Value = 56.44 V/m; Power Drift = 0.05 dB

Peak SAR (extrapolated) = 9.67 W/kg

SAR(10 g) = 2.29 W/kg

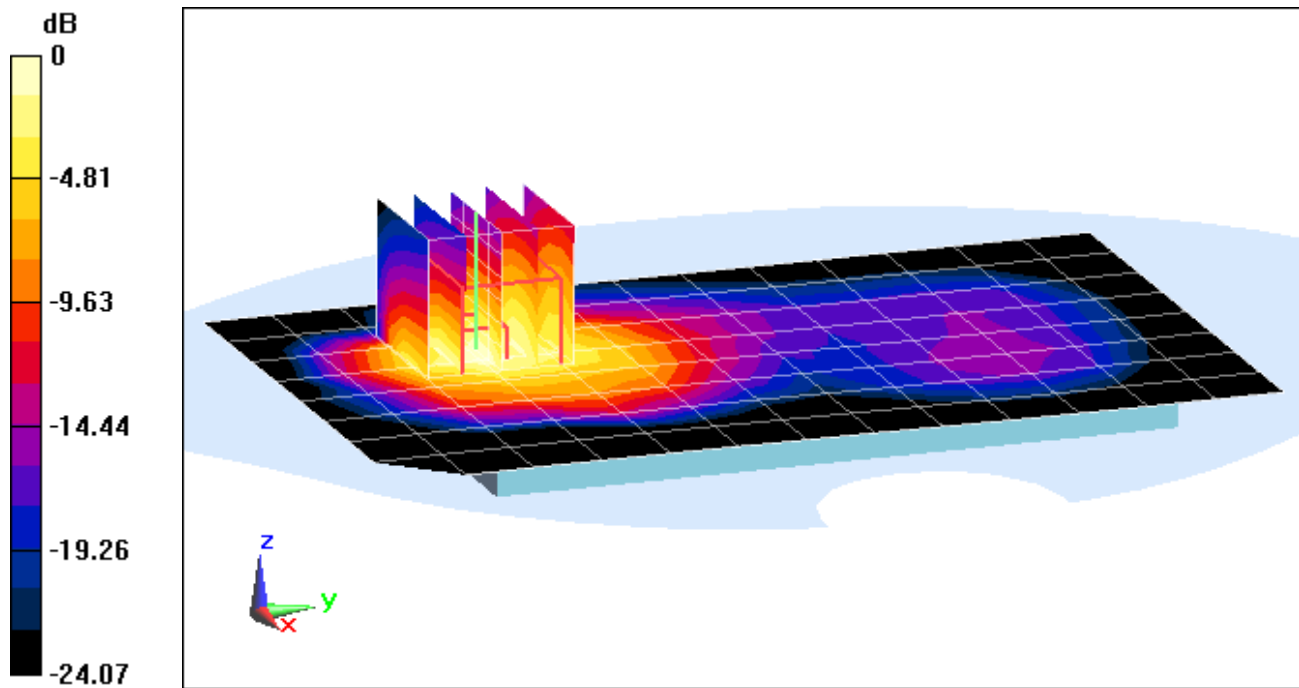

0 dB = 5.31 W/kg = 7.25 dBW/kg

PCTEST ENGINEERING LABORATORY, INC.

DUT: ZNFH820; Type: Portable Handset; Serial: 08137

Communication System: UID 0, LTE Band 2 (PCS); Frequency: 1900 MHz; Duty Cycle: 1:1
Medium: 1900 Body Medium parameters used (interpolated):
 $f = 1900 \text{ MHz}$; $\sigma = 1.563 \text{ S/m}$; $\epsilon_r = 52.918$; $\rho = 1000 \text{ kg/m}^3$
Phantom section: Flat Section; Space: 0.0 cm

Test Date: 03-03-2016; Ambient Temp: 22.2°C; Tissue Temp: 21.4°C

Probe: ES3DV3 - SN3334; ConvF(4.84, 4.84, 4.84); Calibrated: 11/17/2015;
Sensor-Surface: 3mm (Mechanical Surface Detection)
Electronics: DAE4 Sn1415; Calibrated: 11/11/2015
Phantom: SAM Front; Type: SAM; Serial: 1686

Measurement SW: DASY52, Version 52.8 (8); SEMCAD X Version 14.6.10 (7331)

**Mode: LTE Band 2 (PCS), 10g Hotspot Mode at 0mm SAR, Back side, High.ch, 20 MHz
Bandwidth, QPSK, 1 RB, 99 RB Offset, Ant 2, Camera Module Accessory**

Area Scan (9x15x1): Measurement grid: dx=15mm, dy=15mm

Zoom Scan (5x5x7)/Cube 0: Measurement grid: dx=8mm, dy=8mm, dz=5mm

Reference Value = 33.85 V/m; Power Drift = 0.01 dB

Peak SAR (extrapolated) = 3.67 W/kg

SAR(10 g) = 0.828 W/kg

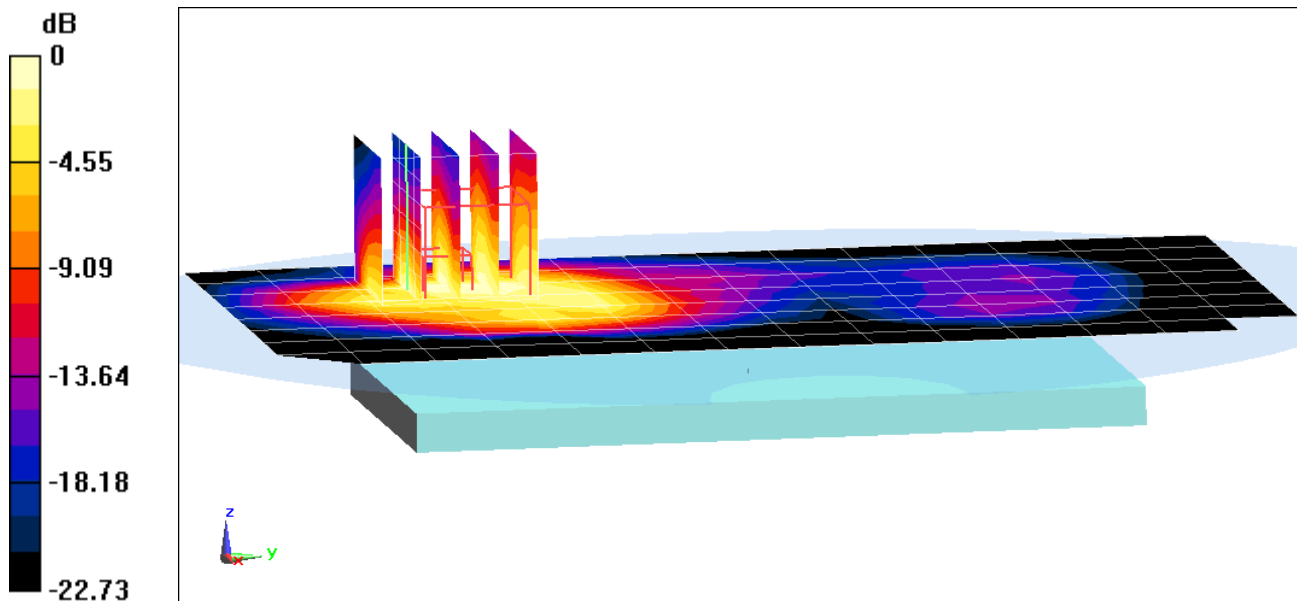

0 dB = 1.90 W/kg = 2.79 dBW/kg

PCTEST ENGINEERING LABORATORY, INC.

DUT: ZNFH820; Type: Portable Handset; Serial: 08038

Communication System: UID 0, LTE Band 30 (0); Frequency: 2310 MHz; Duty Cycle: 1:1

Medium: 2300 Body Medium parameters used:

$f = 2310 \text{ MHz}$; $\sigma = 1.827 \text{ S/m}$; $\epsilon_r = 51.527$; $\rho = 1000 \text{ kg/m}^3$

Phantom section: Flat Section; Space: 0.0 cm

Test Date: 03-03-2016; Ambient Temp: 22.5°C; Tissue Temp: 21.5°C

Probe: ES3DV2 - SN3022; ConvF(4.32, 4.32, 4.32); Calibrated: 8/26/2015;

Sensor-Surface: 3mm (Mechanical Surface Detection)

Electronics: DAE4 Sn1323; Calibrated: 9/16/2015

Phantom: SAM Left; Type: QD000P40CC; Serial: TP: 1375

Measurement SW: DASY52, Version 52.8 (8); SEMCAD X Version 14.6.10 (7331)

Mode: LTE Band 30, 10g Hotspot Mode at 0mm SAR, Back side, Mid.ch, 10 MHz Bandwidth, QPSK, 1 RB, 0 RB Offset, Camera Module Accessory

Area Scan (11x18x1): Measurement grid: dx=12mm, dy=12mm

Zoom Scan (7x7x7)/Cube 1: Measurement grid: dx=5mm, dy=5mm, dz=5mm

Reference Value = 40.83 V/m; Power Drift = 0.02 dB

Peak SAR (extrapolated) = 3.84 W/kg

SAR(10 g) = 1.01 W/kg

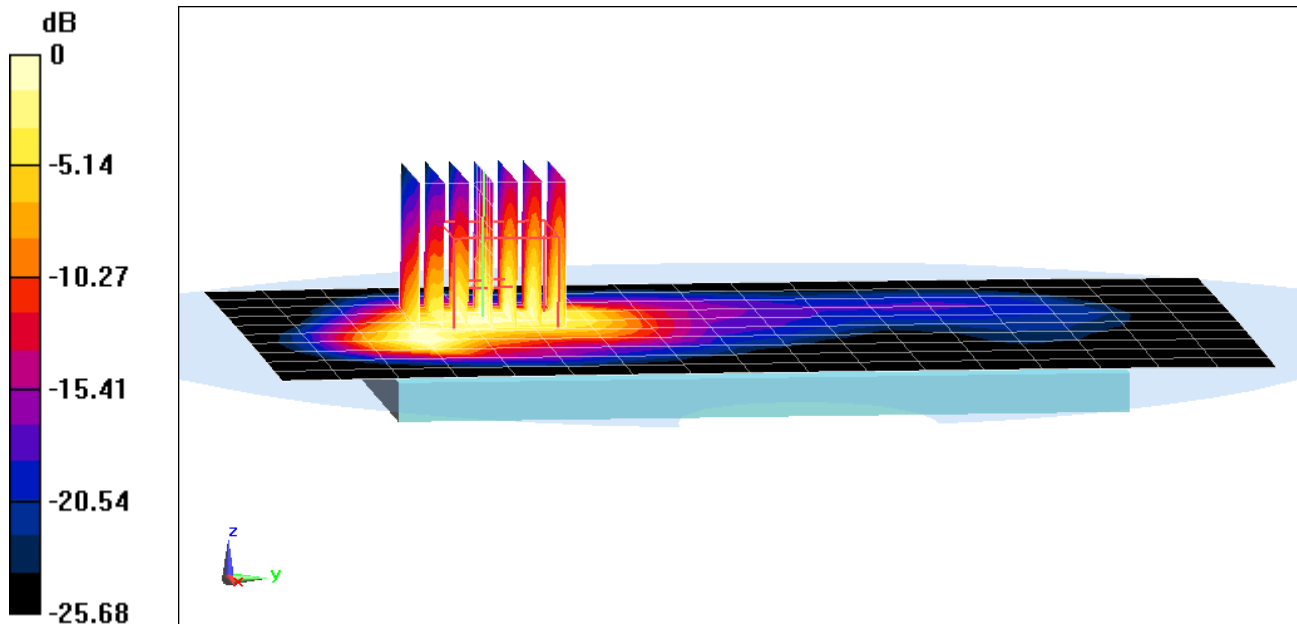

0 dB = 2.59 W/kg = 4.13 dBW/kg

PCTEST ENGINEERING LABORATORY, INC.

DUT: ZNFH820; Type: Portable Handset; Serial: 08137

Communication System: UID 0, LTE Band 7; Frequency: 2510 MHz; Duty Cycle: 1:1
Medium: 2450 Body, Medium parameters used (interpolated):
 $f = 2510 \text{ MHz}$; $\sigma = 2.071 \text{ S/m}$; $\epsilon_r = 50.367$; $\rho = 1000 \text{ kg/m}^3$
Phantom section: Flat Section; Space: 0.0 cm

Test Date: 02-26-2016; Ambient Temp: 21.5°C; Tissue Temp: 22.5°C

Probe: ES3DV3 - SN3263; ConvF(4.28, 4.28, 4.28); Calibrated: 5/20/2015;
Sensor-Surface: 3mm (Mechanical Surface Detection)
Electronics: DAE4 Sn859; Calibrated: 6/17/2015

Phantom: SAM with CRP v5.0 (Right); Type: QD000P40CD; Serial: TP:1759
Measurement SW: DASY52, Version 52.8 (8); SEMCAD X Version 14.6.10 (7331)

**Mode: LTE Band 7, 10g Hotspot Mode at 0mm SAR, Back Side, Low.ch, 20 MHz Bandwidth,
QPSK, 1 RB, 99 RB Offset, Camera Module Accessory**

Area Scan (11x18x1): Measurement grid: dx=12mm, dy=12mm

Zoom Scan (7x7x7)/Cube 0: Measurement grid: dx=5mm, dy=5mm, dz=5mm

Reference Value = 43.00 V/m; Power Drift = -0.13 dB

Peak SAR (extrapolated) = 8.90 W/kg

SAR(10 g) = 1.30 W/kg

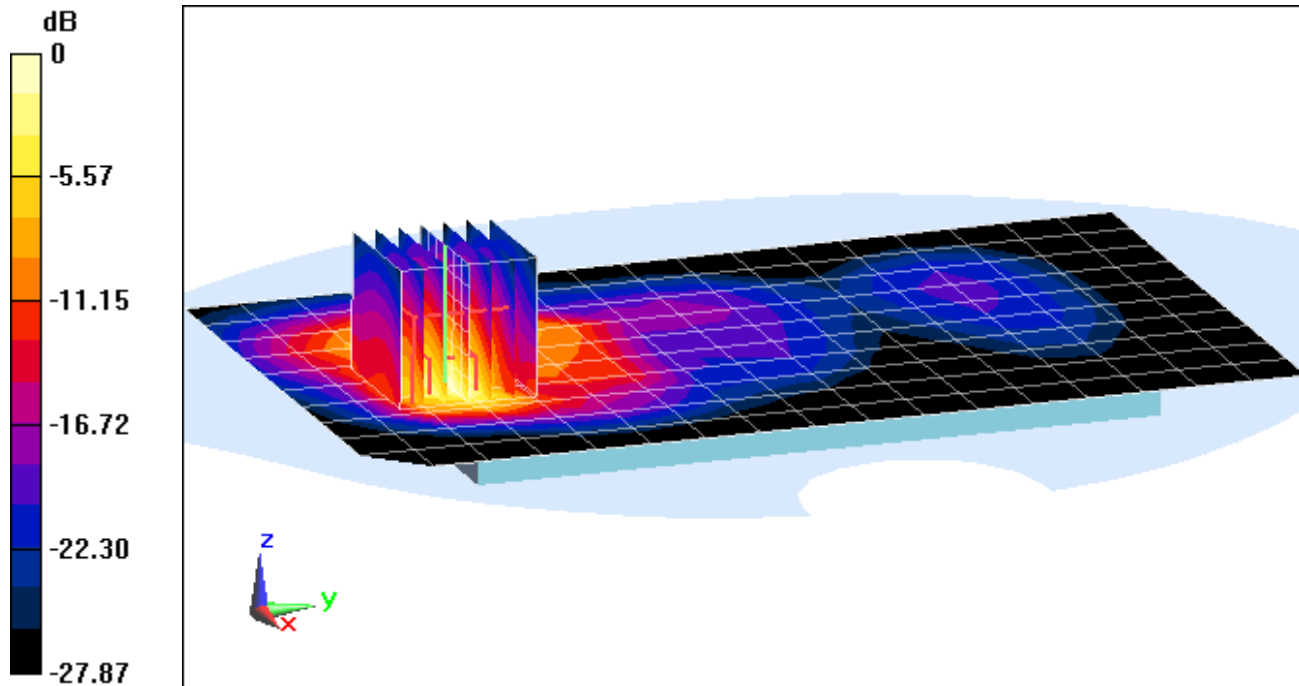

0 dB = 5.17 W/kg = 7.13 dBW/kg

APPENDIX B: SYSTEM VERIFICATION

PCTEST ENGINEERING LABORATORY, INC.

DUT: Dipole 750 MHz; Type: D750V3; Serial: 1054

Communication System: UID 0, CW; Frequency: 750 MHz; Duty Cycle: 1:1
Medium: 750 Head Medium parameters used (interpolated):
 $f = 750 \text{ MHz}$; $\sigma = 0.902 \text{ S/m}$; $\epsilon_r = 43.047$; $\rho = 1000 \text{ kg/m}^3$
Phantom section: Flat Section; Space: 1.5 cm

Test Date: 02-07-2016; Ambient Temp: 20.7°C; Tissue Temp: 20.4°C

Probe: ES3DV3 - SN3333; ConvF(6.46, 6.46, 6.46); Calibrated: 10/29/2015;
Sensor-Surface: 3mm (Mechanical Surface Detection)
Electronics: DAE4 Sn1333; Calibrated: 10/27/2015
Phantom: SAM Right; Type: QD000P40CD; Serial: 1757
Measurement SW: DASY52, Version 52.8 (8);SEMCAD X Version 14.6.10 (7331)

750 MHz System Verification at 23.0 dBm (200 mW)

Area Scan (7x15x1): Measurement grid: dx=15mm, dy=15mm
Zoom Scan (5x5x7)/Cube 0: Measurement grid: dx=8mm, dy=8mm, dz=5mm
Peak SAR (extrapolated) = 2.49 W/kg
SAR(1 g) = 1.69 W/kg
Deviation(1 g) = 2.05%

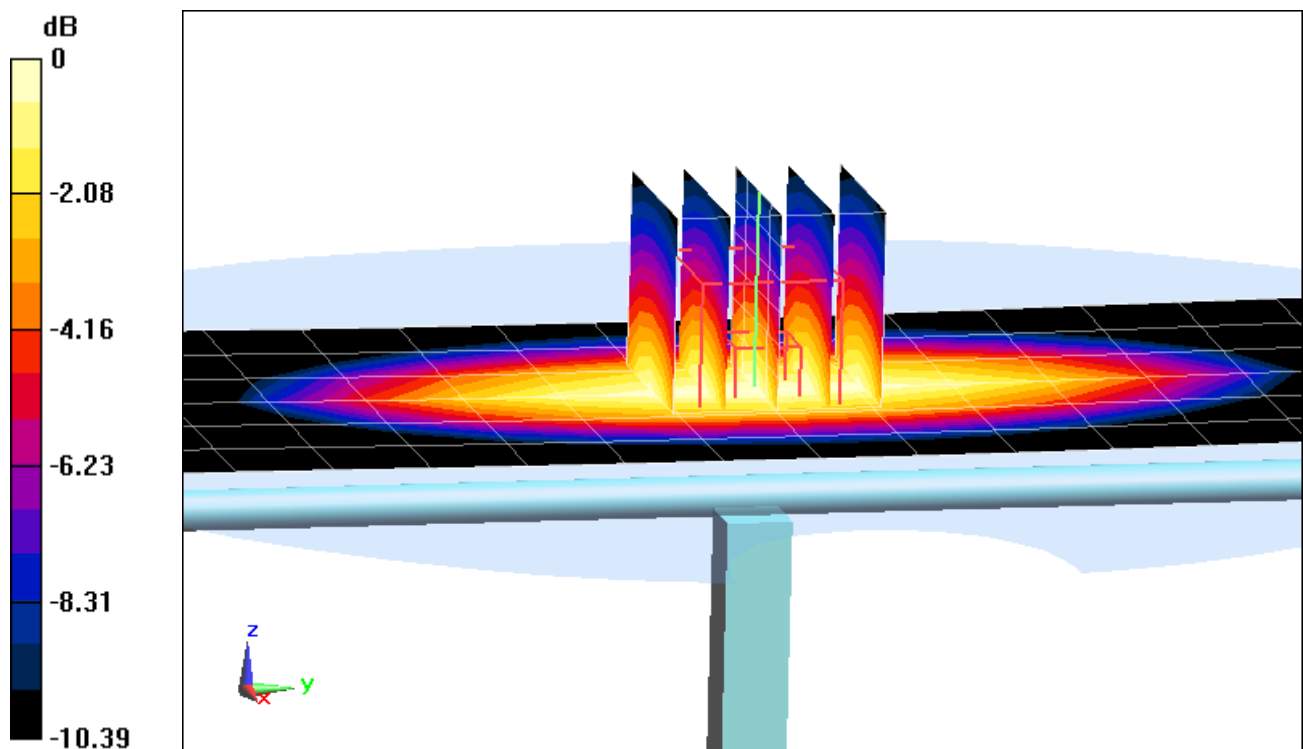

0 dB = 1.98 W/kg = 2.97 dBW/kg

PCTEST ENGINEERING LABORATORY, INC.

DUT: Dipole 835 MHz; Type: D835V2; Serial: 4d133

Communication System: UID 0, CW; Frequency: 835 MHz; Duty Cycle: 1:1

Medium: 835 Head Medium parameters used:

$f = 835 \text{ MHz}$; $\sigma = 0.885 \text{ S/m}$; $\epsilon_r = 40.687$; $\rho = 1000 \text{ kg/m}^3$

Phantom section: Flat Section; Space: 1.5 cm

Test Date: 1-28-2016; Ambient Temp: 21.6°C; Tissue Temp: 22.5°C

Probe: ES3DV3 - SN3319; ConvF(6.41, 6.41, 6.41); Calibrated: 3/19/2015;

Sensor-Surface: 3mm (Mechanical Surface Detection)

Electronics: DAE4 Sn1368; Calibrated: 3/13/2015

Phantom: SAM with CRP v4.0; Type: QD000P40CD; Serial: TP:1800

Measurement SW: DASY52, Version 52.8 (8);SEMCAD X Version 14.6.10 (7331)

835 MHz System Verification at 23.0 dBm (200 mW)

Area Scan (7x14x1): Measurement grid: dx=15mm, dy=15mm

Zoom Scan (5x5x7)/Cube 0: Measurement grid: dx=8mm, dy=8mm, dz=5mm

Peak SAR (extrapolated) = 2.79 W/kg

SAR(1 g) = 1.91 W/kg

Deviation(1 g) = 4.60%

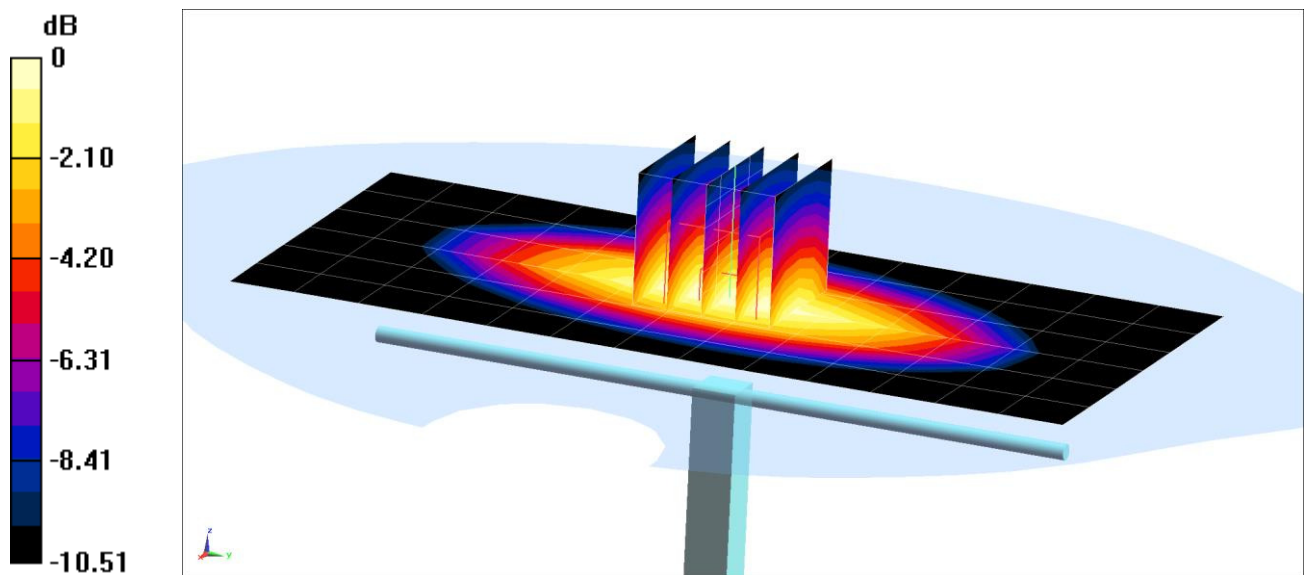

0 dB = 2.23 W/kg = 3.48 dBW/kg

PCTEST ENGINEERING LABORATORY, INC.

DUT: Dipole 1750 MHz; Type: D1750V2; Serial: 1051

Communication System: UID 0, CW; Frequency: 1750 MHz; Duty Cycle: 1:1

Medium: 1750 Head Medium parameters used:

$f = 1750$ MHz; $\sigma = 1.332$ S/m; $\epsilon_r = 39.53$; $\rho = 1000$ kg/m³

Phantom section: Flat Section; Space: 1.0 cm

Test Date: 02-04-2016; Ambient Temp: 23.5°C; Tissue Temp: 21.7°C

Probe: ES3DV2 - SN3022; ConvF(5.08, 5.08, 5.08); Calibrated: 8/26/2015;

Sensor-Surface: 3mm (Mechanical Surface Detection)

Electronics: DAE4 Sn665; Calibrated: 2/18/2015

Phantom: SAM with CRP v4.0; Type: QD000P40CD; Serial: TP:1797

Measurement SW: DASY52, Version 52.8 (8);SEMCAD X Version 14.6.10 (7331)

1750 MHz System Verification at 20.0 dBm (100 mW)

Area Scan (7x9x1): Measurement grid: dx=15mm, dy=15mm

Zoom Scan (5x5x7)/Cube 0: Measurement grid: dx=8mm, dy=8mm, dz=5mm

Peak SAR (extrapolated) = 6.13 W/kg

SAR(1 g) = 3.44 W/kg

Deviation(1 g) = -4.97%

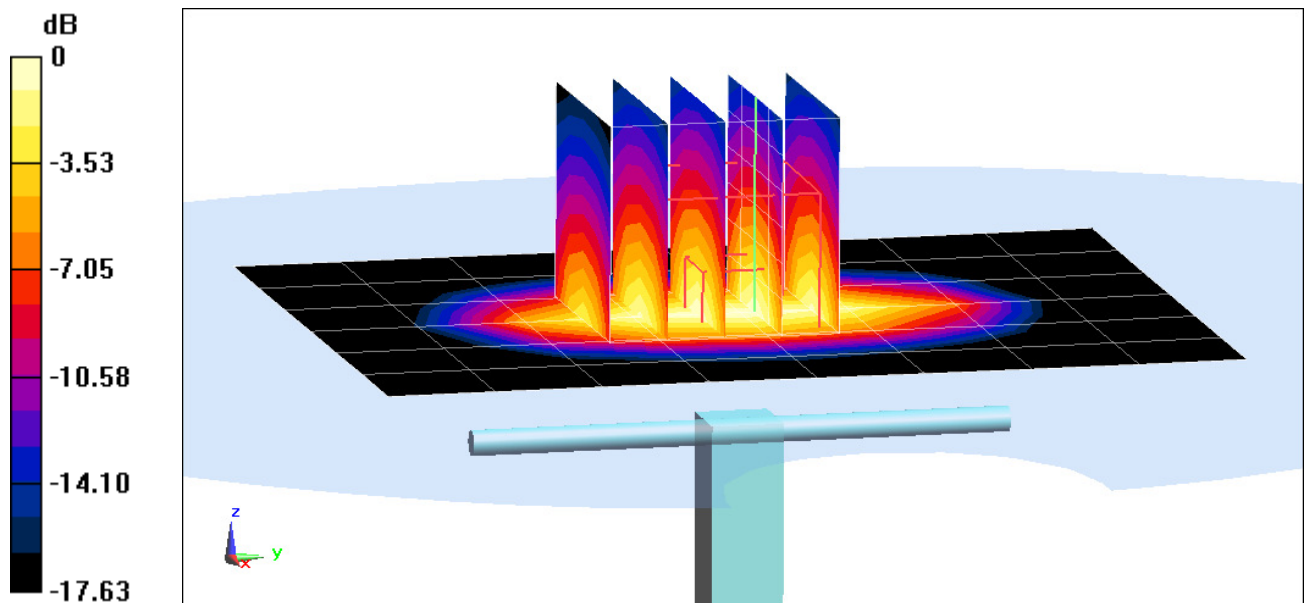

0 dB = 4.26 W/kg = 6.29 dBW/kg

PCTEST ENGINEERING LABORATORY, INC.

DUT: Dipole 1900 MHz; Type: D1900V2; Serial: 5d149

Communication System: UID 0, CW; Frequency: 1900 MHz; Duty Cycle: 1:1
Medium: 1900 Head Medium parameters used (interpolated):
 $f = 1900 \text{ MHz}$; $\sigma = 1.436 \text{ S/m}$; $\epsilon_r = 38.861$; $\rho = 1000 \text{ kg/m}^3$
Phantom section: Flat Section; Space: 1.0 cm

Test Date: 02-01-2016; Ambient Temp: 24.5°C; Tissue Temp: 22.8°C

Probe: ES3DV3 - SN3334; ConvF(5.18, 5.18, 5.18); Calibrated: 11/17/2015;
Sensor-Surface: 3mm (Mechanical Surface Detection)
Electronics: DAE4 Sn1415; Calibrated: 11/11/2015
Phantom: SAM Front; Type: SAM; Serial: 1686
Measurement SW: DASY52, Version 52.8 (8);SEMCAD X Version 14.6.10 (7331)

1900 MHz System Verification at 20.0 dBm (100 mW)

Area Scan (7x10x1): Measurement grid: dx=15mm, dy=15mm
Zoom Scan (5x5x7)/Cube 0: Measurement grid: dx=8mm, dy=8mm, dz=5mm
Peak SAR (extrapolated) = 7.93 W/kg
SAR(1 g) = 4.34 W/kg
Deviation(1 g) = 6.63%

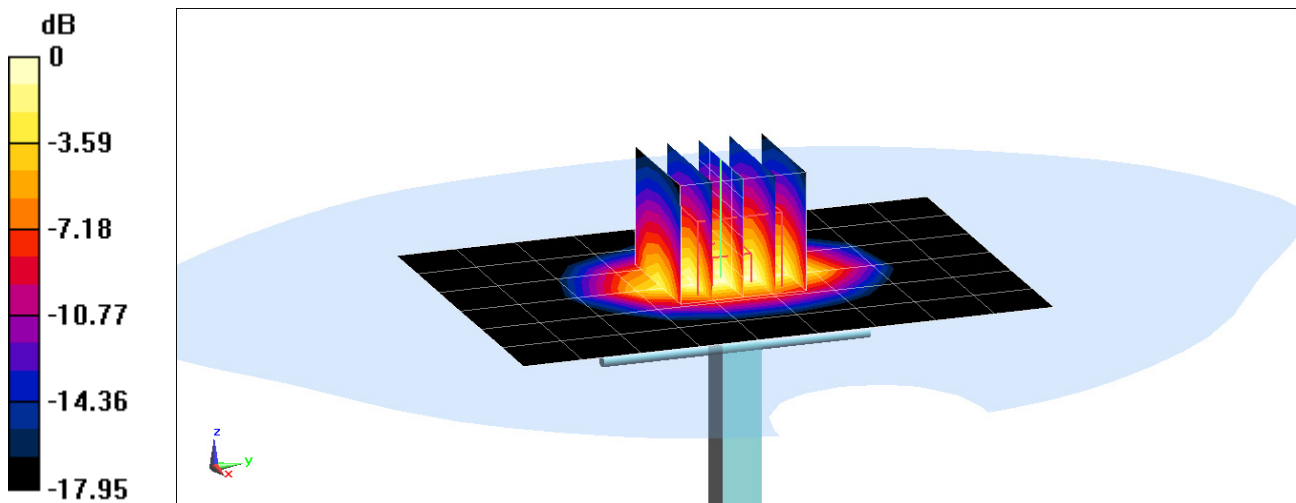

0 dB = 5.54 W/kg = 7.44 dBW/kg

PCTEST ENGINEERING LABORATORY, INC.

DUT: Dipole 2300 MHz; Type: D2300V2; Serial: 1064

Communication System: UID 0, CW; Frequency: 2300 MHz; Duty Cycle: 1:1

Medium: 2300 Head Medium parameters used:

$f = 2300 \text{ MHz}$; $\sigma = 1.651 \text{ S/m}$; $\epsilon_r = 38.624$; $\rho = 1000 \text{ kg/m}^3$

Phantom section: Flat Section; Space: 1.0 cm

Test Date: 02-22-2016; Ambient Temp: 23.8°C; Tissue Temp: 23.4°C

Probe: ES3DV3 - SN3351; ConvF(4.74, 4.74, 4.74); Calibrated: 6/22/2015;

Sensor-Surface: 3mm (Mechanical Surface Detection)

Electronics: DAE4 Sn1322; Calibrated: 8/24/2015

Phantom: SAM V5.0 Right; Type: QD000P40CD; Serial: 1647

Measurement SW: DASY52, Version 52.8 (8);SEMCAD X Version 14.6.10 (7331)

2300 MHz System Verification at 20.0 dBm (100 mW)

Area Scan (8x9x1): Measurement grid: dx=12mm, dy=12mm

Zoom Scan (7x7x7)/Cube 0: Measurement grid: dx=5mm, dy=5mm, dz=5mm

Peak SAR (extrapolated) = 8.83 W/kg

SAR(1 g) = 4.42 W/kg

Deviation(1 g) = -7.14%

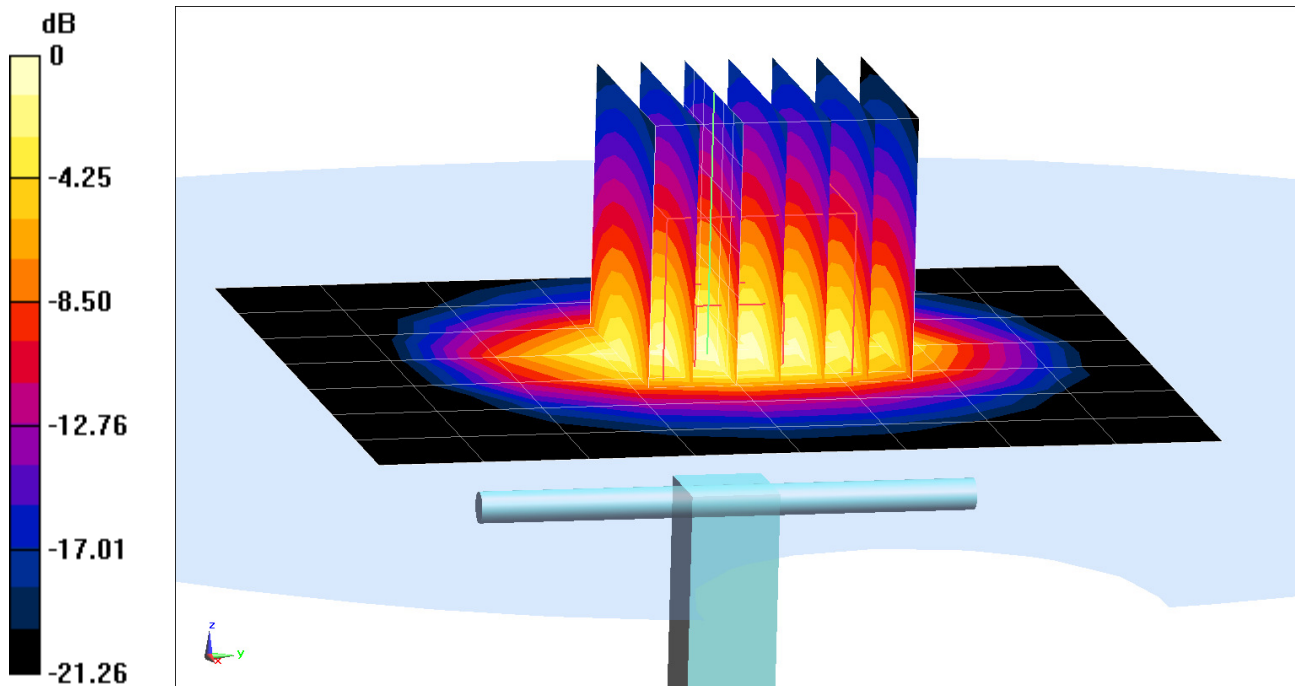

0 dB = 5.72 W/kg = 7.57 dBW/kg

PCTEST ENGINEERING LABORATORY, INC.

DUT: Dipole 2450 MHz; Type: D2450V2; Serial: 719

Communication System: UID 0, CW; Frequency: 2450 MHz; Duty Cycle: 1:1

Medium: 2450 Head; Medium parameters used:

$f = 2450 \text{ MHz}$; $\sigma = 1.808 \text{ S/m}$; $\epsilon_r = 40.413$; $\rho = 1000 \text{ kg/m}^3$

Phantom section: Flat Section; Space: 1.0 cm

Test Date: 02-01-2016; Ambient Temp: 22.5°C; Tissue Temp: 22.5°C

Probe: ES3DV3 - SN3263; ConvF(4.4, 4.4, 4.4); Calibrated: 5/20/2015;

Sensor-Surface: 3mm (Mechanical Surface Detection)

Electronics: DAE4 Sn859; Calibrated: 6/17/2015

Phantom: SAM with CRP (Left); Type: SAM; Serial: 1715

Measurement SW: DASY52, Version 52.8 (8); SEMCAD X Version 14.6.10 (7331)

2450 MHz System Verification at 20.0 dBm (100 mW)

Area Scan (8x9x1): Measurement grid: dx=12mm, dy=12mm

Zoom Scan (7x7x7)/Cube 0: Measurement grid: dx=5mm, dy=5mm, dz=5mm

Peak SAR (extrapolated) = 11.5 W/kg

SAR(1 g) = 5.48 W/kg

Deviation(1 g) = 1.11%

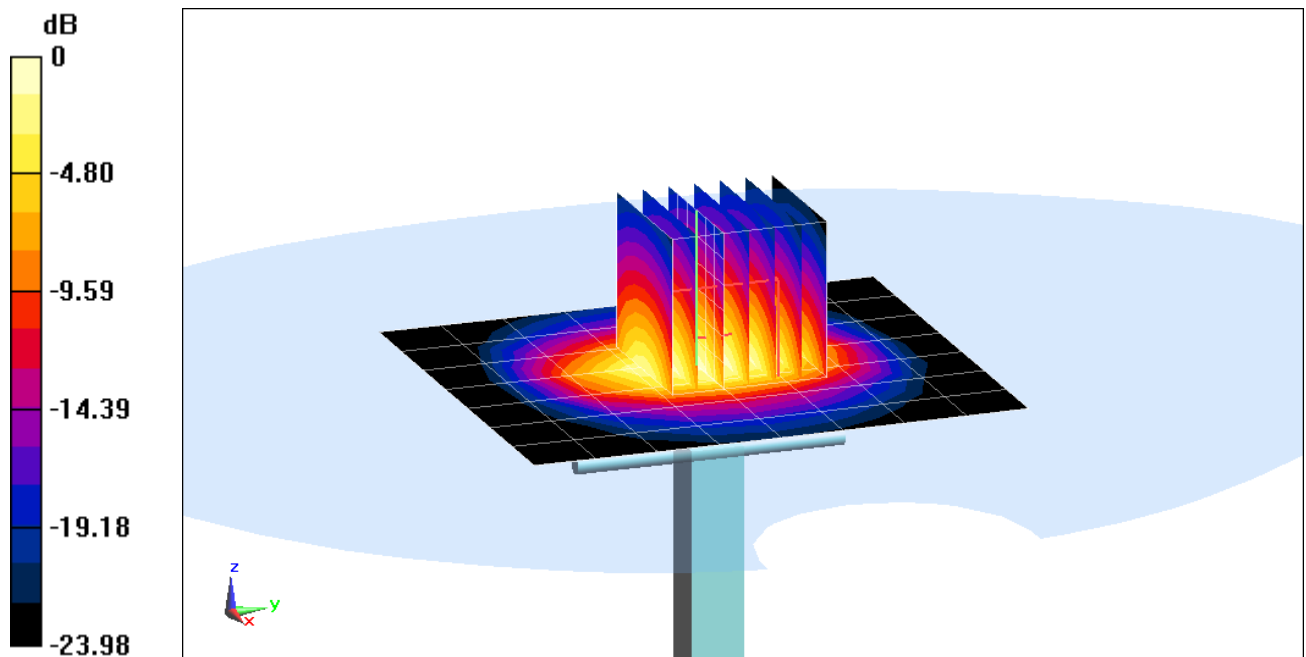

PCTEST ENGINEERING LABORATORY, INC.

DUT: Dipole 2450 MHz; Type: D2450V2; Serial: 719

Communication System: UID 0, CW; Frequency: 2450 MHz; Duty Cycle: 1:1

Medium: 2450 Head Medium parameters used:

$f = 2450 \text{ MHz}$; $\sigma = 1.812 \text{ S/m}$; $\epsilon_r = 38.112$; $\rho = 1000 \text{ kg/m}^3$

Phantom section: Flat Section; Space: 1.0 cm

Test Date: 02-22-2016; Ambient Temp: 23.8°C; Tissue Temp: 23.4°C

Probe: ES3DV3 - SN3351; ConvF(4.46, 4.46, 4.46); Calibrated: 6/22/2015;

Sensor-Surface: 3mm (Mechanical Surface Detection)

Electronics: DAE4 Sn1322; Calibrated: 8/24/2015

Phantom: SAM V5.0 Right; Type: QD000P40CD; Serial: 1647

Measurement SW: DASY52, Version 52.8 (8);SEMCAD X Version 14.6.10 (7331)

2450 MHz System Verification at 20.0 dBm (100 mW)

Area Scan (8x9x1): Measurement grid: dx=12mm, dy=12mm

Zoom Scan (7x7x7)/Cube 0: Measurement grid: dx=5mm, dy=5mm, dz=5mm

Peak SAR (extrapolated) = 10.6 W/kg

SAR(1 g) = 5.2 W/kg

Deviation(1 g) = -4.06%

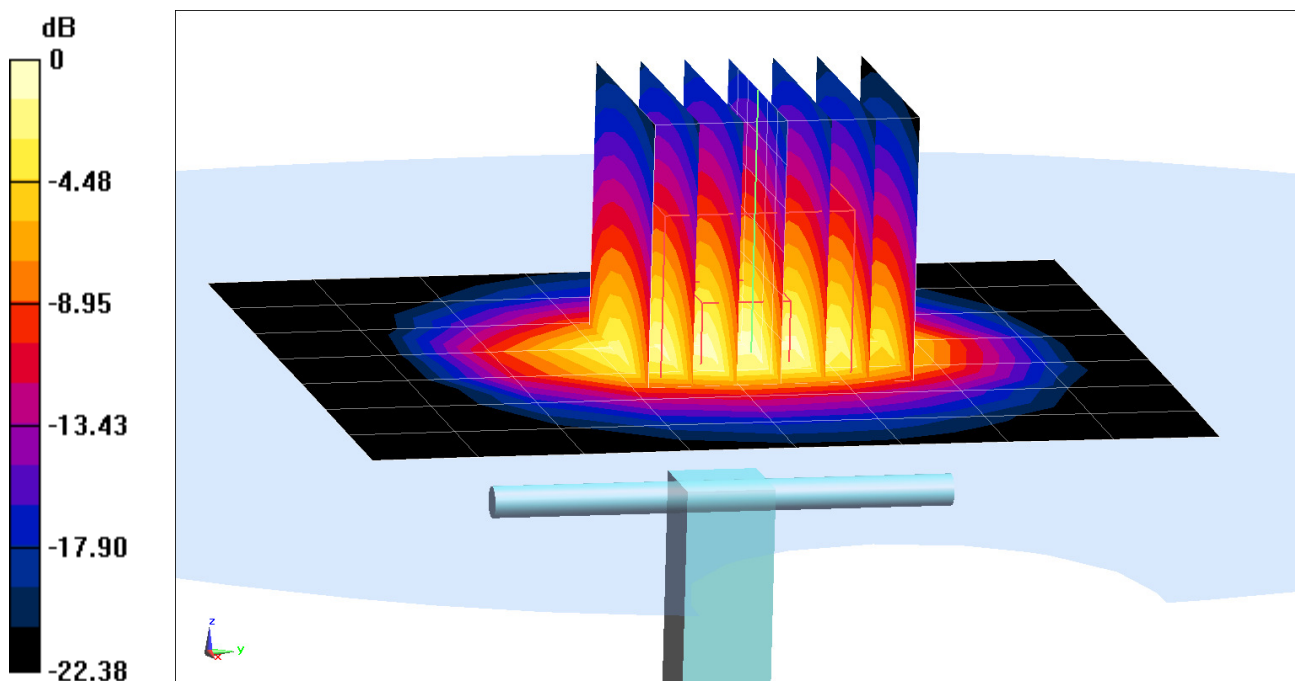

0 dB = 6.83 W/kg = 8.34 dBW/kg

PCTEST ENGINEERING LABORATORY, INC.

DUT: Dipole 5 GHz; Type: D5GHzV2; Serial: 1120

Communication System: UID 0, CW; Frequency: 5300 MHz; Duty Cycle: 1:1

Medium: 5 GHz Head; Medium parameters used:

$f = 5300 \text{ MHz}$; $\sigma = 4.585 \text{ S/m}$; $\epsilon_r = 37.537$; $\rho = 1000 \text{ kg/m}^3$

Phantom section: Flat Section; Space: 1.0 cm

Test Date: 02-10-2016; Ambient Temp: 22.1°C; Tissue Temp: 22.7°C

Probe: EX3DV4 - SN7357; ConvF(4.93, 4.93, 4.93); Calibrated: 4/23/2015;

Sensor-Surface: 1.4mm (Mechanical Surface Detection)

Electronics: DAE4 Sn1407; Calibrated: 4/20/2015

Phantom: SAM v5.0 front; Type: QD000P40CD; Serial: TP-1646

Measurement SW: DASY52, Version 52.8 (8);SEMCAD X Version 14.6.10 (7331)

5300 MHz System Verification at 17.0 dBm (50 mW)

Area Scan (7x8x1): Measurement grid: dx=10mm, dy=10mm

Zoom Scan (8x8x7)/Cube 0: Measurement grid: dx=4mm, dy=4mm, dz=1.4mm; Graded Ratio: 1.4

Peak SAR (extrapolated) = 15.5 W/kg

SAR(1 g) = 3.82 W/kg

Deviation(1 g) = -5.80%

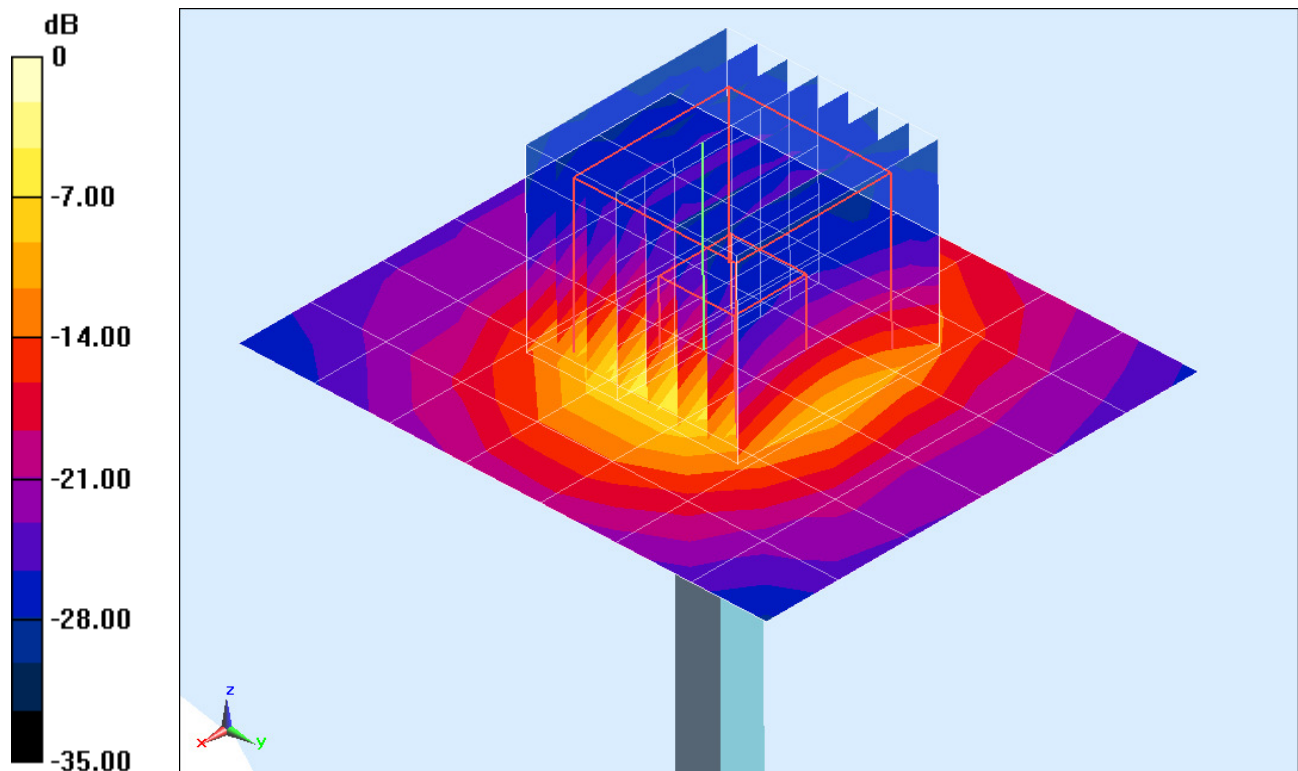

0 dB = 8.82 W/kg = 9.45 dBW/kg

PCTEST ENGINEERING LABORATORY, INC.

DUT: Dipole 5 GHz; Type: D5GHzV2; Serial: 1120

Communication System: UID 0, CW; Frequency: 5500 MHz; Duty Cycle: 1:1

Medium: 5 GHz Head; Medium parameters used:

$f = 5500 \text{ MHz}$; $\sigma = 4.762 \text{ S/m}$; $\epsilon_r = 37.292$; $\rho = 1000 \text{ kg/m}^3$

Phantom section: Flat Section; Space: 1.0 cm

Test Date: 02-10-2016; Ambient Temp: 22.1°C; Tissue Temp: 22.7°C

Probe: EX3DV4 - SN7357; ConvF(4.7, 4.7, 4.7); Calibrated: 4/23/2015;

Sensor-Surface: 1.4mm (Mechanical Surface Detection)

Electronics: DAE4 Sn1407; Calibrated: 4/20/2015

Phantom: SAM v5.0 front; Type: QD000P40CD; Serial: TP-1646

Measurement SW: DASY52, Version 52.8 (8);SEMCAD X Version 14.6.10 (7331)

5500 MHz System Verification at 17.0 dBm (50 mW)

Area Scan (7x7x1): Measurement grid: dx=10mm, dy=10mm

Zoom Scan (8x8x7)/Cube 0: Measurement grid: dx=4mm, dy=4mm, dz=1.4mm; Graded Ratio: 1.4

Peak SAR (extrapolated) = 16.1 W/kg

SAR(1 g) = 3.77 W/kg

Deviation(1 g) = -7.71%

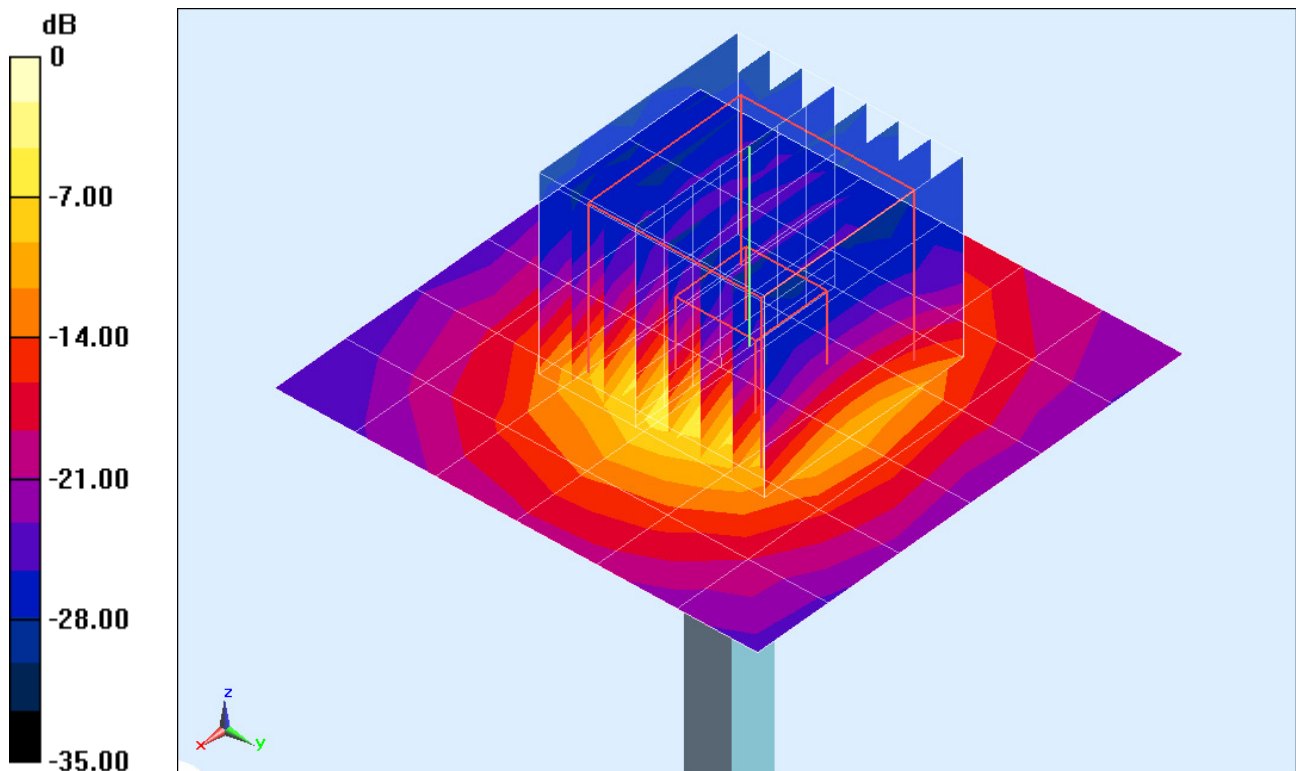

0 dB = 8.83 W/kg = 9.46 dBW/kg

PCTEST ENGINEERING LABORATORY, INC.

DUT: Dipole 5 GHz; Type: D5GHzV2; Serial: 1120

Communication System: UID 0, CW; Frequency: 5800 MHz; Duty Cycle: 1:1

Medium: 5 GHz Head; Medium parameters used:

$f = 5800 \text{ MHz}$; $\sigma = 5.087 \text{ S/m}$; $\epsilon_r = 36.958$; $\rho = 1000 \text{ kg/m}^3$

Phantom section: Flat Section; Space: 1.0 cm

Test Date: 02-10-2016; Ambient Temp: 22.1°C; Tissue Temp: 22.7°C

Probe: EX3DV4 - SN7357; ConvF(4.41, 4.41, 4.41); Calibrated: 4/23/2015;

Sensor-Surface: 1.4mm (Mechanical Surface Detection)

Electronics: DAE4 Sn1407; Calibrated: 4/20/2015

Phantom: SAM v5.0 front; Type: QD000P40CD; Serial: TP-1646

Measurement SW: DASY52, Version 52.8 (8);SEMCAD X Version 14.6.10 (7331)

5800 MHz System Verification at 17.0 dBm (50 mW)

Area Scan (7x7x1): Measurement grid: dx=10mm, dy=10mm

Zoom Scan (8x8x7)/Cube 0: Measurement grid: dx=4mm, dy=4mm, dz=1.4mm; Graded Ratio: 1.4

Peak SAR (extrapolated) = 16.5 W/kg

SAR(1 g) = 3.75 W/kg

Deviation(1 g) = -2.98%

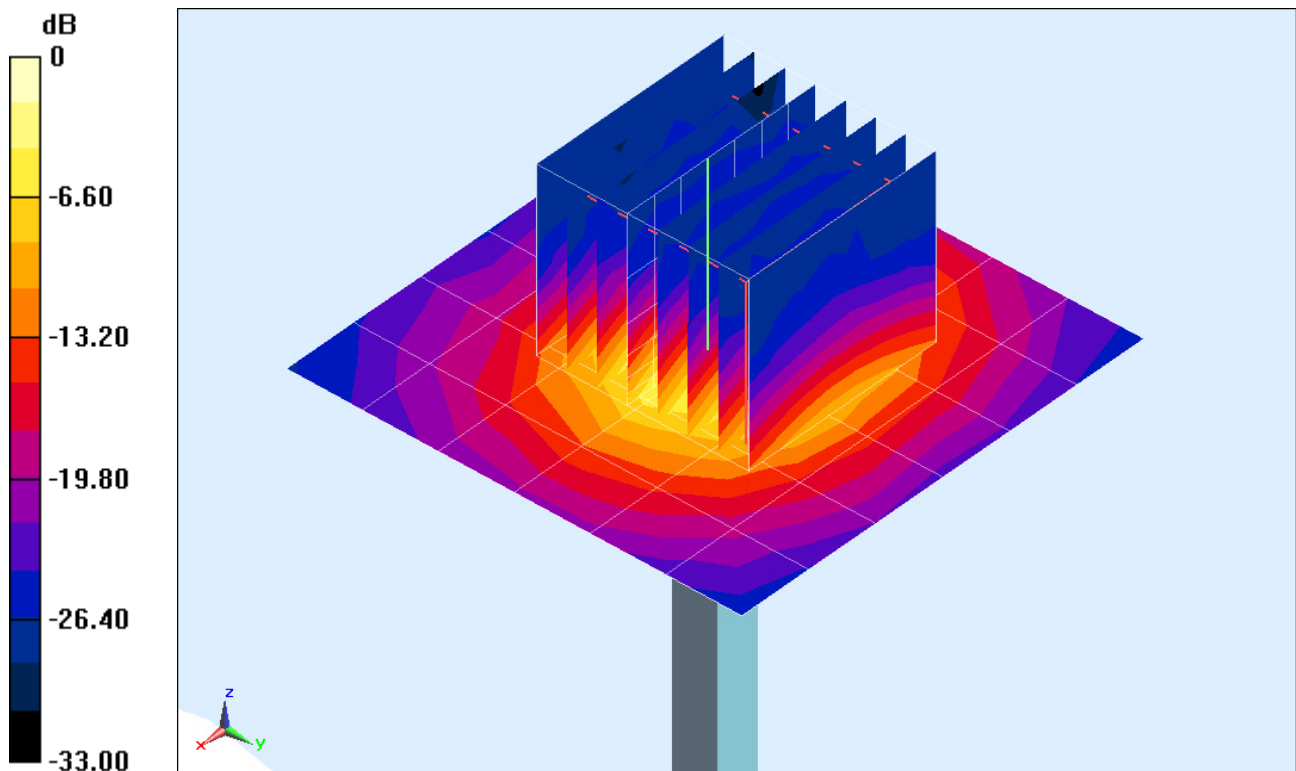

0 dB = 8.92 W/kg = 9.50 dBW/kg

PCTEST ENGINEERING LABORATORY, INC.

DUT: Dipole 750 MHz; Type: D750V3; Serial: 1054

Communication System: UID 0, CW; Frequency: 750 MHz; Duty Cycle: 1:1
Medium: 750 Body Medium parameters used (interpolated):
 $f = 750 \text{ MHz}$; $\sigma = 0.966 \text{ S/m}$; $\epsilon_r = 54.707$; $\rho = 1000 \text{ kg/m}^3$
Phantom section: Flat Section; Space: 1.5 cm

Test Date: 02-08-2016; Ambient Temp: 20.6°C; Tissue Temp: 21.1°C

Probe: ES3DV2 - SN3022; ConvF(6.16, 6.16, 6.16); Calibrated: 8/26/2015;
Sensor-Surface: 3mm (Mechanical Surface Detection)
Electronics: DAE4 Sn665; Calibrated: 2/18/2015
Phantom: SAM with CRP v4.0; Type: QD000P40CD; Serial: TP:1797
Measurement SW: DASY52, Version 52.8 (8);SEMCAD X Version 14.6.10 (7331)

750 MHz System Verification at 23.0 dBm (200 mW)

Area Scan (7x15x1): Measurement grid: dx=15mm, dy=15mm
Zoom Scan (5x5x7)/Cube 0: Measurement grid: dx=8mm, dy=8mm, dz=5mm
Peak SAR (extrapolated) = 2.63 W/kg
SAR(1 g) = 1.79 W/kg
Deviation(1 g) = 4.92%

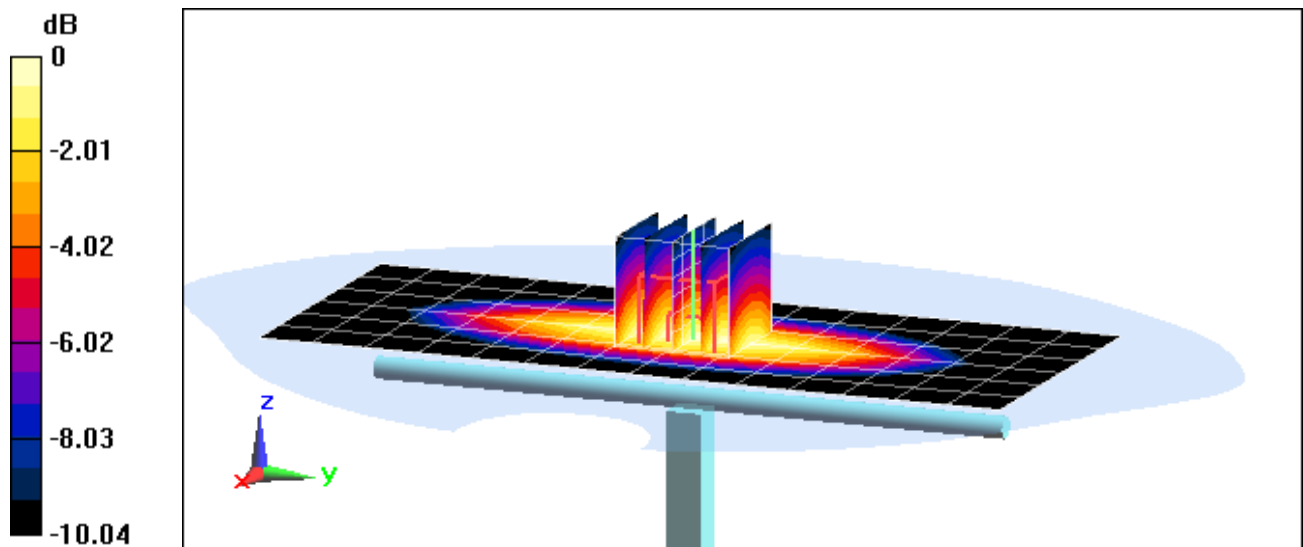

PCTEST ENGINEERING LABORATORY, INC.

DUT: Dipole 835 MHz; Type: D835V2; Serial: 4d119

Communication System: UID 0, CW; Frequency: 835 MHz; Duty Cycle: 1:1

Medium: 835 Body Medium parameters used:

$f = 835 \text{ MHz}$; $\sigma = 1.004 \text{ S/m}$; $\epsilon_r = 55.452$; $\rho = 1000 \text{ kg/m}^3$

Phantom section: Flat Section; Space: 1.5 cm

Test Date: 02-02-2016; Ambient Temp: 24.3°C; Tissue Temp: 22.8°C

Probe: ES3DV3 - SN3334; ConvF(6.24, 6.24, 6.24); Calibrated: 11/17/2015;

Sensor-Surface: 3mm (Mechanical Surface Detection)

Electronics: DAE4 Sn1415; Calibrated: 11/11/2015

Phantom: SAM Front; Type: SAM; Serial: 1686

Measurement SW: DASY52, Version 52.8 (8);SEMCAD X Version 14.6.10 (7331)

835 MHz System Verification at 23.0 dBm (200 mW)

Area Scan (7x14x1): Measurement grid: dx=15mm, dy=15mm

Zoom Scan (5x5x7)/Cube 0: Measurement grid: dx=8mm, dy=8mm, dz=5mm

Peak SAR (extrapolated) = 2.91 W/kg

SAR(1 g) = 1.99 W/kg

Deviation(1 g) = 8.15%

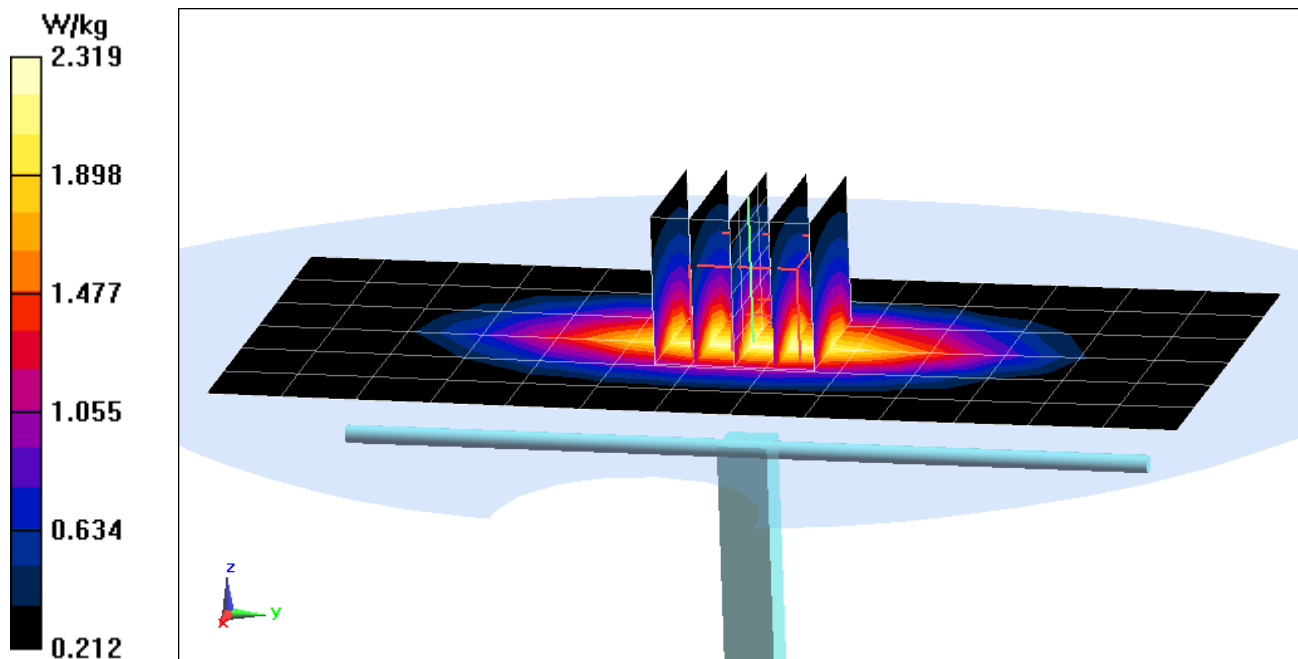

PCTEST ENGINEERING LABORATORY, INC.

DUT: Dipole 1750 MHz; Type: D1750V2; Serial: 1051

Communication System: UID 0, CW; Frequency: 1750 MHz; Duty Cycle: 1:1

Medium: 1750 Body Medium parameters used:

$f = 1750 \text{ MHz}$; $\sigma = 1.512 \text{ S/m}$; $\epsilon_r = 51.539$; $\rho = 1000 \text{ kg/m}^3$

Phantom section: Flat Section; Space: 1.0 cm

Test Date: 02-01-2016; Ambient Temp: 23.2°C; Tissue Temp: 22.5°C

Probe: ES3DV2 - SN3022; ConvF(4.79, 4.79, 4.79); Calibrated: 8/26/2015;

Sensor-Surface: 3mm (Mechanical Surface Detection)

Electronics: DAE4 Sn665; Calibrated: 2/18/2015

Phantom: SAM with CRP v4.0; Type: QD000P40CD; Serial: TP:1797

Measurement SW: DASY52, Version 52.8 (8); SEMCAD X Version 14.6.10 (7331)

1750 MHz System Verification at 20.0 dBm (100 mW)

Area Scan (7x9x1): Measurement grid: dx=15mm, dy=15mm

Zoom Scan (5x6x7)/Cube 0: Measurement grid: dx=8mm, dy=8mm, dz=5mm

Peak SAR (extrapolated) = 7.01 W/kg

SAR(1 g) = 4.03 W/kg

Deviation(1 g) = 8.63%

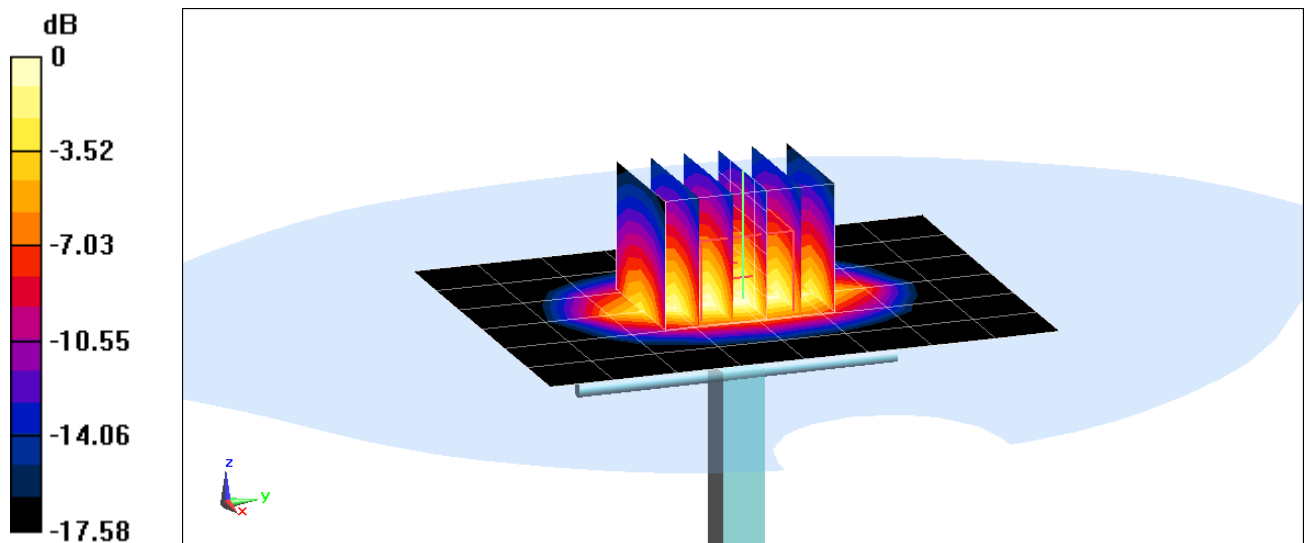

0 dB = 5.00 W/kg = 6.99 dBW/kg

PCTEST ENGINEERING LABORATORY, INC.

DUT: Dipole 1750 MHz; Type: D1750V2; Serial: 1051

Communication System: UID 0, CW; Frequency: 1750 MHz; Duty Cycle: 1:1

Medium: 1750 Body Medium parameters used:

$f = 1750 \text{ MHz}$; $\sigma = 1.484 \text{ S/m}$; $\epsilon_r = 51.369$; $\rho = 1000 \text{ kg/m}^3$

Phantom section: Flat Section; Space: 1.0 cm

Test Date: 02-10-2016; Ambient Temp: 24.0°C; Tissue Temp: 22.6°C

Probe: ES3DV2 - SN3022; ConvF(4.79, 4.79, 4.79); Calibrated: 8/26/2015;

Sensor-Surface: 3mm (Mechanical Surface Detection)

Electronics: DAE4 Sn1323; Calibrated: 9/16/2015

Phantom: ELI v5.0; Type: QDOVA001BB; Serial: 1229

Measurement SW: DASY52, Version 52.8 (8);SEMCAD X Version 14.6.10 (7331)

1750 MHz System Verification at 20.0 dBm (100 mW)

Area Scan (7x9x1): Measurement grid: dx=15mm, dy=15mm

Zoom Scan (5x5x7)/Cube 0: Measurement grid: dx=8mm, dy=8mm, dz=5mm

Peak SAR (extrapolated) = 6.72 W/kg

SAR(1 g) = 3.84 W/kg

Deviation(1 g) = 3.50%

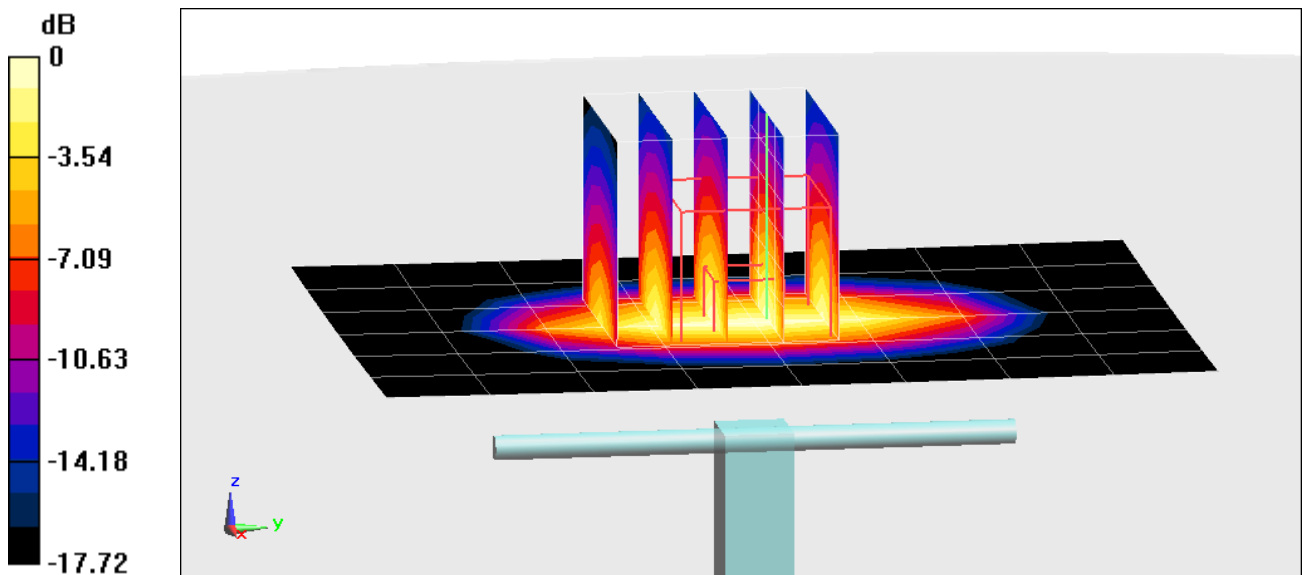

0 dB = 4.75 W/kg = 6.77 dBW/kg

PCTEST ENGINEERING LABORATORY, INC.

DUT: Dipole 1900 MHz; Type: D1900V2; Serial: 5d149

Communication System: UID 0, CW; Frequency: 1900 MHz; Duty Cycle: 1:1
Medium: 1900 Body Medium parameters used (interpolated):
 $f = 1900 \text{ MHz}$; $\sigma = 1.574 \text{ S/m}$; $\epsilon_r = 51.319$; $\rho = 1000 \text{ kg/m}^3$
Phantom section: Flat Section; Space: 1.0 cm

Test Date: 02-08-2016; Ambient Temp: 22.0°C; Tissue Temp: 21.2°C

Probe: ES3DV3 - SN3334; ConvF(4.84, 4.84, 4.84); Calibrated: 11/17/2015;
Sensor-Surface: 3mm (Mechanical Surface Detection)
Electronics: DAE4 Sn1415; Calibrated: 11/11/2015
Phantom: SAM Front; Type: SAM; Serial: 1686
Measurement SW: DASY52, Version 52.8 (8);SEMCAD X Version 14.6.10 (7331)

1900 MHz System Verification at 20.0 dBm (100 mW)

Area Scan (7x10x1): Measurement grid: dx=15mm, dy=15mm
Zoom Scan (5x5x7)/Cube 0: Measurement grid: dx=8mm, dy=8mm, dz=5mm
Peak SAR (extrapolated) = 7.63 W/kg
SAR(1 g) = 4.18 W/kg
Deviation(1 g) = 3.47%

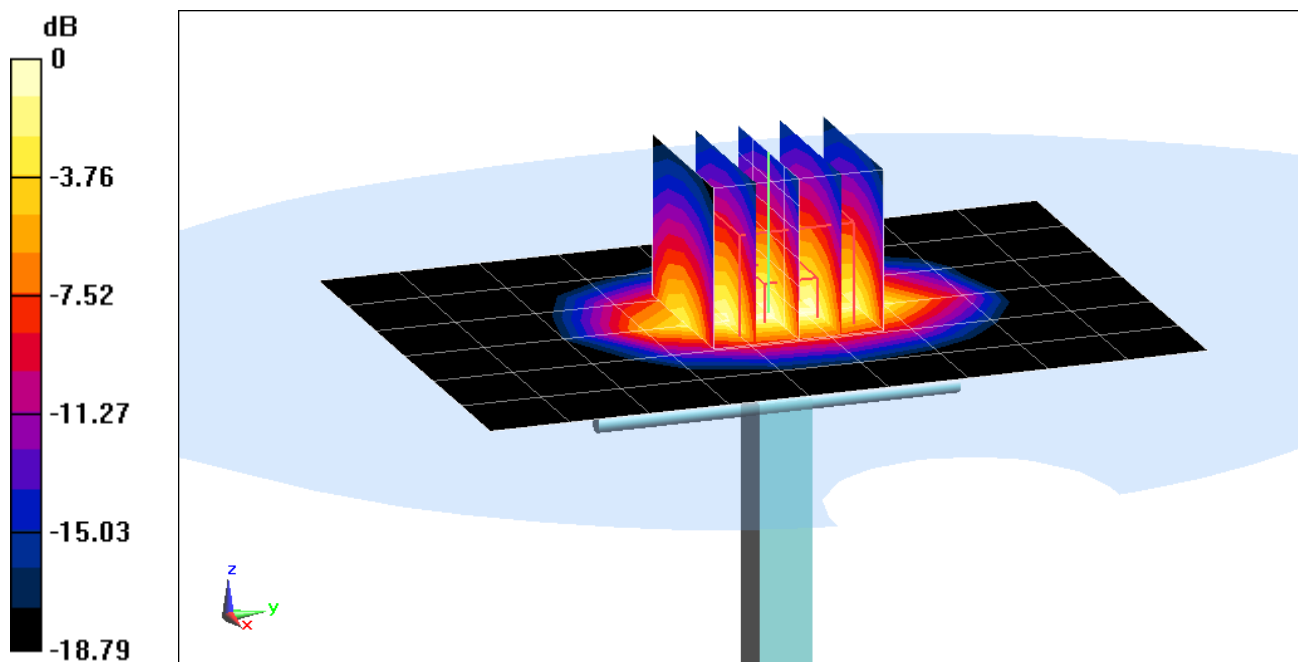

0 dB = 5.31 W/kg = 7.25 dBW/kg

PCTEST ENGINEERING LABORATORY, INC.

DUT: Dipole 2300 MHz; Type: D2300V2; Serial: 1064

Communication System: UID 0, CW; Frequency: 2300 MHz; Duty Cycle: 1:1

Medium: 2300 Body Medium parameters used:

$f = 2300 \text{ MHz}$; $\sigma = 1.826 \text{ S/m}$; $\epsilon_r = 52.675$; $\rho = 1000 \text{ kg/m}^3$

Phantom section: Flat Section; Space: 1.0 cm

Test Date: 02-11-2016; Ambient Temp: 23.1°C; Tissue Temp: 22.2°C

Probe: ES3DV3 - SN3263; ConvF(4.42, 4.42, 4.42); Calibrated: 5/20/2015;

Sensor-Surface: 3mm (Mechanical Surface Detection)

Electronics: DAE4 Sn859; Calibrated: 6/17/2015

Phantom: SAM with CRP v5.0 (Right); Type: QD000P40CD; Serial: TP:1759

Measurement SW: DASY52, Version 52.8 (8); SEMCAD X Version 14.6.10 (7331)

2300 MHz System Verification at 20.0 dBm (100 mW)

Area Scan (8x9x1): Measurement grid: dx=12mm, dy=12mm

Zoom Scan (7x7x7)/Cube 0: Measurement grid: dx=5mm, dy=5mm, dz=5mm

Peak SAR (extrapolated) = 9.05 W/kg

SAR(1 g) = 4.67 W/kg

Deviation(1 g) = 2.64 %

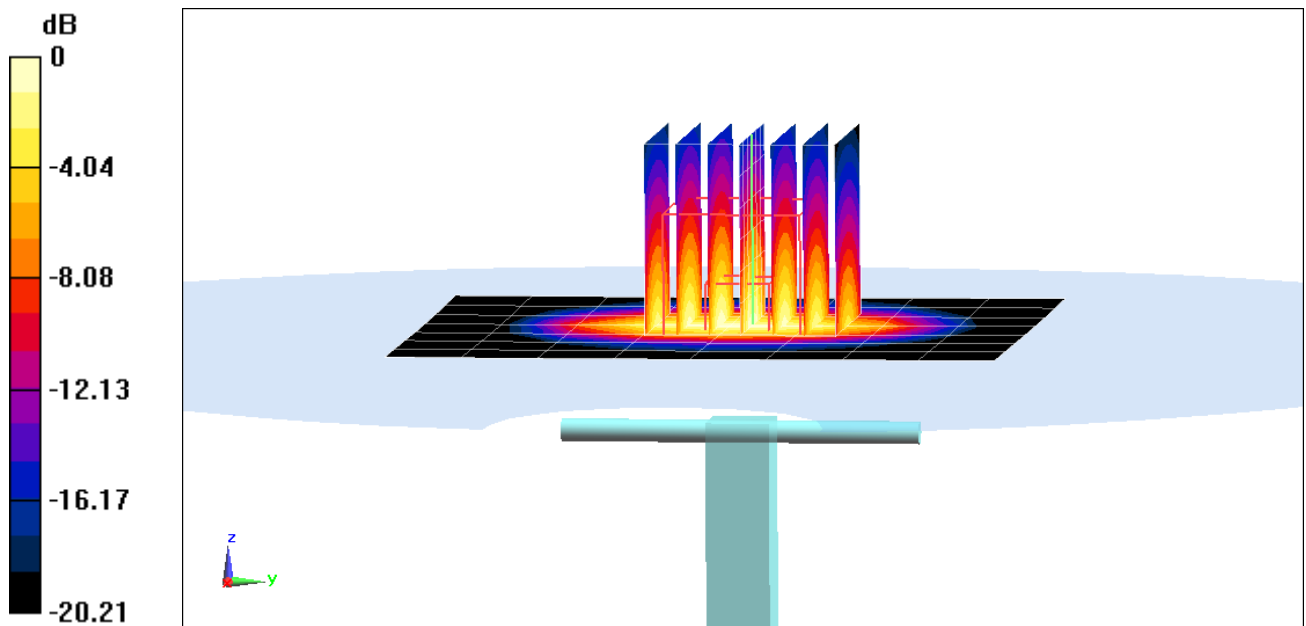

0 dB = 6.02 W/kg = 7.80 dBW/kg

PCTEST ENGINEERING LABORATORY, INC.

DUT: Dipole 2300 MHz; Type: D2300V2; Serial: 1064

Communication System: UID 0, CW; Frequency: 2300 MHz; Duty Cycle: 1:1

Medium: 2300 Body Medium parameters used:

$f = 2300$ MHz; $\sigma = 1.809$ S/m; $\epsilon_r = 51.639$; $\rho = 1000$ kg/m³

Phantom section: Flat Section; Space: 1.0 cm

Test Date: 02-22-2016; Ambient Temp: 23.1°C; Tissue Temp: 22.6°C

Probe: ES3DV3 - SN3334; ConvF(4.61, 4.61, 4.61); Calibrated: 11/17/2015;

Sensor-Surface: 3mm (Mechanical Surface Detection)

Electronics: DAE4 Sn1415; Calibrated: 11/11/2015

Phantom: SAM Front; Type: SAM; Serial: 1686

Measurement SW: DASY52, Version 52.8 (8);SEMCAD X Version 14.6.10 (7331)

2300 MHz System Verification at 20.0 dBm (100 mW)

Area Scan (8x9x1): Measurement grid: dx=12mm, dy=12mm

Zoom Scan (7x7x7)/Cube 0: Measurement grid: dx=5mm, dy=5mm, dz=5mm

Peak SAR (extrapolated) = 9.51 W/kg

SAR(1 g) = 4.71 W/kg

Deviation(1 g) = 3.52%

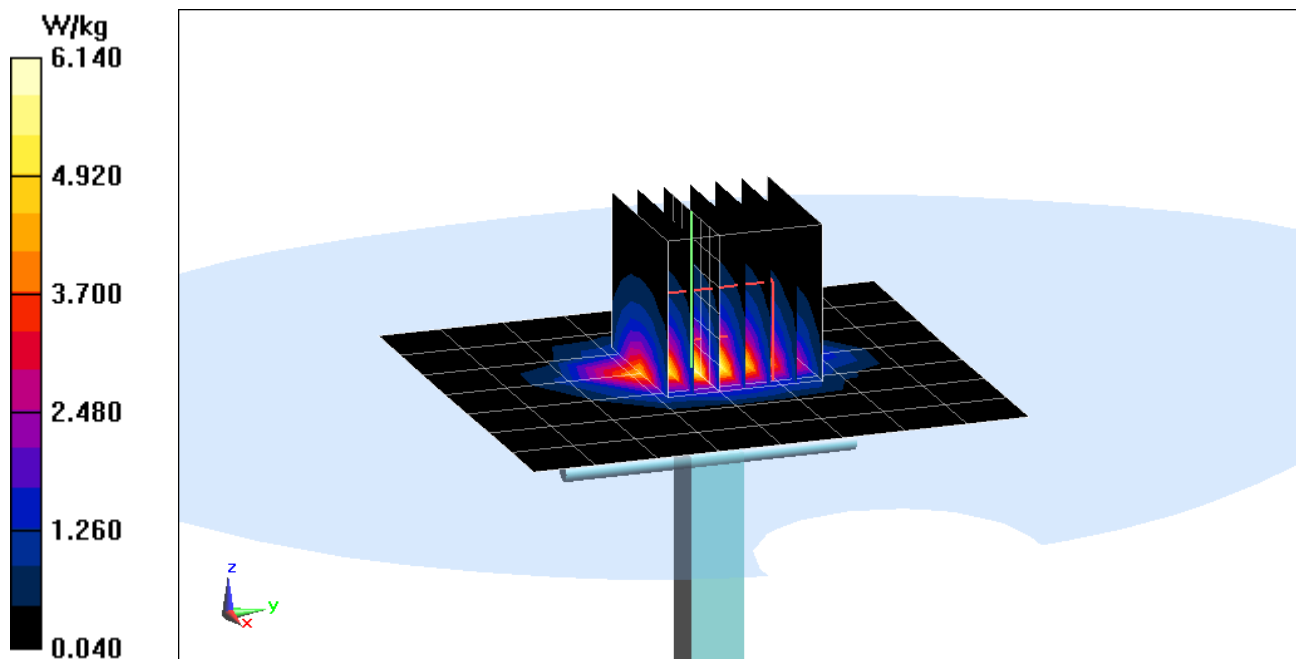

PCTEST ENGINEERING LABORATORY, INC.

DUT: Dipole 2450 MHz; Type: D2450V2; Serial: 719

Communication System: UID 0, CW; Frequency: 2450 MHz; Duty Cycle: 1:1

Medium: 2450 Body Medium parameters used:

$f = 2450 \text{ MHz}$; $\sigma = 1.984 \text{ S/m}$; $\epsilon_r = 51.839$; $\rho = 1000 \text{ kg/m}^3$

Phantom section: Flat Section; Space: 1.0 cm

Test Date: 02-03-2016; Ambient Temp: 22.5°C; Tissue Temp: 23.0°C

Probe: ES3DV3 - SN3319; ConvF(4.11, 4.11, 4.11); Calibrated: 3/19/2015;

Sensor-Surface: 3mm (Mechanical Surface Detection)

Electronics: DAE4 Sn1368; Calibrated: 3/13/2015

Phantom: SAM with CRP v4.0; Type: QD000P40CD; Serial: TP:1800

Measurement SW: DASY52, Version 52.8 (8);SEMCAD X Version 14.6.10 (7331)

2450 MHz System Verification at 20.0 dBm (100 mW)

Area Scan (8x9x1): Measurement grid: dx=12mm, dy=12mm

Zoom Scan (7x7x7)/Cube 0: Measurement grid: dx=5mm, dy=5mm, dz=5mm

Peak SAR (extrapolated) = 11.1 W/kg

SAR(1 g) = 5.26 W/kg

Deviation(1 g) = 1.35%

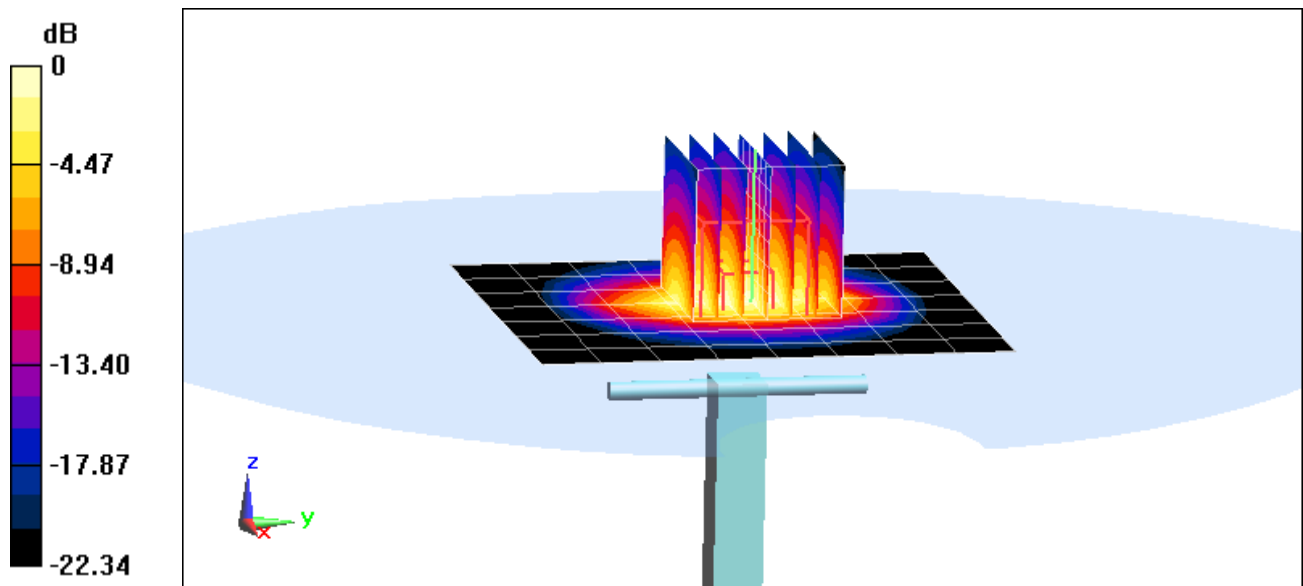

0 dB = 6.76 W/kg = 8.30 dBW/kg

PCTEST ENGINEERING LABORATORY, INC.

DUT: Dipole 2450 MHz; Type: D2450V2; Serial: 719

Communication System: UID 0, CW; Frequency: 2450 MHz; Duty Cycle: 1:1

Medium: 2450 Body Medium parameters used:

$f = 2450 \text{ MHz}$; $\sigma = 1.952 \text{ S/m}$; $\epsilon_r = 50.779$; $\rho = 1000 \text{ kg/m}^3$

Phantom section: Flat Section; Space: 1.0 cm

Test Date: 02-16-2016; Ambient Temp: 24.1°C; Tissue Temp: 23.4°C

Probe: ES3DV3 - SN3334; ConvF(4.45, 4.45, 4.45); Calibrated: 11/17/2015;

Sensor-Surface: 3mm (Mechanical Surface Detection)

Electronics: DAE4 Sn1415; Calibrated: 11/11/2015

Phantom: SAM Front; Type: SAM; Serial: 1686

Measurement SW: DASY52, Version 52.8 (8);SEMCAD X Version 14.6.10 (7331)

2450 MHz System Verification at 20.0 dBm (100 mW)

Area Scan (8x9x1): Measurement grid: dx=12mm, dy=12mm

Zoom Scan (7x7x7)/Cube 0: Measurement grid: dx=5mm, dy=5mm, dz=5mm

Peak SAR (extrapolated) = 10.8 W/kg

SAR(1 g) = 5.06 W/kg

Deviation(1 g) = -2.50%

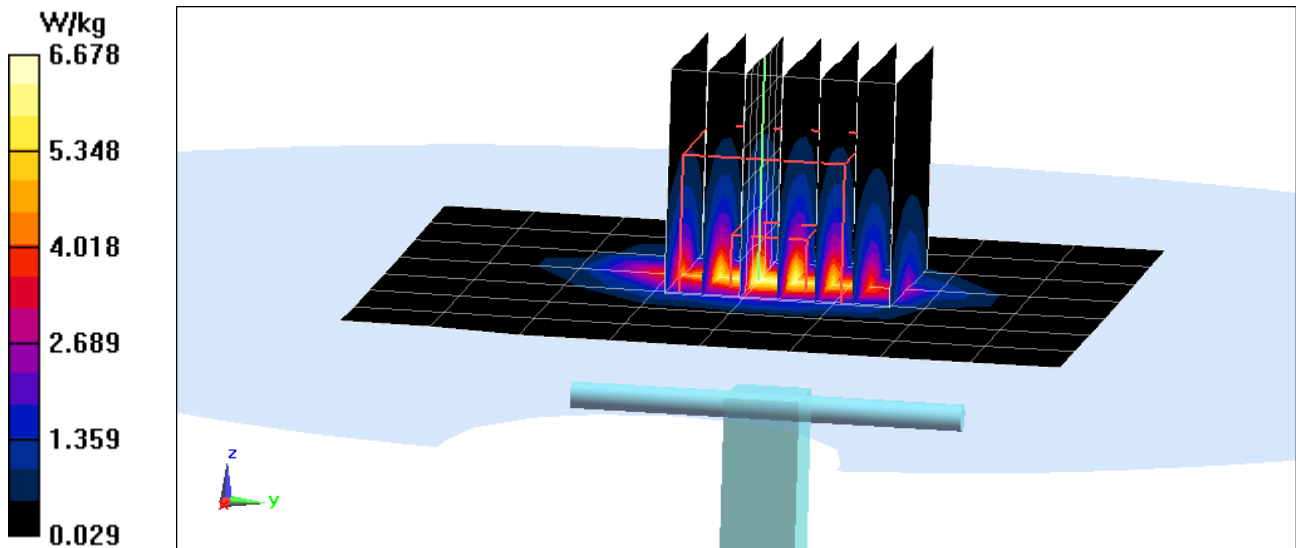

PCTEST ENGINEERING LABORATORY, INC.

DUT: Dipole 5 GHz; Type: D5GHzV2; Serial: 1191

Communication System: UID 0, CW; Frequency: 5250 MHz; Duty Cycle: 1:1

Medium: 5 GHz Body Medium parameters used (interpolated):

$f = 5250 \text{ MHz}$; $\sigma = 5.493 \text{ S/m}$; $\epsilon_r = 48.156$; $\rho = 1000 \text{ kg/m}^3$

Phantom section: Flat Section; Space: 1.0 cm

Test Date: 02-08-2016; Ambient Temp: 23.6°C; Tissue Temp: 22.3°C

Probe: EX3DV4 - SN7308; ConvF(4.63, 4.63, 4.63); Calibrated: 7/21/2015;

Sensor-Surface: 1.4mm (Mechanical Surface Detection)

Electronics: DAE4 Sn1322; Calibrated: 8/24/2015

Phantom: SAM 5.0 front; Type: QD000P40CD; Serial: TP:-1648

Measurement SW: DASY52, Version 52.8 (8);SEMCAD X Version 14.6.10 (7331)

5250 MHz System Verification at 17.0 dBm (50 mW)

Area Scan (7x7x1): Measurement grid: dx=10mm, dy=10mm

Zoom Scan (8x8x7)/Cube 0: Measurement grid: dx=4mm, dy=4mm, dz=1.4mm; Graded Ratio: 1.4

Peak SAR (extrapolated) = 14.8 W/kg

SAR(1 g) = 3.55 W/kg

Deviation(1 g) = -8.03%

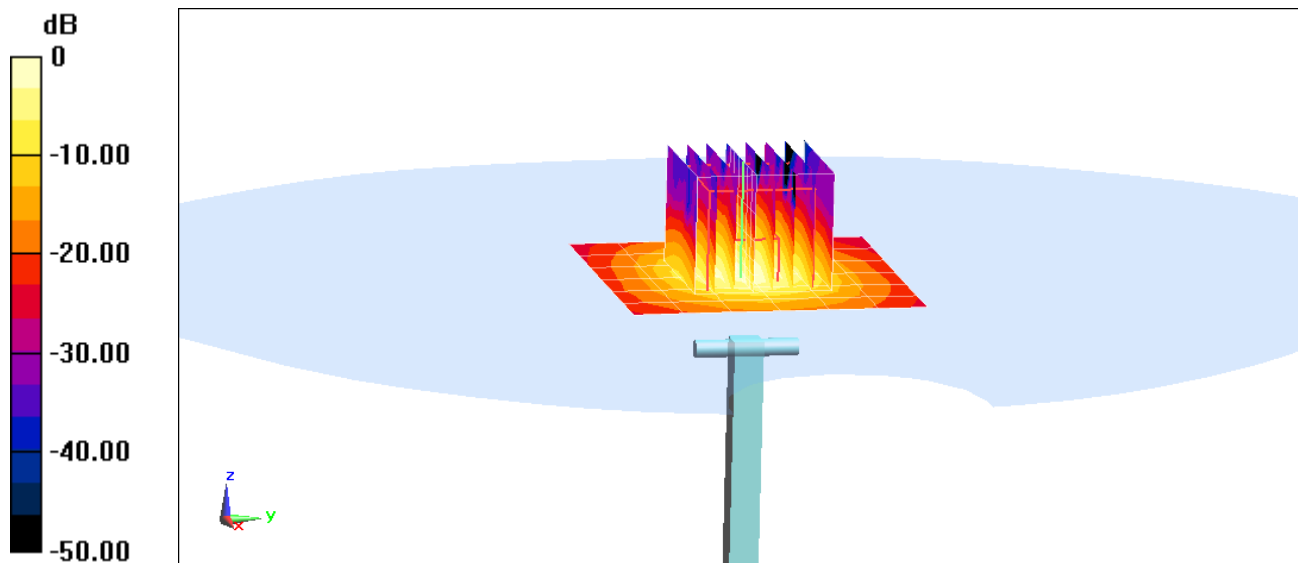

0 dB = 8.39 W/kg = 9.24 dBW/kg

PCTEST ENGINEERING LABORATORY, INC.

DUT: Dipole 5 GHz; Type: D5GHzV2; Serial: 1191

Communication System: UID 0, CW; Frequency: 5600 MHz; Duty Cycle: 1:1

Medium: 5 GHz Body Medium parameters used:

$f = 5600 \text{ MHz}$; $\sigma = 5.983 \text{ S/m}$; $\epsilon_r = 47.544$; $\rho = 1000 \text{ kg/m}^3$

Phantom section: Flat Section; Space: 1.0 cm

Test Date: 02-08-2016; Ambient Temp: 23.6°C; Tissue Temp: 22.3°C

Probe: EX3DV4 - SN7308; ConvF(3.92, 3.92, 3.92); Calibrated: 7/21/2015;

Sensor-Surface: 1.4mm (Mechanical Surface Detection)

Electronics: DAE4 Sn1322; Calibrated: 8/24/2015

Phantom: SAM 5.0 front; Type: QD000P40CD; Serial: TP:-1648

Measurement SW: DASY52, Version 52.8 (8);SEMCAD X Version 14.6.10 (7331)

5600 MHz System Verification at 17.0 dBm (50 mW)

Area Scan (7x7x1): Measurement grid: dx=10mm, dy=10mm

Zoom Scan (8x8x7)/Cube 0: Measurement grid: dx=4mm, dy=4mm, dz=1.4mm; Graded Ratio: 1.4

Peak SAR (extrapolated) = 17.5 W/kg

SAR(1 g) = 4.13 W/kg

Deviation(1 g) = 0.85%

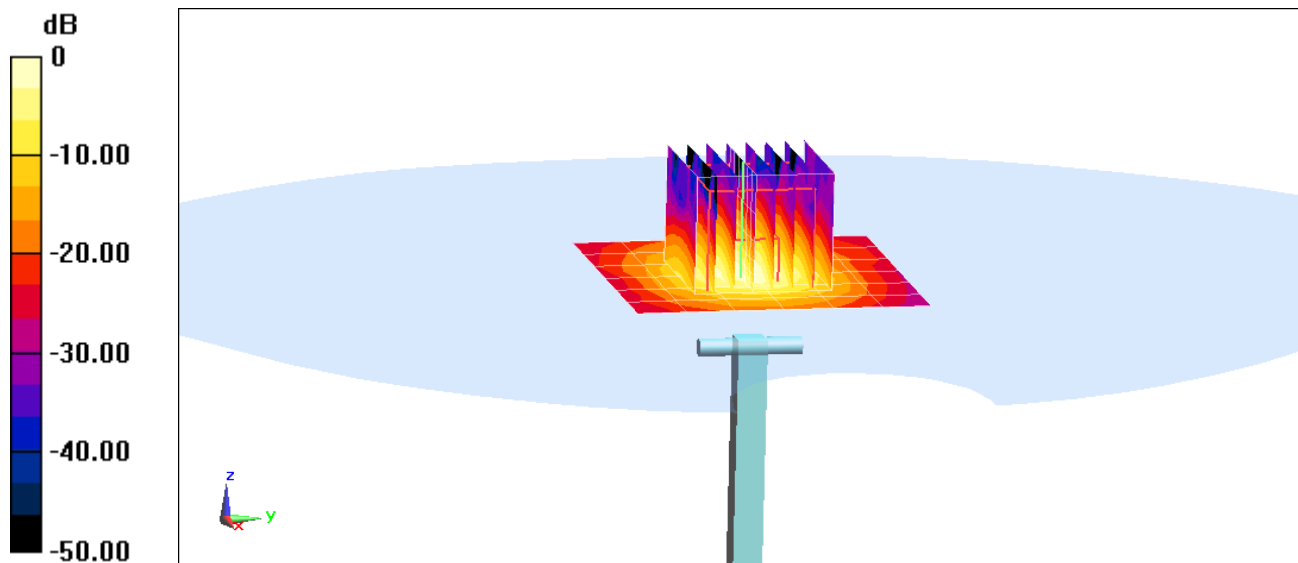

0 dB = 9.90 W/kg = 9.96 dBW/kg

PCTEST ENGINEERING LABORATORY, INC.

DUT: Dipole 5 GHz; Type: D5GHzV2; Serial: 1191

Communication System: UID 0, CW; Frequency: 5750 MHz; Duty Cycle: 1:1

Medium: 5 GHz Body Medium parameters used (interpolated):

$f = 5750 \text{ MHz}$; $\sigma = 6.199 \text{ S/m}$; $\epsilon_r = 47.217$; $\rho = 1000 \text{ kg/m}^3$

Phantom section: Flat Section; Space: 1.0 cm

Test Date: 02-08-2016; Ambient Temp: 23.6°C; Tissue Temp: 22.3°C

Probe: EX3DV4 - SN7308; ConvF(4.24, 4.24, 4.24); Calibrated: 7/21/2015;

Sensor-Surface: 1.4mm (Mechanical Surface Detection)

Electronics: DAE4 Sn1322; Calibrated: 8/24/2015

Phantom: SAM 5.0 front; Type: QD000P40CD; Serial: TP:-1648

Measurement SW: DASY52, Version 52.8 (8);SEMCAD X Version 14.6.10 (7331)

5750 MHz System Verification at 17.0 dBm (50 mW)

Area Scan (7x7x1): Measurement grid: dx=10mm, dy=10mm

Zoom Scan (8x8x7)/Cube 0: Measurement grid: dx=4mm, dy=4mm, dz=1.4mm; Graded Ratio: 1.4

Peak SAR (extrapolated) = 15.7 W/kg

SAR(1 g) = 3.6 W/kg

Deviation(1 g) = -6.61%

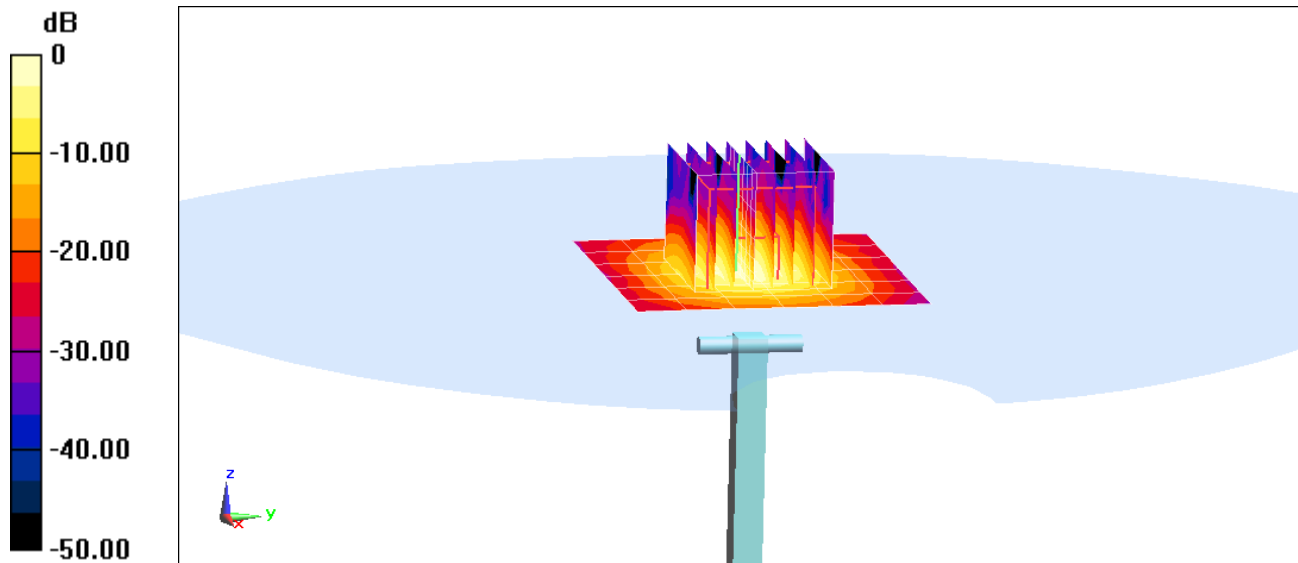

0 dB = 8.73 W/kg = 9.41 dBW/kg

PCTEST ENGINEERING LABORATORY, INC.

DUT: Dipole 750 MHz; Type: D750V3; Serial: 1054

Communication System: UID 0, CW; Frequency: 750 MHz; Duty Cycle: 1:1

Medium: 750 Body Medium parameters used (interpolated):

$f = 750 \text{ MHz}$; $\sigma = 0.956 \text{ S/m}$; $\epsilon_r = 55.118$; $\rho = 1000 \text{ kg/m}^3$

Phantom section: Flat Section; Space: 1.5 cm

Test Date: 02-27-2016; Ambient Temp: 19.8°C; Tissue Temp: 20.8°C

Probe: ES3DV3 - SN3333; ConvF(6.31, 6.31, 6.31); Calibrated: 10/29/2015;

Sensor-Surface: 3mm (Mechanical Surface Detection)

Electronics: DAE4 Sn1333; Calibrated: 10/27/2015

Phantom: SAM Front; Type: QD000P40CD; Serial: TP:1758

Measurement SW: DASY52, Version 52.8 (8);SEMCAD X Version 14.6.10 (7331)

750 MHz System Verification at 23.0 dBm (200 mW)

Area Scan (7x15x1): Measurement grid: dx=15mm, dy=15mm

Zoom Scan (5x5x7)/Cube 0: Measurement grid: dx=8mm, dy=8mm, dz=5mm

Peak SAR (extrapolated) = 2.48 W/kg

SAR(10 g) = 1.14 W/kg

Deviation(10 g) = 0.35 %

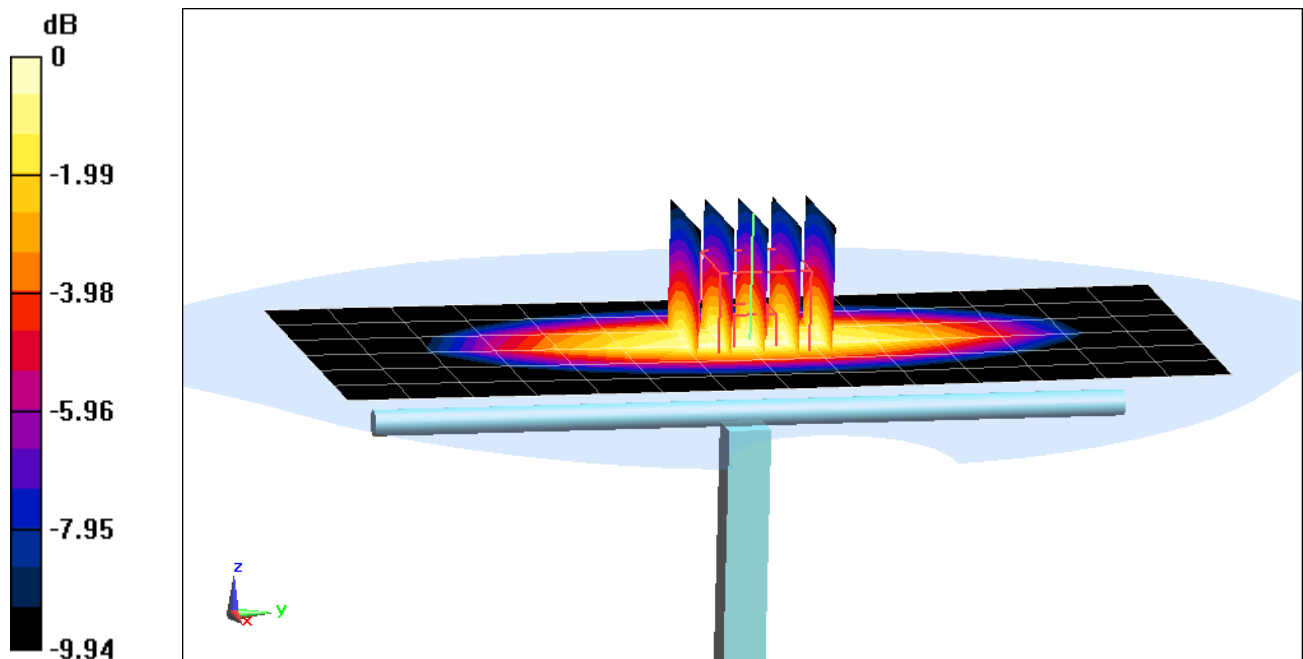

0 dB = 1.99 W/kg = 2.99 dBW/kg

PCTEST ENGINEERING LABORATORY, INC.

DUT: Dipole 835 MHz; Type: D835V2; Serial: 4d119

Communication System: UID 0, CW; Frequency: 835 MHz; Duty Cycle: 1:1

Medium: 835 Body Medium parameters used:

$f = 835 \text{ MHz}$; $\sigma = 0.996 \text{ S/m}$; $\epsilon_r = 53.964$; $\rho = 1000 \text{ kg/m}^3$

Phantom section: Flat Section; Space: 1.5 cm

Test Date: 02-27-2016; Ambient Temp: 20.3°C; Tissue Temp: 19.2°C

Probe: ES3DV3 - SN3319; ConvF(6.07, 6.07, 6.07); Calibrated: 3/19/2015;

Sensor-Surface: 3mm (Mechanical Surface Detection)

Electronics: DAE4 Sn1368; Calibrated: 3/13/2015

Phantom: SAM with CRP v4.0; Type: QD000P40CD; Serial: TP:1800

Measurement SW: DASY52, Version 52.8 (8);SEMCAD X Version 14.6.10 (7331)

835 MHz System Verification at 23.0 dBm (200 mW)

Area Scan (7x14x1): Measurement grid: dx=15mm, dy=15mm

Zoom Scan (5x5x7)/Cube 0: Measurement grid: dx=8mm, dy=8mm, dz=5mm

Peak SAR (extrapolated) = 2.67 W/kg

SAR(10 g) = 1.21 W/kg

Deviation(10 g) = -0.17%

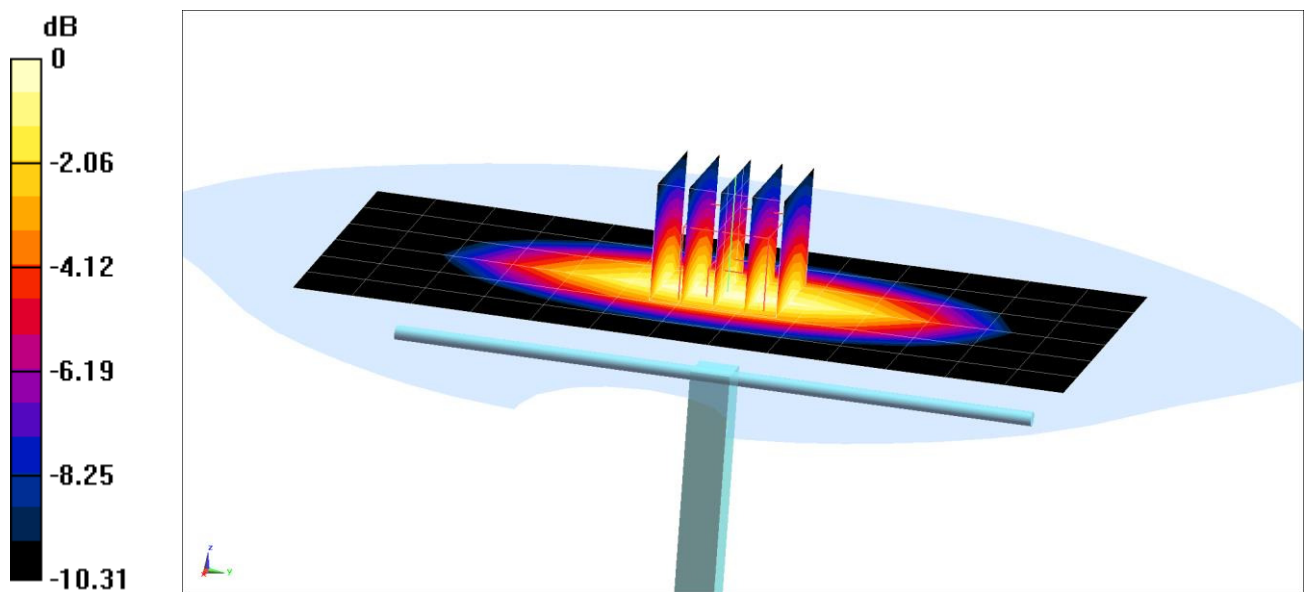

0 dB = 2.14 W/kg = 3.30 dBW/kg

PCTEST ENGINEERING LABORATORY, INC.

DUT: Dipole 1750 MHz; Type: D1750V2; Serial: 1051

Communication System: UID 0, CW; Frequency: 1750 MHz; Duty Cycle: 1:1

Medium: 1750 Body Medium parameters used:

$f = 1750 \text{ MHz}$; $\sigma = 1.483 \text{ S/m}$; $\epsilon_r = 52.104$; $\rho = 1000 \text{ kg/m}^3$

Phantom section: Flat Section; Space: 1.0 cm

Test Date: 02-27-2016; Ambient Temp: 20.8°C; Tissue Temp: 20.5°C

Probe: ES3DV2 - SN3022; ConvF(4.79, 4.79, 4.79); Calibrated: 8/26/2015;

Sensor-Surface: 3mm (Mechanical Surface Detection)

Electronics: DAE4 Sn1323; Calibrated: 9/16/2015

Phantom: SAM with CRP v4.0; Type: QD000P40CD; Serial: TP:1797

Measurement SW: DASY52, Version 52.8 (8); SEMCAD X Version 14.6.10 (7331)

1750 MHz System Verification at 20.0 dBm (100 mW)

Area Scan (7x9x1): Measurement grid: dx=15mm, dy=15mm

Zoom Scan (5x5x7)/Cube 0: Measurement grid: dx=8mm, dy=8mm, dz=5mm

Peak SAR (extrapolated) = 6.45 W/kg

SAR(10 g) = 1.95 W/kg

Deviation(10 g) = -2.50%

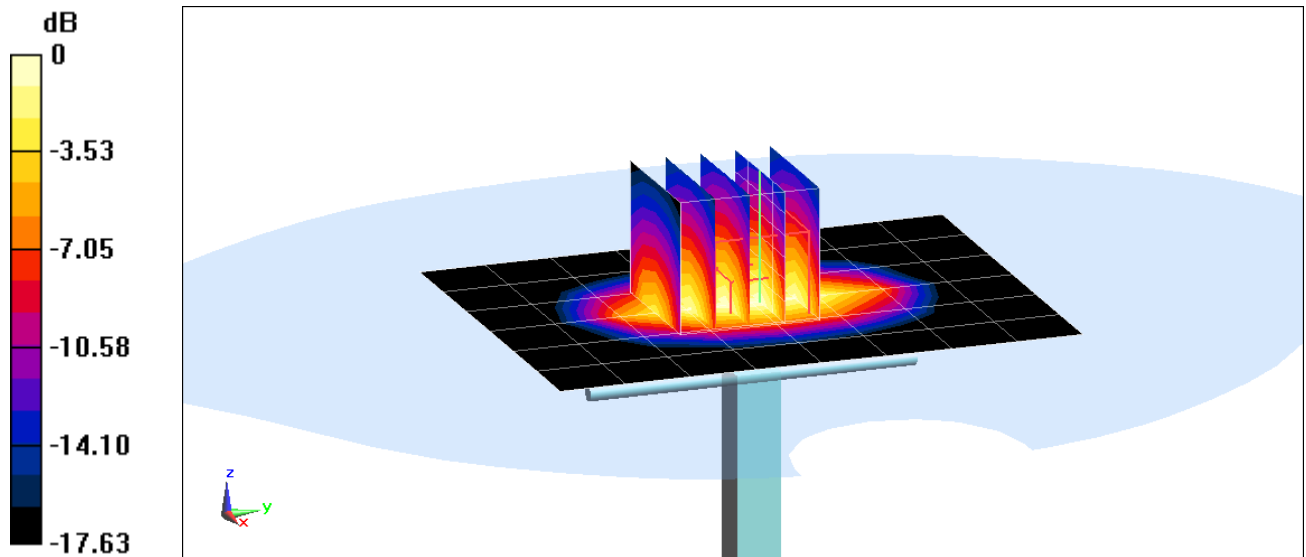

0 dB = 4.55 W/kg = 6.58 dBW/kg

PCTEST ENGINEERING LABORATORY, INC.

DUT: Dipole 1750 MHz; Type: D1750V2; Serial: 1051

Communication System: UID 0, CW; Frequency: 1750 MHz; Duty Cycle: 1:1

Medium: 1750 Body Medium parameters used:

$f = 1750 \text{ MHz}$; $\sigma = 1.473 \text{ S/m}$; $\epsilon_r = 52.27$; $\rho = 1000 \text{ kg/m}^3$

Phantom section: Flat Section; Space: 1.0 cm

Test Date: 03-03-2016; Ambient Temp: 24.3°C; Tissue Temp: 22.2°C

Probe: ES3DV3 - SN3351; ConvF(4.88, 4.88, 4.88); Calibrated: 6/22/2015;

Sensor-Surface: 3mm (Mechanical Surface Detection)

Electronics: DAE4 Sn1322; Calibrated: 8/24/2015

Phantom: SAM 5.0 front; Type: QD000P40CD; Serial: TP:-1648

Measurement SW: DASY52, Version 52.8 (8);SEMCAD X Version 14.6.10 (7331)

1750 MHz System Verification at 20.0 dBm (100 mW)

Area Scan (7x9x1): Measurement grid: dx=15mm, dy=15mm

Zoom Scan (5x6x7)/Cube 0: Measurement grid: dx=8mm, dy=8mm, dz=5mm

Peak SAR (extrapolated) = 6.59 W/kg

SAR(10 g) = 2.05 W/kg

Deviation(10 g) = 2.50%

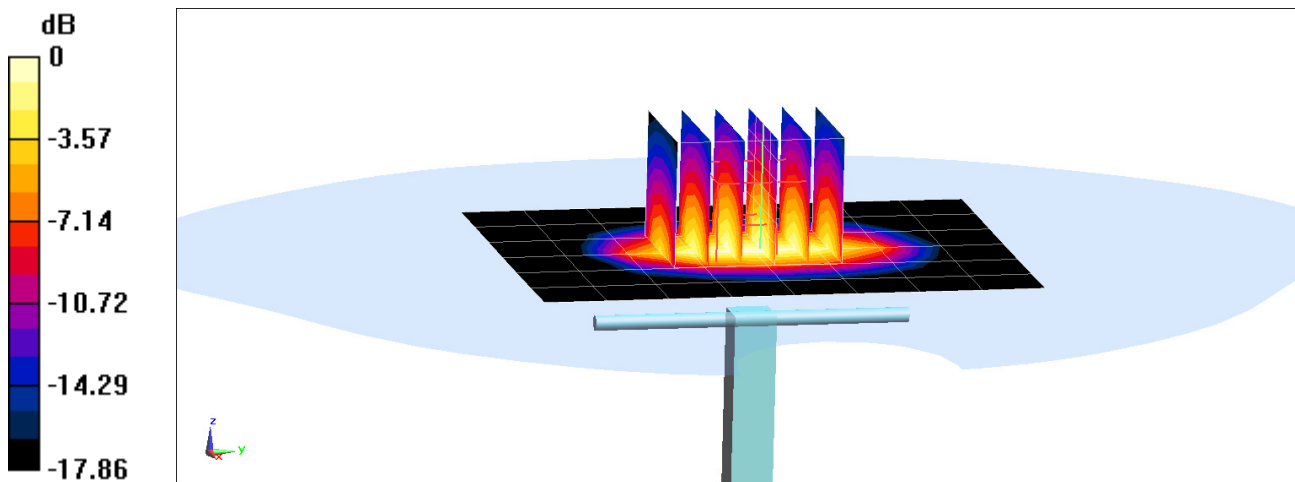

0 dB = 4.77 W/kg = 6.79 dBW/kg

PCTEST ENGINEERING LABORATORY, INC.

DUT: Dipole 1900 MHz; Type: D1900V2; Serial: 5d149

Communication System: UID 0, CW; Frequency: 1900 MHz; Duty Cycle: 1:1
Medium: 1900 Body Medium parameters used (interpolated):
 $f = 1900 \text{ MHz}$; $\sigma = 1.563 \text{ S/m}$; $\epsilon_r = 52.918$; $\rho = 1000 \text{ kg/m}^3$
Phantom section: Flat Section; Space: 1.0 cm

Test Date: 03-03-2016; Ambient Temp: 22.2°C; Tissue Temp: 21.4°C

Probe: ES3DV3 - SN3334; ConvF(4.84, 4.84, 4.84); Calibrated: 11/17/2015;
Sensor-Surface: 3mm (Mechanical Surface Detection)
Electronics: DAE4 Sn1415; Calibrated: 11/11/2015
Phantom: SAM Front; Type: SAM; Serial: 1686
Measurement SW: DASY52, Version 52.8 (8);SEMCAD X Version 14.6.10 (7331)

1900 MHz System Verification at 20.0 dBm (100 mW)

Area Scan (7x10x1): Measurement grid: dx=15mm, dy=15mm
Zoom Scan (5x5x7)/Cube 0: Measurement grid: dx=8mm, dy=8mm, dz=5mm
Peak SAR (extrapolated) = 6.82 W/kg
SAR(10 g) = 1.99 W/kg
Deviation(10 g) = -8.72%

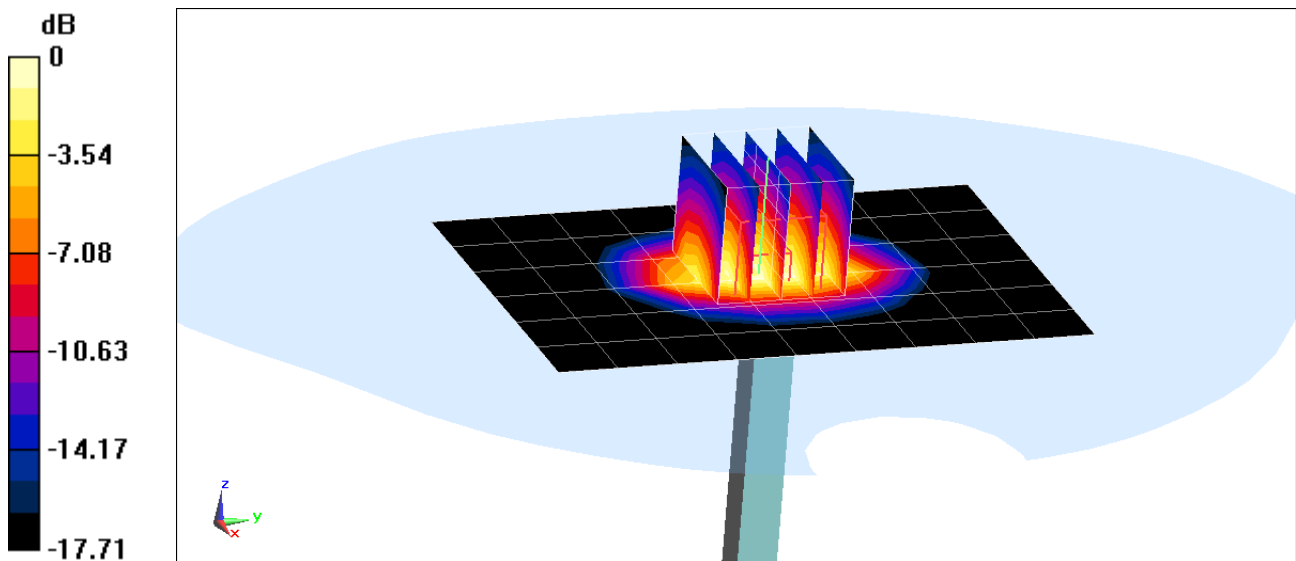

0 dB = 4.86 W/kg = 6.87 dBW/kg

PCTEST ENGINEERING LABORATORY, INC.

DUT: Dipole 2300 MHz; Type: D2300V2; Serial: 1064

Communication System: UID 0, CW; Frequency: 2300 MHz; Duty Cycle: 1:1

Medium: 2300 Body Medium parameters used:

$f = 2300$ MHz; $\sigma = 1.813$ S/m; $\epsilon_r = 51.561$; $\rho = 1000$ kg/m³

Phantom section: Flat Section; Space: 1.0 cm

Test Date: 03-03-2016; Ambient Temp: 22.5°C; Tissue Temp: 21.5°C

Probe: ES3DV2 - SN3022; ConvF(4.32, 4.32, 4.32); Calibrated: 8/26/2015;

Sensor-Surface: 3mm (Mechanical Surface Detection)

Electronics: DAE4 Sn1323; Calibrated: 9/16/2015

Phantom: SAM Left; Type: QD000P40CC; Serial: TP: 1375

Measurement SW: DASY52, Version 52.8 (8); SEMCAD X Version 14.6.10 (7331)

2300 MHz System Verification at 20.0 dBm (100 mW)

Area Scan (8x9x1): Measurement grid: dx=12mm, dy=12mm

Zoom Scan (7x7x7)/Cube 0: Measurement grid: dx=5mm, dy=5mm, dz=5mm

Peak SAR (extrapolated) = 9.65 W/kg

SAR(10 g) = 2.36 W/kg

Deviation(10 g) = 7.27%

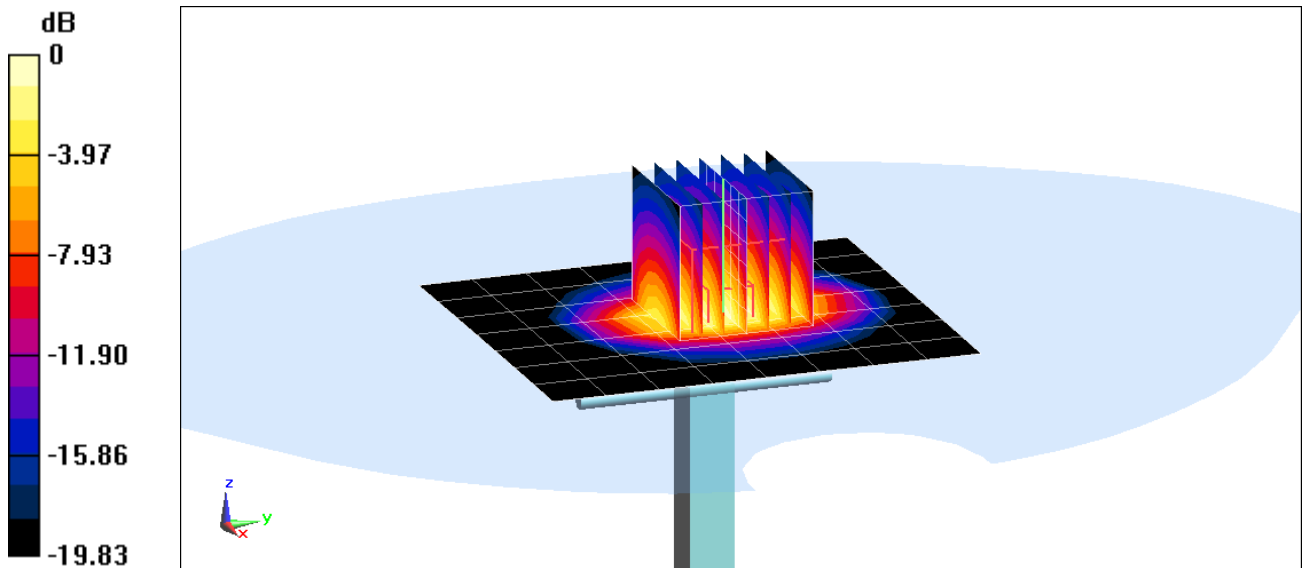

0 dB = 6.47 W/kg = 8.11 dBW/kg

PCTEST ENGINEERING LABORATORY, INC.

DUT: Dipole 2450 MHz; Type: D2450V2; Serial: 719

Communication System: UID 0, CW; Frequency: 2450 MHz; Duty Cycle: 1:1

Medium: 2450 Body Medium parameters used:

$f = 2450 \text{ MHz}$; $\sigma = 1.989 \text{ S/m}$; $\epsilon_r = 50.648$; $\rho = 1000 \text{ kg/m}^3$

Phantom section: Flat Section; Space: 1.0 cm

Test Date: 02-26-2016; Ambient Temp: 21.5°C; Tissue Temp: 22.5°C

Probe: ES3DV3 - SN3263; ConvF(4.28, 4.28, 4.28); Calibrated: 5/20/2015;

Sensor-Surface: 3mm (Mechanical Surface Detection)

Electronics: DAE4 Sn859; Calibrated: 6/17/2015

Phantom: SAM with CRP v5.0 (Right); Type: QD000P40CD; Serial: TP:1759

Measurement SW: DASY52, Version 52.8 (8);SEMCAD X Version 14.6.10 (7331)

2450 MHz System Verification at 20.0 dBm (100 mW)

Area Scan (8x9x1): Measurement grid: dx=12mm, dy=12mm

Zoom Scan (7x7x7)/Cube 0: Measurement grid: dx=5mm, dy=5mm, dz=5mm

Peak SAR (extrapolated) = 10.8 W/kg

SAR(10 g) = 2.31 W/kg

Deviation(10 g) = -4.94%

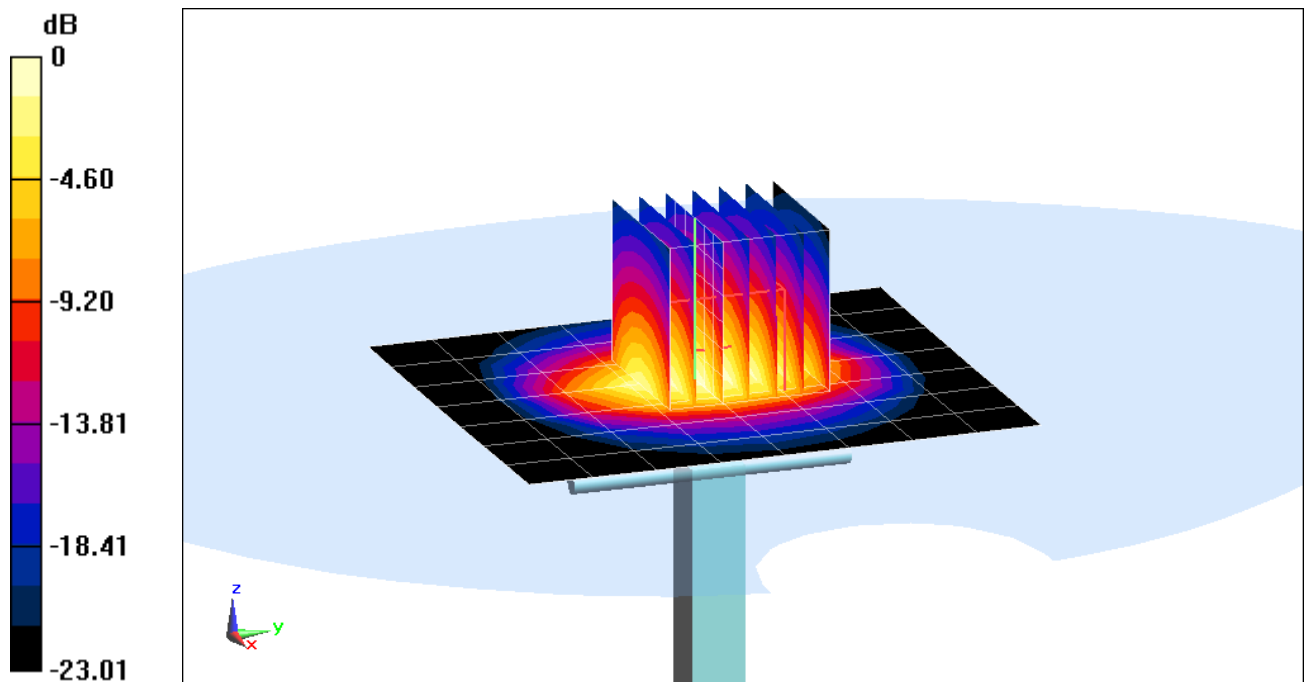

0 dB = 6.61 W/kg = 8.20 dBW/kg

APPENDIX C: PROBE CALIBRATION



Accreditation No.: **SCS 0108**

Accredited by the Swiss Accreditation Service (SAS)
The Swiss Accreditation Service is one of the signatories to the EA
Multilateral Agreement for the recognition of calibration certificates

Client **PC Test**

Certificate No: **D750V3-1054_Mar15**

CALIBRATION CERTIFICATE

Object **D750V3 - SN:1054**

Calibration procedure(s) **QA CAL-05.v9
Calibration procedure for dipole validation kits above 700 MHz**

*CCV
3/26/15*

Calibration date: **March 11, 2015**

This calibration certificate documents the traceability to national standards, which realize the physical units of measurements (SI).
The measurements and the uncertainties with confidence probability are given on the following pages and are part of the certificate.

All calibrations have been conducted in the closed laboratory facility: environment temperature (22 ± 3)°C and humidity < 70%.

Calibration Equipment used (M&TE critical for calibration)

Primary Standards	ID #	Cal Date (Certificate No.)	Scheduled Calibration
Power meter EPM-442A	GB37480704	07-Oct-14 (No. 217-02020)	Oct-15
Power sensor HP 8481A	US37292783	07-Oct-14 (No. 217-02020)	Oct-15
Power sensor HP 8481A	MY41092317	07-Oct-14 (No. 217-02021)	Oct-15
Reference 20 dB Attenuator	SN: 5058 (20k)	03-Apr-14 (No. 217-01918)	Apr-15
Type-N mismatch combination	SN: 5047.2 / 06327	03-Apr-14 (No. 217-01921)	Apr-15
Reference Probe ES3DV3	SN: 3205	30-Dec-14 (No. ES3-3205_Dec14)	Dec-15
DAE4	SN: 601	18-Aug-14 (No. DAE4-601_Aug14)	Aug-15
Secondary Standards	ID #	Check Date (in house)	Scheduled Check
RF generator R&S SMT-06	100005	04-Aug-99 (in house check Oct-13)	In house check: Oct-16
Network Analyzer HP 8753E	US37390585 S4206	18-Oct-01 (in house check Oct-14)	In house check: Oct-15

Calibrated by: **Name** Michael Weber **Function** Laboratory Technician

Signature

Approved by: **Name** Katja Pokovic **Function** Technical Manager

Issued: March 11, 2015

This calibration certificate shall not be reproduced except in full without written approval of the laboratory.



Accredited by the Swiss Accreditation Service (SAS)
The Swiss Accreditation Service is one of the signatories to the EA
Multilateral Agreement for the recognition of calibration certificates

Accreditation No.: **SCS 0108**

Glossary:

TSL	tissue simulating liquid
ConvF	sensitivity in TSL / NORM x,y,z
N/A	not applicable or not measured

Calibration is Performed According to the Following Standards:

- IEEE Std 1528-2013, "IEEE Recommended Practice for Determining the Peak Spatial-Averaged Specific Absorption Rate (SAR) in the Human Head from Wireless Communications Devices: Measurement Techniques", June 2013
- IEC 62209-1, "Procedure to measure the Specific Absorption Rate (SAR) for hand-held devices used in close proximity to the ear (frequency range of 300 MHz to 3 GHz)", February 2005
- KDB 865664, "SAR Measurement Requirements for 100 MHz to 6 GHz"

Additional Documentation:

- DASY4/5 System Handbook

Methods Applied and Interpretation of Parameters:

- Measurement Conditions:* Further details are available from the Validation Report at the end of the certificate. All figures stated in the certificate are valid at the frequency indicated.
- Antenna Parameters with TSL:* The dipole is mounted with the spacer to position its feed point exactly below the center marking of the flat phantom section, with the arms oriented parallel to the body axis.
- Feed Point Impedance and Return Loss:* These parameters are measured with the dipole positioned under the liquid filled phantom. The impedance stated is transformed from the measurement at the SMA connector to the feed point. The Return Loss ensures low reflected power. No uncertainty required.
- Electrical Delay:* One-way delay between the SMA connector and the antenna feed point. No uncertainty required.
- SAR measured:* SAR measured at the stated antenna input power.
- SAR normalized:* SAR as measured, normalized to an input power of 1 W at the antenna connector.
- SAR for nominal TSL parameters:* The measured TSL parameters are used to calculate the nominal SAR result.

The reported uncertainty of measurement is stated as the standard uncertainty of measurement multiplied by the coverage factor $k=2$, which for a normal distribution corresponds to a coverage probability of approximately 95%.

Measurement Conditions

DASY system configuration, as far as not given on page 1.

DASY Version	DASY5	V52.8.8
Extrapolation	Advanced Extrapolation	
Phantom	Modular Flat Phantom	
Distance Dipole Center - TSL	15 mm	with Spacer
Zoom Scan Resolution	dx, dy, dz = 5 mm	
Frequency	750 MHz \pm 1 MHz	

Head TSL parameters

The following parameters and calculations were applied.

	Temperature	Permittivity	Conductivity
Nominal Head TSL parameters	22.0 °C	41.9	0.89 mho/m
Measured Head TSL parameters	(22.0 \pm 0.2) °C	40.8 \pm 6 %	0.90 mho/m \pm 6 %
Head TSL temperature change during test	< 0.5 °C	----	----

SAR result with Head TSL

SAR averaged over 1 cm³ (1 g) of Head TSL	Condition	
SAR measured	250 mW input power	2.10 W/kg
SAR for nominal Head TSL parameters	normalized to 1W	8.28 W/kg \pm 17.0 % (k=2)

SAR averaged over 10 cm³ (10 g) of Head TSL	condition	
SAR measured	250 mW input power	1.37 W/kg
SAR for nominal Head TSL parameters	normalized to 1W	5.42 W/kg \pm 16.5 % (k=2)

Body TSL parameters

The following parameters and calculations were applied.

	Temperature	Permittivity	Conductivity
Nominal Body TSL parameters	22.0 °C	55.5	0.96 mho/m
Measured Body TSL parameters	(22.0 \pm 0.2) °C	54.7 \pm 6 %	0.99 mho/m \pm 6 %
Body TSL temperature change during test	< 0.5 °C	----	----

SAR result with Body TSL

SAR averaged over 1 cm³ (1 g) of Body TSL	Condition	
SAR measured	250 mW input power	2.19 W/kg
SAR for nominal Body TSL parameters	normalized to 1W	8.53 W/kg \pm 17.0 % (k=2)

SAR averaged over 10 cm³ (10 g) of Body TSL	condition	
SAR measured	250 mW input power	1.45 W/kg
SAR for nominal Body TSL parameters	normalized to 1W	5.68 W/kg \pm 16.5 % (k=2)

Appendix (Additional assessments outside the scope of SCS 0108)

Antenna Parameters with Head TSL

Impedance, transformed to feed point	54.8 Ω - 0.6 j Ω
Return Loss	- 26.7 dB

Antenna Parameters with Body TSL

Impedance, transformed to feed point	48.8 Ω - 2.6 j Ω
Return Loss	- 30.6 dB

General Antenna Parameters and Design

Electrical Delay (one direction)	1.033 ns
----------------------------------	----------

After long term use with 100W radiated power, only a slight warming of the dipole near the feedpoint can be measured.

The dipole is made of standard semirigid coaxial cable. The center conductor of the feeding line is directly connected to the second arm of the dipole. The antenna is therefore short-circuited for DC-signals. On some of the dipoles, small end caps are added to the dipole arms in order to improve matching when loaded according to the position as explained in the "Measurement Conditions" paragraph. The SAR data are not affected by this change. The overall dipole length is still according to the Standard.

No excessive force must be applied to the dipole arms, because they might bend or the soldered connections near the feedpoint may be damaged.

Additional EUT Data

Manufactured by	SPEAG
Manufactured on	November 08, 2011

DASY5 Validation Report for Head TSL

Date: 11.03.2015

Test Laboratory: SPEAG, Zurich, Switzerland

DUT: Dipole 750 MHz; Type: D750V3; Serial: D750V3 - SN:1054

Communication System: UID 0 - CW; Frequency: 750 MHz

Medium parameters used: $f = 750$ MHz; $\sigma = 0.9$ S/m; $\epsilon_r = 40.8$; $\rho = 1000$ kg/m³

Phantom section: Flat Section

Measurement Standard: DASY5 (IEEE/IEC/ANSI C63.19-2011)

DASY52 Configuration:

- Probe: ES3DV3 - SN3205; ConvF(6.44, 6.44, 6.44); Calibrated: 30.12.2014;
- Sensor-Surface: 3mm (Mechanical Surface Detection)
- Electronics: DAE4 Sn601; Calibrated: 18.08.2014
- Phantom: Flat Phantom 4.9L; Type: QD000P49AA; Serial: 1001
- DASY52 52.8.8(1222); SEMCAD X 14.6.10(7331)

Dipole Calibration for Head Tissue/Pin=250 mW, d=15mm/Zoom Scan (7x7x7)/Cube 0:

Measurement grid: dx=5mm, dy=5mm, dz=5mm

Reference Value = 54.06 V/m; Power Drift = -0.01 dB

Peak SAR (extrapolated) = 3.16 W/kg

SAR(1 g) = 2.1 W/kg; SAR(10 g) = 1.37 W/kg

Maximum value of SAR (measured) = 2.46 W/kg

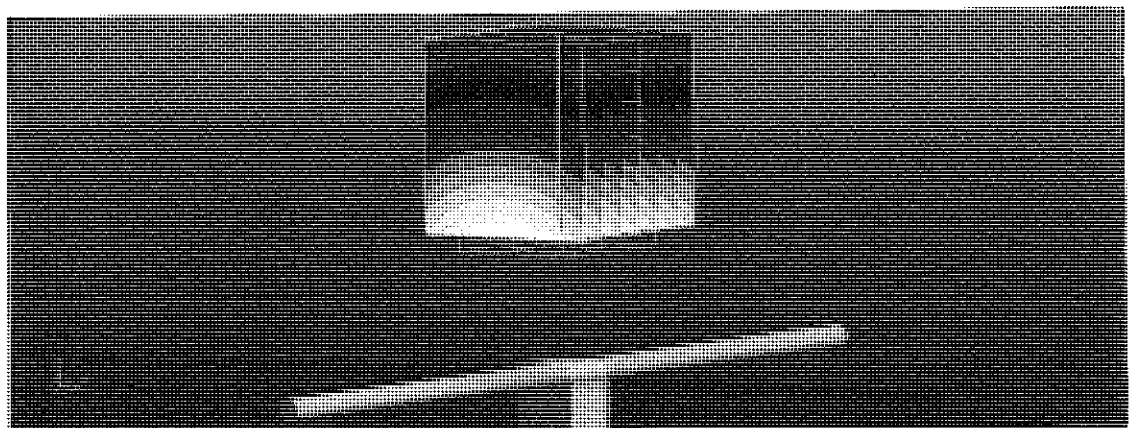
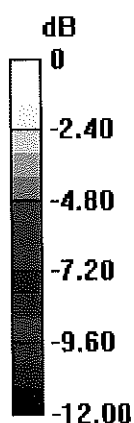

0 dB = 2.46 W/kg = 3.91 dBW/kg

Impedance Measurement Plot for Head TSL

11 Mar 2015 12:42:05

CH1 S11 1 U FS 1: 54.844 Ω -552.73 m Ω 383.92 pF 750.000 000 MHz

*
Del
CA
Avg
16
H1d

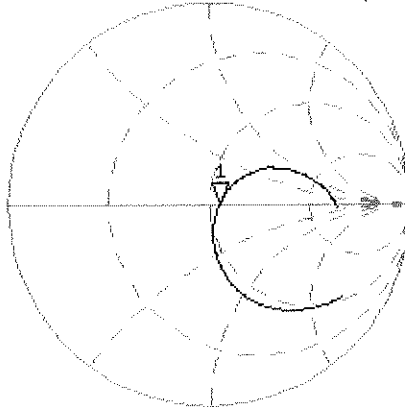

CH2 S11 LOG 5 dB/REF -20 dB 1:-26.654 dB 750.000 000 MHz

Del
CA
Avg
16
H1d

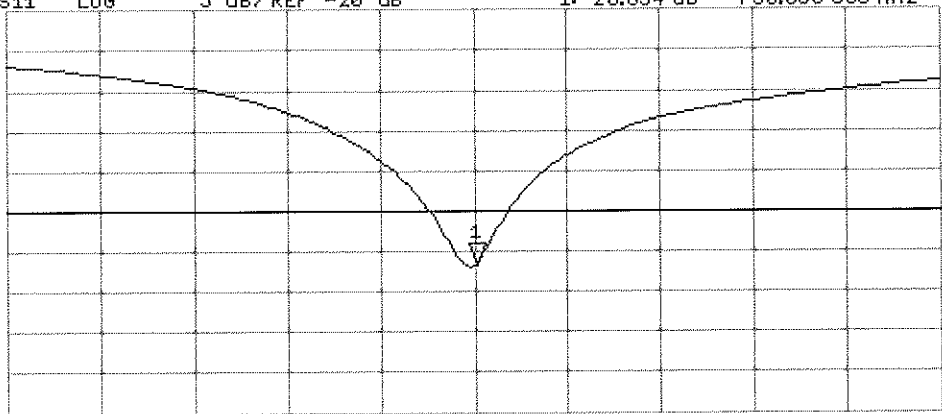

START 550.000 000 MHz

STOP 950.000 000 MHz

DASY5 Validation Report for Body TSL

Date: 11.03.2015

Test Laboratory: SPEAG, Zurich, Switzerland

DUT: Dipole 750 MHz; Type: D750V3; Serial: D750V3 - SN:1054

Communication System: UID 0 - CW; Frequency: 750 MHz

Medium parameters used: $f = 750$ MHz; $\sigma = 0.99$ S/m; $\epsilon_r = 54.7$; $\rho = 1000$ kg/m³

Phantom section: Flat Section

Measurement Standard: DASY5 (IEEE/IEC/ANSI C63.19-2011)

DASY52 Configuration:

- Probe: ES3DV3 - SN3205; ConvF(6.21, 6.21, 6.21); Calibrated: 30.12.2014;
- Sensor-Surface: 3mm (Mechanical Surface Detection)
- Electronics: DAE4 Sn601; Calibrated: 18.08.2014
- Phantom: Flat Phantom 4.9L; Type: QD000P49AA; Serial: 1001
- DASY52 52.8.8(1222); SEMCAD X 14.6.10(7331)

Dipole Calibration for Body Tissue/Pin=250 mW, d=15mm/Zoom Scan (7x7x7)/Cube 0:

Measurement grid: dx=5mm, dy=5mm, dz=5mm

Reference Value = 52.35 V/m; Power Drift = 0.03 dB

Peak SAR (extrapolated) = 3.20 W/kg

SAR(1 g) = 2.19 W/kg; SAR(10 g) = 1.45 W/kg

Maximum value of SAR (measured) = 2.54 W/kg

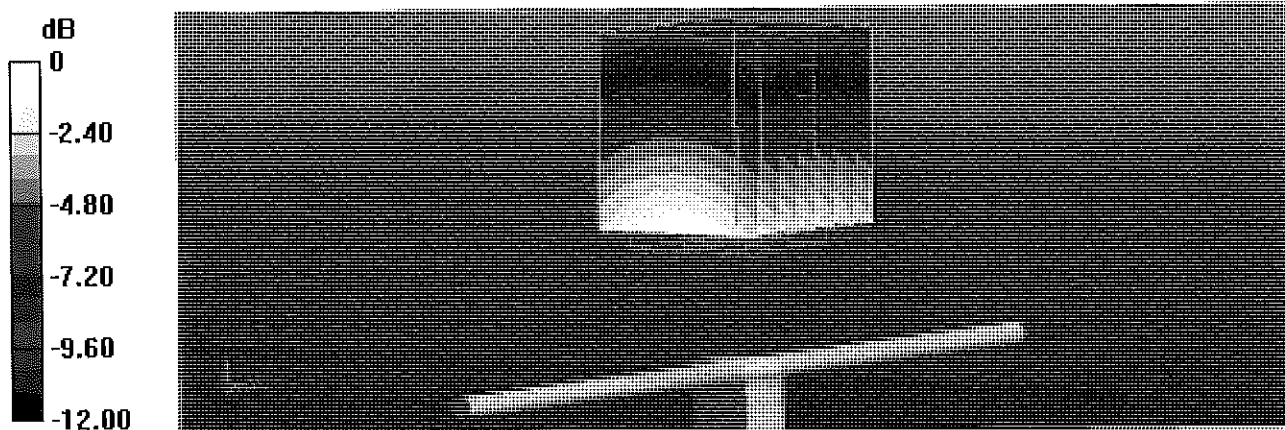

0 dB = 2.54 W/kg = 4.05 dBW/kg

Impedance Measurement Plot for Body TSL

11 Mar 2015 11:49:08
[CH1] S11 1 U FS 1: 48.779 Ω -2.6426 Ω 80.303 pF 750.000 000 MHz

*
De1
CA
Avg
16
H1d

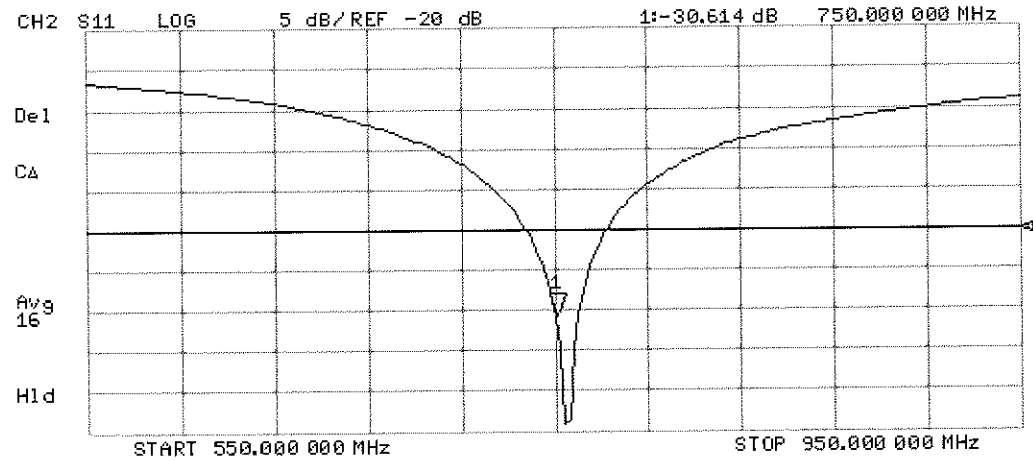
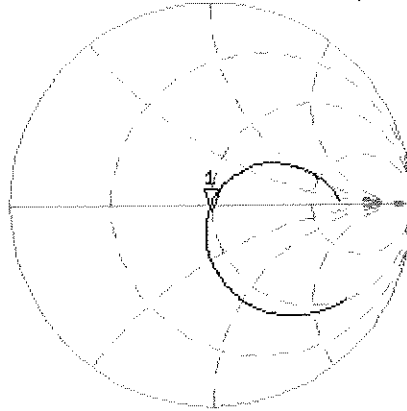



Accredited by the Swiss Accreditation Service (SAS)
The Swiss Accreditation Service is one of the signatories to the EA
Multilateral Agreement for the recognition of calibration certificates

Accreditation No.: **SCS 0108**

Client **PC Test**

Certificate No: **D835V2-4d133_Jul15**

CALIBRATION CERTIFICATE

Object **D835V2 - SN: 4d133**

Calibration procedure(s) **QA CAL-05.v9**
Calibration procedure for dipole validation kits above 700 MHz

PN ✓
8/4/15

Calibration date: **July 23, 2015**

This calibration certificate documents the traceability to national standards, which realize the physical units of measurements (SI).
The measurements and the uncertainties with confidence probability are given on the following pages and are part of the certificate.

All calibrations have been conducted in the closed laboratory facility: environment temperature (22 ± 3)°C and humidity < 70%.

Calibration Equipment used (M&TE critical for calibration)

Primary Standards	ID #	Cal Date (Certificate No.)	Scheduled Calibration
Power meter EPM-442A	GB37480704	07-Oct-14 (No. 217-02020)	Oct-15
Power sensor HP 8481A	US37292783	07-Oct-14 (No. 217-02020)	Oct-15
Power sensor HP 8481A	MY41092317	07-Oct-14 (No. 217-02021)	Oct-15
Reference 20 dB Attenuator	SN: 5058 (20k)	01-Apr-15 (No. 217-02131)	Mar-16
Type-N mismatch combination	SN: 5047.2 / 06327	01-Apr-15 (No. 217-02134)	Mar-16
Reference Probe ES3DV3	SN: 3205	30-Dec-14 (No. ES3-3205_Dec14)	Dec-15
DAE4	SN: 601	18-Aug-14 (No. DAE4-601_Aug14)	Aug-15
Secondary Standards	ID #	Check Date (in house)	Scheduled Check
RF generator R&S SMT-06	100005	04-Aug-99 (in house check Oct-13)	In house check: Oct-16
Network Analyzer HP 8753E	US37390585 S4206	18-Oct-01 (in house check Oct-14)	In house check: Oct-15

Calibrated by: **Michael Weber** Name: Michael Weber Function: Laboratory Technician

Signature
M. Weber

Approved by: **Katja Pokovic** Name: Katja Pokovic Function: Technical Manager

[Signature]

Issued: July 23, 2015

This calibration certificate shall not be reproduced except in full without written approval of the laboratory.



Accredited by the Swiss Accreditation Service (SAS)

The Swiss Accreditation Service is one of the signatories to the EA
Multilateral Agreement for the recognition of calibration certificates

Glossary:

TSL	tissue simulating liquid
ConvF	sensitivity in TSL / NORM x,y,z
N/A	not applicable or not measured

Calibration is Performed According to the Following Standards:

- IEEE Std 1528-2013, "IEEE Recommended Practice for Determining the Peak Spatial-Averaged Specific Absorption Rate (SAR) in the Human Head from Wireless Communications Devices: Measurement Techniques", June 2013
- IEC 62209-1, "Procedure to measure the Specific Absorption Rate (SAR) for hand-held devices used in close proximity to the ear (frequency range of 300 MHz to 3 GHz)", February 2005
- IEC 62209-2, "Procedure to determine the Specific Absorption Rate (SAR) for wireless communication devices used in close proximity to the human body (frequency range of 30 MHz to 6 GHz)", March 2010
- KDB 865664, "SAR Measurement Requirements for 100 MHz to 6 GHz"

Additional Documentation:

- DASY4/5 System Handbook

Methods Applied and Interpretation of Parameters:

- Measurement Conditions:* Further details are available from the Validation Report at the end of the certificate. All figures stated in the certificate are valid at the frequency indicated.
- Antenna Parameters with TSL:* The dipole is mounted with the spacer to position its feed point exactly below the center marking of the flat phantom section, with the arms oriented parallel to the body axis.
- Feed Point Impedance and Return Loss:* These parameters are measured with the dipole positioned under the liquid filled phantom. The impedance stated is transformed from the measurement at the SMA connector to the feed point. The Return Loss ensures low reflected power. No uncertainty required.
- Electrical Delay:* One-way delay between the SMA connector and the antenna feed point. No uncertainty required.
- SAR measured:* SAR measured at the stated antenna input power.
- SAR normalized:* SAR as measured, normalized to an input power of 1 W at the antenna connector.
- SAR for nominal TSL parameters:* The measured TSL parameters are used to calculate the nominal SAR result.

The reported uncertainty of measurement is stated as the standard uncertainty of measurement multiplied by the coverage factor $k=2$, which for a normal distribution corresponds to a coverage probability of approximately 95%.

Measurement Conditions

DASY system configuration, as far as not given on page 1.

DASY Version	DASY5	V52.8.8
Extrapolation	Advanced Extrapolation	
Phantom	Modular Flat Phantom	
Distance Dipole Center - TSL	15 mm	with Spacer
Zoom Scan Resolution	dx, dy, dz = 5 mm	
Frequency	835 MHz \pm 1 MHz	

Head TSL parameters

The following parameters and calculations were applied.

	Temperature	Permittivity	Conductivity
Nominal Head TSL parameters	22.0 °C	41.5	0.90 mho/m
Measured Head TSL parameters	(22.0 \pm 0.2) °C	42.4 \pm 6 %	0.92 mho/m \pm 6 %
Head TSL temperature change during test	< 0.5 °C	----	----

SAR result with Head TSL

SAR averaged over 1 cm³ (1 g) of Head TSL	Condition	
SAR measured	250 mW input power	2.31 W/kg
SAR for nominal Head TSL parameters	normalized to 1W	9.13 W/kg \pm 17.0 % (k=2)

SAR averaged over 10 cm³ (10 g) of Head TSL	condition	
SAR measured	250 mW input power	1.50 W/kg
SAR for nominal Head TSL parameters	normalized to 1W	5.94 W/kg \pm 16.5 % (k=2)

Body TSL parameters

The following parameters and calculations were applied.

	Temperature	Permittivity	Conductivity
Nominal Body TSL parameters	22.0 °C	55.2	0.97 mho/m
Measured Body TSL parameters	(22.0 \pm 0.2) °C	54.9 \pm 6 %	1.00 mho/m \pm 6 %
Body TSL temperature change during test	< 0.5 °C	----	----

SAR result with Body TSL

SAR averaged over 1 cm³ (1 g) of Body TSL	Condition	
SAR measured	250 mW input power	2.37 W/kg
SAR for nominal Body TSL parameters	normalized to 1W	9.25 W/kg \pm 17.0 % (k=2)

SAR averaged over 10 cm³ (10 g) of Body TSL	condition	
SAR measured	250 mW input power	1.55 W/kg
SAR for nominal Body TSL parameters	normalized to 1W	6.08 W/kg \pm 16.5 % (k=2)

Appendix (Additional assessments outside the scope of SCS 0108)

Antenna Parameters with Head TSL

Impedance, transformed to feed point	51.6 Ω - 1.6 j Ω
Return Loss	- 33.1 dB

Antenna Parameters with Body TSL

Impedance, transformed to feed point	48.0 Ω - 3.7 j Ω
Return Loss	- 27.4 dB

General Antenna Parameters and Design

Electrical Delay (one direction)	1.395 ns
----------------------------------	----------

After long term use with 100W radiated power, only a slight warming of the dipole near the feedpoint can be measured.

The dipole is made of standard semirigid coaxial cable. The center conductor of the feeding line is directly connected to the second arm of the dipole. The antenna is therefore short-circuited for DC-signals. On some of the dipoles, small end caps are added to the dipole arms in order to improve matching when loaded according to the position as explained in the "Measurement Conditions" paragraph. The SAR data are not affected by this change. The overall dipole length is still according to the Standard.

No excessive force must be applied to the dipole arms, because they might bend or the soldered connections near the feedpoint may be damaged.

Additional EUT Data

Manufactured by	SPEAG
Manufactured on	July 22, 2011

DASY5 Validation Report for Head TSL

Date: 22.07.2015

Test Laboratory: SPEAG, Zurich, Switzerland

DUT: Dipole 835 MHz; Type: D835V2; Serial: D835V2 - SN: 4d133

Communication System: UID 0 - CW; Frequency: 835 MHz

Medium parameters used: $f = 835$ MHz; $\sigma = 0.92$ S/m; $\epsilon_r = 42.4$; $\rho = 1000$ kg/m³

Phantom section: Flat Section

Measurement Standard: DASY5 (IEEE/IEC/ANSI C63.19-2011)

DASY52 Configuration:

- Probe: ES3DV3 - SN3205; ConvF(6.2, 6.2, 6.2); Calibrated: 30.12.2014;
- Sensor-Surface: 3mm (Mechanical Surface Detection)
- Electronics: DAE4 Sn601; Calibrated: 18.08.2014
- Phantom: Flat Phantom 4.9L; Type: QD000P49AA; Serial: 1001
- DASY52 52.8.8(1222); SEMCAD X 14.6.10(7331)

Dipole Calibration for Head Tissue/Pin=250 mW, d=15mm/Zoom Scan (7x7x7)/Cube 0:

Measurement grid: dx=5mm, dy=5mm, dz=5mm

Reference Value = 56.11 V/m; Power Drift = 0.00 dB

Peak SAR (extrapolated) = 3.44 W/kg

SAR(1 g) = 2.31 W/kg; SAR(10 g) = 1.5 W/kg

Maximum value of SAR (measured) = 2.70 W/kg

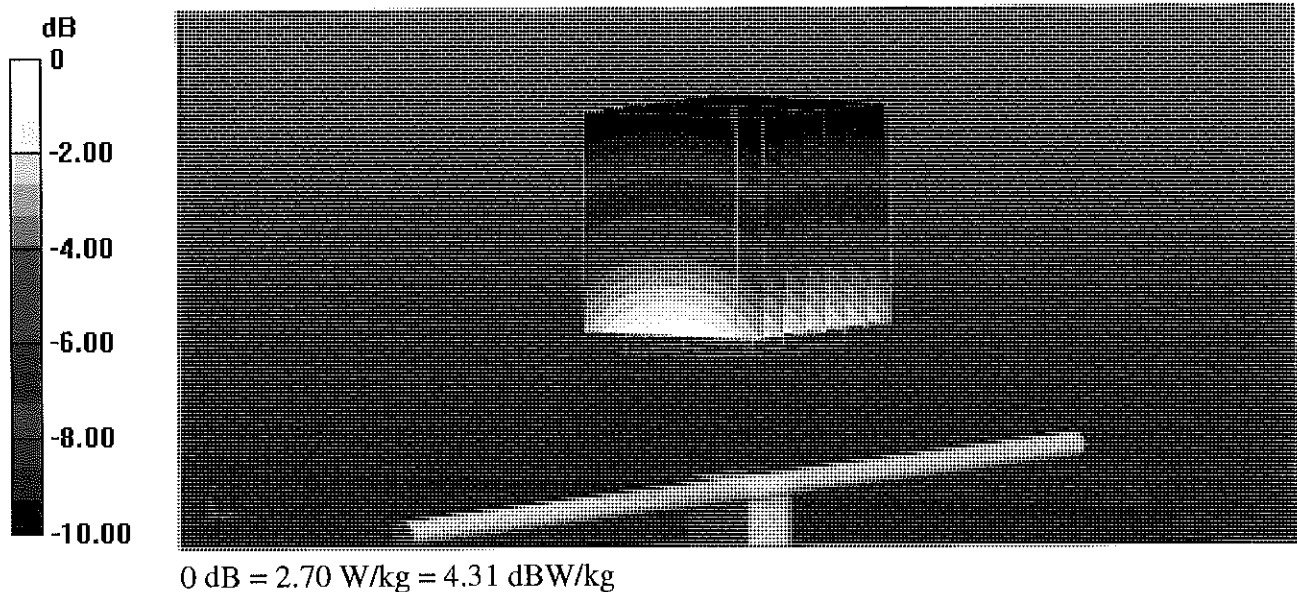

Impedance Measurement Plot for Head TSL

22 Jul 2015 09:20:37

CH1 S11 1 U FS 1: 51.563 Ω -1.6152 Ω 118.00 pF 835.000 000 MHz

*
Del
Cor

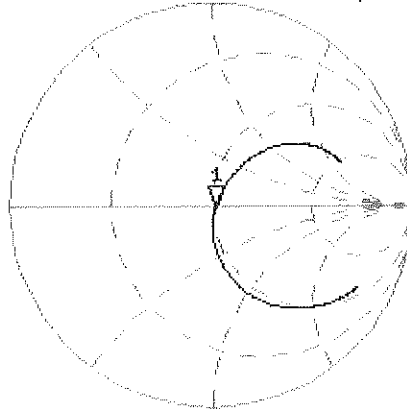

Avg
16

H1d

CH2 S11 LOG 5 dB/REF -20 dB 1: -33.086 dB 835.000 000 MHz

Cor

Avg
16

H1d

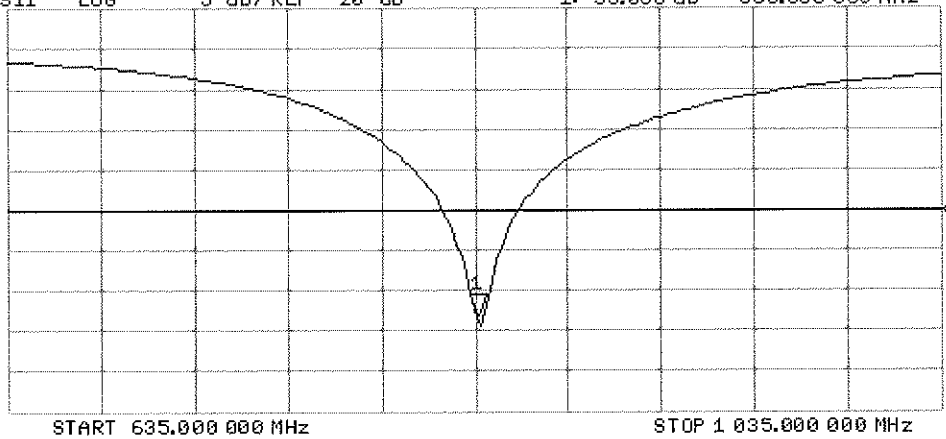

DASY5 Validation Report for Body TSL

Date: 23.07.2015

Test Laboratory: SPEAG, Zurich, Switzerland

DUT: Dipole 835 MHz; Type: D835V2; Serial: D835V2 - SN: 4d133

Communication System: UID 0 - CW; Frequency: 835 MHz

Medium parameters used: $f = 835 \text{ MHz}$; $\sigma = 1 \text{ S/m}$; $\epsilon_r = 54.9$; $\rho = 1000 \text{ kg/m}^3$

Phantom section: Flat Section

Measurement Standard: DASY5 (IEEE/IEC/ANSI C63.19-2011)

DASY52 Configuration:

- Probe: ES3DV3 - SN3205; ConvF(6.17, 6.17, 6.17); Calibrated: 30.12.2014;
- Sensor-Surface: 3mm (Mechanical Surface Detection)
- Electronics: DAE4 Sn601; Calibrated: 18.08.2014
- Phantom: Flat Phantom 4.9L; Type: QD000P49AA; Serial: 1001
- DASY52 52.8.8(1222); SEMCAD X 14.6.10(7331)

Dipole Calibration for Body Tissue/Pin=250 mW, d=15mm/Zoom Scan (7x7x7)/Cube 0:

Measurement grid: $dx=5\text{mm}$, $dy=5\text{mm}$, $dz=5\text{mm}$

Reference Value = 54.56 V/m; Power Drift = -0.02 dB

Peak SAR (extrapolated) = 3.50 W/kg

SAR(1 g) = 2.37 W/kg; SAR(10 g) = 1.55 W/kg

Maximum value of SAR (measured) = 2.77 W/kg

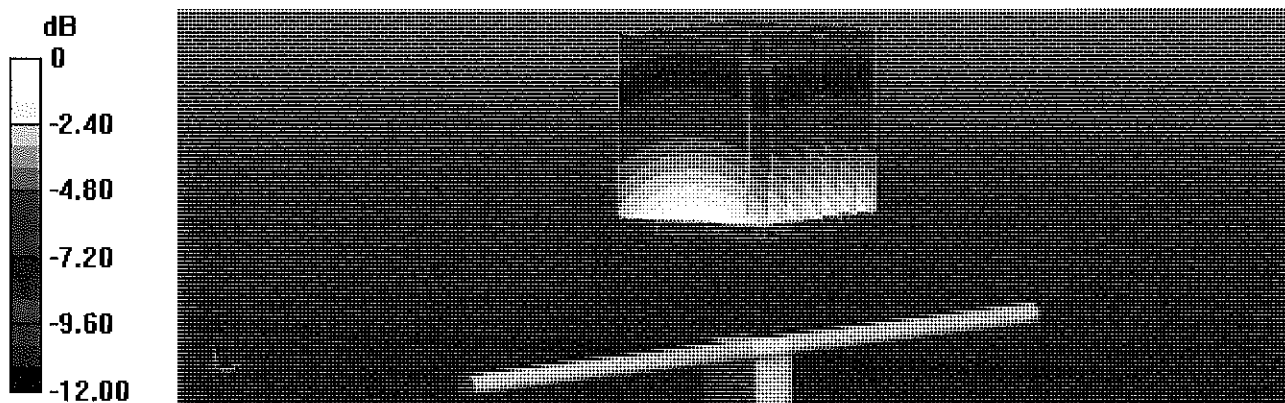

0 dB = 2.77 W/kg = 4.42 dBW/kg

Impedance Measurement Plot for Body TSL

23 Jul 2015 12:09:09

CH1 S11 1 U FS 1: 47.979 Ω -3.6699 Ω 51.937 pF 835.000 000 MHz

*
De1

CA

Avg
16

H1d

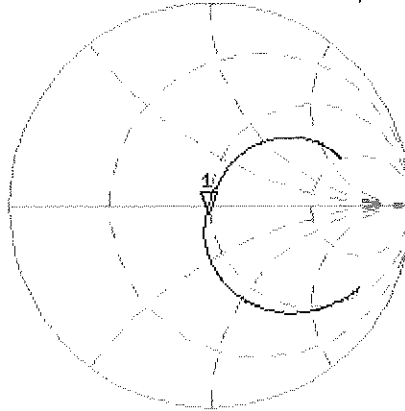

CH2 S11 LOG 5 dB/REF -20 dB 1: -27.388 dB 835.000 000 MHz

De1

CA

Avg
16

H1d

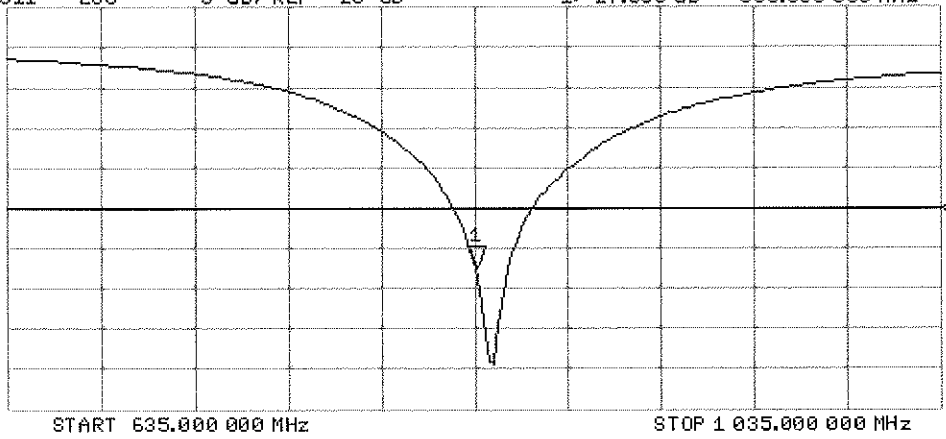



Accredited by the Swiss Accreditation Service (SAS)
The Swiss Accreditation Service is one of the signatories to the EA
Multilateral Agreement for the recognition of calibration certificates

Accreditation No.: **SCS 0108**

Client **PC Test**

Certificate No: **D1750V2-1051_Apr15**

CALIBRATION CERTIFICATE

Object **D1750V2 - SN:1051**

Calibration procedure(s) **QA CAL-05.v9
Calibration procedure for dipole validation kits above 700 MHz**

Calibration date: **April 15, 2015**

PM ✓
4/29/15

This calibration certificate documents the traceability to national standards, which realize the physical units of measurements (SI).
The measurements and the uncertainties with confidence probability are given on the following pages and are part of the certificate.

All calibrations have been conducted in the closed laboratory facility: environment temperature (22 ± 3)°C and humidity < 70%.

Calibration Equipment used (M&TE critical for calibration)

Primary Standards	ID #	Cal Date (Certificate No.)	Scheduled Calibration
Power meter EPM-442A	GB37480704	07-Oct-14 (No. 217-02020)	Oct-15
Power sensor HP 8481A	US37292783	07-Oct-14 (No. 217-02020)	Oct-15
Power sensor HP 8481A	MY41092317	07-Oct-14 (No. 217-02021)	Oct-15
Reference 20 dB Attenuator	SN: 5058 (20k)	01-Apr-15 (No. 217-02131)	Mar-16
Type-N mismatch combination	SN: 5047.2 / 06327	01-Apr-15 (No. 217-02134)	Mar-16
Reference Probe ES3DV3	SN: 3205	30-Dec-14 (No. ES3-3205_Dec14)	Dec-15
DAE4	SN: 601	18-Aug-14 (No. DAE4-601_Aug14)	Aug-15
Secondary Standards	ID #	Check Date (in house)	Scheduled Check
RF generator R&S SMT-06	100005	04-Aug-99 (in house check Oct-13)	In house check: Oct-16
Network Analyzer HP 8753E	US37390585 S4206	18-Oct-01 (in house check Oct-14)	In house check: Oct-15

Calibrated by: **Jeton Kastrati** (Name), **Laboratory Technician** (Function), [Signature]

Approved by: **Katja Pokovic** (Name), **Technical Manager** (Function), [Signature]

Issued: April 15, 2015

This calibration certificate shall not be reproduced except in full without written approval of the laboratory.



Accredited by the Swiss Accreditation Service (SAS)
The Swiss Accreditation Service is one of the signatories to the EA
Multilateral Agreement for the recognition of calibration certificates

Accreditation No.: **SCS 0108**

Glossary:

TSL	tissue simulating liquid
ConvF	sensitivity in TSL / NORM x,y,z
N/A	not applicable or not measured

Calibration is Performed According to the Following Standards:

- IEEE Std 1528-2013, "IEEE Recommended Practice for Determining the Peak Spatial-Averaged Specific Absorption Rate (SAR) in the Human Head from Wireless Communications Devices: Measurement Techniques", June 2013
- IEC 62209-1, "Procedure to measure the Specific Absorption Rate (SAR) for hand-held devices used in close proximity to the ear (frequency range of 300 MHz to 3 GHz)", February 2005
- KDB 865664, "SAR Measurement Requirements for 100 MHz to 6 GHz"

Additional Documentation:

- DASY4/5 System Handbook

Methods Applied and Interpretation of Parameters:

- Measurement Conditions:* Further details are available from the Validation Report at the end of the certificate. All figures stated in the certificate are valid at the frequency indicated.
- Antenna Parameters with TSL:* The dipole is mounted with the spacer to position its feed point exactly below the center marking of the flat phantom section, with the arms oriented parallel to the body axis.
- Feed Point Impedance and Return Loss:* These parameters are measured with the dipole positioned under the liquid filled phantom. The impedance stated is transformed from the measurement at the SMA connector to the feed point. The Return Loss ensures low reflected power. No uncertainty required.
- Electrical Delay:* One-way delay between the SMA connector and the antenna feed point. No uncertainty required.
- SAR measured:* SAR measured at the stated antenna input power.
- SAR normalized:* SAR as measured, normalized to an input power of 1 W at the antenna connector.
- SAR for nominal TSL parameters:* The measured TSL parameters are used to calculate the nominal SAR result.

The reported uncertainty of measurement is stated as the standard uncertainty of measurement multiplied by the coverage factor $k=2$, which for a normal distribution corresponds to a coverage probability of approximately 95%.

Measurement Conditions

DASY system configuration, as far as not given on page 1.

DASY Version	DASY5	V52.8.8
Extrapolation	Advanced Extrapolation	
Phantom	Modular Flat Phantom	
Distance Dipole Center - TSL	10 mm	with Spacer
Zoom Scan Resolution	dx, dy, dz = 5 mm	
Frequency	1750 MHz ± 1 MHz	

Head TSL parameters

The following parameters and calculations were applied.

	Temperature	Permittivity	Conductivity
Nominal Head TSL parameters	22.0 °C	40.1	1.37 mho/m
Measured Head TSL parameters	(22.0 ± 0.2) °C	38.9 ± 6 %	1.35 mho/m ± 6 %
Head TSL temperature change during test	< 0.5 °C	----	----

SAR result with Head TSL

SAR averaged over 1 cm ³ (1 g) of Head TSL	Condition	
SAR measured	250 mW input power	9.04 W/kg
SAR for nominal Head TSL parameters	normalized to 1W	36.2 W/kg ± 17.0 % (k=2)

SAR averaged over 10 cm ³ (10 g) of Head TSL	condition	
SAR measured	250 mW input power	4.80 W/kg
SAR for nominal Head TSL parameters	normalized to 1W	19.2 W/kg ± 16.5 % (k=2)

Body TSL parameters

The following parameters and calculations were applied.

	Temperature	Permittivity	Conductivity
Nominal Body TSL parameters	22.0 °C	53.4	1.49 mho/m
Measured Body TSL parameters	(22.0 ± 0.2) °C	51.5 ± 6 %	1.48 mho/m ± 6 %
Body TSL temperature change during test	< 0.5 °C	----	----

SAR result with Body TSL

SAR averaged over 1 cm ³ (1 g) of Body TSL	Condition	
SAR measured	250 mW input power	9.32 W/kg
SAR for nominal Body TSL parameters	normalized to 1W	37.1 W/kg ± 17.0 % (k=2)

SAR averaged over 10 cm ³ (10 g) of Body TSL	condition	
SAR measured	250 mW input power	5.01 W/kg
SAR for nominal Body TSL parameters	normalized to 1W	20.0 W/kg ± 16.5 % (k=2)

Appendix (Additional assessments outside the scope of SCS 0108)

Antenna Parameters with Head TSL

Impedance, transformed to feed point	51.3 Ω - 0.2 j Ω
Return Loss	- 37.5 dB

Antenna Parameters with Body TSL

Impedance, transformed to feed point	46.9 Ω + 0.3 j Ω
Return Loss	- 29.9 dB

General Antenna Parameters and Design

Electrical Delay (one direction)	1.221 ns
----------------------------------	----------

After long term use with 100W radiated power, only a slight warming of the dipole near the feedpoint can be measured.

The dipole is made of standard semirigid coaxial cable. The center conductor of the feeding line is directly connected to the second arm of the dipole. The antenna is therefore short-circuited for DC-signals. On some of the dipoles, small end caps are added to the dipole arms in order to improve matching when loaded according to the position as explained in the "Measurement Conditions" paragraph. The SAR data are not affected by this change. The overall dipole length is still according to the Standard.

No excessive force must be applied to the dipole arms, because they might bend or the soldered connections near the feedpoint may be damaged.

Additional EUT Data

Manufactured by	SPEAG
Manufactured on	February 19, 2010

DASY5 Validation Report for Head TSL

Date: 15.04.2015

Test Laboratory: SPEAG, Zurich, Switzerland

DUT: Dipole 1750 MHz; Type: D1750V2; Serial: D1750V2 - SN:1051

Communication System: UID 0 - CW; Frequency: 1750 MHz

Medium parameters used: $f = 1750$ MHz; $\sigma = 1.35$ S/m; $\epsilon_r = 38.9$; $\rho = 1000$ kg/m³

Phantom section: Flat Section

Measurement Standard: DASY5 (IEEE/IEC/ANSI C63.19-2011)

DASY52 Configuration:

- Probe: ES3DV3 - SN3205; ConvF(5.2, 5.2, 5.2); Calibrated: 30.12.2014;
- Sensor-Surface: 3mm (Mechanical Surface Detection)
- Electronics: DAE4 Sn601; Calibrated: 18.08.2014
- Phantom: Flat Phantom 5.0 (front); Type: QD000P50AA; Serial: 1001
- DASY52 52.8.8(1222); SEMCAD X 14.6.10(7331)

Dipole Calibration for Head Tissue/Pin=250 mW, d=10mm/Zoom Scan (7x7x7)/Cube 0:

Measurement grid: dx=5mm, dy=5mm, dz=5mm

Reference Value = 94.99 V/m; Power Drift = 0.06 dB

Peak SAR (extrapolated) = 16.3 W/kg

SAR(1 g) = 9.04 W/kg; SAR(10 g) = 4.8 W/kg

Maximum value of SAR (measured) = 11.5 W/kg

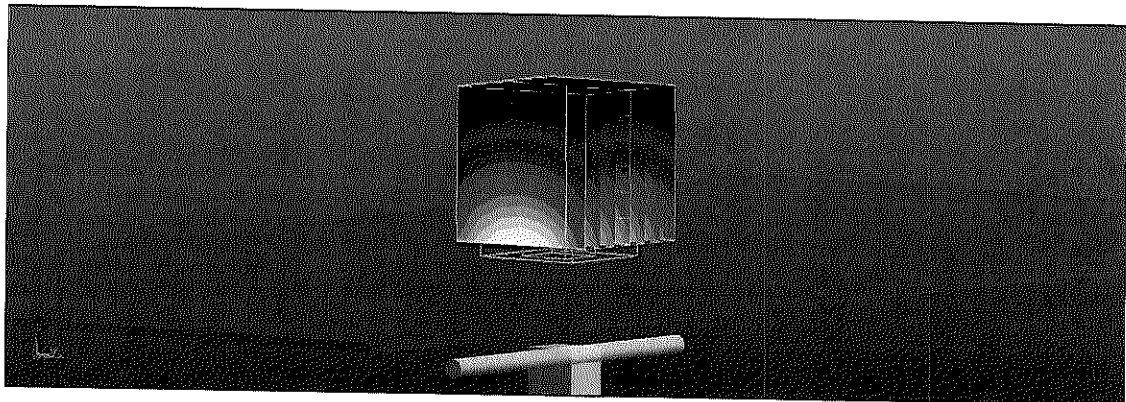
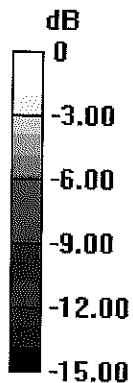

0 dB = 11.5 W/kg = 10.61 dBW/kg

Impedance Measurement Plot for Head TSL

[CH1] S11 1 U FS 3: 51.330 Ω -248.05 m Ω 366.65 pF 15 Apr 2015 12:25:31
 1 750.000 000 MHz

*
 Del
 C Δ
 Avg
 15
 H1d

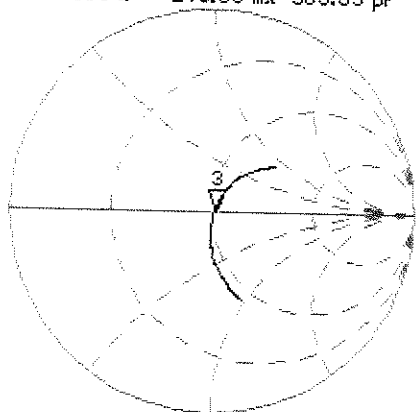

CH2 S11 LOG 5 dB/REF -20 dB 3: -37.470 dB 1 750.000 000 MHz

C Δ
 Avg
 15
 H1d

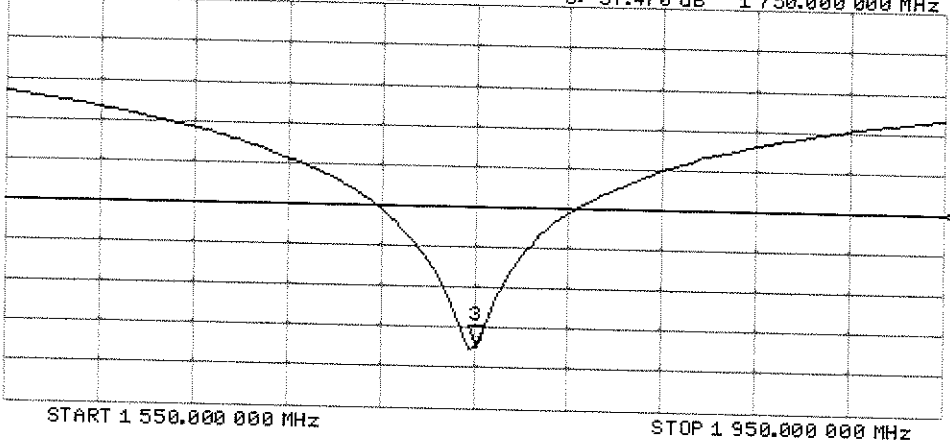

DASY5 Validation Report for Body TSL

Date: 15.04.2015

Test Laboratory: SPEAG, Zurich, Switzerland

DUT: Dipole 1750 MHz; Type: D1750V2; Serial: D1750V2 - SN:1051

Communication System: UID 0 - CW; Frequency: 1750 MHz

Medium parameters used: $f = 1750$ MHz; $\sigma = 1.48$ S/m; $\epsilon_r = 51.5$; $\rho = 1000$ kg/m³

Phantom section: Flat Section

Measurement Standard: DASY5 (IEEE/IEC/ANSI C63.19-2011)

DASY52 Configuration:

- Probe: ES3DV3 - SN3205; ConvF(4.88, 4.88, 4.88); Calibrated: 30.12.2014;
- Sensor-Surface: 3mm (Mechanical Surface Detection)
- Electronics: DAE4 Sn601; Calibrated: 18.08.2014
- Phantom: Flat Phantom 5.0 (back); Type: QD000P50AA; Serial: 1002
- DASY52 52.8.8(1222); SEMCAD X 14.6.10(7331)

Dipole Calibration for Body Tissue/Pin=250 mW, d=10mm/Zoom Scan (7x7x7)/Cube 0:

Measurement grid: dx=5mm, dy=5mm, dz=5mm

Reference Value = 92.87 V/m; Power Drift = 0.01 dB

Peak SAR (extrapolated) = 16.0 W/kg

SAR(1 g) = 9.32 W/kg; SAR(10 g) = 5.01 W/kg

Maximum value of SAR (measured) = 11.7 W/kg

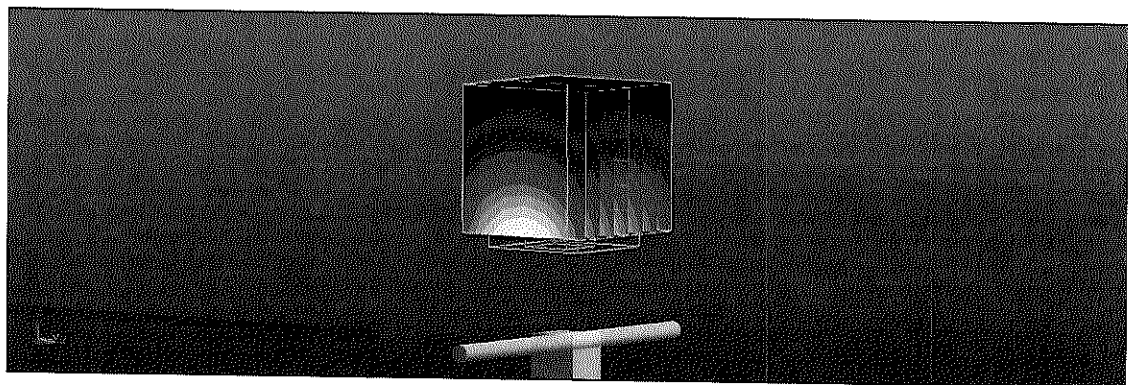
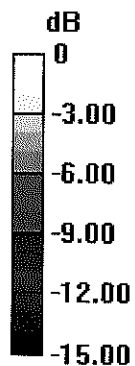

0 dB = 11.7 W/kg = 10.68 dBW/kg

Impedance Measurement Plot for Body TSL

15 Apr 2015 12:23:57
 [CH1] S11 1 U FS 3: 46.930 Ω 0.3242 Ω 29.486 pF 1 750.000 000 MHz

 De1
 Ca
 Avg
 16
 H1 d

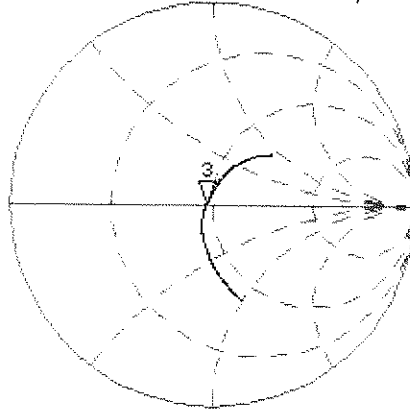

CH2 S11 LOG 5 dB/REF -20 dB 3:-29.939 dB 1 750.000 000 MHz

Ca
 Avg
 16
 H1 d

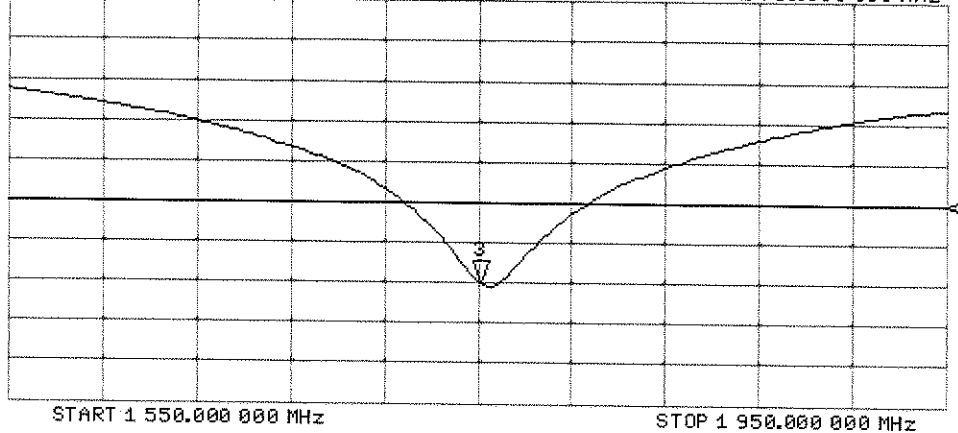



Accredited by the Swiss Accreditation Service (SAS)
The Swiss Accreditation Service is one of the signatories to the EA
Multilateral Agreement for the recognition of calibration certificates

Accreditation No.: **SCS 0108**

Client **PC Test**

Certificate No: **D1900V2-5d149_Jul15**

CALIBRATION CERTIFICATE

Object **D1900V2 - SN:5d149**

Calibration procedure(s) **QA CAL-05.v9
Calibration procedure for dipole validation kits above 700 MHz**

CCV
8/4/15

Calibration date: **July 14, 2015**

This calibration certificate documents the traceability to national standards, which realize the physical units of measurements (SI).
The measurements and the uncertainties with confidence probability are given on the following pages and are part of the certificate.

All calibrations have been conducted in the closed laboratory facility: environment temperature (22 ± 3)°C and humidity < 70%.

Calibration Equipment used (M&TE critical for calibration)

Primary Standards	ID #	Cal Date (Certificate No.)	Scheduled Calibration
Power meter EPM-442A	GB37480704	07-Oct-14 (No. 217-02020)	Oct-15
Power sensor HP 8481A	US37292783	07-Oct-14 (No. 217-02020)	Oct-15
Power sensor HP 8481A	MY41092317	07-Oct-14 (No. 217-02021)	Oct-15
Reference 20 dB Attenuator	SN: 5058 (20k)	01-Apr-15 (No. 217-02131)	Mar-16
Type-N mismatch combination	SN: 5047.2 / 06327	01-Apr-15 (No. 217-02134)	Mar-16
Reference Probe ES3DV3	SN: 3205	30-Dec-14 (No. ES3-3205_Dec14)	Dec-15
DAE4	SN: 601	18-Aug-14 (No. DAE4-601_Aug14)	Aug-15
Secondary Standards	ID #	Check Date (in house)	Scheduled Check
RF generator R&S SMT-06	100005	04-Aug-99 (in house check Oct-13)	In house check: Oct-16
Network Analyzer HP 8753E	US37390585 S4206	18-Oct-01 (in house check Oct-14)	In house check: Oct-15

Calibrated by:	Name Leif Klysner	Function Laboratory Technician	Signature
Approved by:	Katja Pokovic	Technical Manager	

Issued: July 14, 2015

This calibration certificate shall not be reproduced except in full without written approval of the laboratory.



Accredited by the Swiss Accreditation Service (SAS)

The Swiss Accreditation Service is one of the signatories to the EA Multilateral Agreement for the recognition of calibration certificates

Accreditation No.: **SCS 0108**

Glossary:

TSL	tissue simulating liquid
ConvF	sensitivity in TSL / NORM x,y,z
N/A	not applicable or not measured

Calibration is Performed According to the Following Standards:

- a) IEEE Std 1528-2013, "IEEE Recommended Practice for Determining the Peak Spatial-Averaged Specific Absorption Rate (SAR) in the Human Head from Wireless Communications Devices: Measurement Techniques", June 2013
- b) IEC 62209-1, "Procedure to measure the Specific Absorption Rate (SAR) for hand-held devices used in close proximity to the ear (frequency range of 300 MHz to 3 GHz)", February 2005
- c) IEC 62209-2, "Procedure to determine the Specific Absorption Rate (SAR) for wireless communication devices used in close proximity to the human body (frequency range of 30 MHz to 6 GHz)", March 2010
- d) KDB 865664, "SAR Measurement Requirements for 100 MHz to 6 GHz"

Additional Documentation:

- e) DASY4/5 System Handbook

Methods Applied and Interpretation of Parameters:

- *Measurement Conditions:* Further details are available from the Validation Report at the end of the certificate. All figures stated in the certificate are valid at the frequency indicated.
- *Antenna Parameters with TSL:* The dipole is mounted with the spacer to position its feed point exactly below the center marking of the flat phantom section, with the arms oriented parallel to the body axis.
- *Feed Point Impedance and Return Loss:* These parameters are measured with the dipole positioned under the liquid filled phantom. The impedance stated is transformed from the measurement at the SMA connector to the feed point. The Return Loss ensures low reflected power. No uncertainty required.
- *Electrical Delay:* One-way delay between the SMA connector and the antenna feed point. No uncertainty required.
- *SAR measured:* SAR measured at the stated antenna input power.
- *SAR normalized:* SAR as measured, normalized to an input power of 1 W at the antenna connector.
- *SAR for nominal TSL parameters:* The measured TSL parameters are used to calculate the nominal SAR result.

The reported uncertainty of measurement is stated as the standard uncertainty of measurement multiplied by the coverage factor $k=2$, which for a normal distribution corresponds to a coverage probability of approximately 95%.

Measurement Conditions

DASY system configuration, as far as not given on page 1.

DASY Version	DASY5	V52.8.8
Extrapolation	Advanced Extrapolation	
Phantom	Modular Flat Phantom	
Distance Dipole Center - TSL	10 mm	with Spacer
Zoom Scan Resolution	dx, dy, dz = 5 mm	
Frequency	1900 MHz \pm 1 MHz	

Head TSL parameters

The following parameters and calculations were applied.

	Temperature	Permittivity	Conductivity
Nominal Head TSL parameters	22.0 °C	40.0	1.40 mho/m
Measured Head TSL parameters	(22.0 \pm 0.2) °C	39.7 \pm 6 %	1.38 mho/m \pm 6 %
Head TSL temperature change during test	< 0.5 °C	----	----

SAR result with Head TSL

SAR averaged over 1 cm³ (1 g) of Head TSL	Condition	
SAR measured	250 mW input power	10.1 W/kg
SAR for nominal Head TSL parameters	normalized to 1W	40.7 W/kg \pm 17.0 % (k=2)

SAR averaged over 10 cm³ (10 g) of Head TSL	condition	
SAR measured	250 mW input power	5.34 W/kg
SAR for nominal Head TSL parameters	normalized to 1W	21.5 W/kg \pm 16.5 % (k=2)

Body TSL parameters

The following parameters and calculations were applied.

	Temperature	Permittivity	Conductivity
Nominal Body TSL parameters	22.0 °C	53.3	1.52 mho/m
Measured Body TSL parameters	(22.0 \pm 0.2) °C	52.7 \pm 6 %	1.54 mho/m \pm 6 %
Body TSL temperature change during test	< 0.5 °C	----	----

SAR result with Body TSL

SAR averaged over 1 cm³ (1 g) of Body TSL	Condition	
SAR measured	250 mW input power	10.2 W/kg
SAR for nominal Body TSL parameters	normalized to 1W	40.4 W/kg \pm 17.0 % (k=2)

SAR averaged over 10 cm³ (10 g) of Body TSL	condition	
SAR measured	250 mW input power	5.49 W/kg
SAR for nominal Body TSL parameters	normalized to 1W	21.8 W/kg \pm 16.5 % (k=2)

Appendix (Additional assessments outside the scope of SCS 0108)

Antenna Parameters with Head TSL

Impedance, transformed to feed point	$51.4 \Omega + 5.6 j\Omega$
Return Loss	- 24.9 dB

Antenna Parameters with Body TSL

Impedance, transformed to feed point	$47.7 \Omega + 6.1 j\Omega$
Return Loss	- 23.5 dB

General Antenna Parameters and Design

Electrical Delay (one direction)	1.197 ns
----------------------------------	----------

After long term use with 100W radiated power, only a slight warming of the dipole near the feedpoint can be measured.

The dipole is made of standard semirigid coaxial cable. The center conductor of the feeding line is directly connected to the second arm of the dipole. The antenna is therefore short-circuited for DC-signals. On some of the dipoles, small end caps are added to the dipole arms in order to improve matching when loaded according to the position as explained in the "Measurement Conditions" paragraph. The SAR data are not affected by this change. The overall dipole length is still according to the Standard.

No excessive force must be applied to the dipole arms, because they might bend or the soldered connections near the feedpoint may be damaged.

Additional EUT Data

Manufactured by	SPEAG
Manufactured on	March 11, 2011

DASY5 Validation Report for Head TSL

Date: 14.07.2015

Test Laboratory: SPEAG, Zurich, Switzerland

DUT: Dipole 1900 MHz; Type: D1900V2; Serial: D1900V2 - SN:5d149

Communication System: UID 0 - CW; Frequency: 1900 MHz

Medium parameters used: $f = 1900$ MHz; $\sigma = 1.38$ S/m; $\epsilon_r = 39.7$; $\rho = 1000$ kg/m³

Phantom section: Flat Section

Measurement Standard: DASY5 (IEEE/IEC/ANSI C63.19-2011)

DASY52 Configuration:

- Probe: ES3DV3 - SN3205; ConvF(5, 5, 5); Calibrated: 30.12.2014;
- Sensor-Surface: 3mm (Mechanical Surface Detection)
- Electronics: DAE4 Sn601; Calibrated: 18.08.2014
- Phantom: Flat Phantom 5.0 (front); Type: QD000P50AA; Serial: 1001
- DASY52 52.8.8(1222); SEMCAD X 14.6.10(7331)

Dipole Calibration for Head Tissue/Pin=250 mW, d=10mm/Zoom Scan (7x7x7)/Cube 0:

Measurement grid: dx=5mm, dy=5mm, dz=5mm

Reference Value = 99.22 V/m; Power Drift = 0.02 dB

Peak SAR (extrapolated) = 18.3 W/kg

SAR(1 g) = 10.1 W/kg; SAR(10 g) = 5.34 W/kg

Maximum value of SAR (measured) = 12.9 W/kg

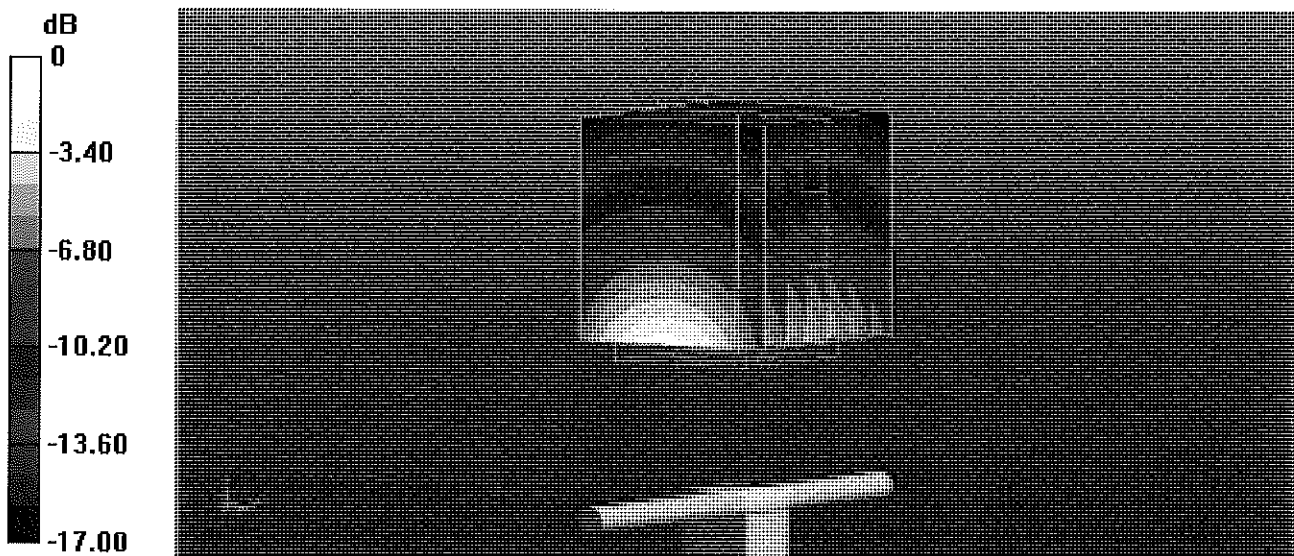

0 dB = 12.9 W/kg = 11.11 dBW/kg

Impedance Measurement Plot for Head TSL

14 Jul 2015 09:20:59

CH1 S11 1 U FS 1: 51.447 Ω 5.5664 Ω 466.27 μ H 1 900.000 000 MHz

*
De1
CA
Avg
16
H1d

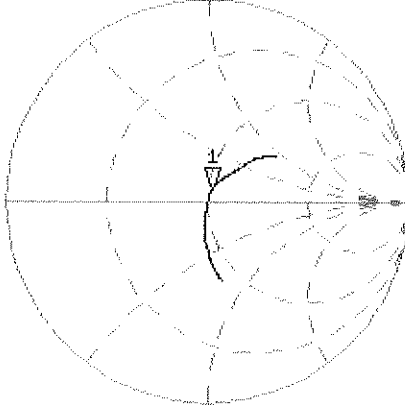

CH2 S11 LOG 5 dB/REF -20 dB 1: -24.943 dB 1 900.000 000 MHz

De1
CA
Avg
16
H1d

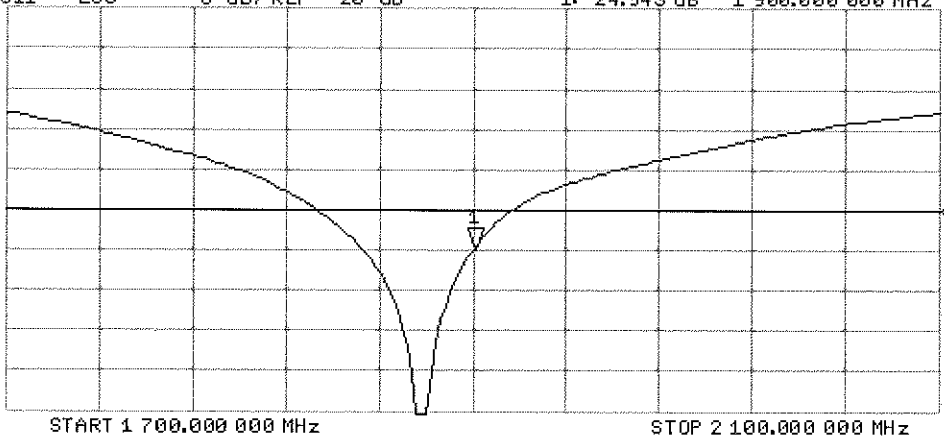

DASY5 Validation Report for Body TSL

Date: 14.07.2015

Test Laboratory: SPEAG, Zurich, Switzerland

DUT: Dipole 1900 MHz; Type: D1900V2; Serial: D1900V2 - SN:5d149

Communication System: UID 0 - CW; Frequency: 1900 MHz

Medium parameters used: $f = 1900$ MHz; $\sigma = 1.54$ S/m; $\epsilon_r = 52.7$; $\rho = 1000$ kg/m³

Phantom section: Flat Section

Measurement Standard: DASY5 (IEEE/IEC/ANSI C63.19-2011)

DASY52 Configuration:

- Probe: ES3DV3 - SN3205; ConvF(4.65, 4.65, 4.65); Calibrated: 30.12.2014;
- Sensor-Surface: 3mm (Mechanical Surface Detection)
- Electronics: DAE4 Sn601; Calibrated: 18.08.2014
- Phantom: Flat Phantom 5.0 (back); Type: QD000P50AA; Serial: 1002
- DASY52 52.8.8(1222); SEMCAD X 14.6.10(7331)

Dipole Calibration for Body Tissue/Pin=250 mW, d=10mm/Zoom Scan (7x7x7)/Cube 0:

Measurement grid: dx=5mm, dy=5mm, dz=5mm

Reference Value = 95.96 V/m; Power Drift = 0.01 dB

Peak SAR (extrapolated) = 17.2 W/kg

SAR(1 g) = 10.2 W/kg; SAR(10 g) = 5.49 W/kg

Maximum value of SAR (measured) = 12.9 W/kg

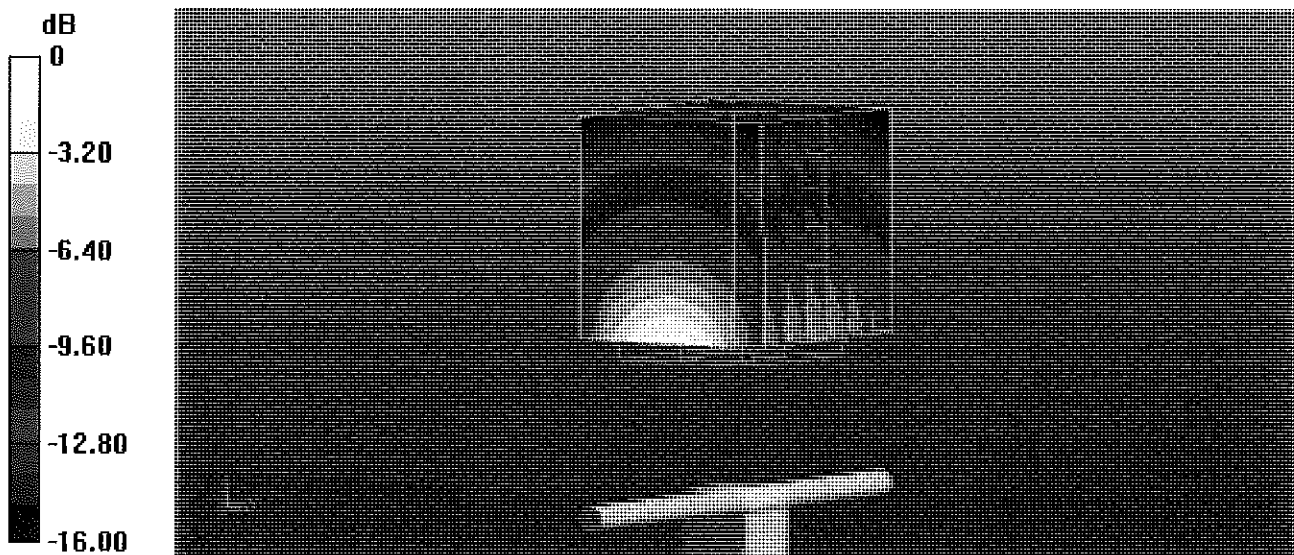

0 dB = 12.9 W/kg = 11.11 dBW/kg

Impedance Measurement Plot for Body TSL

14 Jul 2015 09:20:09

CH1 S11 1 U FS 1: 47.723 ω 6.1406 ω 514.37 pF 1 900.000 000 MHz

*
De1

CΔ

Avg
16

H1d

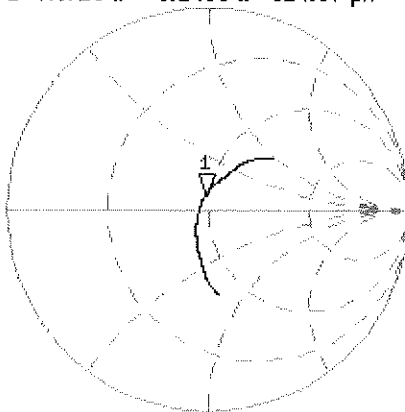

CH2 S11 LOG 5 dB/REF -20 dB 1:-23.490 dB 1 900.000 000 MHz

De1

CΔ

Avg
16

H1d

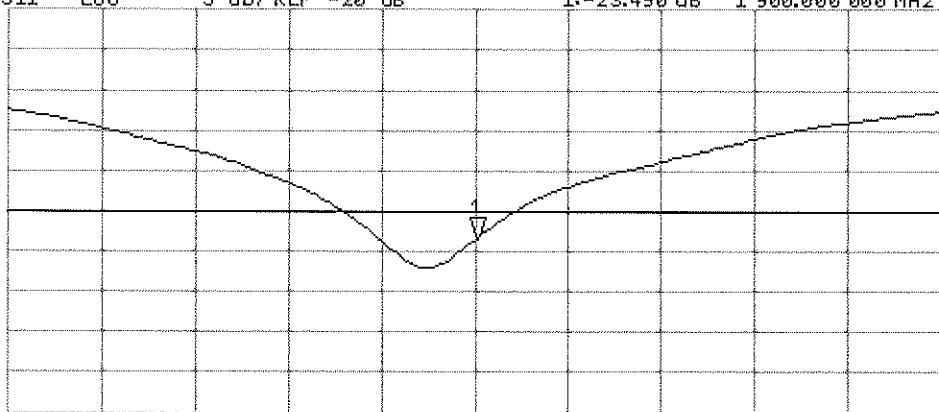

START 1 700.000 000 MHz

STOP 2 100.000 000 MHz



Accredited by the Swiss Accreditation Service (SAS)
The Swiss Accreditation Service is one of the signatories to the EA
Multilateral Agreement for the recognition of calibration certificates

Accreditation No.: **SCS 0108**

Client **PC Test**

Certificate No: **D2300V2-1064_Dec15**

CALIBRATION CERTIFICATE

Object **D2300V2 - SN: 1064**

Calibration procedure(s) **QA CAL-05.v9
Calibration procedure for dipole validation kits above 700 MHz**

Calibration date: **December 08, 2015**

*BNV
12/16/2015*

This calibration certificate documents the traceability to national standards, which realize the physical units of measurements (SI).
The measurements and the uncertainties with confidence probability are given on the following pages and are part of the certificate.

All calibrations have been conducted in the closed laboratory facility: environment temperature (22 ± 3)°C and humidity < 70%.

Calibration Equipment used (M&TE critical for calibration)

Primary Standards	ID #	Cal Date (Certificate No.)	Scheduled Calibration
Power meter EPM-442A	GB37480704	07-Oct-15 (No. 217-02222)	Oct-16
Power sensor HP B481A	US37292783	07-Oct-15 (No. 217-02222)	Oct-16
Power sensor HP B481A	MY41092317	07-Oct-15 (No. 217-02223)	Oct-18
Reference 20 dB Attenuator	SN: 5058 (20k)	01-Apr-15 (No. 217-02131)	Mar-16
Type-N mismatch combination	SN: 5047.2 / 06327	01-Apr-15 (No. 217-02134)	Mar-16
Reference Probe EX3DV4	SN: 7349	30-Dec-14 (No. EX3-7349_Dec14)	Dec-15
DAE4	SN: 601	17-Aug-15 (No. DAE4-601_Aug15)	Aug-16

Secondary Standards	ID #	Check Date (in house)	Scheduled Check
RF generator R&S SMT-06	100972	15-Jun-15 (in house check Jun-15)	In house check: Jun-18
Network Analyzer HP 8753E	US37390585 S4206	18-Oct-01 (in house check Oct-15)	In house check: Oct-16

Calibrated by: **Michael Weber** Name: Michael Weber Function: Laboratory Technician

Signature: *M. Weber*

Approved by: **Katja Pokovic** Name: Katja Pokovic Function: Technical Manager

Signature: *Katja Pokovic*

Issued: December 8, 2015

This calibration certificate shall not be reproduced except in full without written approval of the laboratory.



Accredited by the Swiss Accreditation Service (SAS)
The Swiss Accreditation Service is one of the signatories to the EA
Multilateral Agreement for the recognition of calibration certificates

Accreditation No.: **SCS 0108**

Glossary:

TSL tissue simulating liquid
ConvF sensitivity in TSL / NORM x,y,z
N/A not applicable or not measured

Calibration is Performed According to the Following Standards:

- a) IEEE Std 1528-2013, "IEEE Recommended Practice for Determining the Peak Spatial-Averaged Specific Absorption Rate (SAR) in the Human Head from Wireless Communications Devices: Measurement Techniques", June 2013
- b) IEC 62209-1, "Procedure to measure the Specific Absorption Rate (SAR) for hand-held devices used in close proximity to the ear (frequency range of 300 MHz to 3 GHz)", February 2005
- c) IEC 62209-2, "Procedure to determine the Specific Absorption Rate (SAR) for wireless communication devices used in close proximity to the human body (frequency range of 30 MHz to 6 GHz)", March 2010
- d) KDB 865664, "SAR Measurement Requirements for 100 MHz to 6 GHz"

Additional Documentation:

- e) DASY4/5 System Handbook

Methods Applied and Interpretation of Parameters:

- *Measurement Conditions:* Further details are available from the Validation Report at the end of the certificate. All figures stated in the certificate are valid at the frequency indicated.
- *Antenna Parameters with TSL:* The dipole is mounted with the spacer to position its feed point exactly below the center marking of the flat phantom section, with the arms oriented parallel to the body axis.
- *Feed Point Impedance and Return Loss:* These parameters are measured with the dipole positioned under the liquid filled phantom. The impedance stated is transformed from the measurement at the SMA connector to the feed point. The Return Loss ensures low reflected power. No uncertainty required.
- *Electrical Delay:* One-way delay between the SMA connector and the antenna feed point. No uncertainty required.
- *SAR measured:* SAR measured at the stated antenna input power.
- *SAR normalized:* SAR as measured, normalized to an input power of 1 W at the antenna connector.
- *SAR for nominal TSL parameters:* The measured TSL parameters are used to calculate the nominal SAR result.

The reported uncertainty of measurement is stated as the standard uncertainty of measurement multiplied by the coverage factor $k=2$, which for a normal distribution corresponds to a coverage probability of approximately 95%.

Measurement Conditions

DASY system configuration, as far as not given on page 1.

DASY Version	DASY5	V52.8.8
Extrapolation	Advanced Extrapolation	
Phantom	Modular Flat Phantom	
Distance Dipole Center - TSL	10 mm	with Spacer
Zoom Scan Resolution	dx, dy, dz = 5 mm	
Frequency	2300 MHz \pm 1 MHz	

Head TSL parameters

The following parameters and calculations were applied.

	Temperature	Permittivity	Conductivity
Nominal Head TSL parameters	22.0 °C	39.5	1.67 mho/m
Measured Head TSL parameters	(22.0 \pm 0.2) °C	38.8 \pm 6 %	1.71 mho/m \pm 6 %
Head TSL temperature change during test	< 0.5 °C	---	---

SAR result with Head TSL

SAR averaged over 1 cm ³ (1 g) of Head TSL	Condition	
SAR measured	250 mW input power	12.1 W/kg
SAR for nominal Head TSL parameters	normalized to 1W	47.6 W/kg \pm 17.0 % (k=2)

SAR averaged over 10 cm ³ (10 g) of Head TSL	condition	
SAR measured	250 mW input power	5.73 W/kg
SAR for nominal Head TSL parameters	normalized to 1W	22.7 W/kg \pm 16.5 % (k=2)

Body TSL parameters

The following parameters and calculations were applied.

	Temperature	Permittivity	Conductivity
Nominal Body TSL parameters	22.0 °C	52.9	1.81 mho/m
Measured Body TSL parameters	(22.0 \pm 0.2) °C	53.1 \pm 6 %	1.85 mho/m \pm 6 %
Body TSL temperature change during test	< 0.5 °C	---	---

SAR result with Body TSL

SAR averaged over 1 cm ³ (1 g) of Body TSL	Condition	
SAR measured	250 mW input power	11.5 W/kg
SAR for nominal Body TSL parameters	normalized to 1W	45.5 W/kg \pm 17.0 % (k=2)

SAR averaged over 10 cm ³ (10 g) of Body TSL	condition	
SAR measured	250 mW input power	5.52 W/kg
SAR for nominal Body TSL parameters	normalized to 1W	22.0 W/kg \pm 16.5 % (k=2)

Appendix (Additional assessments outside the scope of SCS 0108)

Antenna Parameters with Head TSL

Impedance, transformed to feed point	48.7 Ω - 5.4 j Ω
Return Loss	- 25.0 dB

Antenna Parameters with Body TSL

Impedance, transformed to feed point	45.8 Ω - 3.4 j Ω
Return Loss	- 25.0 dB

General Antenna Parameters and Design

Electrical Delay (one direction)	1.167 ns
----------------------------------	----------

After long term use with 100W radiated power, only a slight warming of the dipole near the feedpoint can be measured.

The dipole is made of standard semirigid coaxial cable. The center conductor of the feeding line is directly connected to the second arm of the dipole. The antenna is therefore short-circuited for DC-signals. On some of the dipoles, small end caps are added to the dipole arms in order to improve matching when loaded according to the position as explained in the "Measurement Conditions" paragraph. The SAR data are not affected by this change. The overall dipole length is still according to the Standard.

No excessive force must be applied to the dipole arms, because they might bend or the soldered connections near the feedpoint may be damaged.

Additional EUT Data

Manufactured by	SPEAG
Manufactured on	August 20, 2015

DASY5 Validation Report for Head TSL

Date: 08.12.2015

Test Laboratory: SPEAG, Zurich, Switzerland

DUT: Dipole 2300 MHz; Type: D2300V2; Serial: D2300V2 - SN: 1064

Communication System: UID 0 - CW; Frequency: 2300 MHz

Medium parameters used: $f = 2300$ MHz; $\sigma = 1.71$ S/m; $\epsilon_r = 38.8$; $\rho = 1000$ kg/m³

Phantom section: Flat Section

Measurement Standard: DASY5 (IEEE/IEC/ANSI C63.19-2011)

DASY52 Configuration:

- Probe: EX3DV4 - SN7349; ConvF(7.94, 7.94, 7.94); Calibrated: 30.12.2014;
- Sensor-Surface: 1.4mm (Mechanical Surface Detection)
- Electronics: DAE4 Sn601; Calibrated: 17.08.2015
- Phantom: Flat Phantom 5.0 (front); Type: QD000P50AA; Serial: 1001
- DASY52 52.8.8(1222); SEMCAD X 14.6.10(7331)

Dipole Calibration for Head Tissue/ $P_{in}=250$ mW, $d=10$ mm/Zoom Scan (7x7x7)/Cube 0:

Measurement grid: $dx=5$ mm, $dy=5$ mm, $dz=5$ mm

Reference Value = 111.1 V/m; Power Drift = 0.04 dB

Peak SAR (extrapolated) = 24.4 W/kg

SAR(1 g) = 12.1 W/kg; SAR(10 g) = 5.73 W/kg

Maximum value of SAR (measured) = 19.7 W/kg

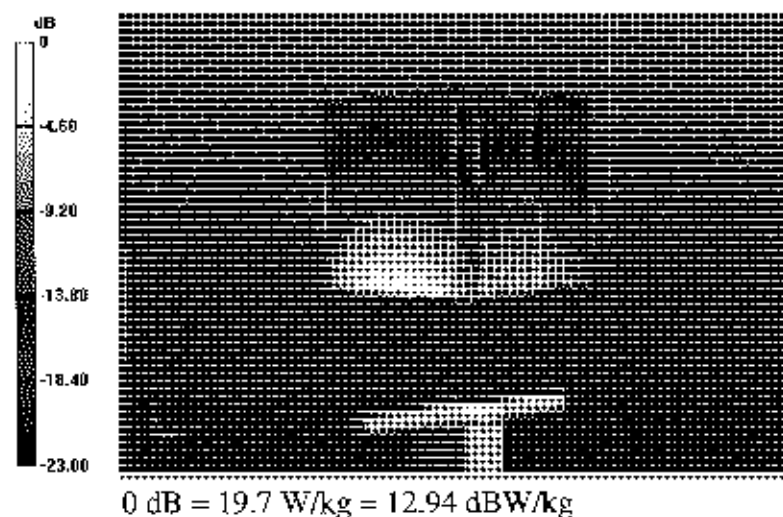

Impedance Measurement Plot for Head TSL

8 Dec 2015 11:52:18
 [CHI] S11 1 U FS 2:45.748 Ω -5.4238 Ω 12.758 μ F 2 300.000 000 MHz

*
 Del
 CA
 Avg
 16
 H1d

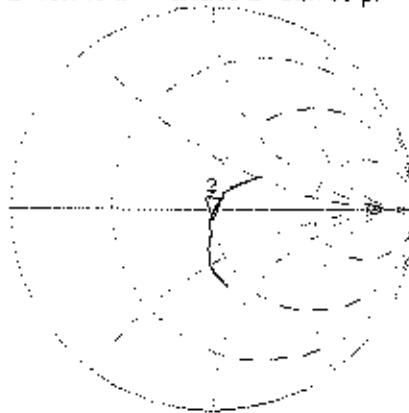

CH2 S11 LOG 5 dB/REF -20 dB 2:-24.993 dB 2 300.000 000 MHz

CA
 Avg
 16
 H1d

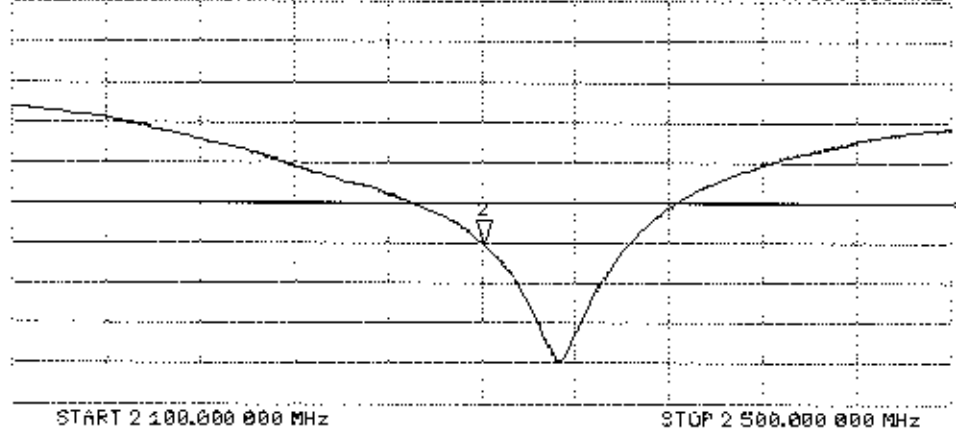

DASY5 Validation Report for Body TSL

Date: 08.12.2015

Test Laboratory: SPEAG, Zurich, Switzerland

DUT: Dipole 2300 MHz; Type: D2300V2; Serial: D2300V2 - SN: 1064

Communication System: UID 0 - CW; Frequency: 2300 MHz

Medium parameters used: $f = 2300$ MHz; $\sigma = 1.85$ S/m; $\epsilon_r = 53.1$; $\rho = 1000$ kg/m³

Phantom section: Flat Section

Measurement Standard: DASY5 (IEEE/IEC/ANSI C63.19-2011)

DASY52 Configuration:

- Probe: EX3DV4 - SN7349; ConvF(7.74, 7.74, 7.74); Calibrated: 30.12.2014;
- Sensor-Surface: 1.4mm (Mechanical Surface Detection)
- Electronics: DAE4 Sn601; Calibrated: 17.08.2015
- Phantom: Flat Phantom 5.0 (back); Type: QD000P50AA; Serial: 1002
- DASY52 52.8.8(1222); SEMCAD X 14.6.10(7331)

Dipole Calibration for Body Tissue/ $P_{in}=250$ mW, $d=10$ mm/Zoom Scan (7x7x7)/Cube 0:

Measurement grid: $dx=5$ mm, $dy=5$ mm, $dz=5$ mm

Reference Value = 103.8 V/m; Power Drift = 0.01 dB

Peak SAR (extrapolated) = 22.5 W/kg

SAR(1 g) = 11.5 W/kg; SAR(10 g) = 5.52 W/kg

Maximum value of SAR (measured) = 18.6 W/kg

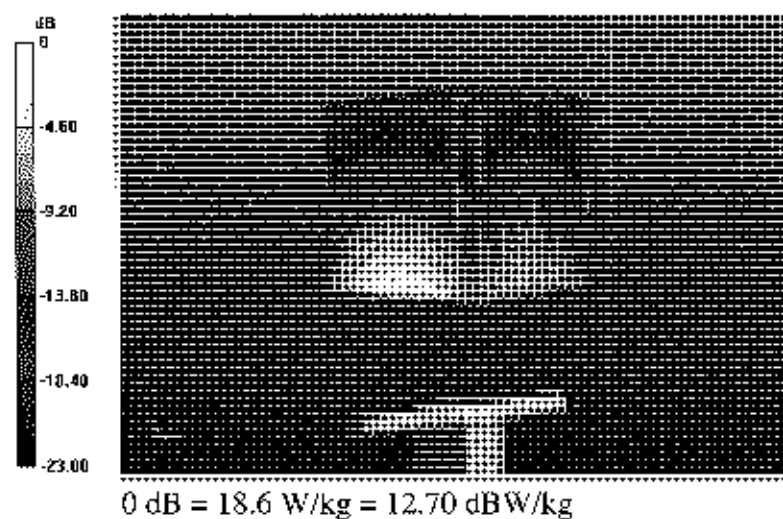

Impedance Measurement Plot for Body TSL

8 Dec 2015 11:51:39

CH1 S11 1 U FS 2: 45.816 Ω -3.4414 Ω 20.107 pF 2 300.000 000 MHz

*
Del
CA
Avg
16
H1d

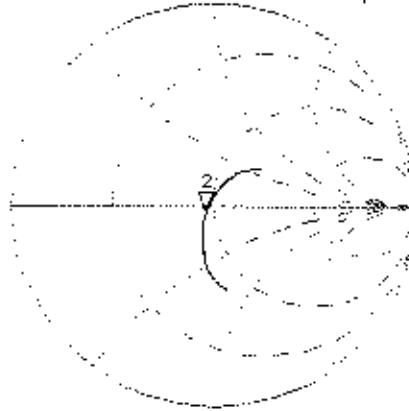

CH2 S11 L06 5 dB/REF -20 dB 2: -24.958 dB 2 300.000 000 MHz

CA
Avg
16
H1d

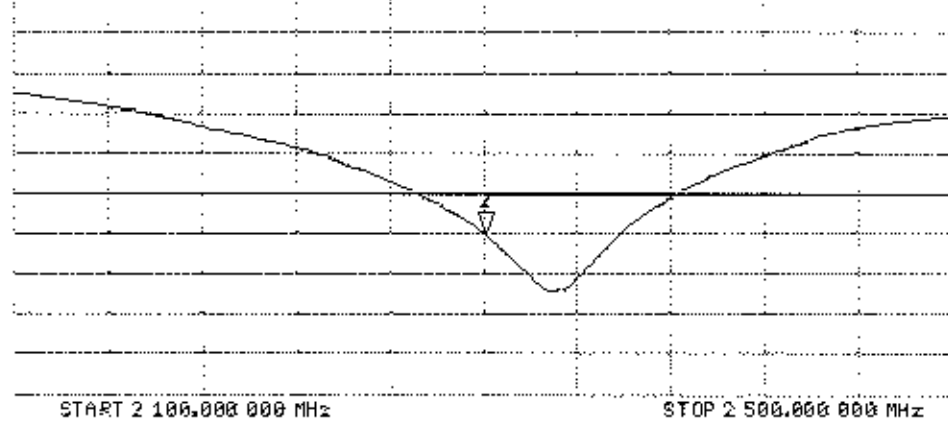



Accredited by the Swiss Accreditation Service (SAS)
The Swiss Accreditation Service is one of the signatories to the EA
Multilateral Agreement for the recognition of calibration certificates

Accreditation No.: **SCS 0108**

Client **PC Test**

Certificate No: **D2450V2-719_Aug15**

CALIBRATION CERTIFICATE

Object **D2450V2 - SN: 719**

Calibration procedure(s) **QA CAL-05.v9
Calibration procedure for dipole validation kits above 700 MHz**

Calibration date: **August 20, 2015**

*BN ✓
9/3/15*

This calibration certificate documents the traceability to national standards, which realize the physical units of measurements (SI).
The measurements and the uncertainties with confidence probability are given on the following pages and are part of the certificate.

All calibrations have been conducted in the closed laboratory facility: environment temperature (22 ± 3)°C and humidity < 70%.

Calibration Equipment used (M&TE critical for calibration)

Primary Standards	ID #	Cal Date (Certificate No.)	Scheduled Calibration
Power meter EPM-442A	GB37480704	07-Oct-14 (No. 217-02020)	Oct-15
Power sensor HP 8481A	US37292783	07-Oct-14 (No. 217-02020)	Oct-15
Power sensor HP 8481A	MY41092317	07-Oct-14 (No. 217-02021)	Oct-15
Reference 20 dB Attenuator	SN: 5058 (20k)	01-Apr-15 (No. 217-02131)	Mar-16
Type-N mismatch combination	SN: 5047.2 / 06327	01-Apr-15 (No. 217-02134)	Mar-16
Reference Probe ES3DV3	SN: 3205	30-Dec-14 (No. ES3-3205_Dec14)	Dec-15
DAE4	SN: 601	17-Aug-15 (No. DAE4-601_Aug15)	Aug-16

Secondary Standards	ID #	Check Date (in house)	Scheduled Check
RF generator R&S SMT-06	100005	04-Aug-99 (in house check Oct-13)	In house check: Oct-16
Network Analyzer HP 8753E	US37390585 S4206	18-Oct-01 (in house check Oct-14)	In house check: Oct-15

Calibrated by: **Name** Michael Weber **Function** Laboratory Technician

Signature
M. Weber

Approved by: **Name** Katja Pokovic **Function** Technical Manager

[Signature]

Issued: August 21, 2015

This calibration certificate shall not be reproduced except in full without written approval of the laboratory.



Accredited by the Swiss Accreditation Service (SAS)
The Swiss Accreditation Service is one of the signatories to the EA
Multilateral Agreement for the recognition of calibration certificates

Accreditation No.: **SCS 0108**

Glossary:

TSL	tissue simulating liquid
ConvF	sensitivity in TSL / NORM x,y,z
N/A	not applicable or not measured

Calibration is Performed According to the Following Standards:

- a) IEEE Std 1528-2013, "IEEE Recommended Practice for Determining the Peak Spatial-Averaged Specific Absorption Rate (SAR) in the Human Head from Wireless Communications Devices: Measurement Techniques", June 2013
- b) IEC 62209-1, "Procedure to measure the Specific Absorption Rate (SAR) for hand-held devices used in close proximity to the ear (frequency range of 300 MHz to 3 GHz)", February 2005
- c) IEC 62209-2, "Procedure to determine the Specific Absorption Rate (SAR) for wireless communication devices used in close proximity to the human body (frequency range of 30 MHz to 6 GHz)", March 2010
- d) KDB 865664, "SAR Measurement Requirements for 100 MHz to 6 GHz"

Additional Documentation:

- e) DASY4/5 System Handbook

Methods Applied and Interpretation of Parameters:

- *Measurement Conditions:* Further details are available from the Validation Report at the end of the certificate. All figures stated in the certificate are valid at the frequency indicated.
- *Antenna Parameters with TSL:* The dipole is mounted with the spacer to position its feed point exactly below the center marking of the flat phantom section, with the arms oriented parallel to the body axis.
- *Feed Point Impedance and Return Loss:* These parameters are measured with the dipole positioned under the liquid filled phantom. The impedance stated is transformed from the measurement at the SMA connector to the feed point. The Return Loss ensures low reflected power. No uncertainty required.
- *Electrical Delay:* One-way delay between the SMA connector and the antenna feed point. No uncertainty required.
- *SAR measured:* SAR measured at the stated antenna input power.
- *SAR normalized:* SAR as measured, normalized to an input power of 1 W at the antenna connector.
- *SAR for nominal TSL parameters:* The measured TSL parameters are used to calculate the nominal SAR result.

The reported uncertainty of measurement is stated as the standard uncertainty of measurement multiplied by the coverage factor $k=2$, which for a normal distribution corresponds to a coverage probability of approximately 95%.

Measurement Conditions

DASY system configuration, as far as not given on page 1.

DASY Version	DASY5	V52.8.8
Extrapolation	Advanced Extrapolation	
Phantom	Modular Flat Phantom	
Distance Dipole Center - TSL	10 mm	with Spacer
Zoom Scan Resolution	dx, dy, dz = 5 mm	
Frequency	2450 MHz ± 1 MHz	

Head TSL parameters

The following parameters and calculations were applied.

	Temperature	Permittivity	Conductivity
Nominal Head TSL parameters	22.0 °C	39.2	1.80 mho/m
Measured Head TSL parameters	(22.0 ± 0.2) °C	39.2 ± 6 %	1.87 mho/m ± 6 %
Head TSL temperature change during test	< 0.5 °C	----	----

SAR result with Head TSL

SAR averaged over 1 cm³ (1 g) of Head TSL	Condition	
SAR measured	250 mW input power	13.8 W/kg
SAR for nominal Head TSL parameters	normalized to 1W	54.2 W/kg ± 17.0 % (k=2)

SAR averaged over 10 cm³ (10 g) of Head TSL	condition	
SAR measured	250 mW input power	6.48 W/kg
SAR for nominal Head TSL parameters	normalized to 1W	25.7 W/kg ± 16.5 % (k=2)

Body TSL parameters

The following parameters and calculations were applied.

	Temperature	Permittivity	Conductivity
Nominal Body TSL parameters	22.0 °C	52.7	1.95 mho/m
Measured Body TSL parameters	(22.0 ± 0.2) °C	53.2 ± 6 %	2.00 mho/m ± 6 %
Body TSL temperature change during test	< 0.5 °C	----	----

SAR result with Body TSL

SAR averaged over 1 cm³ (1 g) of Body TSL	Condition	
SAR measured	250 mW input power	13.1 W/kg
SAR for nominal Body TSL parameters	normalized to 1W	51.9 W/kg ± 17.0 % (k=2)

SAR averaged over 10 cm³ (10 g) of Body TSL	condition	
SAR measured	250 mW input power	6.11 W/kg
SAR for nominal Body TSL parameters	normalized to 1W	24.3 W/kg ± 16.5 % (k=2)

Appendix (Additional assessments outside the scope of SCS 0108)

Antenna Parameters with Head TSL

Impedance, transformed to feed point	54.5 Ω + 5.3 j Ω
Return Loss	- 23.5 dB

Antenna Parameters with Body TSL

Impedance, transformed to feed point	50.1 Ω + 6.5 j Ω
Return Loss	- 23.7 dB

General Antenna Parameters and Design

Electrical Delay (one direction)	1.149 ns
----------------------------------	----------

After long term use with 100W radiated power, only a slight warming of the dipole near the feedpoint can be measured.

The dipole is made of standard semirigid coaxial cable. The center conductor of the feeding line is directly connected to the second arm of the dipole. The antenna is therefore short-circuited for DC-signals. On some of the dipoles, small end caps are added to the dipole arms in order to improve matching when loaded according to the position as explained in the "Measurement Conditions" paragraph. The SAR data are not affected by this change. The overall dipole length is still according to the Standard.

No excessive force must be applied to the dipole arms, because they might bend or the soldered connections near the feedpoint may be damaged.

Additional EUT Data

Manufactured by	SPEAG
Manufactured on	September 10, 2002

DASY5 Validation Report for Head TSL

Date: 20.08.2015

Test Laboratory: SPEAG, Zurich, Switzerland

DUT: Dipole 2450 MHz; Type: D2450V2; Serial: D2450V2 - SN: 719

Communication System: UID 0 - CW; Frequency: 2450 MHz

Medium parameters used: $f = 2450$ MHz; $\sigma = 1.87$ S/m; $\epsilon_r = 39.2$; $\rho = 1000$ kg/m³

Phantom section: Flat Section

Measurement Standard: DASY5 (IEEE/IEC/ANSI C63.19-2011)

DASY52 Configuration:

- Probe: ES3DV3 - SN3205; ConvF(4.54, 4.54, 4.54); Calibrated: 30.12.2014;
- Sensor-Surface: 3mm (Mechanical Surface Detection)
- Electronics: DAE4 Sn601; Calibrated: 17.08.2015
- Phantom: Flat Phantom 5.0 (front); Type: QD000P50AA; Serial: 1001
- DASY52 52.8.8(1222); SEMCAD X 14.6.10(7331)

Dipole Calibration for Head Tissue/Pin=250 mW, d=10mm/Zoom Scan (7x7x7)/Cube 0:

Measurement grid: dx=5mm, dy=5mm, dz=5mm

Reference Value = 102.2 V/m; Power Drift = -0.01 dB

Peak SAR (extrapolated) = 28.1 W/kg

SAR(1 g) = 13.8 W/kg; SAR(10 g) = 6.48 W/kg

Maximum value of SAR (measured) = 18.2 W/kg

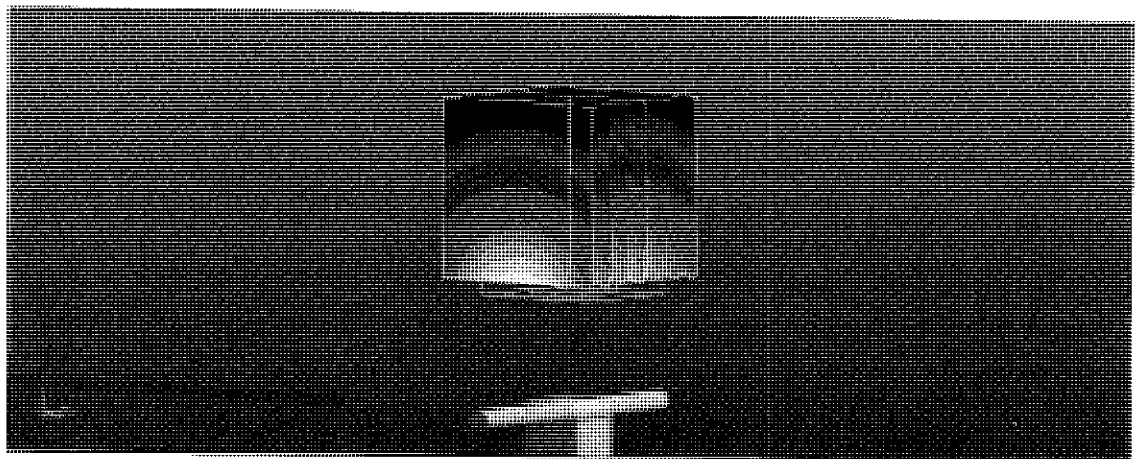
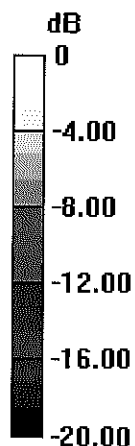

0 dB = 18.2 W/kg = 12.60 dBW/kg

Impedance Measurement Plot for Head TSL

CH1 S11 1 U FS 19 Aug 2015 12:34:37
 4: 54.510 Ω 5.3223 Ω 345.74 μ H 2 450.000 000 MHz

*
 Del
 CA
 Avg
 16
 H1d

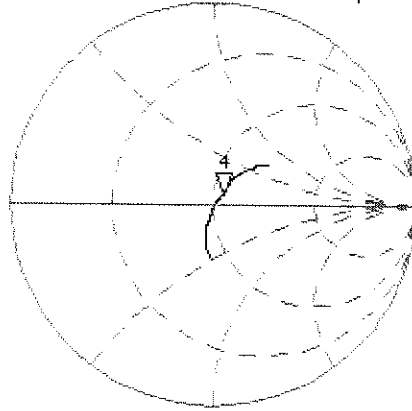

CH2 S11 LOG 5 dB/REF -20 dB 4: -23.517 dB 2 450.000 000 MHz

CA
 Avg
 16
 H1d

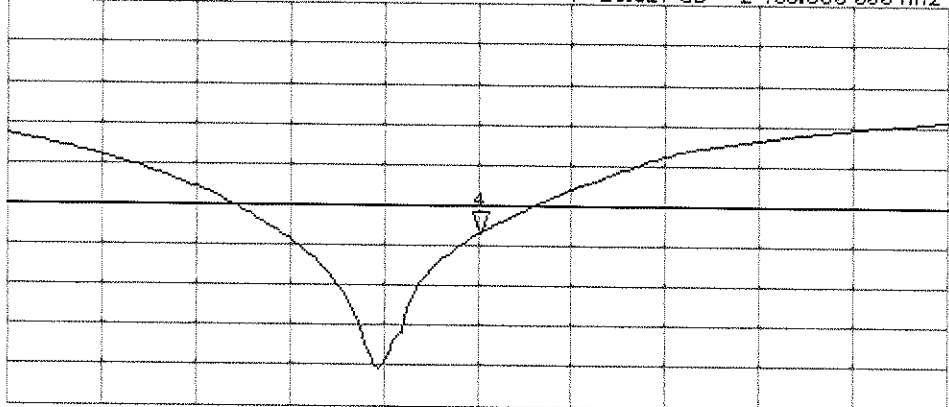

START 2 250.000 000 MHz

STOP 2 650.000 000 MHz

DASY5 Validation Report for Body TSL

Date: 19.08.2015

Test Laboratory: SPEAG, Zurich, Switzerland

DUT: Dipole 2450 MHz; Type: D2450V2; Serial: D2450V2 - SN: 719

Communication System: UID 0 - CW; Frequency: 2450 MHz

Medium parameters used: $f = 2450$ MHz; $\sigma = 2$ S/m; $\epsilon_r = 53.2$; $\rho = 1000$ kg/m³

Phantom section: Flat Section

Measurement Standard: DASY5 (IEEE/IEC/ANSI C63.19-2011)

DASY52 Configuration:

- Probe: ES3DV3 - SN3205; ConvF(4.32, 4.32, 4.32); Calibrated: 30.12.2014;
- Sensor-Surface: 3mm (Mechanical Surface Detection)
- Electronics: DAE4 Sn601; Calibrated: 17.08.2015
- Phantom: Flat Phantom 5.0 (back); Type: QD000P50AA; Serial: 1002
- DASY52 52.8.8(1222); SEMCAD X 14.6.10(7331)

Dipole Calibration for Body Tissue/Pin=250 mW, d=10mm/Zoom Scan (7x7x7)/Cube 0:

Measurement grid: dx=5mm, dy=5mm, dz=5mm

Reference Value = 95.73 V/m; Power Drift = 0.01 dB

Peak SAR (extrapolated) = 26.9 W/kg

SAR(1 g) = 13.1 W/kg; SAR(10 g) = 6.11 W/kg

Maximum value of SAR (measured) = 17.3 W/kg

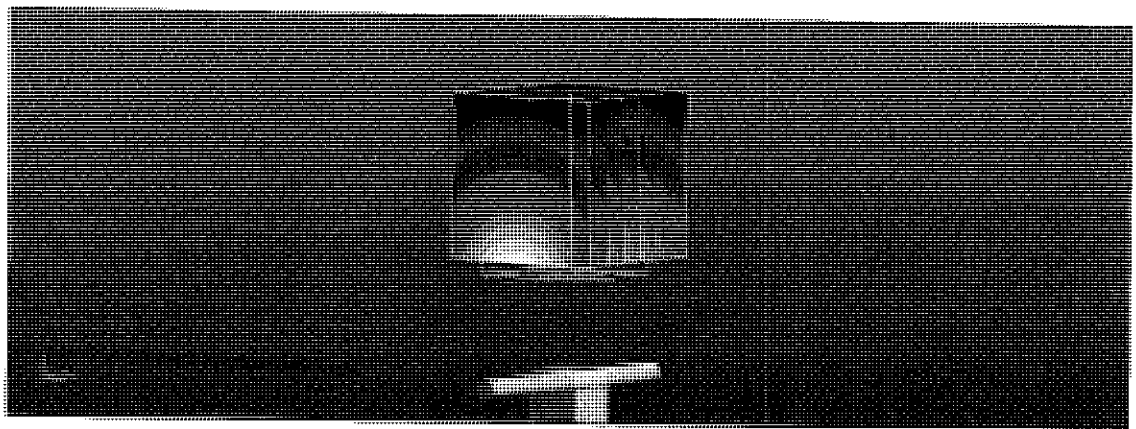
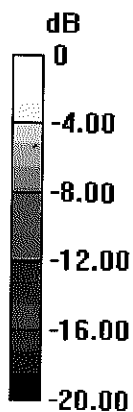

0 dB = 17.3 W/kg = 12.38 dBW/kg

Impedance Measurement Plot for Body TSL

CH1 S11 1 U FS 19 Aug 2015 12:33:47
4: 50.098 Ω 6.5195 μ 423.52 pF 2 450.000 000 MHz

*
De1
C Δ
Avg
16

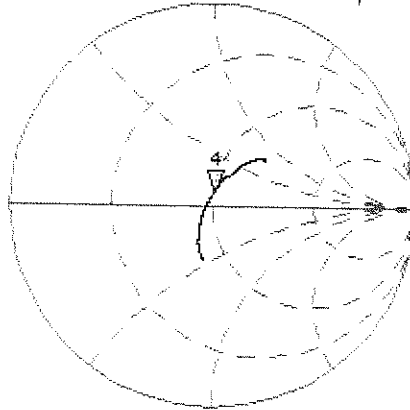

CH2 S11 LOG 5 dB/REF -20 dB 4: -23.742 dB 2 450.000 000 MHz

C Δ
Avg
16
H1d

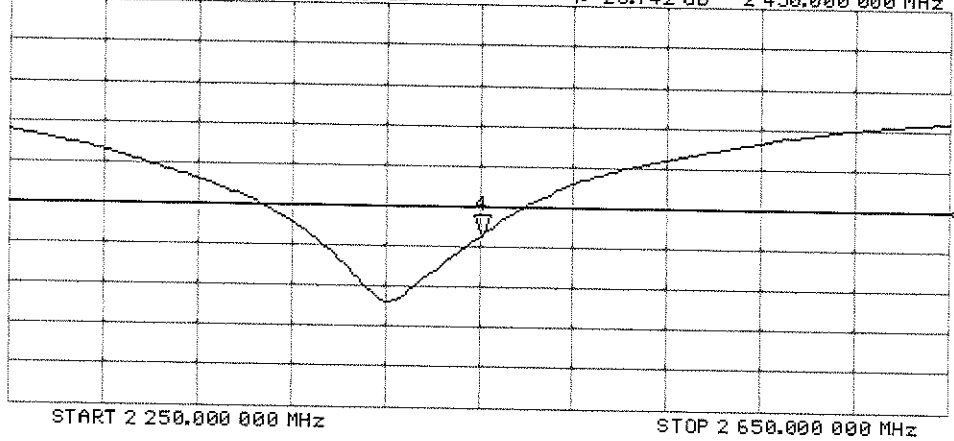



Accredited by the Swiss Accreditation Service (SAS)
The Swiss Accreditation Service is one of the signatories to the EA
Multilateral Agreement for the recognition of calibration certificates

Accreditation No.: **SCS 0108**

Client **PC Test**

Certificate No: **D5GHzV2-1120_Feb15**

CALIBRATION CERTIFICATE

Object **D5GHzV2 - SN:1120**

Calibration procedure(s) **QA CAL-22.v2
Calibration procedure for dipole validation kits between 3-6 GHz**

*BN ✓
3/6/2015*

Calibration date: **February 17, 2015**

This calibration certificate documents the traceability to national standards, which realize the physical units of measurements (SI).
The measurements and the uncertainties with confidence probability are given on the following pages and are part of the certificate.

All calibrations have been conducted in the closed laboratory facility: environment temperature (22 ± 3)°C and humidity < 70%.

Calibration Equipment used (M&TE critical for calibration)

Primary Standards	ID #	Cal Date (Certificate No.)	Scheduled Calibration
Power meter EPM-442A	GB37480704	07-Oct-14 (No. 217-02020)	Oct-15
Power sensor HP 8481A	US37292783	07-Oct-14 (No. 217-02020)	Oct-15
Power sensor HP 8481A	MY41092317	07-Oct-14 (No. 217-02021)	Oct-15
Reference 20 dB Attenuator	SN: 5058 (20k)	03-Apr-14 (No. 217-01918)	Apr-15
Type-N mismatch combination	SN: 5047.2 / 06327	03-Apr-14 (No. 217-01921)	Apr-15
Reference Probe EX3DV4	SN: 3503	30-Dec-14 (No. EX3-3503_Dec14)	Dec-15
DAE4	SN: 601	18-Aug-14 (No. DAE4-601_Aug14)	Aug-15

Secondary Standards	ID #	Check Date (In house)	Scheduled Check
RF generator R&S SMT-06	100005	04-Aug-99 (in house check Oct-13)	In house check: Oct-16
Network Analyzer HP 8753E	US37390585 S4206	18-Oct-01 (in house check Oct-14)	In house check: Oct-15

Calibrated by: **Name** Claudio Leubler **Function** Laboratory Technician **Signature** *[Signature]*

Approved by: **Name** Katja Pokovic **Technical Manager** *[Signature]*

Issued: February 17, 2015

This calibration certificate shall not be reproduced except in full without written approval of the laboratory.



Accredited by the Swiss Accreditation Service (SAS)

The Swiss Accreditation Service is one of the signatories to the EA
Multilateral Agreement for the recognition of calibration certificates

Glossary:

TSL	tissue simulating liquid
ConvF	sensitivity in TSL / NORM x,y,z
N/A	not applicable or not measured

Calibration is Performed According to the Following Standards:

- IEC 62209-2, "Evaluation of Human Exposure to Radio Frequency Fields from Handheld and Body-Mounted Wireless Communication Devices in the Frequency Range of 30 MHz to 6 GHz: Human models, Instrumentation, and Procedures"; Part 2: "Procedure to determine the Specific Absorption Rate (SAR) for including accessories and multiple transmitters", March 2010
- KDB 865664, "SAR Measurement Requirements for 100 MHz to 6 GHz"
- IEEE Std 1528-2013, "IEEE Recommended Practice for Determining the Peak Spatial-Averaged Specific Absorption Rate (SAR) in the Human Head from Wireless Communications Devices: Measurement Techniques", June 2013

Additional Documentation:

- DASY4/5 System Handbook

Methods Applied and Interpretation of Parameters:

- Measurement Conditions:** Further details are available from the Validation Report at the end of the certificate. All figures stated in the certificate are valid at the frequency indicated.
- Antenna Parameters with TSL:** The dipole is mounted with the spacer to position its feed point exactly below the center marking of the flat phantom section, with the arms oriented parallel to the body axis.
- Feed Point Impedance and Return Loss:** These parameters are measured with the dipole positioned under the liquid filled phantom. The impedance stated is transformed from the measurement at the SMA connector to the feed point. The Return Loss ensures low reflected power. No uncertainty required.
- Electrical Delay:** One-way delay between the SMA connector and the antenna feed point. No uncertainty required.
- SAR measured:** SAR measured at the stated antenna input power.
- SAR normalized:** SAR as measured, normalized to an input power of 1 W at the antenna connector.
- SAR for nominal TSL parameters:** The measured TSL parameters are used to calculate the nominal SAR result.

The reported uncertainty of measurement is stated as the standard uncertainty of measurement multiplied by the coverage factor $k=2$, which for a normal distribution corresponds to a coverage probability of approximately 95%.

Measurement Conditions

DASY system configuration, as far as not given on page 1.

DASY Version	DASY5	V52.8.8
Extrapolation	Advanced Extrapolation	
Phantom	Modular Flat Phantom V5.0	
Distance Dipole Center - TSL	10 mm	with Spacer
Zoom Scan Resolution	dx, dy = 4.0 mm, dz = 1.4 mm	Graded Ratio = 1.4 (Z direction)
Frequency	5200 MHz ± 1 MHz 5300 MHz ± 1 MHz 5500 MHz ± 1 MHz 5600 MHz ± 1 MHz 5800 MHz ± 1 MHz	

Head TSL parameters at 5200 MHz

The following parameters and calculations were applied.

	Temperature	Permittivity	Conductivity
Nominal Head TSL parameters	22.0 °C	36.0	4.66 mho/m
Measured Head TSL parameters	(22.0 ± 0.2) °C	35.4 ± 6 %	4.54 mho/m ± 6 %
Head TSL temperature change during test	< 0.5 °C	----	----

SAR result with Head TSL at 5200 MHz

SAR averaged over 1 cm³ (1 g) of Head TSL	Condition	
SAR measured	100 mW input power	7.81 W/kg
SAR for nominal Head TSL parameters	normalized to 1W	77.8 W/kg ± 19.9 % (k=2)

SAR averaged over 10 cm³ (10 g) of Head TSL	condition	
SAR measured	100 mW input power	2.24 W/kg
SAR for nominal Head TSL parameters	normalized to 1W	22.3 W/kg ± 19.5 % (k=2)

Head TSL parameters at 5300 MHz

The following parameters and calculations were applied.

	Temperature	Permittivity	Conductivity
Nominal Head TSL parameters	22.0 °C	35.9	4.76 mho/m
Measured Head TSL parameters	(22.0 ± 0.2) °C	35.2 ± 6 %	4.64 mho/m ± 6 %
Head TSL temperature change during test	< 0.5 °C	----	----

SAR result with Head TSL at 5300 MHz

SAR averaged over 1 cm ³ (1 g) of Head TSL	Condition	
SAR measured	100 mW input power	8.15 W/kg
SAR for nominal Head TSL parameters	normalized to 1W	81.1 W / kg ± 19.9 % (k=2)

SAR averaged over 10 cm ³ (10 g) of Head TSL	condition	
SAR measured	100 mW input power	2.33 W/kg
SAR for nominal Head TSL parameters	normalized to 1W	23.2 W/kg ± 19.5 % (k=2)

Head TSL parameters at 5500 MHz

The following parameters and calculations were applied.

	Temperature	Permittivity	Conductivity
Nominal Head TSL parameters	22.0 °C	35.6	4.96 mho/m
Measured Head TSL parameters	(22.0 ± 0.2) °C	35.0 ± 6 %	4.83 mho/m ± 6 %
Head TSL temperature change during test	< 0.5 °C	----	----

SAR result with Head TSL at 5500 MHz

SAR averaged over 1 cm ³ (1 g) of Head TSL	Condition	
SAR measured	100 mW input power	8.21 W/kg
SAR for nominal Head TSL parameters	normalized to 1W	81.7 W/kg ± 19.9 % (k=2)

SAR averaged over 10 cm ³ (10 g) of Head TSL	condition	
SAR measured	100 mW input power	2.32 W/kg
SAR for nominal Head TSL parameters	normalized to 1W	23.1 W/kg ± 19.5 % (k=2)

Head TSL parameters at 5600 MHz

The following parameters and calculations were applied.

	Temperature	Permittivity	Conductivity
Nominal Head TSL parameters	22.0 °C	35.5	5.07 mho/m
Measured Head TSL parameters	(22.0 ± 0.2) °C	34.8 ± 6 %	4.94 mho/m ± 6 %
Head TSL temperature change during test	< 0.5 °C	----	----

SAR result with Head TSL at 5600 MHz

SAR averaged over 1 cm ³ (1 g) of Head TSL	Condition	
SAR measured	100 mW input power	8.03 W/kg
SAR for nominal Head TSL parameters	normalized to 1W	79.9 W/kg ± 19.9 % (k=2)

SAR averaged over 10 cm ³ (10 g) of Head TSL	condition	
SAR measured	100 mW input power	2.29 W/kg
SAR for nominal Head TSL parameters	normalized to 1W	22.8 W/kg ± 19.5 % (k=2)

Head TSL parameters at 5800 MHz

The following parameters and calculations were applied.

	Temperature	Permittivity	Conductivity
Nominal Head TSL parameters	22.0 °C	35.3	5.27 mho/m
Measured Head TSL parameters	(22.0 ± 0.2) °C	34.5 ± 6 %	5.15 mho/m ± 6 %
Head TSL temperature change during test	< 0.5 °C	----	----

SAR result with Head TSL at 5800 MHz

SAR averaged over 1 cm ³ (1 g) of Head TSL	Condition	
SAR measured	100 mW input power	7.77 W/kg
SAR for nominal Head TSL parameters	normalized to 1W	77.3 W/kg ± 19.9 % (k=2)

SAR averaged over 10 cm ³ (10 g) of Head TSL	condition	
SAR measured	100 mW input power	2.21 W/kg
SAR for nominal Head TSL parameters	normalized to 1W	22.0 W/kg ± 19.5 % (k=2)

Body TSL parameters at 5200 MHz

The following parameters and calculations were applied.

	Temperature	Permittivity	Conductivity
Nominal Body TSL parameters	22.0 °C	49.0	5.30 mho/m
Measured Body TSL parameters	(22.0 ± 0.2) °C	48.5 ± 6 %	5.46 mho/m ± 6 %
Body TSL temperature change during test	< 0.5 °C	----	----

SAR result with Body TSL at 5200 MHz

SAR averaged over 1 cm ³ (1 g) of Body TSL	Condition	
SAR measured	100 mW input power	7.44 W/kg
SAR for nominal Body TSL parameters	normalized to 1W	74.3 W/kg ± 19.9 % (k=2)

SAR averaged over 10 cm ³ (10 g) of Body TSL	condition	
SAR measured	100 mW input power	2.08 W/kg
SAR for nominal Body TSL parameters	normalized to 1W	20.8 W/kg ± 19.5 % (k=2)

Body TSL parameters at 5300 MHz

The following parameters and calculations were applied.

	Temperature	Permittivity	Conductivity
Nominal Body TSL parameters	22.0 °C	48.9	5.42 mho/m
Measured Body TSL parameters	(22.0 ± 0.2) °C	48.3 ± 6 %	5.59 mho/m ± 6 %
Body TSL temperature change during test	< 0.5 °C	----	----

SAR result with Body TSL at 5300 MHz

SAR averaged over 1 cm ³ (1 g) of Body TSL	Condition	
SAR measured	100 mW input power	7.53 W/kg
SAR for nominal Body TSL parameters	normalized to 1W	75.2 W/kg ± 19.9 % (k=2)

SAR averaged over 10 cm ³ (10 g) of Body TSL	condition	
SAR measured	100 mW input power	2.11 W/kg
SAR for nominal Body TSL parameters	normalized to 1W	21.1 W/kg ± 19.5 % (k=2)

Body TSL parameters at 5500 MHz

The following parameters and calculations were applied.

	Temperature	Permittivity	Conductivity
Nominal Body TSL parameters	22.0 °C	48.6	5.65 mho/m
Measured Body TSL parameters	(22.0 ± 0.2) °C	47.9 ± 6 %	5.85 mho/m ± 6 %
Body TSL temperature change during test	< 0.5 °C	----	----

SAR result with Body TSL at 5500 MHz

SAR averaged over 1 cm ³ (1 g) of Body TSL	Condition	
SAR measured	100 mW input power	7.96 W/kg
SAR for nominal Body TSL parameters	normalized to 1W	79.5 W/kg ± 19.9 % (k=2)

SAR averaged over 10 cm ³ (10 g) of Body TSL	condition	
SAR measured	100 mW input power	2.21 W/kg
SAR for nominal Body TSL parameters	normalized to 1W	22.1 W/kg ± 19.5 % (k=2)

Body TSL parameters at 5600 MHz

The following parameters and calculations were applied.

	Temperature	Permittivity	Conductivity
Nominal Body TSL parameters	22.0 °C	48.5	5.77 mho/m
Measured Body TSL parameters	(22.0 ± 0.2) °C	47.7 ± 6 %	5.99 mho/m ± 6 %
Body TSL temperature change during test	< 0.5 °C	----	----

SAR result with Body TSL at 5600 MHz

SAR averaged over 1 cm ³ (1 g) of Body TSL	Condition	
SAR measured	100 mW input power	7.75 W/kg
SAR for nominal Body TSL parameters	normalized to 1W	77.4 W/kg ± 19.9 % (k=2)

SAR averaged over 10 cm ³ (10 g) of Body TSL	condition	
SAR measured	100 mW input power	2.15 W/kg
SAR for nominal Body TSL parameters	normalized to 1W	21.4 W/kg ± 19.5 % (k=2)

Body TSL parameters at 5800 MHz

The following parameters and calculations were applied.

	Temperature	Permittivity	Conductivity
Nominal Body TSL parameters	22.0 °C	48.2	6.00 mho/m
Measured Body TSL parameters	(22.0 ± 0.2) °C	47.4 ± 6 %	6.28 mho/m ± 6 %
Body TSL temperature change during test	< 0.5 °C	----	----

SAR result with Body TSL at 5800 MHz

SAR averaged over 1 cm ³ (1 g) of Body TSL	Condition	
SAR measured	100 mW input power	7.64 W/kg
SAR for nominal Body TSL parameters	normalized to 1W	76.3 W/kg ± 19.9 % (k=2)

SAR averaged over 10 cm ³ (10 g) of Body TSL	condition	
SAR measured	100 mW input power	2.10 W/kg
SAR for nominal Body TSL parameters	normalized to 1W	20.9 W/kg ± 19.5 % (k=2)

Appendix (Additional assessments outside the scope of SCS0108)

Antenna Parameters with Head TSL at 5200 MHz

Impedance, transformed to feed point	53.7 Ω - 5.4 j Ω
Return Loss	- 24.0 dB

Antenna Parameters with Head TSL at 5300 MHz

Impedance, transformed to feed point	50.1 Ω + 2.0 j Ω
Return Loss	- 34.0 dB

Antenna Parameters with Head TSL at 5500 MHz

Impedance, transformed to feed point	50.9 Ω - 2.5 j Ω
Return Loss	- 31.6 dB

Antenna Parameters with Head TSL at 5600 MHz

Impedance, transformed to feed point	58.4 Ω + 0.2 j Ω
Return Loss	- 22.2 dB

Antenna Parameters with Head TSL at 5800 MHz

Impedance, transformed to feed point	51.5 Ω + 2.6 j Ω
Return Loss	- 30.5 dB

Antenna Parameters with Body TSL at 5200 MHz

Impedance, transformed to feed point	52.9 Ω - 3.6 j Ω
Return Loss	- 26.9 dB

Antenna Parameters with Body TSL at 5300 MHz

Impedance, transformed to feed point	49.9 Ω + 2.8 j Ω
Return Loss	- 31.0 dB

Antenna Parameters with Body TSL at 5500 MHz

Impedance, transformed to feed point	51.4 Ω - 1.4 j Ω
Return Loss	- 34.3 dB

Antenna Parameters with Body TSL at 5600 MHz

Impedance, transformed to feed point	58.5 Ω + 1.9 j Ω
Return Loss	- 21.9 dB

Antenna Parameters with Body TSL at 5800 MHz

Impedance, transformed to feed point	51.8 Ω + 4.3 j Ω
Return Loss	- 26.8 dB

General Antenna Parameters and Design

Electrical Delay (one direction)	1.207 ns
----------------------------------	----------

After long term use with 100W radiated power, only a slight warming of the dipole near the feedpoint can be measured.

The dipole is made of standard semirigid coaxial cable. The center conductor of the feeding line is directly connected to the second arm of the dipole. The antenna is therefore short-circuited for DC-signals. On some of the dipoles, small end caps are added to the dipole arms in order to improve matching when loaded according to the position as explained in the "Measurement Conditions" paragraph. The SAR data are not affected by this change. The overall dipole length is still according to the Standard.

No excessive force must be applied to the dipole arms, because they might bend or the soldered connections near the feedpoint may be damaged.

Additional EUT Data

Manufactured by	SPEAG
Manufactured on	September 08, 2011

Test Laboratory: SPEAG, Zurich, Switzerland

DUT: Dipole 5GHz; Type: D5GHzV2; Serial: D5GHzV2 - SN:1120

Communication System: UID 0 - CW; Frequency: 5200 MHz, Frequency: 5300 MHz, Frequency: 5500 MHz, Frequency: 5600 MHz, Frequency: 5800 MHz

Medium parameters used: $f = 5200$ MHz; $\sigma = 4.54$ S/m; $\epsilon_r = 35.4$; $\rho = 1000$ kg/m³,

Medium parameters used: $f = 5300$ MHz; $\sigma = 4.64$ S/m; $\epsilon_r = 35.2$; $\rho = 1000$ kg/m³,

Medium parameters used: $f = 5500$ MHz; $\sigma = 4.83$ S/m; $\epsilon_r = 35$; $\rho = 1000$ kg/m³,

Medium parameters used: $f = 5600$ MHz; $\sigma = 4.94$ S/m; $\epsilon_r = 34.8$; $\rho = 1000$ kg/m³,

Medium parameters used: $f = 5800$ MHz; $\sigma = 5.15$ S/m; $\epsilon_r = 34.5$; $\rho = 1000$ kg/m³

Phantom section: Flat Section

Measurement Standard: DASY5 (IEEE/IEC/ANSI C63.19-2011)

DASY52 Configuration:

- Probe: EX3DV4 - SN3503; ConvF(5.51, 5.51, 5.51); Calibrated: 30.12.2014, ConvF(5.21, 5.21, 5.21); Calibrated: 30.12.2014, ConvF(5.12, 5.12, 5.12); Calibrated: 30.12.2014, ConvF(4.92, 4.92, 4.92); Calibrated: 30.12.2014, ConvF(4.9, 4.9, 4.9); Calibrated: 30.12.2014;
- Sensor-Surface: 1.4mm (Mechanical Surface Detection)
- Electronics: DAE4 Sn601; Calibrated: 18.08.2014
- Phantom: Flat Phantom 5.0 (front); Type: QD000P50AA; Serial: 1001
- DASY52 52.8.8(1222); SEMCAD X 14.6.10(7331)

Dipole Calibration for Head Tissue/Pin=100mW, dist=10mm, f=5200 MHz/Zoom Scan, dist=1.4mm (8x8x7)/Cube 0: Measurement grid: dx=4mm, dy=4mm, dz=1.4mm

Reference Value = 64.11 V/m; Power Drift = 0.07 dB

Peak SAR (extrapolated) = 28.3 W/kg

SAR(1 g) = 7.81 W/kg; SAR(10 g) = 2.24 W/kg

Maximum value of SAR (measured) = 17.8 W/kg

Dipole Calibration for Head Tissue/Pin=100mW, dist=10mm, f=5300 MHz/Zoom Scan, dist=1.4mm (8x8x7)/Cube 0: Measurement grid: dx=4mm, dy=4mm, dz=1.4mm

Reference Value = 64.53 V/m; Power Drift = 0.09 dB

Peak SAR (extrapolated) = 30.4 W/kg

SAR(1 g) = 8.15 W/kg; SAR(10 g) = 2.33 W/kg

Maximum value of SAR (measured) = 18.8 W/kg

Dipole Calibration for Head Tissue/Pin=100mW, dist=10mm, f=5500 MHz/Zoom Scan, dist=1.4mm (8x8x7)/Cube 0: Measurement grid: dx=4mm, dy=4mm, dz=1.4mm

Reference Value = 63.02 V/m; Power Drift = 0.09 dB

Peak SAR (extrapolated) = 32.0 W/kg

SAR(1 g) = 8.21 W/kg; SAR(10 g) = 2.32 W/kg

Maximum value of SAR (measured) = 19.2 W/kg

Dipole Calibration for Head Tissue/Pin=100mW, dist=10mm, f=5600 MHz/Zoom Scan, dist=1.4mm (8x8x7)/Cube 0: Measurement grid: dx=4mm, dy=4mm, dz=1.4mm
Reference Value = 63.14 V/m; Power Drift = 0.07 dB
Peak SAR (extrapolated) = 31.3 W/kg
SAR(1 g) = 8.03 W/kg; SAR(10 g) = 2.29 W/kg

Dipole Calibration for Head Tissue/Pin=100mW, dist=10mm, f=5800 MHz/Zoom Scan, dist=1.4mm (8x8x7)/Cube 0: Measurement grid: dx=4mm, dy=4mm, dz=1.4mm
Reference Value = 60.76 V/m; Power Drift = 0.06 dB
Peak SAR (extrapolated) = 31.8 W/kg
SAR(1 g) = 7.77 W/kg; SAR(10 g) = 2.21 W/kg
Maximum value of SAR (measured) = 18.7 W/kg

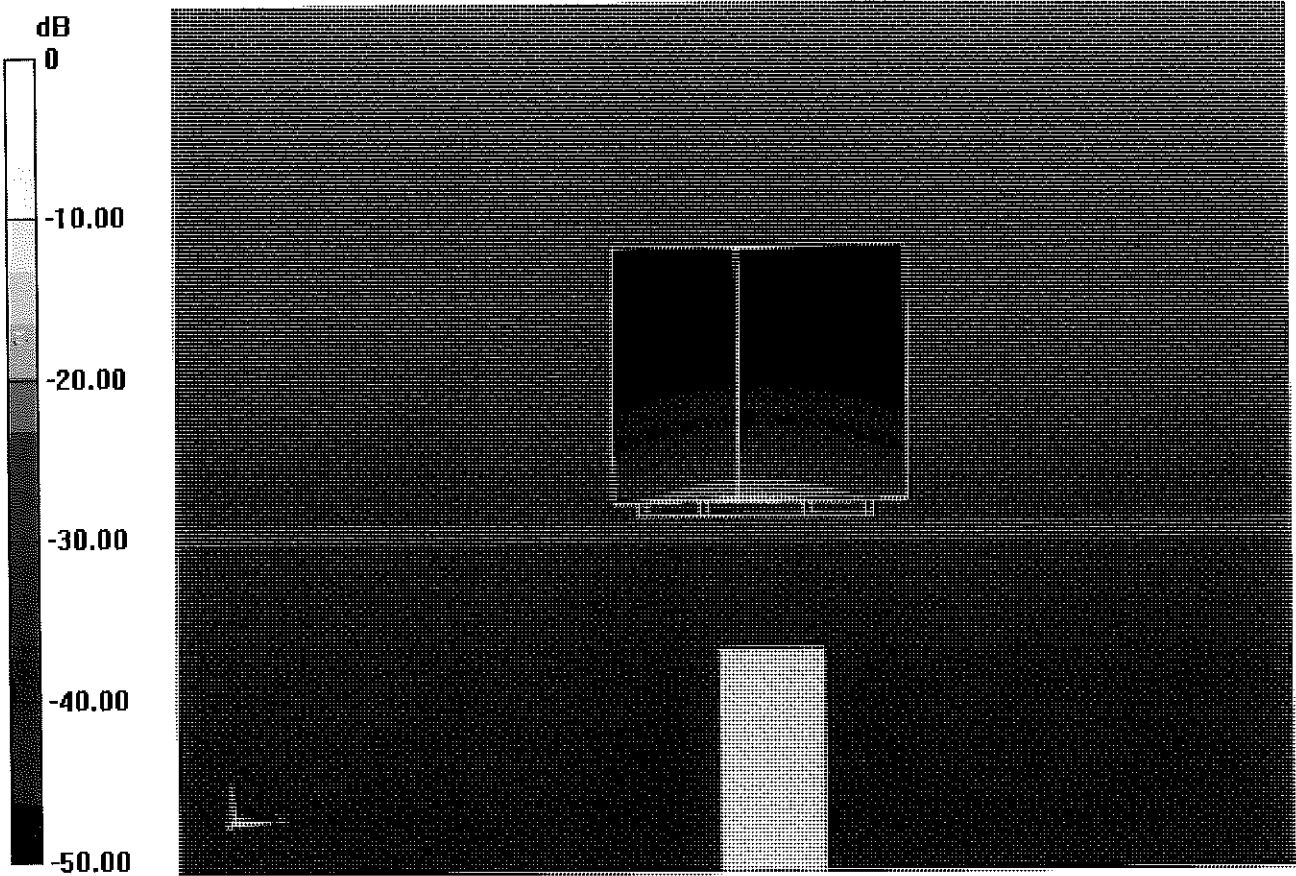

0 dB = 17.8 W/kg = 12.50 dBW/kg

Impedance Measurement Plot for Head TSL

16 Feb 2015 11:34:26

[CH1] S11 1 U FS 1: 53.650 Ω -5.4375 Ω 5.6288 pF 5 200.000 000 MHz

*
Del
Cor
Avg
16
H1d

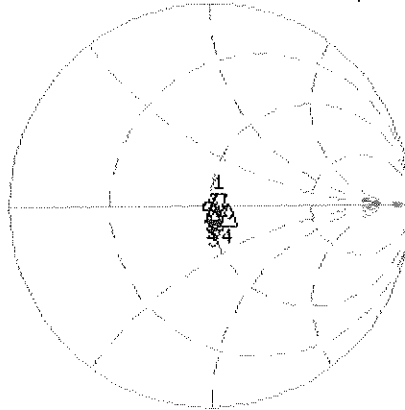

CH1 Markers
2: 50.104 Ω
1.9961 Ω
5.30000 GHz
3: 50.939 Ω
-2.4727 Ω
5.50000 GHz
4: 50.404 Ω
0.1895 Ω
5.60000 GHz
5: 51.496 Ω
2.6133 Ω
5.80000 GHz

CH2 S11 LOG 5 dB/REF -20 dB 1:-24.000 dB 5 200.000 000 MHz

Cor
Avg
16
H1d

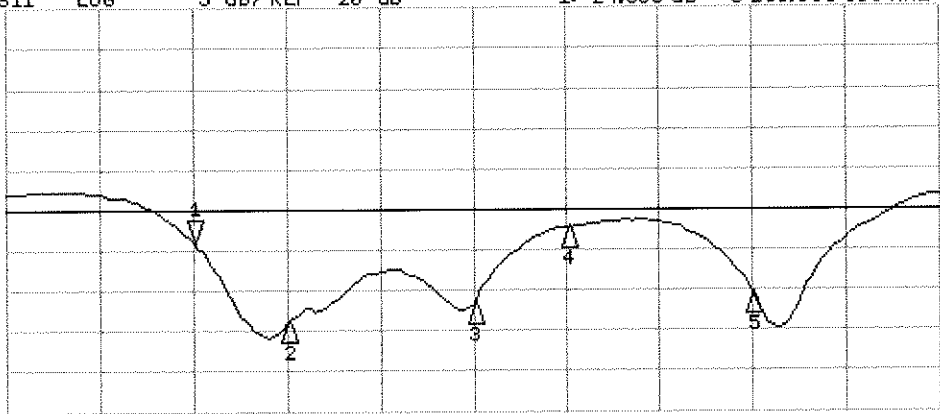

CH2 Markers
2:-33.992 dB
5.30000 GHz
3:-31.633 dB
5.50000 GHz
4:-22.210 dB
5.60000 GHz
5:-30.540 dB
5.80000 GHz

START 5 000.000 000 MHz

STOP 6 000.000 000 MHz

Test Laboratory: SPEAG, Zurich, Switzerland

DUT: Dipole 5GHz; Type: D5GHzV2; Serial: D5GHzV2 - SN:1120

Communication System: UID 0 - CW; Frequency: 5200 MHz, Frequency: 5300 MHz, Frequency: 5500 MHz, Frequency: 5600 MHz, Frequency: 5800 MHz

Medium parameters used: $f = 5200$ MHz; $\sigma = 5.46$ S/m; $\epsilon_r = 48.5$; $\rho = 1000$ kg/m³,

Medium parameters used: $f = 5300$ MHz; $\sigma = 5.59$ S/m; $\epsilon_r = 48.3$; $\rho = 1000$ kg/m³,

Medium parameters used: $f = 5500$ MHz; $\sigma = 5.85$ S/m; $\epsilon_r = 47.9$; $\rho = 1000$ kg/m³,

Medium parameters used: $f = 5600$ MHz; $\sigma = 5.99$ S/m; $\epsilon_r = 47.7$; $\rho = 1000$ kg/m³,

Medium parameters used: $f = 5800$ MHz; $\sigma = 6.28$ S/m; $\epsilon_r = 47.4$; $\rho = 1000$ kg/m³

Phantom section: Flat Section

Measurement Standard: DASY5 (IEEE/IEC/ANSI C63.19-2011)

DASY52 Configuration:

- Probe: EX3DV4 - SN3503; ConvF(4.95, 4.95, 4.95); Calibrated: 30.12.2014, ConvF(4.78, 4.78, 4.78); Calibrated: 30.12.2014, ConvF(4.45, 4.45, 4.45); Calibrated: 30.12.2014, ConvF(4.35, 4.35, 4.35); Calibrated: 30.12.2014, ConvF(4.32, 4.32, 4.32); Calibrated: 30.12.2014;
- Sensor-Surface: 1.4mm (Mechanical Surface Detection)
- Electronics: DAE4 Sn601; Calibrated: 18.08.2014
- Phantom: Flat Phantom 5.0 (back); Type: QD000P50AA; Serial: 1002
- DASY52 52.8.8(1222); SEMCAD X 14.6.10(7331)

Dipole Calibration for Body Tissue/Pin=100mW, dist=10mm, f=5200 MHz/Zoom Scan, dist=1.4mm (8x8x7)/Cube 0: Measurement grid: dx=4mm, dy=4mm, dz=1.4mm

Reference Value = 58.32 V/m; Power Drift = 0.04 dB

Peak SAR (extrapolated) = 29.5 W/kg

SAR(1 g) = 7.44 W/kg; SAR(10 g) = 2.08 W/kg

Maximum value of SAR (measured) = 17.5 W/kg

Dipole Calibration for Body Tissue/Pin=100mW, dist=10mm, f=5300 MHz/Zoom Scan, dist=1.4mm (8x8x7)/Cube 0: Measurement grid: dx=4mm, dy=4mm, dz=1.4mm

Reference Value = 57.81 V/m; Power Drift = 0.04 dB

Peak SAR (extrapolated) = 30.5 W/kg

SAR(1 g) = 7.53 W/kg; SAR(10 g) = 2.11 W/kg

Maximum value of SAR (measured) = 17.9 W/kg

Dipole Calibration for Body Tissue/Pin=100mW, dist=10mm, f=5500 MHz/Zoom Scan, dist=1.4mm (8x8x7)/Cube 0: Measurement grid: dx=4mm, dy=4mm, dz=1.4mm

Reference Value = 58.23 V/m; Power Drift = 0.04 dB

Peak SAR (extrapolated) = 34.1 W/kg

SAR(1 g) = 7.96 W/kg; SAR(10 g) = 2.21 W/kg

Maximum value of SAR (measured) = 19.2 W/kg

Dipole Calibration for Body Tissue/Pin=100mW, dist=10mm, f=5600 MHz/Zoom Scan, dist=1.4mm (8x8x7)/Cube 0: Measurement grid: dx=4mm, dy=4mm, dz=1.4mm
Reference Value = 57.03 V/m; Power Drift = 0.04 dB
Peak SAR (extrapolated) = 34.3 W/kg
SAR(1 g) = 7.75 W/kg; SAR(10 g) = 2.15 W/kg
Maximum value of SAR (measured) = 19.1 W/kg

Dipole Calibration for Body Tissue/Pin=100mW, dist=10mm, f=5800 MHz/Zoom Scan, dist=1.4mm (8x8x7)/Cube 0: Measurement grid: dx=4mm, dy=4mm, dz=1.4mm
Reference Value = 55.44 V/m; Power Drift = 0.04 dB
Peak SAR (extrapolated) = 35.8 W/kg
SAR(1 g) = 7.64 W/kg; SAR(10 g) = 2.1 W/kg

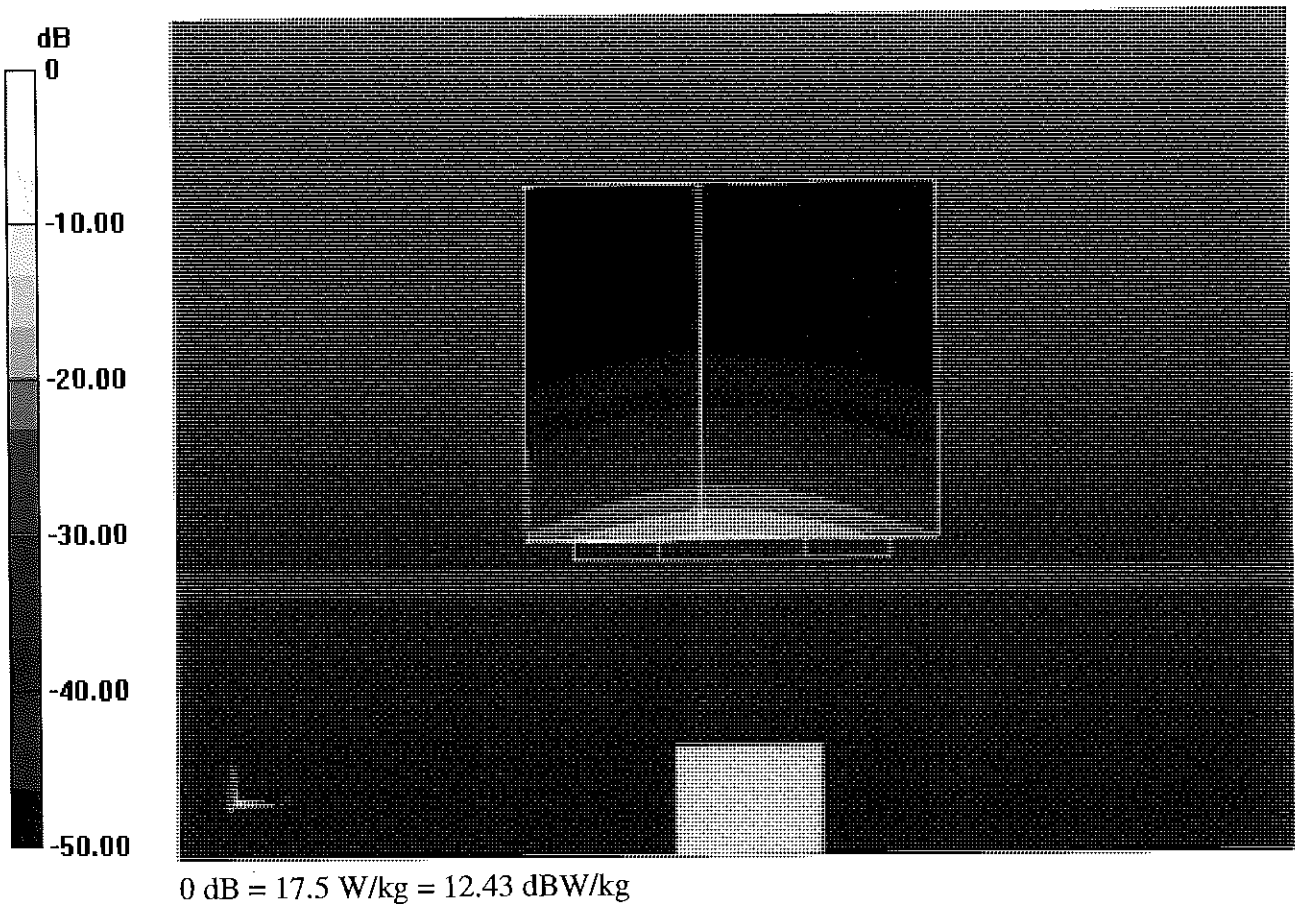

Impedance Measurement Plot for Body TSL

16 Feb 2015 11:34:01

CH1 S11 1 U FS 1: 52.871 Ω -3.6367 Ω 8.4160 pF 5 200.000 000 MHz

De1
Cor
Avg
16
H1d

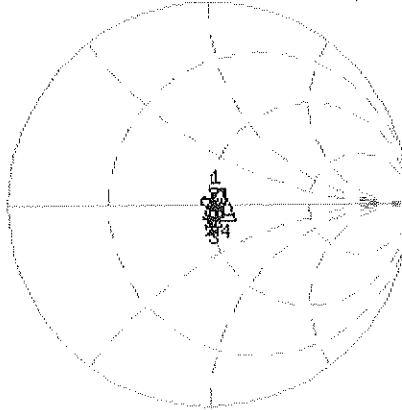

CH1 Markers
2: 49.928 Ω
2.8203 Ω
5.30000 GHz
3: 51.355 Ω
-1.4063 Ω
5.50000 GHz
4: 50.475 Ω
1.8555 Ω
5.60000 GHz
5: 51.044 Ω
4.3027 Ω
5.80000 GHz

CH2 S11 LOG 5 dB/ REF -20 dB 1: -26.930 dB 5 200.000 000 MHz

Cor
Avg
16
H1d

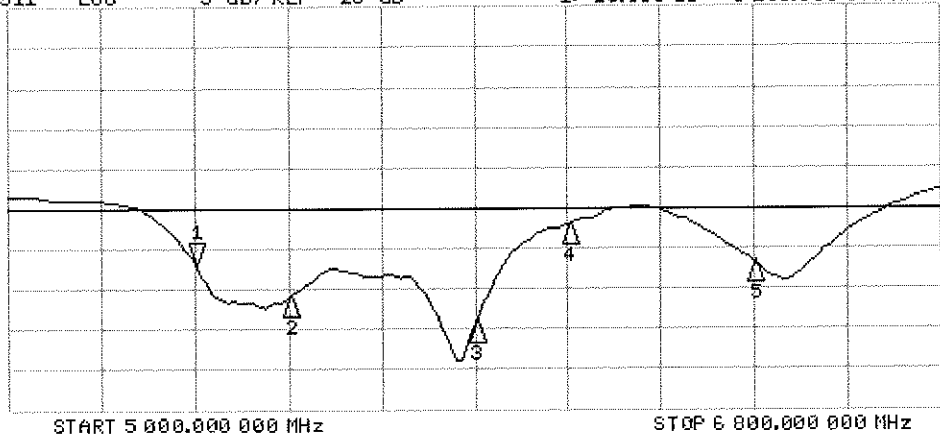

CH2 Markers
2: -30.981 dB
5.30000 GHz
3: -34.300 dB
5.50000 GHz
4: -21.944 dB
5.60000 GHz
5: -26.760 dB
5.80000 GHz



Accredited by the Swiss Accreditation Service (SAS)
The Swiss Accreditation Service is one of the signatories to the EA
Multilateral Agreement for the recognition of calibration certificates

Accreditation No.: **SCS 0108**

Client **PC Test**

Certificate No: **D835V2-4d119_Apr15**

CALIBRATION CERTIFICATE

Object **D835V2 - SN:4d119**

Calibration procedure(s) **QA CAL-05.v9**
Calibration procedure for dipole validation kits above 700 MHz

Calibration date: **April 13, 2015**

RY ✓
4/29/15

This calibration certificate documents the traceability to national standards, which realize the physical units of measurements (SI).
The measurements and the uncertainties with confidence probability are given on the following pages and are part of the certificate.

All calibrations have been conducted in the closed laboratory facility: environment temperature (22 ± 3)°C and humidity < 70%.

Calibration Equipment used (M&TE critical for calibration)

Primary Standards	ID #	Cal Date (Certificate No.)	Scheduled Calibration
Power meter EPM-442A	GB37480704	07-Oct-14 (No. 217-02020)	Oct-15
Power sensor HP 8481A	US37292783	07-Oct-14 (No. 217-02020)	Oct-15
Power sensor HP 8481A	MY41092317	07-Oct-14 (No. 217-02021)	Oct-15
Reference 20 dB Attenuator	SN: 5058 (20k)	01-Apr-15 (No. 217-02131)	Mar-16
Type-N mismatch combination	SN: 5047.2 / 06327	01-Apr-15 (No. 217-02134)	Mar-16
Reference Probe ES3DV3	SN: 3205	30-Dec-14 (No. ES3-3205_Dec14)	Dec-15
DAE4	SN: 601	18-Aug-14 (No. DAE4-601_Aug14)	Aug-15
Secondary Standards	ID #	Check Date (in house)	Scheduled Check
RF generator R&S SMT-06	100005	04-Aug-99 (in house check Oct-13)	In house check: Oct-16
Network Analyzer HP 8753E	US37390585 S4206	18-Oct-01 (in house check Oct-14)	In house check: Oct-15

Calibrated by: **Israe Elnaouq** (Name) **Laboratory Technician** (Function) *[Signature]* (Signature)

Approved by: **Katja Pokovic** (Name) **Technical Manager** (Function) *[Signature]* (Signature)

Issued: April 13, 2015

This calibration certificate shall not be reproduced except in full without written approval of the laboratory.



Accredited by the Swiss Accreditation Service (SAS)
The Swiss Accreditation Service is one of the signatories to the EA
Multilateral Agreement for the recognition of calibration certificates

Accreditation No.: **SCS 0108**

Glossary:

TSL	tissue simulating liquid
ConvF	sensitivity in TSL / NORM x,y,z
N/A	not applicable or not measured

Calibration is Performed According to the Following Standards:

- IEEE Std 1528-2013, "IEEE Recommended Practice for Determining the Peak Spatial-Averaged Specific Absorption Rate (SAR) in the Human Head from Wireless Communications Devices: Measurement Techniques", June 2013
- IEC 62209-1, "Procedure to measure the Specific Absorption Rate (SAR) for hand-held devices used in close proximity to the ear (frequency range of 300 MHz to 3 GHz)", February 2005
- KDB 865664, "SAR Measurement Requirements for 100 MHz to 6 GHz"

Additional Documentation:

- DASY4/5 System Handbook

Methods Applied and Interpretation of Parameters:

- Measurement Conditions:* Further details are available from the Validation Report at the end of the certificate. All figures stated in the certificate are valid at the frequency indicated.
- Antenna Parameters with TSL:* The dipole is mounted with the spacer to position its feed point exactly below the center marking of the flat phantom section, with the arms oriented parallel to the body axis.
- Feed Point Impedance and Return Loss:* These parameters are measured with the dipole positioned under the liquid filled phantom. The impedance stated is transformed from the measurement at the SMA connector to the feed point. The Return Loss ensures low reflected power. No uncertainty required.
- Electrical Delay:* One-way delay between the SMA connector and the antenna feed point. No uncertainty required.
- SAR measured:* SAR measured at the stated antenna input power.
- SAR normalized:* SAR as measured, normalized to an input power of 1 W at the antenna connector.
- SAR for nominal TSL parameters:* The measured TSL parameters are used to calculate the nominal SAR result.

The reported uncertainty of measurement is stated as the standard uncertainty of measurement multiplied by the coverage factor $k=2$, which for a normal distribution corresponds to a coverage probability of approximately 95%.

Measurement Conditions

DASY system configuration, as far as not given on page 1.

DASY Version	DASY5	V52.8.8
Extrapolation	Advanced Extrapolation	
Phantom	Modular Flat Phantom	
Distance Dipole Center - TSL	15 mm	with Spacer
Zoom Scan Resolution	dx, dy, dz = 5 mm	
Frequency	835 MHz \pm 1 MHz	

Head TSL parameters

The following parameters and calculations were applied.

	Temperature	Permittivity	Conductivity
Nominal Head TSL parameters	22.0 °C	41.5	0.90 mho/m
Measured Head TSL parameters	(22.0 \pm 0.2) °C	40.9 \pm 6 %	0.94 mho/m \pm 6 %
Head TSL temperature change during test	< 0.5 °C	----	----

SAR result with Head TSL

SAR averaged over 1 cm ³ (1 g) of Head TSL	Condition	
SAR measured	250 mW input power	2.43 W/kg
SAR for nominal Head TSL parameters	normalized to 1W	9.38 W/kg \pm 17.0 % (k=2)

SAR averaged over 10 cm ³ (10 g) of Head TSL	condition	
SAR measured	250 mW input power	1.57 W/kg
SAR for nominal Head TSL parameters	normalized to 1W	6.11 W/kg \pm 16.5 % (k=2)

Body TSL parameters

The following parameters and calculations were applied.

	Temperature	Permittivity	Conductivity
Nominal Body TSL parameters	22.0 °C	55.2	0.97 mho/m
Measured Body TSL parameters	(22.0 \pm 0.2) °C	55.4 \pm 6 %	1.01 mho/m \pm 6 %
Body TSL temperature change during test	< 0.5 °C	----	----

SAR result with Body TSL

SAR averaged over 1 cm ³ (1 g) of Body TSL	Condition	
SAR measured	250 mW input power	2.37 W/kg
SAR for nominal Body TSL parameters	normalized to 1W	9.20 W/kg \pm 17.0 % (k=2)

SAR averaged over 10 cm ³ (10 g) of Body TSL	condition	
SAR measured	250 mW input power	1.55 W/kg
SAR for nominal Body TSL parameters	normalized to 1W	6.06 W/kg \pm 16.5 % (k=2)

Appendix (Additional assessments outside the scope of SCS 0108)

Antenna Parameters with Head TSL

Impedance, transformed to feed point	50.2 Ω - 2.2 j Ω
Return Loss	- 33.3 dB

Antenna Parameters with Body TSL

Impedance, transformed to feed point	47.7 Ω - 4.9 j Ω
Return Loss	- 25.1 dB

General Antenna Parameters and Design

Electrical Delay (one direction)	1.386 ns
----------------------------------	----------

After long term use with 100W radiated power, only a slight warming of the dipole near the feedpoint can be measured.

The dipole is made of standard semirigid coaxial cable. The center conductor of the feeding line is directly connected to the second arm of the dipole. The antenna is therefore short-circuited for DC-signals. On some of the dipoles, small end caps are added to the dipole arms in order to improve matching when loaded according to the position as explained in the "Measurement Conditions" paragraph. The SAR data are not affected by this change. The overall dipole length is still according to the Standard.

No excessive force must be applied to the dipole arms, because they might bend or the soldered connections near the feedpoint may be damaged.

Additional EUT Data

Manufactured by	SPEAG
Manufactured on	June 29, 2010

DASY5 Validation Report for Head TSL

Date: 13.04.2015

Test Laboratory: SPEAG, Zurich, Switzerland

DUT: Dipole 835 MHz; Type: D835V2; Serial: D835V2 - SN:4d119

Communication System: UID 0 - CW; Frequency: 835 MHz

Medium parameters used: $f = 835 \text{ MHz}$; $\sigma = 0.94 \text{ S/m}$; $\epsilon_r = 40.9$; $\rho = 1000 \text{ kg/m}^3$

Phantom section: Flat Section

Measurement Standard: DASY5 (IEEE/IEC/ANSI C63.19-2011)

DASY52 Configuration:

- Probe: ES3DV3 - SN3205; ConvF(6.2, 6.2, 6.2); Calibrated: 30.12.2014;
- Sensor-Surface: 3mm (Mechanical Surface Detection)
- Electronics: DAE4 Sn601; Calibrated: 18.08.2014
- Phantom: Flat Phantom 4.9L; Type: QD000P49AA; Serial: 1001
- DASY52 52.8.8(1222); SEMCAD X 14.6.10(7331)

Dipole Calibration for Head Tissue/Pin=250 mW, $d=15\text{mm}$ /Zoom Scan (7x7x7)/Cube 0:

Measurement grid: $dx=5\text{mm}$, $dy=5\text{mm}$, $dz=5\text{mm}$

Reference Value = 56.77 V/m; Power Drift = 0.01 dB

Peak SAR (extrapolated) = 3.64 W/kg

SAR(1 g) = 2.43 W/kg; SAR(10 g) = 1.57 W/kg

Maximum value of SAR (measured) = 2.85 W/kg

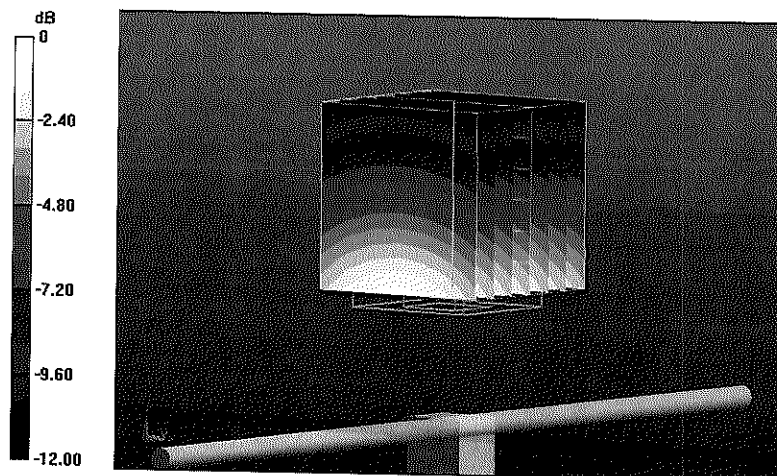

0 dB = 2.85 W/kg = 4.55 dBW/kg

Impedance Measurement Plot for Head TSL

CH1 S11 1 U FS 13 Apr 2015 13:42:59
 2: 50.213 Ω -2.1602 \angle 88.237 μ F 835.000 000 MHz

*
 De1
 CA
 Avg
 16
 H1 d

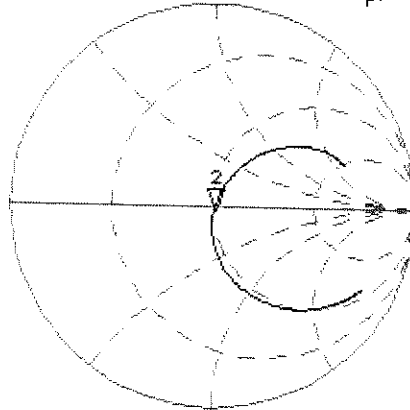

CH2 S11 LOG 5 dB/REF -20 dB 2: -33.275 dB 835.000 000 MHz

CA
 Avg
 16
 H1 d

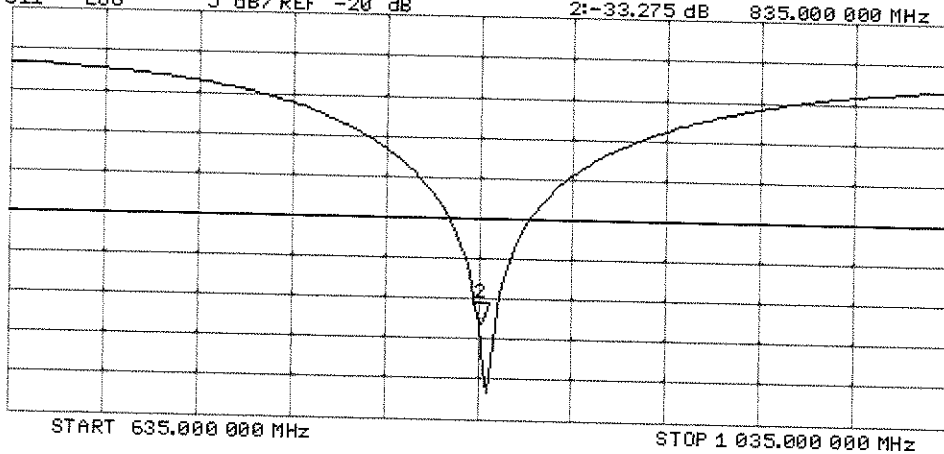

DASY5 Validation Report for Body TSL

Date: 13.04.2015

Test Laboratory: SPEAG, Zurich, Switzerland

DUT: Dipole 835 MHz; Type: D835V2; Serial: D835V2 - SN:4d119

Communication System: UID 0 - CW; Frequency: 835 MHz

Medium parameters used: $f = 835$ MHz; $\sigma = 1.01$ S/m; $\epsilon_r = 55.4$; $\rho = 1000$ kg/m³

Phantom section: Flat Section

Measurement Standard: DASY5 (IEEE/IEC/ANSI C63.19-2011)

DASY52 Configuration:

- Probe: ES3DV3 - SN3205; ConvF(6.17, 6.17, 6.17); Calibrated: 30.12.2014;
- Sensor-Surface: 3mm (Mechanical Surface Detection)
- Electronics: DAE4 Sn601; Calibrated: 18.08.2014
- Phantom: Flat Phantom 4.9L; Type: QD000P49AA; Serial: 1001
- DASY52 52.8.8(1222); SEMCAD X 14.6.10(7331)

Dipole Calibration for Body Tissue/Pin=250 mW, d=15mm/Zoom Scan (7x7x7)/Cube 0:

Measurement grid: dx=5mm, dy=5mm, dz=5mm

Reference Value = 54.44 V/m; Power Drift = -0.06 dB

Peak SAR (extrapolated) = 3.52 W/kg

SAR(1 g) = 2.37 W/kg; SAR(10 g) = 1.55 W/kg

Maximum value of SAR (measured) = 2.77 W/kg

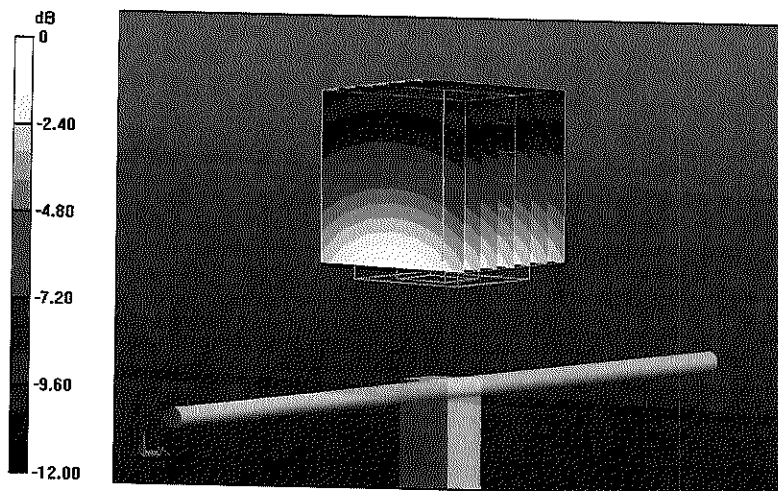

0 dB = 2.77 W/kg = 4.42 dBW/kg

Impedance Measurement Plot for Body TSL

CH1 S11 1 U FS 13 Apr 2015 10:53:33
 2: 47.658 Ω -4.9043 Ω 38.865 pF 835.000 000 MHz

*
 Del
 CA
 Avg
 16
 H1 d

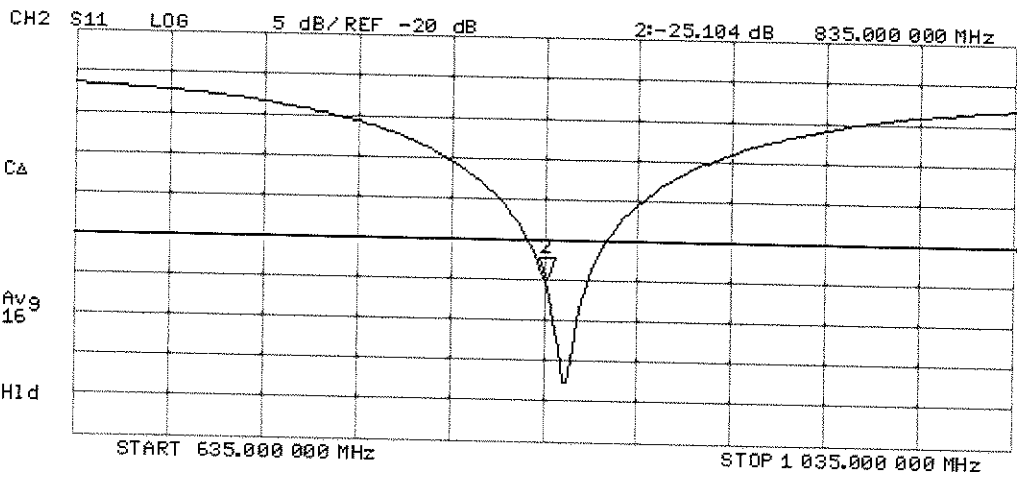
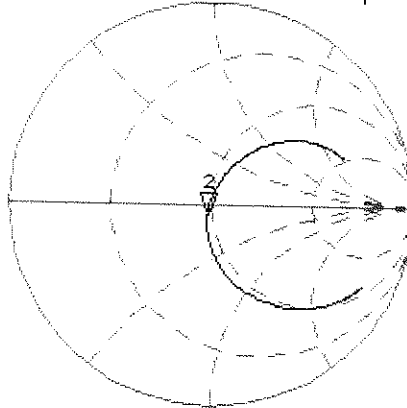



Accredited by the Swiss Accreditation Service (SAS)
The Swiss Accreditation Service is one of the signatories to the EA
Multilateral Agreement for the recognition of calibration certificates

Accreditation No.: **SCS 0108**

Client **PC Test**

Certificate No: **D5GHzV2-1191_Sep15**

CALIBRATION CERTIFICATE

Object **D5GHzV2 - SN: 1191**

Calibration procedure(s) **QA CAL-22.v2
Calibration procedure for dipole validation kits between 3-6 GHz**

*BN ✓
10/22/15*

Calibration date: **September 16, 2015**

This calibration certificate documents the traceability to national standards, which realize the physical units of measurements (SI).
The measurements and the uncertainties with confidence probability are given on the following pages and are part of the certificate.

All calibrations have been conducted in the closed laboratory facility: environment temperature (22 ± 3)°C and humidity < 70%.

Calibration Equipment used (M&TE critical for calibration)

Primary Standards	ID #	Cal Date (Certificate No.)	Scheduled Calibration
Power meter EPM-442A	GB37480704	07-Oct-14 (No. 217-02020)	Oct-15
Power sensor HP 8481A	US37292783	07-Oct-14 (No. 217-02020)	Oct-15
Power sensor HP 8481A	MY41092317	07-Oct-14 (No. 217-02021)	Oct-15
Reference 20 dB Attenuator	SN: 5058 (20k)	01-Apr-15 (No. 217-02131)	Mar-16
Type-N mismatch combination	SN: 6047.2 / 08327	01-Apr-15 (No. 217-02134)	Mar-16
Reference Probe EX3DV4	SN: 3503	30-Dec-14 (No. EX3-3503_Dec14)	Dec-15
DAE4	SN: 601	17-Aug-15 (No. DAE4-601_Aug15)	Aug-16

Secondary Standards	ID #	Check Date (in house)	Scheduled Check
RF generator R&S SMT-06	100972	15-Jun-15 (in house check Jun-15)	In house check: Jun-18
Network Analyzer HP 8753E	US37390585 S4206	18-Oct-01 (in house check Oct-14)	In house check: Oct-15

Calibrated by: **Claudio Leubler** **Laboratory Technician**

Signature

Approved by: **Katja Pokovic** **Technical Manager**

Issued: September 18, 2015

This calibration certificate shall not be reproduced except in full without written approval of the laboratory.



Accredited by the Swiss Accreditation Service (SAS)

The Swiss Accreditation Service is one of the signatories to the EA
Multilateral Agreement for the recognition of calibration certificates

Accreditation No.: **SCS 0108**

Glossary:

TSL	tissue simulating liquid
ConvF	sensitivity in TSL / NORM x,y,z
N/A	not applicable or not measured

Calibration is Performed According to the Following Standards:

- IEEE Std 1528-2013, "IEEE Recommended Practice for Determining the Peak Spatial-Averaged Specific Absorption Rate (SAR) in the Human Head from Wireless Communications Devices: Measurement Techniques", June 2013
- IEC 62209-2, "Procedure to determine the Specific Absorption Rate (SAR) for wireless communication devices used in close proximity to the human body (frequency range of 30 MHz to 6 GHz)", March 2010
- KDB 865664, "SAR Measurement Requirements for 100 MHz to 6 GHz"

Additional Documentation:

- DASY4/5 System Handbook

Methods Applied and Interpretation of Parameters:

- Measurement Conditions:** Further details are available from the Validation Report at the end of the certificate. All figures stated in the certificate are valid at the frequency indicated.
- Antenna Parameters with TSL:** The dipole is mounted with the spacer to position its feed point exactly below the center marking of the flat phantom section, with the arms oriented parallel to the body axis.
- Feed Point Impedance and Return Loss:** These parameters are measured with the dipole positioned under the liquid filled phantom. The impedance stated is transformed from the measurement at the SMA connector to the feed point. The Return Loss ensures low reflected power. No uncertainty required.
- Electrical Delay:** One-way delay between the SMA connector and the antenna feed point. No uncertainty required.
- SAR measured:** SAR measured at the stated antenna input power.
- SAR normalized:** SAR as measured, normalized to an input power of 1 W at the antenna connector.
- SAR for nominal TSL parameters:** The measured TSL parameters are used to calculate the nominal SAR result.

The reported uncertainty of measurement is stated as the standard uncertainty of measurement multiplied by the coverage factor $k=2$, which for a normal distribution corresponds to a coverage probability of approximately 95%.

Measurement Conditions

DASY system configuration, as far as not given on page 1.

DASY Version	DASY5	V52.8.8
Extrapolation	Advanced Extrapolation	
Phantom	Modular Flat Phantom V5.0	
Distance Dipole Center - TSL	10 mm	with Spacer
Zoom Scan Resolution	dx, dy = 4.0 mm, dz = 1.4 mm	Graded Ratio = 1.4 (Z direction)
Frequency	5250 MHz \pm 1 MHz 5600 MHz \pm 1 MHz 5750 MHz \pm 1 MHz	

Head TSL parameters at 5250 MHz

The following parameters and calculations were applied.

	Temperature	Permittivity	Conductivity
Nominal Head TSL parameters	22.0 °C	35.9	4.71 mho/m
Measured Head TSL parameters	(22.0 \pm 0.2) °C	34.9 \pm 6 %	4.54 mho/m \pm 6 %
Head TSL temperature change during test	< 0.5 °C	---	---

SAR result with Head TSL at 5250 MHz

SAR averaged over 1 cm ³ (1 g) of Head TSL	Condition	
SAR measured	100 mW input power	6.31 W/kg
SAR for nominal Head TSL parameters	normalized to 1W	62.5 W/kg \pm 19.9 % (k=2)

SAR averaged over 10 cm ³ (10 g) of Head TSL	condition	
SAR measured	100 mW input power	2.38 W/kg
SAR for nominal Head TSL parameters	normalized to 1W	23.6 W/kg \pm 19.5 % (k=2)

Head TSL parameters at 5600 MHz

The following parameters and calculations were applied.

	Temperature	Permittivity	Conductivity
Nominal Head TSL parameters	22.0 °C	35.5	5.07 mho/m
Measured Head TSL parameters	(22.0 ± 0.2) °C	34.4 ± 6 %	4.88 mho/m ± 6 %
Head TSL temperature change during test	< 0.5 °C	----	----

SAR result with Head TSL at 5600 MHz

SAR averaged over 1 cm ³ (1 g) of Head TSL	Condition	
SAR measured	100 mW input power	8.52 W/kg
SAR for nominal Head TSL parameters	normalized to 1W	84.5 W/kg ± 19.9 % (k=2)

SAR averaged over 10 cm ³ (10 g) of Head TSL	condition	
SAR measured	100 mW input power	2.43 W/kg
SAR for nominal Head TSL parameters	normalized to 1W	24.1 W/kg ± 19.5 % (k=2)

Head TSL parameters at 5750 MHz

The following parameters and calculations were applied.

	Temperature	Permittivity	Conductivity
Nominal Head TSL parameters	22.0 °C	35.4	5.22 mho/m
Measured Head TSL parameters	(22.0 ± 0.2) °C	34.2 ± 6 %	5.04 mho/m ± 6 %
Head TSL temperature change during test	< 0.5 °C	---	---

SAR result with Head TSL at 5750 MHz

SAR averaged over 1 cm ³ (1 g) of Head TSL	Condition	
SAR measured	100 mW input power	8.07 W/kg
SAR for nominal Head TSL parameters	normalized to 1W	80.0 W/kg ± 19.9 % (k=2)

SAR averaged over 10 cm ³ (10 g) of Head TSL	condition	
SAR measured	100 mW input power	2.31 W/kg
SAR for nominal Head TSL parameters	normalized to 1W	22.9 W/kg ± 19.5 % (k=2)

Body TSL parameters at 5250 MHz

The following parameters and calculations were applied.

	Temperature	Permittivity	Conductivity
Nominal Body TSL parameters	22.0 °C	48.9	5.36 mho/m
Measured Body TSL parameters	(22.0 ± 0.2) °C	47.3 ± 6 %	5.53 mho/m ± 6 %
Body TSL temperature change during test	< 0.5 °C	---	---

SAR result with Body TSL at 5250 MHz

SAR averaged over 1 cm ³ (1 g) of Body TSL	Condition	
SAR measured	100 mW input power	7.77 W/kg
SAR for nominal Body TSL parameters	normalized to 1W	77.2 W/kg ± 19.9 % (k=2)

SAR averaged over 10 cm ³ (10 g) of Body TSL	condition	
SAR measured	100 mW input power	2.17 W/kg
SAR for nominal Body TSL parameters	normalized to 1W	21.5 W/kg ± 19.5 % (k=2)

Body TSL parameters at 5600 MHz

The following parameters and calculations were applied.

	Temperature	Permittivity	Conductivity
Nominal Body TSL parameters	22.0 °C	48.5	5.77 mho/m
Measured Body TSL parameters	(22.0 ± 0.2) °C	46.7 ± 6 %	5.99 mho/m ± 6 %
Body TSL temperature change during test	< 0.5 °C	---	---

SAR result with Body TSL at 5600 MHz

SAR averaged over 1 cm ³ (1 g) of Body TSL	Condition	
SAR measured	100 mW input power	8.24 W/kg
SAR for nominal Body TSL parameters	normalized to 1W	81.9 W/kg ± 19.9 % (k=2)

SAR averaged over 10 cm ³ (10 g) of Body TSL	condition	
SAR measured	100 mW input power	2.30 W/kg
SAR for nominal Body TSL parameters	normalized to 1W	22.8 W/kg ± 19.5 % (k=2)

Body TSL parameters at 5750 MHz

The following parameters and calculations were applied.

	Temperature	Permittivity	Conductivity
Nominal Body TSL parameters	22.0 °C	48.3	5.94 mho/m
Measured Body TSL parameters	(22.0 ± 0.2) °C	46.5 ± 6 %	6.20 mho/m ± 6 %
Body TSL temperature change during test	< 0.5 °C	----	----

SAR result with Body TSL at 5750 MHz

SAR averaged over 1 cm ³ (1 g) of Body TSL	Condition	
SAR measured	100 mW input power	7.76 W/kg
SAR for nominal Body TSL parameters	normalized to 1W	77.1 W/kg ± 19.9 % (k=2)

SAR averaged over 10 cm ³ (10 g) of Body TSL	condition	
SAR measured	100 mW input power	2.16 W/kg
SAR for nominal Body TSL parameters	normalized to 1W	21.4 W/kg ± 19.5 % (k=2)

Appendix (Additional assessments outside the scope of SCS 0108)

Antenna Parameters with Head TSL at 5250 MHz

Impedance, transformed to feed point	54.1 Ω - 5.2 j Ω
Return Loss	- 24.0 dB

Antenna Parameters with Head TSL at 5600 MHz

Impedance, transformed to feed point	58.0 Ω - 3.2 j Ω
Return Loss	- 22.0 dB

Antenna Parameters with Head TSL at 5750 MHz

Impedance, transformed to feed point	59.2 Ω + 3.7 j Ω
Return Loss	- 20.8 dB

Antenna Parameters with Body TSL at 5250 MHz

Impedance, transformed to feed point	54.5 Ω - 3.9 j Ω
Return Loss	- 24.8 dB

Antenna Parameters with Body TSL at 5600 MHz

Impedance, transformed to feed point	59.0 Ω - 2.5 j Ω
Return Loss	- 21.3 dB

Antenna Parameters with Body TSL at 5750 MHz

Impedance, transformed to feed point	59.9 Ω + 4.8 j Ω
Return Loss	- 20.0 dB

General Antenna Parameters and Design

Electrical Delay (one direction)	1.203 ns
----------------------------------	----------

After long term use with 100W radiated power, only a slight warming of the dipole near the feedpoint can be measured.

The dipole is made of standard semirigid coaxial cable. The center conductor of the feeding line is directly connected to the second arm of the dipole. The antenna is therefore short-circuited for DC-signals. On some of the dipoles, small end caps are added to the dipole arms in order to improve matching when loaded according to the position as explained in the "Measurement Conditions" paragraph. The SAR data are not affected by this change. The overall dipole length is still according to the Standard.

No excessive force must be applied to the dipole arms, because they might bend or the soldered connections near the feedpoint may be damaged.

Additional EUT Data

Manufactured by	SPEAG
Manufactured on	August 28, 2003

DASY5 Validation Report for Head TSL

Date: 15.09.2015

Test Laboratory: SPEAG, Zurich, Switzerland

DUT: Dipole 5GHz; Type: D5GHzV2; Serial: D5GHzV2 - SN: 1191

Communication System: UID 0 - CW; Frequency: 5250 MHz, Frequency: 5600 MHz, Frequency: 5750 MHz

Medium parameters used: $f = 5250$ MHz; $\sigma = 4.54$ S/m; $\epsilon_r = 34.9$; $\rho = 1000$ kg/m³,

Medium parameters used: $f = 5600$ MHz; $\sigma = 4.88$ S/m; $\epsilon_r = 34.4$; $\rho = 1000$ kg/m³,

Medium parameters used: $f = 5750$ MHz; $\sigma = 5.04$ S/m; $\epsilon_r = 34.2$; $\rho = 1000$ kg/m³

Phantom section: Flat Section

Measurement Standard: DASY5 (IEEE/IEC/ANSI C63.19-2011)

DASY52 Configuration:

- Probe: EX3DV4 - SN3503; ConvF(5.45, 5.45, 5.45); Calibrated: 30.12.2014, ConvF(4.92, 4.92, 4.92); Calibrated: 30.12.2014, ConvF(4.91, 4.91, 4.91); Calibrated: 30.12.2014;
- Sensor-Surface: 1.4mm (Mechanical Surface Detection)
- Electronics: DAE4 Sn601; Calibrated: 17.08.2015
- Phantom: Flat Phantom 5.0 (front); Type: QD000P50AA; Serial: 1001
- DASY52 52.8.8(1222); SEMCAD X 14.6.10(7331)

Dipole Calibration for Head Tissue/Pin=100mW, dist=10mm, f=5250 MHz/Zoom Scan, dist=1.4mm (8x8x7)/Cube 0: Measurement grid: dx=4mm, dy=4mm, dz=1.4mm

Reference Value = 64.94 V/m; Power Drift = 0.02 dB

Peak SAR (extrapolated) = 30.7 W/kg

SAR(1 g) = 8.31 W/kg; SAR(10 g) = 2.38 W/kg

Maximum value of SAR (measured) = 19.5 W/kg

Dipole Calibration for Head Tissue/Pin=100mW, dist=10mm, f=5600 MHz/Zoom Scan, dist=1.4mm (8x8x7)/Cube 0: Measurement grid: dx=4mm, dy=4mm, dz=1.4mm

Reference Value = 63.94 V/m; Power Drift = 0.03 dB

Peak SAR (extrapolated) = 33.8 W/kg

SAR(1 g) = 8.52 W/kg; SAR(10 g) = 2.43 W/kg

Maximum value of SAR (measured) = 20.7 W/kg

Dipole Calibration for Head Tissue/Pin=100mW, dist=10mm, f=5750 MHz/Zoom Scan, dist=1.4mm (8x8x7)/Cube 0: Measurement grid: dx=4mm, dy=4mm, dz=1.4mm

Reference Value = 61.52 V/m; Power Drift = 0.06 dB

Peak SAR (extrapolated) = 33.4 W/kg

SAR(1 g) = 8.07 W/kg; SAR(10 g) = 2.31 W/kg

Maximum value of SAR (measured) = 19.9 W/kg

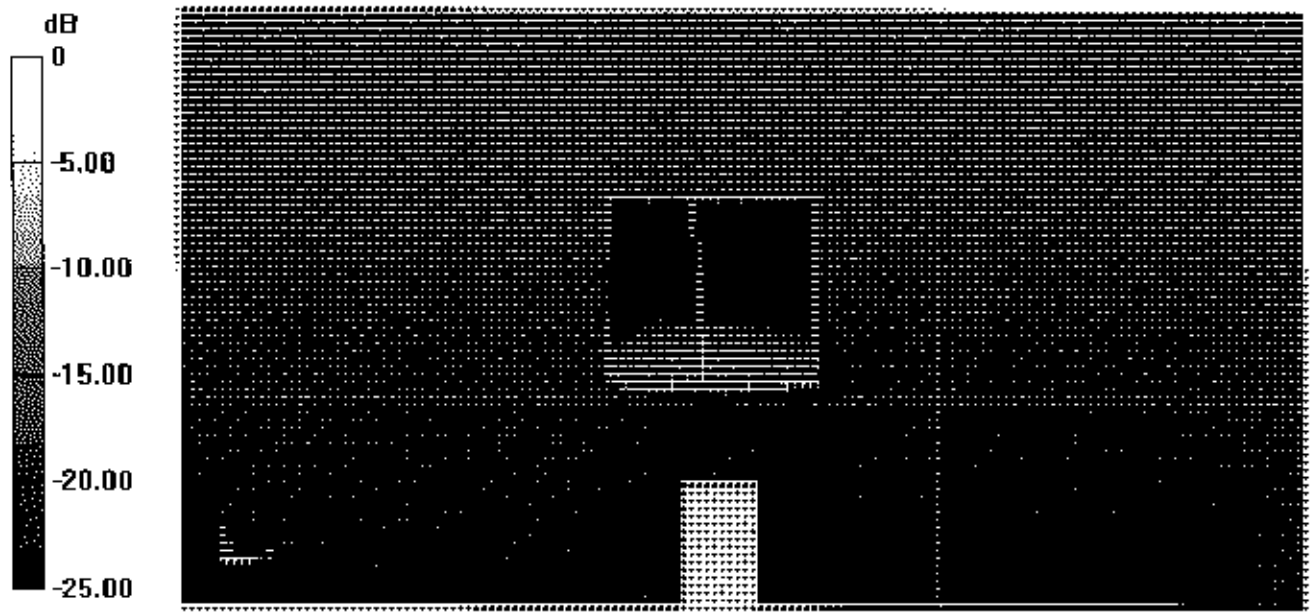

0 dB = 19.9 W/kg = 12.99 dBW/kg

Impedance Measurement Plot for Head TSL

15 Sep 2015 15:38:52
 CH1 S11 1 U FS 1: 54.123 Ω -5.1641 Ω 5.8704 pF 5 250.000 000 MHz

 Del
 Cor
 Avg
 16
 H1d

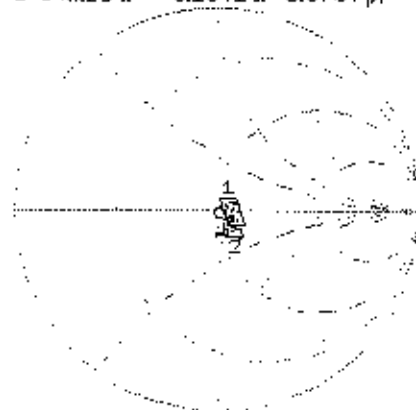

CH1 Markers

1: 54.123 Ω
 -5.1641 Ω
 5.8704 pF
 2: 57.959 Ω
 -3.1655 Ω
 5.60000 GHz
 3: 59.244 Ω
 3.6675 Ω
 5.75000 GHz

CH2 S11 LOG 5 dB/REF -20 dB 1: -23.955 dB 5 250.000 000 MHz

Cor
 Avg
 16
 H1d

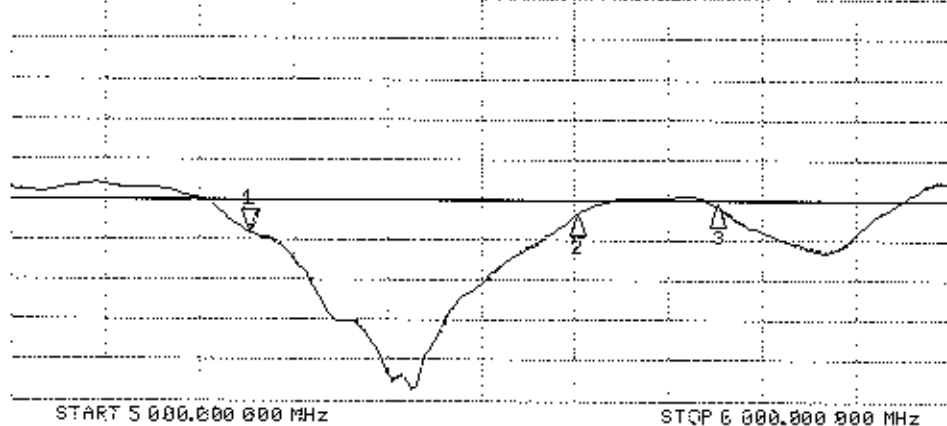

CH2 Markers

1: -23.955 dB
 5.60000 GHz
 2: -22.001 dB
 5.60000 GHz
 3: -20.813 dB
 5.75000 GHz

START 5 000.000 000 MHz STOP 6 000.000 000 MHz

Test Laboratory: SPEAG, Zurich, Switzerland

DUT: Dipole 5GHz; Type: D5GHzV2; Serial: D5GHzV2 - SN: 1191

Communication System: UID 0 - CW; Frequency: 5250 MHz, Frequency: 5600 MHz, Frequency: 5750 MHz

Medium parameters used: $f = 5250$ MHz; $\sigma = 5.53$ S/m; $\epsilon_r = 47.3$; $\rho = 1000$ kg/m³,

Medium parameters used: $f = 5600$ MHz; $\sigma = 5.99$ S/m; $\epsilon_r = 46.7$; $\rho = 1000$ kg/m³,

Medium parameters used: $f = 5750$ MHz; $\sigma = 6.2$ S/m; $\epsilon_r = 46.5$; $\rho = 1000$ kg/m³

Phantom section: Flat Section

Measurement Standard: DASY5 (IEEE/IEC/ANSI C63.19-2011)

DASY52 Configuration:

- Probe: EX3DV4 - SN3503; ConvF(4.9, 4.9, 4.9); Calibrated: 30.12.2014, ConvF(4.35, 4.35, 4.35); Calibrated: 30.12.2014, ConvF(4.35, 4.35, 4.35); Calibrated: 30.12.2014;
- Sensor-Surface: 1.4mm (Mechanical Surface Detection)
- Electronics: DAE4 Sn601; Calibrated: 17.08.2015
- Phantom: Flat Phantom 5.0 (back); Type: QD000P50AA; Serial: 1002
- DASY52 52.8.8(1222); SEMCAD X 14.6.10(7331)

Dipole Calibration for Body Tissue/Pin=100mW, dist=10mm, f=5250 MHz/Zoom Scan, dist=1.4mm (8x8x7)/Cube 0: Measurement grid: dx=4mm, dy=4mm, dz=1.4mm

Reference Value = 58.40 V/m; Power Drift = 0.09 dB

Peak SAR (extrapolated) = 30.8 W/kg

SAR(1 g) = 7.77 W/kg; SAR(10 g) = 2.17 W/kg

Maximum value of SAR (measured) = 19.0 W/kg

Dipole Calibration for Body Tissue/Pin=100mW, dist=10mm, f=5600 MHz/Zoom Scan, dist=1.4mm (8x8x7)/Cube 0: Measurement grid: dx=4mm, dy=4mm, dz=1.4mm

Reference Value = 59.20 V/m; Power Drift = -0.02 dB

Peak SAR (extrapolated) = 36.1 W/kg

SAR(1 g) = 8.24 W/kg; SAR(10 g) = 2.3 W/kg

Maximum value of SAR (measured) = 21.0 W/kg

Dipole Calibration for Body Tissue/Pin=100mW, dist=10mm, f=5750 MHz/Zoom Scan, dist=1.4mm (8x8x7)/Cube 0: Measurement grid: dx=4mm, dy=4mm, dz=1.4mm

Reference Value = 56.52 V/m; Power Drift = 0.01 dB

Peak SAR (extrapolated) = 35.5 W/kg

SAR(1 g) = 7.76 W/kg; SAR(10 g) = 2.16 W/kg

Maximum value of SAR (measured) = 19.9 W/kg

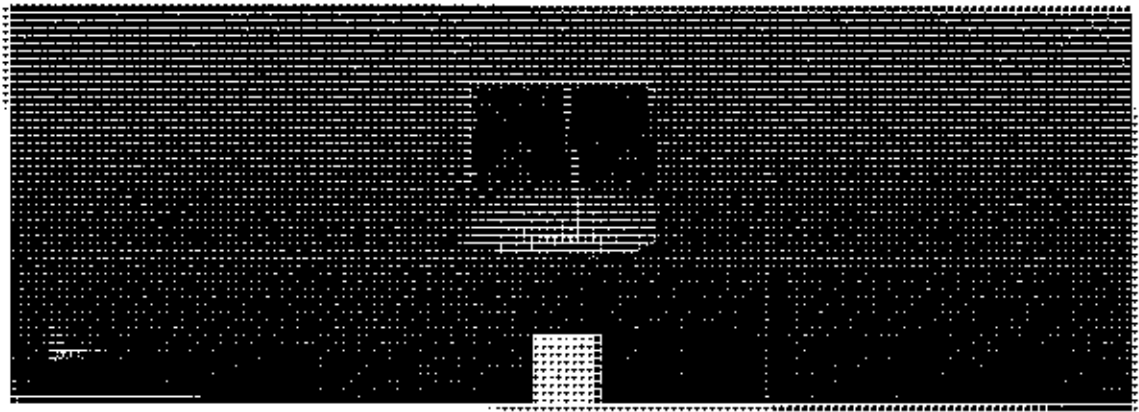
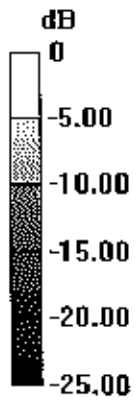

0 dB = 19.9 W/kg = 12.99 dBW/kg

Impedance Measurement Plot for Body TSL

16 Sep 2015 10:53:21

CH1 S11 1 U FS 1: 54.562 Ω -3.5453 Δ 7.6839 pF 5 250.000 000 MHz

*
De1
Cor
Avg
16
H1d

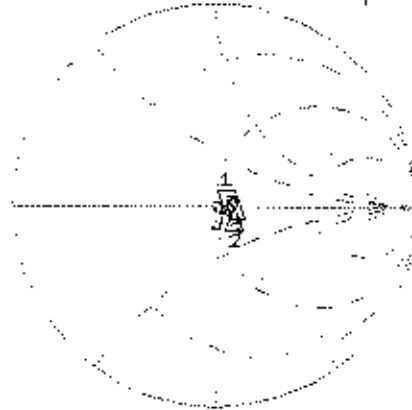

CH1 Markers
2: 59.833 Ω
-2.5000 Δ
5.60000 GHz
3: 59.852 Ω
4.7635 Δ
5.75000 GHz

CH2 S11 LOG 5 dB/REF -20 dB 1: -24.844 dB 5 250.000 000 MHz

Cor
Avg
16
H1d

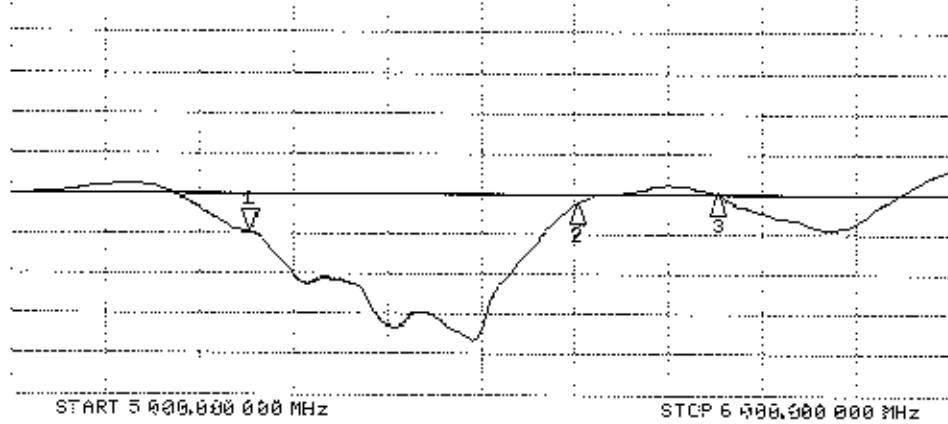

CH2 Markers
2: -21.316 dB
5.60000 GHz
3: -20.042 dB
5.75000 GHz



Accredited by the Swiss Accreditation Service (SAS)
The Swiss Accreditation Service is one of the signatories to the EA
Multilateral Agreement for the recognition of calibration certificates

Accreditation No.: **SCS 0108**

Client **PC Test**

Certificate No: **ES3-3333_Oct15**

CALIBRATION CERTIFICATE

Object: **ES3DV3 - SN:3333**

Calibration procedure(s): **QA CAL-01.v9, QA CAL-23.v5, QA CAL-25.v6**
Calibration procedure for dosimetric E-field probes

Calibration date: **October 29, 2015**

*BN ✓
11/03/15*

This calibration certificate documents the traceability to national standards, which realize the physical units of measurements (SI).
The measurements and the uncertainties with confidence probability are given on the following pages and are part of the certificate.

All calibrations have been conducted in the closed laboratory facility; environment temperature (22 ± 3)°C and humidity < 70%.

Calibration Equipment used (M&TE critical for calibration)

Primary Standards	ID	Cal Date (Certificate No.)	Scheduled Calibration
Power meter E4419B	GB41293874	01-Apr-15 (No. 217-02128)	Mar-16
Power sensor E4412A	MY41498087	01-Apr-15 (No. 217-02128)	Mar-16
Reference 3 dB Attenuator	SN: S5054 (3c)	01-Apr-15 (No. 217-02129)	Mar-16
Reference 20 dB Attenuator	SN: S5277 (20x)	01-Apr-15 (No. 217-02132)	Mar-16
Reference 30 dB Attenuator	SN: S5129 (30b)	01-Apr-15 (No. 217-02133)	Mar-16
Reference Probe ES3DV2	SN: 3013	30-Dec-14 (No. ES3-3013_Dec14)	Dec-15
DAE4	SN: 660	14-Jan-15 (No. DAE4-660_Jan15)	Jan-16
Secondary Standards	ID	Check Date (in house)	Scheduled Check
RF generator HP 8648C	US3642U01700	4-Aug-99 (In house check Apr-13)	In house check: Apr-16
Network Analyzer HP 8753E	US37390585	18-Oct-01 (in house check Oct-15)	In house check: Oct-16

Calibrated by:	Name Lutz Klysner	Function Laboratory Technician	Signature
Approved by:	Name Katja Pokovic	Function Technical Manager	

Issued: October 29, 2015

This calibration certificate shall not be reproduced except in full without written approval of the laboratory.



Accredited by the Swiss Accreditation Service (SAS)

Accreditation No.: **SCS 0108**

The Swiss Accreditation Service is one of the signatories to the EA
Multilateral Agreement for the recognition of calibration certificates

Glossary:

TSL	tissue simulating liquid
NORM _{x,y,z}	sensitivity in free space
ConvF	sensitivity in TSL / NORM _{x,y,z}
DCP	diode compression point
CF	crest factor (1/duty_cycle) of the RF signal
A, B, C, D	modulation dependent linearization parameters
Polarization ϕ	ϕ rotation around probe axis
Polarization θ	θ rotation around an axis that is in the plane normal to probe axis (at measurement center), i.e., $\theta = 0$ is normal to probe axis
Connector Angle	information used in DASY system to align probe sensor X to the robot coordinate system

Calibration is Performed According to the Following Standards:

- IEEE Std 1528-2013, "IEEE Recommended Practice for Determining the Peak Spatial-Averaged Specific Absorption Rate (SAR) in the Human Head from Wireless Communications Devices: Measurement Techniques", June 2013
- IEC 62209-1, "Procedure to measure the Specific Absorption Rate (SAR) for hand-held devices used in close proximity to the ear (frequency range of 300 MHz to 3 GHz)", February 2005
- IEC 62209-2, "Procedure to determine the Specific Absorption Rate (SAR) for wireless communication devices used in close proximity to the human body (frequency range of 30 MHz to 6 GHz)", March 2010
- KDB 865604, "SAR Measurement Requirements for 100 MHz to 6 GHz"

Methods Applied and Interpretation of Parameters:

- NORM_{x,y,z}**: Assessed for E-field polarization $\theta = 0$ ($f \leq 900$ MHz in TEM-cell; $f > 1800$ MHz: R22 waveguide). NORM_{x,y,z} are only intermediate values, i.e., the uncertainties of NORM_{x,y,z} does not affect the E²-field uncertainty inside TSL (see below ConvF).
- NORM(f)_{x,y,z}** = NORM_{x,y,z} * frequency_response (see Frequency Response Chart). This linearization is implemented in DASY4 software versions later than 4.2. The uncertainty of the frequency response is included in the stated uncertainty of ConvF.
- DCP_{x,y,z}**: DCP are numerical linearization parameters assessed based on the data of power sweep with CW signal (no uncertainty required). DCP does not depend on frequency nor media.
- PAR**: PAR is the Peak to Average Ratio that is not calibrated but determined based on the signal characteristics
- A_{x,y,z}; B_{x,y,z}; C_{x,y,z}; D_{x,y,z}; VR_{x,y,z}**: A, B, C, D are numerical linearization parameters assessed based on the data of power sweep for specific modulation signal. The parameters do not depend on frequency nor media. VR is the maximum calibration range expressed in RMS voltage across the diode.
- ConvF and Boundary Effect Parameters**: Assessed in flat phantom using E-field (or Temperature Transfer Standard for $f \leq 800$ MHz) and inside waveguide using analytical field distributions based on power measurements for $f > 800$ MHz. The same setups are used for assessment of the parameters applied for boundary compensation (alpha, depth) of which typical uncertainty values are given. These parameters are used in DASY4 software to improve probe accuracy close to the boundary. The sensitivity in TSL corresponds to NORM_{x,y,z} * ConvF whereby the uncertainty corresponds to that given for ConvF. A frequency dependent ConvF is used in DASY version 4.4 and higher which allows extending the validity from ± 50 MHz to ± 100 MHz.
- Spherical isotropy (3D deviation from isotropy)**: in a field of low gradients realized using a flat phantom exposed by a patch antenna.
- Sensor Offset**: The sensor offset corresponds to the offset of virtual measurement center from the probe tip (on probe axis). No tolerance required.
- Connector Angle**: The angle is assessed using the information gained by determining the NORM_x (no uncertainty required).

Probe ES3DV3

SN:3333

Manufactured: January 24, 2012
Calibrated: October 29, 2015

Calibrated for DASY/EASY Systems
(Note: non-compatible with DASY2 system!)

DASY/EASY - Parameters of Probe: ES3DV3 - SN:3333

Basic Calibration Parameters

	Sensor X	Sensor Y	Sensor Z	Unc (k=2)
Norm ($\mu\text{V}/(\text{V}/\text{m})^2$) ^A	1.07	0.90	0.88	$\pm 10.1\%$
DCP (mV) ^B	106.8	108.5	106.8	

Modulation Calibration Parameters

UID	Communication System Name		A dB	B dB $\sqrt{\mu\text{V}}$	C	D dB	VR mV	Unc ^E (k=2)
0	CW	X	0.0	0.0	1.0	0.00	201.0	$\pm 3.5\%$
		Y	0.0	0.0	1.0		187.1	
		Z	0.0	0.0	1.0		184.8	
10010- CAA	SAR Validation (Square, 100ms, 10ms)	X	2.43	80.7	11.4	10.00	41.6	$\pm 2.2\%$
		Y	4.35	67.4	13.2		35.6	
		Z	1.46	57.0	8.7		36.2	
10011- CAB	UMTS-FDD (WCDMA)	X	3.35	67.9	19.1	2.91	138.2	$\pm 0.5\%$
		Y	3.48	68.8	19.2		127.5	
		Z	3.37	67.6	18.6		149.0	
10012- CAB	IEEE 802.11b WiFi 2.4 GHz (DSSS, 1 Mbps)	X	3.80	72.8	20.8	1.87	141.0	$\pm 0.7\%$
		Y	3.68	73.3	20.8		128.0	
		Z	3.01	69.3	18.8		128.2	
10013- CAB	IEEE 802.11g WiFi 2.4 GHz (DSSS-OFDM, 6 Mbps)	X	11.52	71.7	23.9	9.46	139.3	$\pm 3.0\%$
		Y	10.94	70.4	22.9		147.1	
		Z	10.95	70.8	23.4		144.5	
10021- DAB	GSM-FDD (TDMA, GMSK)	X	21.45	95.2	26.5	9.39	139.9	$\pm 2.5\%$
		Y	9.12	82.9	21.9		142.0	
		Z	11.47	88.1	23.9		127.6	
10023- DAB	GPRS-FDD (TDMA, GMSK, TN 0)	X	20.81	95.6	27.0	9.57	135.8	$\pm 2.2\%$
		Y	9.78	84.4	22.7		135.3	
		Z	8.12	83.5	22.1		144.6	
10024- DAB	GPRS-FDD (TDMA, GMSK, TN 0-1)	X	39.84	99.8	25.2	6.56	140.9	$\pm 1.9\%$
		Y	35.07	100.0	25.0		128.4	
		Z	35.20	99.8	24.7		131.9	
10027- DAB	GPRS-FDD (TDMA, GMSK, TN 0-1-2)	X	47.16	99.8	23.9	4.80	124.9	$\pm 2.5\%$
		Y	49.75	99.6	22.8		145.4	
		Z	45.37	99.9	23.1		148.5	
10028- DAB	GPRS-FDD (TDMA, GMSK, TN 0-1-2-3)	X	56.24	99.6	22.6	3.55	140.4	$\pm 2.7\%$
		Y	56.95	99.7	21.9		129.1	
		Z	48.45	99.6	22.1		133.2	
10032- CAA	IEEE 802.15.1 Bluetooth (GFSK, DH5)	X	18.03	98.1	22.8	1.16	127.5	$\pm 1.9\%$
		Y	35.17	99.6	20.7		141.1	
		Z	21.08	99.9	21.9		127.5	
10100- CAB	LTE-FDD (SC-FDMA, 100% RB, 20 MHz, QPSK)	X	6.36	87.6	19.8	5.67	137.5	$\pm 1.2\%$
		Y	6.29	87.4	19.6		128.9	
		Z	6.35	87.5	19.7		139.5	

10103-CAB	LTE-TDD (SC-FDMA, 100% RB, 20 MHz, QPSK)	X	10.85	76.6	26.4	9.29	130.8	±2.7 %
		Y	9.58	73.7	24.8		143.0	
		Z	9.94	75.6	26.2		149.3	
10108-CAC	LTE-FDD (SC-FDMA, 100% RB, 10 MHz, QPSK)	X	6.21	67.0	19.7	5.80	128.9	±1.2 %
		Y	6.16	66.9	19.5		129.2	
		Z	6.22	67.2	19.7		138.0	
10117-CAB	IEEE 802.11n (HT Mixed, 13.5 Mbps, BPSK)	X	10.05	68.7	21.2	8.07	126.1	±2.5 %
		Y	10.13	69.0	21.3		146.1	
		Z	9.97	68.7	21.1		126.2	
10151-CAB	LTE-TDD (SC-FDMA, 50% RB, 20 MHz, QPSK)	X	10.11	75.5	26.0	9.28	125.8	±3.3 %
		Y	9.08	73.2	24.7		138.2	
		Z	9.32	74.8	26.0		143.1	
10154-CAC	LTE-FDD (SC-FDMA, 50% RB, 10 MHz, QPSK)	X	5.97	66.8	19.6	5.75	133.4	±1.2 %
		Y	5.92	66.7	19.5		127.0	
		Z	5.91	68.7	19.5		134.2	
10160-CAB	LTE-FDD (SC-FDMA, 50% RB, 15 MHz, QPSK)	X	6.40	67.3	19.9	5.82	137.8	±1.2 %
		Y	6.31	67.1	19.6		130.7	
		Z	6.32	67.1	19.6		139.8	
10169-CAB	LTE-FDD (SC-FDMA, 1 RB, 20 MHz, QPSK)	X	5.05	67.3	20.1	5.73	136.8	±1.2 %
		Y	4.89	67.0	19.9		131.1	
		Z	4.93	67.2	20.0		137.4	
10172-CAB	LTE-TDD (SC-FDMA, 1 RB, 20 MHz, QPSK)	X	10.74	83.9	30.3	9.21	136.8	±2.7 %
		Y	7.34	74.3	25.5		125.9	
		Z	7.74	76.6	27.1		131.2	
10175-CAC	LTE-FDD (SC-FDMA, 1 RB, 10 MHz, QPSK)	X	4.97	66.9	19.9	5.72	130.8	±1.2 %
		Y	4.86	66.9	19.8		128.5	
		Z	4.97	67.3	20.1		137.0	
10181-CAB	LTE-FDD (SC-FDMA, 1 RB, 15 MHz, QPSK)	X	4.99	67.0	19.9	5.72	130.1	±1.2 %
		Y	4.88	67.0	19.9		127.6	
		Z	4.95	67.2	20.0		136.2	
10196-CAB	IEEE 802.11n (HT Mixed, 6.5 Mbps, BPSK)	X	10.00	69.2	21.7	8.10	137.9	±2.2 %
		Y	9.75	68.7	21.2		137.5	
		Z	9.94	69.4	21.7		145.3	
10225-CAB	UMTS-FDD (HSPA+)	X	7.08	67.5	19.8	5.97	147.1	±1.4 %
		Y	7.06	67.7	19.8		142.3	
		Z	7.04	67.7	19.9		148.8	
10237-CAB	LTE-TDD (SC-FDMA, 1 RB, 10 MHz, QPSK)	X	10.66	83.5	30.1	9.21	144.0	±3.0 %
		Y	7.43	74.7	25.7		127.6	
		Z	7.86	77.1	27.4		132.3	
10252-CAB	LTE-TDD (SC-FDMA, 50% RB, 10 MHz, QPSK)	X	10.81	78.7	27.9	9.24	139.7	±3.0 %
		Y	8.48	72.4	24.4		130.1	
		Z	8.71	74.1	25.8		135.2	
10267-CAB	LTE-TDD (SC-FDMA, 100% RB, 10 MHz, QPSK)	X	11.73	79.9	28.3	9.30	148.6	±3.3 %
		Y	9.11	73.2	24.8		139.0	
		Z	9.38	74.9	26.1		142.7	

10275-CAB	UMTS-FDD (HSUPA, Subtest 5, 3GPP Rel8.4)	X	4.52	67.6	19.3	3.96	144.5	±0.7 %
		Y	4.67	68.3	19.6		146.0	
		Z	4.41	67.0	18.9		130.0	
10291-AAB	CDMA2000, RC3, SO55, Full Rate	X	3.68	67.2	19.0	3.46	134.5	±0.5 %
		Y	3.91	68.9	19.9		133.2	
		Z	3.86	68.5	19.6		146.9	
10292-AAB	CDMA2000, RC3, SO32, Full Rate	X	3.63	67.5	19.1	3.39	134.9	±0.5 %
		Y	3.93	69.3	20.0		136.0	
		Z	3.81	68.5	19.6		148.6	
10297-AAA	LTE-FDD (SC-FDMA, 50% RB, 20 MHz, QPSK)	X	6.20	67.1	19.7	5.81	129.0	±1.2 %
		Y	6.20	67.0	19.6		128.0	
		Z	6.32	67.5	19.9		142.7	
10311-AAA	LTE-FDD (SC-FDMA, 100% RB, 15 MHz, QPSK)	X	6.76	67.6	20.0	6.06	134.7	±1.4 %
		Y	6.75	67.5	19.9		133.5	
		Z	6.90	68.1	20.3		149.2	
10400-AAC	IEEE 802.11ac WiFi (20MHz, 64-QAM, 99pc duty cycle)	X	10.30	69.7	22.1	8.37	140.1	±2.5 %
		Y	10.05	69.0	21.5		141.2	
		Z	9.94	69.0	21.7		126.3	
10403-AAB	CDMA2000 (1xEV-DO, Rev. 0)	X	4.80	68.5	19.0	3.76	129.3	±0.5 %
		Y	5.30	71.1	20.2		148.4	
		Z	5.10	70.4	19.9		135.2	
10404-AAB	CDMA2000 (1xEV-DO, Rev. A)	X	4.77	68.8	19.2	3.77	127.3	±0.7 %
		Y	5.35	71.7	20.5		145.4	
		Z	5.03	70.6	20.1		133.3	
10415-AAA	IEEE 802.11b WiFi 2.4 GHz (DSSS, 1 Mbps, 99pc duty cycle)	X	2.77	69.7	19.7	1.54	147.0	±0.7 %
		Y	3.73	75.4	22.2		143.7	
		Z	3.25	72.2	20.7		133.9	
10416-AAA	IEEE 802.11g WiFi 2.4 GHz (ERP-OFDM, 6 Mbps, 99pc duty cycle)	X	10.11	69.4	21.8	8.23	144.7	±2.5 %
		Y	9.86	68.8	21.4		139.3	
		Z	9.72	68.6	21.3		126.0	

The reported uncertainty of measurement is stated as the standard uncertainty of measurement multiplied by the coverage factor $k=2$, which for a normal distribution corresponds to a coverage probability of approximately 95%.

^A The uncertainties of Norm X,Y,Z do not affect the E^2 -field uncertainty inside TSL (see Pages 7 and 8).

^B Numerical linearization parameter: uncertainty not required.

^E Uncertainty is determined using the max. deviation from linear response applying rectangular distribution and is expressed for the square of the field value.

DASY/EASY - Parameters of Probe: ES3DV3 - SN:3333

Calibration Parameter Determined In Head Tissue Simulating Media

f (MHz) ^c	Relative Permittivity ^F	Conductivity (S/m) ^F	ConvF X	ConvF Y	ConvF Z	Alpha ^G	Depth ^G (mm)	Unc (k=2)
750	41.9	0.89	6.46	6.46	6.46	0.75	1.22	± 12.0 %
835	41.5	0.90	6.16	6.16	6.16	0.36	1.67	± 12.0 %
1750	40.1	1.37	5.21	5.21	5.21	0.80	1.19	± 12.0 %
1900	40.0	1.40	5.03	5.03	5.03	0.73	1.25	± 12.0 %
2300	39.5	1.67	4.73	4.73	4.73	0.60	1.43	± 12.0 %
2450	39.2	1.80	4.53	4.53	4.53	0.80	1.28	± 12.0 %
2600	39.0	1.96	4.39	4.39	4.39	0.80	1.29	± 12.0 %

^c Frequency validity above 300 MHz of ± 100 MHz only applies for DASY v4.4 and higher (see Page 2), else it is restricted to ± 50 MHz. The uncertainty is the RSS of the ConvF uncertainty at calibration frequency and the uncertainty for the indicated frequency band. Frequency validity below 300 MHz is ± 10, 25, 40, 50 and 70 MHz for ConvF assessments at 30, 64, 128, 150 and 220 MHz respectively. Above 5 GHz frequency validity can be extended to ± 110 MHz.

^F At frequencies below 3 GHz, the validity of tissue parameters (ϵ and σ) can be relaxed to ± 10% if liquid compensation formula is applied to measured SAR values. At frequencies above 3 GHz, the validity of tissue parameters (ϵ and σ) is restricted to ± 5%. The uncertainty is the RSS of the ConvF uncertainty for indicated target tissue parameters.

^G Alpha/Depth are determined during calibration. SPEAG warrants that the remaining deviation due to the boundary effect after compensation is always less than ± 1% for frequencies below 3 GHz and below ± 2% for frequencies between 3-6 GHz at any distance larger than half the probe tip diameter from the boundary.

DASY/EASY - Parameters of Probe: ES3DV3 - SN:3333

Calibration Parameter Determined in Body Tissue Simulating Media

f (MHz) ^c	Relative Permittivity ^F	Conductivity (S/m) ^F	ConvF X	ConvF Y	ConvF Z	Alpha ^g	Depth ^g (mm)	Unc (k=2)
750	55.5	0.98	6.31	6.31	6.31	0.70	1.26	± 12.0 %
835	55.2	0.97	6.25	6.25	6.25	0.47	1.54	± 12.0 %
1750	53.4	1.49	4.90	4.90	4.90	0.49	1.63	± 12.0 %
1900	53.3	1.52	4.70	4.70	4.70	0.54	1.49	± 12.0 %
2300	52.9	1.81	4.51	4.51	4.51	0.80	1.15	± 12.0 %
2450	52.7	1.95	4.34	4.34	4.34	0.80	1.15	± 12.0 %
2600	52.5	2.16	4.23	4.23	4.23	0.80	1.03	± 12.0 %

^c Frequency validity above 300 MHz of ± 100 MHz only applies for DASY v4.4 and higher (see Page 2), else it is restricted to ± 50 MHz. The uncertainty is the RSS of the ConvF uncertainty at calibration frequency and the uncertainty for the indicated frequency band. Frequency validity below 300 MHz is ± 10, 25, 40, 50 and 70 MHz for ConvF assessments at 30, 64, 128, 160 and 220 MHz respectively. Above 5 GHz frequency validity can be extended to ± 110 MHz.

^F At frequencies below 3 GHz, the validity of tissue parameters (ϵ and σ) can be relaxed to ± 10% if liquid compensation formula is applied to measured SAR values. At frequencies above 3 GHz, the validity of tissue parameters (ϵ and σ) is restricted to ± 5%. The uncertainty is the RSS of the ConvF uncertainty for indicated target tissue parameters.

^g Alpha/Depth are determined during calibration. SPEAG warrants that the remaining deviation due to the boundary effect after compensation is always less than ± 1% for frequencies below 3 GHz and below ± 2% for frequencies between 3-6 GHz at any distance larger than half the probe tip diameter from the boundary.

Frequency Response of E-Field (TEM-Cell:ifi110 EXX, Waveguide: R22)

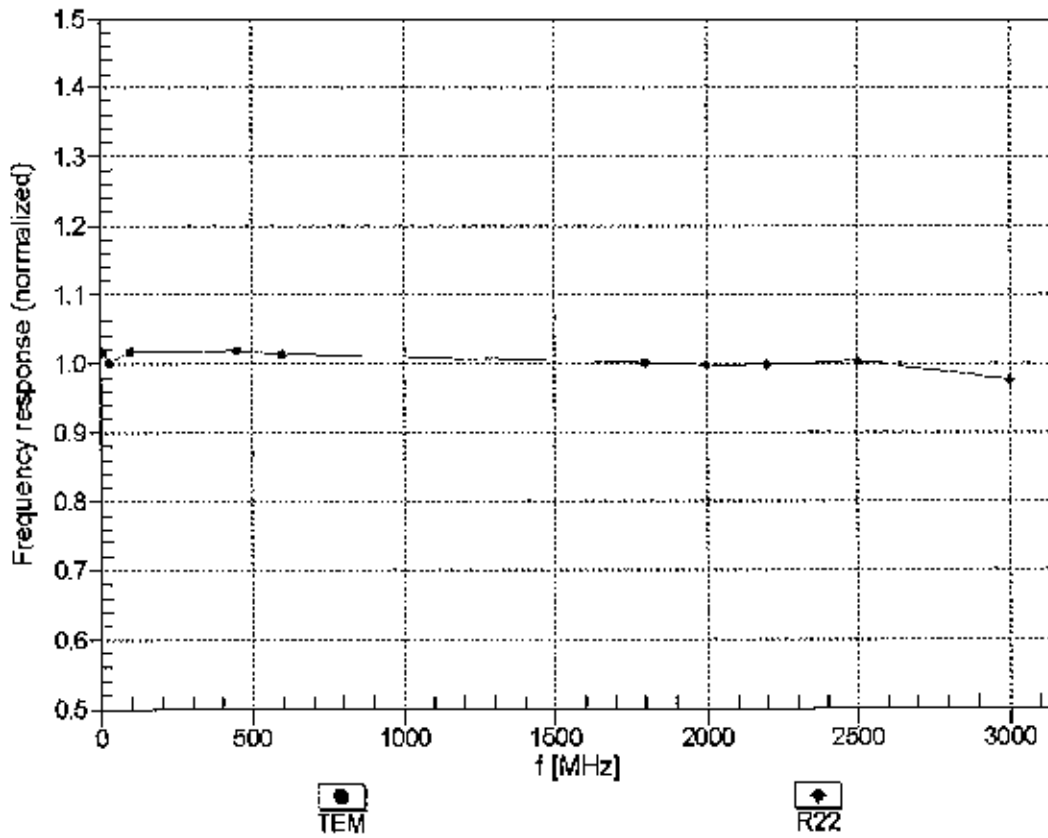

Uncertainty of Frequency Response of E-field: $\pm 6.3\%$ (k=2)

Receiving Pattern (ϕ), $\theta = 0^\circ$

f=600 MHz,TEM

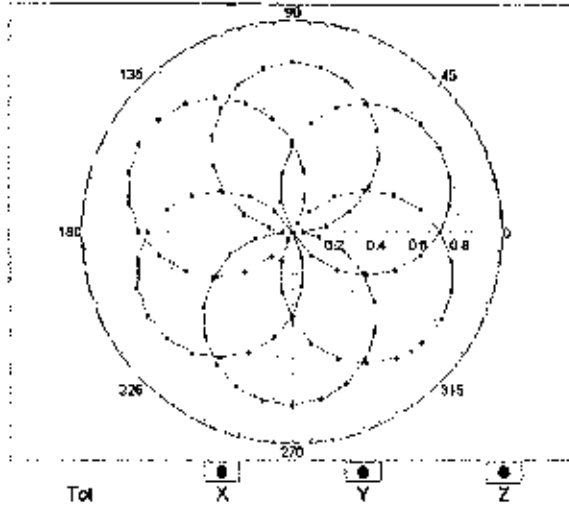

f=1800 MHz,R22

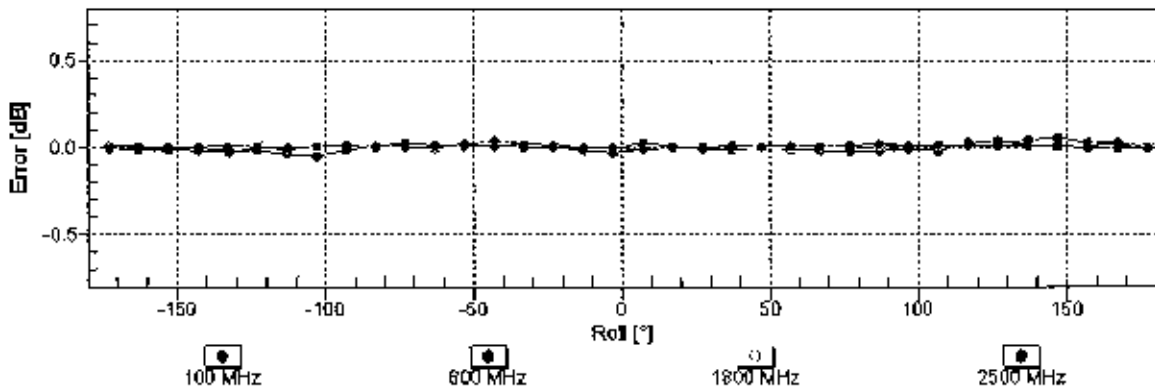
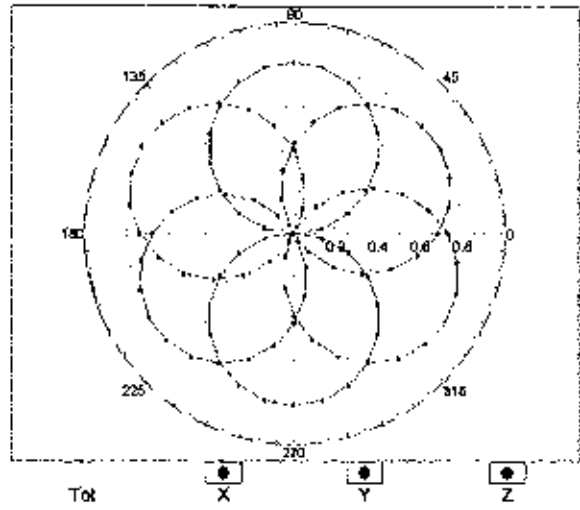

Uncertainty of Axial Isotropy Assessment: $\pm 0.5\%$ (k=2)

Dynamic Range f(SAR_{head}) (TEM cell , f_{eval}= 1900 MHz)

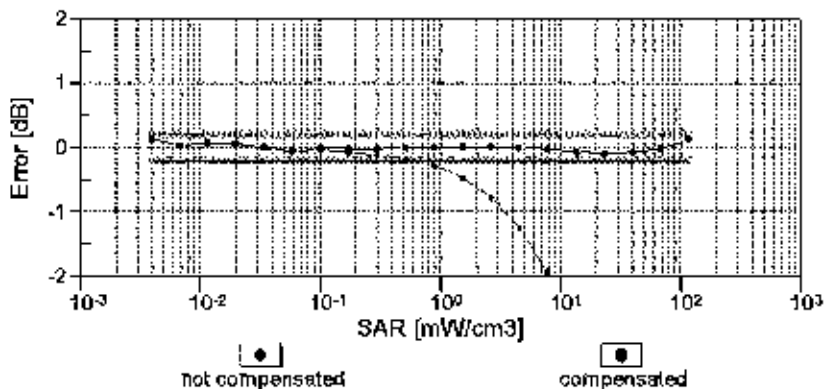
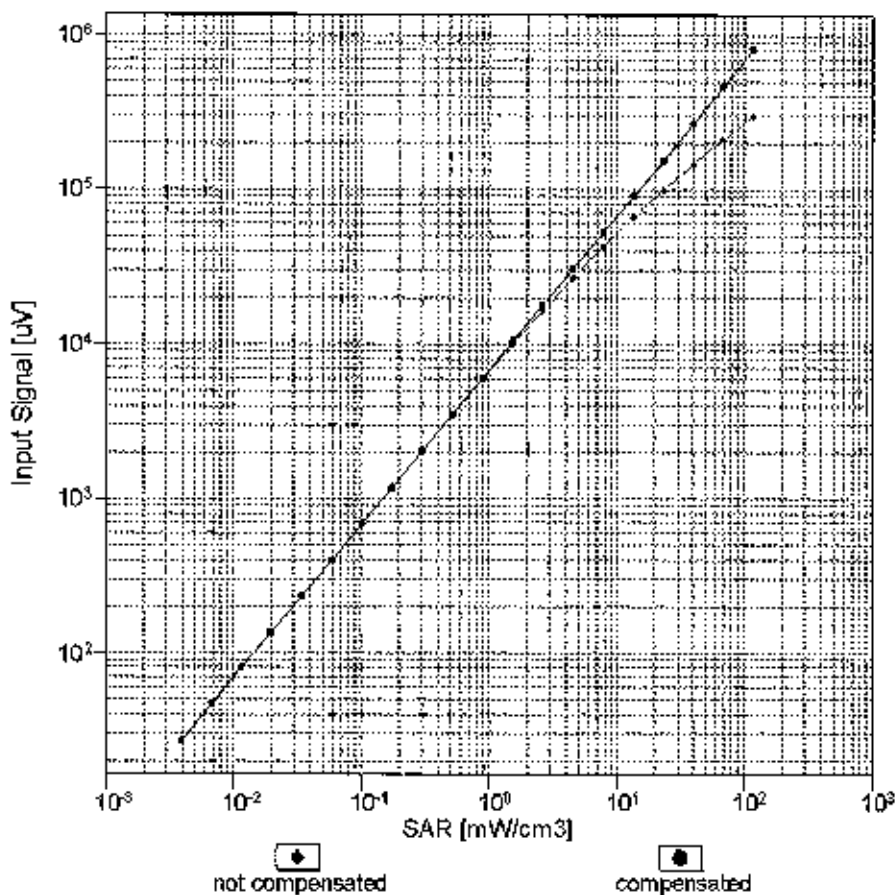

Uncertainty of Linearity Assessment: ± 0.6% (k=2)

Conversion Factor Assessment

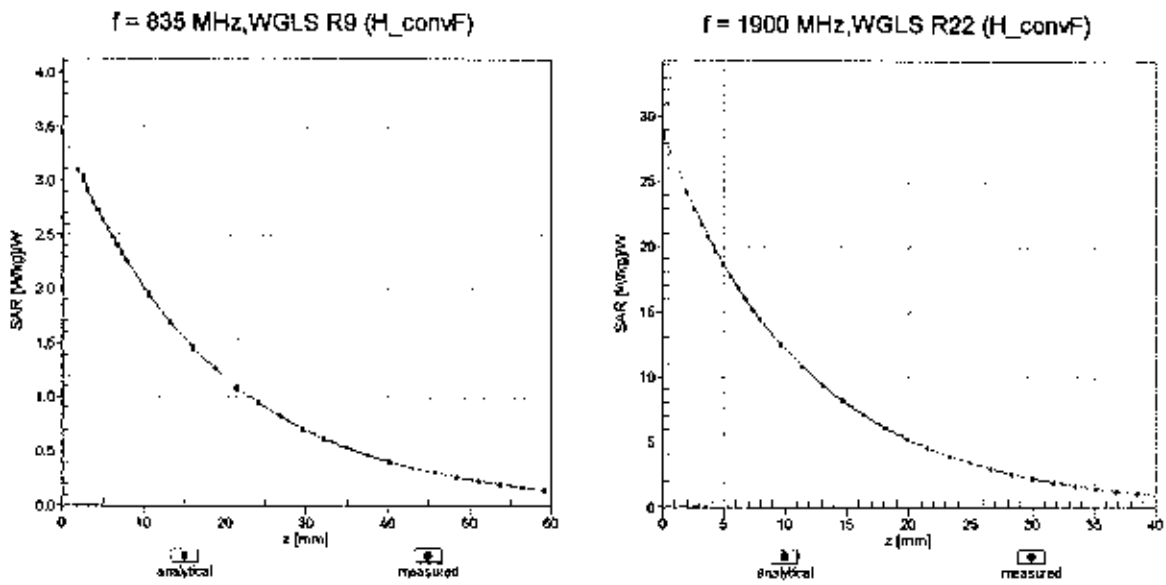

Deviation from Isotropy in Liquid Error (ϕ, θ), f = 900 MHz

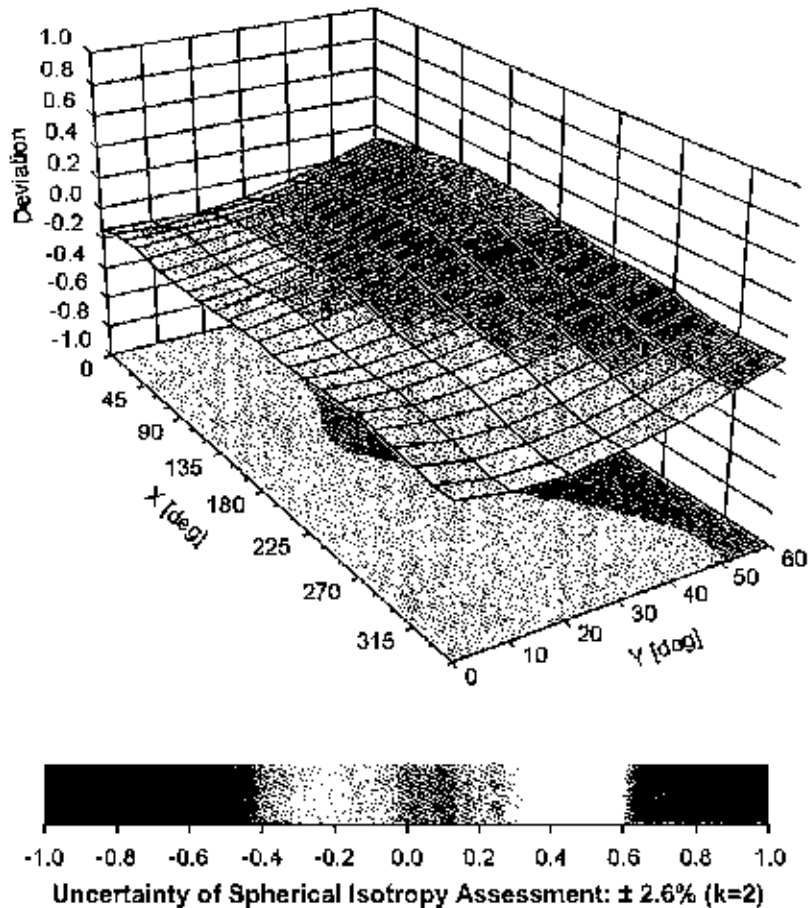

DASY/EASY - Parameters of Probe: ES3DV3 - SN:3333**Other Probe Parameters**

Sensor Arrangement	Triangular
Connector Angle (°)	-32.8
Mechanical Surface Delection Mode	enabled
Optical Surface Detection Mode	disabled
Probe Overall Length	337 mm
Probe Body Diameter	10 mm
Tip Length	10 mm
Tip Diameter	4 mm
Probe Tip to Sensor X Calibration Point	2 mm
Probe Tip to Sensor Y Calibration Point	2 mm
Probe Tip to Sensor Z Calibration Point	2 mm
Recommended Measurement Distance from Surface	3 mm



Accredited by the Swiss Accreditation Service (SAS)
The Swiss Accreditation Service is one of the signatories to the EA
Multilateral Agreement for the recognition of calibration certificates

Accreditation No.: **SCS 0108**

Client **PG Test**

Certificate No: **ES3-3334_Nov15**

CALIBRATION CERTIFICATE

Object **ES3DV3 - SN:3334**

Calibration procedure(s) **QA CAL-01.v9, QA CAL-12.v9, QA CAL-23.v5, QA CAL-25.v6**
Calibration procedure for dosimetric E-field probes

Calibration date: **November 17, 2015**

This calibration certificate documents the traceability to national standards, which realize the physical units of measurements (SI).
The measurements and the uncertainties with confidence probability are given on the following pages and are part of the certificate.

All calibrations have been conducted in the closed laboratory facility: environment temperature (22 ± 3)°C and humidity < 70%.

Calibration Equipment used (M&TE critical for calibration)

BV
11/24/15

Primary Standards	ID	Cal Date (Certificate No.)	Scheduled Calibration
Power meter E4419B	GB41293874	01-Apr-15 (No. 217-02128)	Mar-16
Power sensor E4412A	MY41498087	01-Apr-15 (No. 217-02128)	Mar-16
Reference 3 dB Attenuator	SN: S5054 (3c)	01-Apr-15 (No. 217-02129)	Mar-16
Reference 20 dB Attenuator	SN: S5277 (20x)	01-Apr-15 (No. 217-02132)	Mar-16
Reference 30 dB Attenuator	SN: S5129 (30b)	01-Apr-15 (No. 217-02133)	Mar-16
Reference Probe ES3DV2	SN: 3013	30-Dec-14 (No. ES3-3013 Dec14)	Dec-15
DAE4	SN: 660	14-Jan-15 (No. DAE4-660_Jan15)	Jan-16
Secondary Standards	ID	Check Date (in house)	Scheduled Check
RF generator HP 8648C	US3642U01700	4-Aug-99 (in house check Apr-13)	In house check: Apr-16
Network Analyzer HP 8753E	US3739J585	18-Oct-01 (in house check Oct-15)	In house check: Oct-16

	Name	Function	Signature
Calibrated by:	Jeton Kastrioti	Laboratory Technician	<i>[Signature]</i>
Approved by:	Katja Pokovic	Technical Manager	<i>[Signature]</i>

Issued: November 17, 2015

This calibration certificate shall not be reproduced except in full without written approval of the laboratory.



Accredited by the Swiss Accreditation Service (SAS)

Accreditation No.: **SCS 0108**

The Swiss Accreditation Service is one of the signatories to the EA Multilateral Agreement for the recognition of calibration certificates

Glossary:

TSL	tissue simulating liquid
NORM _{x,y,z}	sensitivity in free space
ConvF	sensitivity in TSL / NORM _{x,y,z}
DCP	diode compression point
CF	crest factor (1/duty_cycle) of the RF signal
A, B, C, D	modulation dependent linearization parameters
Polarization ϕ	ϕ rotation around probe axis
Polarization ϑ	ϑ rotation around an axis that is in the plane normal to probe axis (at measurement center), i.e., $\vartheta = 0$ is normal to probe axis
Connector Angle	information used in DASY system to align probe sensor X to the robot coordinate system

Calibration is Performed According to the Following Standards:

- a) IEEE Std 1528-2013, "IEEE Recommended Practice for Determining the Peak Spatial-Averaged Specific Absorption Rate (SAR) in the Human Head from Wireless Communications Devices: Measurement Techniques", June 2013
- b) IEC 62209-1, "Procedure to measure the Specific Absorption Rate (SAR) for hand-held devices used in close proximity to the ear (frequency range of 300 MHz to 3 GHz)", February 2005
- c) IEC 62209-2, "Procedure to determine the Specific Absorption Rate (SAR) for wireless communication devices used in close proximity to the human body (frequency range of 30 MHz to 6 GHz)", March 2010
- d) KDB 865664, "SAR Measurement Requirements for 100 MHz to 6 GHz"

Methods Applied and Interpretation of Parameters:

- **NORM_{x,y,z}**: Assessed for E-field polarization $\vartheta = 0$ ($f \leq 900$ MHz in TEM-cell; $f > 1800$ MHz: R22 waveguide). NORM_{x,y,z} are only intermediate values, i.e., the uncertainties of NORM_{x,y,z} does not affect the E²-field uncertainty inside TSL (see below ConvF).
- **NORM(f)_{x,y,z}** = NORM_{x,y,z} * frequency_response (see Frequency Response Chart). This linearization is implemented in DASY4 software versions later than 4.2. The uncertainty of the frequency response is included in the stated uncertainty of ConvF.
- **DCP_{x,y,z}**: DCP are numerical linearization parameters assessed based on the data of power sweep with CW signal (no uncertainty required). DCP does not depend on frequency nor media.
- **PAR**: PAR is the Peak to Average Ratio that is not calibrated but determined based on the signal characteristics
- **A_{x,y,z}; B_{x,y,z}; C_{x,y,z}; D_{x,y,z}; VR_{x,y,z}; A, B, C, D** are numerical linearization parameters assessed based on the data of power sweep for specific modulation signal. The parameters do not depend on frequency nor media. VR is the maximum calibration range expressed in RMS voltage across the diode.
- **ConvF and Boundary Effect Parameters**: Assessed in flat phantom using E-field (or Temperature Transfer Standard for $f \leq 800$ MHz) and inside waveguide using analytical field distributions based on power measurements for $f > 800$ MHz. The same setups are used for assessment of the parameters applied for boundary compensation (alpha, depth) of which typical uncertainty values are given. These parameters are used in DASY4 software to improve probe accuracy close to the boundary. The sensitivity in TSL corresponds to NORM_{x,y,z} * ConvF whereby the uncertainty corresponds to that given for ConvF. A frequency dependent ConvF is used in DASY version 4.4 and higher which allows extending the validity from ± 50 MHz to ± 100 MHz.
- **Spherical isotropy (3D deviation from isotropy)**: in a field of low gradients realized using a flat phantom exposed by a patch antenna.
- **Sensor Offset**: The sensor offset corresponds to the offset of virtual measurement center from the probe tip (on probe axis). No tolerance required.
- **Connector Angle**: The angle is assessed using the information gained by determining the NORM_x (no uncertainty required).

Probe ES3DV3

SN:3334

Manufactured: January 24, 2012
Calibrated: November 17, 2015

Calibrated for DASY/EASY Systems
(Note: non-compatible with DASY2 system!)

DASY/EASY - Parameters of Probe: ES3DV3 - SN:3334

Basic Calibration Parameters

	Sensor X	Sensor Y	Sensor Z	Unc (k=2)
Norm ($\mu\text{V}/(\text{V}/\text{m})^2$) ^A	1.03	1.03	0.99	$\pm 10.1\%$
DCP (mV) ^B	107.6	105.3	107.9	

Modulation Calibration Parameters

UID	Communication System Name		A dB	B dB/ μV	C	D dB	VR mV	Unc ^E (k=2)
0	CW	X	0.0	0.0	1.0	0.00	192.1	$\pm 2.7\%$
		Y	0.0	0.0	1.0		183.6	
		Z	0.0	0.0	1.0		183.3	
10010- CAA	SAR Validation (Square, 100ms, 10ms)	X	2.27	60.1	10.2	10.00	38.6	$\pm 1.4\%$
		Y	1.99	59.3	10.2		38.4	
		Z	5.38	67.8	12.9		37.2	
10011- CAB	UMTS-FDD (WCDMA)	X	3.40	68.0	18.9	2.91	131.7	$\pm 0.5\%$
		Y	3.27	67.0	18.2		130.2	
		Z	3.41	68.3	19.1		148.5	
10012- CAB	IEEE 802.11b WiFi 2.4 GHz (DSSS, 1 Mbps)	X	2.93	68.9	18.7	1.87	132.9	$\pm 0.7\%$
		Y	3.12	69.6	18.8		130.2	
		Z	3.24	71.1	19.7		128.2	
10013- CAB	IEEE 802.11g WiFi 2.4 GHz (DSSS-OFDM, 6 Mbps)	X	10.90	70.3	23.0	9.46	133.5	$\pm 3.3\%$
		Y	10.53	69.0	22.1		124.6	
		Z	11.14	71.2	23.6		147.1	
10021- DAB	GSM-FDD (TDMA, GMSK)	X	15.05	91.0	24.4	9.39	139.5	$\pm 1.9\%$
		Y	10.11	85.5	23.3		131.9	
		Z	11.84	87.6	23.4		130.0	
10023- DAB	GPRS-FDD (TDMA, GMSK, TN 0)	X	10.42	84.9	22.6	9.57	131.5	$\pm 3.0\%$
		Y	13.29	89.7	24.6		141.1	
		Z	14.17	90.2	24.2		148.7	
10024- DAB	GPRS-FDD (TDMA, GMSK, TN 0-1)	X	11.26	83.1	19.4	6.56	140.7	$\pm 1.9\%$
		Y	26.29	95.5	23.8		134.7	
		Z	16.82	88.9	21.3		131.6	
10027- DAB	GPRS-FDD (TDMA, GMSK, TN 0-1-2)	X	64.74	99.9	22.2	4.80	131.5	$\pm 2.2\%$
		Y	56.71	99.8	22.7		124.7	
		Z	63.10	99.9	22.2		124.1	
10028- DAB	GPRS-FDD (TDMA, GMSK, TN 0-1-2-3)	X	62.11	99.6	21.6	3.55	146.1	$\pm 1.9\%$
		Y	77.61	99.8	21.2		132.0	
		Z	72.33	99.7	21.2		133.3	
10032- CAA	IEEE 802.15.1 Bluetooth (GFSK, DH5)	X	96.24	92.7	15.9	1.16	137.2	$\pm 1.7\%$
		Y	95.69	93.1	16.2		129.5	
		Z	98.67	94.1	16.4		149.7	
10100- CAB	LTE-FDD (SC-FDMA, 100% RB, 20 MHz, QPSK)	X	6.14	66.8	19.2	5.67	126.2	$\pm 1.7\%$
		Y	6.21	66.8	19.1		139.9	
		Z	6.41	67.9	19.9		145.9	

10103-CAB	LTE-TDD (SC-FDMA, 100% RB, 20 MHz, QPSK)	X	10.07	75.4	25.8	9.29	138.2	±2.5 %
		Y	9.54	73.3	24.5		130.5	
		Z	9.84	75.1	25.8		130.6	
10108-CAC	LTE-FDD (SC-FDMA, 100% RB, 10 MHz, QPSK)	X	6.34	67.6	19.8	5.80	149.5	±1.4 %
		Y	6.13	66.6	19.1		132.1	
		Z	6.19	67.2	19.7		137.8	
10117-CAB	IEEE 802.11n (HT Mixed, 13.5 Mbps, BPSK)	X	10.13	68.9	21.2	8.07	138.8	±2.7 %
		Y	10.16	68.9	21.1		149.6	
		Z	9.96	68.7	21.1		127.1	
10151-CAB	LTE-TDD (SC-FDMA, 50% RB, 20 MHz, QPSK)	X	9.42	74.4	25.5	9.28	132.9	±3.0 %
		Y	9.50	74.0	25.0		143.7	
		Z	9.01	73.4	25.0		126.5	
10154-CAC	LTE-FDD (SC-FDMA, 50% RB, 10 MHz, QPSK)	X	6.03	67.1	19.6	5.75	145.5	±1.4 %
		Y	5.81	66.0	18.9		128.9	
		Z	5.91	66.8	19.5		135.1	
10160-CAB	LTE-FDD (SC-FDMA, 50% RB, 15 MHz, QPSK)	X	6.19	66.5	19.2	5.82	126.7	±1.4 %
		Y	6.20	66.4	19.0		132.8	
		Z	6.39	67.5	19.8		141.1	
10169-CAB	LTE-FDD (SC-FDMA, 1 RB, 20 MHz, QPSK)	X	5.05	67.6	20.0	5.73	146.8	±1.4 %
		Y	4.82	66.2	19.2		132.2	
		Z	4.96	67.4	20.0		143.8	
10172-CAB	LTE-TDD (SC-FDMA, 1 RB, 20 MHz, QPSK)	X	8.88	79.7	28.3	9.21	147.9	±3.0 %
		Y	8.00	76.1	26.2		138.9	
		Z	8.39	78.5	27.8		141.5	
10175-CAC	LTE-FDD (SC-FDMA, 1 RB, 10 MHz, QPSK)	X	4.99	67.3	19.9	5.72	140.7	±1.2 %
		Y	4.80	66.2	19.1		131.3	
		Z	4.90	67.1	19.8		136.1	
10181-CAB	LTE-FDD (SC-FDMA, 1 RB, 15 MHz, QPSK)	X	4.99	67.3	19.9	5.72	145.4	±1.4 %
		Y	4.81	66.2	19.2		130.9	
		Z	4.89	67.1	19.8		136.0	
10196-CAB	IEEE 802.11n (HT Mixed, 6.5 Mbps, BPSK)	X	9.78	68.8	21.3	8.10	131.0	±2.5 %
		Y	9.73	68.4	21.0		140.7	
		Z	9.94	69.4	21.6		146.6	
10225-CAB	UMTS-FDD (HSPA+)	X	6.88	66.9	19.3	5.97	133.9	±1.7 %
		Y	6.96	67.1	19.3		144.8	
		Z	6.71	66.6	19.2		125.7	
10237-CAB	LTE-TDD (SC-FDMA, 1 RB, 10 MHz, QPSK)	X	9.00	80.2	28.5	9.21	148.2	±3.0 %
		Y	7.73	75.1	25.7		131.6	
		Z	8.27	78.2	27.7		136.1	
10252-CAB	LTE-TDD (SC-FDMA, 50% RB, 10 MHz, QPSK)	X	9.59	76.3	26.7	9.24	144.1	±2.7 %
		Y	8.74	72.9	24.5		133.4	
		Z	9.14	75.2	26.1		136.9	
10267-CAB	LTE-TDD (SC-FDMA, 100% RB, 10 MHz, QPSK)	X	9.25	73.9	25.3	9.30	124.8	±3.0 %
		Y	9.40	73.7	24.9		142.1	
		Z	9.86	76.1	26.5		145.3	

10275-CAB	UMTS-FDD (HSUPA, Subtest 5, 3GPP Rel8.4)	X	4.38	66.9	18.7	3.96	133.3	±0.9 %
		Y	4.44	66.9	18.6		148.2	
		Z	4.30	66.7	18.6		128.9	
10291-AAB	CDMA2000, RC3, SQ55, Full Rate	X	3.68	67.3	18.7	3.46	145.8	±0.7 %
		Y	3.58	66.6	18.2		136.3	
		Z	3.62	67.3	18.8		139.4	
10292-AAB	CDMA2000, RC3, SQ32, Full Rate	X	3.73	68.0	19.1	3.39	147.5	±0.7 %
		Y	3.55	66.7	18.3		138.5	
		Z	3.60	67.6	18.9		143.0	
10297-AAA	LTE-FDD (SC-FDMA, 50% RB, 20 MHz, QPSK)	X	6.30	67.4	19.7	5.81	141.4	±1.2 %
		Y	6.11	66.5	19.1		130.3	
		Z	6.17	67.0	19.5		138.8	
10311-AAA	LTE-FDD (SC-FDMA, 100% RB, 15 MHz, QPSK)	X	6.88	68.0	20.1	6.06	147.0	±1.7 %
		Y	6.68	67.1	19.5		136.0	
		Z	6.75	67.7	20.0		141.6	
10400-AAC	IEEE 802.11ac WiFi (20MHz, 64-QAM, 99pc duty cycle)	X	9.97	68.8	21.4	8.37	126.9	±2.7 %
		Y	10.07	68.9	21.4		143.6	
		Z	10.21	69.7	22.0		147.4	
10403-AAB	CDMA2000 (1xEV-DO, Rev. 0)	X	4.77	68.5	18.8	3.76	134.9	±0.5 %
		Y	4.69	68.1	18.5		126.7	
		Z	4.74	68.8	18.9		129.4	
10404-AAB	CDMA2000 (1xEV-DO, Rev. A)	X	4.72	68.7	18.8	3.77	132.9	±0.7 %
		Y	4.78	68.9	18.9		147.4	
		Z	4.63	68.7	18.9		127.1	
10415-AAA	IEEE 802.11b WiFi 2.4 GHz (DSSS, 1 Mbps, 99pc duty cycle)	X	2.72	68.9	18.8	1.54	131.9	±0.5 %
		Y	2.65	68.0	18.1		145.9	
		Z	2.72	69.3	19.0		127.3	
10416-AAA	IEEE 802.11g WiFi 2.4 GHz (ERP-OFDM, 6 Mbps, 99pc duty cycle)	X	9.81	68.6	21.2	8.23	131.6	±2.7 %
		Y	9.90	68.7	21.2		144.1	
		Z	9.97	69.3	21.7		146.0	

The reported uncertainty of measurement is stated as the standard uncertainty of measurement multiplied by the coverage factor $k=2$, which for a normal distribution corresponds to a coverage probability of approximately 95%.

^A The uncertainties of Norm X,Y,Z do not affect the E^2 -field uncertainty inside TSL (see Pages 7 and 8).

^B Numerical linearization parameter: uncertainty not required.

^C Uncertainty is determined using the max. deviation from linear response applying rectangular distribution and is expressed for the square of the field value.

DASY/EASY - Parameters of Probe: ES3DV3 - SN:3334

Calibration Parameter Determined in Head Tissue Simulating Media

f (MHz) ^c	Relative Permittivity ^e	Conductivity (S/m) ^e	ConvF X	ConvF Y	ConvF Z	Alpha ^g	Depth (mm) ^h	Unc (k=2)
6	55.5	0.75	6.13	6.13	6.13	0.00	1.00	± 13.3 %
13	55.5	0.75	5.76	5.76	5.76	0.00	1.00	± 13.3 %
750	41.9	0.89	6.56	6.56	6.56	0.24	2.36	± 12.0 %
835	41.5	0.90	6.37	6.37	6.37	0.37	1.70	± 12.0 %
1750	40.1	1.37	5.39	5.39	5.39	0.58	1.32	± 12.0 %
1900	40.0	1.40	5.18	5.18	5.18	0.77	1.20	± 12.0 %
2300	39.5	1.67	4.85	4.85	4.85	0.71	1.28	± 12.0 %
2450	39.2	1.80	4.58	4.58	4.58	0.79	1.17	± 12.0 %
2600	39.0	1.96	4.46	4.46	4.46	0.80	1.26	± 12.0 %

^c Frequency validity above 300 MHz of ± 100 MHz only applies for DASY v4.4 and higher (see Page 2), else it is restricted to ± 50 MHz. The uncertainty is the RSS of the ConvF uncertainty at calibration frequency and the uncertainty for the indicated frequency band. Frequency validity below 300 MHz is ± 10, 25, 40, 50 and 70 MHz for ConvF assessments at 30, 64, 128, 150 and 220 MHz respectively. Above 5 GHz frequency validity can be extended to ± 110 MHz.

^e At frequencies below 3 GHz, the validity of tissue parameters (ϵ and σ) can be relaxed to ± 10% if liquid compensation formula is applied to measured SAR values. At frequencies above 3 GHz, the validity of tissue parameters (ϵ and σ) is restricted to ± 5%. The uncertainty is the RSS of the ConvF uncertainty for indicated target tissue parameters.

^g Alpha/Depth are determined during calibration. SPEAG warrants that the remaining deviation due to the boundary effect after compensation is always less than ± 1% for frequencies below 3 GHz and below ± 2% for frequencies between 3-6 GHz at any distance larger than half the probe tip diameter from the boundary.

DASY/EASY - Parameters of Probe: ES3DV3 - SN:3334

Calibration Parameter Determined in Body Tissue Simulating Media

f (MHz) ^c	Relative Permittivity ^f	Conductivity (S/m) ^f	ConvF X	ConvF Y	ConvF Z	Alpha ^g	Depth ^g (mm)	Unc (k=2)
750	55.5	0.96	6.37	6.37	6.37	0.74	1.22	± 12.0 %
835	55.2	0.97	6.24	6.24	6.24	0.31	1.94	± 12.0 %
1750	53.4	1.49	5.03	5.03	5.03	0.50	1.57	± 12.0 %
1900	53.3	1.52	4.84	4.84	4.84	0.50	1.58	± 12.0 %
2300	52.9	1.81	4.61	4.61	4.61	0.74	1.23	± 12.0 %
2450	52.7	1.95	4.45	4.45	4.45	0.74	1.20	± 12.0 %
2600	52.5	2.16	4.29	4.29	4.29	0.80	1.20	± 12.0 %

^c Frequency validity above 300 MHz of ± 100 MHz only applies for DASY v4.4 and higher (see Page 2), else it is restricted to ± 50 MHz. The uncertainty is the RSS of the ConvF uncertainty at calibration frequency and the uncertainty for the indicated frequency band. Frequency validity below 300 MHz is ± 10, 25, 40, 50 and 70 MHz for ConvF assessments at 30, 64, 128, 150 and 220 MHz respectively. Above 5 GHz frequency validity can be extended to ± 110 MHz.

^f At frequencies below 3 GHz, the validity of tissue parameters (ϵ and σ) can be relaxed to ± 10% if liquid compensation formula is applied to measured SAR values. At frequencies above 3 GHz, the validity of tissue parameters (ϵ and σ) is restricted to ± 5%. The uncertainty is the RSS of the ConvF uncertainty for indicated target tissue parameters.

^g Alpha/Depth are determined during calibration. SPEAG warrants that the remaining deviation due to the boundary effect after compensation is always less than ± 1% for frequencies below 3 GHz and below ± 2% for frequencies between 3-6 GHz at any distance larger than half the probe tip diameter from the boundary.

Frequency Response of E-Field

(TEM-Cell:ifi110 EXX, Waveguide: R22)

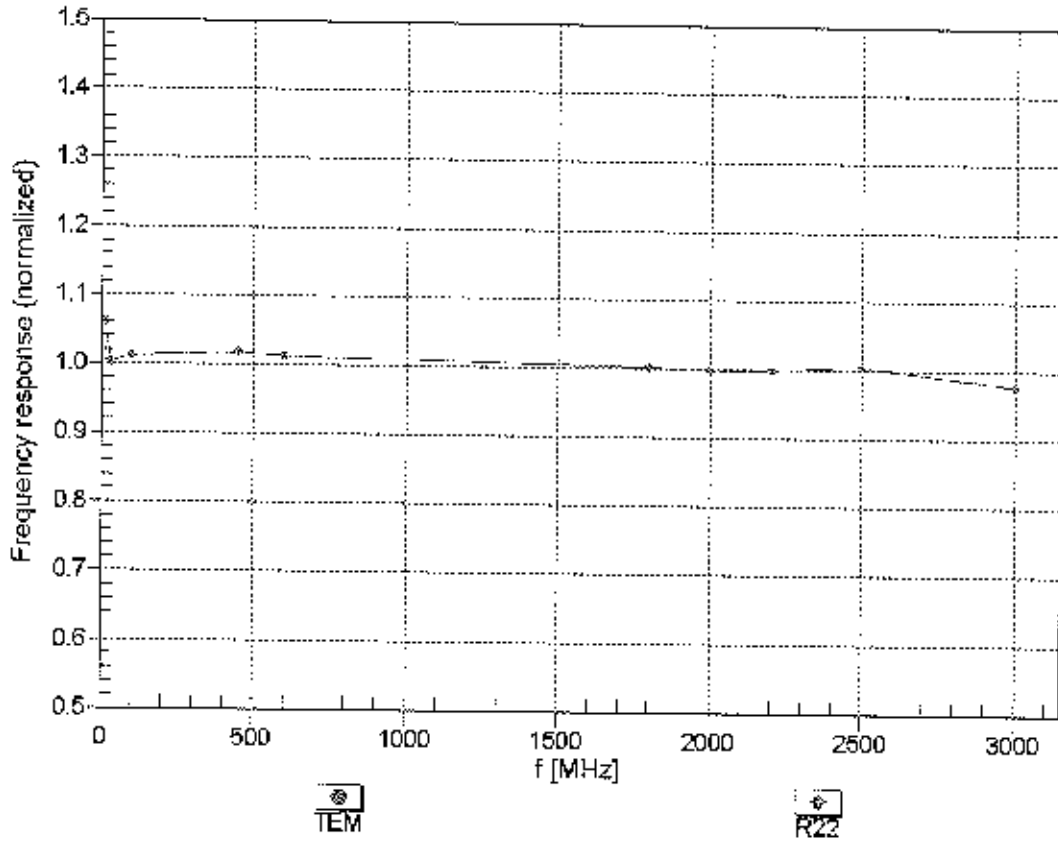

Uncertainty of Frequency Response of E-field: $\pm 6.3\%$ (k=2)

Receiving Pattern (ϕ), $\theta = 0^\circ$

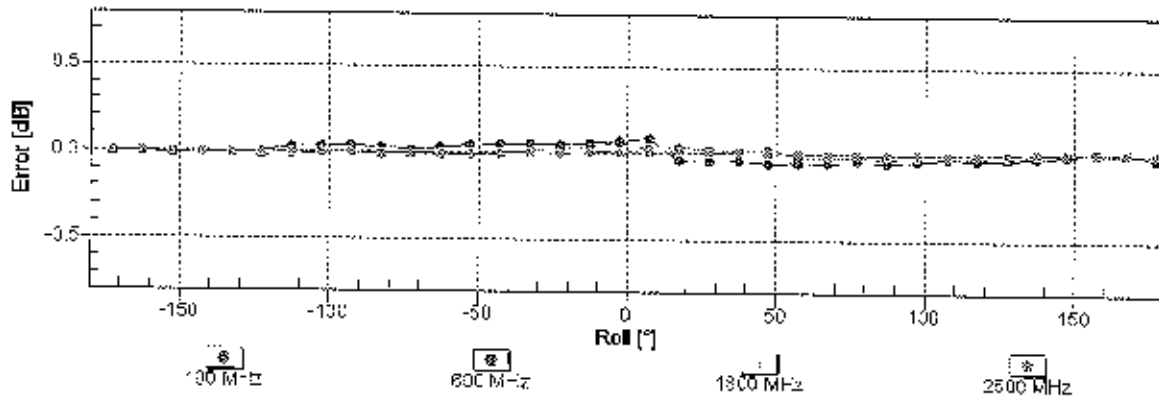
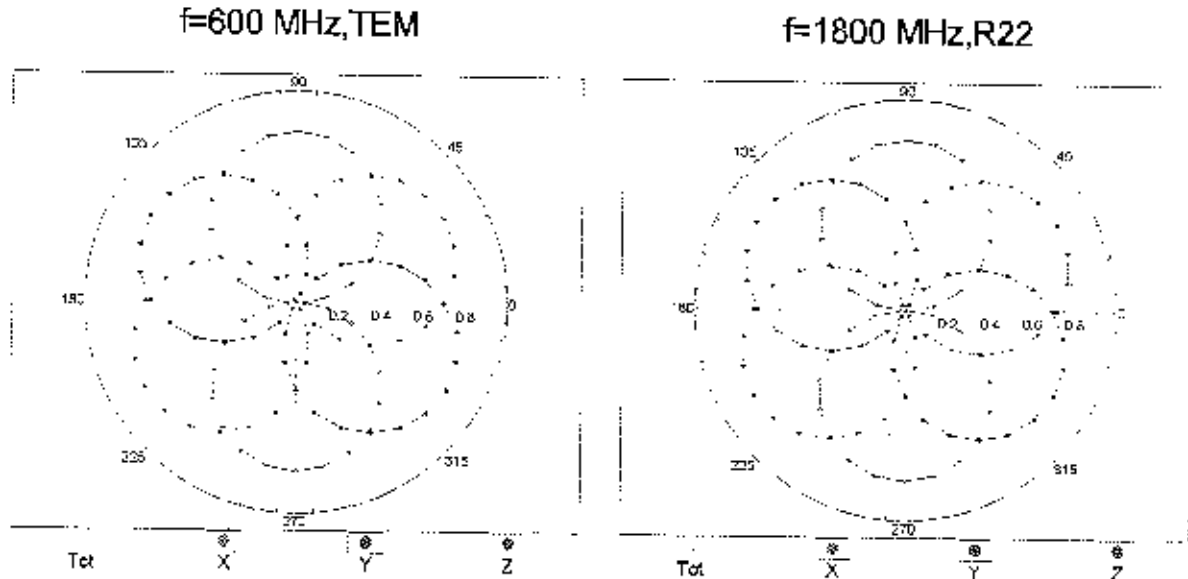

Uncertainty of Axial Isotropy Assessment: $\pm 0.5\%$ ($k=2$)

Dynamic Range $f(\text{SAR}_{\text{head}})$ (TEM cell, $f_{\text{eval}} = 1900 \text{ MHz}$)

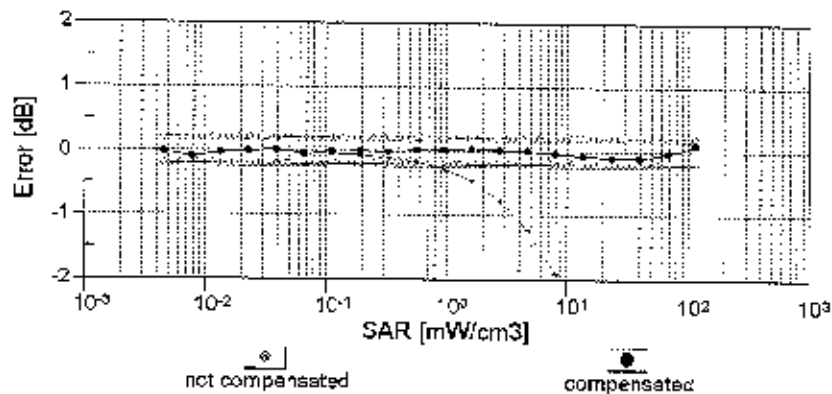
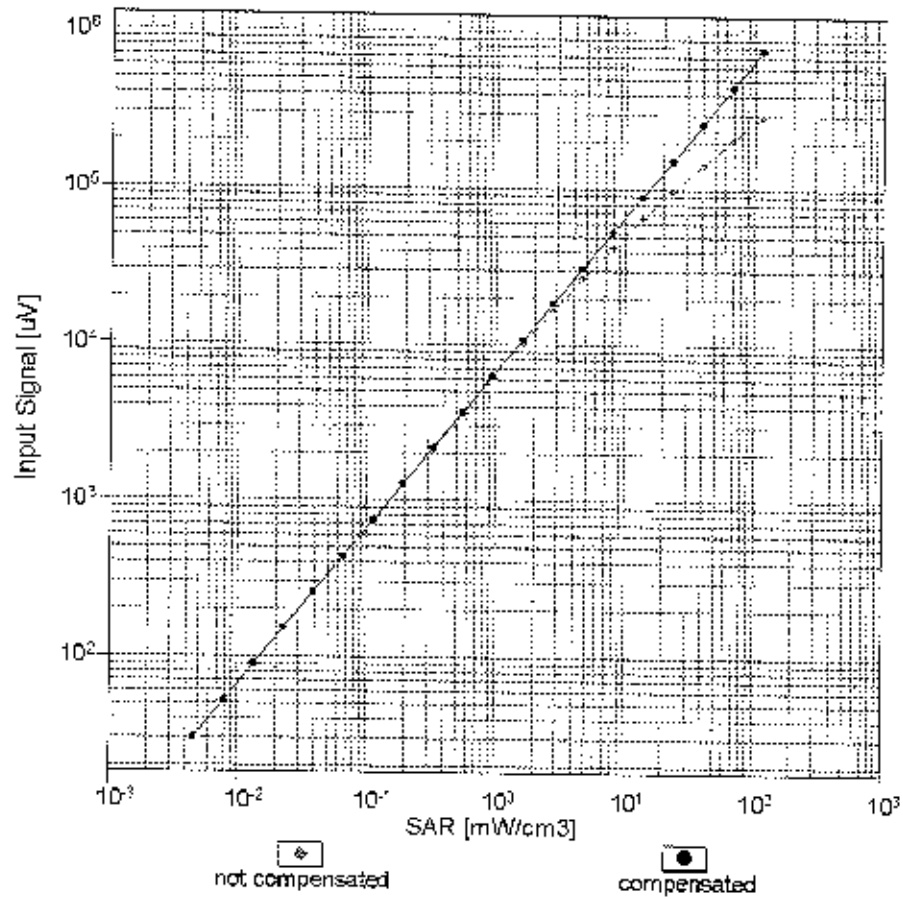

Uncertainty of Linearity Assessment: $\pm 0.6\%$ ($k=2$)

Conversion Factor Assessment

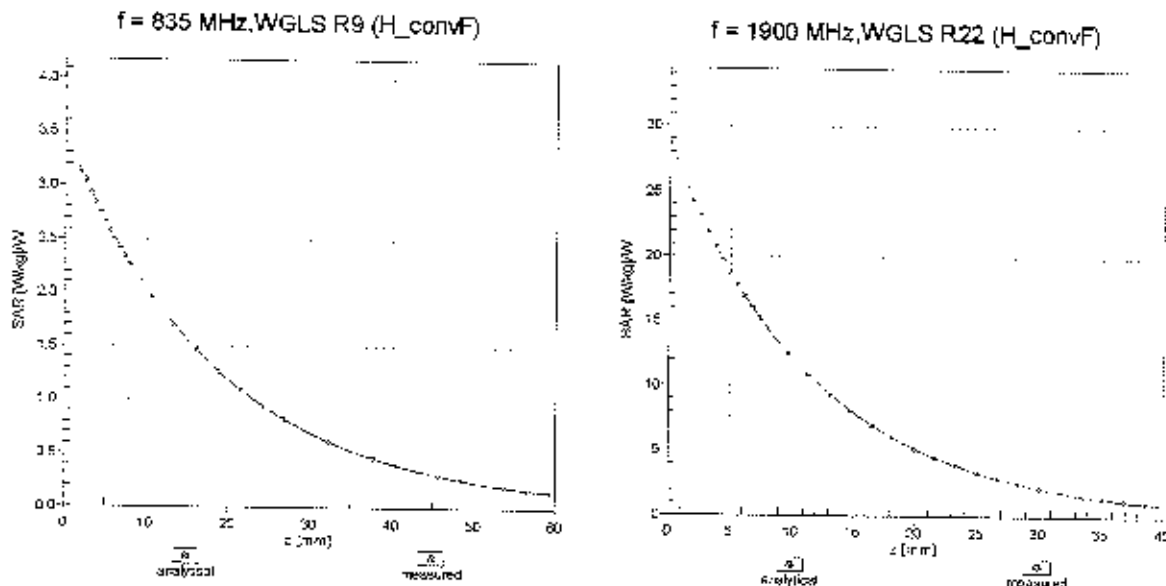

Deviation from Isotropy in Liquid Error (ϕ, θ), f = 900 MHz

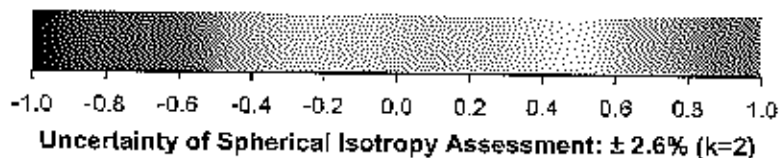
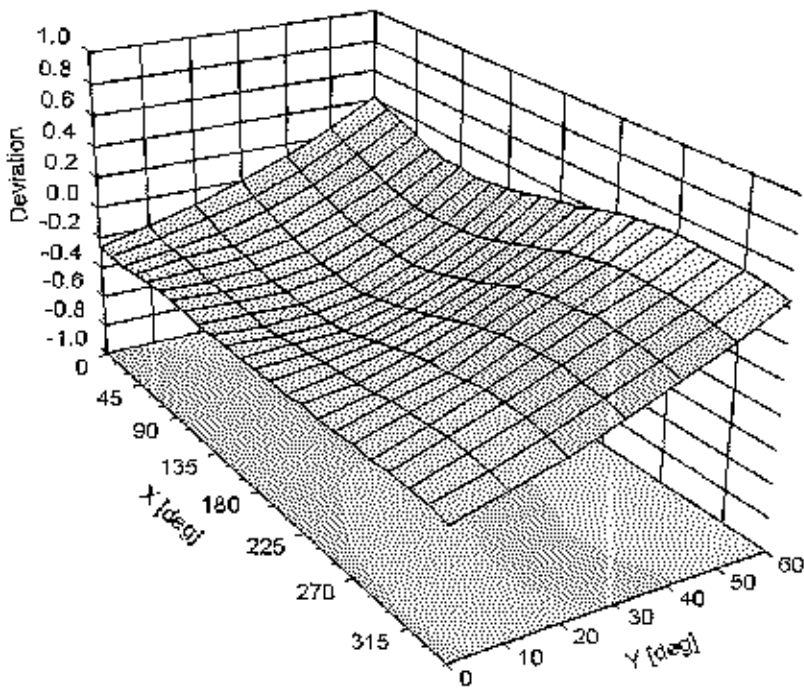

DASY/EASY - Parameters of Probe: ES3DV3 - SN:3334

Other Probe Parameters

Sensor Arrangement	Triangular
Connector Angle (°)	17.4
Mechanical Surface Detection Mode	enabled
Optical Surface Detection Mode	disabled
Probe Overall Length	337 mm
Probe Body Diameter	10 mm
Tip Length	10 mm
Tip Diameter	4 mm
Probe Tip to Sensor X Calibration Point	2 mm
Probe Tip to Sensor Y Calibration Point	2 mm
Probe Tip to Sensor Z Calibration Point	2 mm
Recommended Measurement Distance from Surface	3 mm

**Calibration Laboratory of
Schmid & Partner
Engineering AG**
Zeughausstrasse 43, 8004 Zurich, Switzerland



S Schweizerischer Kalibrierdienst
C Service suisse d'étalonnage
S Servizio svizzero di taratura
S Swiss Calibration Service

Accredited by the Swiss Accreditation Service (SAS)
The Swiss Accreditation Service is one of the signatories to the EA
Multilateral Agreement for the recognition of calibration certificates

Accreditation No.: **SCS 0108**

Client **PC Test**

Certificate No: **ES3-3351_Jun15**

CALIBRATION CERTIFICATE

Object **ES3DV3 - SN:3351**

Calibration procedure(s) **QA CAL-01.v9, QA CAL-23.v5, QA CAL-25.v6
Calibration procedure for dosimetric E-field probes**

Calibration date: **June 22, 2015**

This calibration certificate documents the traceability to national standards, which realize the physical units of measurements (SI).
The measurements and the uncertainties with confidence probability are given on the following pages and are part of the certificate.

All calibrations have been conducted in the closed laboratory facility: environment temperature (22 ± 3)°C and humidity < 70%.

Calibration Equipment used (M&TE critical for calibration)

*BN ✓
06/25/15*

Primary Standards	ID	Cal Date (Certificate No.)	Scheduled Calibration
Power meter E4419B	GB41293874	01-Apr-15 (No. 217-02128)	Mar-16
Power sensor E4412A	MY41498087	01-Apr-15 (No. 217-02128)	Mar-16
Reference 3 dB Attenuator	SN: S5054 (3c)	01-Apr-15 (No. 217-02129)	Mar-16
Reference 20 dB Attenuator	SN: S5277 (20x)	01-Apr-15 (No. 217-02132)	Mar-16
Reference 30 dB Attenuator	SN: S5129 (30b)	01-Apr-15 (No. 217-02133)	Mar-16
Reference Probe ES3DV2	SN: 3013	30-Dec-14 (No. ES3-3013_Dec14)	Dec-15
DAE4	SN: 660	14-Jan-15 (No. DAE4-660_Jan15)	Jan-16
Secondary Standards	ID	Check Date (in house)	Scheduled Check
RF generator HP 8648C	US3642U01700	4-Aug-99 (in house check Apr-13)	In house check: Apr-16
Network Analyzer HP 8753E	US37390585	18-Oct-01 (in house check Oct-14)	In house check: Oct-15

Calibrated by:	Name Leif Klysner	Function Laboratory Technician	Signature <i>Leif Klysner</i>
Approved by:	Name Katja Pokovic	Function Technical Manager	Signature <i>Katja Pokovic</i>
			Issued: June 22, 2015
This calibration certificate shall not be reproduced except in full without written approval of the laboratory.			



Accredited by the Swiss Accreditation Service (SAS)

Accreditation No.: **SCS 0108**

The Swiss Accreditation Service is one of the signatories to the EA
Multilateral Agreement for the recognition of calibration certificates

Glossary:

TSL	tissue simulating liquid
NORM _{x,y,z}	sensitivity in free space
ConvF	sensitivity in TSL / NORM _{x,y,z}
DCP	diode compression point
CF	crest factor (1/duty_cycle) of the RF signal
A, B, C, D	modulation dependent linearization parameters
Polarization ϕ	ϕ rotation around probe axis
Polarization ϑ	ϑ rotation around an axis that is in the plane normal to probe axis (at measurement center), i.e., $\vartheta = 0$ is normal to probe axis
Connector Angle	information used in DASY system to align probe sensor X to the robot coordinate system

Calibration is Performed According to the Following Standards:

- IEEE Std 1528-2013, "IEEE Recommended Practice for Determining the Peak Spatial-Averaged Specific Absorption Rate (SAR) in the Human Head from Wireless Communications Devices: Measurement Techniques", June 2013
- IEC 62209-1, "Procedure to measure the Specific Absorption Rate (SAR) for hand-held devices used in close proximity to the ear (frequency range of 300 MHz to 3 GHz)", February 2005

Methods Applied and Interpretation of Parameters:

- NORM_{x,y,z}**: Assessed for E-field polarization $\vartheta = 0$ ($f \leq 900$ MHz in TEM-cell; $f > 1800$ MHz: R22 waveguide). NORM_{x,y,z} are only intermediate values, i.e., the uncertainties of NORM_{x,y,z} does not affect the E²-field uncertainty inside TSL (see below *ConvF*).
- NORM(f)_{x,y,z} = NORM_{x,y,z} * frequency_response** (see Frequency Response Chart). This linearization is implemented in DASY4 software versions later than 4.2. The uncertainty of the frequency response is included in the stated uncertainty of *ConvF*.
- DCP_{x,y,z}**: DCP are numerical linearization parameters assessed based on the data of power sweep with CW signal (no uncertainty required). DCP does not depend on frequency nor media.
- PAR**: PAR is the Peak to Average Ratio that is not calibrated but determined based on the signal characteristics
- A_{x,y,z}; B_{x,y,z}; C_{x,y,z}; D_{x,y,z}; VR_{x,y,z}; A, B, C, D** are numerical linearization parameters assessed based on the data of power sweep for specific modulation signal. The parameters do not depend on frequency nor media. VR is the maximum calibration range expressed in RMS voltage across the diode.
- ConvF and Boundary Effect Parameters**: Assessed in flat phantom using E-field (or Temperature Transfer Standard for $f \leq 800$ MHz) and inside waveguide using analytical field distributions based on power measurements for $f > 800$ MHz. The same setups are used for assessment of the parameters applied for boundary compensation (alpha, depth) of which typical uncertainty values are given. These parameters are used in DASY4 software to improve probe accuracy close to the boundary. The sensitivity in TSL corresponds to NORM_{x,y,z} * ConvF whereby the uncertainty corresponds to that given for ConvF. A frequency dependent ConvF is used in DASY version 4.4 and higher which allows extending the validity from ± 50 MHz to ± 100 MHz.
- Spherical isotropy (3D deviation from isotropy)**: in a field of low gradients realized using a flat phantom exposed by a patch antenna.
- Sensor Offset**: The sensor offset corresponds to the offset of virtual measurement center from the probe tip (on probe axis). No tolerance required.
- Connector Angle**: The angle is assessed using the information gained by determining the NORM_x (no uncertainty required).