

**Calibration Laboratory of
Schmid & Partner
Engineering AG**
Zeughausstrasse 43, 8004 Zurich, Switzerland



S Schweizerischer Kalibrierdienst
C Service suisse d'étalonnage
S Servizio svizzero di taratura
Swiss Calibration Service

Accredited by the Swiss Accreditation Service (SAS)
The Swiss Accreditation Service is one of the signatories to the EA
Multilateral Agreement for the recognition of calibration certificates

Accreditation No.: **SCS 108**

Client **PC Test**

Certificate No: **ES3-3022_Aug14/2**

CALIBRATION CERTIFICATE (Replacement of No: ES3-3022_Aug14)

Object **ES3DV2 - SN:3022**

Calibration procedure(s) **QA CAL-01.v9, QA CAL-12.v9, QA CAL-23.v5, QA CAL-25.v6
Calibration procedure for dosimetric E-field probes** CC
D/M/14

Calibration date: **August 19, 2014**

This calibration certificate documents the traceability to national standards, which realize the physical units of measurements (SI).
The measurements and the uncertainties with confidence probability are given on the following pages and are part of the certificate.

All calibrations have been conducted in the closed laboratory facility: environment temperature (22 ± 3)°C and humidity < 70%.

Calibration Equipment used (M&TE critical for calibration)

Primary Standards	ID	Cal Date (Certificate No.)	Scheduled Calibration
Power meter E4419B	GB41293874	03-Apr-14 (No. 217-01911)	Apr-15
Power sensor E4412A	MY41498087	03-Apr-14 (No. 217-01911)	Apr-15
Reference 3 dB Attenuator	SN: S5054 (3c)	03-Apr-14 (No. 217-01915)	Apr-15
Reference 20 dB Attenuator	SN: S5277 (20x)	03-Apr-14 (No. 217-01919)	Apr-15
Reference 30 dB Attenuator	SN: S5129 (30b)	03-Apr-14 (No. 217-01920)	Apr-15
Reference Probe ES3DV2	SN: 3013	30-Dec-13 (No. ES3-3013_Dec13)	Dec-14
DAE4	SN: 660	13-Dec-13 (No. DAE4-660_Dec13)	Dec-14
Secondary Standards	ID	Check Date (in house)	Scheduled Check
RF generator HP 8648C	US3642U01700	4-Aug-99 (in house check Apr-13)	In house check: Apr-16
Network Analyzer HP 8753E	US37390585	18-Oct-01 (in house check Oct-13)	In house check: Oct-14

Calibrated by:	Name Jeton Kastrali	Function Laboratory Technician	Signature
Approved by:	Name Katja Pokovic	Function Technical Manager	

Issued: November 3, 2014

This calibration certificate shall not be reproduced except in full without written approval of the laboratory.



Accredited by the Swiss Accreditation Service (SAS)
The Swiss Accreditation Service is one of the signatories to the EA
Multilateral Agreement for the recognition of calibration certificates

Accreditation No.: **SCS 108**

Glossary:

TSL	tissue simulating liquid
NORM _{x,y,z}	sensitivity in free space
ConvF	sensitivity in TSL / NORM _{x,y,z}
DCP	diode compression point
CF	crest factor (1/duty_cycle) of the RF signal
A, B, C, D	modulation dependent linearization parameters
Polarization φ	φ rotation around probe axis
Polarization ϑ	ϑ rotation around an axis that is in the plane normal to probe axis (at measurement center), i.e., $\vartheta = 0$ is normal to probe axis
Connector Angle	information used in DASY system to align probe sensor X to the robot coordinate system

Calibration is Performed According to the Following Standards:

- IEEE Std 1528-2013, "IEEE Recommended Practice for Determining the Peak Spatial-Averaged Specific Absorption Rate (SAR) in the Human Head from Wireless Communications Devices: Measurement Techniques", June 2013
- IEC 62209-1, "Procedure to measure the Specific Absorption Rate (SAR) for hand-held devices used in close proximity to the ear (frequency range of 300 MHz to 3 GHz)", February 2005

Methods Applied and Interpretation of Parameters:

- NORM_{x,y,z}**: Assessed for E-field polarization $\vartheta = 0$ ($f \leq 900$ MHz in TEM-cell; $f > 1800$ MHz: R22 waveguide). NORM_{x,y,z} are only intermediate values, i.e., the uncertainties of NORM_{x,y,z} does not affect the E²-field uncertainty inside TSL (see below ConvF).
- NORM(f)_{x,y,z} = NORM_{x,y,z} * frequency_response** (see Frequency Response Chart). This linearization is implemented in DASY4 software versions later than 4.2. The uncertainty of the frequency response is included in the stated uncertainty of ConvF.
- DCP_{x,y,z}**: DCP are numerical linearization parameters assessed based on the data of power sweep with CW signal (no uncertainty required). DCP does not depend on frequency nor media.
- PAR**: PAR is the Peak to Average Ratio that is not calibrated but determined based on the signal characteristics
- A_{x,y,z}; B_{x,y,z}; C_{x,y,z}; D_{x,y,z}; VR_{x,y,z}; A, B, C, D** are numerical linearization parameters assessed based on the data of power sweep for specific modulation signal. The parameters do not depend on frequency nor media. VR is the maximum calibration range expressed in RMS voltage across the diode.
- ConvF and Boundary Effect Parameters**: Assessed in flat phantom using E-field (or Temperature Transfer Standard for $f \leq 800$ MHz) and inside waveguide using analytical field distributions based on power measurements for $f > 800$ MHz. The same setups are used for assessment of the parameters applied for boundary compensation (alpha, depth) of which typical uncertainty values are given. These parameters are used in DASY4 software to improve probe accuracy close to the boundary. The sensitivity in TSL corresponds to NORM_{x,y,z} * ConvF whereby the uncertainty corresponds to that given for ConvF. A frequency dependent ConvF is used in DASY version 4.4 and higher which allows extending the validity from ± 50 MHz to ± 100 MHz.
- Spherical isotropy (3D deviation from isotropy)**: in a field of low gradients realized using a flat phantom exposed by a patch antenna.
- Sensor Offset**: The sensor offset corresponds to the offset of virtual measurement center from the probe tip (on probe axis). No tolerance required.
- Connector Angle**: The angle is assessed using the information gained by determining the NORM_x (no uncertainty required).

Probe ES3DV2

SN:3022

Manufactured: April 15, 2003
Calibrated: August 19, 2014

Calibrated for DASY/EASY Systems
(Note: non-compatible with DASY2 system!)

DASY/EASY - Parameters of Probe: ES3DV2 - SN:3022

Basic Calibration Parameters

	Sensor X	Sensor Y	Sensor Z	Unc (k=2)
Norm ($\mu\text{V}/(\text{V}/\text{m})^2$) ^A	1.00	1.04	0.96	$\pm 10.1 \%$
DCP (mV) ^B	103.0	96.3	101.6	

Modulation Calibration Parameters

UID	Communication System Name		A dB	B dB $\sqrt{\mu\text{V}}$	C	D dB	VR mV	Unc ^E (k=2)
0	CW	X	0.0	0.0	1.0	0.00	181.8	$\pm 2.7 \%$
		Y	0.0	0.0	1.0		183.0	
		Z	0.0	0.0	1.0		192.3	
10010- CAA	SAR Validation (Square, 100ms, 10ms)	X	2.51	63.1	12.7	10.00	42.6	$\pm 1.9 \%$
		Y	2.62	63.1	12.9		42.7	
		Z	3.12	65.7	13.6		40.4	
10011- CAB	UMTS-FDD (WCDMA)	X	3.33	67.8	19.2	2.91	145.9	$\pm 0.9 \%$
		Y	3.13	64.9	16.9		147.4	
		Z	3.20	66.4	18.2		139.6	
10012- CAA	IEEE 802.11b WiFi 2.4 GHz (DSSS, 1 Mbps)	X	3.05	70.1	19.8	1.87	147.2	$\pm 0.9 \%$
		Y	2.62	65.1	16.2		147.4	
		Z	2.85	68.2	18.4		141.7	
10013- CAA	IEEE 802.11g WiFi 2.4 GHz (DSSS-OFDM, 6 Mbps)	X	11.10	70.9	23.6	9.46	143.9	$\pm 3.0 \%$
		Y	11.04	70.2	22.9		144.2	
		Z	10.77	70.2	23.1		134.7	
10021- DAB	GSM-FDD (TDMA, GMSK)	X	19.66	99.7	28.6	9.39	126.0	$\pm 1.9 \%$
		Y	11.04	89.6	25.5		138.9	
		Z	10.45	88.8	24.9		137.5	
10023- DAB	GPRS-FDD (TDMA, GMSK, TN 0)	X	20.19	99.6	28.5	9.57	142.0	$\pm 2.5 \%$
		Y	10.53	88.4	25.0		145.5	
		Z	15.52	96.5	27.8		147.6	
10024- DAB	GPRS-FDD (TDMA, GMSK, TN 0-1)	X	31.93	99.6	25.2	6.56	149.5	$\pm 1.9 \%$
		Y	12.70	87.9	22.2		148.0	
		Z	27.00	99.8	25.7		135.3	
10027- DAB	GPRS-FDD (TDMA, GMSK, TN 0-1-2)	X	38.32	99.8	23.8	4.80	148.1	$\pm 2.2 \%$
		Y	9.80	83.2	19.3		138.8	
		Z	31.96	99.9	24.2		128.9	
10028- DAB	GPRS-FDD (TDMA, GMSK, TN 0-1-2-3)	X	40.03	99.5	22.8	3.55	130.5	$\pm 2.2 \%$
		Y	40.27	99.6	23.0		148.1	
		Z	43.09	99.7	22.5		140.1	
10032- CAA	IEEE 802.15.1 Bluetooth (GFSK, DH5)	X	38.93	99.4	20.4	1.16	146.7	$\pm 1.9 \%$
		Y	32.83	92.5	17.9		139.2	
		Z	31.94	99.5	20.8		133.1	
10039- CAB	CDMA2000 (1xRTT, RC1)	X	4.66	66.8	19.3	4.57	144.5	$\pm 1.2 \%$
		Y	4.56	65.3	17.9		137.2	
		Z	4.52	66.1	18.7		131.7	

10081-CAB	CDMA2000 (1xRTT, RC3)	X	3.82	66.0	18.7	3.97	140.3	±0.9 %
		Y	3.77	64.5	17.3		133.6	
		Z	3.79	65.7	18.4		128.2	
10098-CAB	UMTS-FDD (HSUPA, Subtest 2)	X	4.40	66.2	18.5	3.98	130.9	±1.2 %
		Y	4.39	65.0	17.4		131.1	
		Z	4.47	66.3	18.4		140.0	
10100-CAB	LTE-FDD (SC-FDMA, 100% RB, 20 MHz, QPSK)	X	6.30	67.3	19.8	5.67	137.4	±1.7 %
		Y	6.25	66.3	18.9		135.9	
		Z	6.36	67.4	19.7		147.5	
10108-CAB	LTE-FDD (SC-FDMA, 100% RB, 10 MHz, QPSK)	X	6.14	66.8	19.6	5.80	134.6	±1.7 %
		Y	6.17	66.1	18.9		133.9	
		Z	6.24	67.0	19.7		144.5	
10110-CAB	LTE-FDD (SC-FDMA, 100% RB, 6 MHz, QPSK)	X	5.82	66.3	19.4	5.75	131.2	±1.7 %
		Y	5.82	65.4	18.6		130.3	
		Z	5.91	66.5	19.4		140.4	
10114-CAA	IEEE 802.11n (HT Greenfield, 13.5 Mbps, BPSK)	X	10.00	68.5	21.2	8.10	124.3	±2.5 %
		Y	9.89	67.9	20.6		124.0	
		Z	10.05	68.6	21.2		133.2	
10117-CAA	IEEE 802.11n (HT Mixed, 13.5 Mbps, BPSK)	X	10.01	68.6	21.2	8.07	125.8	±2.5 %
		Y	9.91	67.9	20.7		125.8	
		Z	10.09	68.8	21.3		134.7	
10151-CAB	LTE-TDD (SC-FDMA, 50% RB, 20 MHz, QPSK)	X	9.69	75.5	26.4	9.28	144.7	±3.3 %
		Y	9.09	72.7	24.6		143.2	
		Z	8.54	72.0	24.5		124.8	
10154-CAB	LTE-FDD (SC-FDMA, 50% RB, 10 MHz, QPSK)	X	5.82	66.2	19.4	5.75	131.3	±1.9 %
		Y	6.06	66.3	19.1		149.2	
		Z	5.91	66.5	19.4		140.7	
10160-CAB	LTE-FDD (SC-FDMA, 50% RB, 15 MHz, QPSK)	X	6.27	66.9	19.7	5.82	136.5	±1.4 %
		Y	6.19	65.8	18.7		128.4	
		Z	6.33	67.0	19.6		145.4	
10169-CAB	LTE-FDD (SC-FDMA, 1 RB, 20 MHz, QPSK)	X	4.81	66.4	19.7	5.73	134.8	±1.7 %
		Y	4.92	66.1	19.1		149.9	
		Z	4.78	66.4	19.6		141.2	
10172-CAB	LTE-TDD (SC-FDMA, 1 RB, 20 MHz, QPSK)	X	7.83	76.6	27.2	9.21	131.4	±3.5 %
		Y	7.54	74.5	25.8		147.8	
		Z	7.71	76.7	27.4		145.3	
10175-CAB	LTE-FDD (SC-FDMA, 1 RB, 10 MHz, QPSK)	X	4.90	66.9	20.0	5.72	147.6	±1.4 %
		Y	4.90	66.0	19.1		148.0	
		Z	4.78	66.4	19.6		141.6	
10181-CAB	LTE-FDD (SC-FDMA, 1 RB, 15 MHz, QPSK)	X	4.90	66.9	20.0	5.72	148.1	±1.4 %
		Y	4.89	65.9	19.0		146.9	
		Z	4.80	66.5	19.7		142.1	
10193-CAA	IEEE 802.11n (HT Greenfield, 6.5 Mbps, BPSK)	X	9.80	68.7	21.4	8.09	135.1	±2.7 %
		Y	9.78	68.2	20.9		135.5	
		Z	9.70	68.5	21.2		130.2	

10196-CAA	IEEE 802.11n (HT Mixed, 6.5 Mbps, BPSK)	X	9.79	68.7	21.4	8.10	136.4	±2.7 %
		Y	9.81	68.3	20.9		138.0	
		Z	9.72	68.6	21.3		132.8	
10219-CAA	IEEE 802.11n (HT Mixed, 7.2 Mbps, BPSK)	X	9.68	68.6	21.3	8.03	136.0	±2.7 %
		Y	9.74	68.3	21.0		137.4	
		Z	9.62	68.5	21.2		132.6	
10222-CAA	IEEE 802.11n (HT Mixed, 15 Mbps, BPSK)	X	10.20	69.1	21.5	8.06	143.4	±2.5 %
		Y	9.91	60.0	20.7		125.8	
		Z	10.27	69.4	21.6		148.4	
10225-CAB	UMTS-FDD (HSPA+)	X	6.87	66.9	19.6	5.97	139.5	±1.9 %
		Y	7.04	66.9	19.3		149.3	
		Z	6.89	67.0	19.5		143.5	
10237-CAB	LTE-TDD (SC-FDMA, 1 RB, 10 MHz, QPSK)	X	7.66	75.9	26.9	9.21	126.1	±3.0 %
		Y	7.17	73.1	25.1		132.1	
		Z	7.18	74.6	26.3		128.0	
10252-CAB	LTE-TDD (SC-FDMA, 50% RB, 10 MHz, QPSK)	X	8.58	73.1	25.3	9.24	127.6	±3.3 %
		Y	8.22	71.0	23.7		126.9	
		Z	8.83	74.3	26.0		149.8	
10267-CAB	LTE-TDD (SC-FDMA, 100% RB, 10 MHz, QPSK)	X	9.69	75.5	26.5	9.30	143.8	±3.3 %
		Y	8.88	72.0	24.2		135.2	
		Z	8.83	72.9	25.1		131.3	
10274-CAB	UMTS-FDD (HSUPA, Subtest 5, 3GPP Rel8.10)	X	5.87	67.0	19.2	4.87	141.2	±1.4 %
		Y	5.77	65.8	18.1		136.0	
		Z	5.71	66.3	18.6		132.7	
10275-CAB	UMTS-FDD (HSUPA, Subtest 5, 3GPP Rel8.4)	X	4.44	67.2	19.2	3.96	147.3	±0.9 %
		Y	4.29	65.3	17.6		139.2	
		Z	4.31	66.3	18.5		139.6	
10291-AAB	CDMA2000, RC3, SO55, Full Rate	X	3.60	67.1	19.1	3.46	137.8	±0.7 %
		Y	3.44	64.8	17.2		129.6	
		Z	3.48	66.2	18.4		130.5	
10292-AAB	CDMA2000, RC3, SO32, Full Rate	X	3.50	66.9	18.9	3.39	139.5	±0.7 %
		Y	3.38	64.8	17.2		132.0	
		Z	3.48	66.5	18.5		133.1	
10297-AAA	LTE-FDD (SC-FDMA, 50% RB, 20 MHz, QPSK)	X	6.12	66.7	19.6	5.81	133.3	±1.9 %
		Y	6.35	66.7	19.3		149.3	
		Z	6.17	66.8	19.5		132.7	
10311-AAA	LTE-FDD (SC-FDMA, 100% RB, 15 MHz, QPSK)	X	6.72	67.4	20.0	6.06	138.7	±1.7 %
		Y	6.63	66.3	19.1		131.4	
		Z	6.72	67.3	19.9		138.7	
10315-AAA	IEEE 802.11b WiFi 2.4 GHz (DSSS, 1 Mbps, 96pc duty cycle)	X	2.90	69.9	19.8	1.71	146.4	±0.5 %
		Y	2.54	65.2	16.5		139.3	
		Z	2.75	68.1	18.5		146.4	
10316-AAA	IEEE 802.11g WiFi 2.4 GHz (ERP-OFDM, 6 Mbps, 96pc duty cycle)	X	10.12	69.3	21.9	8.36	142.9	±3.0 %
		Y	10.01	68.5	21.3		135.2	
		Z	10.11	69.3	21.9		141.7	

10403-AAB	CDMA2000 (1xEV-DO, Rev. 0)	X	4.59	68.2	19.0	3.76	126.7	±0.7 %
		Y	4.59	67.2	18.0		142.4	
		Z	4.64	68.5	19.0		143.0	
10404-AAB	CDMA2000 (1xEV-DO, Rev. A)	X	4.64	68.8	19.3	3.77	147.1	±0.9 %
		Y	4.47	67.1	17.9		139.6	
		Z	4.54	68.4	18.9		147.2	
10415-AAA	IEEE 802.11b WiFi 2.4 GHz (DSSS, 1 Mbps, 99pc duty cycle)	X	2.66	69.0	19.4	1.54	145.8	±0.5 %
		Y	2.40	64.8	16.2		140.0	
		Z	2.62	67.8	18.4		147.2	
10416-AAA	IEEE 802.11g WiFi 2.4 GHz (ERP-OFDM, 6 Mbps, 99pc duty cycle)	X	9.97	69.1	21.7	8.23	142.0	±3.0 %
		Y	10.08	68.9	21.4		145.8	
		Z	10.01	69.2	21.8		143.3	

The reported uncertainty of measurement is stated as the standard uncertainty of measurement multiplied by the coverage factor $k=2$, which for a normal distribution corresponds to a coverage probability of approximately 95%.

[^] The uncertainties of NormX,Y,Z do not affect the E^2 -field uncertainty inside TSL (see Pages 8 and 9).

[^] Numerical linearization parameter: uncertainty not required.

[^] Uncertainty is determined using the max. deviation from linear response applying rectangular distribution and is expressed for the square of the field value.

DASY/EASY - Parameters of Probe: ES3DV2 - SN:3022

Calibration Parameter Determined in Head Tissue Simulating Media

f (MHz) ^c	Relative Permittivity ^F	Conductivity (S/m) ^F	ConvF X	ConvF Y	ConvF Z	Alpha ^G	Depth ^G (mm)	Unct. (k=2)
750	41.9	0.89	6.39	6.39	6.39	0.20	2.24	± 12.0 %
835	41.5	0.90	6.18	6.18	6.18	0.23	1.98	± 12.0 %
1750	40.1	1.37	5.04	5.04	5.04	0.51	1.35	± 12.0 %
1900	40.0	1.40	4.85	4.85	4.85	0.38	1.66	± 12.0 %
2450	39.2	1.80	4.31	4.31	4.31	0.66	1.28	± 12.0 %
2600	39.0	1.96	4.13	4.13	4.13	0.76	1.28	± 12.0 %

^c Frequency validity above 300 MHz of ± 100 MHz only applies for DASY v4.4 and higher (see Page 2), else it is restricted to ± 50 MHz. The uncertainty is the RSS of the ConvF uncertainty at calibration frequency and the uncertainty for the indicated frequency band. Frequency validity below 300 MHz is ± 10, 25, 40, 50 and 70 MHz for ConvF assessments at 30, 64, 128, 150 and 220 MHz respectively. Above 5 GHz frequency validity can be extended to ± 110 MHz.

^F At frequencies below 3 GHz, the validity of tissue parameters (ϵ and σ) can be relaxed to ± 10% if liquid compensation formula is applied to measured SAR values. At frequencies above 3 GHz, the validity of tissue parameters (ϵ and σ) is restricted to ± 5%. The uncertainty is the RSS of the ConvF uncertainty for indicated target tissue parameters.

^G Alpha/Depth are determined during calibration. SPEAG warrants that the remaining deviation due to the boundary effect after compensation is always less than ± 1% for frequencies below 3 GHz and below ± 2% for frequencies between 3-6 GHz at any distance larger than half the probe tip diameter from the boundary.

DASY/EASY - Parameters of Probe: ES3DV2 - SN:3022

Calibration Parameter Determined in Body Tissue Simulating Media

f (MHz) ^c	Relative Permittivity ^F	Conductivity (S/m) ^F	ConvF X	ConvF Y	ConvF Z	Alpha ^g	Depth ^g (mm)	Unct. (k=2)
450	56.7	0.94	6.78	6.78	6.78	0.12	1.30	± 13.3 %
600	56.1	0.95	6.72	6.72	6.72	0.05	1.20	± 13.3 %
750	55.5	0.96	6.02	6.02	6.02	0.23	2.05	± 12.0 %
835	55.2	0.97	5.98	5.98	5.98	0.29	1.85	± 12.0 %
1750	53.4	1.49	4.70	4.70	4.70	0.66	1.25	± 12.0 %
1900	53.3	1.52	4.49	4.49	4.49	0.33	2.02	± 12.0 %
2450	52.7	1.95	4.05	4.05	4.05	0.80	1.01	± 12.0 %
2600	52.5	2.16	3.94	3.94	3.94	0.68	1.03	± 12.0 %

^c Frequency validity above 300 MHz of ± 100 MHz only applies for DASY v4.4 and higher (see Page 2), else it is restricted to ± 50 MHz. The uncertainty is the RSS of the ConvF uncertainty at calibration frequency and the uncertainty for the indicated frequency band. Frequency validity below 300 MHz is ± 10, 25, 40, 50 and 70 MHz for ConvF assessments at 30, 64, 128, 150 and 220 MHz respectively. Above 5 GHz frequency validity can be extended to ± 110 MHz.

^F At frequencies below 3 GHz, the validity of tissue parameters (ϵ and σ) can be relaxed to ± 10% if liquid compensation formula is applied to measured SAR values. At frequencies above 3 GHz, the validity of tissue parameters (ϵ and σ) is restricted to ± 5%. The uncertainty is the RSS of the ConvF uncertainty for indicated target tissue parameters.

^g Alpha/Depth are determined during calibration. SPEAG warrants that the remaining deviation due to the boundary effect after compensation is always less than ± 1% for frequencies below 3 GHz and below ± 2% for frequencies between 3-6 GHz at any distance larger than half the probe tip diameter from the boundary.

Frequency Response of E-Field (TEM-Cell:ifi110 EXX, Waveguide: R22)

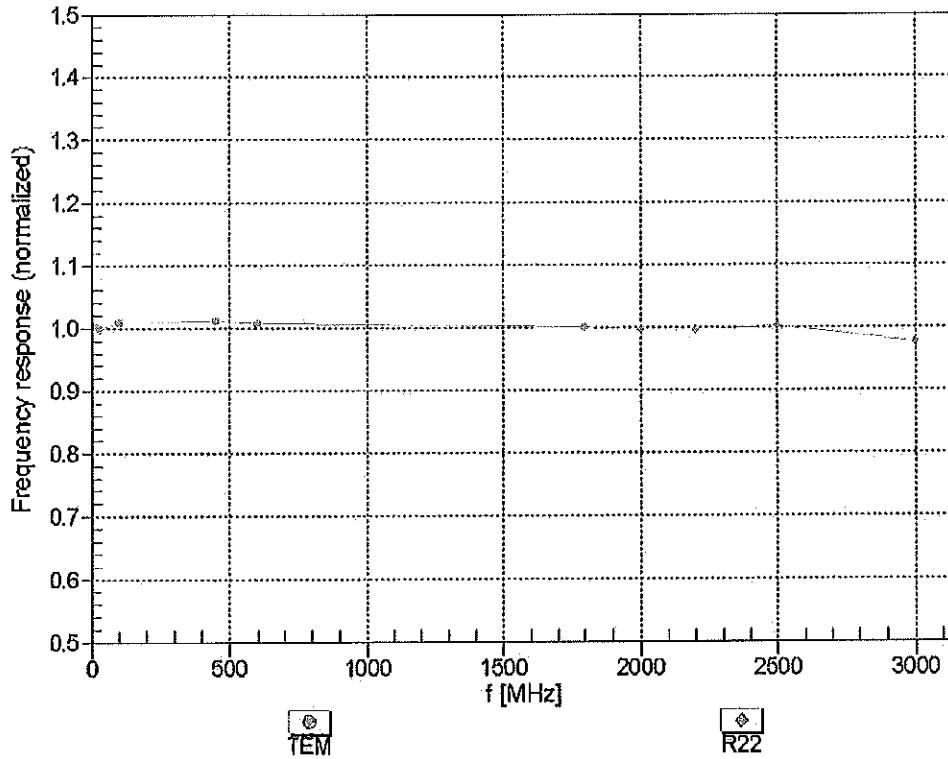

Uncertainty of Frequency Response of E-field: $\pm 6.3\%$ (k=2)

Receiving Pattern (ϕ), $\theta = 0^\circ$

f=600 MHz,TEM

f=1800 MHz,R22

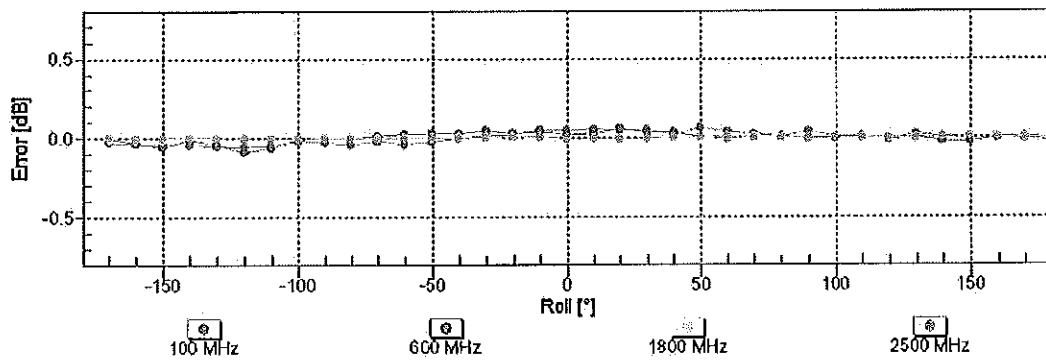
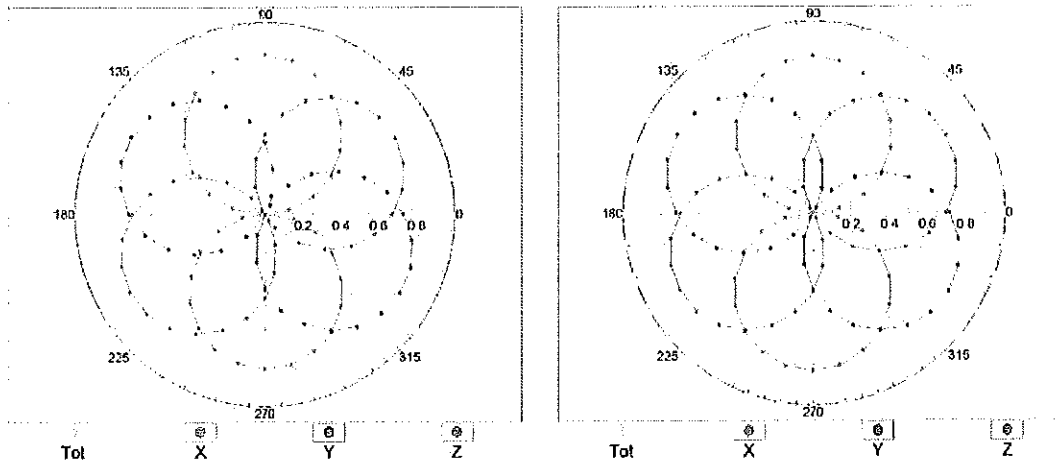

Uncertainty of Axial Isotropy Assessment: $\pm 0.5\%$ (k=2)

Dynamic Range $f(SAR_{head})$ (TEM cell, $f_{eval}=1900$ MHz)

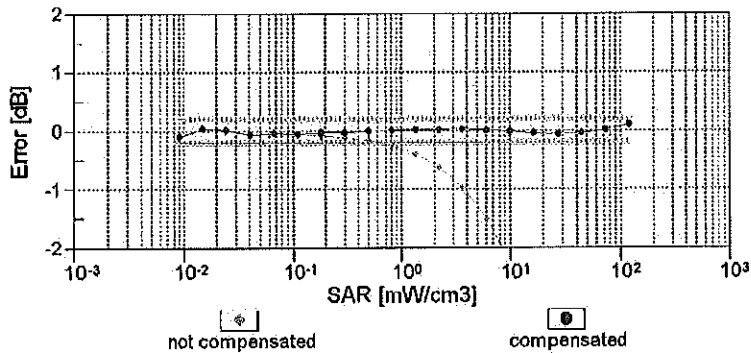
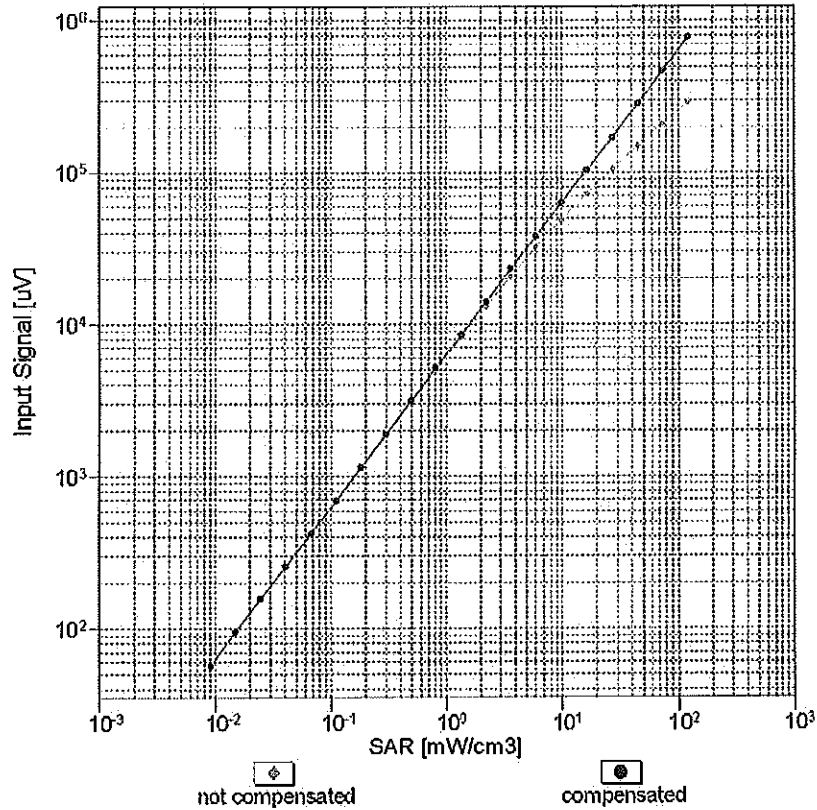

Uncertainty of Linearity Assessment: $\pm 0.6\%$ ($k=2$)

Conversion Factor Assessment

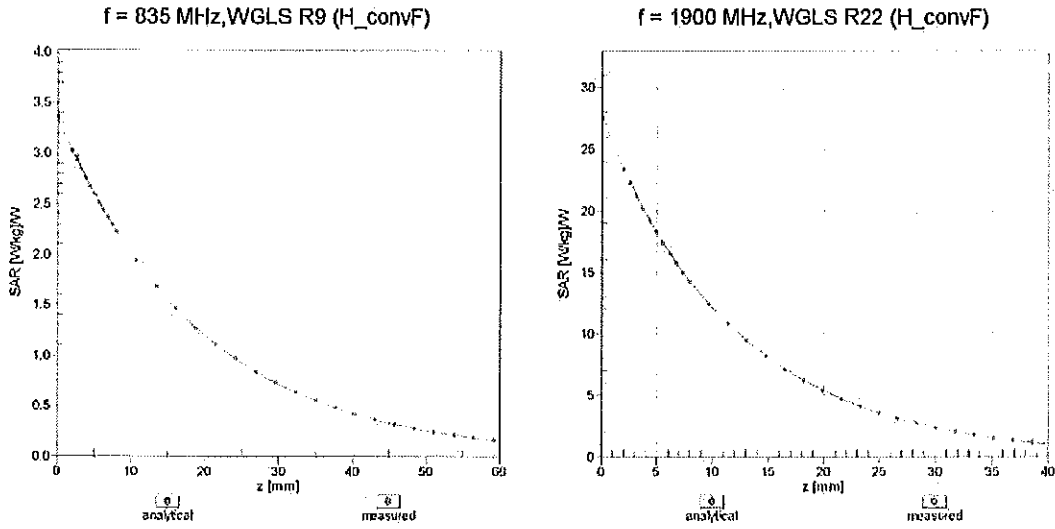

Deviation from Isotropy in Liquid Error (ϕ, θ), f = 900 MHz

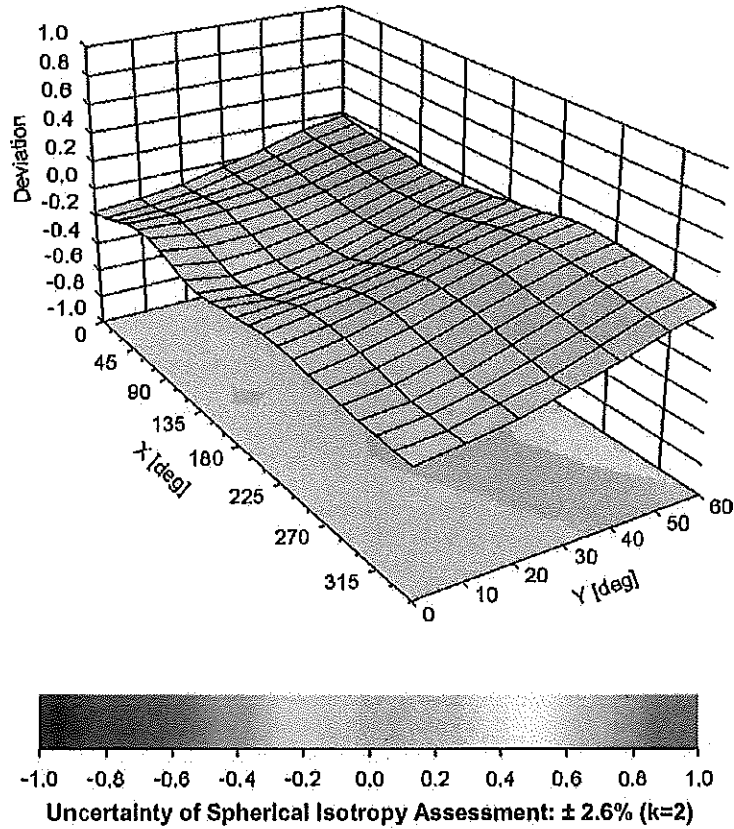

DASY/EASY - Parameters of Probe: ES3DV2 - SN:3022**Other Probe Parameters**

Sensor Arrangement	Triangular
Connector Angle (°)	-80,3
Mechanical Surface Detection Mode	enabled
Optical Surface Detection Mode	disabled
Probe Overall Length	337 mm
Probe Body Diameter	10 mm
Tip Length	10 mm
Tip Diameter	4 mm
Probe Tip to Sensor X Calibration Point	2 mm
Probe Tip to Sensor Y Calibration Point	2 mm
Probe Tip to Sensor Z Calibration Point	2 mm
Recommended Measurement Distance from Surface	3 mm

**Calibration Laboratory of
Schmid & Partner
Engineering AG**
Zeughausstrasse 43, 8004 Zurich, Switzerland



S Schweizerischer Kalibrierdienst
S Service suisse d'étalonnage
C Servizio svizzero di taratura
S Swiss Calibration Service

Accredited by the Swiss Accreditation Service (SAS)
The Swiss Accreditation Service is one of the signatories to the EA
Multilateral Agreement for the recognition of calibration certificates

Accreditation No.: **SCS 108**

Client **PC Test**

Certificate No: **ES3-3288_Sep14/2**

CALIBRATION CERTIFICATE (Replacement of No:ES3-3288_Sep14)

Object **ES3DV3 - SN:3288**

Calibration procedure(s) **QA CAL-01.v9, QA CAL-23.v5, QA CAL-25.v6
Calibration procedure for dosimetric E-field probes** CC
11/12/14

Calibration date: **September 24, 2014**

This calibration certificate documents the traceability to national standards, which realize the physical units of measurements (SI).
The measurements and the uncertainties with confidence probability are given on the following pages and are part of the certificate.

All calibrations have been conducted in the closed laboratory facility: environment temperature (22 ± 3)°C and humidity < 70%.

Calibration Equipment used (M&TE critical for calibration)

Primary Standards	ID	Cal Date (Certificate No.)	Scheduled Calibration
Power meter E4419B	GB41293874	03-Apr-14 (No. 217-01911)	Apr-15
Power sensor E4412A	MY41498087	03-Apr-14 (No. 217-01911)	Apr-15
Reference 3 dB Attenuator	SN: S5054 (3c)	03-Apr-14 (No. 217-01915)	Apr-15
Reference 20 dB Attenuator	SN: S5277 (20x)	03-Apr-14 (No. 217-01919)	Apr-15
Reference 30 dB Attenuator	SN: S5129 (30b)	03-Apr-14 (No. 217-01920)	Apr-15
Reference Probe ES3DV2	SN: 3013	30-Dec-13 (No. ES3-3013_Dec13)	Dec-14
DAE4	SN: 660	13-Dec-13 (No. DAE4-660_Dec13)	Dec-14
Secondary Standards	ID	Check Date (in house)	Scheduled Check
RF generator HP 8648C	US3642U01700	4-Aug-99 (in house check Apr-13)	In house check: Apr-16
Network Analyzer HP 8753E	US37390585	18-Oct-01 (in house check Oct-13)	In house check: Oct-14

	Name	Function	Signature
Calibrated by:	Leif Klysner	Laboratory Technician	
Approved by:	Katja Pokovic	Technical Manager	

Issued: November 3, 2014

This calibration certificate shall not be reproduced except in full without written approval of the laboratory.



Accredited by the Swiss Accreditation Service (SAS)
The Swiss Accreditation Service is one of the signatories to the EA
Multilateral Agreement for the recognition of calibration certificates

Accreditation No.: **SCS 108**

Glossary:

TSL	tissue simulating liquid
NORM _{x,y,z}	sensitivity in free space
ConvF	sensitivity in TSL / NORM _{x,y,z}
DCP	diode compression point
CF	crest factor (1/duty_cycle) of the RF signal
A, B, C, D	modulation dependent linearization parameters
Polarization ϕ	ϕ rotation around probe axis
Polarization ϑ	ϑ rotation around an axis that is in the plane normal to probe axis (at measurement center), i.e., $\vartheta = 0$ is normal to probe axis
Connector Angle	information used in DASY system to align probe sensor X to the robot coordinate system

Calibration is Performed According to the Following Standards:

- a) IEEE Std 1528-2013, "IEEE Recommended Practice for Determining the Peak Spatial-Averaged Specific Absorption Rate (SAR) in the Human Head from Wireless Communications Devices: Measurement Techniques", June 2013
- b) IEC 62209-1, "Procedure to measure the Specific Absorption Rate (SAR) for hand-held devices used in close proximity to the ear (frequency range of 300 MHz to 3 GHz)", February 2005

Methods Applied and Interpretation of Parameters:

- *NORM_{x,y,z}*: Assessed for E-field polarization $\vartheta = 0$ ($f \leq 900$ MHz in TEM-cell; $f > 1800$ MHz: R22 waveguide). *NORM_{x,y,z}* are only intermediate values, i.e., the uncertainties of *NORM_{x,y,z}* does not affect the E^2 -field uncertainty inside TSL (see below *ConvF*).
- *NORM(f)_{x,y,z}* = *NORM_{x,y,z}* * *frequency_response* (see Frequency Response Chart). This linearization is implemented in DASY4 software versions later than 4.2. The uncertainty of the frequency response is included in the stated uncertainty of *ConvF*.
- *DCP_{x,y,z}*: DCP are numerical linearization parameters assessed based on the data of power sweep with CW signal (no uncertainty required). DCP does not depend on frequency nor media.
- *PAR*: PAR is the Peak to Average Ratio that is not calibrated but determined based on the signal characteristics
- *A_{x,y,z}*; *B_{x,y,z}*; *C_{x,y,z}*; *D_{x,y,z}*; *VR_{x,y,z}*: *A, B, C, D* are numerical linearization parameters assessed based on the data of power sweep for specific modulation signal. The parameters do not depend on frequency nor media. *VR* is the maximum calibration range expressed in RMS voltage across the diode.
- *ConvF and Boundary Effect Parameters*: Assessed in flat phantom using E-field (or Temperature Transfer Standard for $f \leq 800$ MHz) and inside waveguide using analytical field distributions based on power measurements for $f > 800$ MHz. The same setups are used for assessment of the parameters applied for boundary compensation (alpha, depth) of which typical uncertainty values are given. These parameters are used in DASY4 software to improve probe accuracy close to the boundary. The sensitivity in TSL corresponds to *NORM_{x,y,z}* * *ConvF* whereby the uncertainty corresponds to that given for *ConvF*. A frequency dependent *ConvF* is used in DASY version 4.4 and higher which allows extending the validity from ± 50 MHz to ± 100 MHz.
- *Spherical isotropy (3D deviation from isotropy)*: in a field of low gradients realized using a flat phantom exposed by a patch antenna.
- *Sensor Offset*: The sensor offset corresponds to the offset of virtual measurement center from the probe tip (on probe axis). No tolerance required.
- *Connector Angle*: The angle is assessed using the information gained by determining the *NORM_x* (no uncertainty required).

Probe ES3DV3

SN:3288

Manufactured:	July 6, 2010
Repaired:	September 18, 2014
Calibrated:	September 24, 2014

Calibrated for DASY/EASY Systems

(Note: non-compatible with DASY2 system!)

DASY/EASY - Parameters of Probe: ES3DV3 - SN:3288

Basic Calibration Parameters

	Sensor X	Sensor Y	Sensor Z	Unc (k=2)
Norm ($\mu\text{V}/(\text{V}/\text{m})^2$) ^A	1.05	1.16	0.92	$\pm 10.1 \%$
DCP (mV) ^B	105.1	104.6	106.7	

Modulation Calibration Parameters

UID	Communication System Name		A dB	B dB $\sqrt{\mu\text{V}}$	C	D dB	VR mV	Unc ^E (k=2)
0	CW	X	0.0	0.0	1.0	0.00	195.8	$\pm 3.5 \%$
		Y	0.0	0.0	1.0		175.9	
		Z	0.0	0.0	1.0		177.1	
10010-CAA	SAR Validation (Square, 100ms, 10ms)	X	2.71	61.9	11.4	10.00	40.3	$\pm 2.2 \%$
		Y	2.37	60.2	11.2		42.6	
		Z	1.54	56.6	8.9		41.2	
10011-CAB	UMTS-FDD (WCDMA)	X	3.29	67.1	18.4	2.91	133.8	$\pm 0.5 \%$
		Y	3.43	67.9	18.9		139.5	
		Z	3.45	68.1	18.9		141.3	
10012-CAA	IEEE 802.11b WiFi 2.4 GHz (DSSS, 1 Mbps)	X	2.99	68.9	18.6	1.87	135.1	$\pm 0.7 \%$
		Y	3.59	72.4	20.4		140.7	
		Z	3.54	72.4	20.3		143.0	
10013-CAA	IEEE 802.11g WiFi 2.4 GHz (DSSS-OFDM, 6 Mbps)	X	11.15	70.8	23.3	9.46	132.3	$\pm 3.5 \%$
		Y	11.29	70.8	23.2		141.1	
		Z	11.07	70.7	23.2		139.2	
10021-DAB	GSM-FDD (TDMA, GMSK)	X	14.71	90.5	24.5	9.39	149.0	$\pm 1.9 \%$
		Y	16.40	92.8	26.0		131.3	
		Z	11.34	87.2	23.6		126.1	
10023-DAB	GPRS-FDD (TDMA, GMSK, TN 0)	X	15.91	92.2	25.3	9.57	138.9	$\pm 2.5 \%$
		Y	21.25	96.9	27.2		142.0	
		Z	11.68	87.2	23.5		145.9	
10024-DAB	GPRS-FDD (TDMA, GMSK, TN 0-1)	X	38.62	99.8	24.7	6.56	123.8	$\pm 2.2 \%$
		Y	36.71	99.7	25.2		128.1	
		Z	36.56	99.4	24.5		129.5	
10027-DAB	GPRS-FDD (TDMA, GMSK, TN 0-1-2)	X	56.60	99.6	22.6	4.80	138.8	$\pm 1.9 \%$
		Y	46.94	99.9	23.7		149.9	
		Z	51.17	99.8	22.9		144.9	
10028-DAB	GPRS-FDD (TDMA, GMSK, TN 0-1-2-3)	X	70.88	100.0	21.6	3.55	147.5	$\pm 1.9 \%$
		Y	52.58	99.8	22.6		129.4	
		Z	76.98	99.8	21.2		128.7	
10032-CAA	IEEE 802.15.1 Bluetooth (GFSK, DH5)	X	98.89	99.5	18.9	1.16	135.8	$\pm 1.4 \%$
		Y	78.39	99.6	19.5		141.7	
		Z	95.21	95.5	17.1		143.4	
10039-CAB	CDMA2000 (1xRTT, RC1)	X	4.72	66.7	18.9	4.57	133.7	$\pm 0.9 \%$
		Y	4.85	67.1	19.1		137.7	
		Z	4.81	67.4	19.2		141.9	

10081-CAB	CDMA2000 (1xRTT, RC3)	X	3.91	66.3	18.6	3.97	129.5	±0.7 %
		Y	4.00	66.6	18.7		133.7	
		Z	3.99	66.8	18.8		137.5	
10098-CAB	UMTS-FDD (HSUPA, Subtest 2)	X	4.63	66.9	18.7	3.98	141.4	±0.7 %
		Y	4.78	67.5	19.0		147.7	
		Z	4.57	66.8	18.6		127.8	
10100-CAB	LTE-FDD (SC-FDMA, 100% RB, 20 MHz, QPSK)	X	6.59	68.2	20.1	5.67	149.2	±1.4 %
		Y	6.36	67.3	19.6		130.7	
		Z	6.36	67.5	19.6		133.6	
10108-CAB	LTE-FDD (SC-FDMA, 100% RB, 10 MHz, QPSK)	X	6.44	67.8	20.0	5.80	146.6	±1.4 %
		Y	6.23	66.8	19.4		128.8	
		Z	6.24	67.1	19.6		131.4	
10110-CAB	LTE-FDD (SC-FDMA, 100% RB, 5 MHz, QPSK)	X	6.08	67.1	19.6	5.75	143.2	±1.4 %
		Y	6.20	67.4	19.8		148.0	
		Z	5.92	66.6	19.3		128.5	
10114-CAA	IEEE 802.11n (HT Greenfield, 13.5 Mbps, BPSK)	X	10.32	69.3	21.5	8.10	137.0	±2.2 %
		Y	10.31	69.1	21.4		143.5	
		Z	10.37	69.5	21.6		146.1	
10117-CAA	IEEE 802.11n (HT Mixed, 13.5 Mbps, BPSK)	X	10.35	69.4	21.6	8.07	138.3	±2.2 %
		Y	10.36	69.3	21.4		146.4	
		Z	10.42	69.6	21.6		149.0	
10151-CAB	LTE-TDD (SC-FDMA, 50% RB, 20 MHz, QPSK)	X	9.95	75.7	26.2	9.28	134.9	±3.3 %
		Y	10.37	76.0	26.1		146.6	
		Z	9.77	75.4	26.0		142.5	
10154-CAB	LTE-FDD (SC-FDMA, 50% RB, 10 MHz, QPSK)	X	6.12	67.2	19.7	5.75	144.9	±1.4 %
		Y	6.21	67.4	19.8		148.8	
		Z	5.91	66.5	19.3		128.7	
10160-CAB	LTE-FDD (SC-FDMA, 50% RB, 15 MHz, QPSK)	X	6.28	66.7	19.4	5.82	125.5	±1.2 %
		Y	6.37	66.8	19.4		129.7	
		Z	6.36	67.1	19.6		132.9	
10169-CAB	LTE-FDD (SC-FDMA, 1 RB, 20 MHz, QPSK)	X	5.08	67.6	20.2	5.73	147.0	±1.2 %
		Y	4.95	66.6	19.6		128.6	
		Z	4.91	66.9	19.8		131.2	
10172-CAB	LTE-TDD (SC-FDMA, 1 RB, 20 MHz, QPSK)	X	8.18	77.2	27.2	9.21	123.4	±2.7 %
		Y	8.37	76.6	26.6		129.5	
		Z	7.97	76.7	26.9		128.7	
10175-CAB	LTE-FDD (SC-FDMA, 1 RB, 10 MHz, QPSK)	X	5.05	67.4	20.1	5.72	146.2	±1.4 %
		Y	5.10	67.3	20.0		142.8	
		Z	4.87	66.7	19.6		129.6	
10181-CAB	LTE-FDD (SC-FDMA, 1 RB, 15 MHz, QPSK)	X	5.04	67.4	20.0	5.72	145.5	±1.2 %
		Y	5.12	67.4	20.0		143.4	
		Z	4.87	66.7	19.6		129.9	
10193-CAA	IEEE 802.11n (HT Greenfield, 6.5 Mbps, BPSK)	X	9.92	68.9	21.4	8.09	131.0	±2.2 %
		Y	9.84	68.5	21.1		130.0	
		Z	9.94	69.0	21.4		138.6	

10196-CAA	IEEE 802.11n (HT Mixed, 6.5 Mbps, BPSK)	X	9.90	68.9	21.4	8.10	130.8	±2.2 %
		Y	9.81	68.4	21.0		131.4	
		Z	9.95	69.1	21.5		140.5	
10219-CAA	IEEE 802.11n (HT Mixed, 7.2 Mbps, BPSK)	X	9.81	68.8	21.3	8.03	130.0	±2.2 %
		Y	9.89	68.9	21.3		138.1	
		Z	9.89	69.1	21.5		140.5	
10222-CAA	IEEE 802.11n (HT Mixed, 15 Mbps, BPSK)	X	10.25	69.2	21.4	8.06	137.1	±2.2 %
		Y	10.30	69.2	21.4		144.4	
		Z	10.38	69.6	21.6		148.4	
10225-CAB	UMTS-FDD (HSPA+)	X	6.90	66.8	19.3	5.97	132.8	±1.4 %
		Y	7.09	67.3	19.6		142.0	
		Z	7.04	67.4	19.6		143.5	
10237-CAB	LTE-TDD (SC-FDMA, 1 RB, 10 MHz, QPSK)	X	9.61	81.9	29.6	9.21	149.3	±2.7 %
		Y	8.66	77.6	27.1		133.7	
		Z	8.20	77.5	27.3		132.2	
10252-CAB	LTE-TDD (SC-FDMA, 50% RB, 10 MHz, QPSK)	X	9.16	74.5	25.8	9.24	126.3	±3.0 %
		Y	9.62	75.0	25.8		137.4	
		Z	9.16	74.8	25.9		135.2	
10267-CAB	LTE-TDD (SC-FDMA, 100% RB, 10 MHz, QPSK)	X	9.97	75.7	26.3	9.30	133.7	±3.3 %
		Y	10.38	75.9	26.1		146.1	
		Z	9.91	75.7	26.3		143.8	
10274-CAB	UMTS-FDD (HSUPA, Subtest 5, 3GPP Rel8.10)	X	5.86	66.6	18.7	4.87	129.9	±0.9 %
		Y	6.01	67.1	19.0		135.7	
		Z	5.95	67.1	19.0		139.4	
10275-CAB	UMTS-FDD (HSUPA, Subtest 5, 3GPP Rel8.4)	X	4.40	66.7	18.6	3.96	136.4	±0.7 %
		Y	4.55	67.3	19.0		138.3	
		Z	4.56	67.6	19.1		144.3	
10291-AAB	CDMA2000, RC3, SO55, Full Rate	X	3.64	66.9	18.7	3.46	127.4	±0.5 %
		Y	3.77	67.6	19.1		130.2	
		Z	3.72	67.5	19.0		134.4	
10292-AAB	CDMA2000, RC3, SO32, Full Rate	X	3.58	67.0	18.7	3.39	128.4	±0.5 %
		Y	3.73	67.7	19.1		132.7	
		Z	3.69	67.8	19.1		136.1	
10297-AAA	LTE-FDD (SC-FDMA, 50% RB, 20 MHz, QPSK)	X	6.43	67.7	19.9	5.81	145.5	±1.4 %
		Y	6.49	67.7	19.9		149.5	
		Z	6.23	67.0	19.6		129.5	
10311-AAA	LTE-FDD (SC-FDMA, 100% RB, 15 MHz, QPSK)	X	6.74	67.3	19.8	6.06	126.7	±1.4 %
		Y	6.83	67.5	19.8		132.9	
		Z	6.81	67.6	19.9		135.8	
10315-AAA	IEEE 802.11b WiFi 2.4 GHz (DSSS, 1 Mbps, 96pc duty cycle)	X	3.00	69.9	19.4	1.71	133.9	±0.5 %
		Y	3.30	71.5	20.1		141.0	
		Z	3.22	71.4	20.0		142.9	
10316-AAA	IEEE 802.11g WiFi 2.4 GHz (ERP-OFDM, 6 Mbps, 96pc duty cycle)	X	10.17	69.2	21.8	8.36	130.5	±2.5 %
		Y	10.20	69.1	21.6		138.4	
		Z	10.20	69.4	21.8		140.7	

10403-AAB	CDMA2000 (1xEV-DO, Rev. 0)	X	4.75	68.3	18.8	3.76	138.5	±0.7 %
		Y	5.00	69.1	19.2		146.7	
		Z	4.92	69.2	19.1		148.5	
10404-AAB	CDMA2000 (1xEV-DO, Rev. A)	X	4.73	68.6	18.9	3.77	136.3	±0.7 %
		Y	4.97	69.4	19.4		143.7	
		Z	4.91	69.6	19.3		146.0	
10415-AAA	IEEE 802.11b WiFi 2.4 GHz (DSSS, 1 Mbps, 99pc duty cycle)	X	2.65	68.1	18.5	1.54	135.2	±0.5 %
		Y	3.05	70.8	19.9		140.7	
		Z	2.87	69.8	19.3		144.8	
10416-AAA	IEEE 802.11g WiFi 2.4 GHz (ERP-OFDM, 6 Mbps, 99pc duty cycle)	X	10.00	69.0	21.5	8.23	130.8	±2.2 %
		Y	10.06	68.9	21.4		138.6	
		Z	10.08	69.3	21.7		141.6	

The reported uncertainty of measurement is stated as the standard uncertainty of measurement multiplied by the coverage factor $k=2$, which for a normal distribution corresponds to a coverage probability of approximately 95%.

^A The uncertainties of NormX,Y,Z do not affect the E²-field uncertainty inside TSL (see Pages 8 and 9).

^B Numerical linearization parameter: uncertainty not required.

^E Uncertainty is determined using the max. deviation from linear response applying rectangular distribution and is expressed for the square of the field value.

DASY/EASY - Parameters of Probe: ES3DV3 - SN:3288

Calibration Parameter Determined in Head Tissue Simulating Media

f (MHz) ^C	Relative Permittivity ^F	Conductivity (S/m) ^F	ConvF X	ConvF Y	ConvF Z	Alpha ^G	Depth ^G (mm)	Unct. (k=2)
750	41.9	0.89	6.81	6.81	6.81	0.37	1.70	± 12.0 %
835	41.5	0.90	6.51	6.51	6.51	0.45	1.52	± 12.0 %
1750	40.1	1.37	5.38	5.38	5.38	0.44	1.58	± 12.0 %
1900	40.0	1.40	5.17	5.17	5.17	0.80	1.18	± 12.0 %
2450	39.2	1.80	4.56	4.56	4.56	0.80	1.21	± 12.0 %
2600	39.0	1.96	4.44	4.44	4.44	0.80	1.22	± 12.0 %

^C Frequency validity above 300 MHz of ± 100 MHz only applies for DASY v4.4 and higher (see Page 2), else it is restricted to ± 50 MHz. The uncertainty is the RSS of the ConvF uncertainty at calibration frequency and the uncertainty for the indicated frequency band. Frequency validity below 300 MHz is ± 10, 25, 40, 50 and 70 MHz for ConvF assessments at 30, 64, 128, 150 and 220 MHz respectively. Above 5 GHz frequency validity can be extended to ± 110 MHz.

^F At frequencies below 3 GHz, the validity of tissue parameters (ϵ and σ) can be relaxed to ± 10% if liquid compensation formula is applied to measured SAR values. At frequencies above 3 GHz, the validity of tissue parameters (ϵ and σ) is restricted to ± 5%. The uncertainty is the RSS of the ConvF uncertainty for indicated target tissue parameters.

^G Alpha/Depth are determined during calibration. SPEAG warrants that the remaining deviation due to the boundary effect after compensation is always less than ± 1% for frequencies below 3 GHz and below ± 2% for frequencies between 3-6 GHz at any distance larger than half the probe tip diameter from the boundary.

DASY/EASY - Parameters of Probe: ES3DV3 - SN:3288

Calibration Parameter Determined in Body Tissue Simulating Media

f (MHz) ^C	Relative Permittivity ^F	Conductivity (S/m) ^F	ConvF X	ConvF Y	ConvF Z	Alpha ^G	Depth ^G (mm)	Unct. (k=2)
750	55.5	0.96	6.38	6.38	6.38	0.31	1.89	± 12.0 %
835	55.2	0.97	6.32	6.32	6.32	0.55	1.39	± 12.0 %
1750	53.4	1.49	5.03	5.03	5.03	0.57	1.44	± 12.0 %
1900	53.3	1.52	4.82	4.82	4.82	0.51	1.54	± 12.0 %
2450	52.7	1.95	4.36	4.36	4.36	0.71	1.07	± 12.0 %
2600	52.5	2.16	4.22	4.22	4.22	0.80	1.07	± 12.0 %

^C Frequency validity above 300 MHz of ± 100 MHz only applies for DASY v4.4 and higher (see Page 2), else it is restricted to ± 50 MHz. The uncertainty is the RSS of the ConvF uncertainty at calibration frequency and the uncertainty for the indicated frequency band. Frequency validity below 300 MHz is ± 10, 25, 40, 50 and 70 MHz for ConvF assessments at 30, 64, 128, 150 and 220 MHz respectively. Above 5 GHz frequency validity can be extended to ± 110 MHz.

^F At frequencies below 3 GHz, the validity of tissue parameters (ϵ and σ) can be relaxed to ± 10% if liquid compensation formula is applied to measured SAR values. At frequencies above 3 GHz, the validity of tissue parameters (ϵ and σ) is restricted to ± 5%. The uncertainty is the RSS of the ConvF uncertainty for indicated target tissue parameters.

^G Alpha/Depth are determined during calibration. SPEAG warrants that the remaining deviation due to the boundary effect after compensation is always less than ± 1% for frequencies below 3 GHz and below ± 2% for frequencies between 3-6 GHz at any distance larger than half the probe tip diameter from the boundary.

Frequency Response of E-Field

(TEM-Cell:ifi1110 EXX, Waveguide: R22)

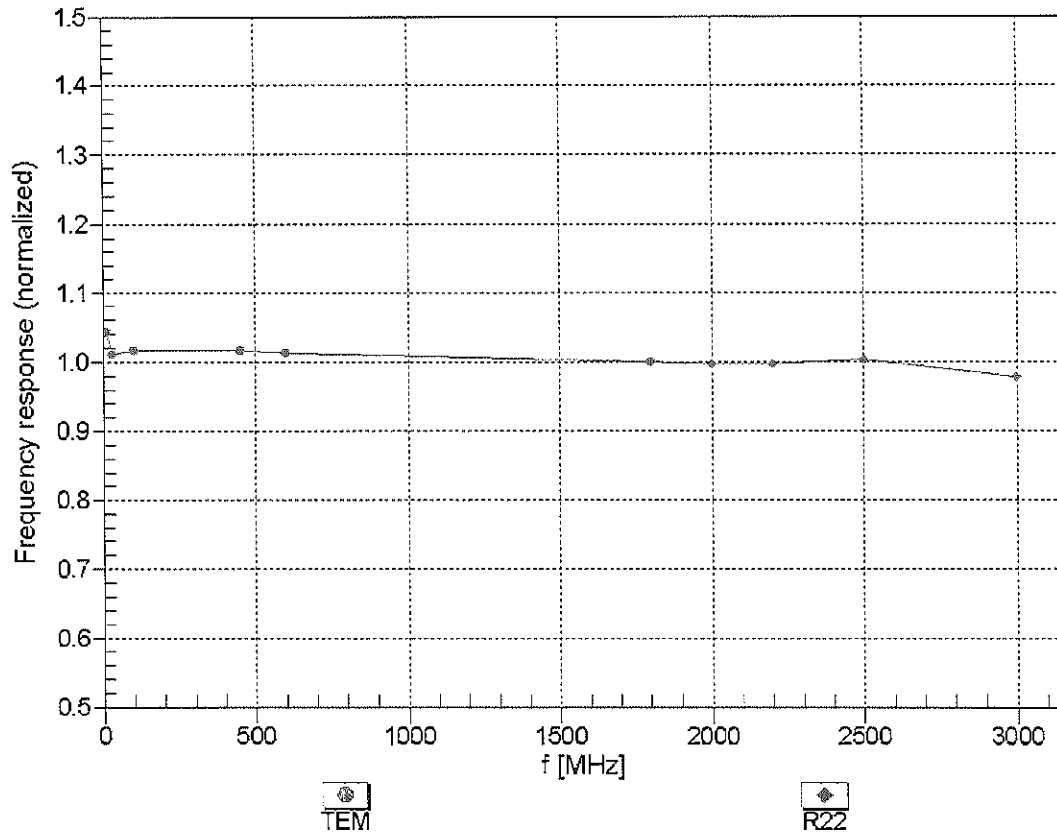

Uncertainty of Frequency Response of E-field: $\pm 6.3\%$ (k=2)

Receiving Pattern (ϕ), $\vartheta = 0^\circ$

f=600 MHz, TEM

f=1800 MHz, R22

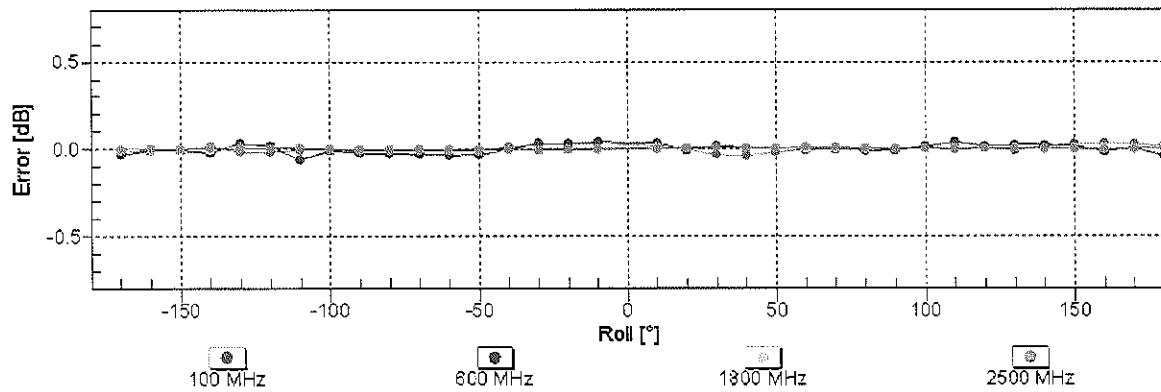
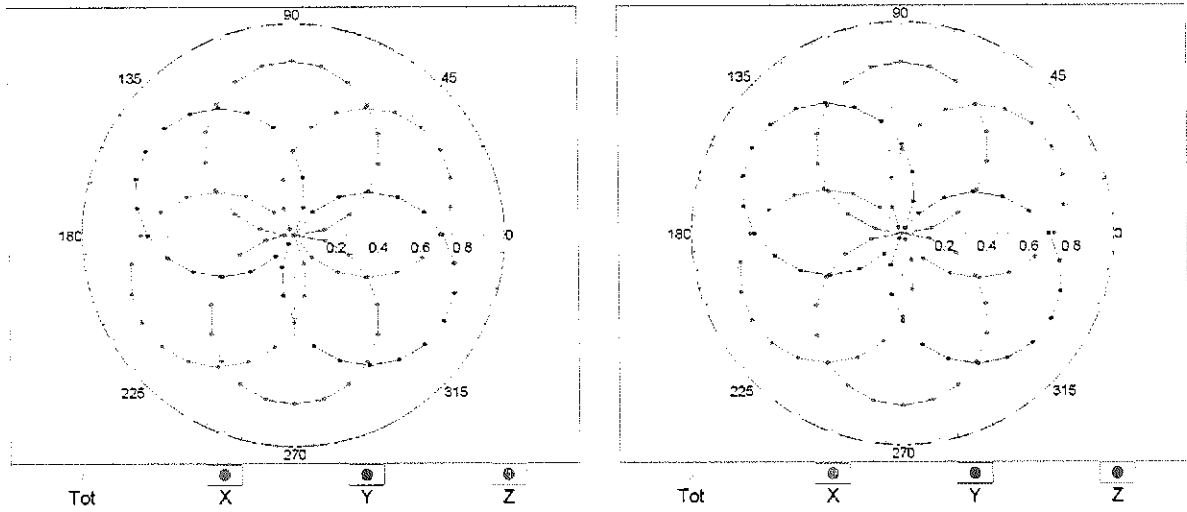

Uncertainty of Axial Isotropy Assessment: $\pm 0.5\%$ (k=2)

Dynamic Range $f(\text{SAR}_{\text{head}})$ (TEM cell , $f_{\text{eval}}= 1900 \text{ MHz}$)

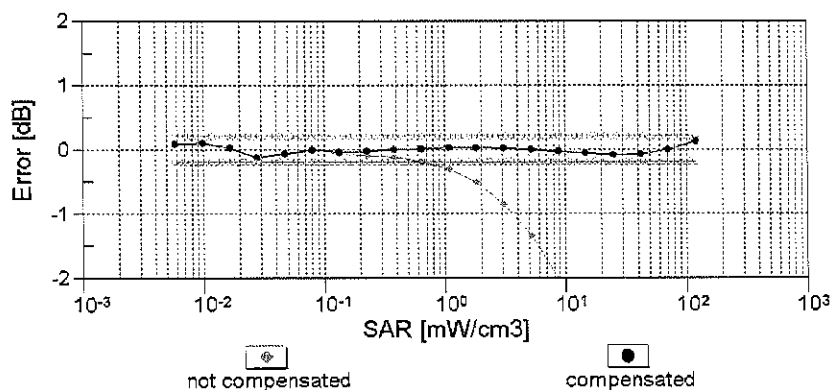
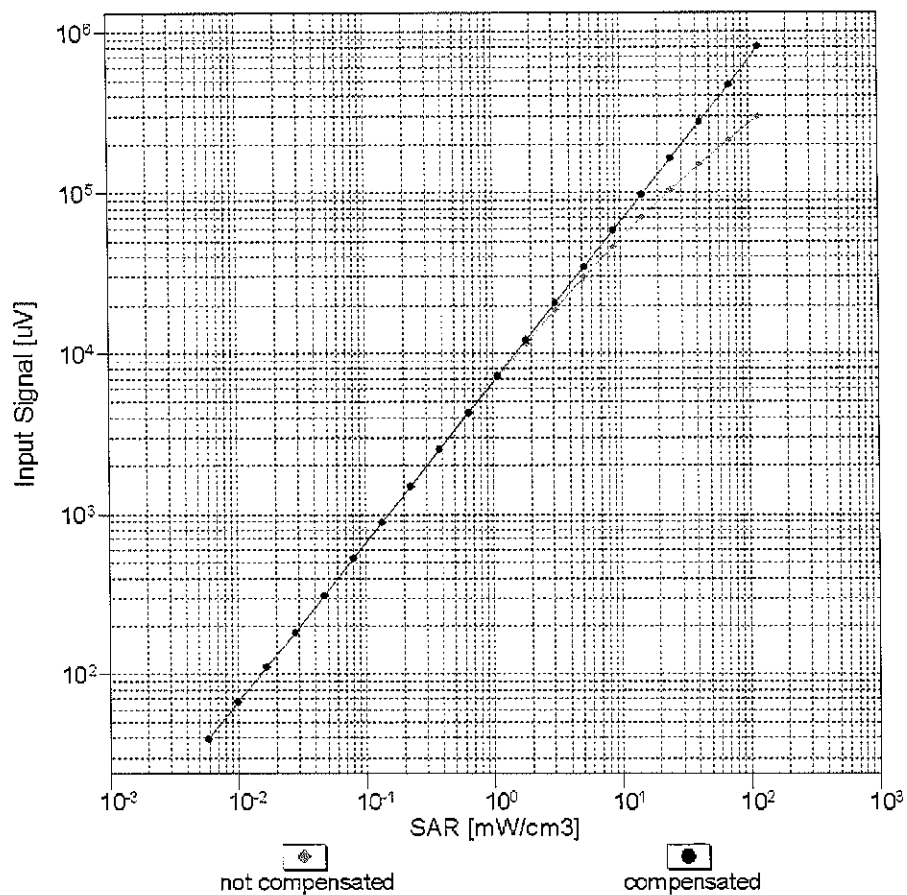

Uncertainty of Linearity Assessment: $\pm 0.6\%$ ($k=2$)

Conversion Factor Assessment

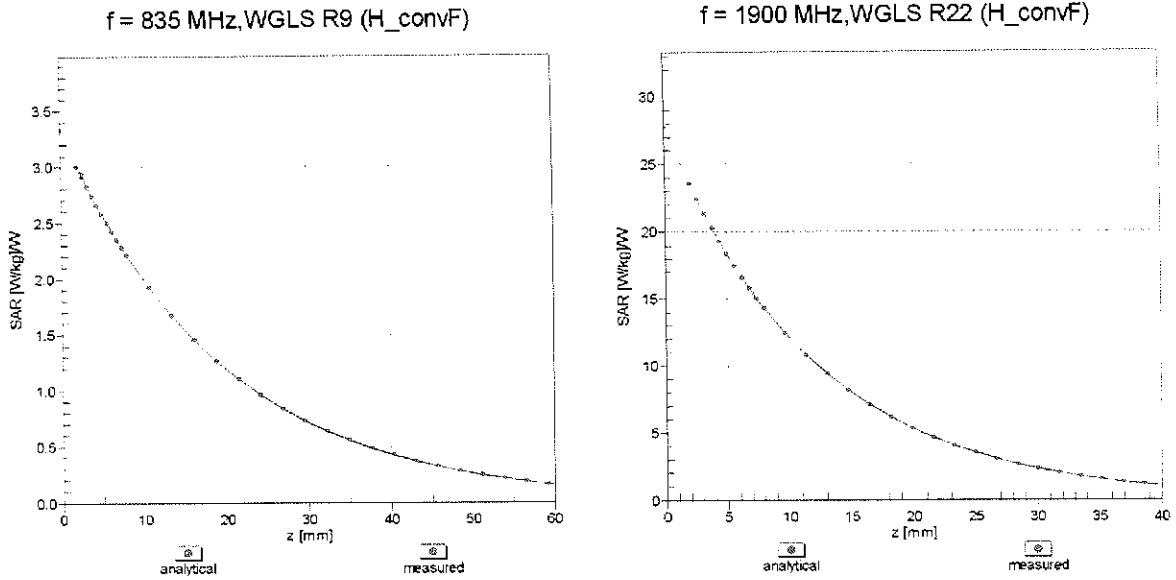

Deviation from Isotropy in Liquid

Error (ϕ, θ), f = 900 MHz

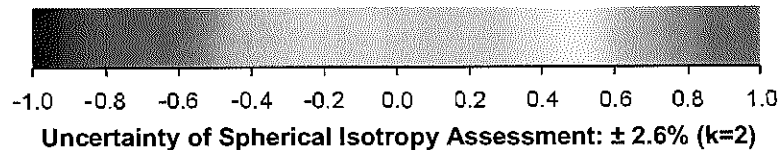
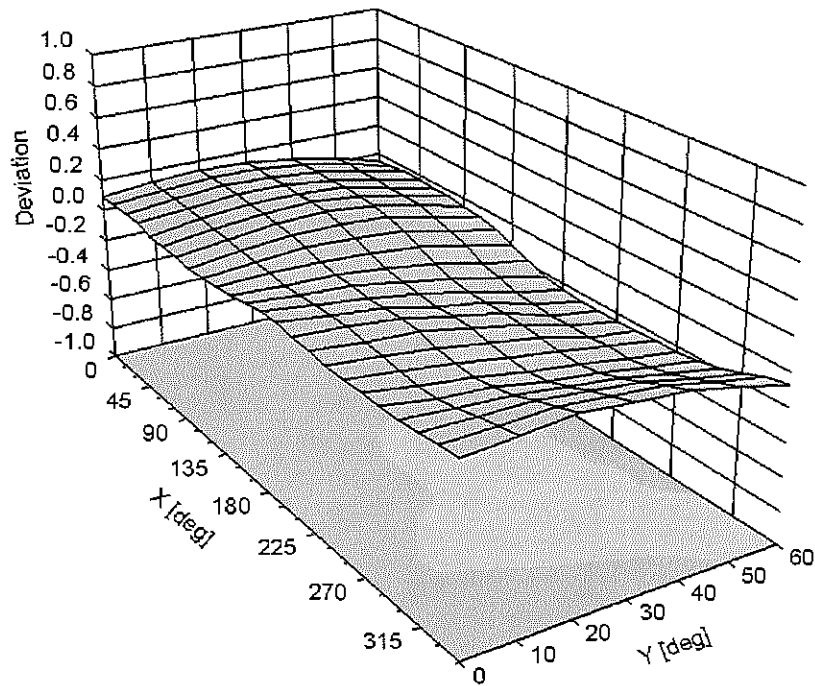

DASY/EASY - Parameters of Probe: ES3DV3 - SN:3288

Other Probe Parameters

Sensor Arrangement	Triangular
Connector Angle (°)	-110
Mechanical Surface Detection Mode	enabled
Optical Surface Detection Mode	disabled
Probe Overall Length	337 mm
Probe Body Diameter	10 mm
Tip Length	10 mm
Tip Diameter	4 mm
Probe Tip to Sensor X Calibration Point	2 mm
Probe Tip to Sensor Y Calibration Point	2 mm
Probe Tip to Sensor Z Calibration Point	2 mm
Recommended Measurement Distance from Surface	3 mm

**Calibration Laboratory of
Schmid & Partner
Engineering AG**
Zeughausstrasse 43, 8004 Zurich, Switzerland



S Schweizerischer Kalibrierdienst
S Service suisse d'étalonnage
C Servizio svizzero di taratura
S Swiss Calibration Service

Accredited by the Swiss Accreditation Service (SAS)
The Swiss Accreditation Service is one of the signatories to the EA
Multilateral Agreement for the recognition of calibration certificates

Accreditation No.: **SCS 108**

Client **PC Test**

Certificate No: **ES3-3334_Dec14**

CALIBRATION CERTIFICATE

Object **ES3DV3 - SN:3334**

Calibration procedure(s) **QA CAL-01.v9, QA CAL-23.v5, QA CAL-25.v6**
Calibration procedure for dosimetric E-field probes

CC
12/31/14

Calibration date: **December 16, 2014**

This calibration certificate documents the traceability to national standards, which realize the physical units of measurements (SI).
The measurements and the uncertainties with confidence probability are given on the following pages and are part of the certificate.

All calibrations have been conducted in the closed laboratory facility: environment temperature (22 ± 3)°C and humidity < 70%.

Calibration Equipment used (M&TE critical for calibration)

Primary Standards	ID	Cal Date (Certificate No.)	Scheduled Calibration
Power meter E4419B	GB41293874	03-Apr-14 (No. 217-01911)	Apr-15
Power sensor E4412A	MY41498087	03-Apr-14 (No. 217-01911)	Apr-15
Reference 3 dB Attenuator	SN: S5054 (3c)	03-Apr-14 (No. 217-01915)	Apr-15
Reference 20 dB Attenuator	SN: S5277 (20x)	03-Apr-14 (No. 217-01919)	Apr-15
Reference 30 dB Attenuator	SN: S5129 (30b)	03-Apr-14 (No. 217-01920)	Apr-15
Reference Probe ES3DV2	SN: 3013	30-Dec-13 (No. ES3-3013_Dec13)	Dec-14
DAE4	SN: 789	30-Apr-14 (No. DAE4-789_Apr14)	Apr-15
Secondary Standards	ID	Check Date (in house)	Scheduled Check
RF generator HP 8648C	US3642U01700	4-Aug-99 (in house check Apr-13)	In house check: Apr-16
Network Analyzer HP 8753E	US37390585	18-Oct-01 (in house check Oct-14)	In house check: Oct-15

	Name	Function	Signature
Calibrated by:	Leif Klysner	Laboratory Technician	
Approved by:	Katja Pokovic	Technical Manager	
			Issued: December 16, 2014

This calibration certificate shall not be reproduced except in full without written approval of the laboratory.



Accredited by the Swiss Accreditation Service (SAS)
The Swiss Accreditation Service is one of the signatories to the EA
Multilateral Agreement for the recognition of calibration certificates

Accreditation No.: **SCS 108**

Glossary:

TSL	tissue simulating liquid
NORM _{x,y,z}	sensitivity in free space
ConvF	sensitivity in TSL / NORM _{x,y,z}
DCP	diode compression point
CF	crest factor (1/duty_cycle) of the RF signal
A, B, C, D	modulation dependent linearization parameters
Polarization ϕ	ϕ rotation around probe axis
Polarization ϑ	ϑ rotation around an axis that is in the plane normal to probe axis (at measurement center), i.e., $\vartheta = 0$ is normal to probe axis
Connector Angle	Information used in DASY system to align probe sensor X to the robot coordinate system

Calibration is Performed According to the Following Standards:

- a) IEEE Std 1528-2013, "IEEE Recommended Practice for Determining the Peak Spatial-Averaged Specific Absorption Rate (SAR) in the Human Head from Wireless Communications Devices: Measurement Techniques", June 2013
- b) IEC 62209-1, "Procedure to measure the Specific Absorption Rate (SAR) for hand-held devices used in close proximity to the ear (frequency range of 300 MHz to 3 GHz)", February 2005

Methods Applied and Interpretation of Parameters:

- **NORM_{x,y,z}:** Assessed for E-field polarization $\vartheta = 0$ ($f \leq 900$ MHz in TEM-cell; $f > 1800$ MHz: R22 waveguide). NORM_{x,y,z} are only intermediate values, i.e., the uncertainties of NORM_{x,y,z} does not affect the E²-field uncertainty inside TSL (see below ConvF).
- **NORM(f)_{x,y,z} = NORM_{x,y,z} * frequency_response** (see Frequency Response Chart). This linearization is implemented in DASY4 software versions later than 4.2. The uncertainty of the frequency response is included in the stated uncertainty of ConvF.
- **DCP_{x,y,z}:** DCP are numerical linearization parameters assessed based on the data of power sweep with CW signal (no uncertainty required). DCP does not depend on frequency nor media.
- **PAR:** PAR is the Peak to Average Ratio that is not calibrated but determined based on the signal characteristics
- **A_{x,y,z}; B_{x,y,z}; C_{x,y,z}; D_{x,y,z}; VR_{x,y,z}:** A, B, C, D are numerical linearization parameters assessed based on the data of power sweep for specific modulation signal. The parameters do not depend on frequency nor media. VR is the maximum calibration range expressed in RMS voltage across the diode.
- **ConvF and Boundary Effect Parameters:** Assessed in flat phantom using E-field (or Temperature Transfer Standard for $f \leq 800$ MHz) and inside waveguide using analytical field distributions based on power measurements for $f > 800$ MHz. The same setups are used for assessment of the parameters applied for boundary compensation (alpha, depth) of which typical uncertainty values are given. These parameters are used in DASY4 software to improve probe accuracy close to the boundary. The sensitivity in TSL corresponds to NORM_{x,y,z} * ConvF whereby the uncertainty corresponds to that given for ConvF. A frequency dependent ConvF is used in DASY version 4.4 and higher which allows extending the validity from ± 50 MHz to ± 100 MHz.
- **Spherical Isotropy (3D deviation from isotropy):** in a field of low gradients realized using a flat phantom exposed by a patch antenna.
- **Sensor Offset:** The sensor offset corresponds to the offset of virtual measurement center from the probe tip (on probe axis). No tolerance required.
- **Connector Angle:** The angle is assessed using the information gained by determining the NORM_x (no uncertainty required).

Probe ES3DV3

SN:3334

Manufactured: January 24, 2012
Repaired: December 9, 2014
Calibrated: December 16, 2014

Calibrated for DASY/EASY Systems
(Note: non-compatible with DASY2 system!)

DASY/EASY - Parameters of Probe: ES3DV3 - SN:3334

Basic Calibration Parameters

	Sensor X	Sensor Y	Sensor Z	Unc (k=2)
Norm ($\mu\text{V}/(\text{V}/\text{m})^2$) ^A	1.04	1.05	1.01	$\pm 10.1 \%$
DCP (mV) ^B	106.5	105.0	105.6	

Modulation Calibration Parameters

UID	Communication System Name		A dB	B dB $\sqrt{\mu\text{V}}$	C	D dB	VR mV	Unc ^E (k=2)
0	CW	X	0.0	0.0	1.0	0.00	188.0	$\pm 3.0 \%$
		Y	0.0	0.0	1.0		183.2	
		Z	0.0	0.0	1.0		181.8	
10010-CAA	SAR Validation (Square, 100ms, 10ms)	X	4.61	67.2	13.7	10.00	38.4	$\pm 1.4 \%$
		Y	20.36	82.7	18.7		38.0	
		Z	17.55	80.3	17.6		37.0	
10011-CAB	UMTS-FDD (WCDMA)	X	3.56	68.4	19.1	2.91	148.4	$\pm 0.7 \%$
		Y	3.44	68.1	19.2		146.9	
		Z	3.52	68.3	19.1		144.7	
10012-CAB	IEEE 802.11b WIFI 2.4 GHz (DSSS, 1 Mbps)	X	3.54	71.9	20.0	1.87	148.0	$\pm 0.7 \%$
		Y	3.51	72.2	20.5		148.9	
		Z	3.80	73.3	20.6		144.6	
10013-CAB	IEEE 802.11g WIFI 2.4 GHz (DSSS-OFDM, 6 Mbps)	X	11.39	71.1	23.3	9.46	149.8	$\pm 3.8 \%$
		Y	11.54	71.8	24.0		149.5	
		Z	11.11	70.5	23.0		141.6	
10021-DAB	GSM-FDD (TDMA, GMSK)	X	15.29	91.3	25.0	9.39	131.9	$\pm 1.7 \%$
		Y	24.16	100.0	28.4		142.8	
		Z	13.05	89.2	24.5		126.5	
10023-DAB	GPRS-FDD (TDMA, GMSK, TN 0)	X	16.07	91.7	25.1	9.57	144.0	$\pm 2.2 \%$
		Y	19.00	95.3	26.8		136.4	
		Z	13.93	89.8	24.6		141.0	
10024-DAB	GPRS-FDD (TDMA, GMSK, TN 0-1)	X	19.98	91.0	22.4	6.56	134.2	$\pm 1.9 \%$
		Y	34.78	99.7	25.5		145.0	
		Z	29.89	96.8	24.1		129.8	
10027-DAB	GPRS-FDD (TDMA, GMSK, TN 0-1-2)	X	56.30	99.7	22.8	4.80	125.2	$\pm 1.9 \%$
		Y	41.16	99.6	23.9		131.2	
		Z	50.78	99.8	23.1		147.6	
10028-DAB	GPRS-FDD (TDMA, GMSK, TN 0-1-2-3)	X	49.35	99.7	22.5	3.55	133.2	$\pm 2.2 \%$
		Y	46.49	99.6	22.9		139.2	
		Z	58.21	99.7	22.0		129.4	
10032-CAA	IEEE 802.15.1 Bluetooth (GFSK, DH5)	X	56.54	100.0	20.2	1.16	128.0	$\pm 1.7 \%$
		Y	20.03	99.3	22.4		130.3	
		Z	84.01	100.0	19.4		141.0	
10100-CAB	LTE-FDD (SC-FDMA, 100% RB, 20 MHz, QPSK)	X	6.44	67.6	19.6	5.67	138.5	$\pm 1.4 \%$
		Y	6.50	67.9	20.0		142.1	
		Z	6.31	67.2	19.4		129.4	

10103-CAB	LTE-TDD (SC-FDMA, 100% RB, 20 MHz, QPSK)	X	9.77	73.6	24.6	9.29	129.6	±3.3 %
		Y	10.52	76.0	26.3		132.1	
		Z	10.21	75.0	25.4		147.7	
10108-CAC	LTE-FDD (SC-FDMA, 100% RB, 10 MHz, QPSK)	X	6.36	67.2	19.6	5.80	136.8	±1.4 %
		Y	6.31	67.3	19.8		137.2	
		Z	6.20	66.7	19.3		128.8	
10117-CAB	IEEE 802.11n (HT Mixed, 13.5 Mbps, BPSK)	X	9.96	68.3	20.8	8.07	126.5	±2.5 %
		Y	10.12	68.8	21.3		126.6	
		Z	10.22	69.0	21.2		143.7	
10151-CAB	LTE-TDD (SC-FDMA, 50% RB, 20 MHz, QPSK)	X	9.29	73.0	24.4	9.28	125.3	±3.3 %
		Y	9.65	74.5	25.6		124.4	
		Z	9.65	74.3	25.2		141.1	
10154-CAC	LTE-FDD (SC-FDMA, 50% RB, 10 MHz, QPSK)	X	6.03	66.7	19.3	5.75	132.7	±1.4 %
		Y	5.97	66.7	19.5		132.7	
		Z	6.17	67.3	19.7		148.3	
10160-CAB	LTE-FDD (SC-FDMA, 50% RB, 15 MHz, QPSK)	X	6.47	67.2	19.5	5.82	138.1	±1.4 %
		Y	6.44	67.3	19.8		138.2	
		Z	6.27	66.6	19.2		126.8	
10169-CAB	LTE-FDD (SC-FDMA, 1 RB, 20 MHz, QPSK)	X	5.03	66.9	19.6	5.73	137.2	±1.2 %
		Y	4.97	67.0	19.9		135.7	
		Z	4.91	66.5	19.5		127.1	
10172-CAB	LTE-TDD (SC-FDMA, 1 RB, 20 MHz, QPSK)	X	8.53	77.4	26.9	9.21	142.4	±2.7 %
		Y	9.59	81.3	29.3		142.3	
		Z	7.78	75.0	25.7		126.7	
10175-CAC	LTE-FDD (SC-FDMA, 1 RB, 10 MHz, QPSK)	X	5.02	67.0	19.7	5.72	131.8	±1.2 %
		Y	4.98	67.0	19.9		136.1	
		Z	4.95	66.8	19.6		128.1	
10181-CAB	LTE-FDD (SC-FDMA, 1 RB, 15 MHz, QPSK)	X	4.99	66.8	19.6	5.72	131.2	±1.2 %
		Y	4.99	67.1	20.0		136.2	
		Z	4.92	66.6	19.5		127.9	
10196-CAB	IEEE 802.11n (HT Mixed, 6.5 Mbps, BPSK)	X	9.98	68.8	21.2	8.10	141.7	±2.5 %
		Y	10.14	69.5	21.8		147.2	
		Z	9.85	68.6	21.1		137.5	
10225-CAB	UMTS-FDD (HSPA+)	X	7.17	67.5	19.6	5.97	146.0	±1.4 %
		Y	7.13	67.7	19.9		149.9	
		Z	7.12	67.5	19.6		142.9	
10237-CAB	LTE-TDD (SC-FDMA, 1 RB, 10 MHz, QPSK)	X	8.29	76.6	26.5	9.21	136.1	±2.7 %
		Y	9.60	81.4	29.3		142.3	
		Z	7.98	75.8	26.1		132.9	
10252-CAB	LTE-TDD (SC-FDMA, 50% RB, 10 MHz, QPSK)	X	9.27	74.1	25.1	9.24	139.1	±3.3 %
		Y	10.25	77.5	27.4		146.3	
		Z	9.07	73.7	25.0		135.8	
10267-CAB	LTE-TDD (SC-FDMA, 100% RB, 10 MHz, QPSK)	X	9.95	74.9	25.4	9.30	147.0	±3.3 %
		Y	9.80	75.0	25.9		125.9	
		Z	9.74	74.6	25.4		143.8	

10275-CAB	UMTS-FDD (HSUPA, Sublest 5, 3GPP Rel8.4)	X	4.63	67.6	19.0	3.96	147.5	±0.7 %
		Y	4.41	66.9	18.9		129.5	
		Z	4.61	67.6	19.1		148.1	
10291-AAB	CDMA2000, RC3, SO55, Full Rate	X	3.83	67.7	19.0	3.46	133.7	±0.7 %
		Y	3.71	67.4	19.0		139.0	
		Z	3.86	68.1	19.2		133.7	
10292-AAB	CDMA2000, RC3, SO32, Full Rate	X	3.85	68.2	19.2	3.39	136.7	±0.5 %
		Y	3.67	67.5	19.1		141.3	
		Z	3.75	67.8	19.0		136.2	
10297-AAA	LTE-FDD (SC-FDMA, 50% RB, 20 MHz, QPSK)	X	6.31	67.1	19.5	5.81	130.6	±1.4 %
		Y	6.32	67.3	19.8		135.1	
		Z	6.24	66.9	19.4		129.2	
10311-AAA	LTE-FDD (SC-FDMA, 100% RB, 15 MHz, QPSK)	X	6.85	67.5	19.8	6.06	135.1	±1.4 %
		Y	6.90	67.9	20.2		141.5	
		Z	6.82	67.5	19.8		135.1	
10403-AAB	CDMA2000 (1xEV-DO, Rev. 0)	X	5.04	69.1	19.1	3.76	126.0	±0.5 %
		Y	4.90	69.0	19.3		129.6	
		Z	5.11	69.7	19.4		125.8	
10404-AAB	CDMA2000 (1xEV-DO, Rev. A)	X	5.05	69.6	19.4	3.77	147.1	±0.7 %
		Y	4.84	69.2	19.5		127.8	
		Z	5.15	70.1	19.6		143.3	
10415-AAA	IEEE 802.11b WIFI 2.4 GHz (DSSS, 1 Mbps, 99pc duty cycle)	X	3.13	71.2	19.9	1.54	144.5	±0.5 %
		Y	2.93	70.4	19.9		149.8	
		Z	3.18	71.6	20.1		141.4	
10416-AAA	IEEE 802.11g WIFI 2.4 GHz (ERP-OFDM, 6 Mbps, 99pc duty cycle)	X	10.11	69.0	21.4	8.23	144.3	±2.5 %
		Y	10.21	69.6	21.9		148.3	
		Z	9.99	68.9	21.3		141.1	

The reported uncertainty of measurement is stated as the standard uncertainty of measurement multiplied by the coverage factor $k=2$, which for a normal distribution corresponds to a coverage probability of approximately 95%.

^A The uncertainties of NormX,Y,Z do not affect the E^2 -field uncertainty inside TSL. (see Pages 7 and 8).

^B Numerical linearization parameter: uncertainty not required.

^E Uncertainty is determined using the max. deviation from linear response applying rectangular distribution and is expressed for the square of the field value.

DASY/EASY - Parameters of Probe: ES3DV3 - SN:3334

Calibration Parameter Determined in Head Tissue Simulating Media

f (MHz) ^c	Relative Permittivity ^f	Conductivity (S/m) ^f	ConvF X	ConvF Y	ConvF Z	Alpha ^g	Depth ^g (mm)	Unct. (k=2)
750	41.9	0.89	6.51	6.51	6.51	0.80	1.17	± 12.0 %
835	41.5	0.90	6.25	6.25	6.25	0.38	1.58	± 12.0 %
1750	40.1	1.37	5.21	5.21	5.21	0.43	1.63	± 12.0 %
1900	40.0	1.40	5.03	5.03	5.03	0.53	1.45	± 12.0 %
2450	39.2	1.80	4.51	4.51	4.51	0.80	1.26	± 12.0 %
2600	39.0	1.96	4.31	4.31	4.31	0.79	1.27	± 12.0 %

^c Frequency validity above 300 MHz of ± 100 MHz only applies for DASY v4.4 and higher (see Page 2), else it is restricted to ± 50 MHz. The uncertainty is the RSS of the ConvF uncertainty at calibration frequency and the uncertainty for the indicated frequency band. Frequency validity below 300 MHz is ± 10, 25, 40, 50 and 70 MHz for ConvF assessments at 30, 64, 128, 150 and 220 MHz respectively. Above 5 GHz frequency validity can be extended to ± 110 MHz.

^f At frequencies below 3 GHz, the validity of tissue parameters (ϵ and σ) can be relaxed to ± 10% if liquid compensation formula is applied to measured SAR values. At frequencies above 3 GHz, the validity of tissue parameters (ϵ and σ) is restricted to ± 5%. The uncertainty is the RSS of the ConvF uncertainty for indicated target tissue parameters.

^g Alpha/Depth are determined during calibration. SPEAG warrants that the remaining deviation due to the boundary effect after compensation is always less than ± 1% for frequencies below 3 GHz and below ± 2% for frequencies between 3-6 GHz at any distance larger than half the probe tip diameter from the boundary.

DASY/EASY - Parameters of Probe: ES3DV3 - SN:3334

Calibration Parameter Determined in Body Tissue Simulating Media

f (MHz) ^c	Relative Permittivity ^f	Conductivity (S/m) ^f	ConvF X	ConvF Y	ConvF Z	Alpha ^g	Depth ^d (mm)	Unct. (k=2)
750	55.5	0.96	6.09	6.09	6.09	0.49	1.47	± 12.0 %
835	55.2	0.97	6.14	6.14	6.14	0.69	1.27	± 12.0 %
1750	53.4	1.49	4.94	4.94	4.94	0.80	1.24	± 12.0 %
1900	53.3	1.52	4.73	4.73	4.73	0.62	1.44	± 12.0 %
2450	52.7	1.95	4.28	4.28	4.28	0.80	1.13	± 12.0 %
2600	52.5	2.16	4.16	4.16	4.16	0.75	1.25	± 12.0 %

^c Frequency validity above 300 MHz of ± 100 MHz only applies for DASY v4.4 and higher (see Page 2), else it is restricted to ± 50 MHz. The uncertainty is the RSS of the ConvF uncertainty at calibration frequency and the uncertainty for the indicated frequency band. Frequency validity below 300 MHz is ± 10, 25, 40, 50 and 70 MHz for ConvF assessments at 30, 64, 128, 150 and 220 MHz respectively. Above 5 GHz frequency validity can be extended to ± 110 MHz.

^f At frequencies below 3 GHz, the validity of tissue parameters (ϵ and σ) can be relaxed to ± 10% if liquid compensation formula is applied to measured SAR values. At frequencies above 3 GHz, the validity of tissue parameters (ϵ and σ) is restricted to ± 5%. The uncertainty is the RSS of the ConvF uncertainty for indicated target tissue parameters.

^g Alpha/Depth are determined during calibration. SPEAG warrants that the remaining deviation due to the boundary effect after compensation is always less than ± 1% for frequencies below 3 GHz and below ± 2% for frequencies between 3-6 GHz at any distance larger than half the probe tip diameter from the boundary.

Frequency Response of E-Field (TEM-Cell:ifi110 EXX, Waveguide: R22)

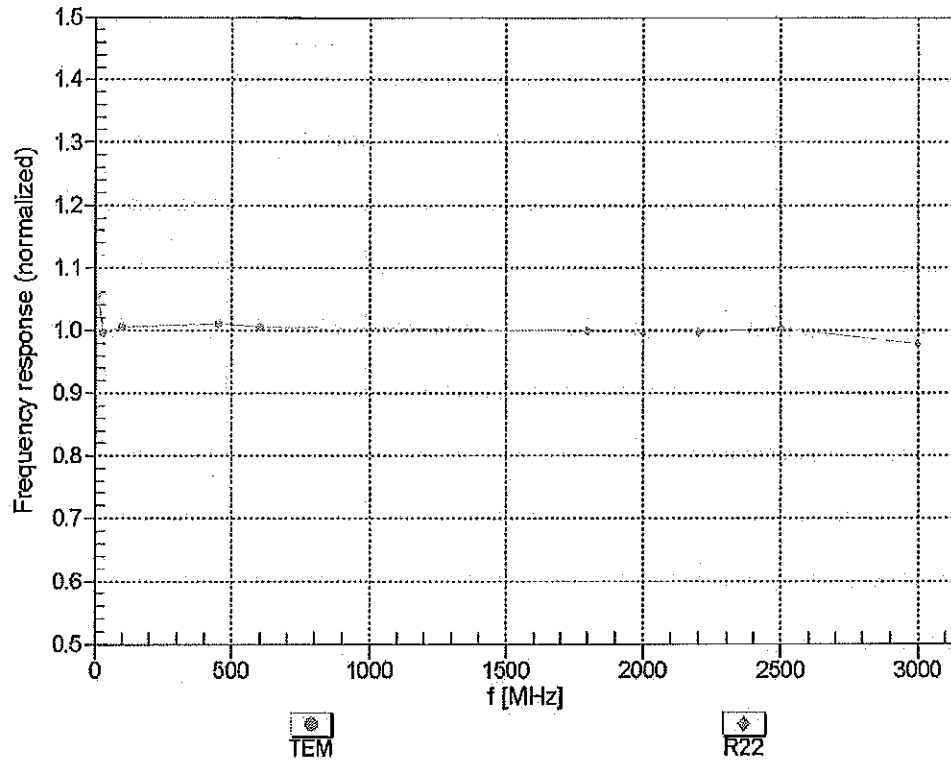

Uncertainty of Frequency Response of E-field: $\pm 6.3\%$ ($k=2$)

Receiving Pattern (ϕ), $\theta = 0^\circ$

f=600 MHz,TEM

f=1800 MHz,R22

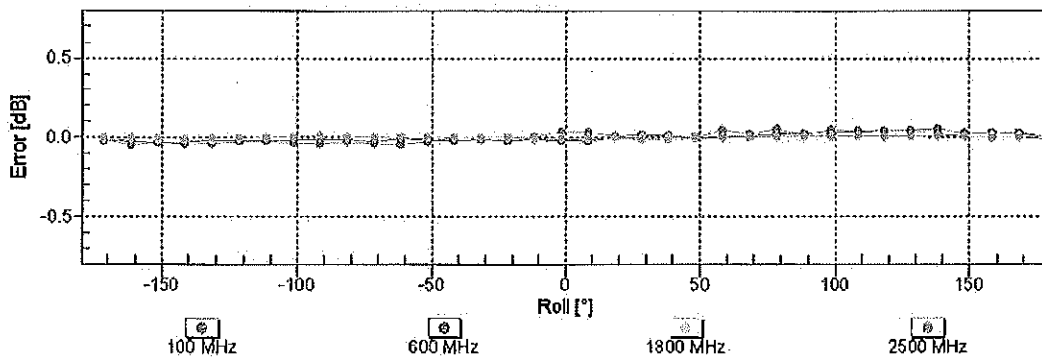
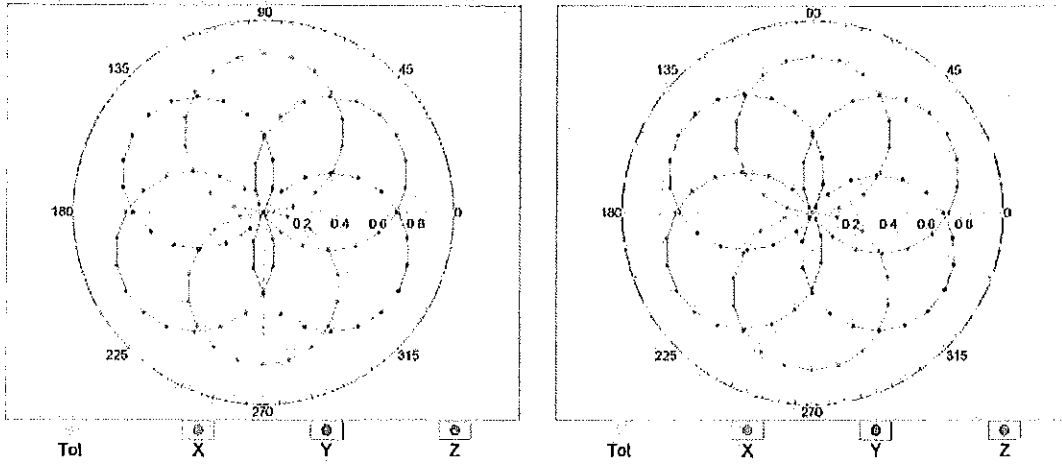

Uncertainty of Axial Isotropy Assessment: $\pm 0.5\%$ ($k=2$)

Dynamic Range f(SAR_{head}) (TEM cell , f_{eval}= 1900 MHz)

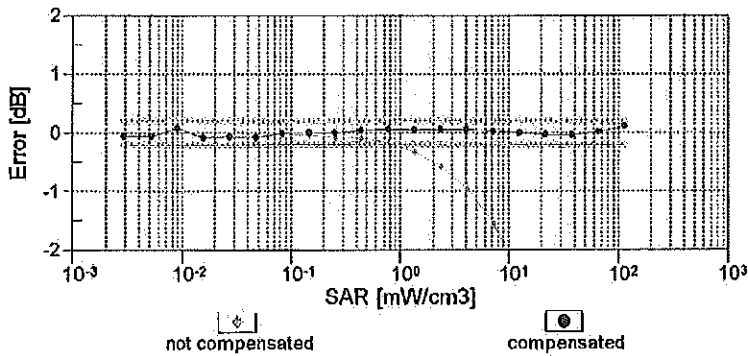
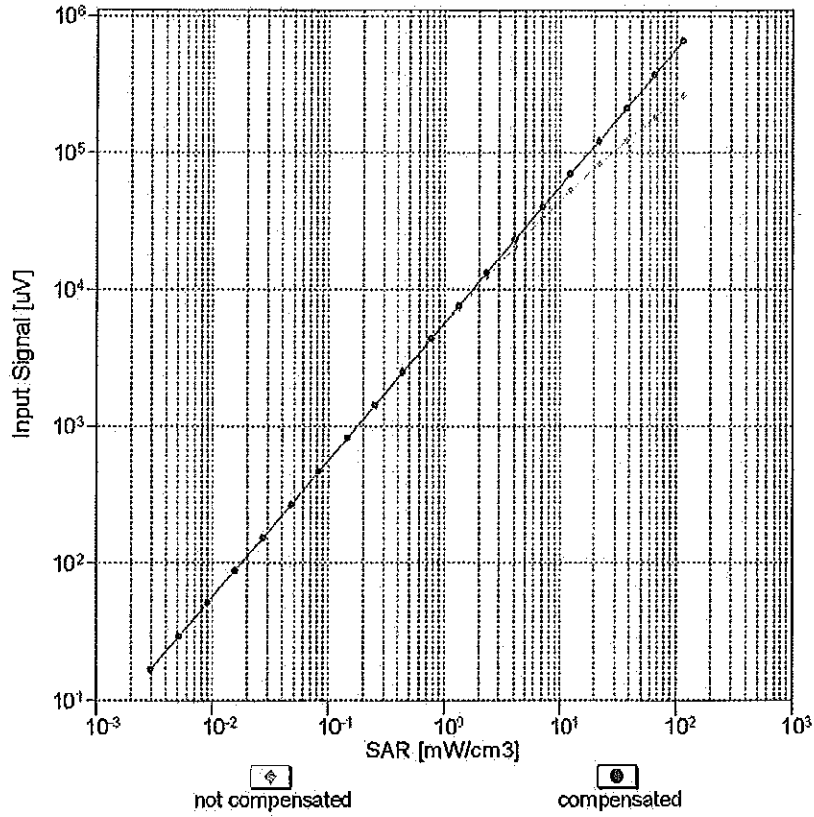

Uncertainty of Linearity Assessment: ± 0.6% (k=2)

Conversion Factor Assessment

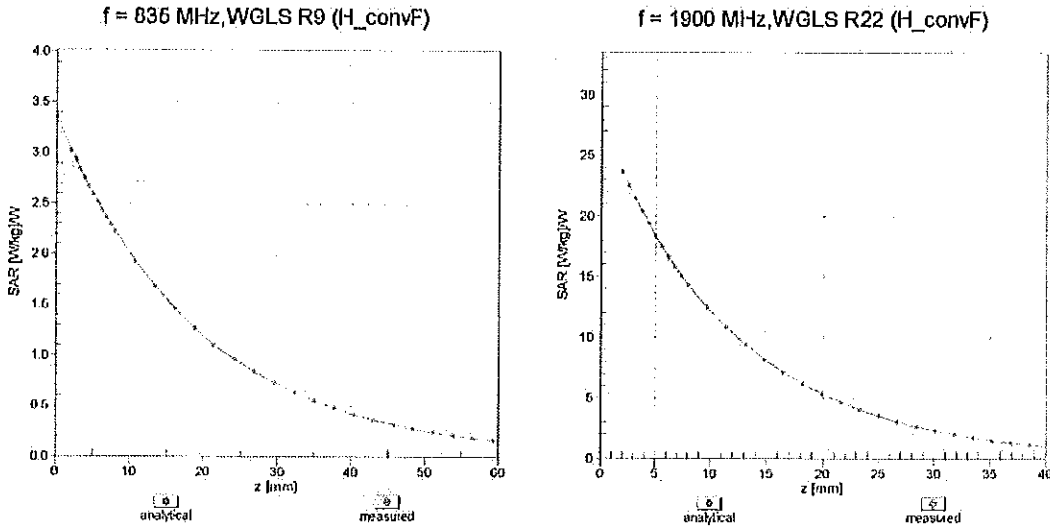

Deviation from Isotropy in Liquid Error (ϕ, θ), f = 900 MHz

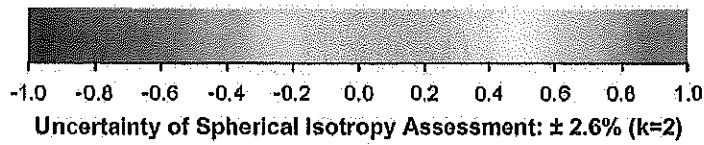
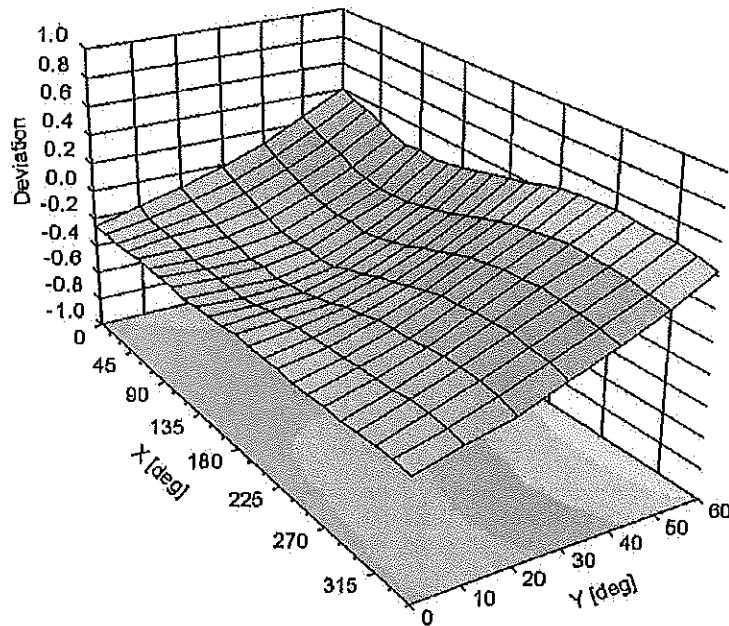

DASY/EASY - Parameters of Probe: ES3DV3 - SN:3334**Other Probe Parameters**

Sensor Arrangement	Triangular
Connector Angle (°)	18.5
Mechanical Surface Detection Mode	enabled
Optical Surface Detection Mode	disabled
Probe Overall Length	337 mm
Probe Body Diameter	10 mm
Tip Length	10 mm
Tip Diameter	4 mm
Probe Tip to Sensor X Calibration Point	2 mm
Probe Tip to Sensor Y Calibration Point	2 mm
Probe Tip to Sensor Z Calibration Point	2 mm
Recommended Measurement Distance from Surface	3 mm

**Calibration Laboratory of
Schmid & Partner
Engineering AG**
Zeughausstrasse 43, 8004 Zurich, Switzerland



S Schweizerischer Kalibrierdienst
C Service suisse d'étalonnage
S Servizio svizzero di taratura
Swiss Calibration Service

Accredited by the Swiss Accreditation Service (SAS)
The Swiss Accreditation Service is one of the signatories to the EA
Multilateral Agreement for the recognition of calibration certificates

Accreditation No.: **SCS 0108**

Client **PC Test**

Certificate No: **ES3-3213_Jan15**

CALIBRATION CERTIFICATE

Object **ES3DV3 - SN:3213**

Calibration procedure(s) **QA CAL-01.v9, QA CAL-23.v5, QA CAL-25.v6
Calibration procedure for dosimetric E-field probes**

CC
1/30/15

Calibration date: **January 20, 2015**

This calibration certificate documents the traceability to national standards, which realize the physical units of measurements (SI).
The measurements and the uncertainties with confidence probability are given on the following pages and are part of the certificate.

All calibrations have been conducted in the closed laboratory facility: environment temperature (22 ± 3)°C and humidity < 70%.

Calibration Equipment used (M&TE critical for calibration)

Primary Standards	ID	Cal Date (Certificate No.)	Scheduled Calibration
Power meter E4419B	GB41293874	03-Apr-14 (No. 217-01911)	Apr-15
Power sensor E4412A	MY41498087	03-Apr-14 (No. 217-01911)	Apr-15
Reference 3 dB Attenuator	SN: S5054 (3c)	03-Apr-14 (No. 217-01915)	Apr-15
Reference 20 dB Attenuator	SN: S5277 (20x)	03-Apr-14 (No. 217-01919)	Apr-15
Reference 30 dB Attenuator	SN: S5129 (30b)	03-Apr-14 (No. 217-01920)	Apr-15
Reference Probe ES3DV2	SN: 3013	30-Dec-14 (No. ES3-3013_Dec14)	Dec-15
DAE4	SN: 660	14-Jan-15 (No. DAE4-660_Jan15)	Jan-16
Secondary Standards	ID	Check Date (in house)	Scheduled Check
RF generator HP 8648C	US3642U01700	4-Aug-99 (in house check Apr-13)	In house check: Apr-16
Network Analyzer HP 8753E	US37390585	18-Oct-01 (in house check Oct-14)	In house check: Oct-15

Calibrated by:	Name Israe Elnaouq	Function Laboratory Technician	Signature
Approved by:	Katja Pokovic	Technical Manager	
			Issued: January 22, 2015
This calibration certificate shall not be reproduced except in full without written approval of the laboratory.			



Accredited by the Swiss Accreditation Service (SAS)

Accreditation No.: **SCS 0108**

The Swiss Accreditation Service is one of the signatories to the EA
Multilateral Agreement for the recognition of calibration certificates

Glossary:

TSL	tissue simulating liquid
NORM _{x,y,z}	sensitivity in free space
ConvF	sensitivity in TSL / NORM _{x,y,z}
DCP	diode compression point
CF	crest factor (1/duty_cycle) of the RF signal
A, B, C, D	modulation dependent linearization parameters
Polarization φ	φ rotation around probe axis
Polarization θ	θ rotation around an axis that is in the plane normal to probe axis (at measurement center), i.e., θ = 0 is normal to probe axis
Connector Angle	information used in DASY system to align probe sensor X to the robot coordinate system

Calibration is Performed According to the Following Standards:

- a) IEEE Std 1528-2013, "IEEE Recommended Practice for Determining the Peak Spatial-Averaged Specific Absorption Rate (SAR) in the Human Head from Wireless Communications Devices: Measurement Techniques", June 2013
- b) IEC 62209-1, "Procedure to measure the Specific Absorption Rate (SAR) for hand-held devices used in close proximity to the ear (frequency range of 300 MHz to 3 GHz)", February 2005

Methods Applied and Interpretation of Parameters:

- *NORM_{x,y,z}*: Assessed for E-field polarization θ = 0 (f ≤ 900 MHz in TEM-cell; f > 1800 MHz: R22 waveguide). *NORM_{x,y,z}* are only intermediate values, i.e., the uncertainties of *NORM_{x,y,z}* does not affect the E²-field uncertainty inside TSL (see below *ConvF*).
- *NORM(f)_{x,y,z}* = *NORM_{x,y,z}* * *frequency_response* (see Frequency Response Chart). This linearization is implemented in DASY4 software versions later than 4.2. The uncertainty of the frequency response is included in the stated uncertainty of *ConvF*.
- *DCP_{x,y,z}*: DCP are numerical linearization parameters assessed based on the data of power sweep with CW signal (no uncertainty required). DCP does not depend on frequency nor media.
- *PAR*: PAR is the Peak to Average Ratio that is not calibrated but determined based on the signal characteristics
- *A_{x,y,z}*; *B_{x,y,z}*; *C_{x,y,z}*; *D_{x,y,z}*; *VR_{x,y,z}*; *A, B, C, D* are numerical linearization parameters assessed based on the data of power sweep for specific modulation signal. The parameters do not depend on frequency nor media. *VR* is the maximum calibration range expressed in RMS voltage across the diode.
- *ConvF* and *Boundary Effect Parameters*: Assessed in flat phantom using E-field (or Temperature Transfer Standard for f ≤ 800 MHz) and inside waveguide using analytical field distributions based on power measurements for f > 800 MHz. The same setups are used for assessment of the parameters applied for boundary compensation (alpha, depth) of which typical uncertainty values are given. These parameters are used in DASY4 software to improve probe accuracy close to the boundary. The sensitivity in TSL corresponds to *NORM_{x,y,z}* * *ConvF* whereby the uncertainty corresponds to that given for *ConvF*. A frequency dependent *ConvF* is used in DASY version 4.4 and higher which allows extending the validity from ± 50 MHz to ± 100 MHz.
- *Spherical isotropy (3D deviation from isotropy)*: in a field of low gradients realized using a flat phantom exposed by a patch antenna.
- *Sensor Offset*: The sensor offset corresponds to the offset of virtual measurement center from the probe tip (on probe axis). No tolerance required.
- *Connector Angle*: The angle is assessed using the information gained by determining the *NORM_x* (no uncertainty required).

Probe ES3DV3

SN:3213

Manufactured: October 14, 2008
Calibrated: January 20, 2015

Calibrated for DASY/EASY Systems
(Note: non-compatible with DASY2 system!)

DASY/EASY - Parameters of Probe: ES3DV3 - SN:3213

Basic Calibration Parameters

	Sensor X	Sensor Y	Sensor Z	Unc (k=2)
Norm ($\mu V/(V/m)^2$) ^A	1.49	1.37	1.34	$\pm 10.1\%$
DCP (mV) ^B	99.9	101.8	101.4	

Modulation Calibration Parameters

UID	Communication System Name		A dB	B dB $\sqrt{\mu V}$	C	D dB	VR mV	Unc ^E (k=2)
0	CW	X	0.0	0.0	1.0	0.00	169.8	$\pm 3.8\%$
		Y	0.0	0.0	1.0		215.4	
		Z	0.0	0.0	1.0		214.5	
10010-CAA	SAR Validation (Square, 100ms, 10ms)	X	1.84	57.8	10.2	10.00	47.4	$\pm 1.9\%$
		Y	1.82	58.6	10.3		44.3	
		Z	1.65	57.3	9.2		44.2	
10011-CAB	UMTS-FDD (WCDMA)	X	3.32	66.8	18.5	2.91	135.8	$\pm 0.5\%$
		Y	3.18	66.4	18.2		127.9	
		Z	3.21	66.5	18.2		128.1	
10012-CAB	IEEE 802.11b WiFi 2.4 GHz (DSSS, 1 Mbps)	X	2.90	68.1	18.4	1.87	137.2	$\pm 0.7\%$
		Y	2.97	69.2	19.0		130.1	
		Z	2.80	68.0	18.4		129.9	
10013-CAB	IEEE 802.11g WiFi 2.4 GHz (DSSS-OFDM, 6 Mbps)	X	11.40	71.2	23.7	9.46	135.1	$\pm 3.8\%$
		Y	11.25	71.3	23.9		124.2	
		Z	10.96	70.3	23.2		124.8	
10021-DAB	GSM-FDD (TDMA, GMSK)	X	18.25	96.6	27.2	9.39	140.4	$\pm 1.7\%$
		Y	21.48	99.9	28.2		133.3	
		Z	11.76	89.4	24.5		127.3	
10023-DAB	GPRS-FDD (TDMA, GMSK, TN 0)	X	13.12	91.7	26.0	9.57	126.4	$\pm 1.9\%$
		Y	17.05	95.2	26.6		127.3	
		Z	8.91	85.2	23.3		118.8	
10024-DAB	GPRS-FDD (TDMA, GMSK, TN 0-1)	X	34.78	100.0	25.2	6.56	116.4	$\pm 1.7\%$
		Y	33.37	99.5	24.8		111.7	
		Z	34.11	99.5	24.6		110.5	
10027-DAB	GPRS-FDD (TDMA, GMSK, TN 0-1-2)	X	37.18	99.7	24.0	4.80	131.2	$\pm 1.7\%$
		Y	44.91	99.8	23.3		127.4	
		Z	41.51	99.7	23.2		125.0	
10028-DAB	GPRS-FDD (TDMA, GMSK, TN 0-1-2-3)	X	48.95	99.5	22.4	3.55	140.9	$\pm 1.7\%$
		Y	67.41	99.8	21.5		137.8	
		Z	56.45	100.0	21.9		135.0	
10032-CAA	IEEE 802.15.1 Bluetooth (GFSK, DH5)	X	20.23	99.3	22.1	1.16	111.3	$\pm 1.2\%$
		Y	32.72	99.5	20.6		109.6	
		Z	48.57	100.0	20.0		108.8	
10100-CAB	LTE-FDD (SC-FDMA, 100% RB, 20 MHz, QPSK)	X	6.60	67.9	20.0	5.67	144.6	$\pm 1.2\%$
		Y	6.55	68.2	20.2		142.7	
		Z	6.50	67.8	19.9		141.5	

10103-CAB	LTE-TDD (SC-FDMA, 100% RB, 20 MHz, QPSK)	X	10.34	75.7	26.2	9.29	133.2	±2.5 %
		Y	10.31	76.5	26.9		128.2	
		Z	9.74	74.5	25.6		127.1	
10108-CAC	LTE-FDD (SC-FDMA, 100% RB, 10 MHz, QPSK)	X	6.50	67.6	20.0	5.80	142.8	±1.2 %
		Y	6.41	67.7	20.1		140.3	
		Z	6.41	67.6	19.9		140.2	
10117-CAB	IEEE 802.11n (HT Mixed, 13.5 Mbps, BPSK)	X	10.36	69.2	21.6	8.07	132.8	±2.7 %
		Y	10.42	69.7	21.9		131.4	
		Z	10.22	69.1	21.4		130.0	
10151-CAB	LTE-TDD (SC-FDMA, 50% RB, 20 MHz, QPSK)	X	9.65	74.6	25.8	9.28	127.9	±2.5 %
		Y	9.66	75.6	26.7		123.7	
		Z	9.14	73.6	25.3		122.7	
10154-CAC	LTE-FDD (SC-FDMA, 50% RB, 10 MHz, QPSK)	X	6.14	66.9	19.6	5.75	139.3	±1.4 %
		Y	6.08	67.2	19.9		138.5	
		Z	6.05	66.9	19.6		137.3	
10160-CAB	LTE-FDD (SC-FDMA, 50% RB, 15 MHz, QPSK)	X	6.58	67.5	19.9	5.82	144.3	±1.4 %
		Y	6.54	67.8	20.1		143.7	
		Z	6.50	67.5	19.8		142.1	
10169-CAB	LTE-FDD (SC-FDMA, 1 RB, 20 MHz, QPSK)	X	4.93	66.1	19.3	5.73	120.6	±0.9 %
		Y	4.93	66.7	19.8		120.9	
		Z	4.85	66.3	19.5		118.9	
10172-CAB	LTE-TDD (SC-FDMA, 1 RB, 20 MHz, QPSK)	X	8.93	79.5	28.6	9.21	140.8	±2.5 %
		Y	9.60	82.9	30.6		139.9	
		Z	8.30	78.2	27.9		136.6	
10175-CAC	LTE-FDD (SC-FDMA, 1 RB, 10 MHz, QPSK)	X	4.90	66.0	19.3	5.72	118.8	±0.9 %
		Y	4.93	66.8	19.8		120.2	
		Z	4.81	66.1	19.3		116.6	
10181-CAB	LTE-FDD (SC-FDMA, 1 RB, 15 MHz, QPSK)	X	4.92	66.1	19.3	5.72	119.0	±0.9 %
		Y	4.92	66.6	19.8		120.5	
		Z	4.77	65.8	19.2		115.8	
10196-CAB	IEEE 802.11n (HT Mixed, 6.5 Mbps, BPSK)	X	9.93	68.7	21.4	8.10	125.0	±2.5 %
		Y	10.06	69.4	21.9		128.3	
		Z	9.78	68.5	21.2		120.5	
10225-CAB	UMTS-FDD (HSPA+)	X	6.66	65.7	18.8	5.97	106.5	±0.9 %
		Y	6.81	66.6	19.3		112.3	
		Z	6.64	66.0	18.9		108.0	
10237-CAB	LTE-TDD (SC-FDMA, 1 RB, 10 MHz, QPSK)	X	8.91	79.4	28.5	9.21	141.4	±2.2 %
		Y	9.39	82.3	30.4		146.7	
		Z	8.40	78.5	28.2		141.2	
10252-CAB	LTE-TDD (SC-FDMA, 50% RB, 10 MHz, QPSK)	X	8.84	73.3	25.2	9.24	119.1	±2.7 %
		Y	8.94	74.6	26.3		118.6	
		Z	8.39	72.4	24.7		114.0	
10267-CAB	LTE-TDD (SC-FDMA, 100% RB, 10 MHz, QPSK)	X	9.62	74.6	25.8	9.30	126.2	±2.7 %
		Y	9.77	76.0	26.9		126.1	
		Z	9.10	73.4	25.2		121.4	

10275-CAB	UMTS-FDD (HSUPA, Subtest 5, 3GPP Rel8.4)	X	4.43	66.4	18.5	3.96	132.5	±0.7 %
		Y	4.37	66.6	18.6		134.1	
		Z	4.40	66.7	18.6		130.5	
10291-AAB	CDMA2000, RC3, SO55, Full Rate	X	3.63	66.4	18.4	3.46	122.5	±0.5 %
		Y	3.54	66.5	18.5		124.9	
		Z	3.55	66.3	18.3		121.4	
10292-AAB	CDMA2000, RC3, SO32, Full Rate	X	3.49	65.9	18.1	3.39	125.1	±0.5 %
		Y	3.52	66.7	18.6		126.1	
		Z	3.51	66.5	18.4		123.8	
10297-AAA	LTE-FDD (SC-FDMA, 50% RB, 20 MHz, QPSK)	X	6.49	67.6	19.9	5.81	143.1	±1.4 %
		Y	6.49	68.0	20.3		142.3	
		Z	6.42	67.6	19.9		144.3	
10311-AAA	LTE-FDD (SC-FDMA, 100% RB, 15 MHz, QPSK)	X	7.06	68.1	20.2	6.06	147.6	±1.7 %
		Y	7.09	68.7	20.7		148.2	
		Z	7.03	68.3	20.4		149.8	
10403-AAB	CDMA2000 (1xEV-DO, Rev. 0)	X	4.66	67.4	18.4	3.76	135.3	±0.5 %
		Y	4.69	68.1	18.7		134.9	
		Z	4.72	68.2	18.7		136.5	
10404-AAB	CDMA2000 (1xEV-DO, Rev. A)	X	4.58	67.4	18.3	3.77	133.4	±0.5 %
		Y	4.68	68.4	18.9		132.8	
		Z	4.58	67.9	18.5		135.4	
10415-AAA	IEEE 802.11b WiFi 2.4 GHz (DSSS, 1 Mbps, 99pc duty cycle)	X	2.41	65.7	17.2	1.54	131.4	±0.7 %
		Y	2.42	66.4	17.7		131.3	
		Z	2.59	67.7	18.2		134.1	
10416-AAA	IEEE 802.11g WiFi 2.4 GHz (ERP-OFDM, 6 Mbps, 99pc duty cycle)	X	10.06	68.9	21.5	8.23	127.6	±2.7 %
		Y	10.12	69.5	22.0		126.3	
		Z	10.04	69.1	21.7		129.7	

The reported uncertainty of measurement is stated as the standard uncertainty of measurement multiplied by the coverage factor $k=2$, which for a normal distribution corresponds to a coverage probability of approximately 95%.

^A The uncertainties of NormX,Y,Z do not affect the E^2 -field uncertainty inside TSL (see Pages 7 and 8).

^B Numerical linearization parameter: uncertainty not required.

^E Uncertainty is determined using the max. deviation from linear response applying rectangular distribution and is expressed for the square of the field value.

DASY/EASY - Parameters of Probe: ES3DV3 - SN:3213

Calibration Parameter Determined in Head Tissue Simulating Media

f (MHz) ^c	Relative Permittivity ^F	Conductivity (S/m) ^F	ConvF X	ConvF Y	ConvF Z	Alpha ^G	Depth ^G (mm)	Unct. (k=2)
750	41.9	0.89	6.45	6.45	6.45	0.57	1.37	± 12.0 %
835	41.5	0.90	6.26	6.26	6.26	0.65	1.26	± 12.0 %
1750	40.1	1.37	5.22	5.22	5.22	0.47	1.47	± 12.0 %
1900	40.0	1.40	5.06	5.06	5.06	0.80	1.14	± 12.0 %
2450	39.2	1.80	4.54	4.54	4.54	0.78	1.22	± 12.0 %
2600	39.0	1.96	4.33	4.33	4.33	0.80	1.28	± 12.0 %

^c Frequency validity above 300 MHz of ± 100 MHz only applies for DASY v4.4 and higher (see Page 2), else it is restricted to ± 50 MHz. The uncertainty is the RSS of the ConvF uncertainty at calibration frequency and the uncertainty for the indicated frequency band. Frequency validity below 300 MHz is ± 10, 25, 40, 50 and 70 MHz for ConvF assessments at 30, 64, 128, 150 and 220 MHz respectively. Above 5 GHz frequency validity can be extended to ± 110 MHz.

^F At frequencies below 3 GHz, the validity of tissue parameters (ϵ and σ) can be relaxed to ± 10% if liquid compensation formula is applied to measured SAR values. At frequencies above 3 GHz, the validity of tissue parameters (ϵ and σ) is restricted to ± 5%. The uncertainty is the RSS of the ConvF uncertainty for indicated target tissue parameters.

^G Alpha/Depth are determined during calibration. SPEAG warrants that the remaining deviation due to the boundary effect after compensation is always less than ± 1% for frequencies below 3 GHz and below ± 2% for frequencies between 3-6 GHz at any distance larger than half the probe tip diameter from the boundary.

DASY/EASY - Parameters of Probe: ES3DV3 - SN:3213

Calibration Parameter Determined in Body Tissue Simulating Media

f (MHz) ^C	Relative Permittivity ^F	Conductivity (S/m) ^F	ConvF X	ConvF Y	ConvF Z	Alpha ^G	Depth ^G (mm)	Unct. (k=2)
750	55.5	0.96	6.11	6.11	6.11	0.71	1.24	± 12.0 %
835	55.2	0.97	6.07	6.07	6.07	0.35	1.86	± 12.0 %
1750	53.4	1.49	4.93	4.93	4.93	0.51	1.47	± 12.0 %
1900	53.3	1.52	4.72	4.72	4.72	0.80	1.20	± 12.0 %
2450	52.7	1.95	4.37	4.37	4.37	0.71	1.12	± 12.0 %
2600	52.5	2.16	4.20	4.20	4.20	0.66	0.95	± 12.0 %

^C Frequency validity above 300 MHz of ± 100 MHz only applies for DASY v4.4 and higher (see Page 2), else it is restricted to ± 50 MHz. The uncertainty is the RSS of the ConvF uncertainty at calibration frequency and the uncertainty for the indicated frequency band. Frequency validity below 300 MHz is ± 10, 25, 40, 50 and 70 MHz for ConvF assessments at 30, 64, 128, 150 and 220 MHz respectively. Above 5 GHz frequency validity can be extended to ± 110 MHz.

^F At frequencies below 3 GHz, the validity of tissue parameters (ϵ and σ) can be relaxed to ± 10% if liquid compensation formula is applied to measured SAR values. At frequencies above 3 GHz, the validity of tissue parameters (ϵ and σ) is restricted to ± 5%. The uncertainty is the RSS of the ConvF uncertainty for indicated target tissue parameters.

^G Alpha/Depth are determined during calibration. SPEAG warrants that the remaining deviation due to the boundary effect after compensation is always less than ± 1% for frequencies below 3 GHz and below ± 2% for frequencies between 3-6 GHz at any distance larger than half the probe tip diameter from the boundary.

Frequency Response of E-Field (TEM-Cell:ifi110 EXX, Waveguide: R22)

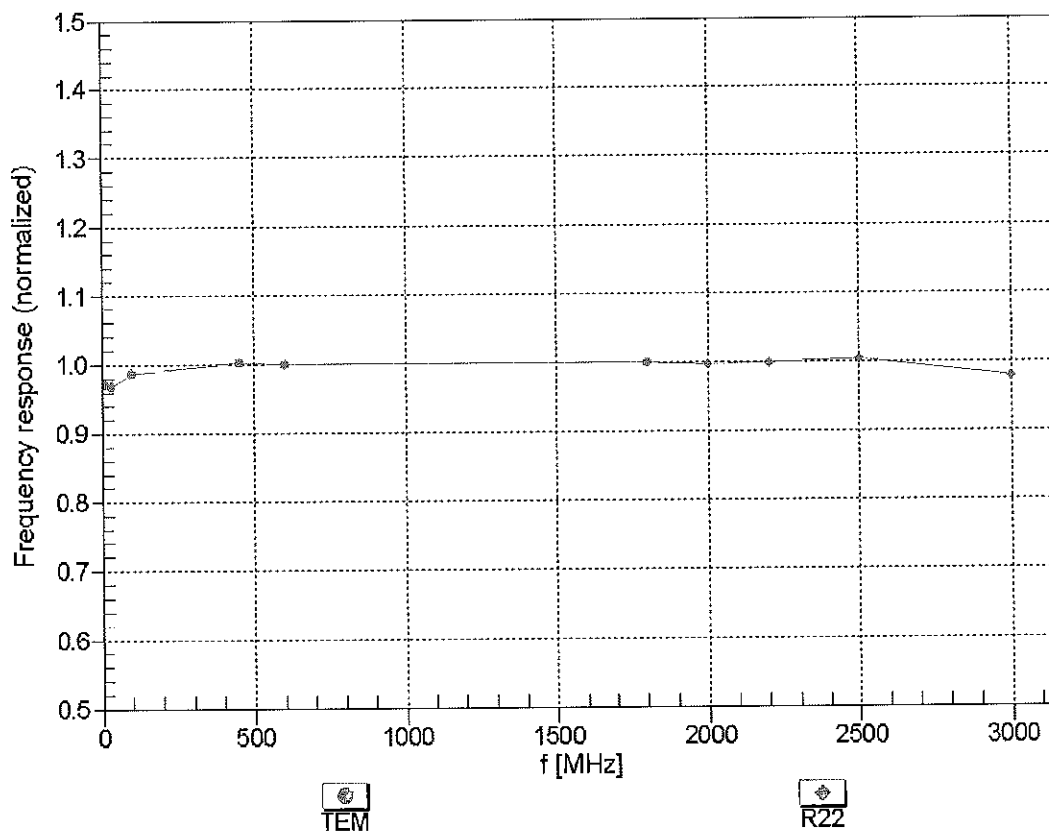

Uncertainty of Frequency Response of E-field: $\pm 6.3\%$ (k=2)

Receiving Pattern (ϕ), $\theta = 0^\circ$

f=600 MHz, TEM

f=1800 MHz, R22

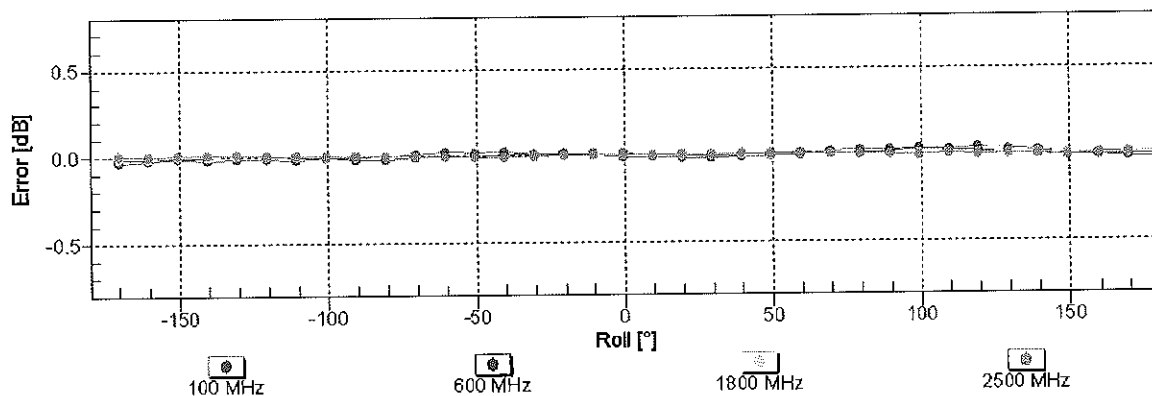
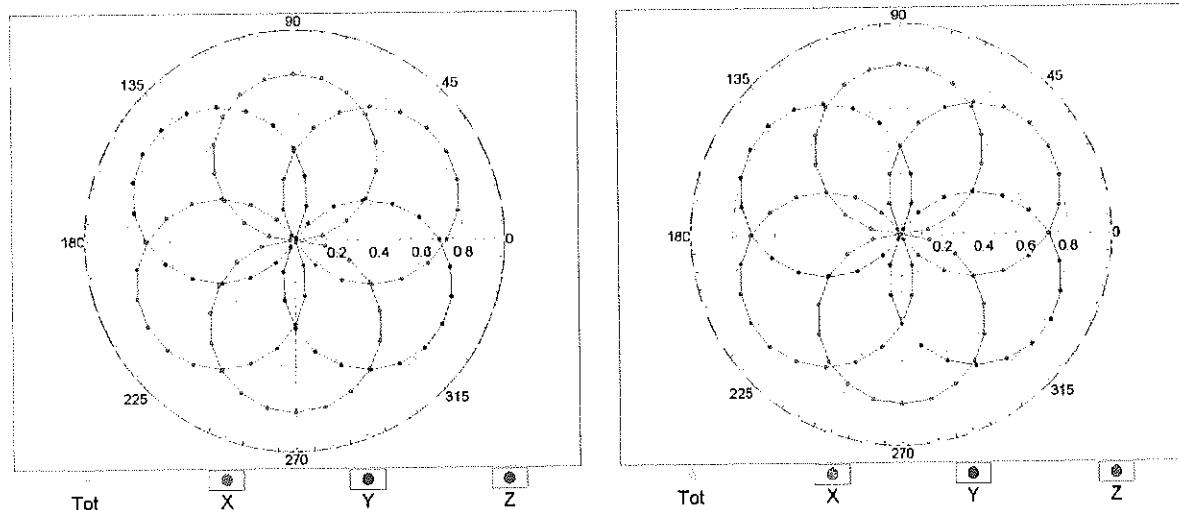

Uncertainty of Axial Isotropy Assessment: $\pm 0.5\%$ (k=2)

Dynamic Range f(SAR_{head}) (TEM cell , f_{eval}= 1900 MHz)

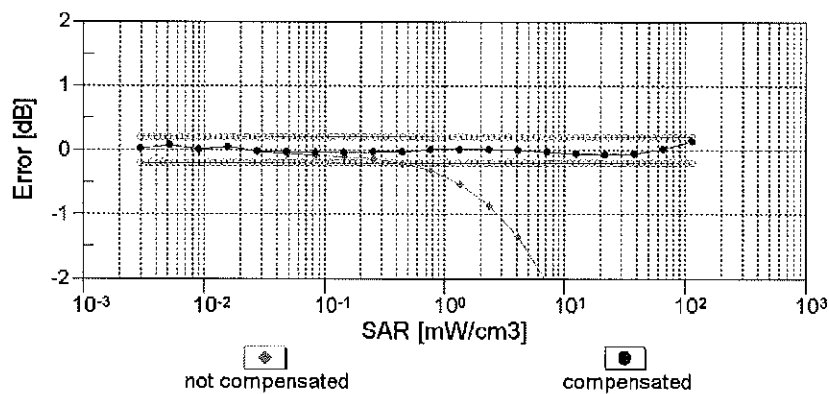
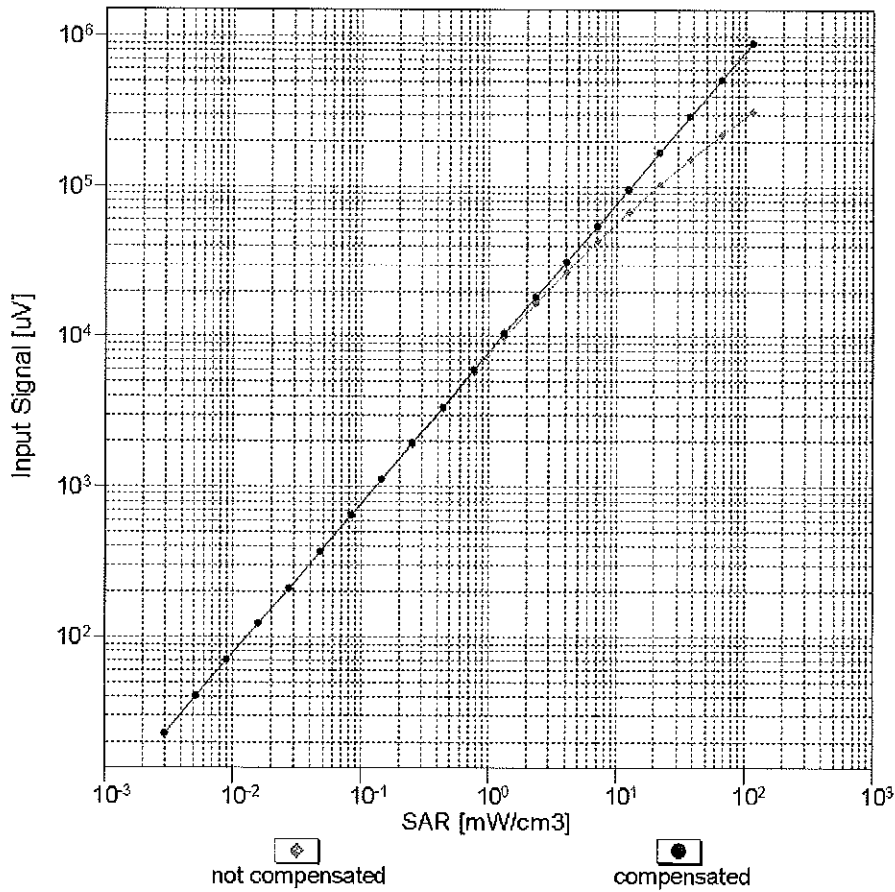

Uncertainty of Linearity Assessment: ± 0.6% (k=2)

Conversion Factor Assessment

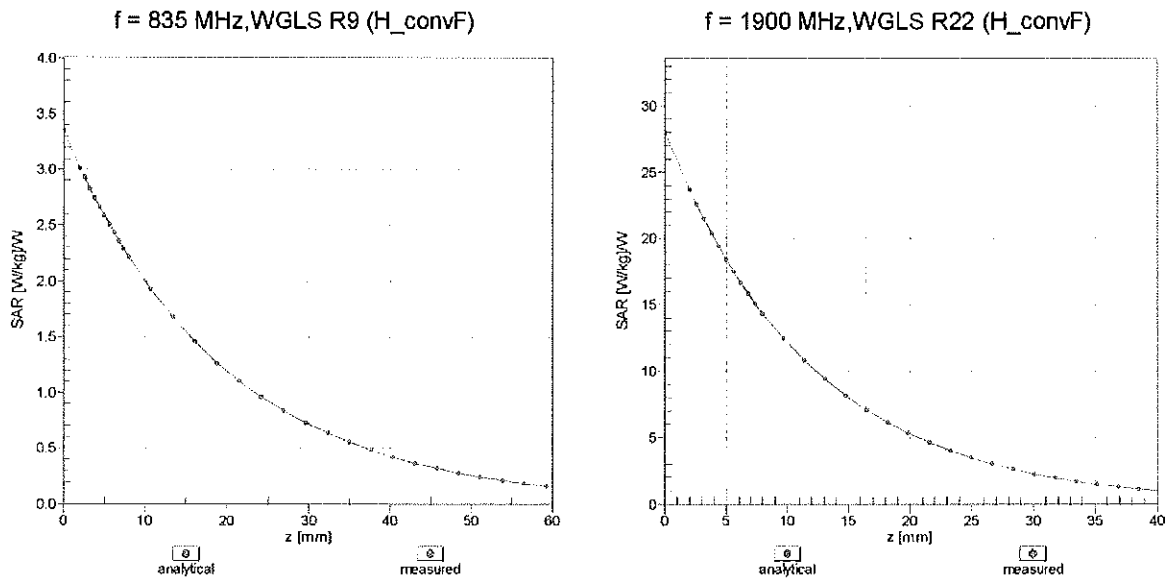

Deviation from Isotropy in Liquid Error (ϕ, θ), f = 900 MHz

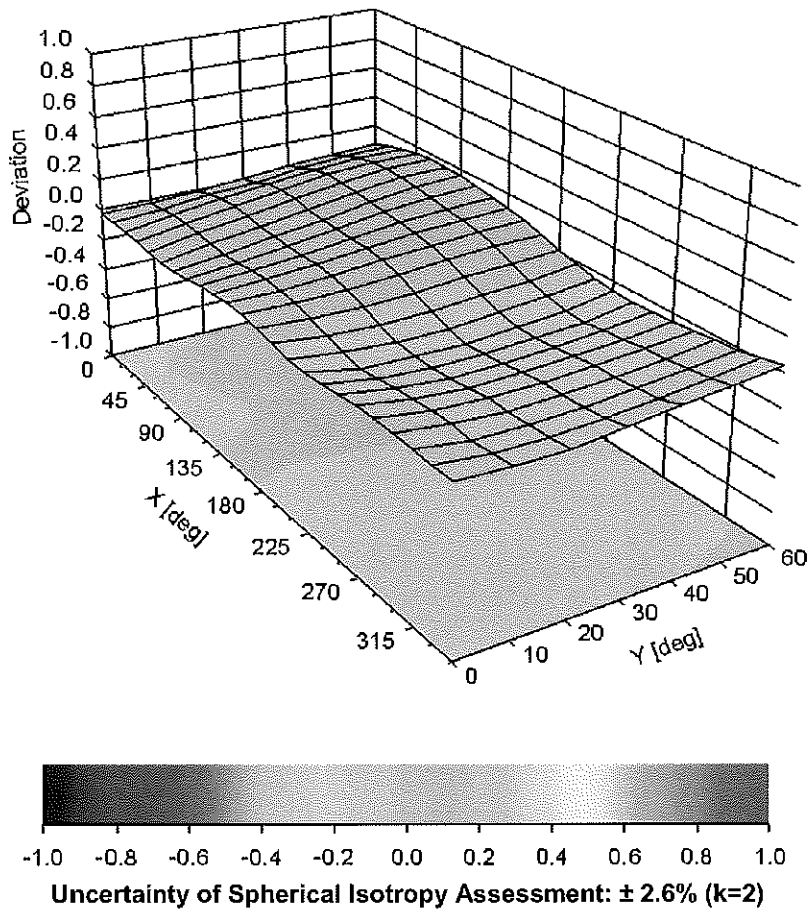

DASY/EASY - Parameters of Probe: ES3DV3 - SN:3213

Other Probe Parameters

Sensor Arrangement	Triangular
Connector Angle (°)	-70.6
Mechanical Surface Detection Mode	enabled
Optical Surface Detection Mode	disabled
Probe Overall Length	337 mm
Probe Body Diameter	10 mm
Tip Length	10 mm
Tip Diameter	4 mm
Probe Tip to Sensor X Calibration Point	2 mm
Probe Tip to Sensor Y Calibration Point	2 mm
Probe Tip to Sensor Z Calibration Point	2 mm
Recommended Measurement Distance from Surface	3 mm



Accredited by the Swiss Accreditation Service (SAS)
The Swiss Accreditation Service is one of the signatories to the EA
Multilateral Agreement for the recognition of calibration certificates

Accreditation No.: **SCS 108**

Client **PC Test**

Certificate No: **EX3-3920_Dec14**

CALIBRATION CERTIFICATE

Object **EX3DV4 - SN:3920**

Calibration procedure(s) **QA CAL-01.v9, QA CAL-14.v4, QA CAL-23.v5, QA CAL-25.v6
Calibration procedure for dosimetric E-field probes**

CC
RIS/19

Calibration date: **December 12, 2014**

This calibration certificate documents the traceability to national standards, which realize the physical units of measurements (SI).
The measurements and the uncertainties with confidence probability are given on the following pages and are part of the certificate.

All calibrations have been conducted in the closed laboratory facility: environment temperature (22 ± 3)°C and humidity < 70%.

Calibration Equipment used (M&TE critical for calibration)

Primary Standards	ID	Cal Date (Certificate No.)	Scheduled Calibration
Power meter E4419B	GB41293874	03-Apr-14 (No. 217-01911)	Apr-15
Power sensor E4412A	MY41498087	03-Apr-14 (No. 217-01911)	Apr-15
Reference 3 dB Attenuator	SN: S5054 (3c)	03-Apr-14 (No. 217-01915)	Apr-15
Reference 20 dB Attenuator	SN: S5277 (20x)	03-Apr-14 (No. 217-01919)	Apr-15
Reference 30 dB Attenuator	SN: S5129 (30b)	03-Apr-14 (No. 217-01920)	Apr-15
Reference Probe ES3DV2	SN: 3013	30-Dec-13 (No. ES3-3013_Dec13)	Dec-14
DAE4	SN: 660	13-Dec-13 (No. DAE4-660_Dec13)	Dec-14
Secondary Standards	ID	Check Date (in house)	Scheduled Check
RF generator HP 8648C	US3642U01700	4-Aug-99 (in house check Apr-13)	In house check: Apr-16
Network Analyzer HP 8753E	US37390585	18-Oct-01 (in house check Oct-14)	In house check: Oct-15

Calibrated by:	Name Israe El-Naoug	Function Laboratory Technician	Signature
Approved by:	Name Katja Pokovic	Function Technical Manager	Signature
			Issued: December 13, 2014
This calibration certificate shall not be reproduced except in full without written approval of the laboratory.			



Accredited by the Swiss Accreditation Service (SAS)

Accreditation No.: **SCS 108**

The Swiss Accreditation Service is one of the signatories to the EA
Multilateral Agreement for the recognition of calibration certificates

Glossary:

TSL	tissue simulating liquid
NORM _{x,y,z}	sensitivity in free space
ConvF	sensitivity in TSL / NORM _{x,y,z}
DCP	diode compression point
CF	crest factor (1/duty_cycle) of the RF signal
A, B, C, D	modulation dependent linearization parameters
Polarization φ	φ rotation around probe axis
Polarization ϑ	ϑ rotation around an axis that is in the plane normal to probe axis (at measurement center), i.e., ϑ = 0 is normal to probe axis
Connector Angle	information used in DASY system to align probe sensor X to the robot coordinate system

Calibration is Performed According to the Following Standards:

- a) IEEE Std 1528-2013, "IEEE Recommended Practice for Determining the Peak Spatial-Averaged Specific Absorption Rate (SAR) in the Human Head from Wireless Communications Devices: Measurement Techniques", June 2013
- b) IEC 62209-1, "Procedure to measure the Specific Absorption Rate (SAR) for hand-held devices used in close proximity to the ear (frequency range of 300 MHz to 3 GHz)", February 2005

Methods Applied and Interpretation of Parameters:

- *NORM_{x,y,z}*: Assessed for E-field polarization ϑ = 0 (f ≤ 900 MHz in TEM-cell; f > 1800 MHz: R22 waveguide). *NORM_{x,y,z}* are only intermediate values, i.e., the uncertainties of *NORM_{x,y,z}* does not affect the E²-field uncertainty inside TSL (see below *ConvF*).
- *NORM(f)_{x,y,z}* = *NORM_{x,y,z}* * *frequency_response* (see Frequency Response Chart). This linearization is implemented in DASY4 software versions later than 4.2. The uncertainty of the frequency response is included in the stated uncertainty of *ConvF*.
- *DCP_{x,y,z}*: DCP are numerical linearization parameters assessed based on the data of power sweep with CW signal (no uncertainty required). DCP does not depend on frequency nor media.
- *PAR*: PAR is the Peak to Average Ratio that is not calibrated but determined based on the signal characteristics
- *A_{x,y,z}*; *B_{x,y,z}*; *C_{x,y,z}*; *D_{x,y,z}*; *VR_{x,y,z}*; *A, B, C, D* are numerical linearization parameters assessed based on the data of power sweep for specific modulation signal. The parameters do not depend on frequency nor media. *VR* is the maximum calibration range expressed in RMS voltage across the diode.
- *ConvF and Boundary Effect Parameters*: Assessed in flat phantom using E-field (or Temperature Transfer Standard for f ≤ 800 MHz) and inside waveguide using analytical field distributions based on power measurements for f > 800 MHz. The same setups are used for assessment of the parameters applied for boundary compensation (alpha, depth) of which typical uncertainty values are given. These parameters are used in DASY4 software to improve probe accuracy close to the boundary. The sensitivity in TSL corresponds to *NORM_{x,y,z}* * *ConvF* whereby the uncertainty corresponds to that given for *ConvF*. A frequency dependent *ConvF* is used in DASY version 4.4 and higher which allows extending the validity from ± 50 MHz to ± 100 MHz.
- *Spherical isotropy (3D deviation from isotropy)*: in a field of low gradients realized using a flat phantom exposed by a patch antenna.
- *Sensor Offset*: The sensor offset corresponds to the offset of virtual measurement center from the probe tip (on probe axis). No tolerance required.
- *Connector Angle*: The angle is assessed using the information gained by determining the *NORM_x* (no uncertainty required).

Probe EX3DV4

SN:3920

Manufactured: December 18, 2012
Calibrated: December 12, 2014

Calibrated for DASY/EASY Systems
(Note: non-compatible with DASY2 system!)

DASY/EASY - Parameters of Probe: EX3DV4 - SN:3920

Basic Calibration Parameters

	Sensor X	Sensor Y	Sensor Z	Unc (k=2)
Norm ($\mu\text{V}/(\text{V}/\text{m})^2$) ^A	0.35	0.50	0.50	$\pm 10.1\%$
DCP (mV) ^B	104.2	98.5	97.7	

Modulation Calibration Parameters

UID	Communication System Name		A dB	B dB $\sqrt{\mu\text{V}}$	C	D dB	VR mV	Unc ^E (k=2)
0	CW	X	0.0	0.0	1.0	0.00	131.7	$\pm 3.5\%$
		Y	0.0	0.0	1.0		140.3	
		Z	0.0	0.0	1.0		136.8	
10010- CAA	SAR Validation (Square, 100ms, 10ms)	X	0.94	56.5	8.3	10.00	38.1	$\pm 0.7\%$
		Y	2.14	63.7	12.2		41.6	
		Z	3.89	70.9	15.1		40.9	
10012- CAB	IEEE 802.11b WiFi 2.4 GHz (DSSS, 1 Mbps)	X	2.91	68.2	18.0	1.87	142.7	$\pm 0.7\%$
		Y	2.48	64.3	15.8		132.6	
		Z	2.61	65.8	16.8		129.2	
10013- CAB	IEEE 802.11g WiFi 2.4 GHz (DSSS-OFDM, 6 Mbps)	X	10.41	69.4	22.2	9.46	149.3	$\pm 3.5\%$
		Y	10.78	69.4	22.2		146.4	
		Z	10.76	69.7	22.6		141.9	
10032- CAA	IEEE 802.15.1 Bluetooth (GFSK, DH5)	X	0.29	58.3	5.2	1.16	136.2	$\pm 0.7\%$
		Y	0.52	61.5	7.4		149.5	
		Z	0.99	66.7	9.6		146.5	
10062- CAB	IEEE 802.11a/h WiFi 5 GHz (OFDM, 6 Mbps)	X	9.78	68.2	21.1	8.68	126.2	$\pm 3.3\%$
		Y	10.40	68.9	21.4		145.8	
		Z	10.43	69.3	21.9		146.6	
10103- CAB	LTE-TDD (SC-FDMA, 100% RB, 20 MHz, QPSK)	X	7.49	68.0	21.7	9.29	145.0	$\pm 2.2\%$
		Y	7.76	68.0	21.7		137.3	
		Z	8.12	69.7	22.9		139.5	
10117- CAB	IEEE 802.11n (HT Mixed, 13.5 Mbps, BPSK)	X	10.08	68.6	20.8	8.07	140.7	$\pm 3.0\%$
		Y	10.01	67.8	20.3		129.1	
		Z	10.13	68.3	20.8		130.9	
10151- CAB	LTE-TDD (SC-FDMA, 50% RB, 20 MHz, QPSK)	X	7.12	67.7	21.7	9.28	140.0	$\pm 2.2\%$
		Y	7.42	67.6	21.5		133.0	
		Z	7.70	69.2	22.8		135.2	
10172- CAB	LTE-TDD (SC-FDMA, 1 RB, 20 MHz, QPSK)	X	5.55	68.8	22.5	9.21	129.9	$\pm 2.7\%$
		Y	6.01	69.1	22.6		144.5	
		Z	6.16	70.6	23.9		146.7	
10196- CAB	IEEE 802.11n (HT Mixed, 6.5 Mbps, BPSK)	X	9.56	68.2	20.7	8.10	132.3	$\pm 3.0\%$
		Y	10.09	68.7	20.9		149.9	
		Z	10.08	69.0	21.3		147.9	
10237- CAB	LTE-TDD (SC-FDMA, 1 RB, 10 MHz, QPSK)	X	5.60	69.2	22.8	9.21	133.6	$\pm 2.7\%$
		Y	6.05	69.3	22.7		145.6	
		Z	6.15	70.5	23.9		147.8	

10252-CAB	LTE-TDD (SC-FDMA, 50% RB, 10 MHz, QPSK)	X	6.68	67.3	21.6	9.24	133.4	±2.7 %
		Y	7.19	68.0	21.9		147.8	
		Z	7.38	69.3	23.0		147.7	
10267-CAB	LTE-TDD (SC-FDMA, 100% RB, 10 MHz, QPSK)	X	7.14	67.7	21.8	9.30	139.9	±2.2 %
		Y	7.44	67.6	21.5		133.0	
		Z	7.68	69.1	22.7		131.5	
10317-AAB	IEEE 802.11a WiFi 5 GHz (OFDM, 6 Mbps, 96pc duty cycle)	X	9.72	68.3	21.0	8.36	132.1	±3.3 %
		Y	10.25	68.8	21.2		148.1	
		Z	10.27	69.2	21.6		148.7	
10400-AAB	IEEE 802.11ac WiFi (20MHz, 64-QAM, 99pc duty cycle)	X	9.78	68.3	20.9	8.37	131.9	±3.3 %
		Y	9.97	67.9	20.7		125.1	
		Z	10.36	69.3	21.7		148.4	
10401-AAB	IEEE 802.11ac WiFi (40MHz, 64-QAM, 99pc duty cycle)	X	10.63	68.9	21.2	8.60	142.5	±3.0 %
		Y	10.72	68.6	21.0		133.5	
		Z	10.74	68.8	21.4		133.0	
10402-AAB	IEEE 802.11ac WiFi (80MHz, 64-QAM, 99pc duty cycle)	X	10.89	69.3	21.2	8.53	145.0	±3.3 %
		Y	10.70	68.4	20.8		133.2	
		Z	10.95	69.2	21.4		134.0	
10415-AAA	IEEE 802.11b WiFi 2.4 GHz (DSSS, 1 Mbps, 99pc duty cycle)	X	2.84	68.2	17.9	1.54	141.1	±0.5 %
		Y	2.39	64.2	15.6		130.2	
		Z	2.63	66.6	17.2		128.6	
10416-AAA	IEEE 802.11g WiFi 2.4 GHz (ERP-OFDM, 6 Mbps, 99pc duty cycle)	X	9.67	68.3	20.9	8.23	131.6	±3.3 %
		Y	10.14	68.6	21.0		147.9	
		Z	10.17	69.1	21.5		148.5	
10417-AAA	IEEE 802.11a/h WiFi 5 GHz (OFDM, 6 Mbps, 99pc duty cycle)	X	9.67	68.3	20.9	8.23	133.0	±3.3 %
		Y	9.78	67.7	20.5		124.4	
		Z	10.21	69.1	21.5		149.4	

The reported uncertainty of measurement is stated as the standard uncertainty of measurement multiplied by the coverage factor $k=2$, which for a normal distribution corresponds to a coverage probability of approximately 95%.

^A The uncertainties of NormX,Y,Z do not affect the E^2 -field uncertainty inside TSL (see Pages 6 and 7).

^B Numerical linearization parameter: uncertainty not required.

^E Uncertainty is determined using the max. deviation from linear response applying rectangular distribution and is expressed for the square of the field value.

DASY/EASY - Parameters of Probe: EX3DV4 - SN:3920

Calibration Parameter Determined in Head Tissue Simulating Media

f (MHz) ^C	Relative Permittivity ^F	Conductivity (S/m) ^F	ConvF X	ConvF Y	ConvF Z	Alpha ^G	Depth ^G (mm)	Unct. (k=2)
2450	39.2	1.80	7.12	7.12	7.12	0.62	0.65	± 12.0 %
2600	39.0	1.96	6.85	6.85	6.85	0.36	0.86	± 12.0 %
5200	36.0	4.66	4.87	4.87	4.87	0.35	1.80	± 13.1 %
5300	35.9	4.76	4.69	4.69	4.69	0.35	1.80	± 13.1 %
5500	35.6	4.96	4.44	4.44	4.44	0.40	1.80	± 13.1 %
5600	35.5	5.07	4.35	4.35	4.35	0.40	1.80	± 13.1 %
5800	35.3	5.27	4.27	4.27	4.27	0.40	1.80	± 13.1 %

^C Frequency validity above 300 MHz of ± 100 MHz only applies for DASY v4.4 and higher (see Page 2), else it is restricted to ± 50 MHz. The uncertainty is the RSS of the ConvF uncertainty at calibration frequency and the uncertainty for the indicated frequency band. Frequency validity below 300 MHz is ± 10, 25, 40, 50 and 70 MHz for ConvF assessments at 30, 64, 128, 150 and 220 MHz respectively. Above 5 GHz frequency validity can be extended to ± 110 MHz.

^F At frequencies below 3 GHz, the validity of tissue parameters (ϵ and σ) can be relaxed to ± 10% if liquid compensation formula is applied to measured SAR values. At frequencies above 3 GHz, the validity of tissue parameters (ϵ and σ) is restricted to ± 5%. The uncertainty is the RSS of the ConvF uncertainty for indicated target tissue parameters.

^G Alpha/Depth are determined during calibration. SPEAG warrants that the remaining deviation due to the boundary effect after compensation is always less than ± 1% for frequencies below 3 GHz and below ± 2% for frequencies between 3-6 GHz at any distance larger than half the probe tip diameter from the boundary.

DASY/EASY - Parameters of Probe: EX3DV4 - SN:3920

Calibration Parameter Determined in Body Tissue Simulating Media

f (MHz) ^C	Relative Permittivity ^F	Conductivity (S/m) ^F	ConvF X	ConvF Y	ConvF Z	Alpha ^G	Depth ^G (mm)	Unct. (k=2)
2450	52.7	1.95	7.02	7.02	7.02	0.80	0.50	± 12.0 %
2600	52.5	2.16	6.78	6.78	6.78	0.80	0.50	± 12.0 %
5200	49.0	5.30	4.33	4.33	4.33	0.45	1.90	± 13.1 %
5300	48.9	5.42	4.16	4.16	4.16	0.45	1.90	± 13.1 %
5500	48.6	5.65	3.79	3.79	3.79	0.50	1.90	± 13.1 %
5600	48.5	5.77	3.66	3.66	3.66	0.50	1.90	± 13.1 %
5800	48.2	6.00	3.93	3.93	3.93	0.50	1.90	± 13.1 %

^C Frequency validity above 300 MHz of ± 100 MHz only applies for DASY v4.4 and higher (see Page 2), else it is restricted to ± 50 MHz. The uncertainty is the RSS of the ConvF uncertainty at calibration frequency and the uncertainty for the indicated frequency band. Frequency validity below 300 MHz is ± 10, 25, 40, 50 and 70 MHz for ConvF assessments at 30, 64, 128, 150 and 220 MHz respectively. Above 5 GHz frequency validity can be extended to ± 110 MHz.

^F At frequencies below 3 GHz, the validity of tissue parameters (ϵ and σ) can be relaxed to ± 10% if liquid compensation formula is applied to measured SAR values. At frequencies above 3 GHz, the validity of tissue parameters (ϵ and σ) is restricted to ± 5%. The uncertainty is the RSS of the ConvF uncertainty for indicated target tissue parameters.

^G Alpha/Depth are determined during calibration. SPEAG warrants that the remaining deviation due to the boundary effect after compensation is always less than ± 1% for frequencies below 3 GHz and below ± 2% for frequencies between 3-6 GHz at any distance larger than half the probe tip diameter from the boundary.

Frequency Response of E-Field

(TEM-Cell:ifi110 EXX, Waveguide: R22)

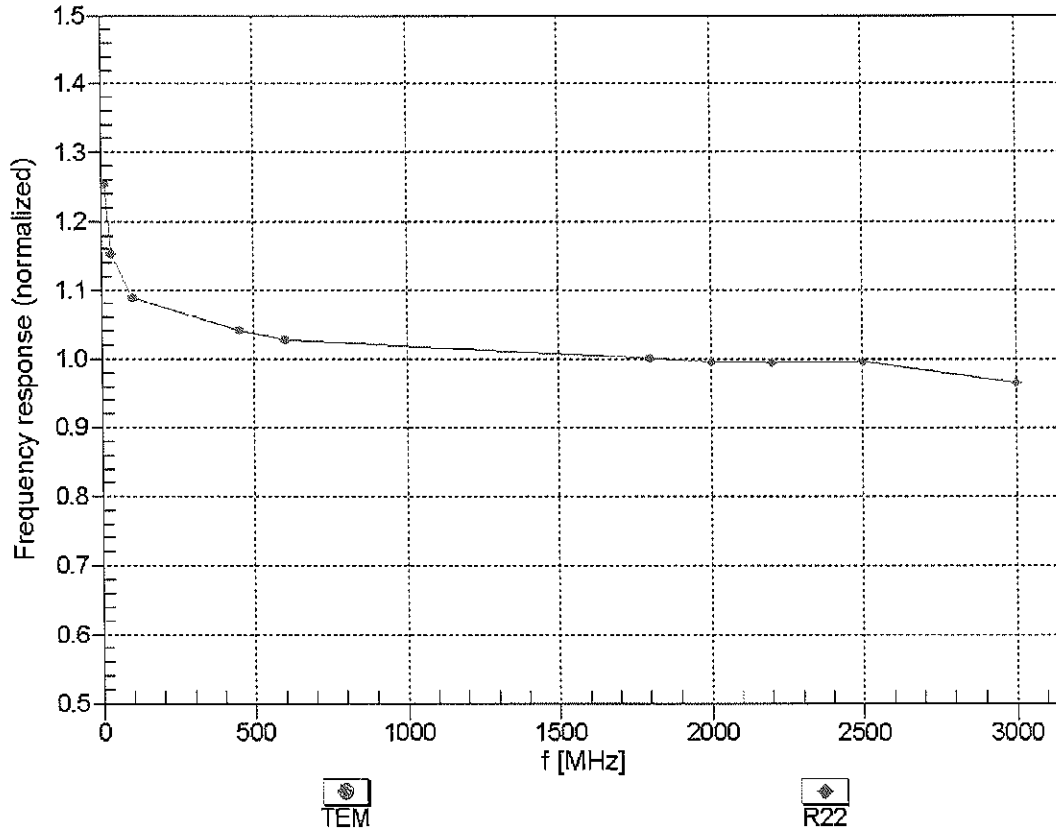

Uncertainty of Frequency Response of E-field: $\pm 6.3\%$ (k=2)

Receiving Pattern (ϕ), $\vartheta = 0^\circ$

f=600 MHz,TEM

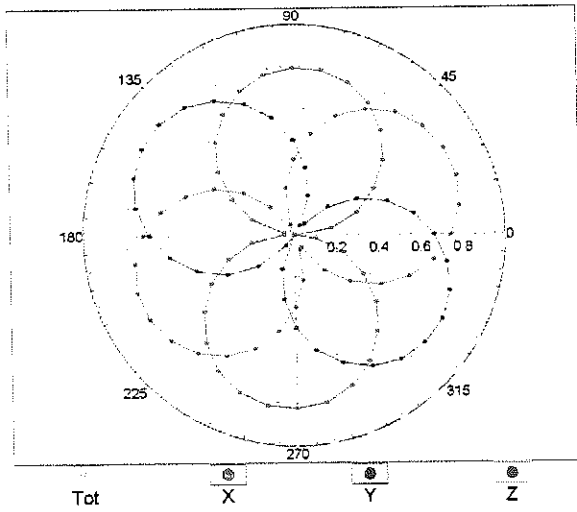

f=1800 MHz,R22

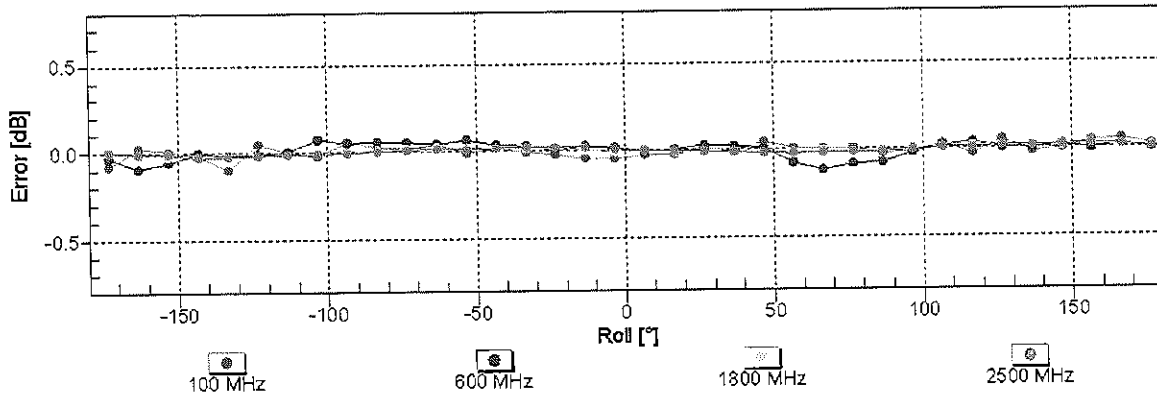
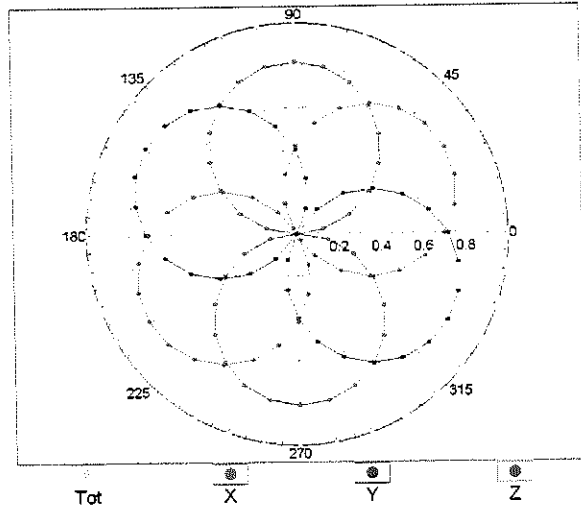

Uncertainty of Axial Isotropy Assessment: $\pm 0.5\%$ (k=2)

Dynamic Range f(SAR_{head})

(TEM cell , f_{eval}= 1900 MHz)

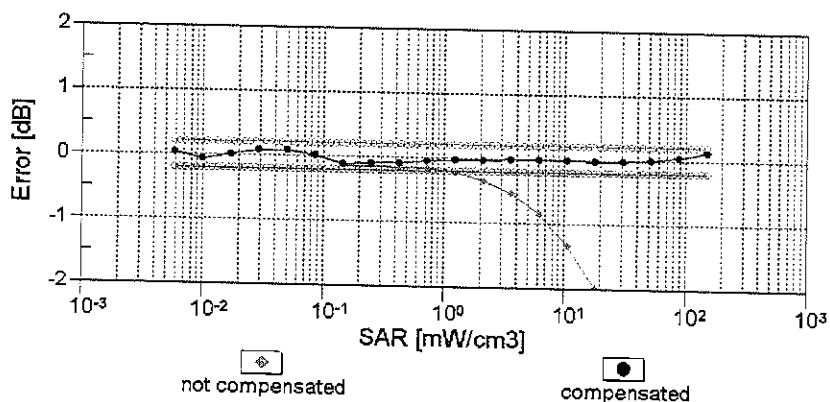
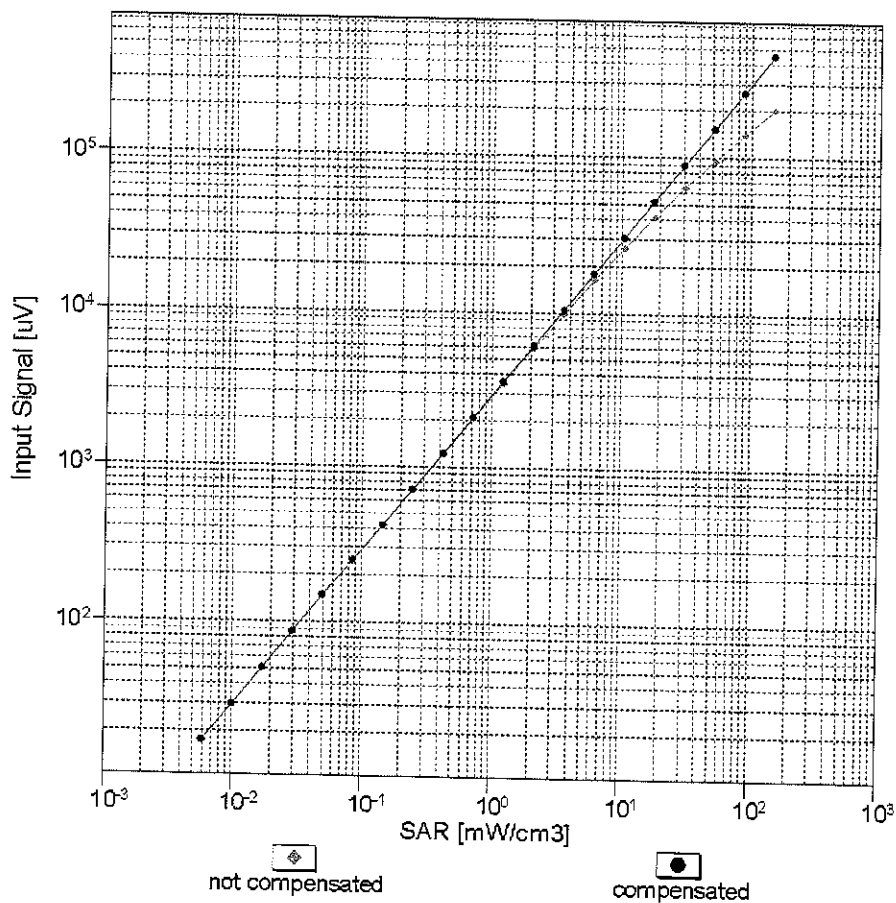

Uncertainty of Linearity Assessment: ± 0.6% (k=2)

Conversion Factor Assessment

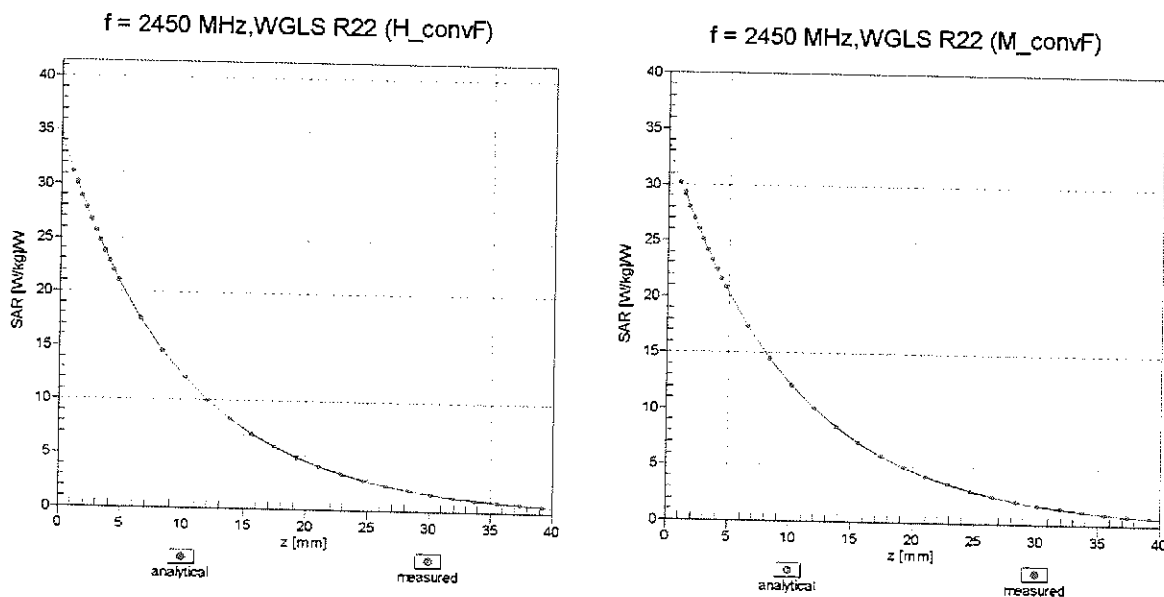

Deviation from Isotropy in Liquid

Error (ϕ, θ), f = 900 MHz

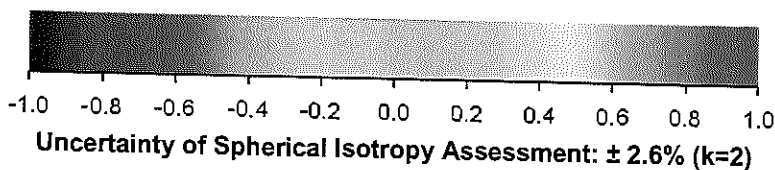
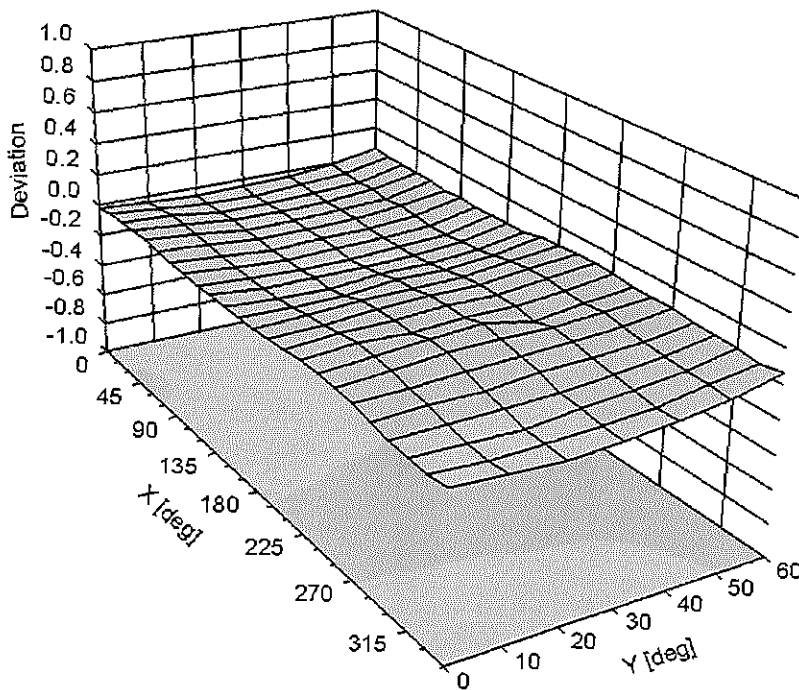

DASY/EASY - Parameters of Probe: EX3DV4 - SN:3920

Other Probe Parameters

Sensor Arrangement	Triangular
Connector Angle (°)	-23.3
Mechanical Surface Detection Mode	enabled
Optical Surface Detection Mode	disabled
Probe Overall Length	337 mm
Probe Body Diameter	10 mm
Tip Length	9 mm
Tip Diameter	2.5 mm
Probe Tip to Sensor X Calibration Point	1 mm
Probe Tip to Sensor Y Calibration Point	1 mm
Probe Tip to Sensor Z Calibration Point	1 mm
Recommended Measurement Distance from Surface	1.4 mm



Accredited by the Swiss Accreditation Service (SAS)
The Swiss Accreditation Service is one of the signatories to the EA
Multilateral Agreement for the recognition of calibration certificates

Accreditation No.: **SCS 108**

Client **PC Test**

Certificate No: **ES3-3263_May14**

CALIBRATION CERTIFICATE

Object **ES3DV3 - SN:3263**

Calibration procedure(s) **QA CAL-01.v9, QA CAL-23.v5, QA CAL-25.v6
Calibration procedure for dosimetric E-field probes**

OCV
7/17/14

Calibration date: **May 15, 2014**

This calibration certificate documents the traceability to national standards, which realize the physical units of measurements (SI).
The measurements and the uncertainties with confidence probability are given on the following pages and are part of the certificate.

All calibrations have been conducted in the closed laboratory facility: environment temperature (22 ± 3)°C and humidity < 70%.

Calibration Equipment used (M&TE critical for calibration)

Primary Standards	ID	Cal Date (Certificate No.)	Scheduled Calibration
Power meter E4419B	GB41293874	03-Apr-14 (No. 217-01911)	Apr-15
Power sensor E4412A	MY41498087	03-Apr-14 (No. 217-01911)	Apr-15
Reference 3 dB Attenuator	SN: S5054 (3c)	03-Apr-14 (No. 217-01915)	Apr-15
Reference 20 dB Attenuator	SN: S5277 (20x)	03-Apr-14 (No. 217-01919)	Apr-15
Reference 30 dB Attenuator	SN: S5129 (30b)	03-Apr-14 (No. 217-01920)	Apr-15
Reference Probe ES3DV2	SN: 3013	30-Dec-13 (No. ES3-3013_Dec13)	Dec-14
DAE4	SN: 660	13-Dec-13 (No. DAE4-660_Dec13)	Dec-14
Secondary Standards	ID	Check Date (in house)	Scheduled Check
RF generator HP 8648C	US3642U01700	4-Aug-99 (in house check Apr-13)	In house check: Apr-16
Network Analyzer HP 8753E	US37390585	18-Oct-01 (in house check Oct-13)	In house check: Oct-14

	Name	Function	Signature
Calibrated by:	Jeton Kastrati	Laboratory Technician	
Approved by:	Katja Pokovic	Technical Manager	
			Issued: May 15, 2014

This calibration certificate shall not be reproduced except in full without written approval of the laboratory.



Accredited by the Swiss Accreditation Service (SAS)
The Swiss Accreditation Service is one of the signatories to the EA
Multilateral Agreement for the recognition of calibration certificates

Accreditation No.: **SCS 108**

Glossary:

TSL	tissue simulating liquid
NORM _{x,y,z}	sensitivity in free space
ConvF	sensitivity in TSL / NORM _{x,y,z}
DCP	diode compression point
CF	crest factor (1/duty_cycle) of the RF signal
A, B, C, D	modulation dependent linearization parameters
Polarization φ	φ rotation around probe axis
Polarization ϑ	ϑ rotation around an axis that is in the plane normal to probe axis (at measurement center), i.e., $\vartheta = 0$ is normal to probe axis
Connector Angle	information used in DASY system to align probe sensor X to the robot coordinate system

Calibration is Performed According to the Following Standards:

- IEEE Std 1528-2013, "IEEE Recommended Practice for Determining the Peak Spatial-Averaged Specific Absorption Rate (SAR) in the Human Head from Wireless Communications Devices: Measurement Techniques", June 2013
- IEC 62209-1, "Procedure to measure the Specific Absorption Rate (SAR) for hand-held devices used in close proximity to the ear (frequency range of 300 MHz to 3 GHz)", February 2005

Methods Applied and Interpretation of Parameters:

- NORM_{x,y,z}**: Assessed for E-field polarization $\vartheta = 0$ ($f \leq 900$ MHz in TEM-cell; $f > 1800$ MHz: R22 waveguide). NORM_{x,y,z} are only intermediate values, i.e., the uncertainties of NORM_{x,y,z} does not affect the E²-field uncertainty inside TSL (see below *ConvF*).
- NORM(f)_{x,y,z} = NORM_{x,y,z} * frequency_response** (see Frequency Response Chart). This linearization is implemented in DASY4 software versions later than 4.2. The uncertainty of the frequency response is included in the stated uncertainty of *ConvF*.
- DCP_{x,y,z}**: DCP are numerical linearization parameters assessed based on the data of power sweep with CW signal (no uncertainty required). DCP does not depend on frequency nor media.
- PAR**: PAR is the Peak to Average Ratio that is not calibrated but determined based on the signal characteristics
- A_{x,y,z}; B_{x,y,z}; C_{x,y,z}; D_{x,y,z}; VR_{x,y,z}**: A, B, C, D are numerical linearization parameters assessed based on the data of power sweep for specific modulation signal. The parameters do not depend on frequency nor media. VR is the maximum calibration range expressed in RMS voltage across the diode.
- ConvF and Boundary Effect Parameters**: Assessed in flat phantom using E-field (or Temperature Transfer Standard for $f \leq 800$ MHz) and inside waveguide using analytical field distributions based on power measurements for $f > 800$ MHz. The same setups are used for assessment of the parameters applied for boundary compensation (alpha, depth) of which typical uncertainty values are given. These parameters are used in DASY4 software to improve probe accuracy close to the boundary. The sensitivity in TSL corresponds to NORM_{x,y,z} * ConvF whereby the uncertainty corresponds to that given for ConvF. A frequency dependent ConvF is used in DASY version 4.4 and higher which allows extending the validity from ± 50 MHz to ± 100 MHz.
- Spherical isotropy (3D deviation from isotropy)**: in a field of low gradients realized using a flat phantom exposed by a patch antenna.
- Sensor Offset**: The sensor offset corresponds to the offset of virtual measurement center from the probe tip (on probe axis). No tolerance required.
- Connector Angle**: The angle is assessed using the information gained by determining the NORM_x (no uncertainty required).

Probe ES3DV3

SN:3263

Manufactured: January 25, 2010
Calibrated: May 15, 2014

Calibrated for DASY/EASY Systems
(Note: non-compatible with DASY2 system!)

DASY/EASY - Parameters of Probe: ES3DV3 - SN:3263

Basic Calibration Parameters

	Sensor X	Sensor Y	Sensor Z	Unc (k=2)
Norm ($\mu\text{V}/(\text{V}/\text{m})^2$) ^A	1.21	1.24	1.13	$\pm 10.1\%$
DCP (mV) ^B	103.8	102.3	104.7	

Modulation Calibration Parameters

UID	Communication System Name		A dB	B dB $\sqrt{\mu\text{V}}$	C	D dB	VR mV	Unc ^E (k=2)
0	CW	X	0.0	0.0	1.0	0.00	156.3	$\pm 3.5\%$
		Y	0.0	0.0	1.0		203.1	
		Z	0.0	0.0	1.0		197.2	
10010- CAA	SAR Validation (Square, 100ms, 10ms)	X	2.33	59.4	10.8	10.00	46.4	$\pm 1.4\%$
		Y	4.39	63.4	13.6		50.8	
		Z	1.35	55.5	7.8		39.6	
10011- CAB	UMTS-FDD (WCDMA)	X	3.49	68.2	19.1	2.91	126.7	$\pm 0.7\%$
		Y	3.28	66.9	18.5		120.7	
		Z	2.74	63.1	15.1		113.5	
10012- CAA	IEEE 802.11b WiFi 2.4 GHz (DSSS, 1 Mbps)	X	3.51	72.0	20.3	1.87	127.9	$\pm 0.7\%$
		Y	3.21	69.4	18.8		124.1	
		Z	1.93	60.6	12.6		113.3	
10013- CAA	IEEE 802.11g WiFi 2.4 GHz (DSSS-OFDM, 6 Mbps)	X	11.30	70.8	23.3	9.46	125.2	$\pm 2.5\%$
		Y	12.42	72.7	24.4		129.4	
		Z	10.03	67.8	21.1		105.5	
10021- DAB	GSM-FDD (TDMA, GMSK)	X	24.45	99.1	27.6	9.39	141.4	$\pm 1.4\%$
		Y	29.93	99.5	29.0		124.5	
		Z	4.53	73.0	18.1		111.6	
10023- DAB	GPRS-FDD (TDMA, GMSK, TN 0)	X	25.10	99.7	27.9	9.57	134.2	$\pm 1.9\%$
		Y	24.85	96.1	28.0		120.2	
		Z	5.99	76.5	19.1		142.5	
10024- DAB	GPRS-FDD (TDMA, GMSK, TN 0-1)	X	24.34	93.0	23.0	6.56	117.1	$\pm 1.4\%$
		Y	26.49	92.6	24.2		148.7	
		Z	4.00	69.6	13.8		136.6	
10027- DAB	GPRS-FDD (TDMA, GMSK, TN 0-1-2)	X	51.24	99.9	23.5	4.80	131.1	$\pm 1.9\%$
		Y	56.83	99.5	24.3		101.8	
		Z	1.70	61.4	9.1		107.7	
10028- DAB	GPRS-FDD (TDMA, GMSK, TN 0-1-2-3)	X	60.12	99.6	22.2	3.55	138.7	$\pm 1.9\%$
		Y	64.73	99.9	23.4		105.5	
		Z	1.13	58.4	6.0		116.0	
10032- CAA	IEEE 802.15.1 Bluetooth (GFSK, DH5)	X	77.27	99.6	19.6	1.16	149.5	$\pm 2.5\%$
		Y	60.44	99.7	21.0		109.4	
		Z	0.34	55.9	2.9		131.4	
10039- CAB	CDMA2000 (1xRTT, RC1)	X	4.79	66.8	19.0	4.57	124.5	$\pm 0.9\%$
		Y	4.85	66.4	18.8		125.6	
		Z	4.06	63.4	16.1		108.1	

10081-CAB	CDMA2000 (1xRTT, RC3)	X	3.93	66.1	18.5	3.97	119.8	±0.7 %
		Y	3.90	65.5	18.2		120.1	
		Z	3.29	62.4	15.3		108.5	
10098-CAB	UMTS-FDD (HSUPA, Subtest 2)	X	4.68	66.9	18.7	3.98	131.2	±0.7 %
		Y	4.64	66.6	18.6		130.5	
		Z	4.15	64.5	16.5		118.8	
10100-CAB	LTE-FDD (SC-FDMA, 100% RB, 20 MHz, QPSK)	X	6.61	68.1	20.0	5.67	137.5	±1.7 %
		Y	6.70	68.4	20.2		137.7	
		Z	5.90	65.6	17.9		124.0	
10108-CAB	LTE-FDD (SC-FDMA, 100% RB, 10 MHz, QPSK)	X	6.44	67.5	19.8	5.80	135.1	±1.7 %
		Y	6.60	68.0	20.1		135.4	
		Z	5.75	64.9	17.6		121.8	
10110-CAB	LTE-FDD (SC-FDMA, 100% RB, 5 MHz, QPSK)	X	6.14	67.1	19.7	5.75	131.6	±1.2 %
		Y	6.28	67.4	19.9		132.7	
		Z	5.62	65.5	18.2		118.4	
10114-CAA	IEEE 802.11n (HT Greenfield, 13.5 Mbps, BPSK)	X	10.18	68.8	21.2	8.10	124.3	±1.9 %
		Y	10.60	69.7	21.8		126.2	
		Z	9.38	67.0	19.8		108.4	
10117-CAA	IEEE 802.11n (HT Mixed, 13.5 Mbps, BPSK)	X	10.23	68.9	21.3	8.07	125.0	±1.9 %
		Y	10.56	69.6	21.7		127.1	
		Z	9.37	67.1	19.8		109.1	
10151-CAB	LTE-TDD (SC-FDMA, 50% RB, 20 MHz, QPSK)	X	10.23	75.7	26.0	9.28	125.0	±2.7 %
		Y	14.60	83.3	29.5		147.3	
		Z	8.05	69.7	22.3		106.3	
10154-CAB	LTE-FDD (SC-FDMA, 50% RB, 10 MHz, QPSK)	X	6.12	67.0	19.6	5.75	131.6	±1.4 %
		Y	6.28	67.4	19.9		132.4	
		Z	5.49	64.7	17.4		117.9	
10160-CAB	LTE-FDD (SC-FDMA, 50% RB, 15 MHz, QPSK)	X	6.57	67.5	19.8	5.82	136.0	±1.4 %
		Y	6.71	67.9	20.1		137.1	
		Z	5.89	65.2	17.8		122.4	
10169-CAB	LTE-FDD (SC-FDMA, 1 RB, 20 MHz, QPSK)	X	4.82	66.0	19.3	5.73	113.5	±1.4 %
		Y	5.12	66.3	19.4		116.6	
		Z	4.75	65.9	18.3		142.7	
10172-CAB	LTE-TDD (SC-FDMA, 1 RB, 20 MHz, QPSK)	X	9.53	80.6	28.6	9.21	136.5	±2.2 %
		Y	11.32	81.6	28.8		109.2	
		Z	6.84	72.0	23.8		117.3	
10175-CAB	LTE-FDD (SC-FDMA, 1 RB, 10 MHz, QPSK)	X	4.86	66.2	19.4	5.72	112.9	±1.2 %
		Y	5.10	66.2	19.4		115.9	
		Z	4.55	64.9	17.8		137.7	
10181-CAB	LTE-FDD (SC-FDMA, 1 RB, 15 MHz, QPSK)	X	4.81	66.0	19.2	5.72	111.6	±1.2 %
		Y	5.13	66.4	19.5		116.1	
		Z	4.70	65.7	18.3		137.1	
10193-CAA	IEEE 802.11n (HT Greenfield, 6.5 Mbps, BPSK)	X	9.80	68.3	21.0	8.09	117.2	±2.2 %
		Y	10.23	69.1	21.6		121.5	
		Z	9.85	68.9	20.8		148.4	

10196-CAA	IEEE 802.11n (HT Mixed, 6.5 Mbps, BPSK)	X	9.81	68.4	21.1	8.10	117.7	±2.2 %
		Y	10.23	69.2	21.6		121.7	
		Z	9.87	69.0	20.9		149.9	
10219-CAA	IEEE 802.11n (HT Mixed, 7.2 Mbps, BPSK)	X	9.71	68.3	21.0	8.03	117.8	±2.2 %
		Y	10.12	69.1	21.6		121.0	
		Z	8.90	66.6	19.6		104.1	
10222-CAA	IEEE 802.11n (HT Mixed, 15 Mbps, BPSK)	X	10.14	68.7	21.2	8.06	122.3	±1.9 %
		Y	10.52	69.5	21.7		125.4	
		Z	9.28	66.8	19.6		108.5	
10225-CAB	UMTS-FDD (HSPA+)	X	7.25	67.8	19.9	5.97	146.3	±1.7 %
		Y	7.32	67.5	19.8		149.3	
		Z	6.52	65.7	18.0		130.7	
10237-CAB	LTE-TDD (SC-FDMA, 1 RB, 10 MHz, QPSK)	X	9.55	80.7	28.7	9.21	137.2	±2.5 %
		Y	11.34	81.7	28.9		109.9	
		Z	6.98	72.5	24.0		119.5	
10252-CAB	LTE-TDD (SC-FDMA, 50% RB, 10 MHz, QPSK)	X	9.26	74.1	25.3	9.24	115.6	±3.3 %
		Y	13.72	82.5	29.3		137.9	
		Z	8.83	73.3	24.4		144.1	
10267-CAB	LTE-TDD (SC-FDMA, 100% RB, 10 MHz, QPSK)	X	10.06	75.2	25.8	9.30	122.9	±2.7 %
		Y	14.69	83.4	29.6		147.6	
		Z	8.02	69.6	22.3		103.4	
10274-CAB	UMTS-FDD (HSUPA, Subtest 5, 3GPP Rel8.10)	X	6.08	67.2	19.0	4.87	140.2	±1.2 %
		Y	6.23	67.5	19.2		143.5	
		Z	5.52	65.4	17.4		125.1	
10275-CAB	UMTS-FDD (HSUPA, Subtest 5, 3GPP Rel8.4)	X	4.44	66.7	18.7	3.96	122.1	±0.7 %
		Y	4.39	66.3	18.5		124.4	
		Z	3.83	63.7	16.0		114.0	
10291-AAB	CDMA2000, RC3, SO55, Full Rate	X	3.64	66.7	18.6	3.46	115.7	±0.7 %
		Y	3.60	66.0	18.2		118.0	
		Z	3.17	64.2	16.3		108.4	
10292-AAB	CDMA2000, RC3, SO32, Full Rate	X	3.62	67.0	18.8	3.39	116.9	±0.9 %
		Y	3.54	66.1	18.2		119.1	
		Z	3.24	64.2	15.8		145.6	
10297-AAA	LTE-FDD (SC-FDMA, 50% RB, 20 MHz, QPSK)	X	6.43	67.5	19.8	5.81	132.0	±1.4 %
		Y	6.60	68.0	20.1		134.9	
		Z	5.81	65.4	18.0		115.0	
10311-AAA	LTE-FDD (SC-FDMA, 100% RB, 15 MHz, QPSK)	X	7.04	68.1	20.2	6.06	137.5	±1.4 %
		Y	7.19	68.6	20.5		140.3	
		Z	6.26	65.7	18.2		119.6	
10315-AAA	IEEE 802.11b WiFi 2.4 GHz (DSSS, 1 Mbps, 96pc duty cycle)	X	3.05	70.0	19.4	1.71	121.7	±0.7 %
		Y	2.91	68.7	18.7		123.4	
		Z	1.83	60.2	12.3		108.4	
10316-AAA	IEEE 802.11g WiFi 2.4 GHz (ERP-OFDM, 6 Mbps, 96pc duty cycle)	X	10.05	68.7	21.4	8.36	117.3	±1.9 %
		Y	10.57	69.7	22.0		122.8	
		Z	9.11	66.5	19.7		103.1	

10403-AAB	CDMA2000 (1xEV-DO, Rev. 0)	X	4.81	68.3	18.8	3.76	125.8	±0.7 %
		Y	4.65	66.5	18.1		130.8	
		Z	3.98	64.7	16.0		114.7	
10404-AAB	CDMA2000 (1xEV-DO, Rev. A)	X	4.91	69.1	19.2	3.77	123.3	±0.7 %
		Y	4.60	66.6	18.1		128.5	
		Z	3.73	64.0	15.4		112.0	
10415-AAA	IEEE 802.11b WiFi 2.4 GHz (DSSS, 1 Mbps, 99pc duty cycle)	X	2.78	69.0	19.0	1.54	121.9	±0.7 %
		Y	2.46	66.8	17.9		122.5	
		Z	1.83	60.9	13.0		112.4	
10416-AAA	IEEE 802.11g WiFi 2.4 GHz (ERP-OFDM, 6 Mbps, 99pc duty cycle)	X	9.88	68.4	21.2	8.23	116.6	±1.7 %
		Y	10.29	69.2	21.7		121.5	
		Z	9.25	67.3	20.2		103.4	

The reported uncertainty of measurement is stated as the standard uncertainty of measurement multiplied by the coverage factor $k=2$, which for a normal distribution corresponds to a coverage probability of approximately 95%.

^A The uncertainties of NormX,Y,Z do not affect the E^2 -field uncertainty inside TSL (see Pages 8 and 9).

^B Numerical linearization parameter: uncertainty not required.

^E Uncertainty is determined using the max. deviation from linear response applying rectangular distribution and is expressed for the square of the field value.

DASY/EASY - Parameters of Probe: ES3DV3 - SN:3263

Calibration Parameter Determined in Head Tissue Simulating Media

f (MHz) ^C	Relative Permittivity ^F	Conductivity (S/m) ^F	ConvF X	ConvF Y	ConvF Z	Alpha ^G	Depth ^G (mm)	Unct. (k=2)
750	41.9	0.89	6.42	6.42	6.42	0.72	1.18	± 12.0 %
835	41.5	0.90	6.23	6.23	6.23	0.27	2.02	± 12.0 %
1750	40.1	1.37	5.41	5.41	5.41	0.74	1.23	± 12.0 %
1900	40.0	1.40	5.08	5.08	5.08	0.80	1.16	± 12.0 %
2450	39.2	1.80	4.47	4.47	4.47	0.80	1.22	± 12.0 %
2600	39.0	1.96	4.33	4.33	4.33	0.66	1.41	± 12.0 %

^C Frequency validity of ± 100 MHz only applies for DASY v4.4 and higher (see Page 2), else it is restricted to ± 50 MHz. The uncertainty is the RSS of the ConvF uncertainty at calibration frequency and the uncertainty for the indicated frequency band.

^F At frequencies below 3 GHz, the validity of tissue parameters (ϵ and σ) can be relaxed to ± 10% if liquid compensation formula is applied to measured SAR values. At frequencies above 3 GHz, the validity of tissue parameters (ϵ and σ) is restricted to ± 5%. The uncertainty is the RSS of the ConvF uncertainty for indicated target tissue parameters.

^G Alpha/Depth are determined during calibration. SPEAG warrants that the remaining deviation due to the boundary effect after compensation is always less than ± 1% for frequencies below 3 GHz and below ± 2% for frequencies between 3-6 GHz at any distance larger than half the probe tip diameter from the boundary.

DASY/EASY - Parameters of Probe: ES3DV3 - SN:3263

Calibration Parameter Determined in Body Tissue Simulating Media

f (MHz) ^C	Relative Permittivity ^F	Conductivity (S/m) ^F	ConvF X	ConvF Y	ConvF Z	Alpha ^G	Depth (mm) ^G	Unct. (k=2)
750	55.5	0.96	6.19	6.19	6.19	0.52	1.41	± 12.0 %
835	55.2	0.97	6.16	6.16	6.16	0.68	1.28	± 12.0 %
1750	53.4	1.49	4.98	4.98	4.98	0.38	1.91	± 12.0 %
1900	53.3	1.52	4.78	4.78	4.78	0.66	1.35	± 12.0 %
2450	52.7	1.95	4.27	4.27	4.27	0.72	1.13	± 12.0 %
2600	52.5	2.16	4.11	4.11	4.11	0.74	1.07	± 12.0 %

^C Frequency validity of ± 100 MHz only applies for DASY v4.4 and higher (see Page 2), else it is restricted to ± 50 MHz. The uncertainty is the RSS of the ConvF uncertainty at calibration frequency and the uncertainty for the indicated frequency band.

^F At frequencies below 3 GHz, the validity of tissue parameters (ϵ and σ) can be relaxed to ± 10% if liquid compensation formula is applied to measured SAR values. At frequencies above 3 GHz, the validity of tissue parameters (ϵ and σ) is restricted to ± 5%. The uncertainty is the RSS of the ConvF uncertainty for indicated target tissue parameters.

^G Alpha/Depth are determined during calibration. SPEAG warrants that the remaining deviation due to the boundary effect after compensation is always less than ± 1% for frequencies below 3 GHz and below ± 2% for frequencies between 3-6 GHz at any distance larger than half the probe tip diameter from the boundary.

Frequency Response of E-Field (TEM-Cell:ifi110 EXX, Waveguide: R22)

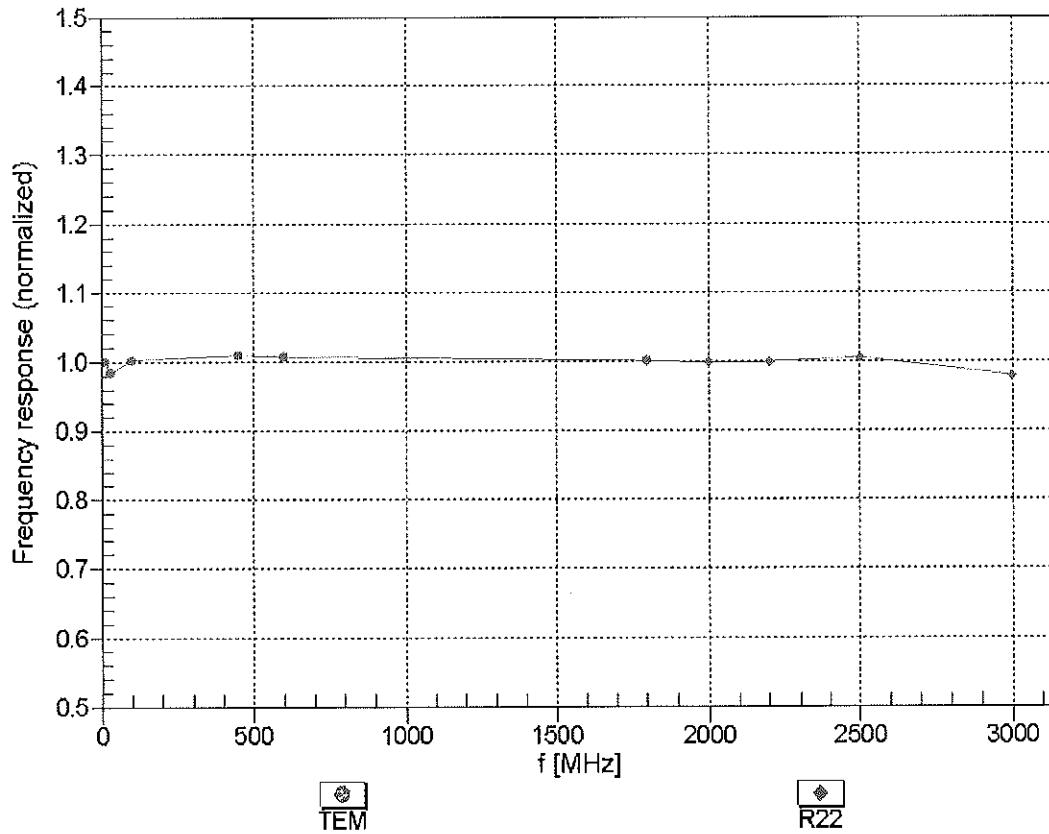

Uncertainty of Frequency Response of E-field: $\pm 6.3\%$ (k=2)

Receiving Pattern (ϕ), $\theta = 0^\circ$

f=600 MHz,TEM

f=1800 MHz,R22

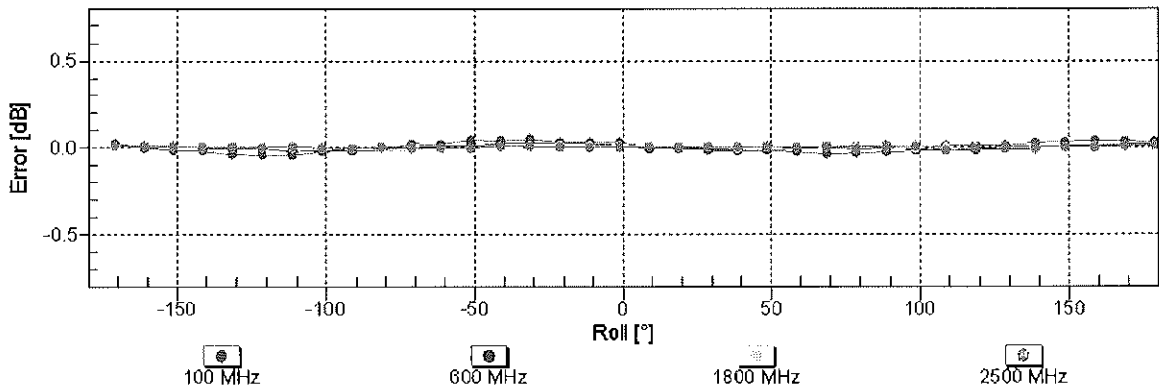
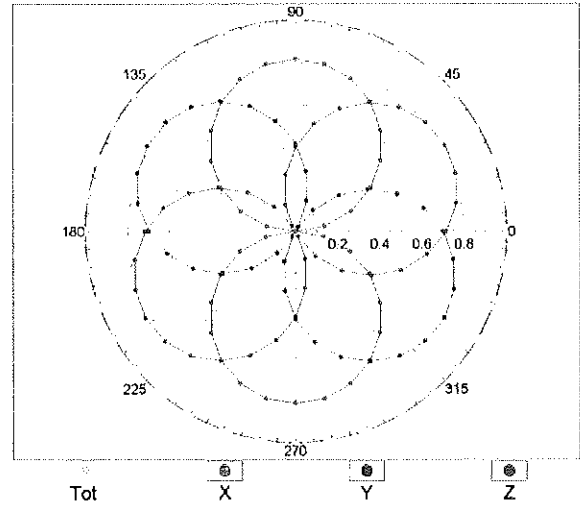
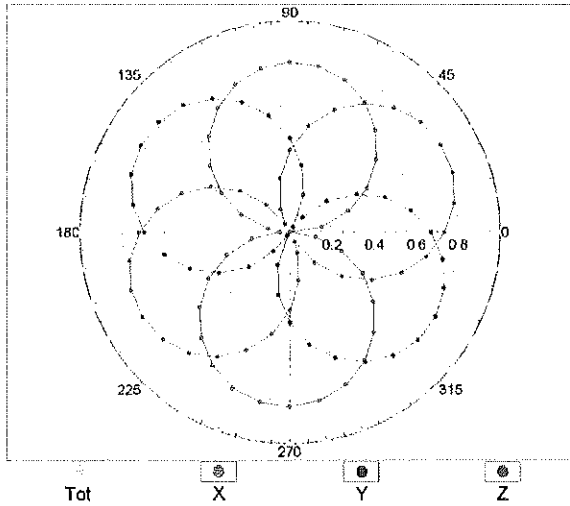

Uncertainty of Axial Isotropy Assessment: $\pm 0.5\%$ (k=2)

Dynamic Range $f(\text{SAR}_{\text{head}})$ (TEM cell , $f_{\text{eval}}= 1900 \text{ MHz}$)

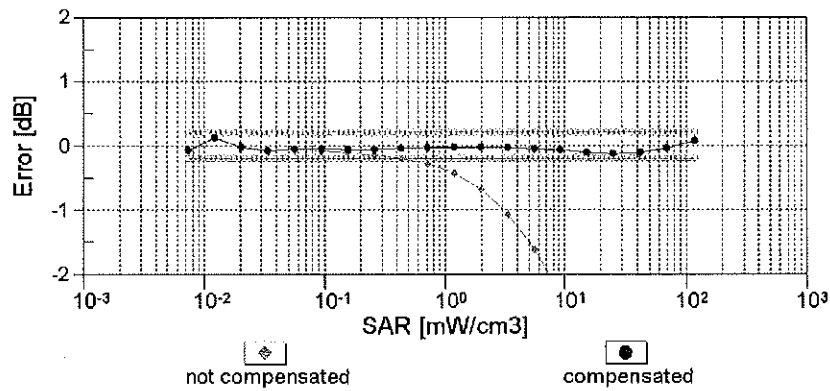
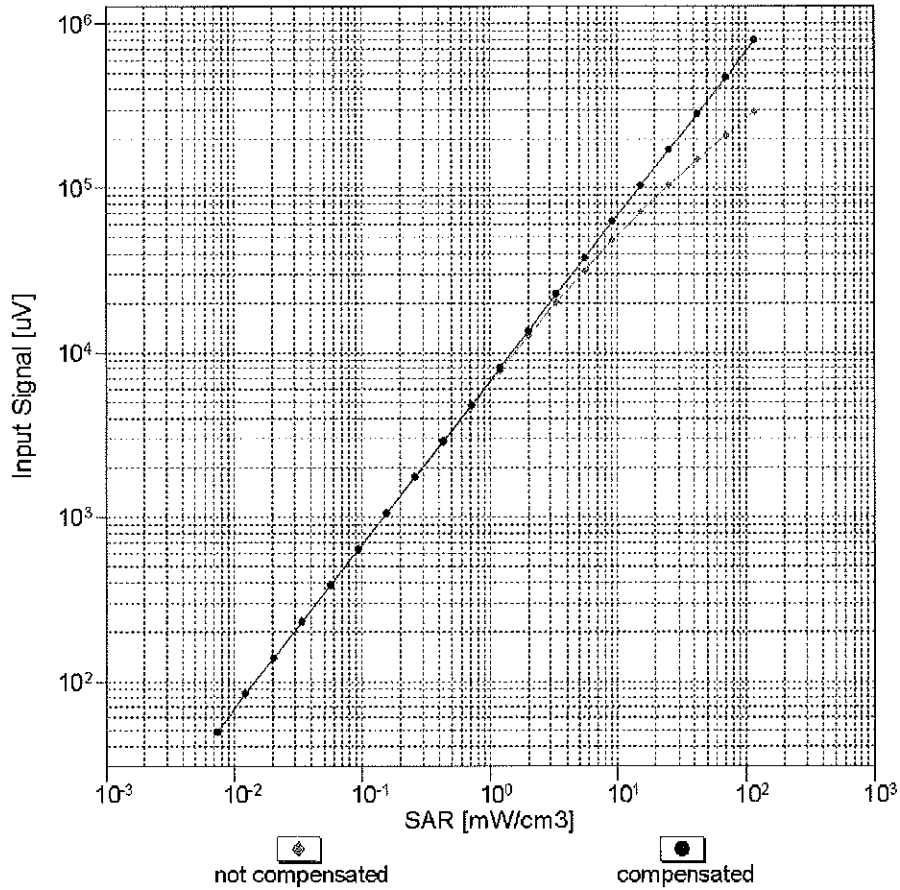

Uncertainty of Linearity Assessment: $\pm 0.6\%$ ($k=2$)

Conversion Factor Assessment

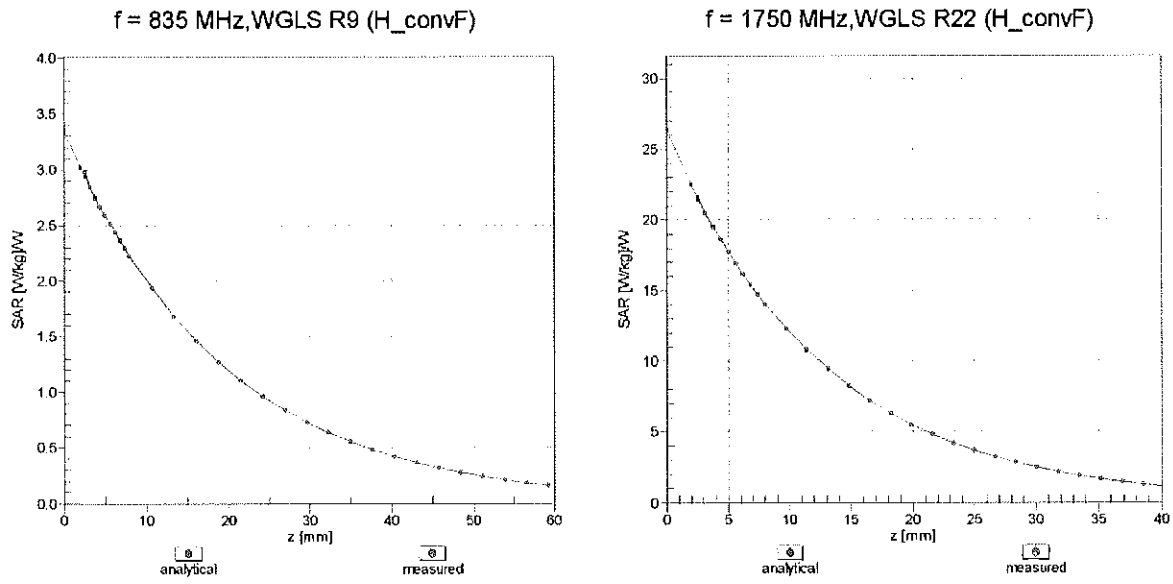

Deviation from Isotropy in Liquid Error (ϕ, θ), f = 900 MHz

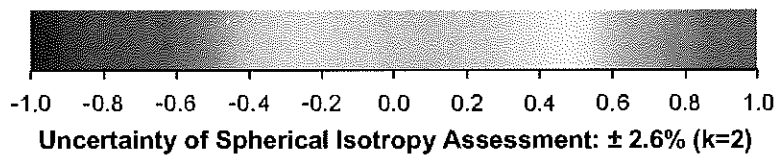
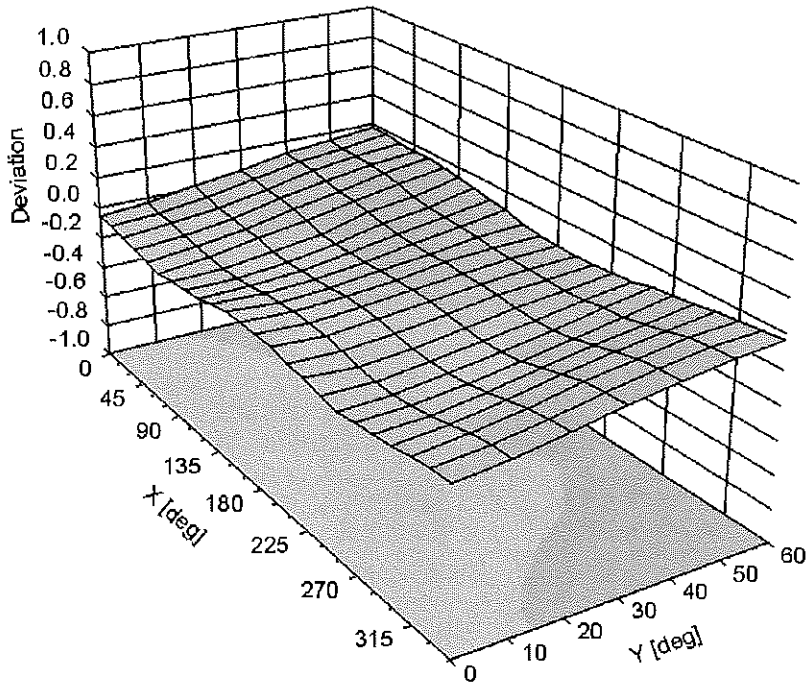

DASY/EASY - Parameters of Probe: ES3DV3 - SN:3263

Other Probe Parameters

Sensor Arrangement	Triangular
Connector Angle (°)	-111.2
Mechanical Surface Detection Mode	enabled
Optical Surface Detection Mode	disabled
Probe Overall Length	337 mm
Probe Body Diameter	10 mm
Tip Length	10 mm
Tip Diameter	4 mm
Probe Tip to Sensor X Calibration Point	2 mm
Probe Tip to Sensor Y Calibration Point	2 mm
Probe Tip to Sensor Z Calibration Point	2 mm
Recommended Measurement Distance from Surface	3 mm

**Calibration Laboratory of
Schmid & Partner
Engineering AG**
Zeughausstrasse 43, 8004 Zurich, Switzerland



S Schweizerischer Kalibrierdienst
C Service suisse d'étalonnage
S Servizio svizzero di taratura
S Swiss Calibration Service

Accredited by the Swiss Accreditation Service (SAS)
The Swiss Accreditation Service is one of the signatories to the EA
Multilateral Agreement for the recognition of calibration certificates

Accreditation No.: **SCS 108**

Client **PC Test**

Certificate No: **ES3-3333_Oct14**

CALIBRATION CERTIFICATE

Object **ES3DV3 - SN:3333**

Calibration procedure(s) **QA CAL-01.v9, QA CAL-23.v5, QA CAL-25.v6
Calibration procedure for dosimetric E-field probes**

CC
10/31/14

Calibration date: **October 24, 2014**

This calibration certificate documents the traceability to national standards, which realize the physical units of measurements (SI).
The measurements and the uncertainties with confidence probability are given on the following pages and are part of the certificate.

All calibrations have been conducted in the closed laboratory facility: environment temperature (22 ± 3)°C and humidity < 70%.

Calibration Equipment used (M&TE critical for calibration)

Primary Standards	ID	Cal Date (Certificate No.)	Scheduled Calibration
Power meter E4419B	GB41293874	03-Apr-14 (No. 217-01911)	Apr-15
Power sensor E4412A	MY41498087	03-Apr-14 (No. 217-01911)	Apr-15
Reference 3 dB Attenuator	SN: S5054 (3c)	03-Apr-14 (No. 217-01915)	Apr-15
Reference 20 dB Attenuator	SN: S5277 (20x)	03-Apr-14 (No. 217-01919)	Apr-15
Reference 30 dB Attenuator	SN: S5129 (30b)	03-Apr-14 (No. 217-01920)	Apr-15
Reference Probe ES3DV2	SN: 3013	30-Dec-13 (No. ES3-3013_Dec13)	Dec-14
DAE4	SN: 660	13-Dec-13 (No. DAE4-660_Dec13)	Dec-14
Secondary Standards	ID	Check Date (in house)	Scheduled Check
RF generator HP 8648C	US3642U01700	4-Aug-99 (in house check Apr-13)	In house check: Apr-16
Network Analyzer HP 8753E	US37390585	18-Oct-01 (in house check Oct-14)	In house check: Oct-15

	Name	Function	Signature
Calibrated by:	Leif Klysner	Laboratory Technician	
Approved by:	Kalja Pokovic	Technical Manager	
			Issued: October 24, 2014

This calibration certificate shall not be reproduced except in full without written approval of the laboratory.



Accredited by the Swiss Accreditation Service (SAS)
The Swiss Accreditation Service is one of the signatories to the EA
Multilateral Agreement for the recognition of calibration certificates

Accreditation No.: **SCS 108**

Glossary:

TSL	tissue simulating liquid
NORM _{x,y,z}	sensitivity in free space
ConvF	sensitivity in TSL / NORM _{x,y,z}
DCP	diode compression point
CF	crest factor (1/duty_cycle) of the RF signal
A, B, C, D	modulation dependent linearization parameters
Polarization φ	φ rotation around probe axis
Polarization ϑ	ϑ rotation around an axis that is in the plane normal to probe axis (at measurement center), i.e., $\vartheta = 0$ is normal to probe axis
Connector Angle	information used in DASY system to align probe sensor X to the robot coordinate system

Calibration is Performed According to the Following Standards:

- IEEE Std 1528-2013, "IEEE Recommended Practice for Determining the Peak Spatial-Averaged Specific Absorption Rate (SAR) in the Human Head from Wireless Communications Devices: Measurement Techniques", June 2013
- IEC 62209-1, "Procedure to measure the Specific Absorption Rate (SAR) for hand-held devices used in close proximity to the ear (frequency range of 300 MHz to 3 GHz)", February 2005

Methods Applied and Interpretation of Parameters:

- NORM_{x,y,z}:** Assessed for E-field polarization $\vartheta = 0$ ($f \leq 900$ MHz in TEM-cell; $f > 1800$ MHz: R22 waveguide). NORM_{x,y,z} are only intermediate values, i.e., the uncertainties of NORM_{x,y,z} does not affect the E²-field uncertainty inside TSL (see below ConvF).
- NORM(f)_{x,y,z} = NORM_{x,y,z} * frequency_response** (see Frequency Response Chart). This linearization is implemented in DASY4 software versions later than 4.2. The uncertainty of the frequency response is included in the stated uncertainty of ConvF.
- DCP_{x,y,z}:** DCP are numerical linearization parameters assessed based on the data of power sweep with CW signal (no uncertainty required). DCP does not depend on frequency nor media.
- PAR:** PAR is the Peak to Average Ratio that is not calibrated but determined based on the signal characteristics
- A_{x,y,z}; B_{x,y,z}; C_{x,y,z}; D_{x,y,z}; VR_{x,y,z}:** A, B, C, D are numerical linearization parameters assessed based on the data of power sweep for specific modulation signal. The parameters do not depend on frequency nor media. VR is the maximum calibration range expressed in RMS voltage across the diode.
- ConvF and Boundary Effect Parameters:** Assessed in flat phantom using E-field (or Temperature Transfer Standard for $f \leq 800$ MHz) and inside waveguide using analytical field distributions based on power measurements for $f > 800$ MHz. The same setups are used for assessment of the parameters applied for boundary compensation (alpha, depth) of which typical uncertainty values are given. These parameters are used in DASY4 software to improve probe accuracy close to the boundary. The sensitivity in TSL corresponds to NORM_{x,y,z} * ConvF whereby the uncertainty corresponds to that given for ConvF. A frequency dependent ConvF is used in DASY version 4.4 and higher which allows extending the validity from ± 50 MHz to ± 100 MHz.
- Spherical Isotropy (3D deviation from isotropy):** in a field of low gradients realized using a flat phantom exposed by a patch antenna.
- Sensor Offset:** The sensor offset corresponds to the offset of virtual measurement center from the probe tip (on probe axis). No tolerance required.
- Connector Angle:** The angle is assessed using the information gained by determining the NORM_x (no uncertainty required).

Probe ES3DV3

SN:3333

Manufactured: January 24, 2012
Calibrated: October 24, 2014

Calibrated for DASY/EASY Systems
(Note: non-compatible with DASY2 system!)

DASY/EASY - Parameters of Probe: ES3DV3 - SN:3333

Basic Calibration Parameters

	Sensor X	Sensor Y	Sensor Z	Unc (k=2)
Norm ($\mu\text{V}/(\text{V}/\text{m})^2$) ^A	1.08	0.90	0.88	$\pm 10.1\%$
DCP (mV) ^B	102.7	107.7	106.3	

Modulation Calibration Parameters

UID	Communication System Name		A dB	B dB $\sqrt{\mu\text{V}}$	C	D dB	VR mV	Unc ^E (k=2)
0	CW	X	0.0	0.0	1.0	0.00	190.7	$\pm 2.5\%$
		Y	0.0	0.0	1.0		183.3	
		Z	0.0	0.0	1.0		197.9	
10010- CAA	SAR Validation (Square, 100ms, 10ms)	X	3.17	61.7	12.2	10.00	42.4	$\pm 1.9\%$
		Y	3.16	63.7	12.4		38.0	
		Z	1.84	59.2	10.5		39.9	
10011- CAB	UMTS-FDD (WCDMA)	X	3.22	65.9	17.6	2.91	128.5	$\pm 0.5\%$
		Y	3.60	69.3	19.8		146.7	
		Z	3.51	68.1	18.8		133.7	
10012- CAA	IEEE 802.11b WIFI 2.4 GHz (DSSS, 1 Mbps)	X	3.14	68.6	18.2	1.87	132.6	$\pm 0.7\%$
		Y	3.64	73.3	21.1		127.5	
		Z	3.50	71.4	19.6		136.4	
10013- CAA	IEEE 802.11g WIFI 2.4 GHz (DSSS-OFDM, 6 Mbps)	X	11.56	70.8	23.0	9.46	135.8	$\pm 3.5\%$
		Y	10.93	70.2	23.0		122.3	
		Z	10.93	70.0	22.6		132.8	
10021- DAB	GSM-FDD (TDMA, GMSK)	X	24.60	96.9	27.6	9.39	147.6	$\pm 1.9\%$
		Y	19.44	94.3	26.1		148.6	
		Z	9.58	82.7	21.9		138.2	
10023- DAB	GPRS-FDD (TDMA, GMSK, TN 0)	X	20.09	93.0	26.4	9.57	141.7	$\pm 2.7\%$
		Y	24.86	99.0	27.9		143.5	
		Z	11.74	86.4	23.4		134.4	
10024- DAB	GPRS-FDD (TDMA, GMSK, TN 0-1)	X	23.76	91.2	23.1	6.56	147.8	$\pm 2.5\%$
		Y	37.10	99.8	25.3		149.9	
		Z	16.01	88.1	21.6		128.0	
10027- DAB	GPRS-FDD (TDMA, GMSK, TN 0-1-2)	X	36.24	94.5	22.6	4.80	128.6	$\pm 2.5\%$
		Y	47.57	99.9	23.7		133.5	
		Z	44.37	99.7	23.6		140.1	
10028- DAB	GPRS-FDD (TDMA, GMSK, TN 0-1-2-3)	X	65.86	99.7	22.7	3.55	133.1	$\pm 2.7\%$
		Y	55.92	100.0	22.6		142.0	
		Z	59.41	100.0	22.2		125.1	
10032- CAA	IEEE 802.15.1 Bluetooth (GFSK, DH5)	X	85.87	100.0	20.1	1.16	138.3	$\pm 2.2\%$
		Y	14.41	99.2	23.3		130.5	
		Z	85.82	99.8	19.3		135.9	
10100- CAB	LTE-FDD (SC-FDMA, 100% RB, 20 MHz, QPSK)	X	6.49	67.4	19.4	5.67	144.6	$\pm 1.7\%$
		Y	6.49	68.0	20.1		139.9	
		Z	6.54	67.9	19.7		147.3	

10103-CAB	LTE-TDD (SC-FDMA, 100% RB, 20 MHz, QPSK)	X	10.81	74.7	24.9	9.29	122.0	±3.0 %
		Y	10.50	75.9	26.1		131.6	
		Z	9.76	73.5	24.5		138.6	
10108-CAB	LTE-FDD (SC-FDMA, 100% RB, 10 MHz, QPSK)	X	6.43	67.2	19.4	5.80	143.3	±1.7 %
		Y	6.37	67.7	20.0		138.0	
		Z	6.43	67.5	19.7		146.7	
10117-CAA	IEEE 802.11n (HT Mixed, 13.5 Mbps, BPSK)	X	10.19	68.6	20.9	8.07	136.2	±2.5 %
		Y	10.15	68.9	21.4		128.3	
		Z	10.12	68.7	21.0		137.9	
10151-CAB	LTE-TDD (SC-FDMA, 50% RB, 20 MHz, QPSK)	X	11.48	77.0	26.1	9.28	147.5	±3.3 %
		Y	9.81	74.9	25.8		125.7	
		Z	9.22	72.8	24.3		133.2	
10154-CAB	LTE-FDD (SC-FDMA, 50% RB, 10 MHz, QPSK)	X	6.10	66.5	19.1	5.75	140.0	±1.7 %
		Y	6.04	67.1	19.8		134.8	
		Z	6.12	67.1	19.5		143.2	
10160-CAB	LTE-FDD (SC-FDMA, 50% RB, 15 MHz, QPSK)	X	6.57	67.2	19.4	5.82	146.3	±1.7 %
		Y	6.47	67.6	20.0		139.6	
		Z	6.56	67.6	19.7		148.5	
10169-CAB	LTE-FDD (SC-FDMA, 1 RB, 20 MHz, QPSK)	X	5.16	66.7	19.4	5.73	145.8	±1.4 %
		Y	5.02	67.5	20.2		137.5	
		Z	5.07	67.2	19.7		147.1	
10172-CAB	LTE-TDD (SC-FDMA, 1 RB, 20 MHz, QPSK)	X	10.07	79.2	27.3	9.21	136.5	±3.0 %
		Y	9.70	81.5	29.3		142.5	
		Z	7.63	74.3	25.3		125.0	
10175-CAB	LTE-FDD (SC-FDMA, 1 RB, 10 MHz, QPSK)	X	5.13	66.6	19.3	5.72	145.9	±1.4 %
		Y	5.01	67.4	20.1		137.5	
		Z	5.04	67.1	19.7		146.3	
10181-CAB	LTE-FDD (SC-FDMA, 1 RB, 15 MHz, QPSK)	X	5.14	66.6	19.3	5.72	145.7	±1.4 %
		Y	5.03	67.5	20.3		137.4	
		Z	5.06	67.2	19.7		146.6	
10196-CAA	IEEE 802.11n (HT Mixed, 6.5 Mbps, BPSK)	X	9.88	68.3	20.8	8.10	130.9	±2.5 %
		Y	10.13	69.6	21.8		149.0	
		Z	9.77	68.4	20.9		131.6	
10225-CAB	UMTS-FDD (HSPA+)	X	6.98	66.5	19.0	5.97	132.9	±1.7 %
		Y	7.14	67.8	20.0		149.7	
		Z	7.02	67.2	19.4		134.3	
10237-CAB	LTE-TDD (SC-FDMA, 1 RB, 10 MHz, QPSK)	X	10.13	79.4	27.4	9.21	137.5	±3.0 %
		Y	9.73	81.6	29.3		143.3	
		Z	7.59	74.1	25.1		125.6	
10252-CAB	LTE-TDD (SC-FDMA, 50% RB, 10 MHz, QPSK)	X	10.80	76.4	25.9	9.24	140.0	±3.3 %
		Y	10.19	77.2	27.1		147.2	
		Z	8.55	71.8	23.9		124.9	
10267-CAB	LTE-TDD (SC-FDMA, 100% RB, 10 MHz, QPSK)	X	11.59	77.3	26.3	9.30	148.4	±3.5 %
		Y	9.87	75.1	25.9		126.0	
		Z	9.21	72.7	24.2		133.6	

10275-CAB	UMTS-FDD (HSUPA, Subtest 5, 3GPP Rel8.4)	X	4.40	66.1	18.1	3.96	134.1	±0.7 %
		Y	4.48	67.4	19.2		129.7	
		Z	4.54	67.2	18.7		137.4	
10291-AAB	CDMA2000, RC3, SO55, Full Rate	X	3.59	65.7	17.7	3.46	127.5	±0.7 %
		Y	3.85	68.4	19.7		143.4	
		Z	3.78	67.6	18.8		129.7	
10292-AAB	CDMA2000, RC3, SO32, Full Rate	X	3.56	65.9	17.8	3.39	127.9	±0.7 %
		Y	3.81	68.6	19.8		144.2	
		Z	3.71	67.5	18.8		130.7	
10297-AAA	LTE-FDD (SC-FDMA, 50% RB, 20 MHz, QPSK)	X	6.44	67.1	19.4	5.81	143.0	±1.7 %
		Y	6.37	67.6	20.0		137.9	
		Z	6.43	67.5	19.7		146.5	
10311-AAA	LTE-FDD (SC-FDMA, 100% RB, 15 MHz, QPSK)	X	7.02	67.8	19.8	6.06	148.7	±1.9 %
		Y	6.96	68.2	20.4		143.6	
		Z	6.72	67.1	19.5		126.9	
10403-AAB	CDMA2000 (1xEV-DO, Rev. 0)	X	4.73	67.0	17.9	3.76	140.2	±0.7 %
		Y	4.96	69.4	19.5		130.7	
		Z	5.05	69.3	19.1		140.9	
10404-AAB	CDMA2000 (1xEV-DO, Rev. A)	X	4.70	67.2	18.1	3.77	138.1	±0.7 %
		Y	4.85	69.5	19.6		129.6	
		Z	5.14	70.1	19.5		139.3	
10415-AAA	IEEE 802.11b WiFi 2.4 GHz (DSSS, 1 Mbps, 99pc duty cycle)	X	2.47	66.1	17.1	1.54	133.2	±0.7 %
		Y	3.15	72.2	20.9		127.9	
		Z	3.32	72.0	20.1		137.2	
10416-AAA	IEEE 802.11g WiFi 2.4 GHz (ERP-OFDM, 6 Mbps, 99pc duty cycle)	X	9.99	68.4	21.0	8.23	131.6	±2.5 %
		Y	9.84	68.6	21.4		123.3	
		Z	9.89	68.6	21.1		133.4	

The reported uncertainty of measurement is stated as the standard uncertainty of measurement multiplied by the coverage factor $k=2$, which for a normal distribution corresponds to a coverage probability of approximately 95%.

^A The uncertainties of NormX,Y,Z do not affect the E^2 -field uncertainty inside TSL (see Pages 7 and 8).

^B Numerical linearization parameter: uncertainty not required.

^E Uncertainty is determined using the max. deviation from linear response applying rectangular distribution and is expressed for the square of the field value.

DASY/EASY - Parameters of Probe: ES3DV3 - SN:3333

Calibration Parameter Determined in Head Tissue Simulating Media

f (MHz) ^C	Relative Permittivity ^F	Conductivity (S/m) ^F	ConvF X	ConvF Y	ConvF Z	Alpha ^G	Depth ^G (mm)	Unct. (k=2)
750	41.9	0.89	6.55	6.55	6.55	0.34	1.74	± 12.0 %
835	41.5	0.90	6.33	6.33	6.33	0.44	1.48	± 12.0 %
1750	40.1	1.37	5.26	5.26	5.26	0.73	1.21	± 12.0 %
1900	40.0	1.40	5.11	5.11	5.11	0.66	1.32	± 12.0 %
2450	39.2	1.80	4.53	4.53	4.53	0.62	1.40	± 12.0 %
2600	39.0	1.96	4.40	4.40	4.40	0.68	1.38	± 12.0 %

^C Frequency validity above 300 MHz of ± 100 MHz only applies for DASY v4.4 and higher (see Page 2), else it is restricted to ± 50 MHz. The uncertainty is the RSS of the ConvF uncertainty at calibration frequency and the uncertainty for the indicated frequency band. Frequency validity below 300 MHz is ± 10, 25, 40, 50 and 70 MHz for ConvF assessments at 30, 64, 128, 150 and 220 MHz respectively. Above 5 GHz frequency validity can be extended to ± 110 MHz.

^F At frequencies below 3 GHz, the validity of tissue parameters (ϵ and σ) can be relaxed to ± 10% if liquid compensation formula is applied to measured SAR values. At frequencies above 3 GHz, the validity of tissue parameters (ϵ and σ) is restricted to ± 5%. The uncertainty is the RSS of the ConvF uncertainty for indicated target tissue parameters.

^G Alpha/Depth are determined during calibration. SPEAG warrants that the remaining deviation due to the boundary effect after compensation is always less than ± 1% for frequencies below 3 GHz and below ± 2% for frequencies between 3-6 GHz at any distance larger than half the probe tip diameter from the boundary.

DASY/EASY - Parameters of Probe: ES3DV3 - SN:3333

Calibration Parameter Determined in Body Tissue Simulating Media

f (MHz) ^C	Relative Permittivity ^F	Conductivity (S/m) ^F	ConvF X	ConvF Y	ConvF Z	Alpha ^G	Depth (mm)	Uct. (k=2)
750	55.5	0.96	6.14	6.14	6.14	0.35	1.76	± 12.0 %
835	55.2	0.97	6.12	6.12	6.12	0.57	1.37	± 12.0 %
1750	53.4	1.49	4.89	4.89	4.89	0.80	1.24	± 12.0 %
1900	53.3	1.52	4.67	4.67	4.67	0.75	1.29	± 12.0 %
2450	52.7	1.95	4.26	4.26	4.26	0.80	1.01	± 12.0 %
2600	52.5	2.16	4.13	4.13	4.13	0.80	0.99	± 12.0 %

^C Frequency validity above 300 MHz of ± 100 MHz only applies for DASY v4.4 and higher (see Page 2), else it is restricted to ± 50 MHz. The uncertainty is the RSS of the ConvF uncertainty at calibration frequency and the uncertainty for the indicated frequency band. Frequency validity below 300 MHz is ± 10, 25, 40, 50 and 70 MHz for ConvF assessments at 30, 64, 128, 150 and 220 MHz respectively. Above 5 GHz frequency validity can be extended to ± 110 MHz.

^F At frequencies below 3 GHz, the validity of tissue parameters (ϵ and σ) can be relaxed to ± 10% if liquid compensation formula is applied to measured SAR values. At frequencies above 3 GHz, the validity of tissue parameters (ϵ and σ) is restricted to ± 5%. The uncertainty is the RSS of the ConvF uncertainty for indicated target tissue parameters.

^G Alpha/Depth are determined during calibration. SPEAG warrants that the remaining deviation due to the boundary effect after compensation is always less than ± 1% for frequencies below 3 GHz and below ± 2% for frequencies between 3-6 GHz at any distance larger than half the probe tip diameter from the boundary.

Frequency Response of E-Field (TEM-Cell: ifi110 EXX, Waveguide: R22)

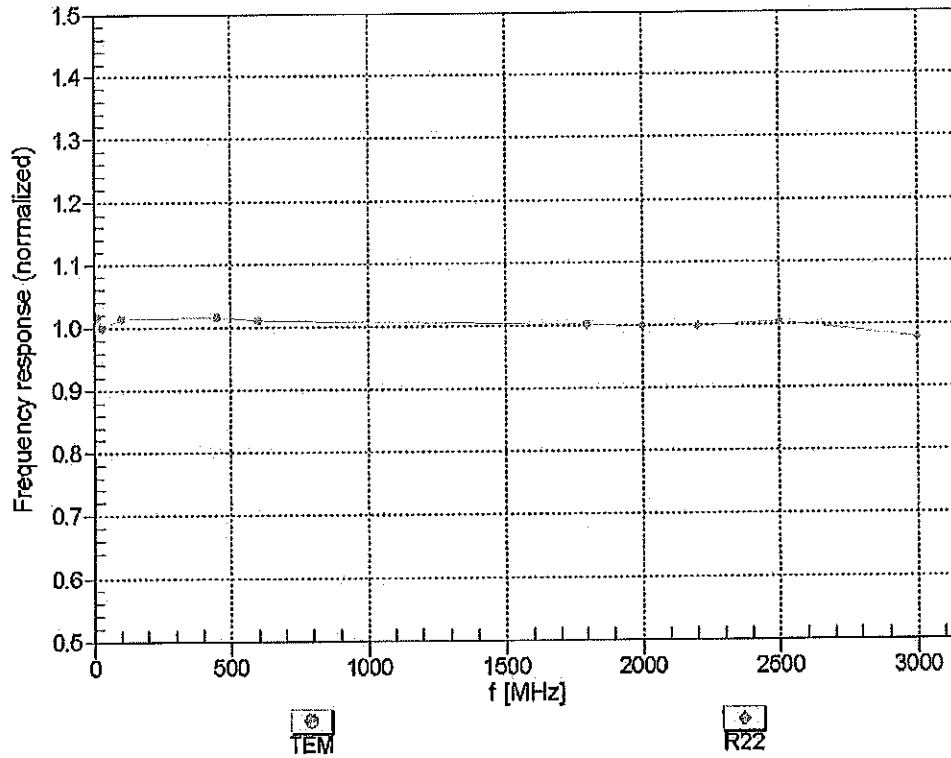

Uncertainty of Frequency Response of E-field: $\pm 6.3\%$ (k=2)

Receiving Pattern (ϕ), $\theta = 0^\circ$

f=600 MHz,TEM

f=1800 MHz,R22

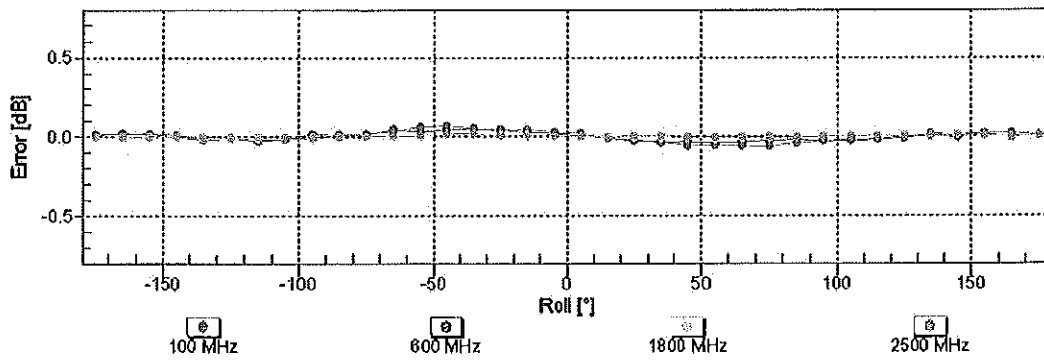
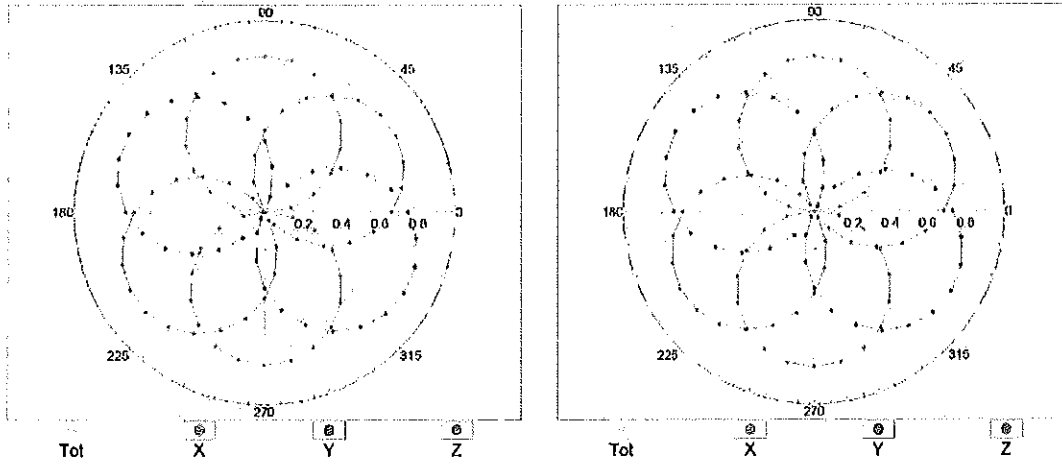

Uncertainty of Axial Isotropy Assessment: $\pm 0.5\%$ (k=2)

Dynamic Range $f(SAR_{head})$ (TEM cell, $f_{eval} = 1900$ MHz)

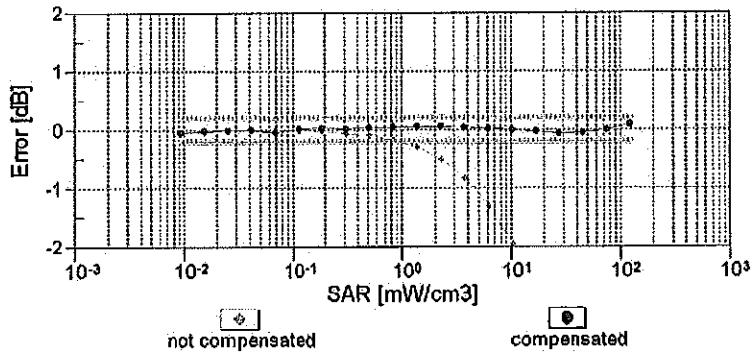
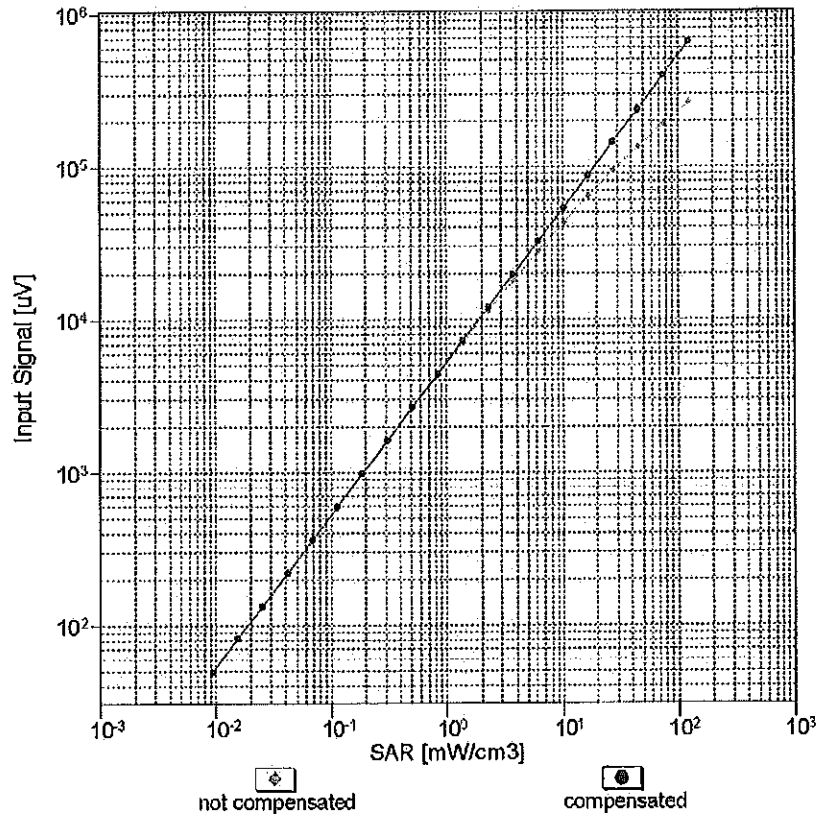

Uncertainty of Linearity Assessment: $\pm 0.6\%$ ($k=2$)

Conversion Factor Assessment

f = 835 MHz, WGLS R9 (H_convF)

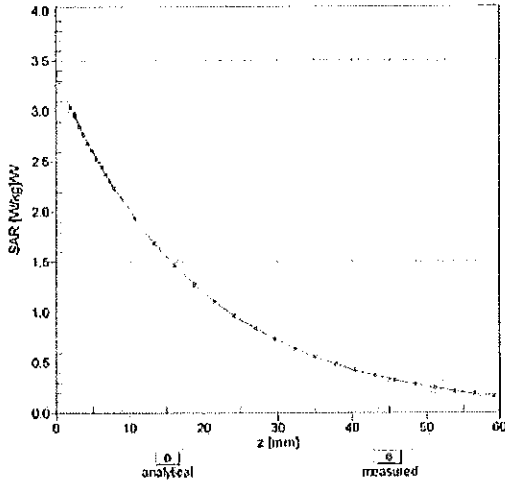

f = 1900 MHz, WGLS R22 (H_convF)

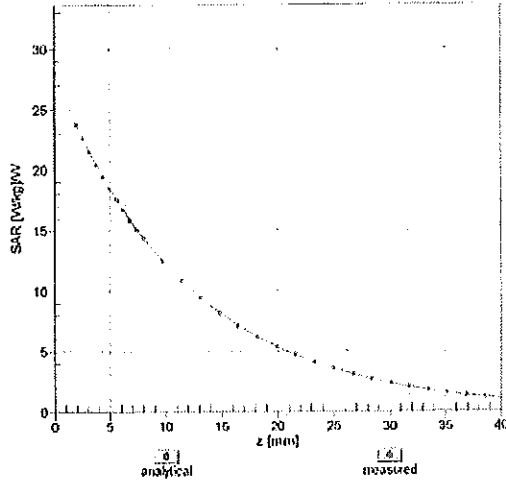

Deviation from Isotropy in Liquid

Error (ϕ, θ), f = 900 MHz

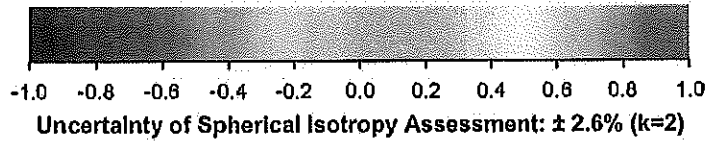
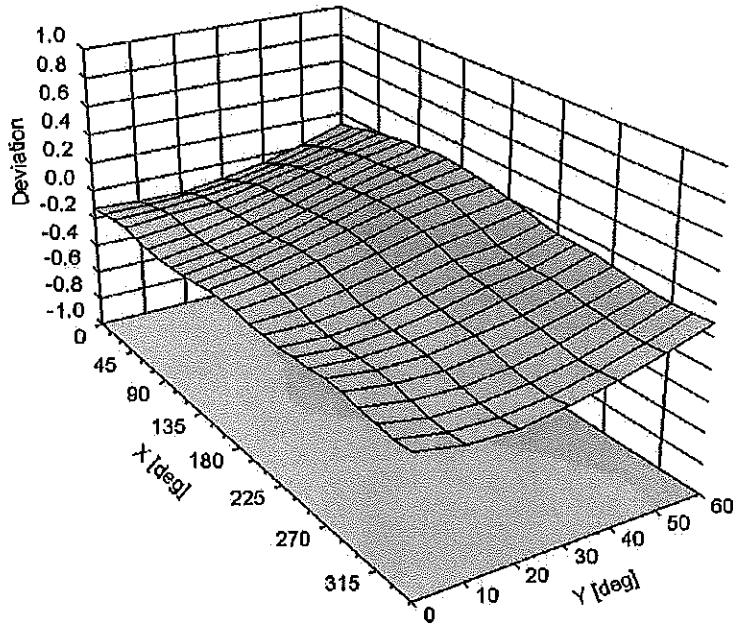

DASY/EASY - Parameters of Probe: ES3DV3 - SN:3333**Other Probe Parameters**

Sensor Arrangement	Triangular
Connector Angle (°)	-34.9
Mechanical Surface Detection Mode	enabled
Optical Surface Detection Mode	disabled
Probe Overall Length	337 mm
Probe Body Diameter	10 mm
Tip Length	10 mm
Tip Diameter	4 mm
Probe Tip to Sensor X Calibration Point	2 mm
Probe Tip to Sensor Y Calibration Point	2 mm
Probe Tip to Sensor Z Calibration Point	2 mm
Recommended Measurement Distance from Surface	3 mm

**Calibration Laboratory of
Schmid & Partner
Engineering AG**
Zeughausstrasse 43, 8004 Zurich, Switzerland



**S
C
S** Schweizerischer Kalibrierdienst
Service suisse d'étalonnage
Servizio svizzero di taratura
Swiss Calibration Service

Accredited by the Swiss Accreditation Service (SAS)
The Swiss Accreditation Service is one of the signatories to the EA
Multilateral Agreement for the recognition of calibration certificates

Accreditation No.: **SCS 0108**

Client **PC Test**

Certificate No: **EX3-3914_Feb15**

CALIBRATION CERTIFICATE

Object **EX3DV4 - SN:3914** CCV
3/6/15

Calibration procedure(s) **QA CAL-01.v9, QA CAL-14.v4, QA CAL-23.v5, QA CAL-25.v6
Calibration procedure for dosimetric E-field probes**

Calibration date: **February 10, 2015**

This calibration certificate documents the traceability to national standards, which realize the physical units of measurements (SI).
The measurements and the uncertainties with confidence probability are given on the following pages and are part of the certificate.

All calibrations have been conducted in the closed laboratory facility: environment temperature (22 ± 3)°C and humidity < 70%.

Calibration Equipment used (M&TE critical for calibration)

Primary Standards	ID	Cal Date (Certificate No.)	Scheduled Calibration
Power meter E4419B	GB41293874	03-Apr-14 (No. 217-01911)	Apr-15
Power sensor E4412A	MY41498087	03-Apr-14 (No. 217-01911)	Apr-15
Reference 3 dB Attenuator	SN: S5054 (3c)	03-Apr-14 (No. 217-01915)	Apr-15
Reference 20 dB Attenuator	SN: S5277 (20x)	03-Apr-14 (No. 217-01919)	Apr-15
Reference 30 dB Attenuator	SN: S5129 (30b)	03-Apr-14 (No. 217-01920)	Apr-15
Reference Probe ES3DV2	SN: 3013	30-Dec-14 (No. ES3-3013_Dec14)	Dec-15
DAE4	SN: 660	14-Jan-15 (No. DAE4-660_Jan15)	Jan-16
Secondary Standards	ID	Check Date (in house)	Scheduled Check
RF generator HP 8648C	US3642U01700	4-Aug-99 (in house check Apr-13)	In house check: Apr-16
Network Analyzer HP 8753E	US37390585	18-Oct-01 (in house check Oct-14)	In house check: Oct-15

Calibrated by:	Name Claudio Leubler	Function Laboratory Technician	Signature
Approved by:	Katja Pokovic	Technical Manager	

Issued: February 10, 2015

This calibration certificate shall not be reproduced except in full without written approval of the laboratory.



Accredited by the Swiss Accreditation Service (SAS)

Accreditation No.: **SCS 0108**

The Swiss Accreditation Service is one of the signatories to the EA Multilateral Agreement for the recognition of calibration certificates

Glossary:

TSL	tissue simulating liquid
NORM _{x,y,z}	sensitivity in free space
ConvF	sensitivity in TSL / NORM _{x,y,z}
DCP	diode compression point
CF	crest factor (1/duty_cycle) of the RF signal
A, B, C, D	modulation dependent linearization parameters
Polarization φ	φ rotation around probe axis
Polarization ϑ	ϑ rotation around an axis that is in the plane normal to probe axis (at measurement center), i.e., $\vartheta = 0$ is normal to probe axis
Connector Angle	information used in DASY system to align probe sensor X to the robot coordinate system

Calibration is Performed According to the Following Standards:

- a) IEEE Std 1528-2013, "IEEE Recommended Practice for Determining the Peak Spatial-Averaged Specific Absorption Rate (SAR) in the Human Head from Wireless Communications Devices: Measurement Techniques", June 2013
- b) IEC 62209-1, "Procedure to measure the Specific Absorption Rate (SAR) for hand-held devices used in close proximity to the ear (frequency range of 300 MHz to 3 GHz)", February 2005

Methods Applied and Interpretation of Parameters:

- **NORM_{x,y,z}**: Assessed for E-field polarization $\vartheta = 0$ ($f \leq 900$ MHz in TEM-cell; $f > 1800$ MHz: R22 waveguide). NORM_{x,y,z} are only intermediate values, i.e., the uncertainties of NORM_{x,y,z} does not affect the E²-field uncertainty inside TSL (see below *ConvF*).
- **NORM(f)_{x,y,z}** = NORM_{x,y,z} * *frequency_response* (see Frequency Response Chart). This linearization is implemented in DASY4 software versions later than 4.2. The uncertainty of the frequency response is included in the stated uncertainty of *ConvF*.
- **DCP_{x,y,z}**: DCP are numerical linearization parameters assessed based on the data of power sweep with CW signal (no uncertainty required). DCP does not depend on frequency nor media.
- **PAR**: PAR is the Peak to Average Ratio that is not calibrated but determined based on the signal characteristics
- **A_{x,y,z}; B_{x,y,z}; C_{x,y,z}; D_{x,y,z}; VR_{x,y,z}; A, B, C, D** are numerical linearization parameters assessed based on the data of power sweep for specific modulation signal. The parameters do not depend on frequency nor media. VR is the maximum calibration range expressed in RMS voltage across the diode.
- **ConvF and Boundary Effect Parameters**: Assessed in flat phantom using E-field (or Temperature Transfer Standard for $f \leq 800$ MHz) and inside waveguide using analytical field distributions based on power measurements for $f > 800$ MHz. The same setups are used for assessment of the parameters applied for boundary compensation (alpha, depth) of which typical uncertainty values are given. These parameters are used in DASY4 software to improve probe accuracy close to the boundary. The sensitivity in TSL corresponds to NORM_{x,y,z} * *ConvF* whereby the uncertainty corresponds to that given for *ConvF*. A frequency dependent *ConvF* is used in DASY version 4.4 and higher which allows extending the validity from ± 50 MHz to ± 100 MHz.
- **Spherical isotropy (3D deviation from isotropy)**: in a field of low gradients realized using a flat phantom exposed by a patch antenna.
- **Sensor Offset**: The sensor offset corresponds to the offset of virtual measurement center from the probe tip (on probe axis). No tolerance required.
- **Connector Angle**: The angle is assessed using the information gained by determining the NORM_x (no uncertainty required).

Probe EX3DV4

SN:3914

Manufactured:	December 18, 2012
Repaired:	January 23, 2015
Calibrated:	February 10, 2015

Calibrated for DASY/EASY Systems
(Note: non-compatible with DASY2 system!)

DASY/EASY - Parameters of Probe: EX3DV4 - SN:3914

Basic Calibration Parameters

	Sensor X	Sensor Y	Sensor Z	Unc (k=2)
Norm ($\mu\text{V}/(\text{V}/\text{m})^2$) ^A	0.48	0.42	0.45	$\pm 10.1\%$
DCP (mV) ^B	102.7	103.2	101.3	

Modulation Calibration Parameters

UID	Communication System Name		A dB	B dB $\sqrt{\mu\text{V}}$	C	D dB	VR mV	Unc ^E (k=2)
0	CW	X	0.0	0.0	1.0	0.00	137.3	$\pm 2.7\%$
		Y	0.0	0.0	1.0		140.8	
		Z	0.0	0.0	1.0		134.6	
10010- CAA	SAR Validation (Square, 100ms, 10ms)	X	1.33	60.3	9.9	10.00	40.4	$\pm 1.2\%$
		Y	1.02	57.7	9.2		42.2	
		Z	1.41	61.3	11.0		39.9	
10011- CAB	UMTS-FDD (WCDMA)	X	3.39	67.3	18.6	2.91	148.9	$\pm 0.5\%$
		Y	3.47	67.6	18.6		130.1	
		Z	3.30	66.5	17.9		145.8	
10012- CAB	IEEE 802.11b WiFi 2.4 GHz (DSSS, 1 Mbps)	X	2.92	68.9	18.9	1.87	149.0	$\pm 0.7\%$
		Y	3.17	70.1	19.2		131.4	
		Z	2.72	67.0	17.6		146.9	
10013- CAB	IEEE 802.11g WiFi 2.4 GHz (DSSS-OFDM, 6 Mbps)	X	10.52	69.1	22.1	9.46	140.7	$\pm 3.3\%$
		Y	10.67	69.8	22.6		146.8	
		Z	10.44	68.9	22.0		136.8	
10021- DAB	GSM-FDD (TDMA, GMSK)	X	1.64	63.4	11.8	9.39	86.2	$\pm 1.7\%$
		Y	2.03	65.7	13.6		105.2	
		Z	1.78	63.6	12.4		85.9	
10023- DAB	GPRS-FDD (TDMA, GMSK, TN 0)	X	1.78	65.0	13.2	9.57	84.0	$\pm 2.2\%$
		Y	1.84	63.8	12.5		101.1	
		Z	1.92	64.9	13.4		83.0	
10024- DAB	GPRS-FDD (TDMA, GMSK, TN 0-1)	X	2.04	68.8	13.2	6.56	141.3	$\pm 1.9\%$
		Y	2.32	70.4	14.4		134.7	
		Z	1.59	65.5	12.3		139.3	
10027- DAB	GPRS-FDD (TDMA, GMSK, TN 0-1-2)	X	1.51	67.3	11.9	4.80	148.8	$\pm 1.9\%$
		Y	1.27	63.7	10.0		136.2	
		Z	3.26	75.5	15.4		148.7	
10028- DAB	GPRS-FDD (TDMA, GMSK, TN 0-1-2-3)	X	52.54	99.9	20.2	3.55	143.3	$\pm 1.7\%$
		Y	2.95	74.0	13.7		149.7	
		Z	32.98	99.9	21.5		141.9	
10032- CAA	IEEE 802.15.1 Bluetooth (GFSK, DH5)	X	96.97	99.5	17.5	1.16	145.3	$\pm 1.2\%$
		Y	83.69	99.7	18.1		128.6	
		Z	0.69	65.4	9.0		143.2	

10062-CAB	IEEE 802.11a/h WiFi 5 GHz (OFDM, 6 Mbps)	X	10.27	68.9	21.5	8.68	145.1	±2.7 %
		Y	9.95	68.4	21.3		123.8	
		Z	10.18	68.8	21.4		140.9	
10100-CAB	LTE-FDD (SC-FDMA, 100% RB, 20 MHz, QPSK)	X	6.38	67.0	19.3	5.67	140.1	±1.4 %
		Y	6.54	67.7	19.6		147.0	
		Z	6.34	66.8	19.1		137.4	
10103-CAB	LTE-TDD (SC-FDMA, 100% RB, 20 MHz, QPSK)	X	7.44	67.6	21.6	9.29	132.4	±1.7 %
		Y	7.78	69.0	22.4		140.2	
		Z	7.40	67.4	21.4		129.5	
10108-CAC	LTE-FDD (SC-FDMA, 100% RB, 10 MHz, QPSK)	X	6.25	66.7	19.2	5.80	137.9	±1.4 %
		Y	6.36	67.2	19.5		143.3	
		Z	6.20	66.4	19.0		135.0	
10117-CAB	IEEE 802.11n (HT Mixed, 13.5 Mbps, BPSK)	X	10.03	68.2	20.7	8.07	128.5	±2.5 %
		Y	10.17	68.7	21.0		134.9	
		Z	9.94	68.0	20.5		125.2	
10151-CAB	LTE-TDD (SC-FDMA, 50% RB, 20 MHz, QPSK)	X	7.21	67.6	21.8	9.28	149.5	±1.9 %
		Y	7.39	68.5	22.3		135.1	
		Z	7.19	67.5	21.7		147.3	
10154-CAC	LTE-FDD (SC-FDMA, 50% RB, 10 MHz, QPSK)	X	5.91	66.2	19.1	5.75	133.8	±1.2 %
		Y	6.04	66.8	19.4		139.4	
		Z	5.88	66.0	18.9		131.1	
10160-CAB	LTE-FDD (SC-FDMA, 50% RB, 15 MHz, QPSK)	X	6.36	66.7	19.3	5.82	139.0	±1.4 %
		Y	6.51	67.4	19.7		145.5	
		Z	6.31	66.4	19.0		136.5	
10169-CAB	LTE-FDD (SC-FDMA, 1 RB, 20 MHz, QPSK)	X	4.79	66.3	19.4	5.73	136.1	±1.2 %
		Y	4.90	67.0	19.8		141.5	
		Z	4.76	66.0	19.1		133.8	
10172-CAB	LTE-TDD (SC-FDMA, 1 RB, 20 MHz, QPSK)	X	5.66	68.8	22.7	9.21	138.2	±2.5 %
		Y	5.93	70.3	23.7		147.0	
		Z	5.68	68.6	22.6		136.7	
10175-CAC	LTE-FDD (SC-FDMA, 1 RB, 10 MHz, QPSK)	X	4.77	66.2	19.3	5.72	135.7	±1.2 %
		Y	4.92	67.1	19.8		141.2	
		Z	4.72	65.8	19.0		133.6	
10181-CAB	LTE-FDD (SC-FDMA, 1 RB, 15 MHz, QPSK)	X	4.77	66.2	19.3	5.72	134.8	±1.2 %
		Y	4.91	67.0	19.7		141.1	
		Z	4.76	66.0	19.1		132.8	
10196-CAB	IEEE 802.11n (HT Mixed, 6.5 Mbps, BPSK)	X	9.99	68.8	21.1	8.10	146.9	±2.5 %
		Y	9.71	68.4	21.0		127.0	
		Z	9.91	68.7	21.0		143.4	
10225-CAB	UMTS-FDD (HSPA+)	X	7.10	67.5	19.5	5.97	149.1	±1.2 %
		Y	6.98	67.4	19.5		128.9	
		Z	7.01	67.2	19.3		145.5	

10237-CAB	LTE-TDD (SC-FDMA, 1 RB, 10 MHz, QPSK)	X	5.68	68.9	22.8	9.21	139.9	±2.2 %
		Y	5.93	70.3	23.6		148.1	
		Z	5.70	68.8	22.7		137.5	
10252-CAB	LTE-TDD (SC-FDMA, 50% RB, 10 MHz, QPSK)	X	6.81	67.4	21.7	9.24	143.4	±2.2 %
		Y	6.93	68.0	22.2		129.3	
		Z	6.79	67.2	21.6		140.3	
10267-CAB	LTE-TDD (SC-FDMA, 100% RB, 10 MHz, QPSK)	X	7.23	67.7	21.9	9.30	149.4	±1.9 %
		Y	7.42	68.6	22.4		135.2	
		Z	7.19	67.4	21.6		146.2	
10275-CAB	UMTS-FDD (HSUPA, Subtest 5, 3GPP Rel8.4)	X	4.44	66.7	18.6	3.96	129.1	±0.7 %
		Y	4.57	67.4	18.9		134.5	
		Z	4.35	66.1	18.1		126.6	
10291-AAB	CDMA2000, RC3, SO55, Full Rate	X	3.64	66.9	18.6	3.46	140.9	±0.7 %
		Y	3.87	68.3	19.3		147.1	
		Z	3.61	66.5	18.2		138.4	
10292-AAB	CDMA2000, RC3, SO32, Full Rate	X	3.64	67.4	18.8	3.39	142.3	±0.5 %
		Y	3.85	68.5	19.3		148.3	
		Z	3.59	66.7	18.3		139.6	
10297-AAA	LTE-FDD (SC-FDMA, 50% RB, 20 MHz, QPSK)	X	6.23	66.6	19.2	5.81	136.3	±1.4 %
		Y	6.42	67.4	19.7		142.8	
		Z	6.19	66.3	19.0		133.9	
10311-AAA	LTE-FDD (SC-FDMA, 100% RB, 15 MHz, QPSK)	X	6.84	67.3	19.6	6.06	142.4	±1.4 %
		Y	6.98	67.8	19.9		149.5	
		Z	6.75	66.8	19.3		140.0	
10317-AAB	IEEE 802.11a WiFi 5 GHz (OFDM, 6 Mbps, 96pc duty cycle)	X	10.13	68.9	21.3	8.36	147.4	±2.7 %
		Y	9.84	68.4	21.1		127.5	
		Z	10.04	68.7	21.2		143.2	
10400-AAB	IEEE 802.11ac WiFi (20MHz, 64-QAM, 99pc duty cycle)	X	10.24	69.0	21.4	8.37	148.6	±2.7 %
		Y	9.92	68.4	21.2		126.6	
		Z	10.14	68.8	21.3		144.6	
10401-AAB	IEEE 802.11ac WiFi (40MHz, 64-QAM, 99pc duty cycle)	X	10.60	68.6	21.2	8.60	129.4	±3.0 %
		Y	10.77	69.1	21.5		136.8	
		Z	10.52	68.4	21.1		125.9	
10402-AAB	IEEE 802.11ac WiFi (80MHz, 64-QAM, 99pc duty cycle)	X	10.60	68.5	20.9	8.53	129.7	±3.0 %
		Y	11.01	69.5	21.5		139.1	
		Z	10.54	68.3	20.8		126.7	
10403-AAB	CDMA2000 (1xEV-DO, Rev. 0)	X	5.07	70.1	19.4	3.76	127.5	±0.5 %
		Y	5.47	71.9	20.2		133.6	
		Z	4.93	69.5	19.0		124.9	
10404-AAB	CDMA2000 (1xEV-DO, Rev. A)	X	5.01	70.2	19.5	3.77	149.3	±0.7 %
		Y	5.38	71.9	20.2		132.0	
		Z	4.94	69.9	19.2		146.4	

10415-AAA	IEEE 802.11b WiFi 2.4 GHz (DSSS, 1 Mbps, 99pc duty cycle)	X	3.20	71.2	19.8	1.54	126.8	±0.7 %
		Y	3.51	72.6	20.4		134.5	
		Z	2.79	68.1	18.1		148.4	
10416-AAA	IEEE 802.11g WiFi 2.4 GHz (ERP-OFDM, 6 Mbps, 99pc duty cycle)	X	10.07	68.8	21.2	8.23	147.8	±2.7 %
		Y	9.81	68.4	21.1		128.4	
		Z	10.00	68.7	21.1		144.0	
10417-AAA	IEEE 802.11a/h WiFi 5 GHz (OFDM, 6 Mbps, 99pc duty cycle)	X	10.07	68.8	21.2	8.23	148.4	±2.7 %
		Y	9.82	68.4	21.1		129.0	
		Z	9.99	68.7	21.1		144.6	

The reported uncertainty of measurement is stated as the standard uncertainty of measurement multiplied by the coverage factor $k=2$, which for a normal distribution corresponds to a coverage probability of approximately 95%.

^A The uncertainties of NormX,Y,Z do not affect the E^2 -field uncertainty inside TSL (see Pages 8 and 9).

^B Numerical linearization parameter: uncertainty not required.

^E Uncertainty is determined using the max. deviation from linear response applying rectangular distribution and is expressed for the square of the field value.

DASY/EASY - Parameters of Probe: EX3DV4 - SN:3914

Calibration Parameter Determined in Head Tissue Simulating Media

f (MHz) ^C	Relative Permittivity ^F	Conductivity (S/m) ^F	ConvF X	ConvF Y	ConvF Z	Alpha ^G	Depth ^G (mm)	Unct. (k=2)
750	41.9	0.89	9.82	9.82	9.82	0.39	0.92	± 12.0 %
835	41.5	0.90	9.50	9.50	9.50	0.43	0.83	± 12.0 %
1750	40.1	1.37	8.04	8.04	8.04	0.30	0.93	± 12.0 %
1900	40.0	1.40	7.86	7.86	7.86	0.35	0.86	± 12.0 %
2450	39.2	1.80	7.02	7.02	7.02	0.28	1.05	± 12.0 %
2600	39.0	1.96	6.82	6.82	6.82	0.26	1.17	± 12.0 %
5200	36.0	4.66	5.26	5.26	5.26	0.35	1.80	± 13.1 %
5300	35.9	4.76	5.06	5.06	5.06	0.35	1.80	± 13.1 %
5500	35.6	4.96	4.92	4.92	4.92	0.40	1.80	± 13.1 %
5600	35.5	5.07	4.73	4.73	4.73	0.40	1.80	± 13.1 %
5800	35.3	5.27	4.67	4.67	4.67	0.40	1.80	± 13.1 %

^C Frequency validity above 300 MHz of ± 100 MHz only applies for DASY v4.4 and higher (see Page 2), else it is restricted to ± 50 MHz. The uncertainty is the RSS of the ConvF uncertainty at calibration frequency and the uncertainty for the indicated frequency band. Frequency validity below 300 MHz is ± 10, 25, 40, 50 and 70 MHz for ConvF assessments at 30, 64, 128, 150 and 220 MHz respectively. Above 5 GHz frequency validity can be extended to ± 110 MHz.

^F At frequencies below 3 GHz, the validity of tissue parameters (ϵ and σ) can be relaxed to ± 10% if liquid compensation formula is applied to measured SAR values. At frequencies above 3 GHz, the validity of tissue parameters (ϵ and σ) is restricted to ± 5%. The uncertainty is the RSS of the ConvF uncertainty for indicated target tissue parameters.

^G Alpha/Depth are determined during calibration. SPEAG warrants that the remaining deviation due to the boundary effect after compensation is always less than ± 1% for frequencies below 3 GHz and below ± 2% for frequencies between 3-6 GHz at any distance larger than half the probe tip diameter from the boundary.

DASY/EASY - Parameters of Probe: EX3DV4 - SN:3914

Calibration Parameter Determined in Body Tissue Simulating Media

f (MHz) ^C	Relative Permittivity ^F	Conductivity (S/m) ^F	ConvF X	ConvF Y	ConvF Z	Alpha ^G	Depth (mm) ^G	Unct. (k=2)
750	55.5	0.96	9.53	9.53	9.53	0.33	1.09	± 12.0 %
835	55.2	0.97	9.49	9.49	9.49	0.27	1.25	± 12.0 %
1750	53.4	1.49	7.78	7.78	7.78	0.51	0.79	± 12.0 %
1900	53.3	1.52	7.49	7.49	7.49	0.73	0.64	± 12.0 %
2450	52.7	1.95	7.15	7.15	7.15	0.69	0.64	± 12.0 %
2600	52.5	2.16	6.84	6.84	6.84	0.80	0.57	± 12.0 %
5200	49.0	5.30	4.50	4.50	4.50	0.45	1.90	± 13.1 %
5300	48.9	5.42	4.33	4.33	4.33	0.45	1.90	± 13.1 %
5500	48.6	5.65	3.91	3.91	3.91	0.50	1.90	± 13.1 %
5600	48.5	5.77	3.89	3.89	3.89	0.50	1.90	± 13.1 %
5800	48.2	6.00	4.01	4.01	4.01	0.55	1.90	± 13.1 %

^C Frequency validity above 300 MHz of ± 100 MHz only applies for DASY v4.4 and higher (see Page 2), else it is restricted to ± 50 MHz. The uncertainty is the RSS of the ConvF uncertainty at calibration frequency and the uncertainty for the indicated frequency band. Frequency validity below 300 MHz is ± 10, 25, 40, 50 and 70 MHz for ConvF assessments at 30, 64, 128, 150 and 220 MHz respectively. Above 5 GHz frequency validity can be extended to ± 110 MHz.

^F At frequencies below 3 GHz, the validity of tissue parameters (ϵ and σ) can be relaxed to ± 10% if liquid compensation formula is applied to measured SAR values. At frequencies above 3 GHz, the validity of tissue parameters (ϵ and σ) is restricted to ± 5%. The uncertainty is the RSS of the ConvF uncertainty for indicated target tissue parameters.

^G Alpha/Depth are determined during calibration. SPEAG warrants that the remaining deviation due to the boundary effect after compensation is always less than ± 1% for frequencies below 3 GHz and below ± 2% for frequencies between 3-6 GHz at any distance larger than half the probe tip diameter from the boundary.

Frequency Response of E-Field (TEM-Cell:ifi110 EXX, Waveguide: R22)

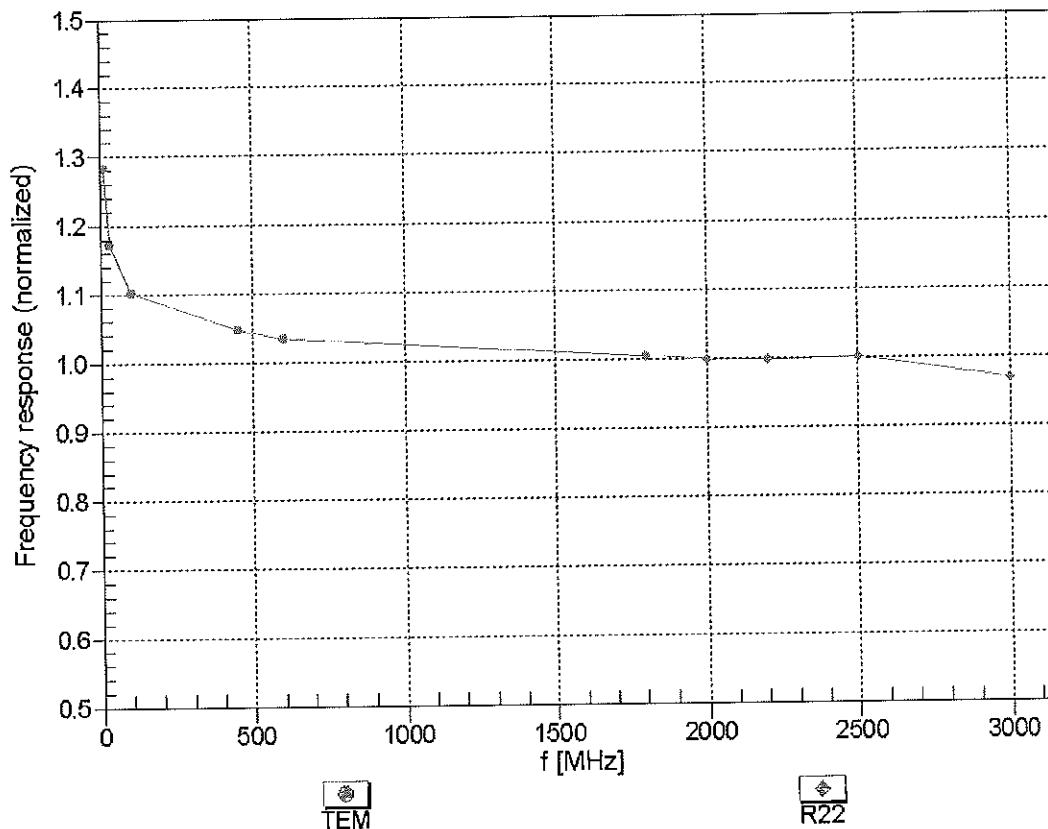

Uncertainty of Frequency Response of E-field: $\pm 6.3\%$ (k=2)

Receiving Pattern (ϕ), $\theta = 0^\circ$

f=600 MHz, TEM

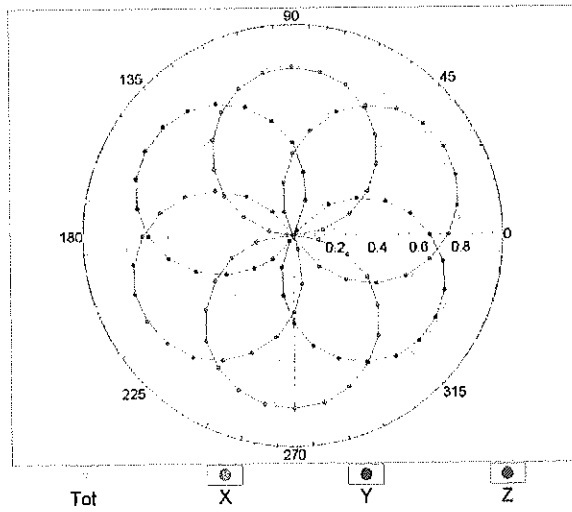

f=1800 MHz, R22

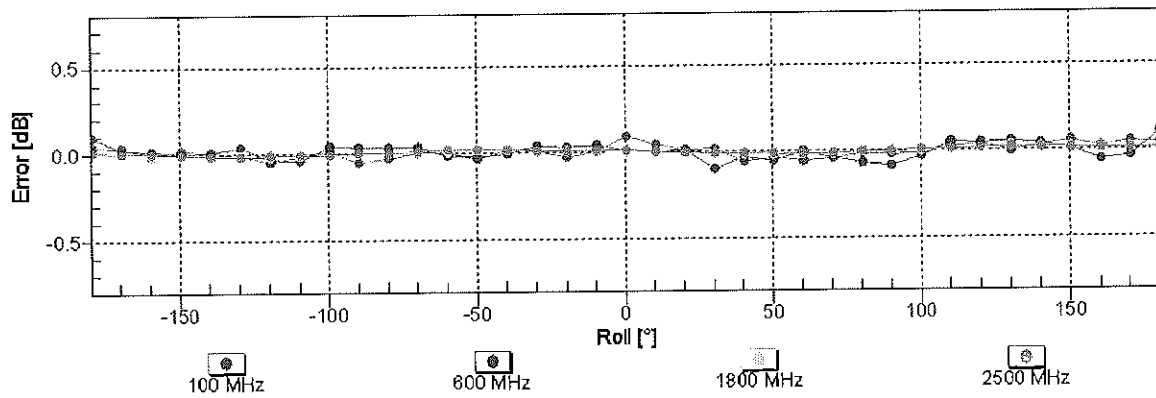
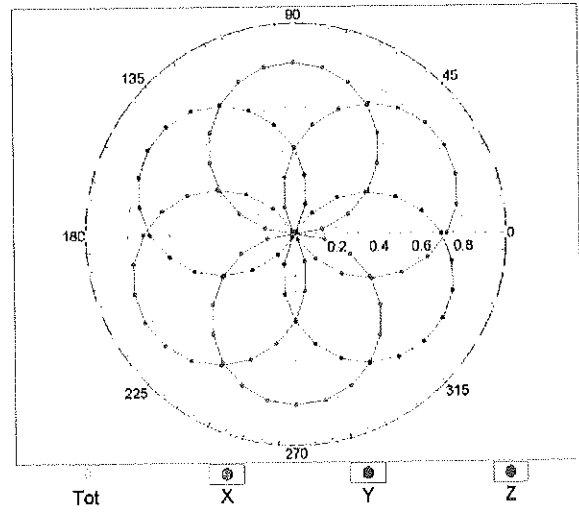

Uncertainty of Axial Isotropy Assessment: $\pm 0.5\%$ ($k=2$)

Dynamic Range f(SAR_{head}) (TEM cell , f_{eval}= 1900 MHz)

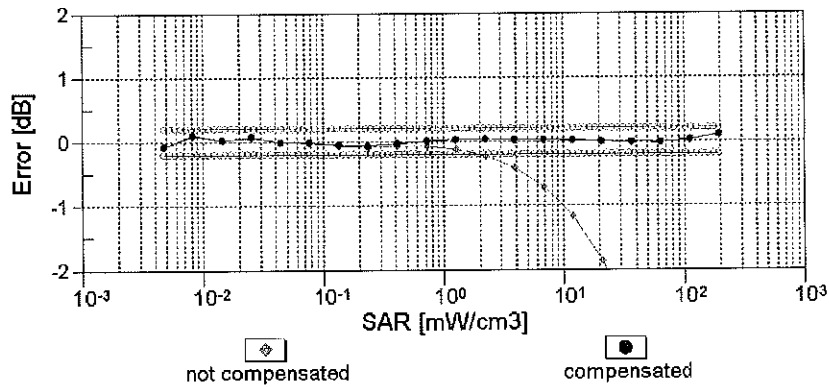
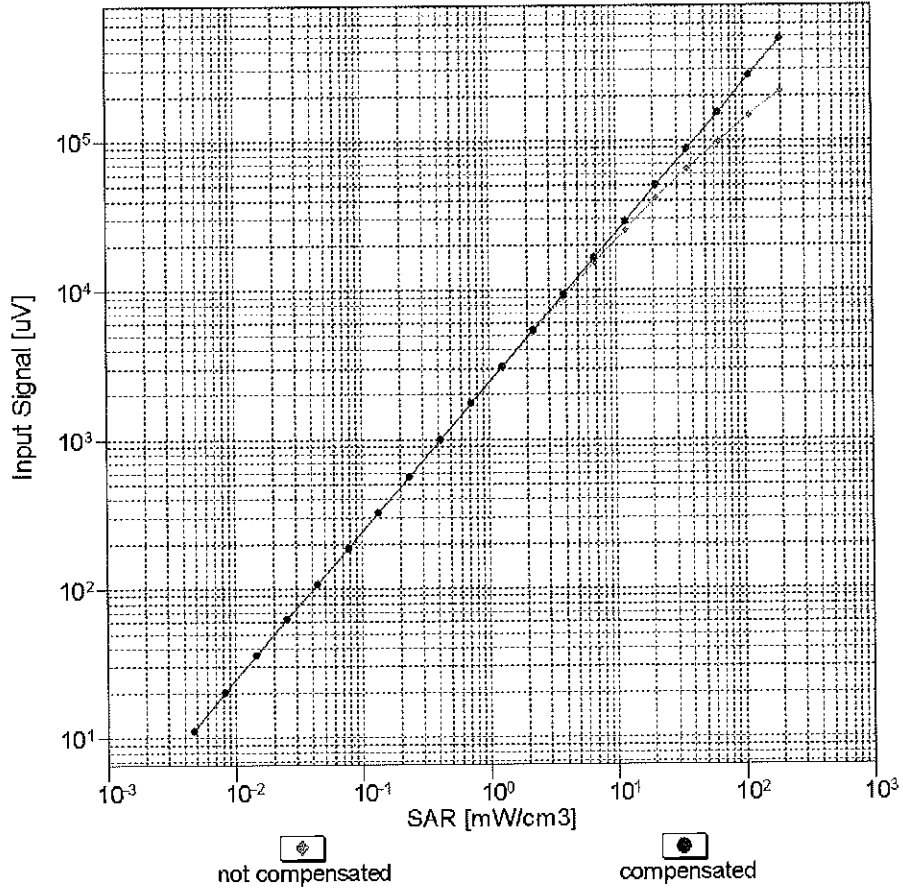

Uncertainty of Linearity Assessment: ± 0.6% (k=2)

Conversion Factor Assessment

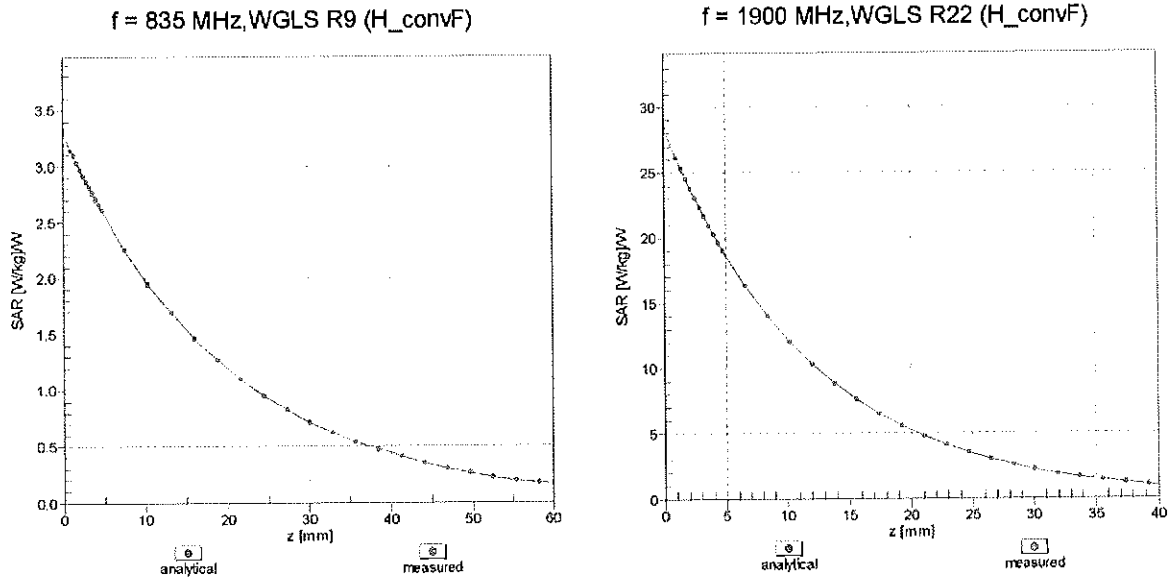

Deviation from Isotropy in Liquid Error (ϕ, θ), f = 900 MHz

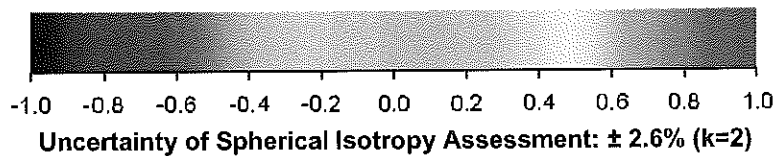
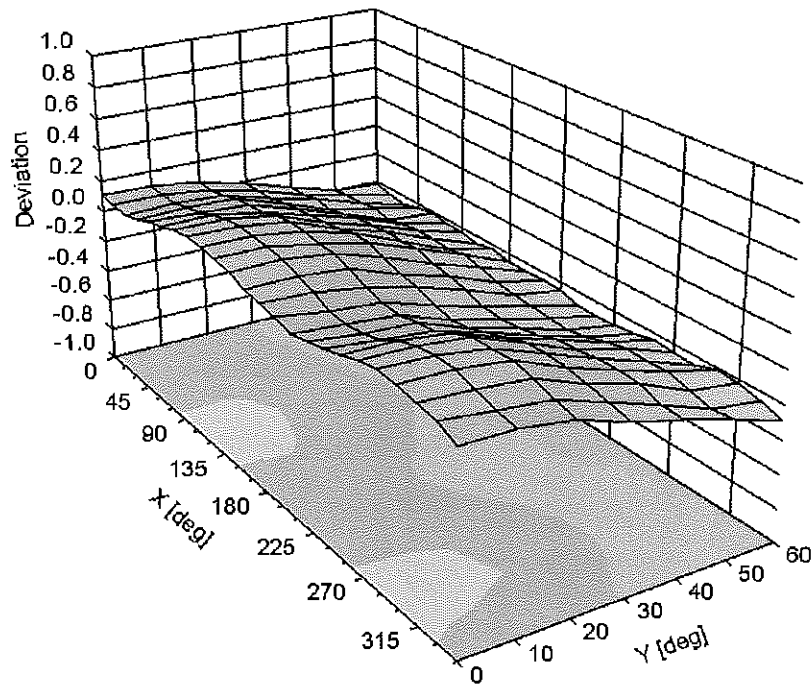

DASY/EASY - Parameters of Probe: EX3DV4 - SN:3914**Other Probe Parameters**

Sensor Arrangement	Triangular
Connector Angle (°)	-49.5
Mechanical Surface Detection Mode	enabled
Optical Surface Detection Mode	disabled
Probe Overall Length	337 mm
Probe Body Diameter	10 mm
Tip Length	9 mm
Tip Diameter	2.5 mm
Probe Tip to Sensor X Calibration Point	1 mm
Probe Tip to Sensor Y Calibration Point	1 mm
Probe Tip to Sensor Z Calibration Point	1 mm
Recommended Measurement Distance from Surface	1.4 mm

APPENDIX D: SAR TISSUE SPECIFICATIONS

Measurement Procedure for Tissue verification:



- 1) The network analyzer and probe system was configured and calibrated.
- 2) The probe was immersed in the tissue. The tissue was placed in a nonmetallic container. Trapped air bubbles beneath the flange were minimized by placing the probe at a slight angle.
- 3) The complex admittance with respect to the probe aperture was measured
- 4) The complex relative permittivity ϵ can be calculated from the below equation (Pournaropoulos and Misra):

$$Y = \frac{j2\omega\epsilon_r\epsilon_0}{[\ln(b/a)]^2} \int_a^b \int_a^b \int_0^\pi \frac{\cos\phi' \exp[-j\omega r(\mu_0\epsilon_r'\epsilon_0)^{1/2}]}{r} d\phi' d\rho' d\rho$$

where Y is the admittance of the probe in contact with the sample, the primed and unprimed coordinates refer to source and observation points, respectively, $r^2 = \rho^2 + \rho'^2 - 2\rho\rho' \cos\phi'$, ω is the angular frequency, and $j = \sqrt{-1}$.

**Table D-I
Composition of the Tissue Equivalent Matter**

Frequency (MHz)	750	750	835	835	1750	1750	1900	1900	2450 - 2600	2450 - 2600	5200-5800	5200-5800
Tissue	Head	Body	Head	Body	Head	Body	Head	Body	Head	Body	Head	Body
Ingredients (% by weight)												
Bactericide	See page 2-3	See page 2	0.1	0.1					See page 4	26.7	See page 5	
DGBE					47	31	44.92	29.44				
HEC			1	1								
NaCl			1.45	0.94	0.4	0.2	0.18	0.39				
Sucrose			57	44.9								
Polysorbate (Tween) 80												
Water			40.45	53.06	52.6	68.8	54.9	70.17				

FCC ID: ZNFH636		SAR EVALUATION REPORT		Reviewed by: Quality Manager
Test Dates: 03/17/15 - 04/20/15	DUT Type: Portable Handset			APPENDIX D: Page 1 of 5

2 Composition / Information on ingredients

The Item is composed of the following ingredients:

H ₂ O	Water, 35 – 58%
Sucrose	Sugar, white, refined, 40 – 60%
NaCl	Sodium Chloride, 0 – 6%
Hydroxyethyl-cellulose	Medium Viscosity (CAS# 9004-62-0), <0.3%
Preventol-D7	Preservative: aqueous preparation, (CAS# 55965-84-9), containing 5-chloro-2-methyl-3(2H)-isothiazolone and 2-methyl-3(2H)-isothiazolone, 0.1 – 0.7%

Relevant for safety; Refer to the respective Safety Data Sheet*.

**Figure D-1
Composition of 750 MHz Head and Body Tissue Equivalent Matter**

Note: 750MHz liquid recipes are proprietary SPEAG. Since the composition is approximate to the actual liquids utilized, the manufacturer tissue-equivalent liquid data sheets are provided below.

Measurement Certificate / Material Test

Item Name	Body Tissue Simulating Liquid (MSL750V2)
Product No.	SL AAM 075 AA (Charge: 130828-1)
Manufacturer	SPEAG

Measurement Method

TSL dielectric parameters measured using calibrated OCP probe.

Setup Validation

Validation results were within $\pm 2.5\%$ towards the target values of Methanol.

Target Parameters

Target parameters as defined in the IEEE 1528 and IEC 62209 compliance standards.

Test Condition

Ambient	Environment temperatur (22 ± 3)°C and humidity < 70%.
TSL Temperature	22°C
Test Date	28-Aug-13
Operator	IEN



Additional Information

TSL Density	1.212 g/cm ³
TSL Heat-capacity	3.006 kJ/(kg*K)

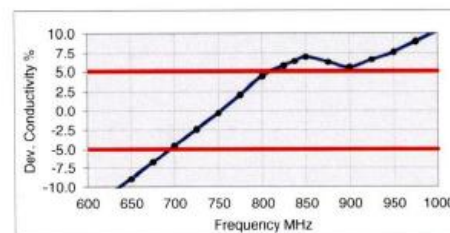
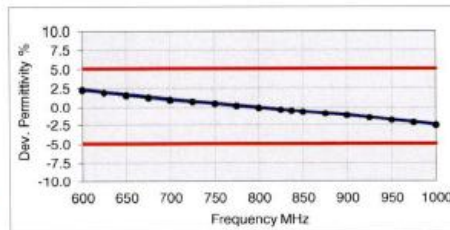
f [MHz]	Measured			Target		Diff.to Target [%]	
	HP-e'	HP-e''	sigma	eps	sigma	Δ-eps	Δ-sigma
600	57.4	24.76	0.83	56.1	0.95	2.3	-13.2
625	57.1	24.42	0.85	56.0	0.95	2.0	-11.0
650	56.8	24.09	0.87	55.9	0.96	1.6	-8.9
675	56.6	23.80	0.89	55.8	0.96	1.3	-6.7
700	56.3	23.52	0.92	55.7	0.96	1.0	-4.5
725	56.1	23.27	0.94	55.6	0.96	0.8	-2.4
750	55.8	23.03	0.96	55.5	0.96	0.5	-0.3
775	55.6	22.87	0.99	55.4	0.97	0.2	2.1
800	55.3	22.71	1.01	55.3	0.97	-0.1	4.5
825	55.1	22.54	1.03	55.2	0.98	-0.3	5.8
838	54.9	22.45	1.05	55.2	0.98	-0.5	6.4
850	54.8	22.37	1.06	55.2	0.99	-0.6	7.0
875	54.6	22.25	1.08	55.1	1.02	-0.9	6.2
900	54.4	22.13	1.11	55.0	1.05	-1.1	5.5
925	54.2	22.02	1.13	55.0	1.06	-1.5	6.6
950	53.9	21.91	1.16	54.9	1.08	-1.8	7.7
975	53.7	21.84	1.18	54.9	1.09	-2.2	9.0
1000	53.5	21.77	1.21	54.8	1.10	-2.5	10.3



**Figure D-2
750MHz Body Tissue Equivalent Matter**

FCC ID: ZNFH636		SAR EVALUATION REPORT		Reviewed by: Quality Manager
Test Dates: 03/17/15 - 04/20/15	DUT Type: Portable Handset			APPENDIX D: Page 2 of 5

Measurement Certificate / Material Test

Item Name	Head Tissue Simulating Liquid (HSL750V2)
Product No.	SL AAH 075 AA (Charge: 130826-2)
Manufacturer	SPEAG

Measurement Method

TSL dielectric parameters measured using calibrated OCP probe.

Setup Validation

Validation results were within $\pm 2.5\%$ towards the target values of Methanol.

Target Parameters

Target parameters as defined in the IEEE 1528 and IEC 62209 compliance standards.

Test Condition

Ambient	Environment temperatur (22 ± 3)°C and humidity < 70%.
TSL Temperature	22°C
Test Date	28-Aug-13
Operator	IEN

Additional Information

TSL Density	1.284 g/cm ³
TSL Heat-capacity	2.701 kJ/(kg*K)

f [MHz]	Measured			Target		Diff.to Target [%]	
	HP-e'	HP-e''	sigma	eps	sigma	Δ -eps	Δ -sigma
600	44.4	23.32	0.78	42.7	0.88	3.9	-11.7
625	44.0	23.05	0.80	42.6	0.88	3.4	-9.3
650	43.6	22.78	0.82	42.5	0.89	2.8	-7.0
675	43.3	22.54	0.85	42.3	0.89	2.2	-4.7
700	42.9	22.30	0.87	42.2	0.89	1.6	-2.4
725	42.6	22.10	0.89	42.1	0.89	1.2	0.0
750	42.3	21.90	0.91	41.9	0.89	0.8	2.3
775	41.9	21.74	0.94	41.8	0.90	0.2	4.6
800	41.6	21.57	0.96	41.7	0.90	-0.3	7.0
825	41.3	21.42	0.98	41.6	0.91	-0.8	8.4
838	41.1	21.35	0.99	41.5	0.91	-1.0	9.1
850	41.0	21.27	1.01	41.5	0.92	-1.3	9.8
875	40.7	21.14	1.03	41.5	0.94	-2.0	9.1
900	40.4	21.00	1.05	41.5	0.97	-2.6	8.4
925	40.1	20.89	1.07	41.5	0.98	-3.2	9.4
950	39.9	20.78	1.10	41.4	0.99	-3.8	10.4
975	39.6	20.69	1.12	41.4	1.00	-4.4	11.7
1000	39.3	20.60	1.15	41.3	1.01	-4.9	12.9

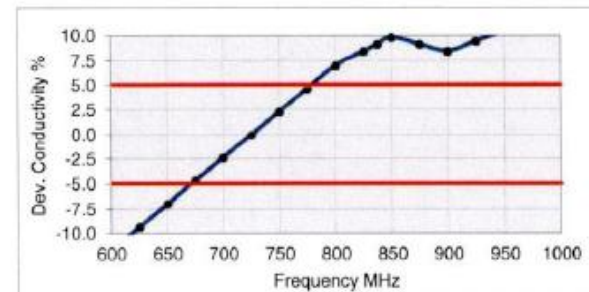
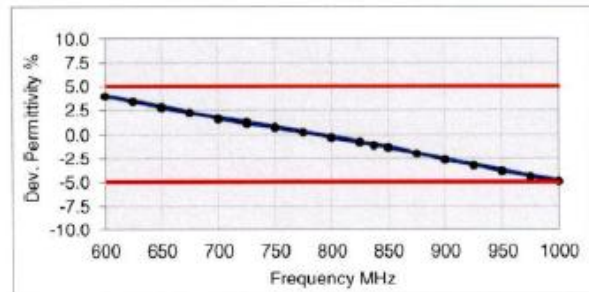



Figure D-3
750MHz Head Tissue Equivalent Matter

FCC ID: ZNFH636		SAR EVALUATION REPORT		Reviewed by: Quality Manager
Test Dates: 03/17/15 - 04/20/15	DUT Type: Portable Handset			APPENDIX D: Page 3 of 5

2 Composition / Information on ingredients

The Item is composed of the following ingredients:

H2O	Water, 52 – 75%
C8H18O3	Diethylene glycol monobutyl ether (DGBE), 25 – 48% (CAS-No. 112-34-5, EC-No. 203-961-6, EC-index-No. 603-096-00-8) Relevant for safety; Refer to the respective Safety Data Sheet*.
NaCl	Sodium Chloride, <1.0%

Figure D-4

Composition of 2.4 – 2.6 GHz Head Tissue Equivalent Matter

Note: 2.4 GHz head liquid recipes are proprietary SPEAG. Since the composition is approximate to the actual liquids utilized, the manufacturer tissue-equivalent liquid data sheets are provided below.

Measurement Certificate / Material Test

Item Name	Head Tissue Simulating Liquid (HSL2450V2)
Product No.	SL AAH 245 BA (Charge: 130926-1)
Manufacturer	SPEAG

Measurement Method

TSL dielectric parameters measured using calibrated OCP probe.

Setup Validation

Validation results were within $\pm 2.5\%$ towards the target values of Methanol.

Target Parameters

Target parameters as defined in the IEEE 1528 and IEC 62209 compliance standards.

Test Condition

Ambient	Environment temperature (22 ± 3)°C and humidity < 70%.
TSL Temperature	23°C
Test Date	2-Oct-13
Operator	CL

Additional Information

TSL Density	0.988 g/cm ³
TSL Heat-capacity	3.680 kJ/(kg·K)

f (MHz)	Measured			Target			Diff.to Target [%]	
	HP-e'	HP-e''	sigma	eps	sigma	Δ-eps	Δ-sigma	
1900	40.3	11.88	1.26	40.0	1.40	0.9	-10.3	
1925	40.3	11.98	1.28	40.0	1.40	0.6	-8.3	
1950	40.2	12.08	1.31	40.0	1.40	0.4	-6.4	
1975	40.1	12.15	1.34	40.0	1.40	0.2	-4.6	
2000	40.0	12.23	1.36	40.0	1.40	-0.1	-2.8	
2025	39.9	12.34	1.39	40.0	1.42	-0.2	-2.3	
2050	39.8	12.45	1.42	39.9	1.44	-0.3	-1.7	
2075	39.7	12.54	1.45	39.9	1.47	-0.4	-1.3	
2100	39.6	12.64	1.48	39.8	1.49	-0.5	-0.8	
2125	39.5	12.69	1.50	39.8	1.51	-0.7	-0.7	
2150	39.4	12.75	1.52	39.7	1.53	-0.8	-0.6	
2175	39.3	12.84	1.55	39.7	1.56	-1.0	-0.1	
2200	39.2	12.94	1.58	39.6	1.58	-1.2	0.4	
2225	39.1	13.00	1.61	39.6	1.60	-1.3	0.6	
2250	39.0	13.07	1.64	39.6	1.62	-1.4	0.8	
2275	38.9	13.15	1.66	39.5	1.64	-1.5	1.2	
2300	38.8	13.22	1.69	39.5	1.67	-1.7	1.5	
2325	38.7	13.32	1.72	39.4	1.69	-1.9	2.0	
2350	38.6	13.42	1.75	39.4	1.71	-2.0	2.5	
2375	38.5	13.49	1.78	39.3	1.73	-2.1	2.8	
2400	38.4	13.56	1.81	39.3	1.76	-2.3	3.1	
2425	38.3	13.63	1.84	39.2	1.78	-2.5	3.5	
2450	38.2	13.71	1.87	39.2	1.80	-2.6	3.8	
2475	38.1	13.79	1.90	39.2	1.83	-2.8	3.9	
2500	38.0	13.87	1.93	39.1	1.85	-3.0	4.0	
2525	37.9	13.96	1.96	39.1	1.88	-3.1	4.2	
2550	37.8	14.05	1.99	39.1	1.91	-3.3	4.4	
2575	37.7	14.11	2.02	39.0	1.94	-3.5	4.4	
2600	37.5	14.17	2.05	39.0	1.96	-3.8	4.4	
2625	37.4	14.23	2.08	39.0	1.99	-4.0	4.4	
2650	37.3	14.30	2.11	38.9	2.02	-4.2	4.5	
2675	37.2	14.37	2.14	38.9	2.05	-4.4	4.6	
2700	37.1	14.45	2.17	38.9	2.07	-4.6	4.7	

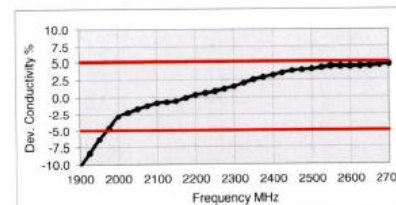
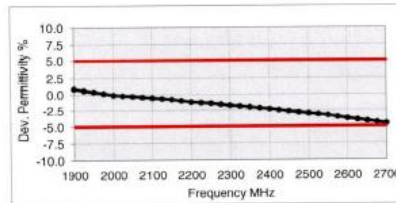



Figure D-5

2.4 – 2.6 GHz Head Tissue Equivalent Matter

FCC ID: ZNFH636		SAR EVALUATION REPORT		Reviewed by: Quality Manager
Test Dates: 03/17/15 - 04/20/15	DUT Type: Portable Handset			APPENDIX D: Page 4 of 5

2 Composition / Information on ingredients

The Item is composed of the following ingredients:

Water	50 – 65%
Mineral oil	10 – 30%
Emulsifiers	8 – 25%
Sodium salt	0 – 1.5%

Figure D-6

Composition of 5 GHz Head Tissue Equivalent Matter

Note: 5GHz head liquid recipes are proprietary SPEAG. Since the composition is approximate to the actual liquids utilized, the manufacturer tissue-equivalent liquid data sheets are provided below.

Measurement Certificate / Material Test

Item Name	Head Tissue Simulating Liquid (HBBL3500-5800V5)
Product No.	SL AAH 502 AC (Charge: 130903-1)
Manufacturer	SPEAG
Measurement Method	
TSL dielectric parameters measured using calibrated OCP probe.	
Setup Validation	
Validation results were within $\pm 2.5\%$ towards the target values of Methanol.	
Target Parameters	
Target parameters as defined in the IEEE 1528 and IEC 62209 compliance standards.	
Test Condition	
Ambient	Environment temperatur ($22 \pm 3^\circ\text{C}$ and humidity $< 70\%$).
TSL Temperature	22°C
Test Date	4-Sep-13
Operator	IEN
Additional Information	
TSL Density	0.985 g/cm^3
TSL Heat-capacity	$3.383 \text{ kJ/(kg}\cdot\text{K)}$

f [MHz]	Measured			Target		Diff to Target [%]	
	HP-e'	HP-e''	sigma	eps	sigma	Δ-eps	Δ-sigma
3400	38.7	15.01	2.84	38.0	2.81	1.7	1.1
3500	38.5	14.98	2.92	37.9	2.91	1.5	0.3
3600	38.4	14.98	3.00	37.8	3.02	1.5	-0.5
3700	38.3	14.97	3.08	37.7	3.12	1.6	-1.2
3800	38.2	14.95	3.16	37.6	3.22	1.6	-1.9
3900	38.1	14.96	3.25	37.5	3.32	1.7	-2.2
4000	37.9	14.98	3.33	37.4	3.43	1.5	-2.8
4100	37.8	15.00	3.42	37.2	3.53	1.5	-3.0
4200	37.7	15.04	3.51	37.1	3.63	1.5	-3.3
4300	37.6	15.10	3.61	37.0	3.73	1.6	-3.3
4400	37.4	15.16	3.71	36.9	3.84	1.4	-3.3
4500	37.3	15.22	3.81	36.8	3.94	1.4	-3.2
4600	37.2	15.29	3.91	36.7	4.04	1.4	-3.2
4700	37.0	15.34	4.01	36.6	4.14	1.2	-3.2
4800	36.9	15.41	4.11	36.4	4.25	1.3	-3.2
4850	36.8	15.43	4.16	36.4	4.30	1.1	-3.2
4900	36.8	15.47	4.22	36.3	4.35	1.3	-2.9
4950	36.7	15.49	4.28	36.3	4.40	1.2	-3.2
5000	36.6	15.52	4.32	36.2	4.45	1.1	-2.9
5050	36.5	15.55	4.37	36.2	4.50	0.9	-2.9
5100	36.5	15.59	4.42	36.1	4.55	1.1	-2.9
5150	36.4	15.62	4.47	36.0	4.60	1.0	-2.9
5200	36.3	15.65	4.53	36.0	4.66	0.9	-2.7
5250	36.2	15.67	4.58	35.9	4.71	0.8	-2.7
5300	36.2	15.71	4.63	35.9	4.76	0.9	-2.7
5350	36.1	15.73	4.68	35.8	4.81	0.8	-2.7
5400	36.0	15.75	4.73	35.8	4.86	0.7	-2.7
5450	35.9	15.78	4.78	35.7	4.91	0.6	-2.7
5500	35.9	15.79	4.83	35.6	4.96	0.7	-2.7
5550	35.8	15.83	4.89	35.6	5.01	0.6	-2.5
5600	35.7	15.86	4.94	35.5	5.07	0.5	-2.5
5650	35.7	15.89	5.00	35.5	5.12	0.6	-2.3
5700	35.6	15.92	5.05	35.4	5.17	0.5	-2.3
5750	35.5	15.96	5.11	35.4	5.22	0.4	-2.1
5800	35.5	15.97	5.15	35.3	5.27	0.6	-2.3
5850	35.4	16.02	5.21	35.3	5.34	0.3	-2.3
5900	35.3	16.03	5.26	35.3	5.40	0.0	-2.6

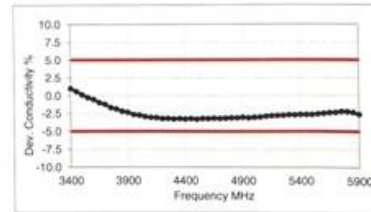
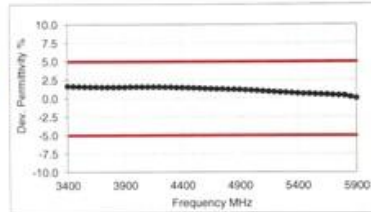



Figure D-7
5GHz Head Tissue Equivalent Matter

FCC ID: ZNFH636		SAR EVALUATION REPORT		Reviewed by: Quality Manager
Test Dates: 03/17/15 - 04/20/15	DUT Type: Portable Handset			APPENDIX D: Page 5 of 5

APPENDIX E: SAR SYSTEM VALIDATION

Per FCC KDB 865664 D02v01, SAR system validation status should be documented to confirm measurement accuracy. The SAR systems (including SAR probes, system components and software versions) used for this device were validated against its performance specifications prior to the SAR measurements. Reference dipoles were used with the required tissue- equivalent media for system validation, according to the procedures outlined in FCC KDB 865664 D01 v01 and IEEE 1528-2013. Since SAR probe calibrations are frequency dependent, each probe calibration point was validated at a frequency within the valid frequency range of the probe calibration point, using the system that normally operates with the probe for routine SAR measurements and according to the required tissue-equivalent media.

A tabulated summary of the system validation status including the validation date(s), measurement frequencies, SAR probes and tissue dielectric parameters has been included.



Table E-I
SAR System Validation Summary – 1 g

SAR SYSTEM #	FREQ. [MHz]	DATE	PROBE SN	PROBE TYPE	PROBE CAL. POINT		COND.	PERM.	CW VALIDATION			MOD. VALIDATION		
							(σ)	(ϵ_r)	SENSI-TIVITY	PROBE LINEARITY	PROBE ISOTROPY	MOD. TYPE	DUTY FACTOR	PAR
J	750	9/26/2014	3022	ES3DV2	750	Head	0.916	40.24	PASS	PASS	PASS	N/A	N/A	N/A
K	835	10/13/2014	3288	ES3DV3	835	Head	0.926	41.94	PASS	PASS	PASS	GMSK	PASS	N/A
B	1750	1/4/2015	3334	ES3DV3	1750	Head	1.369	39.91	PASS	PASS	PASS	N/A	N/A	N/A
G	1900	3/23/2015	3213	ES3DV3	1900	Head	1.432	39.95	PASS	PASS	PASS	GMSK	PASS	N/A
K	2450	10/14/2014	3288	ES3DV3	2450	Head	1.867	37.78	PASS	PASS	PASS	OFDM/TDD	PASS	PASS
H	5300	3/23/2015	3920	EX3DV4	5300	Head	4.589	37.29	PASS	PASS	PASS	OFDM	N/A	PASS
H	5500	3/23/2015	3920	EX3DV4	5500	Head	4.818	37.05	PASS	PASS	PASS	OFDM	N/A	PASS
H	5800	3/23/2015	3920	EX3DV4	5800	Head	5.123	36.61	PASS	PASS	PASS	OFDM	N/A	PASS
D	750	10/20/2014	3263	ES3DV3	750	Body	0.971	55.55	PASS	PASS	PASS	N/A	N/A	N/A
C	835	11/11/2014	3333	ES3DV3	835	Body	0.948	53.05	PASS	PASS	PASS	GMSK	PASS	N/A
B	1750	1/4/2015	3334	ES3DV3	1750	Body	1.527	51.87	PASS	PASS	PASS	N/A	N/A	N/A
J	1900	9/4/2014	3022	ES3DV2	1900	Body	1.555	52.66	PASS	PASS	PASS	GMSK	PASS	N/A
G	2450	3/17/2015	3213	ES3DV3	2450	Body	2.028	50.80	PASS	PASS	PASS	OFDM/TDD	PASS	PASS
B	2450	1/5/2015	3334	ES3DV3	2450	Body	2.044	50.90	PASS	PASS	PASS	OFDM/TDD	PASS	PASS
A	5300	2/19/2015	3914	EX3DV4	5300	Body	5.181	47.44	PASS	PASS	PASS	OFDM	N/A	PASS
A	5500	2/19/2015	3914	EX3DV4	5500	Body	5.464	46.92	PASS	PASS	PASS	OFDM	N/A	PASS
A	5800	2/19/2015	3914	EX3DV4	5800	Body	5.942	46.31	PASS	PASS	PASS	OFDM	N/A	PASS

Table E-II
SAR System Validation Summary – 10 g

SAR SYSTEM #	FREQ. [MHz]	DATE	PROBE SN	PROBE TYPE	PROBE CAL. POINT		COND.	PERM.	CW VALIDATION			MOD. VALIDATION		
							(σ)	(ϵ_r)	SENSI-TIVITY	PROBE LINEARITY	PROBE ISOTROPY	MOD. TYPE	DUTY FACTOR	PAR
B	2450	1/5/2015	3334	ES3DV3	2450	Body	2.044	50.90	PASS	PASS	PASS	OFDM/TDD	PASS	PASS
A	5300	2/19/2015	3914	EX3DV4	5300	Body	5.181	47.44	PASS	PASS	PASS	OFDM	N/A	PASS
A	5500	2/19/2015	3914	EX3DV4	5500	Body	5.464	46.92	PASS	PASS	PASS	OFDM	N/A	PASS

NOTE: While the probes have been calibrated for both CW and modulated signals, all measurements were performed using communication systems calibrated for CW signals only. Modulations in the table above represent test configurations for which the measurement system has been validated per FCC KDB Publication 865664 D01v01 for scenarios when CW probe calibrations are used with other signal types. SAR systems were validated for modulated signals with a periodic duty cycle, such as GMSK, or with a high peak to average ratio (>5 dB), such as OFDM according to KDB 865664.

FCC ID: ZNFH636		SAR EVALUATION REPORT		Reviewed by: Quality Manager
Test Dates: 03/17/15 - 04/20/15	DUT Type: Portable Handset	APPENDIX E: Page 1 of 1		