

# RF TEST REPORT

Test item : GSM/WCDMA/LTE Phone with Bluetooth, WLAN and NFC  
Model No. : LG-H635CX, LGH635CX, H630CX, LG-H635cx, LGH635cx, H635cx  
Order No. : DTNC1510-05038  
Date of receipt : 2015-04-24  
Test duration : 2015-04-25 ~ 2015-05-15, 2015-05-22 ~ 2015-06-01  
Date of issue : 2015-10-27  
Use of report : FCC Original Grant

Applicant : LG Electronics MobileComm U.S.A., Inc.  
1000 Sylvan Avenue, Englewood Cliffs NJ 07632

Test laboratory : DT&C Co., Ltd.  
42, Yurim-ro, 154beon-gil, Cheoin-gu, Yongin-si, Gyeonggi-do, Korea 449-935

Test specification : FCC Part 22, 24, 27  
Test environment : See appended test report  
Test result :  Pass  Fail

The test results presented in this test report are limited only to the sample supplied by applicant and the use of this test report is inhibited other than its purpose. This test report shall not be reproduced except in full, without the written approval of DT&C Co., Ltd.

Tested by:

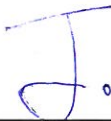

Engineer  
Jaejin Lee

Reviewed by:

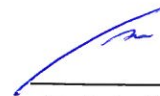

Technical Manager  
Geunki Son

## Test Report Version

Test Report No.	Date	Description
DRTFCC1510-0222	Oct. 27, 2015	Initial issue <sup>Note</sup>

Note: ZNFH635CX used same hardware with ZNFH630. Just enabled the WCDMA B4 function by software. All of performance is same with ZNFH630, and used same result data.

# Table of Contents

<b>1. GENERAL INFORMATION .....</b>	<b>5</b>
<b>2. INTRODUCTION .....</b>	<b>6</b>
2.1 EUT DESCRIPTION .....	6
2.2 MEASURING INSTRUMENT CALIBRATION.....	6
2.3 TEST FACILITY.....	6
<b>3. DESCRIPTION OF TESTS.....</b>	<b>7</b>
3.1 ERP&EIRP .....	7
3.2 PEAK TO AVERAGE RATIO .....	9
3.3 OCCUPIED BANDWIDTH.....	10
3.4 BAND EDGE EMISSIONS (Conducted).....	11
3.5 SPURIOUS AND HARMONIC EMISSIONS (Conducted).....	12
3.6 UNDESIRABLE EMISSIONS (Radiated).....	13
3.7 FREQUENCY STABILITY .....	14
<b>4. LIST OF TEST EQUIPMENT .....</b>	<b>15</b>
<b>5. SUMMARY OF TEST RESULTS.....</b>	<b>16</b>
<b>6. SAMPLE CALCULATION .....</b>	<b>17</b>
<b>7. TEST DATA.....</b>	<b>19</b>
7.1 OCCUPIED BANDWIDTH.....	19
7.2 PEAKTOAVERAGERATIO.....	19
7.3 BAND EDEG EMISSIONS (Conducted).....	19
7.4 SPURIOUS AND HARMONICS EMISSIONS (Conducted) .....	19
7.5 EQUIVALENT ISOTROPIC RADIATED POWER .....	20
7.5.1 LTE Band 4.....	20
7.5.2 LTE Band 2.....	21
7.5.3 LTE Band 7.....	22
7.6 UNDESIRABLE EMISSIONS (Radiated).....	23
7.6.1 LTE Band 4.....	23
7.6.2 LTE Band 2.....	26
7.6.3 LTE Band 7.....	29
7.7 FREQUENCY STABILITY .....	31
7.7.1 LTE Band 4.....	31
7.7.2 LTE Band 2.....	32
7.7.3 LTE Band 7.....	33
<b>8. TEST PLOTS .....</b>	<b>34</b>
8.1 OCCUPIED BANDWIDTH.....	34
8.1.1 LTE Band 4.....	34
8.1.2 LTE Band 2.....	40
8.1.3 LTE Band 7.....	46
8.2 PEAK TO AVERAGE RATIO .....	50
8.2.1 LTE Band 4.....	50

8.2.2 LTE Band 2..... 56

8.3 BAND EDGE EMISSIONS(Conducted)..... 62

8.3.1 LTE Band 4..... 62

8.3.2 LTE Band 2..... 74

8.3.3 LTE Band 7..... 86

8.4 SPURIOUS AND HARMONICS EMISSIONS(Conducted) ..... 92

8.4.1 LTE Band 4..... 92

8.4.2 LTE Band 2..... 110

8.4.3 LTE Band 7..... 128

**1. GENERAL INFORMATION****Applicant Name:** LG Electronics MobileComm U.S.A., Inc.**Address:** 1000 Sylvan Avenue, Englewood Cliffs NJ 07632**FCC ID** : ZNFH635CX**FCC Classification** : Licensed Portable Transmitter Held to Ear (PCE)  
**EUT Type** : GSM/WCDMA/LTE Phone with Bluetooth, WLAN and NFC**Model Name** : LG-H635CX**Add Model Name** : LGH635CX, H630CX, LG-H635cx, LGH635cx, H635cx**Supplying power** : DC 3.85 V**Antenna Information** : Internal Antenna

Mode	TX Frequency (MHz)	Emission Designator	Modulation	ERP/EIRP	
				Max power(dBm)	Max power(W)
LTE Band 4	1710.7 ~ 1754.3	1M08G7D	QPSK	24.60	0.288
LTE Band 4	1710.7 ~ 1754.3	1M09W7D	16QAM	23.95	0.248
LTE Band 4	1711.5 ~ 1753.5	2M70G7D	QPSK	24.64	0.291
LTE Band 4	1711.5 ~ 1753.5	2M69W7D	16QAM	23.94	0.248
LTE Band 4	1712.5 ~ 1752.5	4M49G7D	QPSK	24.13	0.259
LTE Band 4	1712.5 ~ 1752.5	4M50W7D	16QAM	22.79	0.190
LTE Band 4	1715 ~ 1750	8M97G7D	QPSK	24.87	0.307
LTE Band 4	1715 ~ 1750	8M95W7D	16QAM	23.82	0.241
LTE Band 4	1717.5 ~ 1747.5	13M4G7D	QPSK	25.03	0.318
LTE Band 4	1717.5 ~ 1747.5	13M4W7D	16QAM	24.15	0.260
LTE Band 4	1720 ~ 1745	17M9G7D	QPSK	25.03	0.318
LTE Band 4	1720 ~ 1745	17M9W7D	16QAM	24.07	0.255
LTE Band 2	1850.7 ~ 1909.3	1M08G7D	QPSK	24.82	0.303
LTE Band 2	1850.7 ~ 1909.3	1M09W7D	16QAM	24.10	0.257
LTE Band 2	1851.5 ~ 1908.5	2M71G7D	QPSK	25.40	0.347
LTE Band 2	1851.5 ~ 1908.5	2M69W7D	16QAM	24.73	0.297
LTE Band 2	1852.5 ~ 1907.5	4M50G7D	QPSK	25.17	0.329
LTE Band 2	1852.5 ~ 1907.5	4M49W7D	16QAM	24.36	0.273
LTE Band 2	1855 ~ 1905	8M96G7D	QPSK	25.03	0.318
LTE Band 2	1855 ~ 1905	8M96W7D	16QAM	24.50	0.282
LTE Band 2	1857.5 ~ 1902.5	13M4G7D	QPSK	25.27	0.337
LTE Band 2	1857.5 ~ 1902.5	13M4W7D	16QAM	24.36	0.273
LTE Band 2	1860 ~ 1900	17M9G7D	QPSK	25.21	0.332
LTE Band 2	1860 ~ 1900	17M9W7D	16QAM	24.31	0.270
LTE Band 7	2502.5 ~ 2567.5	4M49G7D	QPSK	23.32	0.215
LTE Band 7	2502.5 ~ 2567.5	4M50W7D	16QAM	22.23	0.167
LTE Band 7	2505 ~ 2565	8M97G7D	QPSK	23.42	0.220
LTE Band 7	2505 ~ 2565	8M97W7D	16QAM	22.51	0.178
LTE Band 7	2507.5 ~ 2562.5	13M5G7D	QPSK	23.33	0.215
LTE Band 7	2507.5 ~ 2562.5	13M4W7D	16QAM	22.36	0.172
LTE Band 7	2510 ~ 2560	17M9G7D	QPSK	23.67	0.233
LTE Band 7	2510 ~ 2560	17M9W7D	16QAM	22.60	0.182

## 2. INTRODUCTION

### 2.1 EUT DESCRIPTION

The Equipment under Test (EUT) supports 850/1900 GSM/GPRS/EDGE, 850/1900 WCDMA/HSPA, Band 4 (1.4, 3, 5, 10, 15, 20 MHz BW), Band 2 (1.4, 3, 5, 10, 15, 20 MHz BW), Band 7 (5, 10, 15, 20 MHz BW) LTE, 802.11 b/g/n WLAN, Bluetooth (BDR, EDR, LE) and NFC

### 2.2 MEASURING INSTRUMENT CALIBRATION

The measuring equipment, which was utilized in performing the tests documented herein, has been calibrated in accordance with the manufacturer's recommendations for utilizing calibration equipment, which is traceable to recognized national standards.

### 2.3 TEST FACILITY

The 3M test site and conducted measurement facility used to collect the radiated data are located at the 42, Yurim-ro, 154beon-gil, Cheoin-gu, Yongin-si, Gyeonggi-do, Korea 449-935. The site is constructed in conformance with the requirements.

- 3M test site registration Number: 165783

### 3. DESCRIPTION OF TESTS

#### 3.1 ERP&EIRP

(Effective Radiated Power & Equivalent Isotropic Radiated Power)

##### *Test Set-up*

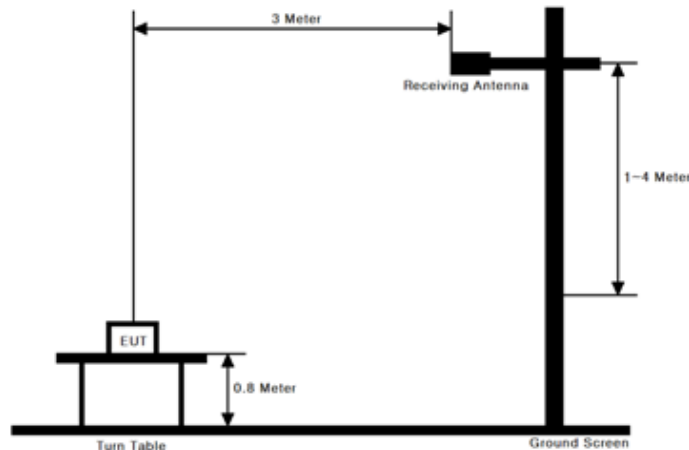

##### *Test Procedure*

- ANSI/TIA-603-C-2004 - Section 2.2.17
- KDB971168 v02r02 - Section 5.2.1

These measurements were performed at 3 & 10 m test site. The equipment under test is placed on a non-conductive table 0.8-meters above a turntable which is flush with the ground plane and 3 meters from the receive antenna.

##### Test setting

1. Set span to at least 1.5 times the OBW.
  2. Set RBW = 1-5 % of the OBW, not to exceed 1 MHz.
  3. Set VBW  $\geq 3 \times$  RBW.
  4. Set number of points in sweep  $\geq 2 \times$  span / RBW.
  5. Sweep time = auto couple.
  6. Detector = RMS (power averaging).
  7. If the EUT can be configured to transmit continuously (i.e., burst duty cycle  $\geq 98$  %), then set the trigger to free run.
  8. If the EUT cannot be configured to transmit continuously (i.e., burst duty cycle  $< 98$  %), then use a sweep trigger with the level set to enable triggering only on full power bursts and configure the EUT to transmit at full power for the entire duration of each sweep.
- Ensure that the sweep time is less than or equal to the transmission burst duration.
9. Trace average at least 100 traces in power averaging (i.e., RMS) mode.
  10. Compute the power by integrating the spectrum across the OBW of the signal using the instrument's band power measurement function, with the band limits set equal to the OBW band edges. If the instrument does not have a band power function, then sum the spectrum levels (in linear power units) at intervals equal to the RBW extending across the entire OBW of the spectrum.

The receive antenna height and turntable rotations were adjusted for the highest reading on the receive spectrum analyzer.

A half-wave dipole was substituted in place of the EUT. This dipole antenna was driven by a signal generator and the level of the signal generator was adjusted to obtain the same receive spectrum analyzer reading. The conducted power at the terminal of the substitute antenna is measured.

The ERP/EIRP is calculated using the following formula:

**ERP/EIRP = The conducted power at the substitute antenna's terminal [dBm] + Substitute Antenna gain [dBd for ERP , dBi for EIRP]**

For readings above 1 GHz, the above procedure is repeated using horn antennas and the difference between the gain of the horn antenna and an isotropic antenna are taken into consideration.



## 3.2 PEAK TO AVERAGE RATIO

### Test set-up

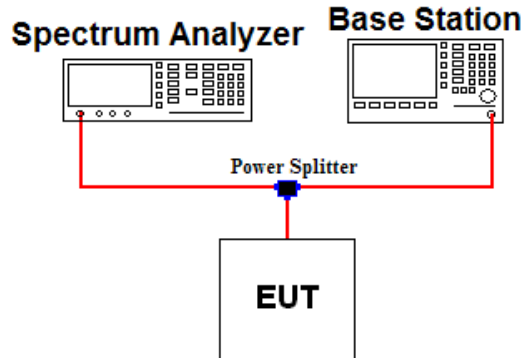

### Test Procedure

- KDB971168 v02r02 - Section 5.7.1

A peak to average ratio measurement is performed at the conducted port of the EUT. The spectrum analyzers Complementary Cumulative Distribution Function (CCDF) measurement profile is used to determine the largest deviation between the average and the peak power of the EUT in a given bandwidth. The CCDF curve shows how much time the peak waveform spends at or above a given average power level. The present of time the signal spends at or above the level defines the probability for that particular power level.

### Test setting

The spectrum Analyzer`s CCDF measurement function is enabled.

1. Set resolution/measurement bandwidth  $\geq$  signal`s occupied bandwidth.
2. Set the number of counts to a value that stabilizes the measured CCDF curve
3. Set the measurement interval as follows:
  - 1) For continuous transmissions, set to 1 ms.
  - 2) For burst transmissions, employ an external trigger that is synchronized with the EUT burst timing sequence, or use the internal burst trigger with a trigger level that allows the burst to stabilize and set the measurement interval to a time that is less than or equal to the burst duration.
4. Record the maximum PAPR level associated with a probability of 0.1 %

### 3.3 OCCUPIED BANDWIDTH.

#### Test set-up

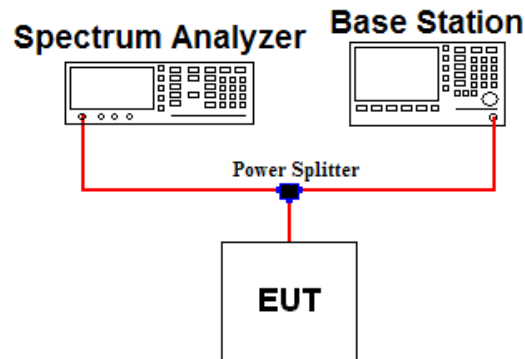

#### Test Procedure

- KDB971168 v02r02 - Section 4.2

The occupied bandwidth, that is the frequency bandwidth such that, below its lower and above its upper frequency limits, the mean powers radiated are each equal to 0.5 percent of the total mean power of a given emission.

#### Test setting

1. The signal analyzer's automatic bandwidth measurement capability was used to perform the 99 % occupied bandwidth and the 26 dB bandwidth. The bandwidth measurement was not influenced by any intermediate power nulls in the fundamental emission.
2.  $RBW = 1 \sim 5 \%$  of the expected OBW &  $VBW \geq 3 \times RBW$
3. Detector = Peak
4. Trance mode = Max hold
5. Sweep = Auto couple
6. The trace was allowed to stabilize
7. If necessary, step 2 ~ 6 were repeated after changing the RBW such that it would be within 1 ~ 5 % of the 99 % occupied bandwidth observed in step 6.

### 3.4 BAND EDGE EMISSIONS (Conducted)

#### Test set-up

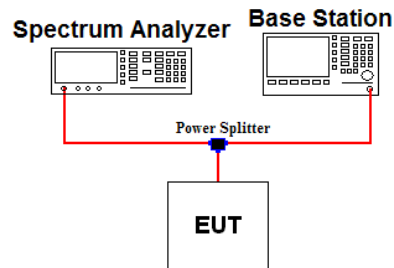

#### Test Procedure

##### - KDB971168 v02r02 - Section 6.0

All out of band emissions are measured by means of a calibrated spectrum analyzer. The EUT was setup to maximum output power at its lowest and highest channel with all bandwidths, modulations and RB configurations.

The power of any spurious emission shall be attenuated below the transmitter power ( $P$ ) by at least  $43 + 10 \log(P)$  dB or requirements on note 2 in case of band 7 and 41.

#### Test setting

1. Start and stop frequency were set such that the band edge would be placed in the center of the plot
2. Span was set large enough so as to capture all out of band emissions near the band edge
3. RBW  $\geq 1\%$  of the emission bandwidth or  $2\%$  of the emission bandwidth (refer to note 2)
4. VBW  $\geq 3 \times$  RBW
5. Detector = RMS & Trace mode = Max hold
6. Sweep time = Auto couple or 1 s for band edge
7. Number of sweep point  $\geq 2 \times$  span / RBW
8. The trace was allowed to stabilize

Note 1: In the 1 MHz bands immediately outside and adjacent to the frequency block a resolution bandwidth of **at least one percent** of the emission bandwidth of the fundamental emission of the transmitter may be employed to demonstrate compliance with the out-of-band emissions limit. The emission bandwidth is defined as the width of the signal between two points, one below the carrier center frequency and one above the carrier center frequency, outside of which all emission are attenuated at least 26 dB below the transmitter power.

Note 2: For part 27.53(m)(4) the attenuation factor shall be not less than  $40 + 10 \log(P)$  dB on all frequencies between the channel edge and 5 MHz from the channel edge,  $43 + 10 \log(P)$  dB on all frequencies between 5 MHz and X MHz from the channel edge, and  $55 + 10 \log(P)$  dB on all frequencies more than X MHz from the channel edge, where X is the greater of 6 MHz or the actual emission bandwidth as defined in paragraph (m)(6) of this section. In addition, the attenuation factor shall not be less than  $43 + 10 \log(P)$  dB on all frequencies between 2490.5 MHz and 2496 MHz and  $55 + 10 \log(P)$  dB at or below 2490.5 MHz. For mobile digital stations, in the 1 MHz bands immediately outside and adjacent to the frequency block a resolution bandwidth of **at least two percent** may be employed, except when the 1 MHz band is 2495-2496 MHz, in which case a resolution bandwidth of **at least one percent** may be employed.

### 3.5 SPURIOUS AND HARMONIC EMISSIONS (Conducted)

#### Test set-up

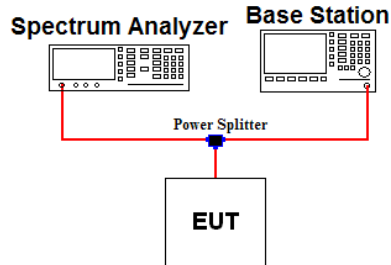

#### Test Procedure

- KDB971168 v02r02 - Section 6.0

The level of the carrier and the various conducted spurious and harmonic frequencies is measured by means of a calibrated spectrum analyzer. The EUT was setup to maximum output power at its low, middle, high channel with all bandwidths, modulations and RB configurations. The spectrum is scanned from 30 MHz up to a frequency including its 10<sup>th</sup> harmonic.

The power of any spurious emission shall be attenuated below the transmitter power (P) by at least  $43 + 10 \log(P)$  dB or  $55 + 10 \log(P)$  in case of band 7 and 41.

#### Test setting

1. RBW = 100 KHz or 1 MHz & VBW  $\geq 3 \times$  RBW ( Refer to Note 1)
2. Detector = RMS & Trace mode = Max hold
3. Sweep time = Auto couple
4. Number of sweep point  $\geq 2 \times$  span / RBW
5. The trace was allowed to stabilize

Note 1: Compliance with these provisions is based on the use of measurement instrumentation employing a resolution bandwidth of 100 kHz or greater for Part 22 and 1 MHz or greater for Part 24, 27.

### 3.6 UNDESIRABLE EMISSIONS (Radiated)

#### Test Set-up

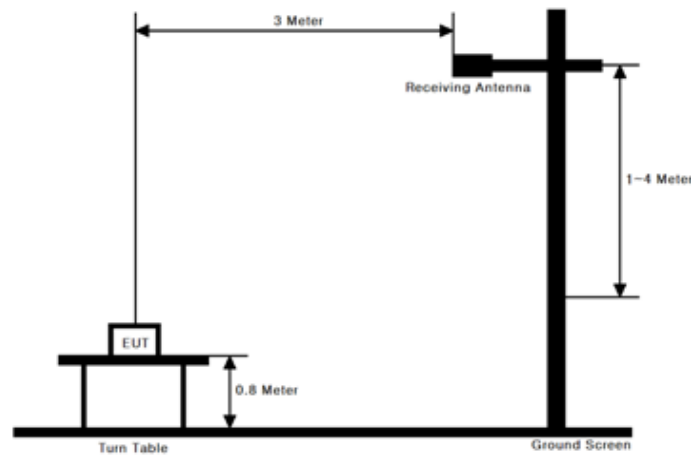

#### Test Procedure

- ANSI/TIA-603-C-2004 - Section 2.2.12
- KDB971168 v02r02 - Section 5.8

These measurements were performed at 3 & 10m test site. The equipment under test is placed on a non-conductive table 0.8-meters above a turntable which is flush with the ground plane and 3 meters from the receive antenna.

#### Test setting

1. RBW = 100 kHz for below 1 GHz and 1 MHz for above 1 GHz / VBW  $\geq$  3 X RBW
2. Detector = Peak & Trace mode = Max hold
3. Sweep time = Auto couple
4. Number of sweep point  $\geq$  2 X span / RBW
5. The trace was allowed to stabilize

The receive antenna height and turntable rotations were adjusted for the highest reading on the receive spectrum analyzer.

For radiated power measurements below 1 GHz, a half-wave dipole was substituted in place of the EUT. This dipole antenna was driven by a signal generator and the level of the signal generator was adjusted to obtain the same spectrum analyzer reading.

For radiated power measurements above 1 GHz, a Horn antenna was substituted in place of the EUT. This Horn antenna was driven by a signal generator and the level of the signal generator was adjusted to obtain the same spectrum analyzer reading. The difference between the gain of the horn and an isotropic antenna are taken into consideration.

This measurement was performed with the EUT oriented in 3 orthogonal axis.

### 3.7 FREQUENCY STABILITY

#### Test Set-up

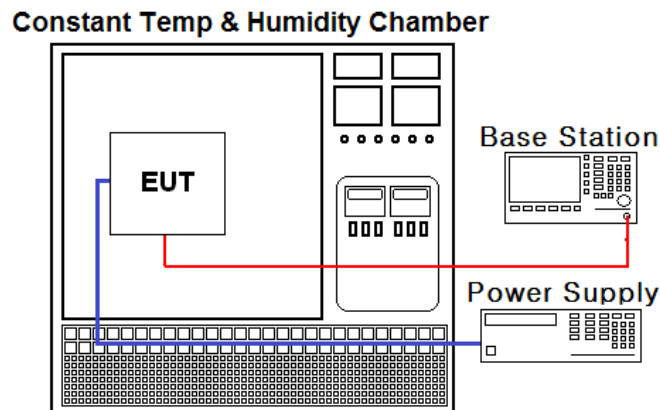

#### Test Procedure

- ANSI/TIA-603-C-2004
- KDB971168 v02r02 - Section 9.0

The frequency stability of the transmitter is measured by:

##### a.) Temperature:

The temperature is varied from - 30 °C to + 50 °C using an environmental chamber.

##### b.) Primary Supply Voltage:

The primary supply voltage is varied from 85 % to 115 % of the nominal value for non hand-carried battery and AC powered equipment. For hand-carried, battery-powered equipment, primary supply voltage is reduced to the battery operating end point which shall be specified by the manufacturer.

#### Specification:

The frequency stability shall be sufficient to ensure that the fundamental emission stays within the authorized frequency block for Part 24. The frequency stability of the transmitter shall be maintained within  $\pm 0.00025\%$  ( $\pm 2.5$  ppm) of the center frequency for Part 22.

#### Time Period and Procedure:

1. The carrier frequency of the transmitter is measured at room temperature.  
(25 °C to provide a reference)
2. The equipment is turned on in a "standby" condition for one minute before applying power to the transmitter. Measurement of the carrier frequency of the transmitter is made within one minute after applying power to the transmitter.
3. Frequency measurements are made at 10 °C intervals ranging from -30 °C to +50 °C.  
A period of at least one half-hour is provided to allow stabilization of the equipment at each temperature level.

**4. LIST OF TEST EQUIPMENT**

Type	Manufacturer	Model	Cal.Date (yy/mm/dd)	Next.Cal. Date (yy/mm/dd)	S/N
MXA Signal Analyzer	Agilent Technologies	N9020A	15/01/19	16/01/19	MY46471096
Dynamic Measurement DC Source	Agilent Technologies	66332A	15/01/22	16/01/22	GB37470200
Temp & Humi Test Chamber	SJ Science	SJ-TH-S50	14/10/21	15/10/21	SJ-TH-S50-130930
RadioCommunication Analyzer	Anritsu	MT8820C	15/01/09	16/01/09	6201274516
Power Splitter	Anritsu	K241B	14/10/21	15/10/21	1701061
2W 3dB Attenuator	SMAJK	SMAJK-2-3	14/10/21	15/10/21	3
Thermohygrometer	BODYCOM	BJ5478	15/02/26	16/02/26	1209
Multimeter	Agilent Technologies	MY41037027	15/01/06	16/01/06	34401A
Vector Signal Generator	Rohde Schwarz	SMBV100A	15/01/06	16/01/06	255571
Signal Generator	Rohde Schwarz	SMF100A	14/07/01	15/07/01	102341
Loop Antenna	Schwarzbeck	FMZB1513	14/04/29	16/04/29	1513-128
TRILOG Broadband Test-Antenna	SCHWARZBECK	VULB 9160	14/04/04	16/04/04	3357
Dipole Antenna	Schwarzbeck	VHA9103	13/10/24	15/10/24	2116
Dipole Antenna	Schwarzbeck	VHA9103	14/04/01	16/04/01	2117
Dipole Antenna	Schwarzbeck	UHA9105	13/10/24	15/10/24	2261
Dipole Antenna	Schwarzbeck	UHA9105	14/04/01	16/04/01	2262
HORN ANT	ETS	3115	15/02/09	17/02/09	00021097
HORN ANT	ETS	3117	14/05/12	16/05/12	140394
HORN ANT	A.H.Systems	SAS-574	15/04/30	17/04/30	154
HORN ANT	ETS	3160-09-01	13/10/13	15/10/13	00158433
Low Noise Pre Amplifier	TSJ	MLA-010K01-B01-27	15/04/09	16/04/09	1844538
Amplifier	RF Bay Inc	MPA-40-40	15/05/08	16/05/08	21151801
Amplifier	EMPOWER	BBS3Q7ELU	14/09/12	15/09/12	1020
Amplifier (30dB)	Agilent	8449B	14/11/06	15/11/06	3008A02108
High-pass filter	Wainwright	WHKX12-935-1000-15000-40SS	14/09/11	15/09/11	7
High-pass filter	Wainwright	WHKX12-2580-3000-18000-80SS	14/09/11	15/09/11	3
High-pass filter	Wainwright	WHNX5.0	14/09/12	15/09/12	8

## 5. SUMMARY OF TEST RESULTS

FCC Part Section(s)	Test Description	Test Limit	Test Condition	Status Note 1
2.1046	Conducted Output Power	N/A	Conducted	<b>C</b> Note2
2.1049	Occupied Bandwidth	N/A		<b>C</b>
24.232(d) 27.50(d.5)	Peak to Average Ratio	< 13 dB		<b>C</b>
2.1051 22.917(a) 24.238(a) 27.53(g) 27.53(h)	Band Edge / conducted Spurious Emissions	> 43 + 10log <sub>10</sub> (P) dB at Band edge and for all out-of-band emissions		<b>C</b>
27.53(m)	Band Edge / conducted Spurious Emissions	> 40 + 10log <sub>10</sub> (P) dB at channel edge and 5 MHz from the channel edge > 43 + 10log <sub>10</sub> (P) dB at 5 MHz and X MHz from the channel edge > 55 + 10log <sub>10</sub> (P) dB at all frequencies more than X MHz from the channel edge		<b>C</b> Note3
2.1055 22.355 24.235 27.54	Frequency Stability	< 2.5 ppm (Part 22) Fundamental emissions must stay within Authorized frequency block (Part 24, 27)		<b>C</b>
22.913(a.2)	Effective Radiated Power (Band5)	< 7 Watts max. ERP	Radiated	<b>C</b>
27.50(c.10)	Effective Radiated Power (Band17)	< 3 Watts max. ERP		<b>C</b>
24.232(c) 27.50(h.2)	Equivalent Isotropic Radiated Power (Band 2,7)	< 2 Watts max. EIRP		<b>C</b>
27.50(d.4)	Equivalent Isotropic Radiated Power (Band 4)	< 1 Watts max. ERP		<b>C</b>
2.1053 22.917(a) 24.238(a) 27.53(g) 27.53(h)	Undesirable Emissions	> 43 + 10log <sub>10</sub> (P) dB at Band edge and for all out-of-band emissions		<b>C</b>
27.53(m)	Undesirable Emissions	> 40 + 10log <sub>10</sub> (P) dB at channel edge and 5 MHz from the channel edge > 43 + 10log <sub>10</sub> (P) dB at 5 MHz and X MHz from the channel edge > 55 + 10log <sub>10</sub> (P) dB at all frequencies more than X MHz from the channel edge		<b>C</b>
<p>Note 1: <b>C</b>=Comply    <b>NC</b>=Not Comply    <b>NT</b>=Not Tested    <b>NA</b>=Not Applicable</p> <p>Note 2: Refer to RF Exposure Report (Test Report_SAR)</p> <p>Note 3: where X is the greater of 6 MHz or the actual emission bandwidth as defined in paragraph (m)(6) of this section.</p> <p>Note 4: This test report data was reused ZNFH630 for band 2, 4 and 7 (Test report number: DRTFCC1505-0105(2), FCC ID: ZNFH630)</p>				

The sample was tested according to the following specification:  
**ANSI/TIA/EIA-603-C-2004 and KDB 971168 D01 v02r02**



## 6. SAMPLE CALCULATION

### A. Emission Designator

#### LTE Band 4(QPSK)

Emission Designator = **17M9G7D**  
LTE OBW = 17.889 MHz  
G = Phase Modulation  
7 = Quantized/Digital Info  
D = Data Transmission

#### LTE Band 2(QPSK)

Emission Designator = **17M9G7D**  
LTE OBW = 17.878 MHz  
G = Phase Modulation  
7 = Quantized/Digital Info  
D = Data Transmission

#### LTE Band 7(QPSK)

Emission Designator = **17M9G7D**  
LTE OBW = 17.929 MHz  
G = Phase Modulation  
7 = Quantized/Digital Info  
D = Data Transmission

#### LTE Band 4(16QAM)

Emission Designator = **17M9W7D**  
LTE OBW = 17.902 MHz  
W = Amplitude/Angle Modulated  
7 = Quantized/Digital Info  
D = Data Transmission

#### LTE Band 2(16QAM)

Emission Designator = **17M9W7D**  
LTE OBW = 17.884 MHz  
W = Amplitude/Angle Modulated  
7 = Quantized/Digital Info  
D = Data Transmission

#### LTE Band 7(16QAM)

Emission Designator = **17M9W7D**  
LTE OBW = 17.862 MHz  
W = Amplitude/Angle Modulated  
7 = Quantized/Digital Info  
D = Data Transmission

**B. EIRP Sample Calculation**

Channel Bandwidth (MHz)	Test Frequency (MHz)	Test Mode	RB Size/ Offset	Spectrum Reading Value(dBm)	EUT Axis	Ant Pol (H/V)	Level(dBm) @ Ant Terminal	TX Ant Gain (dBi)	EIRP (dBm)	EIRP (W)
20	1720	QPSK	1/50	-17.47	X	H	16.16	8.87	25.03	0.318

**EIRP = @ Ant Terminal LEVEL(dBm) + Ant. Gain**

- 1) The EUT mounted on a non-conductive turntable is 0.8 meter above test site ground level.
- 2) During the test, the turn table is rotated until the maximum signal is found.
- 3) Record the field strength meter's level.
- 4) Replace the EUT with dipole/Horn antenna that is connected to a calibrated signal generator.
- 5) Increase the signal generator output till the field strength meter's level is equal to the item (3).
- 6) The signal generator output level with Ant. Gain is the rating of effective isotropic radiated power (EIRP).

## 7. TEST DATA

### 7.1 OCCUPIED BANDWIDTH

- Plots of the EUT's Occupied Bandwidth are shown in Clause 8.1

### 7.2 PEAK TO AVERAGE RATIO

- Plots of the EUT's Peak- to- Average Ratio are shown in Clause 8.2

### 7.3 BAND EDGE EMISSIONS (Conducted)

- Plots of the EUT's Band Edge Emissions are shown in Clause 8.3

### 7.4 SPURIOUS AND HARMONICS EMISSIONS (Conducted)

- Plots of the EUT's Spurious Emissions are shown in Clause 8.4

## 7.5 EQUIVALENT ISOTROPIC RADIATED POWER

### 7.5.1 LTE Band 4

Channel Bandwidth (MHz)	Test Frequency (MHz)	Test Mode	RB Size/Offset	EUT Axis	Ant Pol (H/V)	Level(dBm) @ Ant Terminal	TX Ant Gain (dBi)	EIRP (dBm)	EIRP (W)
20	1720	QPSK	1/50	X	H	16.16	8.87	25.03	0.318
		16QAM	1/0	X	H	15.20	8.87	24.07	0.255
	1732.5	QPSK	1/0	X	H	15.52	8.88	24.40	0.275
		16QAM	1/0	X	H	14.85	8.88	23.73	0.236
	1745	QPSK	1/0	X	H	15.46	8.90	24.36	0.273
		16QAM	1/50	X	H	14.29	8.90	23.19	0.208
15	1717.5	QPSK	1/74	X	H	16.16	8.87	25.03	0.318
		16QAM	1/0	X	H	15.28	8.87	24.15	0.260
	1732.5	QPSK	1/0	X	H	15.34	8.88	24.22	0.264
		16QAM	1/0	X	H	14.57	8.88	23.45	0.221
	1747.5	QPSK	1/0	X	H	15.22	8.90	24.12	0.258
		16QAM	1/0	X	H	14.17	8.90	23.07	0.203
10	1715	QPSK	1/0	X	H	16.00	8.87	24.87	0.307
		16QAM	1/0	X	H	14.95	8.87	23.82	0.241
	1732.5	QPSK	1/0	X	H	15.46	8.88	24.34	0.272
		16QAM	1/0	X	H	14.60	8.88	23.48	0.223
	1750	QPSK	1/0	X	H	15.41	8.90	24.31	0.270
		16QAM	1/0	X	H	14.50	8.90	23.40	0.219
5	1712.5	QPSK	1/24	X	H	15.27	8.86	24.13	0.259
		16QAM	1/0	X	H	13.85	8.86	22.71	0.187
	1732.5	QPSK	1/0	X	H	14.69	8.88	23.57	0.228
		16QAM	1/12	X	H	13.91	8.88	22.79	0.190
	1752.5	QPSK	1/0	X	H	14.58	8.90	23.48	0.223
		16QAM	1/0	X	H	13.02	8.90	21.92	0.156
3	1711.5	QPSK	1/14	X	H	15.78	8.86	24.64	0.291
		16QAM	1/0	X	H	15.08	8.86	23.94	0.248
	1732.5	QPSK	1/0	X	H	15.20	8.88	24.08	0.256
		16QAM	1/0	X	H	13.95	8.88	22.83	0.192
	1753.5	QPSK	1/0	X	H	14.10	8.90	23.00	0.200
		16QAM	1/0	X	H	13.64	8.90	22.54	0.179
1.4	1710.7	QPSK	1/2	X	H	15.74	8.86	24.60	0.288
		16QAM	1/2	X	H	15.09	8.86	23.95	0.248
	1732.5	QPSK	1/2	X	H	15.05	8.88	23.93	0.247
		16QAM	1/2	X	H	14.23	8.88	23.11	0.205
	1754.3	QPSK	1/2	X	H	14.46	8.90	23.36	0.217
		16QAM	1/5	X	H	13.53	8.90	22.43	0.175

Note: This device was tested under all bandwidths, modulations and RB configurations and the worst case data are reported in the table above.

## 7.5.2 LTE Band 2

Channel Bandwidth (MHz)	Test Frequency (MHz)	Test Mode	RB Size/Offset	EUT Axis	Ant Pol (H/V)	Level(dBm) @ Ant Terminal	TX Ant Gain (dBi)	EIRP (dBm)	EIRP (W)
20	1860	QPSK	1/0	X	H	14.65	9.02	23.67	0.233
		16QAM	1/50	X	H	13.47	9.02	22.49	0.177
	1880	QPSK	1/0	X	H	16.03	9.05	25.08	0.322
		16QAM	1/0	X	H	15.09	9.05	24.14	0.259
	1900	QPSK	1/0	X	H	16.14	9.07	25.21	0.332
		16QAM	1/0	X	H	15.24	9.07	24.31	0.270
15	1857.5	QPSK	1/0	X	H	14.54	9.02	23.56	0.227
		16QAM	1/74	X	H	13.70	9.02	22.72	0.187
	1880	QPSK	1/0	X	H	15.34	9.05	24.39	0.275
		16QAM	1/0	X	H	14.39	9.05	23.44	0.221
	1902.5	QPSK	1/0	X	H	16.20	9.07	25.27	0.337
		16QAM	1/0	X	H	15.29	9.07	24.36	0.273
10	1855	QPSK	1/49	X	H	14.69	9.02	23.71	0.235
		16QAM	1/0	X	H	13.74	9.02	22.76	0.189
	1880	QPSK	1/0	X	H	15.67	9.05	24.72	0.296
		16QAM	1/25	X	H	14.68	9.05	23.73	0.236
	1905	QPSK	1/0	X	H	15.95	9.08	25.03	0.318
		16QAM	1/0	X	H	15.42	9.08	24.50	0.282
5	1852.5	QPSK	1/12	X	H	15.10	9.01	24.11	0.258
		16QAM	1/24	X	H	13.95	9.01	22.96	0.198
	1880	QPSK	1/0	X	H	14.90	9.05	23.95	0.248
		16QAM	1/0	X	H	13.98	9.05	23.03	0.201
	1907.5	QPSK	1/0	X	H	16.09	9.08	25.17	0.329
		16QAM	1/0	X	H	15.28	9.08	24.36	0.273
3	1851.5	QPSK	1/14	X	H	14.93	9.01	23.94	0.248
		16QAM	1/0	X	H	14.22	9.01	23.23	0.210
	1880	QPSK	1/7	X	H	15.30	9.05	24.35	0.272
		16QAM	1/0	X	H	14.34	9.05	23.39	0.218
	1908.5	QPSK	1/14	X	H	16.32	9.08	25.40	0.347
		16QAM	1/14	X	H	15.65	9.08	24.73	0.297
1.4	1850.7	QPSK	1/2	X	H	15.09	9.01	24.10	0.257
		16QAM	1/2	X	H	14.27	9.01	23.28	0.213
	1880	QPSK	3/2	X	H	15.05	9.05	24.10	0.257
		16QAM	1/0	X	H	14.24	9.05	23.29	0.213
	1909.3	QPSK	3/2	X	H	15.74	9.08	24.82	0.303
		16QAM	1/5	X	H	15.02	9.08	24.10	0.257

Note: This device was tested under all bandwidths, modulations and RB configurations and the worst case data are reported in the table above.

## 7.5.3 LTE Band 7

Channel Bandwidth (MHz)	Test Frequency (MHz)	Test Mode	RB Size/Offset	EUT Axis	Ant Pol (H/V)	Level(dBm) @ Ant Terminal	TX Ant Gain (dBi)	EIRP (dBm)	EIRP (W)
20	2510	QPSK	1/0	X	H	13.91	9.76	23.67	0.233
		16QAM	1/0	X	H	12.84	9.76	22.60	0.182
	2535	QPSK	1/50	X	H	13.23	9.76	22.99	0.199
		16QAM	1/0	X	H	12.31	9.76	22.07	0.161
	2560	QPSK	1/0	X	H	13.11	9.75	22.86	0.193
		16QAM	1/0	X	H	12.50	9.75	22.25	0.168
15	2507.5	QPSK	1/0	X	H	13.57	9.76	23.33	0.215
		16QAM	1/0	X	H	12.54	9.76	22.30	0.170
	2535	QPSK	1/74	X	H	13.57	9.76	23.33	0.215
		16QAM	1/0	X	H	12.29	9.76	22.05	0.160
	2562.5	QPSK	1/0	X	H	12.78	9.75	22.53	0.179
		16QAM	1/0	X	H	12.61	9.75	22.36	0.172
10	2505	QPSK	1/0	X	H	13.56	9.76	23.32	0.215
		16QAM	1/0	X	H	12.62	9.76	22.38	0.173
	2535	QPSK	1/0	X	H	13.66	9.76	23.42	0.220
		16QAM	1/49	X	H	12.75	9.76	22.51	0.178
	2565	QPSK	1/0	X	H	12.99	9.75	22.74	0.188
		16QAM	1/25	X	H	12.14	9.75	21.89	0.155
5	2502.5	QPSK	1/0	X	H	13.56	9.76	23.32	0.215
		16QAM	1/0	X	H	12.47	9.76	22.23	0.167
	2535	QPSK	1/12	X	H	12.96	9.76	22.72	0.187
		16QAM	1/0	X	H	12.18	9.76	21.94	0.156
	2567.5	QPSK	1/0	X	H	13.28	9.75	23.03	0.201
		16QAM	1/0	X	H	12.29	9.75	22.04	0.160

Note: This device was tested under all bandwidths, modulations and RB configurations and the worst case data are reported in the table above.

**7.6 UNDESIRABLE EMISSIONS (Radiated)****7.6.1 LTE Band 4**

B.W (MHz)	Test Freq. (MHz)	RB Size/ Offset	Test Mode	Freq.(MHz)	EUT Axis	Ant Pol (H/V)	Level(dBm) @ Ant Terminal	TX Ant Gain(dBi)	Result		Limit (dBc)
									(dBm)	(dBc)	
20	1720	1/50	QPSK	6880.34	X	H	-41.69	11.70	-29.99	55.02	38.03
				8600.63	X	H	-40.75	11.35	-29.40	54.43	
				12040.99	X	H	-42.42	12.69	-29.73	54.76	
		1/0	16QAM	6844.38	X	H	-39.14	11.69	-27.45	51.52	37.07
				8555.34	X	H	-37.88	11.35	-26.53	50.60	
				11977.57	X	H	-41.01	12.68	-28.33	52.40	
	1732.5	1/0	QPSK	6894.27	X	H	-42.06	11.70	-30.36	54.76	37.40
				8617.98	X	H	-38.37	11.35	-27.02	51.42	
				12065.15	X	H	-42.85	12.70	-30.15	54.55	
		1/0	16QAM	6894.50	X	H	-43.98	11.70	-32.28	56.01	36.73
				8618.03	X	H	-39.27	11.35	-27.92	51.65	
				12065.30	X	H	-42.34	12.70	-29.64	53.37	
	1745	1/0	QPSK	6944.59	X	H	-36.17	11.70	-24.47	48.83	37.36
				8680.49	X	H	-34.35	11.35	-23.00	47.36	
				12152.79	X	H	-40.56	12.72	-27.84	52.20	
		1/50	16QAM	6980.36	X	H	-37.82	11.70	-26.12	49.31	36.19
				8725.50	X	H	-36.38	11.35	-25.03	48.22	
				12215.89	X	H	-42.07	12.74	-29.33	52.52	
15	1717.5	1/74	QPSK	6896.51	X	H	-43.18	11.70	-31.48	56.51	38.03
				8554.10	X	H	-37.93	11.35	-26.58	51.61	
				12068.98	X	H	-42.15	12.70	-29.45	54.48	
		1/0	16QAM	6843.30	X	H	-41.95	11.69	-30.26	54.41	37.15
				8554.30	X	H	-37.98	11.35	-26.63	50.78	
				11976.16	X	H	-40.39	12.68	-27.71	51.86	
	1732.5	1/0	QPSK	6943.45	X	H	-41.51	11.70	-29.81	54.03	37.22
				8629.24	X	H	-37.38	11.35	-26.03	50.25	
				12081.03	X	H	-42.50	12.70	-29.80	54.02	
		1/0	16QAM	6903.37	X	H	-32.99	11.70	-21.29	44.74	36.45
				8629.26	X	H	-37.99	11.35	-26.64	50.09	
				12080.87	X	H	-43.40	12.70	-30.70	54.15	
	1747.5	1/0	QPSK	6963.48	X	H	-39.64	11.70	-27.94	52.06	37.12
				8704.18	X	H	-36.91	11.35	-25.56	49.68	
				12185.93	X	H	-40.63	12.73	-27.90	52.02	
		1/0	16QAM	6963.40	X	H	-39.85	11.70	-28.15	51.22	36.07
				8704.38	X	H	-36.55	11.35	-25.20	48.27	
				12185.96	X	H	-40.51	12.73	-27.78	50.85	

B.W (MHz)	Test Freq. (MHz)	RB Size/ Offset	Test Mode	Freq.(MHz)	EUT Axis	Ant Pol (H/V)	Level(dBm) @ Ant Terminal	TX Ant Gain(dBi)	Result		Limit (dBc)
									(dBm)	(dBc)	
10	1715	1/0	QPSK	6842.41	X	H	-43.01	11.69	-31.32	56.19	37.87
				8552.87	X	H	-38.11	11.35	-26.76	51.63	
				11974.03	X	H	-41.52	12.68	-28.84	53.71	
	1715	1/0	16QAM	6842.46	X	H	-42.21	11.69	-30.52	54.34	36.82
				8552.86	X	H	-47.70	11.35	-36.35	60.17	
				11973.08	X	H	-41.00	12.68	-28.32	52.14	
	1732.5	1/0	QPSK	6912.11	X	H	-40.74	11.70	-29.04	53.38	37.34
				8640.55	X	H	-37.11	11.35	-25.76	50.10	
				12096.63	X	H	-41.48	12.71	-28.77	53.11	
	1732.5	1/0	16QAM	6912.45	X	H	-40.79	11.70	-29.09	52.57	36.48
				8640.60	X	H	-37.55	11.35	-26.20	49.68	
				12096.80	X	H	-43.02	12.71	-30.31	53.79	
1750	1/0	QPSK	6982.13	X	H	-41.14	11.70	-29.44	53.75	37.31	
			8728.05	X	H	-36.81	11.35	-25.46	49.77		
			12219.08	X	H	-40.54	12.74	-27.80	52.11		
1750	1/0	16QAM	6982.40	X	H	-40.23	11.70	-28.53	51.93	36.40	
			8728.03	X	H	-36.68	11.35	-25.33	48.73		
			12219.21	X	H	-41.21	12.74	-28.47	51.87		
5	1712.5	1/24	QPSK	6858.56	X	H	-43.64	11.69	-31.95	56.08	37.13
				8773.39	X	H	-39.38	11.36	-28.02	52.15	
				12002.66	X	H	-42.16	12.68	-29.48	53.61	
	1712.5	1/0	16QAM	6841.61	X	H	-42.06	11.69	-30.37	53.08	35.71
				8551.60	X	H	-39.24	11.35	-27.89	50.60	
				11972.67	X	H	-41.26	12.68	-28.58	51.29	
	1732.5	1/0	QPSK	6921.20	X	H	-38.94	11.70	-27.24	50.81	36.57
				8651.86	X	H	-36.24	11.35	-24.89	48.46	
				12122.16	X	H	-43.38	12.71	-30.67	54.24	
	1732.5	1/12	16QAM	6930.11	X	H	-38.64	11.70	-26.94	49.73	35.79
				8662.70	X	H	-36.30	11.35	-24.95	47.74	
				12127.83	X	H	-44.22	12.72	-31.50	54.29	
1752.5	1/0	QPSK	7001.34	X	H	-41.40	11.70	-29.70	53.18	36.48	
			8751.62	X	H	-39.10	11.36	-27.74	51.22		
			12252.44	X	H	-43.02	12.75	-30.27	53.75		
1752.5	1/0	16QAM	7001.35	X	H	-38.63	11.70	-26.93	48.85	34.92	
			8751.75	X	H	-36.25	11.36	-24.89	46.81		
			12252.43	X	H	-43.00	12.75	-30.25	52.17		



B.W (MHz)	Test Freq. (MHz)	RB Size/ Offset	Test Mode	Freq.(MHz)	EUT Axis	Ant Pol (H/V)	Level(dBm) @ Ant Terminal	TX Ant Gain(dBi)	Result		Limit (dBc)	
									(dBm)	(dBc)		
3	1711.5	1/14	QPSK	6850.79	X	H	-42.87	11.69	-31.18	55.82	37.64	
				8563.97	X	H	-39.04	11.35	-27.69	52.33		
				11989.54	X	H	-41.64	12.68	-28.96	53.60		
		1/0	16QAM	6840.86	X	H	-40.72	11.69	-29.03	52.97		36.94
				8551.07	X	H	-38.45	11.35	-27.10	51.04		
				11972.10	X	H	-40.97	12.68	-28.29	52.23		
	1732.5	1/0	QPSK	6925.04	X	H	-38.46	11.70	-26.76	50.84	37.08	
				8656.03	X	H	-37.02	11.35	-25.67	49.75		
				12118.76	X	H	-42.59	12.71	-29.88	53.96		
		1/0	16QAM	6924.88	X	H	-38.59	11.70	-26.89	49.72	35.83	
				8656.33	X	H	-35.99	11.35	-24.64	47.47		
				12118.83	X	H	-41.99	12.71	-29.28	52.11		
	1753.5	1/0	QPSK	7009.14	X	H	-40.85	11.70	-29.15	52.15	36.00	
				8761.05	X	H	-39.86	11.36	-28.50	51.50		
				12265.73	X	H	-43.23	12.75	-30.48	53.48		
1/0		16QAM	7008.94	X	H	-41.54	11.70	-29.84	52.38	35.54		
			8761.20	X	H	-40.20	11.36	-28.84	51.38			
			12265.63	X	H	-42.50	12.75	-29.75	52.29			
1.4	1710.7	1/2	QPSK	6842.60	X	H	-41.80	11.69	-30.11	54.71	37.60	
				8553.27	X	H	-37.72	11.35	-26.37	50.97		
				11974.43	X	H	-41.74	12.68	-29.06	53.66		
		1/2	16QAM	6842.33	X	H	-41.62	11.69	-29.93	53.88	36.95	
				8553.00	X	H	-37.51	11.35	-26.16	50.11		
				11974.14	X	H	-40.71	12.68	-28.03	51.98		
	1732.5	1/2	QPSK	6929.69	X	H	-38.70	11.70	-27.00	50.93	36.93	
				8662.21	X	H	-35.51	11.35	-24.16	48.09		
				12126.96	X	H	-42.05	12.72	-29.33	53.26		
		1/2	16QAM	6929.56	X	H	-39.42	11.70	-27.72	50.83	36.11	
				8662.01	X	H	-36.44	11.35	-25.09	48.20		
				12127.28	X	H	-41.75	12.72	-29.03	52.14		
	1754.3	1/2	QPSK	7016.78	X	H	-42.70	11.69	-31.01	54.37	36.36	
				8770.99	X	H	-41.53	11.36	-30.17	53.53		
				12279.56	X	H	-43.42	12.76	-30.66	54.02		
1/5		16QAM	7018.11	X	H	-42.17	11.69	-30.48	52.91	35.43		
			8773.91	X	H	-41.32	11.36	-29.96	52.39			
			12283.31	X	H	-44.27	12.76	-31.51	53.94			

Note 1: Limit Calculation =  $43 + 10\log_{10}(P[\text{Watts}])$

Note 2: This device was tested under all bandwidths, modulations and RB configurations and the worst case data are reported in the table above.

Note 3: The frequency spectrum is examined from 9 kHz to the 10th harmonic of the fundamental frequency of the transmitter. No other spurious and harmonic emissions were reported greater than listed emissions above table.

## 7.6.2 LTE Band 2

B.W (MHz)	Test Freq. (MHz)	RB Size/ Offset	Test Mode	Freq.(MHz)	EUT Axis	Ant Pol (H/V)	Level(dBm) @ Ant Terminal	TX Ant Gain(dBi)	Result		Limit (dBc)
									(dBm)	(dBc)	
20	1860	1/0	QPSK	3702.32	X	H	-47.75	9.91	-37.84	61.51	36.67
				5553.18	X	V	-39.92	10.98	-28.94	52.61	
				-	-	-	-	-	-	-	
		1/50	16QAM	3720.02	X	H	-45.18	9.89	-35.29	57.78	35.49
				5550.38	X	V	-43.87	10.98	-32.89	55.38	
				-	-	-	-	-	-	-	
	1880	1/0	QPSK	3742.30	X	H	-42.70	9.87	-32.83	57.91	38.08
				5613.20	X	V	-46.04	11.07	-34.97	60.05	
				-	-	-	-	-	-	-	
		1/0	16QAM	3742.25	X	H	-42.53	9.87	-32.66	56.80	37.14
				5613.27	X	V	-46.01	11.07	-34.94	59.08	
				-	-	-	-	-	-	-	
	1900	1/0	QPSK	3782.16	X	H	-49.86	9.83	-40.03	65.24	38.21
				5673.44	X	V	-44.40	11.16	-33.24	58.45	
				-	-	-	-	-	-	-	
		1/0	16QAM	3782.25	X	H	-50.41	9.83	-40.58	64.89	37.31
				5673.03	X	V	-43.79	11.16	-32.63	56.94	
				-	-	-	-	-	-	-	
15	1857.5	1/0	QPSK	3701.72	X	H	-49.46	9.91	-39.55	63.11	36.56
				5552.45	X	V	-42.30	10.98	-31.32	54.88	
				-	-	-	-	-	-	-	
		1/74	16QAM	3728.35	X	H	-43.18	9.89	-33.29	56.01	35.72
				5952.54	X	V	-44.70	11.58	-33.12	55.84	
				-	-	-	-	-	-	-	
	1880	1/0	QPSK	3746.66	X	H	-42.78	9.87	-32.91	57.30	37.39
				5620.04	X	V	-45.58	11.08	-34.50	58.89	
				-	-	-	-	-	-	-	
		1/0	16QAM	3746.83	X	H	-42.79	9.87	-32.92	56.36	36.44
				5620.03	X	V	-45.57	11.08	-34.49	57.93	
				-	-	-	-	-	-	-	
	1902.5	1/0	QPSK	3791.76	X	H	-48.03	9.82	-38.21	63.48	38.27
				5687.53	X	V	-45.36	11.18	-34.18	59.45	
				-	-	-	-	-	-	-	
		1/0	16QAM	3791.89	X	H	-48.42	9.82	-38.60	62.96	37.36
				5687.59	X	V	-45.75	11.18	-34.57	58.93	
				-	-	-	-	-	-	-	

B.W (MHz)	Test Freq. (MHz)	RB Size/ Offset	Test Mode	Freq.(MHz)	EUT Axis	Ant Pol (H/V)	Level(dBm) @ Ant Terminal	TX Ant Gain(dBi)	Result		Limit (dBc)	
									(dBm)	(dBc)		
10	1855	1/49	QPSK	3718.55	X	H	-44.23	9.90	-34.33	58.04	36.71	
				5578.45	X	V	-43.96	11.02	-32.94	56.65		
				-	-	-	-	-	-	-		
		1/0	16QAM	3701.20	X	H	-49.29	9.91	-39.38	62.14		35.76
				5551.85	X	V	-42.76	10.98	-31.78	54.54		
				-	-	-	-	-	-	-		
	1880	1/0	QPSK	3751.05	X	H	-43.12	9.86	-33.26	57.98	37.72	
				5626.76	X	V	-44.69	11.09	-33.60	58.32		
				-	-	-	-	-	-	-		
		1/25	16QAM	3760.25	X	H	-44.59	9.85	-34.74	58.47	36.73	
				5640.57	X	V	-45.43	11.11	-34.32	58.05		
				-	-	-	-	-	-	-		
	1905	1/0	QPSK	3801.33	X	H	-47.55	9.81	-37.74	62.77	38.03	
				5702.08	X	V	-46.01	11.20	-34.81	59.84		
				-	-	-	-	-	-	-		
		1/0	16QAM	3801.24	X	H	-48.28	9.81	-38.47	62.97	37.50	
				5701.90	X	V	-46.92	11.20	-35.72	60.22		
				-	-	-	-	-	-	-		
5	1852.5	1/12	QPSK	3705.10	X	H	-48.95	9.91	-39.04	63.15	37.11	
				5557.47	X	V	-42.68	10.99	-31.69	55.80		
				-	-	-	-	-	-	-		
		1/24	16QAM	3709.19	X	H	-47.54	9.90	-37.64	60.60	35.96	
				5654.05	X	V	-42.37	11.13	-31.24	54.20		
				-	-	-	-	-	-	-		
	1880	1/0	QPSK	3755.62	X	H	-44.16	9.86	-34.30	58.25	36.95	
				5633.81	X	V	-45.72	11.10	-34.62	58.57		
				-	-	-	-	-	-	-		
		1/0	16QAM	3755.85	X	H	-43.55	9.86	-33.69	56.72	36.03	
				5633.50	X	V	-46.06	11.10	-34.96	57.99		
				-	-	-	-	-	-	-		
	1907.5	1/0	QPSK	3810.01	X	H	-48.43	9.81	-38.62	63.79	38.17	
				5716.15	X	V	-45.88	11.22	-34.66	59.83		
				-	-	-	-	-	-	-		
		1/0	16QAM	3810.78	X	H	-48.27	9.81	-38.46	62.82	37.36	
				5716.27	X	V	-45.68	11.22	-34.46	58.82		
				-	-	-	-	-	-	-		

B.W (MHz)	Test Freq. (MHz)	RB Size/ Offset	Test Mode	Freq.(MHz)	EUT Axis	Ant Pol (H/V)	Level(dBm) @ Ant Terminal	TX Ant Gain(dBi)	Result		Limit (dBc)
									(dBm)	(dBc)	
3	1851.5	1/14	QPSK	3705.53	X	H	-48.82	9.91	-38.91	62.85	36.94
				5558.30	X	V	-42.30	10.99	-31.31	55.25	
				-	-	-	-	-	-	-	
		1/0	16QAM	3700.40	X	H	-49.55	9.91	-39.64	62.87	36.23
				5550.72	X	V	-42.70	10.98	-31.72	54.95	
				-	-	-	-	-	-	-	
	1880	1/7	QPSK	3760.00	X	H	-44.85	9.86	-34.99	59.34	37.35
				5639.86	X	V	-43.55	11.11	-32.44	56.79	
				-	-	-	-	-	-	-	
		1/0	16QAM	3757.38	X	H	-44.45	9.86	-34.59	57.98	36.39
				5636.15	X	V	-44.20	11.10	-33.10	56.49	
				-	-	-	-	-	-	-	
	1908.5	1/14	QPSK	3819.67	X	H	-49.75	9.80	-39.95	65.35	38.40
				5729.35	X	V	-46.59	11.24	-35.35	60.75	
				-	-	-	-	-	-	-	
		1/14	16QAM	3819.64	X	H	-48.76	9.80	-38.96	63.69	37.73
5729.39				X	V	-47.10	11.24	-35.86	60.59		
-				-	-	-	-	-	-		
1.4	1850.7	1/2	QPSK	3710.65	X	H	-49.54	9.90	-39.64	63.74	37.10
				5552.02	X	V	-42.86	10.98	-31.88	55.98	
				-	-	-	-	-	-	-	
		1/2	16QAM	3701.22	X	H	-50.01	9.91	-40.10	63.38	36.28
				5551.70	X	V	-42.94	10.98	-31.96	55.24	
				-	-	-	-	-	-	-	
	1880	3/2	QPSK	3760.22	X	H	-44.96	9.85	-35.11	59.21	37.10
				5640.47	X	V	-44.66	11.11	-33.55	57.65	
				-	-	-	-	-	-	-	
		1/0	16QAM	3758.94	X	H	-44.43	9.86	-34.57	57.86	36.29
				5638.57	X	V	-44.42	11.11	-33.31	56.60	
				-	-	-	-	-	-	-	
	1909.3	3/2	QPSK	3817.97	X	H	-49.27	9.80	-39.47	64.29	37.82
				5728.07	X	V	-47.75	11.24	-36.51	61.33	
				-	-	-	-	-	-	-	
		1/5	16QAM	3819.56	X	H	-49.17	9.80	-39.37	63.47	37.10
				5729.22	X	V	-48.04	11.24	-36.80	60.90	
				-	-	-	-	-	-	-	

Note 1: Limit Calculation =  $43 + 10\log_{10}(P[\text{Watts}])$

Note 2: This device was tested under all bandwidths, modulations and RB configurations and the worst case data are reported in the table above.

Note 3: The frequency spectrum is examined from 9 kHz to the 10th harmonic of the fundamental frequency of the transmitter. No other spurious and harmonic emissions were reported greater than listed emissions above table.

## 7.6.3 LTE Band 7

B.W (MHz)	Test Freq. (MHz)	RB Size/ Offset	Test Mode	Freq.(MHz)	EUT Axis	Ant Pol (H/V)	Level(dBm) @ Ant Terminal	TX Ant Gain(dBi)	Result		Limit (dBc)
									(dBm)	(dBc)	
20	2510	1/0	QPSK	5002.32	Y	H	-47.23	10.68	-36.55	60.22	48.67
				12505.48	Z	V	-43.16	12.82	-30.34	54.01	
				15006.59	Y	H	-42.34	13.26	-29.08	52.75	
		1/0	16QAM	5002.00	Y	H	-46.53	10.68	-35.85	58.45	47.60
				12505.38	Z	V	-42.34	12.82	-29.52	52.12	
				15006.46	Y	H	-43.40	13.26	-30.14	52.74	
	2535	1/50	QPSK	5070.26	Y	H	-48.79	10.71	-38.08	61.07	47.99
				12675.58	Z	V	-42.68	12.87	-29.81	52.80	
				15210.73	Y	H	-43.67	13.95	-29.72	52.71	
		1/0	16QAM	5052.48	Y	H	-50.78	10.70	-40.08	62.15	47.07
				12630.59	Z	V	-43.00	12.86	-30.14	52.21	
				15156.36	Y	H	-42.52	13.77	-28.75	50.82	
	2560	1/0	QPSK	5102.29	Y	H	-49.26	10.73	-38.53	61.39	47.86
				12755.61	Z	V	-43.21	12.89	-30.32	53.18	
				15306.70	Y	H	-44.44	14.28	-30.16	53.02	
1/0		16QAM	5101.98	Y	H	-49.58	10.72	-38.86	61.11	47.25	
			12755.51	Z	V	-42.73	12.89	-29.84	52.09		
			15306.53	Y	H	-44.49	14.28	-30.21	52.46		
15	2507.5	1/0	QPSK	5001.72	Y	H	-47.12	10.68	-36.44	59.77	48.33
				12504.23	Z	V	-43.22	12.82	-30.40	53.73	
				15005.48	Y	H	-42.29	13.26	-29.03	52.36	
		1/0	16QAM	5001.58	Y	H	-46.81	10.68	-36.13	58.43	47.30
				12504.22	Z	V	-43.67	12.82	-30.85	53.15	
				12005.31	Y	H	-50.05	12.68	-37.37	59.67	
	2535	1/74	QPSK	5083.12	Y	H	-48.72	10.72	-38.00	61.33	48.33
				12708.15	Z	V	-44.28	12.88	-31.40	54.73	
				15249.93	Y	H	-44.45	14.08	-30.37	53.70	
		1/0	16QAM	5056.52	Y	H	-50.21	10.70	-39.51	61.56	47.05
				12642.02	Z	V	-42.30	12.86	-29.44	51.49	
				15169.83	Y	H	-42.63	13.81	-28.82	50.87	
	2562.5	1/0	QPSK	5111.97	Y	H	-50.19	10.73	-39.46	61.99	47.53
				12779.03	Z	V	-41.95	12.90	-29.05	51.58	
				15334.98	Y	H	-45.88	14.37	-31.51	54.04	
1/0		16QAM	5111.47	Y	H	-50.22	10.73	-39.49	61.85	47.36	
			12779.39	Z	V	-42.12	12.90	-29.22	51.58		
			15335.11	Y	H	-45.04	14.37	-30.67	53.03		

B.W (MHz)	Test Freq. (MHz)	RB Size/ Offset	Test Mode	Freq.(MHz)	EUT Axis	Ant Pol (H/V)	Level(dBm) @ Ant Terminal	TX Ant Gain(dBi)	Result		Limit (dBc)
									(dBm)	(dBc)	
10	2505	1/0	QPSK	5001.12	Y	H	-46.20	10.68	-35.52	58.84	48.32
				12502.77	Z	V	-43.47	12.82	-30.65	53.97	
				15003.34	Y	H	-43.78	13.25	-30.53	53.85	
	1/0	16QAM	5001.38	Y	H	-46.20	10.68	-35.52	57.90	47.38	
			12503.71	Z	V	-43.64	12.82	-30.82	53.20		
			15003.73	Y	H	-44.06	13.25	-30.81	53.19		
	2535	1/0	QPSK	5061.05	Y	H	-48.67	10.71	-37.96	61.38	48.42
				12653.17	Z	V	-41.50	12.86	-28.64	52.06	
				15183.61	Y	H	-43.50	13.86	-29.64	53.06	
	1/49	16QAM	5078.85	Y	H	-49.59	10.71	-38.88	61.39	47.51	
			12696.95	Z	V	-42.17	12.88	-29.29	51.80		
			15236.59	Y	H	-42.93	14.04	-28.89	51.40		
	2565	1/0	QPSK	5120.09	Y	H	-50.50	10.73	-39.77	62.51	47.74
				12803.22	Z	V	-42.47	12.90	-29.57	52.31	
				15363.50	Y	H	-45.13	14.47	-30.66	53.40	
1/25	16QAM	5130.12	Y	H	-51.03	10.74	-40.29	62.18	46.89		
		12825.65	Z	V	-42.94	12.91	-30.03	51.92			
		15390.60	Y	H	-44.14	14.56	-29.58	51.47			
5	2502.5	1/0	QPSK	5000.86	Y	H	-46.41	10.68	-35.73	59.05	48.32
				12501.58	Z	V	-44.15	12.82	-31.33	54.65	
				15001.97	Y	H	-44.83	13.25	-31.58	54.90	
	1/0	16QAM	5000.55	Y	H	-46.08	10.68	-35.40	57.63	47.23	
			12501.73	Z	V	-44.49	12.82	-31.67	53.90		
			15002.25	Y	H	-45.11	13.25	-31.86	54.09		
	2535	1/12	QPSK	5069.75	Y	H	-49.19	10.71	-38.48	61.20	47.72
				12675.01	Z	V	-42.59	12.87	-29.72	52.44	
				15209.99	Y	H	-44.68	13.95	-30.73	53.45	
	1/0	16QAM	5065.44	Y	H	-47.35	10.71	-36.64	58.58	46.94	
			12664.33	Z	V	-42.63	12.87	-29.76	51.70		
			15197.13	Y	H	-43.41	13.91	-29.50	51.44		
	2567.5	1/0	QPSK	5130.50	Y	H	-49.37	10.74	-38.63	61.66	48.03
				12826.85	Z	V	-43.25	12.91	-30.34	53.37	
				15392.36	Y	H	-44.82	14.57	-30.25	53.28	
1/0	16QAM	5130.69	Y	H	-49.52	10.74	-38.78	60.82	47.04		
		12826.51	Z	V	-43.59	12.91	-30.68	52.72			
		15392.02	Y	H	-43.90	14.57	-29.33	51.37			

Note 1: Limit Calculation =  $55 + 10\log_{10}(P[\text{Watts}])$  at all frequencies more than X MHz from the channel edge.  
(where X is the greater of 6 MHz or the actual emission bandwidth.)

Note 2: This device was tested under all bandwidths, modulations and RB configurations and the worst case data are reported in the table above.

Note 3: The frequency spectrum is examined from 9 kHz to the 10<sup>th</sup> harmonic of the fundamental frequency of the transmitter. No other spurious and harmonic emissions were reported greater than listed emissions above table.

Note 4: Measurement Distance = 3 m for below 13 GHz, Measurement Distance = 1 m for above 13 GHz.

## 7.7 FREQUENCY STABILITY

### 7.7.1 LTE Band 4

OPERATING FREQUENCY : 1732.5 MHz  
 CHANNEL : 20175  
 REFERENCE VOLTAGE : 3.85 VDC  
 LIMIT : The frequency stability shall be sufficient to ensure that the fundamental emission stays within the authorized frequency block.

VOLTAGE (%)	POWER (V DC)	TEMP (°C)	FREQUENCY (Hz)	FREQ.Dev (Hz)	Deviation	
					(ppm)	(%)
100%	3.85	+25(Ref)	1,732,500,002	2	0.0012	0.000000115
100%		-30	1,732,499,996	-4	-0.0023	-0.000000231
100%		-20	1,732,500,006	6	0.0035	0.000000346
100%		-10	1,732,499,997	-3	-0.0017	-0.000000173
100%		0	1,732,500,004	4	0.0023	0.000000231
100%		10	1,732,500,003	3	0.0017	0.000000173
100%		20	1,732,499,995	-5	-0.0029	-0.000000289
100%		30	1,732,499,996	-4	-0.0023	-0.000000231
100%		40	1,732,499,997	-3	-0.0017	-0.000000173
100%		50	1,732,499,998	-2	-0.0012	-0.000000115
115%	4.43	25	1,732,500,003	3	0.0017	0.000000173
BATT.ENDPOINT	2.90	25	1,732,500,006	6	0.0035	0.000000346

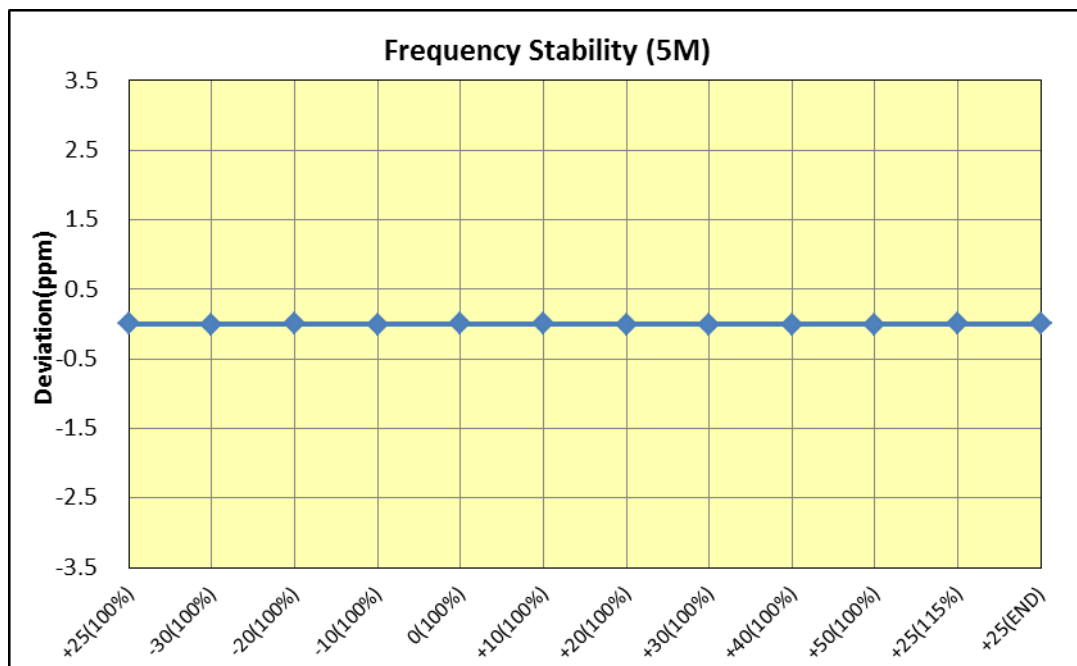

7.7.2 LTE Band 2

OPERATING FREQUENCY : 1880 MHz  
 CHANNEL : 18900  
 REFERENCE VOLTAGE : 3.85 VDC  
 DEVIATION LIMIT : The frequency stability shall be sufficient to ensure that the fundamental emission stays within the authorized frequency block.

VOLTAGE (%)	POWER (V DC)	TEMP (°C)	FREQUENCY (Hz)	FREQ.Dev (Hz)	Deviation	
					(ppm)	(%)
100%	3.85	+25(Ref)	1,879,999,995	-5	-0.0027	-0.000000266
100%		-30	1,879,999,993	-7	-0.0037	-0.000000372
100%		-20	1,879,999,992	-8	-0.0043	-0.000000426
100%		-10	1,879,999,993	-7	-0.0037	-0.000000372
100%		0	1,879,999,997	-3	-0.0016	-0.000000160
100%		+10	1,880,000,002	2	0.0011	0.000000106
100%		+20	1,880,000,003	3	0.0016	0.000000160
100%		+30	1,879,999,996	-4	-0.0021	-0.000000213
100%		+40	1,879,999,995	-5	-0.0027	-0.000000266
100%		+50	1,879,999,993	-7	-0.0037	-0.000000372
115%		4.43	+25	1,879,999,993	-7	-0.0037
BATT.ENDPOINT	2.90	+25	1,879,999,997	-3	-0.0016	-0.000000160

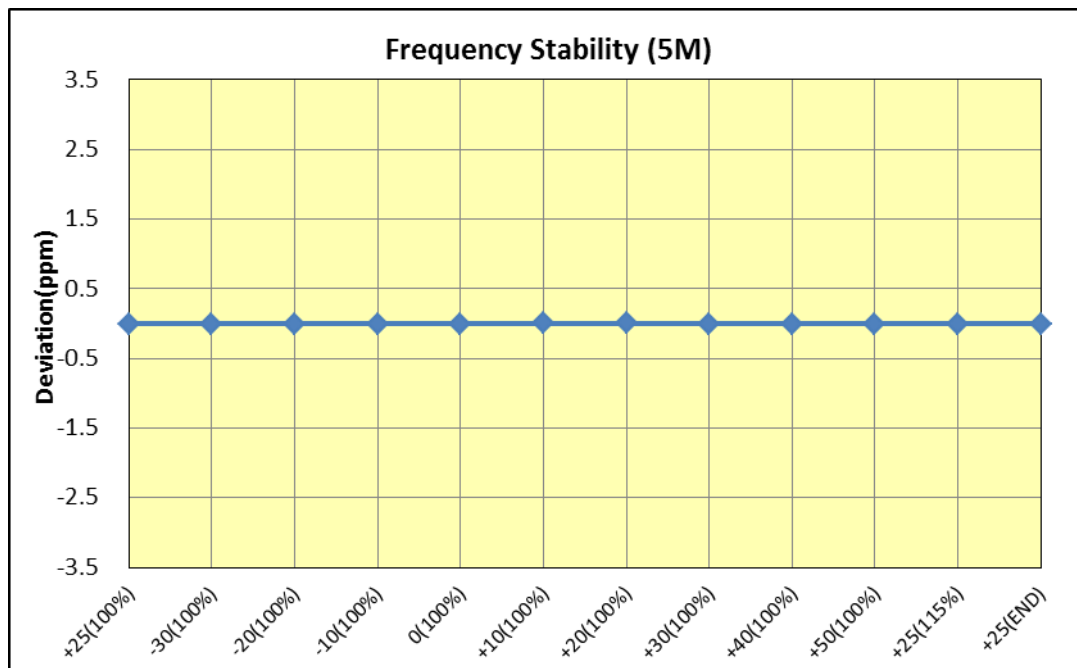



7.7.3 LTE Band 7

OPERATING FREQUENCY : 2535 MHz  
 CHANNEL : 21100  
 REFERENCE VOLTAGE : 3.85\_VDC  
 DEVIATION LIMIT : The frequency stability shall be sufficient to ensure that the fundamental emission stays within the authorized frequency block.

VOLTAGE (%)	POWER (V DC)	TEMP (°C)	FREQUENCY (Hz)	FREQ.Dev (Hz)	Deviation	
					(ppm)	(%)
100%	3.85	+25(Ref)	2,535,000,001	1	0.0004	0.000000039
100%		-30	2,534,999,996	-4	-0.0016	-0.000000158
100%		-20	2,535,000,005	5	0.0020	0.000000197
100%		-10	2,535,000,008	8	0.0032	0.000000316
100%		0	2,535,000,006	6	0.0024	0.000000237
100%		+10	2,535,000,008	8	0.0032	0.000000316
100%		+20	2,534,999,998	-2	-0.0008	-0.000000079
100%		+30	2,534,999,997	-3	-0.0012	-0.000000118
100%		+40	2,535,000,004	4	0.0016	0.000000158
100%		+50	2,534,999,998	-2	-0.0008	-0.000000079
115%		4.43	+25	2,535,000,006	6	0.0024
BATT.ENDPOINT	2.90	+25	2,534,999,995	-5	-0.0020	-0.000000197

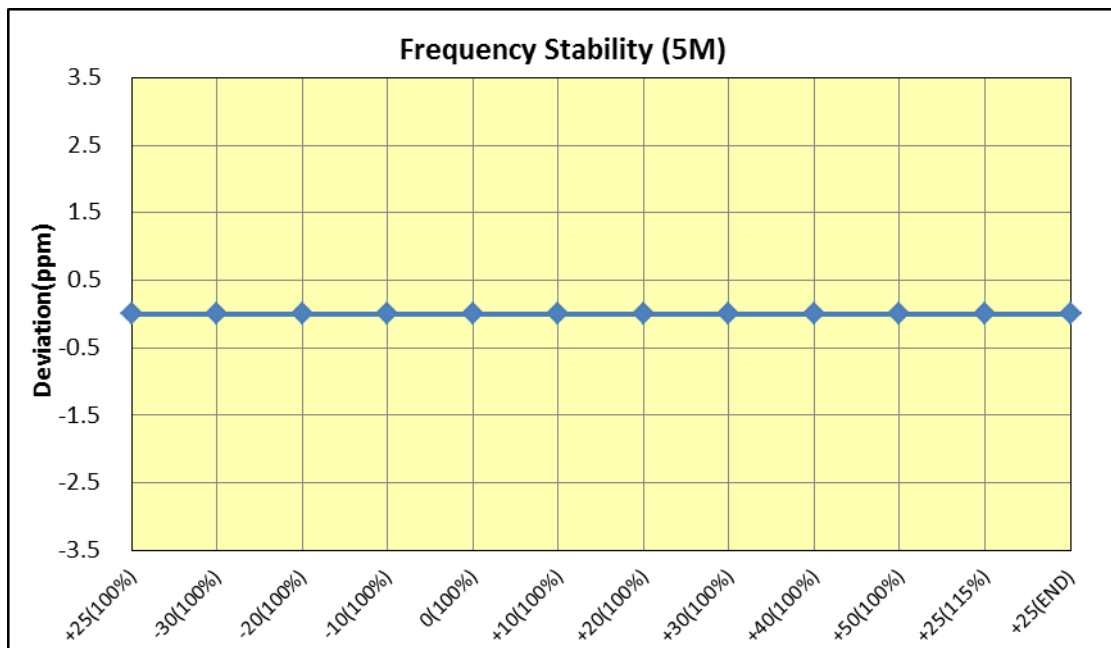

## 8. TEST PLOTS

Note: All bandwidths, RB configurations, and modulations were investigated. The worst case test results are reported below.

### 8.1 OCCUPIED BANDWIDTH

#### 8.1.1 LTE Band 4

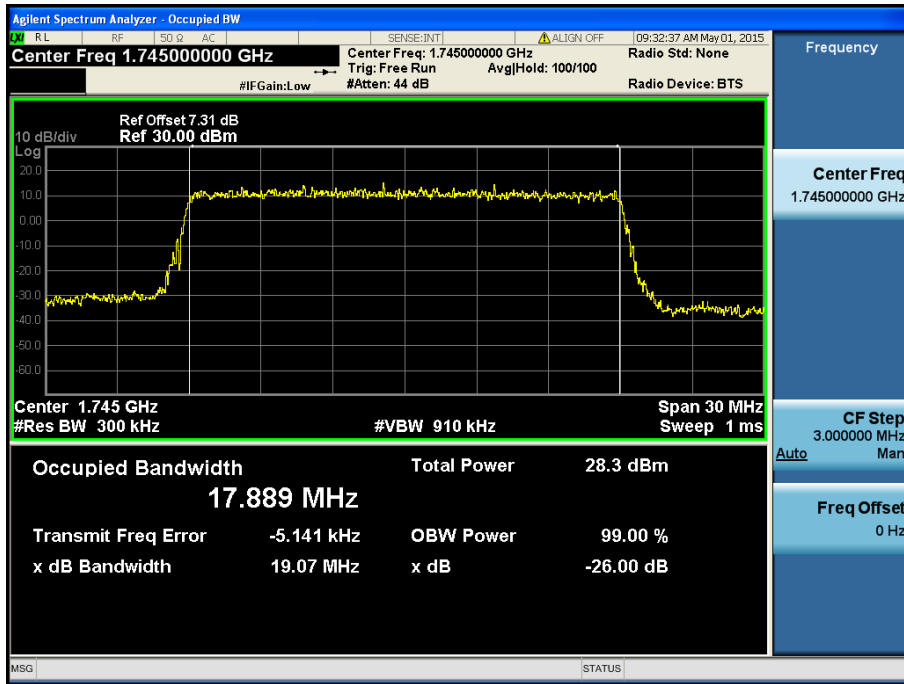

LTE Band 4 / 20 MHz / QPSK - RB Size 100

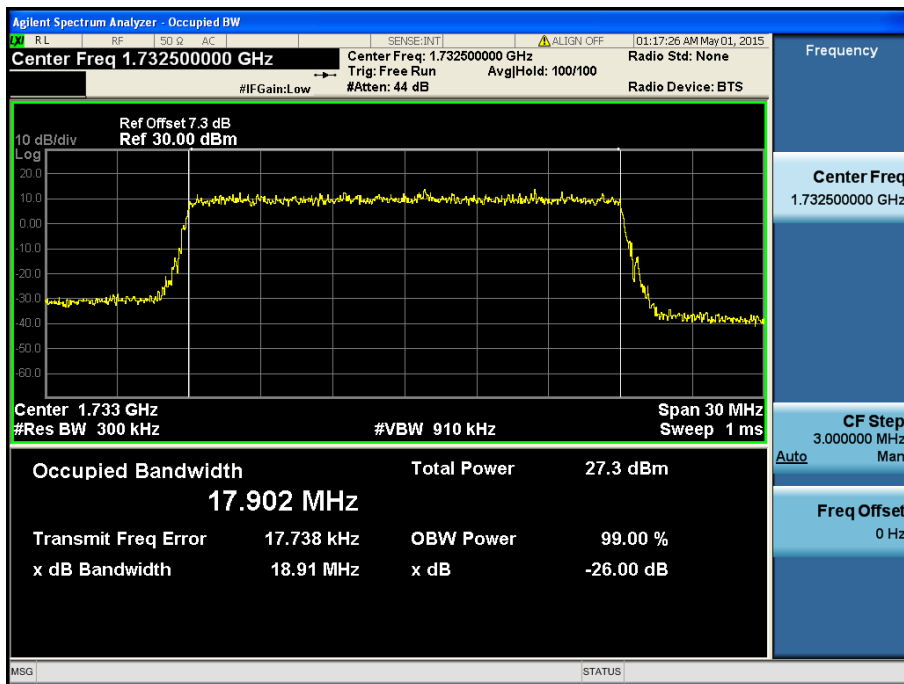

LTE Band 4 / 20 MHz / 16QAM - RB Size 100

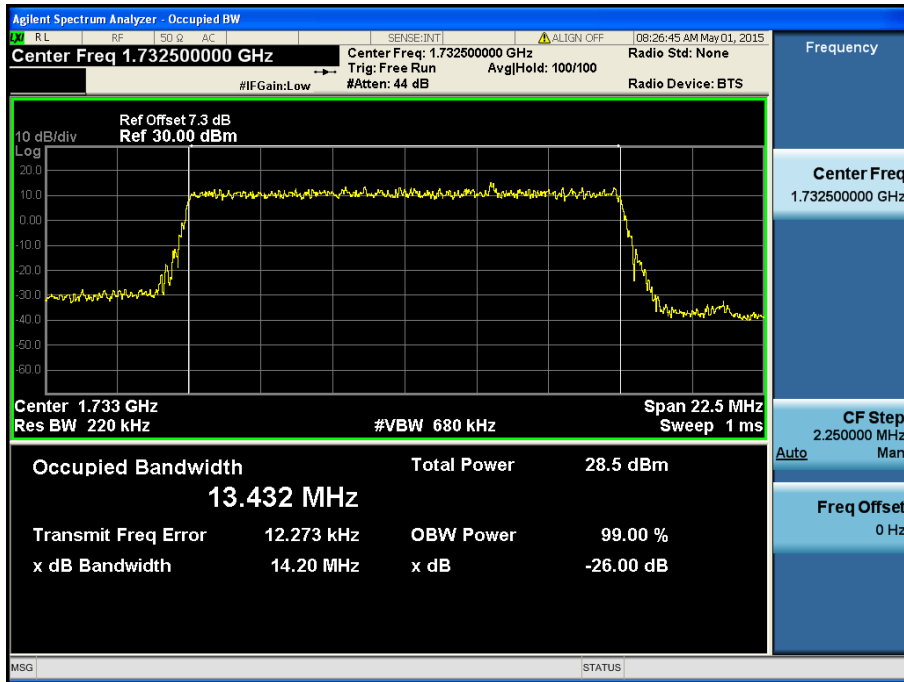

LTE Band 4 / 15 MHz / QPSK - RB Size 75

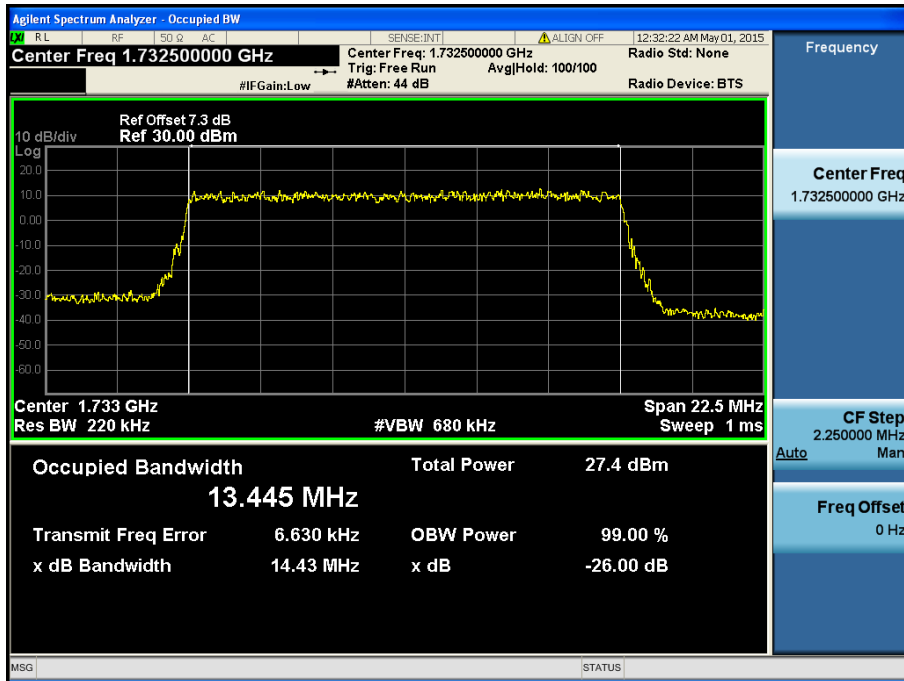

LTE Band 4 / 15 MHz / 16QAM - RB Size 75

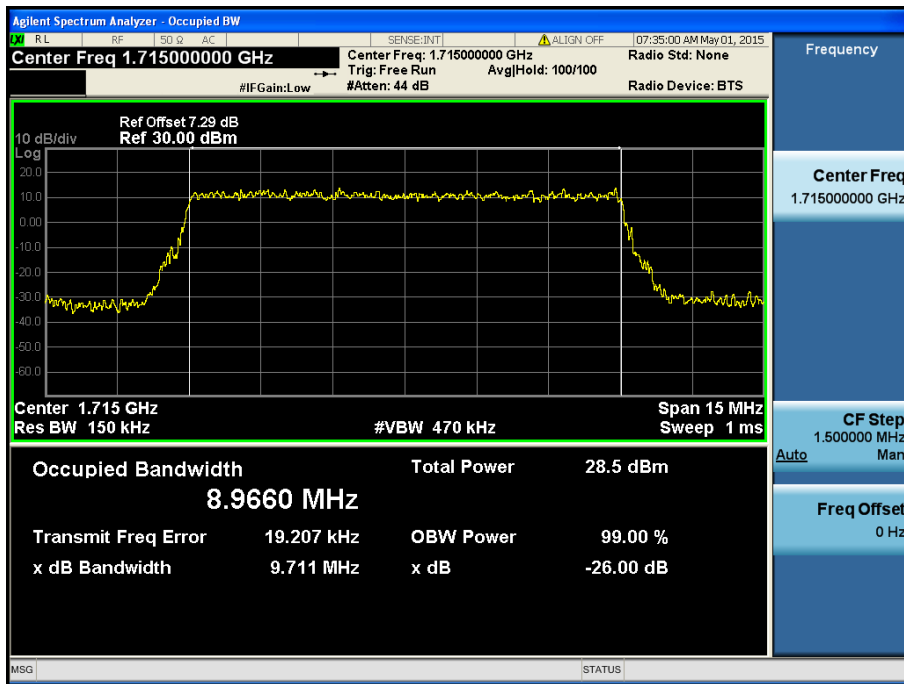

LTE Band 4 / 10 MHz / QPSK - RB Size 50

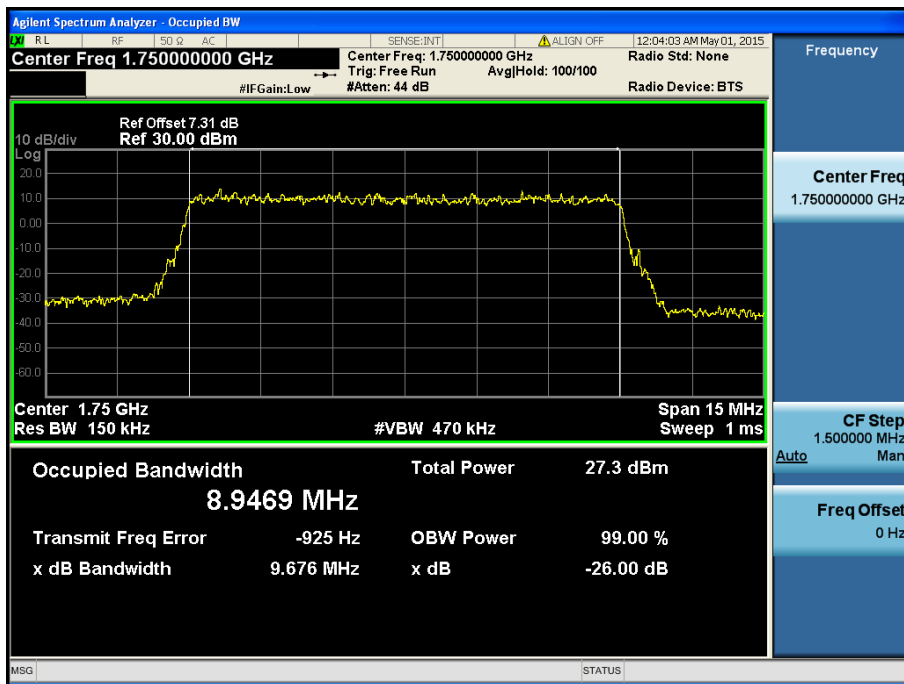

LTE Band 4 / 10 MHz / 16QAM - RB Size 50

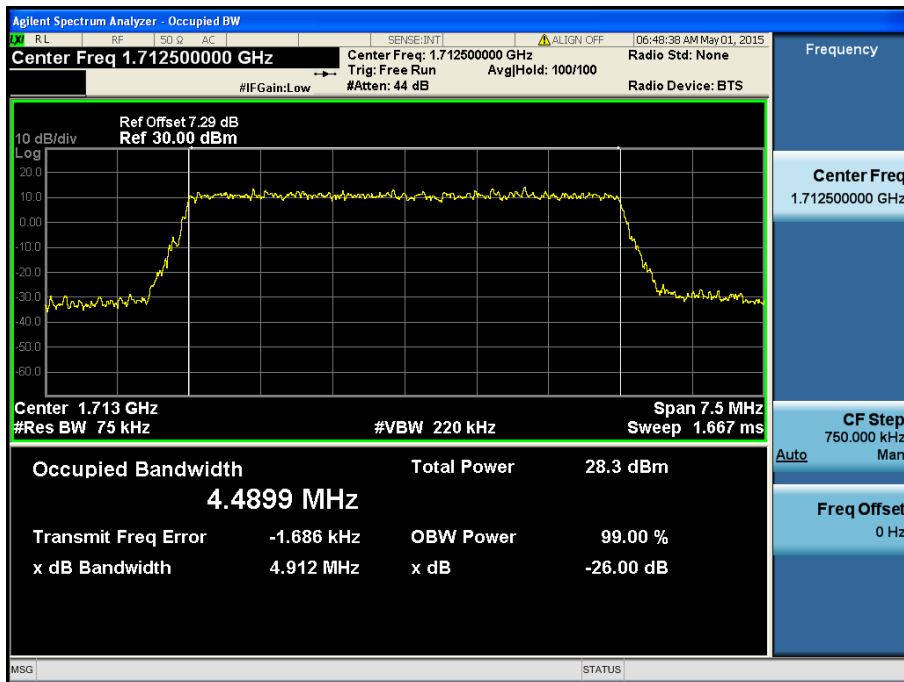

LTE Band 4 / 5 MHz / QPSK - RB Size 25

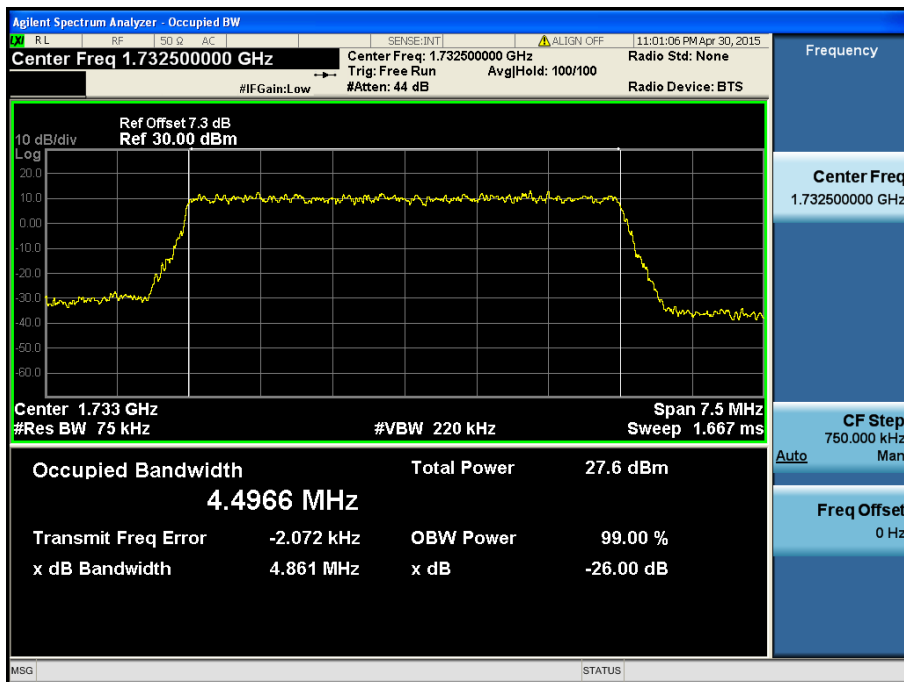

LTE Band 4 / 5 MHz / 16QAM - RB Size 25

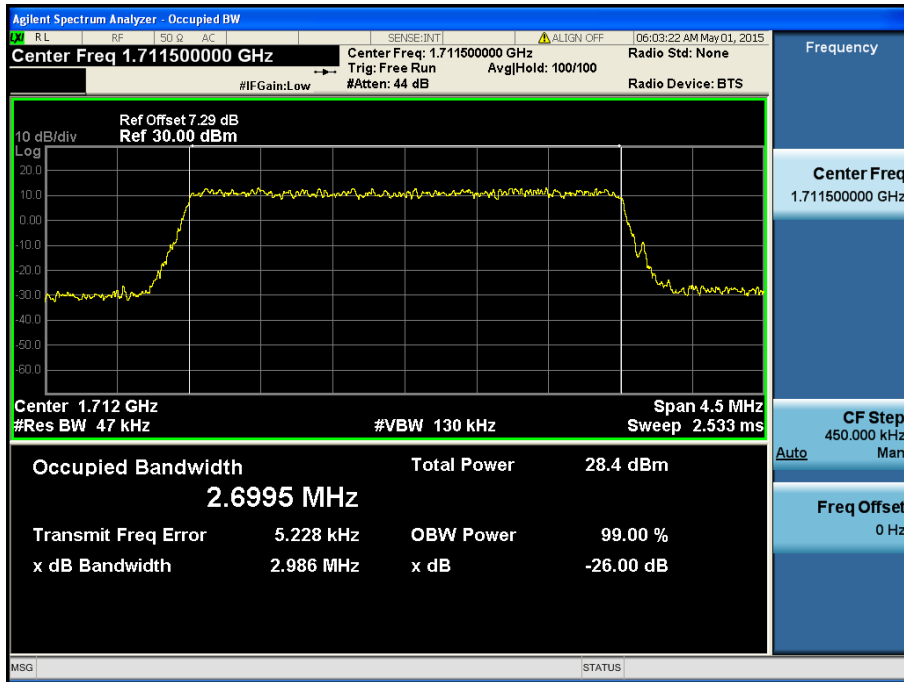

LTE Band 4 / 3 MHz / QPSK - RB Size 15

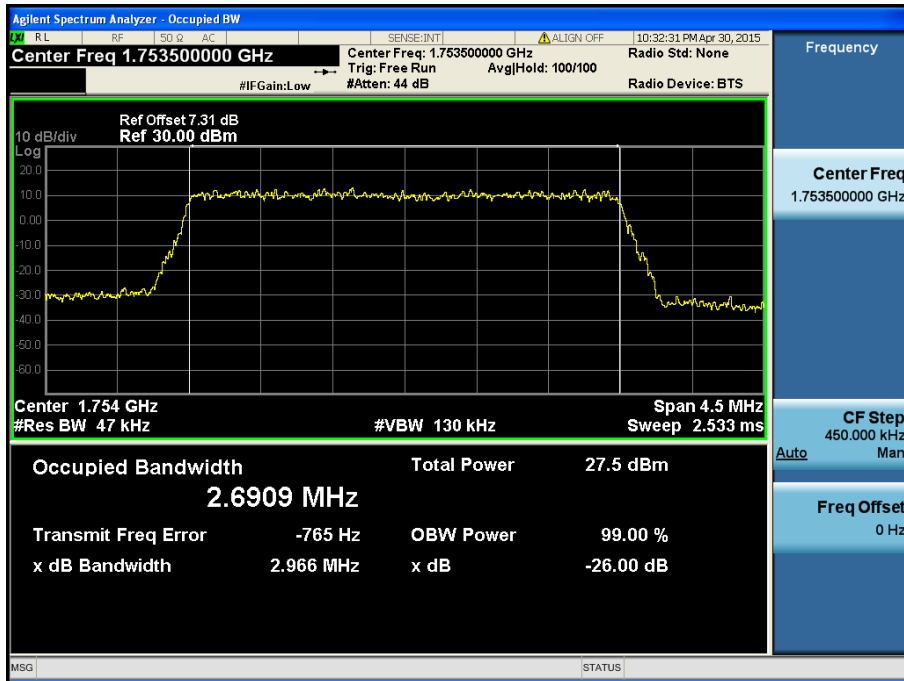

LTE Band 4 / 3 MHz / 16QAM - RB Size 15

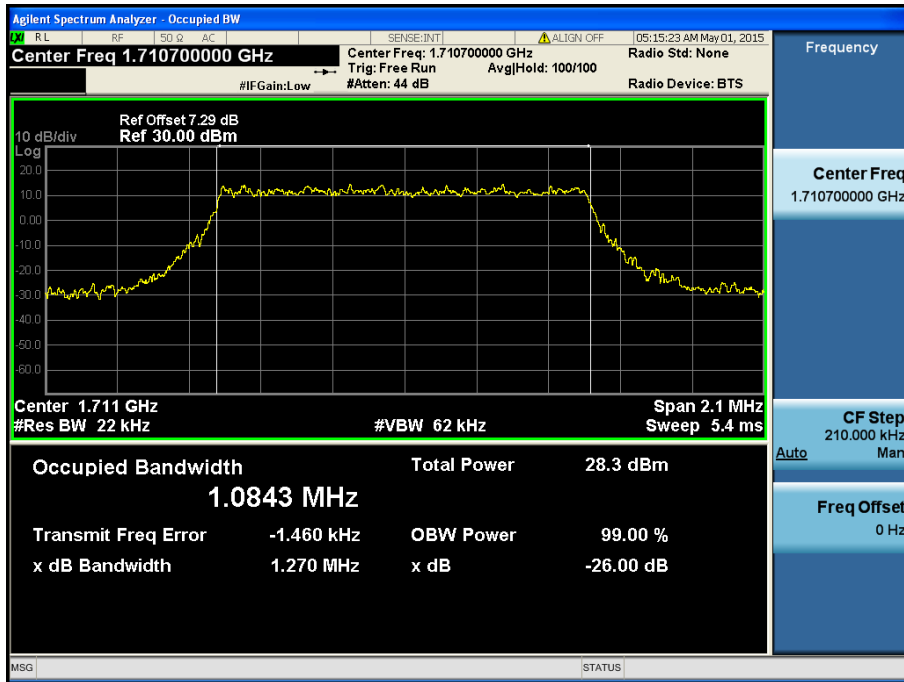

LTE Band 4 / 1.4 MHz / QPSK - RB Size 6

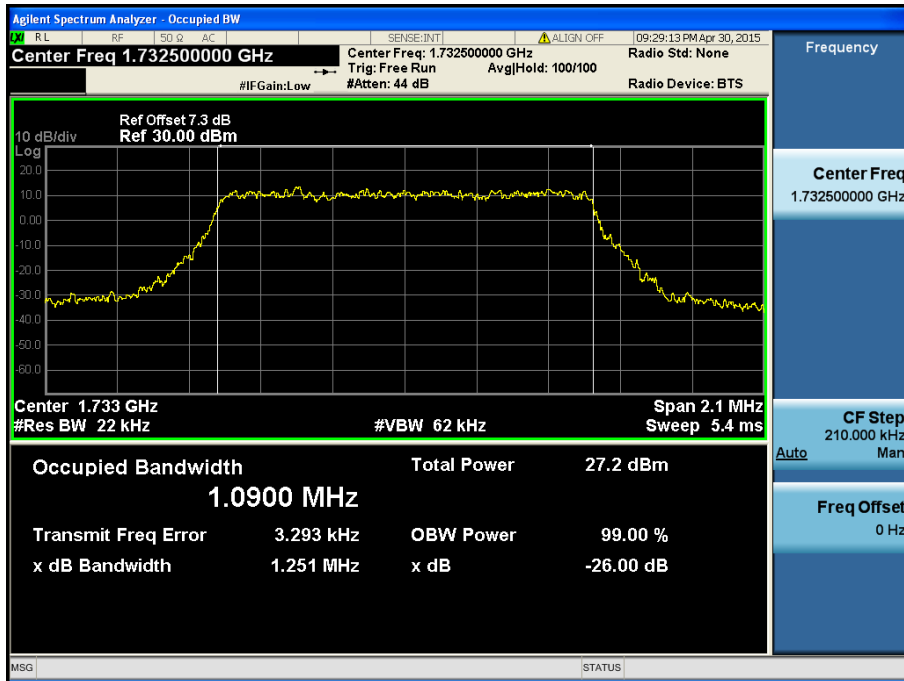

LTE Band 4 / 1.4 MHz / 16QAM - RB Size 6

8.1.2 LTE Band 2

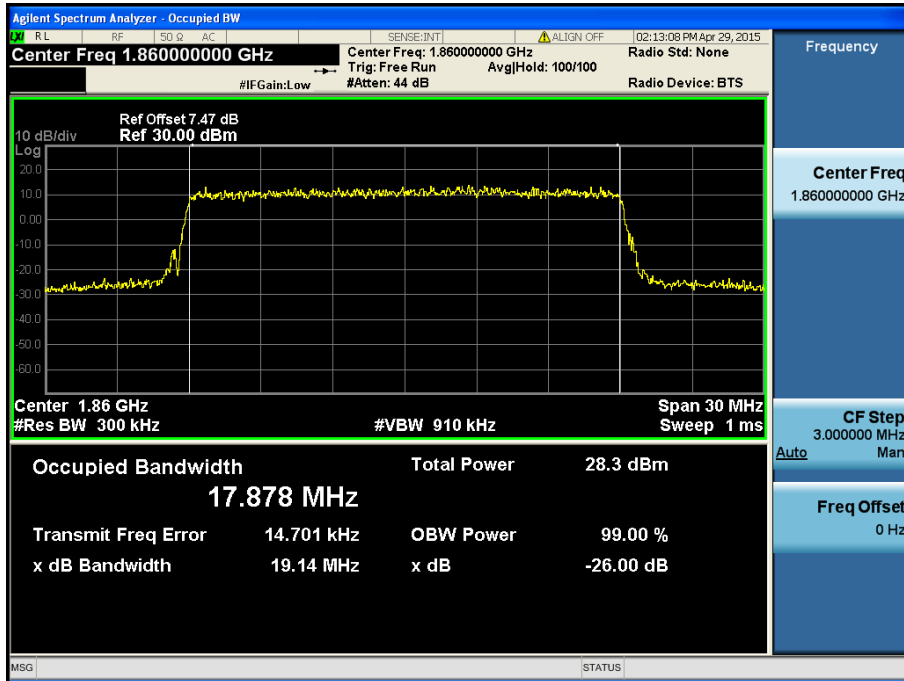

LTE Band 2 / 20 MHz / QPSK - RB Size 100

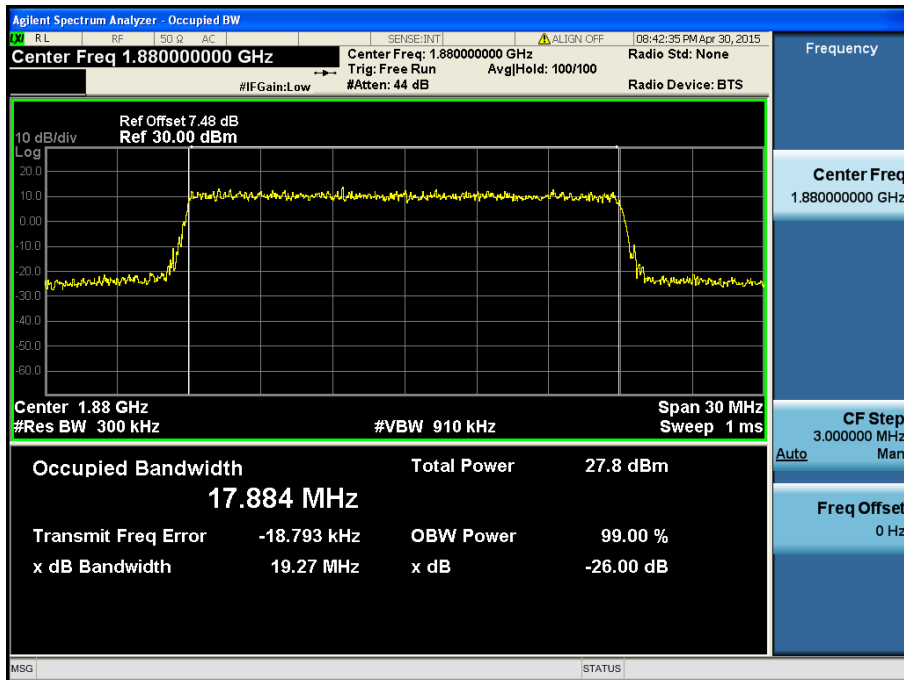

LTE Band 2 / 20 MHz / 16QAM - RB Size 100



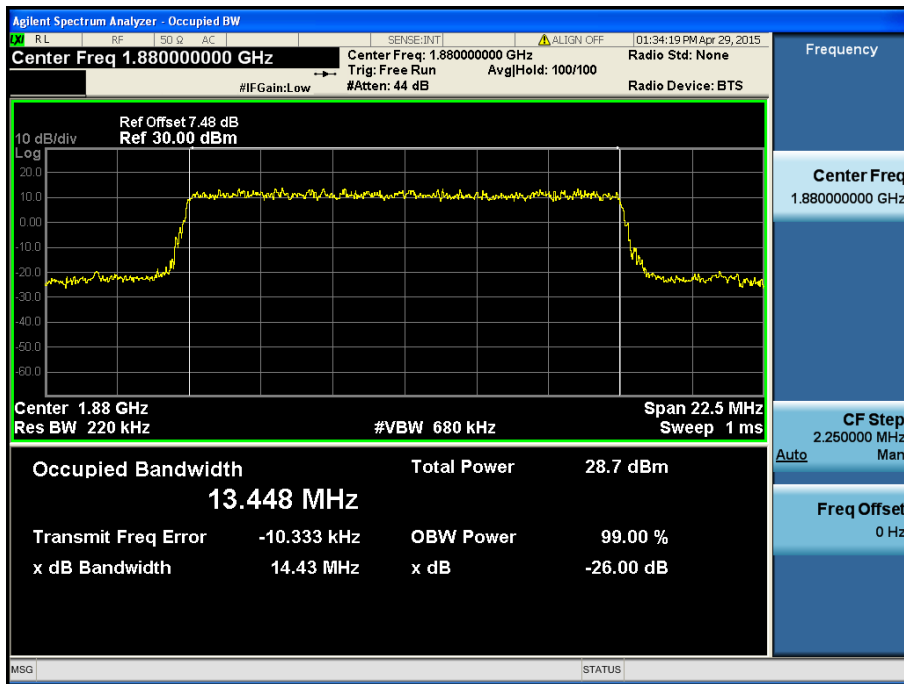

LTE Band 2 / 15 MHz / QPSK - RB Size 75

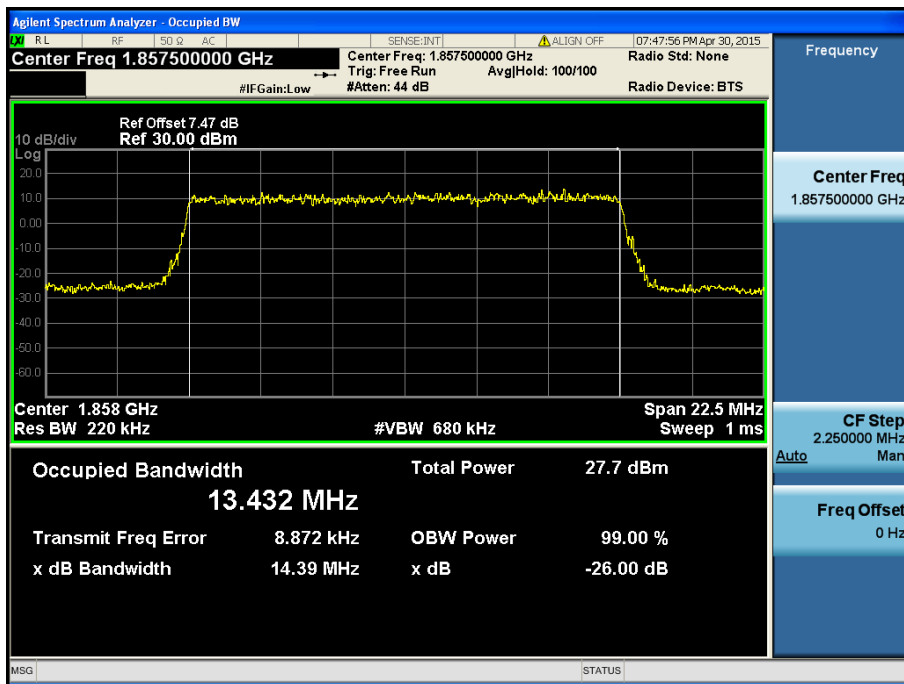

LTE Band 2 / 15 MHz / 16QAM - RB Size 75

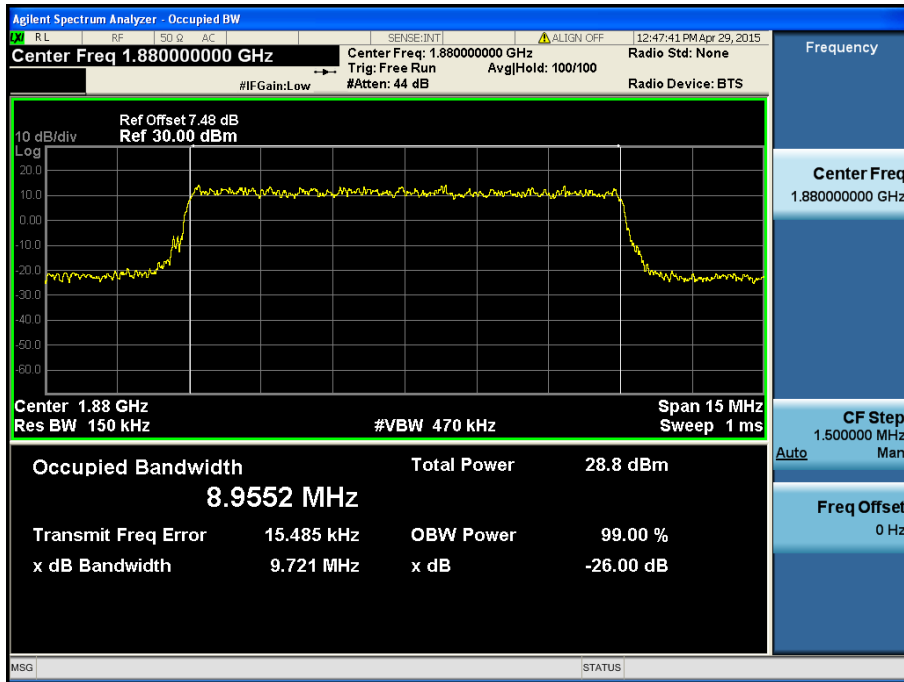

LTE Band 2 / 10 MHz / QPSK - RB Size 50

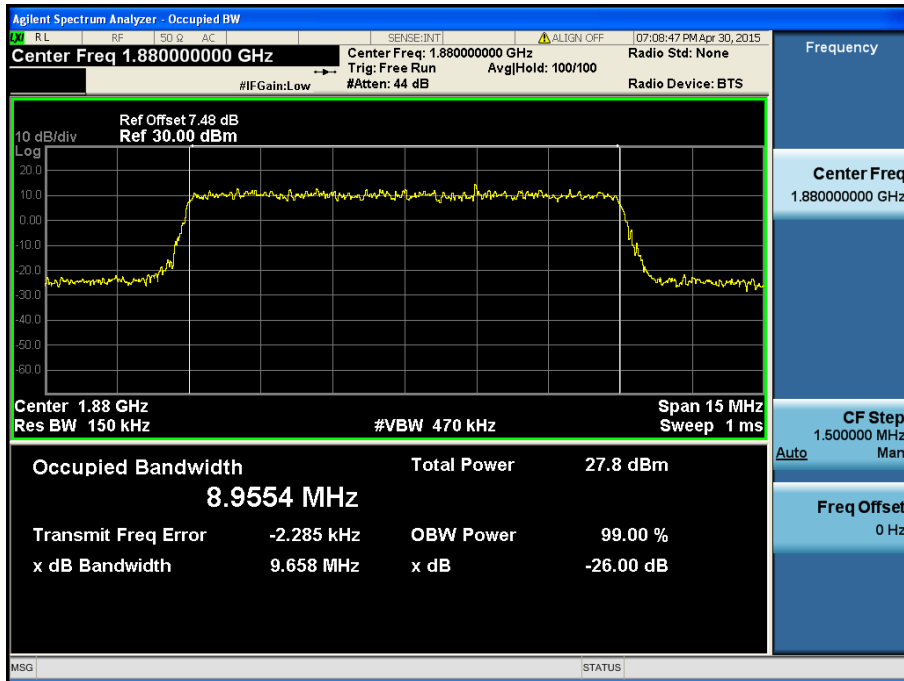

LTE Band 2 / 10 MHz / 16QAM - RB Size 50

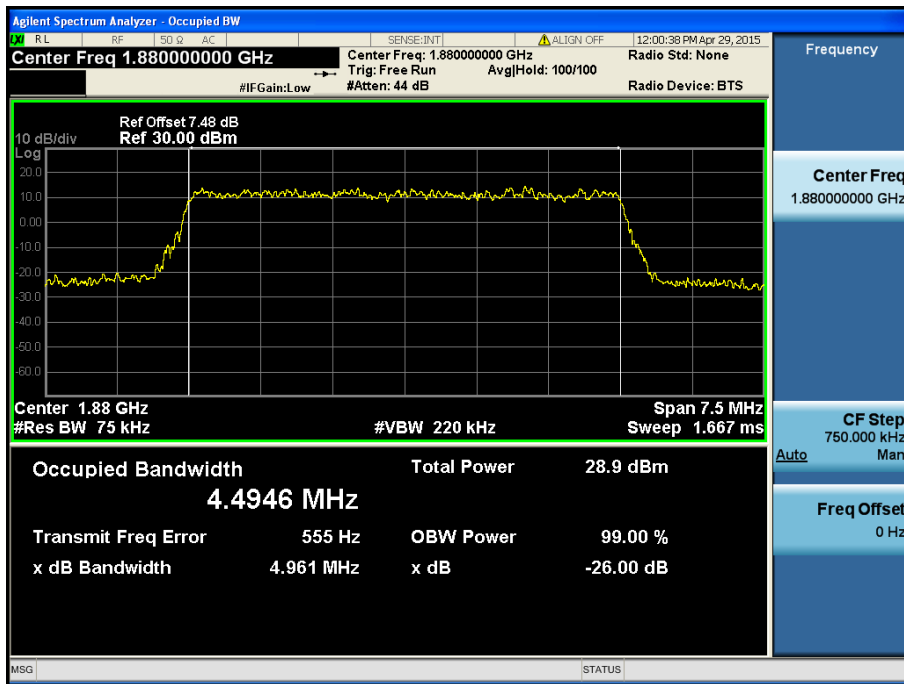

LTE Band 2 / 5 MHz / QPSK - RB Size 25

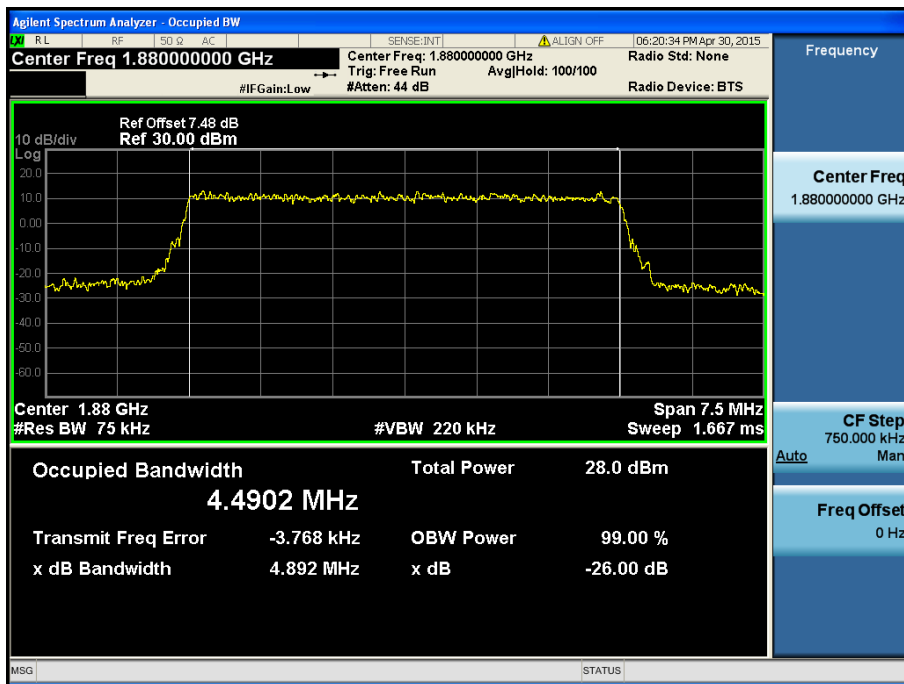

LTE Band 2 / 5 MHz / 16QAM - RB Size 25

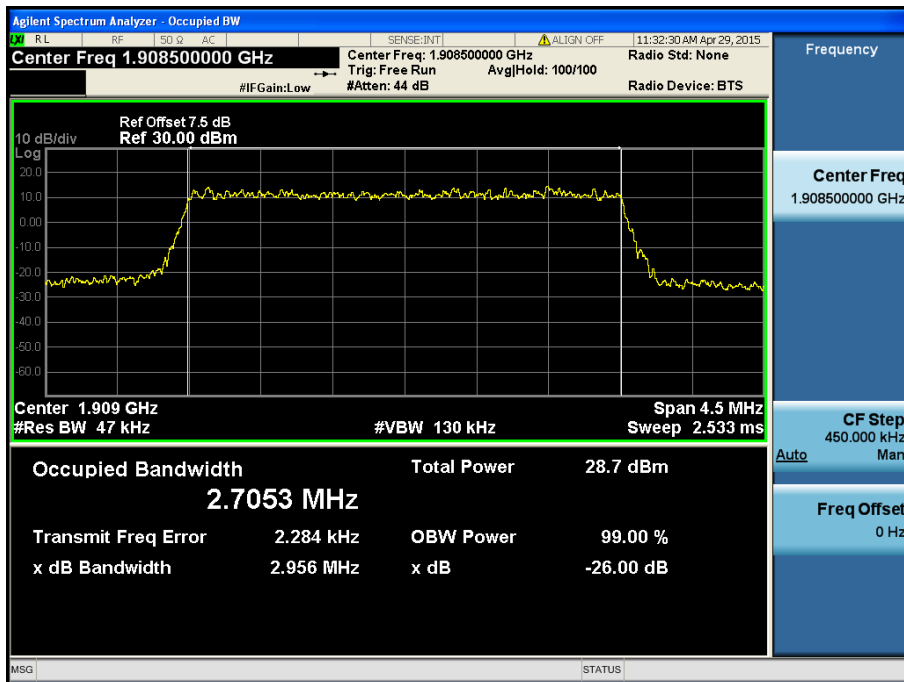

LTE Band 2 / 3 MHz / QPSK - RB Size 15

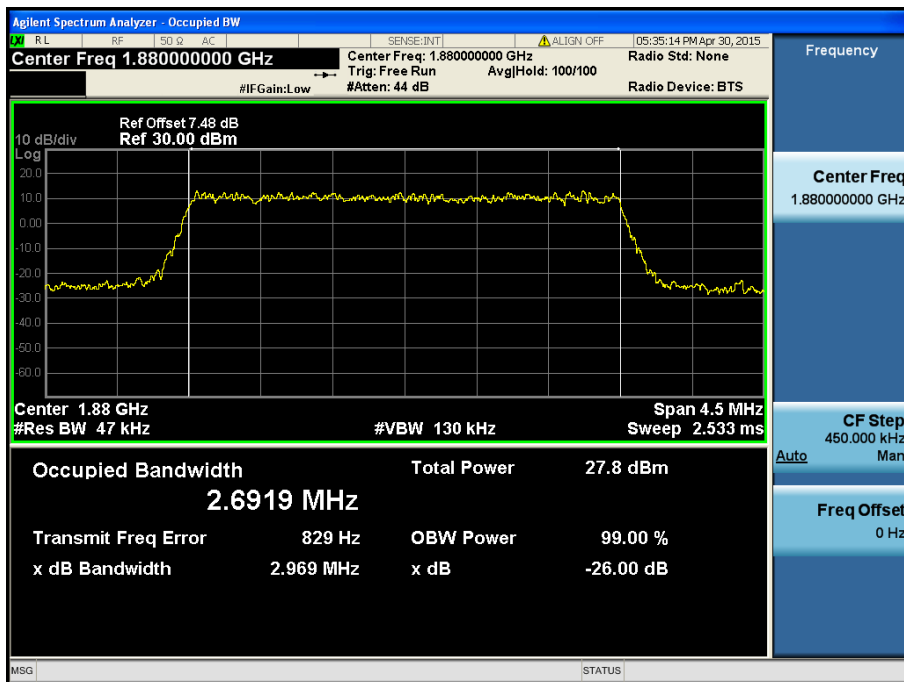

LTE Band 2 / 3 MHz / 16QAM - RB Size 15

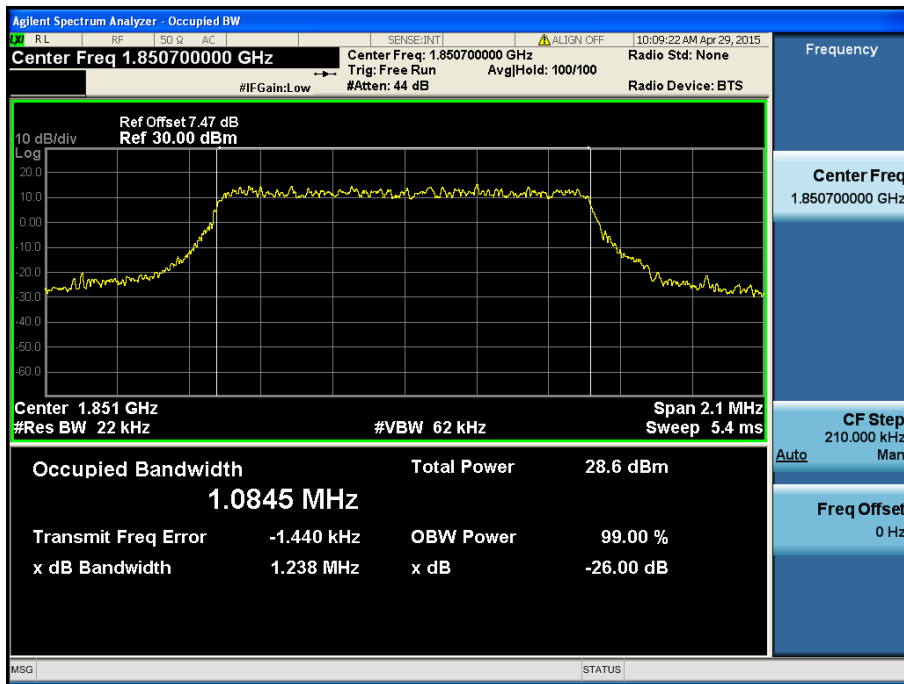

LTE Band 2 / 1.4 MHz / QPSK - RB Size 6

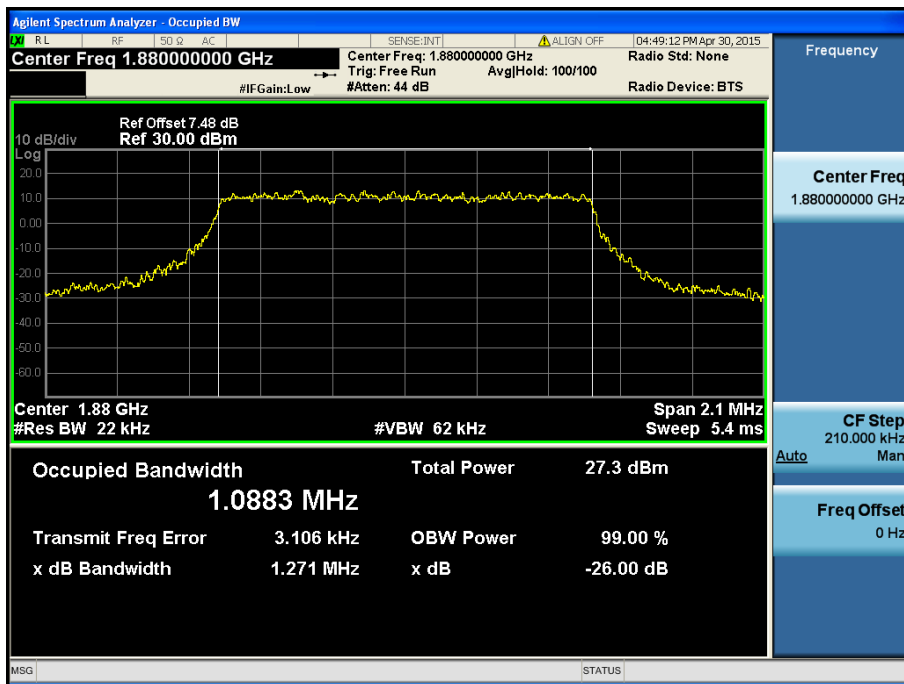

LTE Band 2 / 1.4 MHz / 16QAM - RB Size 6

8.1.3 LTE Band 7

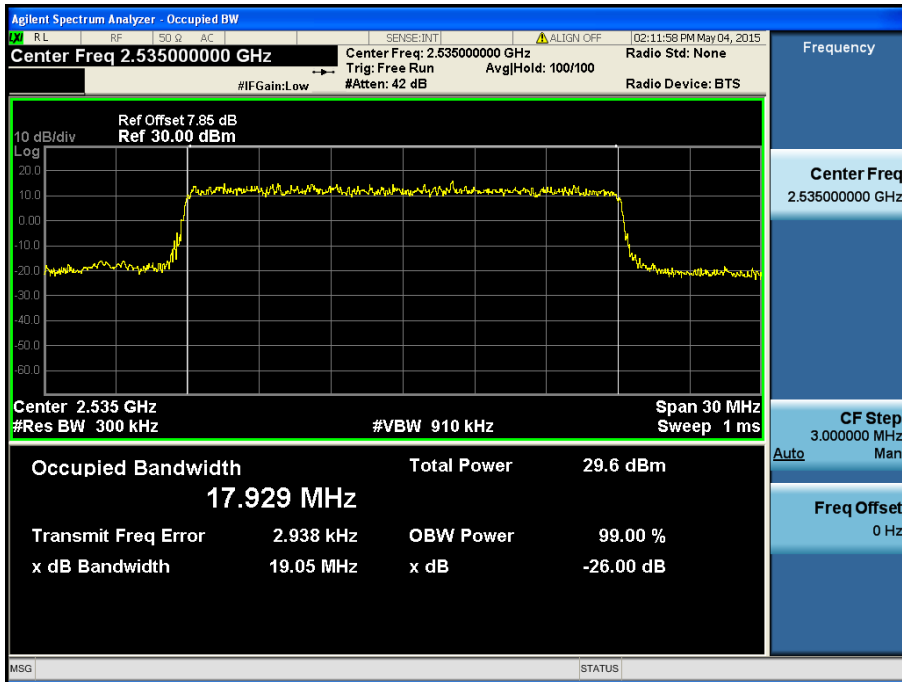

LTE Band 7 / 20 MHz / QPSK - RB Size 100

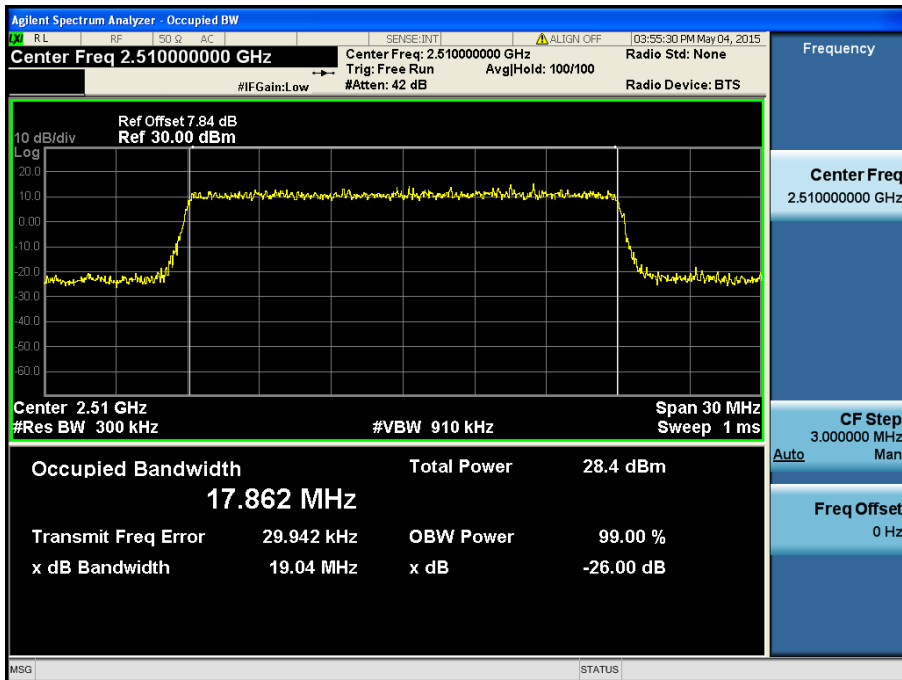

LTE Band 7 / 20 MHz / 16QAM - RB Size 100

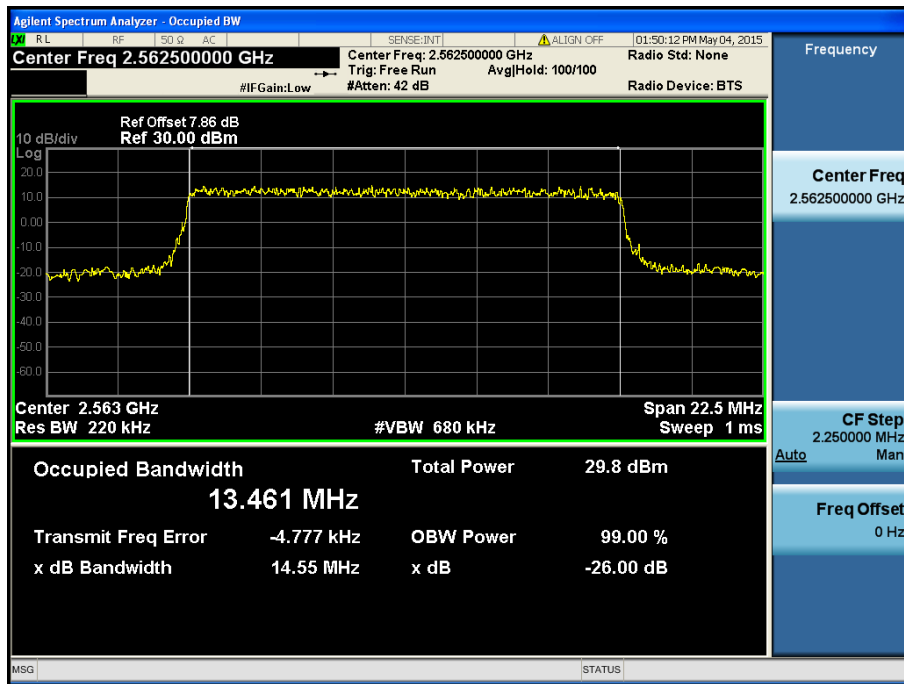

LTE Band 7 / 15 MHz / QPSK - RB Size 75

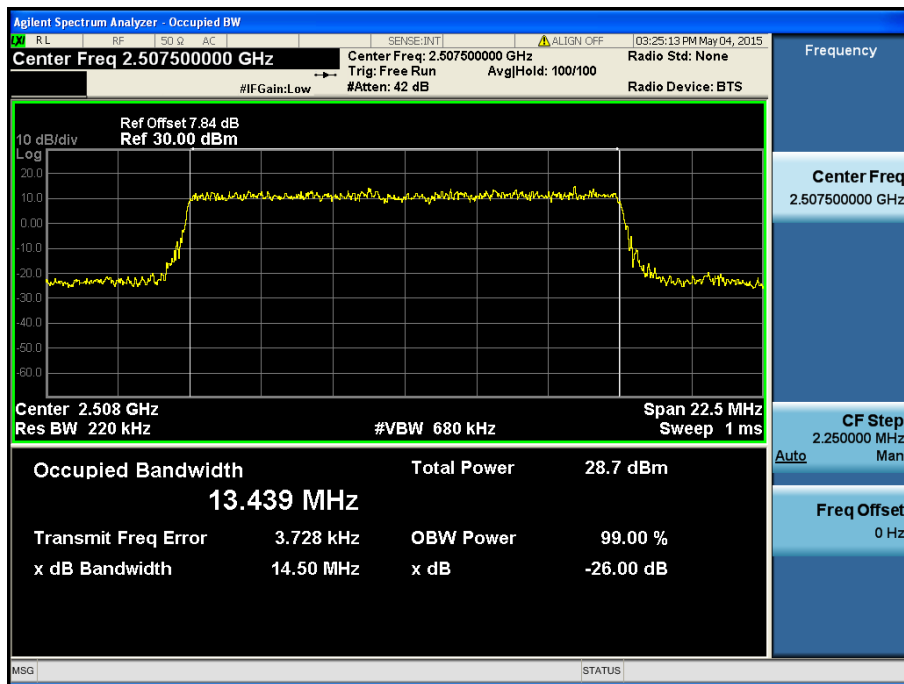

LTE Band 7 / 15 MHz / 16QAM - RB Size 75

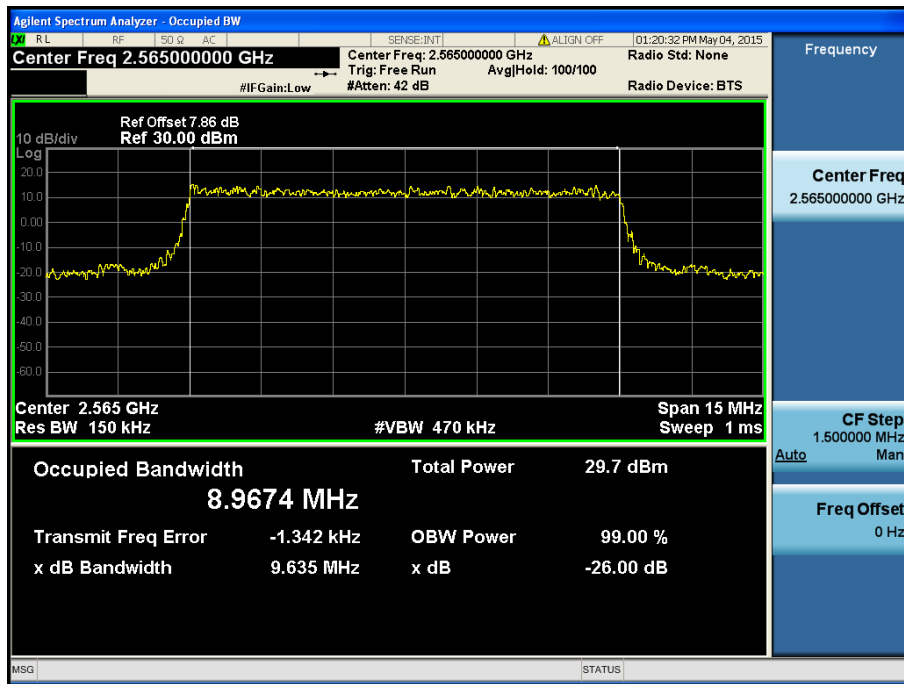

LTE Band 7 / 10 MHz / QPSK - RB Size 50

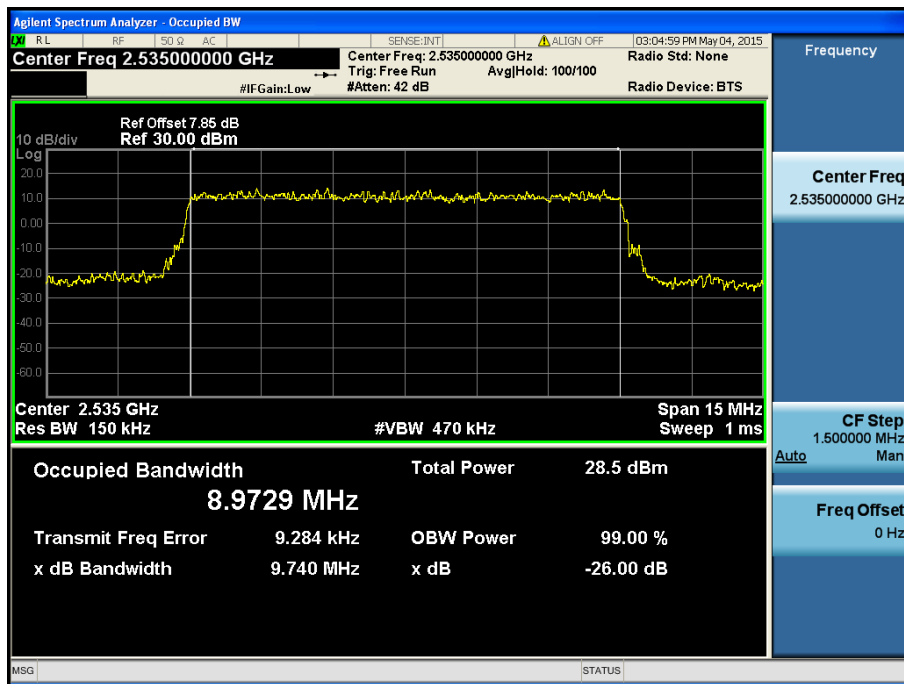

LTE Band 7 / 10 MHz / 16QAM - RB Size 50



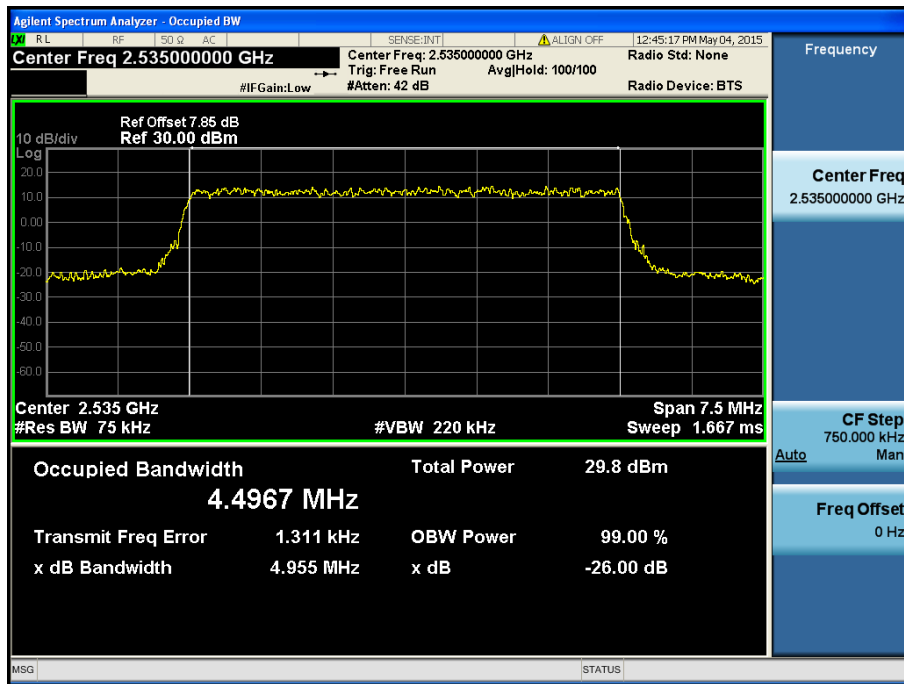

LTE Band 7 / 5 MHz / QPSK - RB Size 25

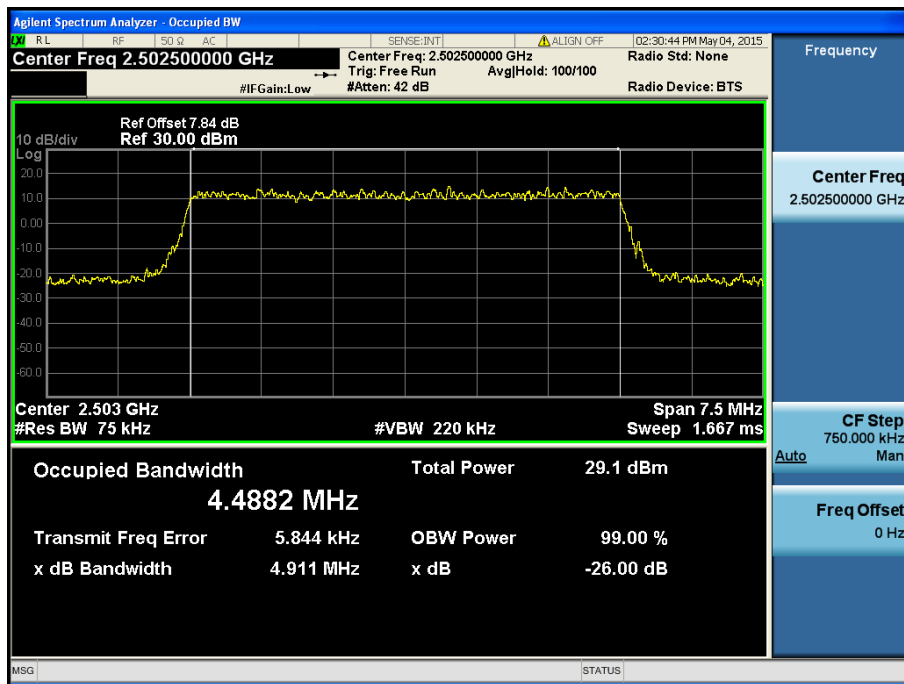

LTE Band 7 / 5 MHz / 16QAM - RB Size 25

## 8.2 PEAK TO AVERAGE RATIO

### 8.2.1 LTE Band 4

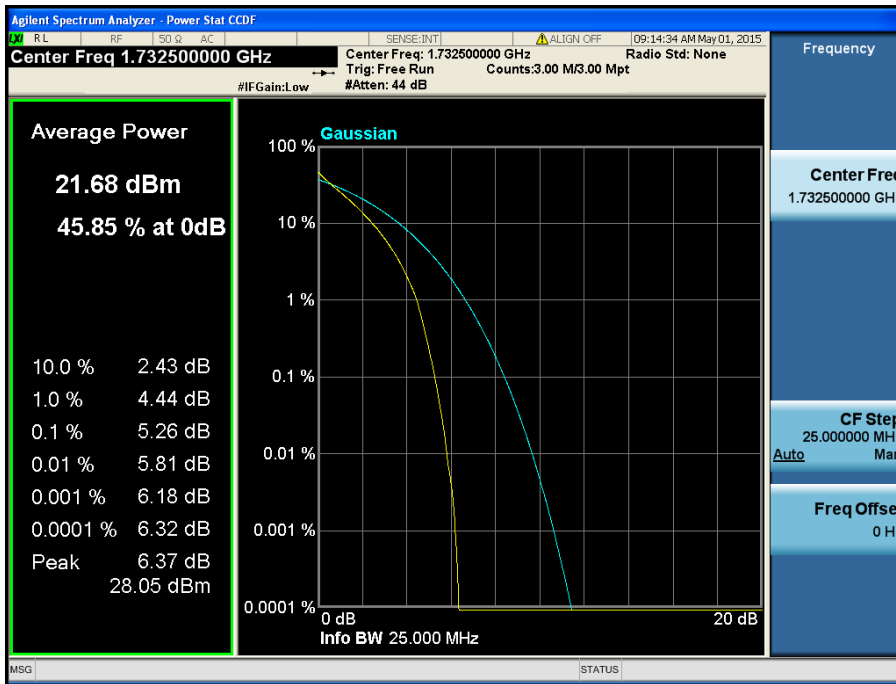

LTE Band 4 / 20 MHz / QPSK - RB Size 100

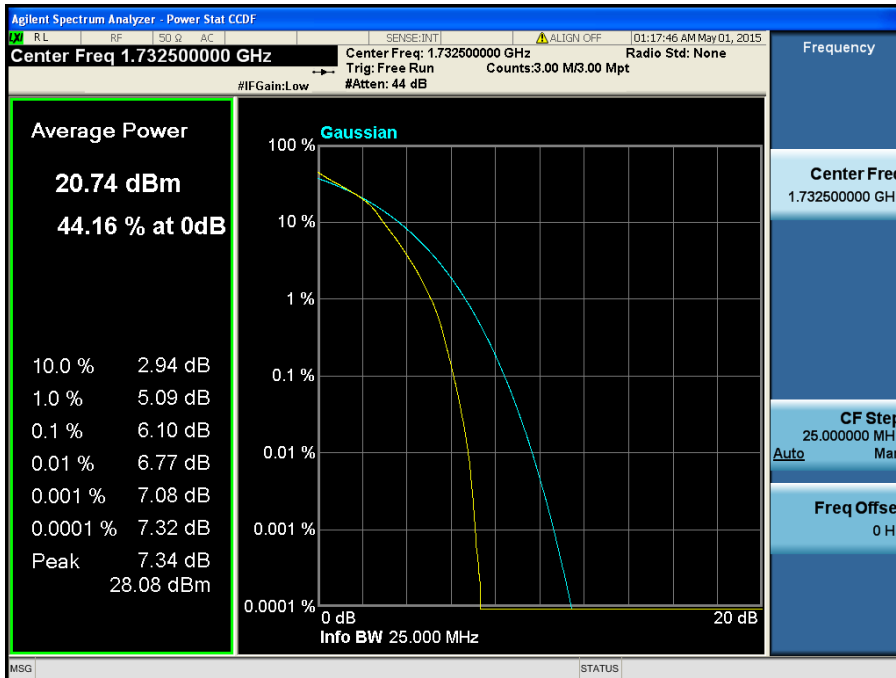

LTE Band 4 / 20 MHz / 16QAM - RB Size 100

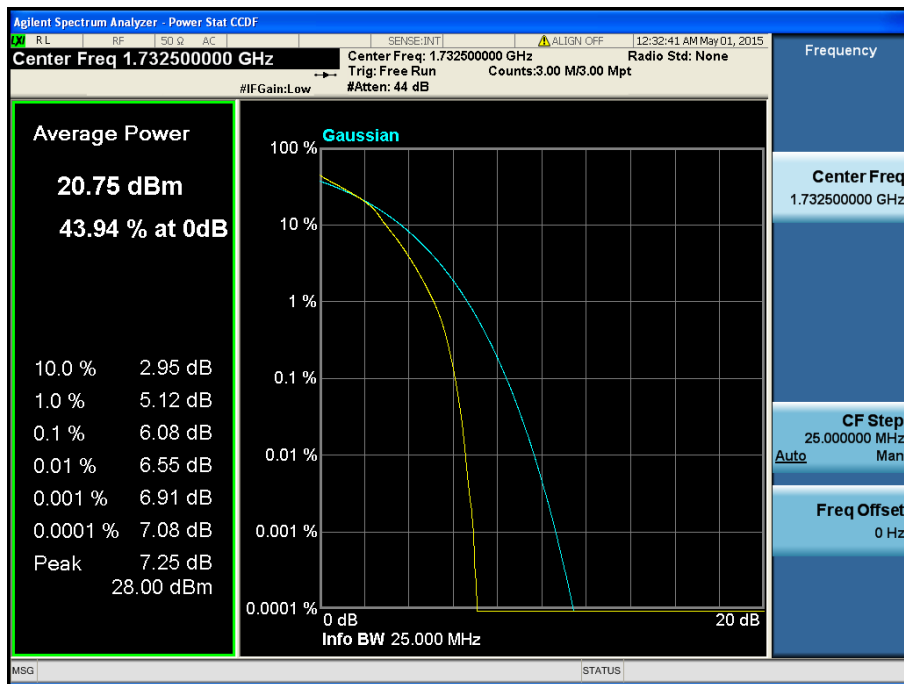
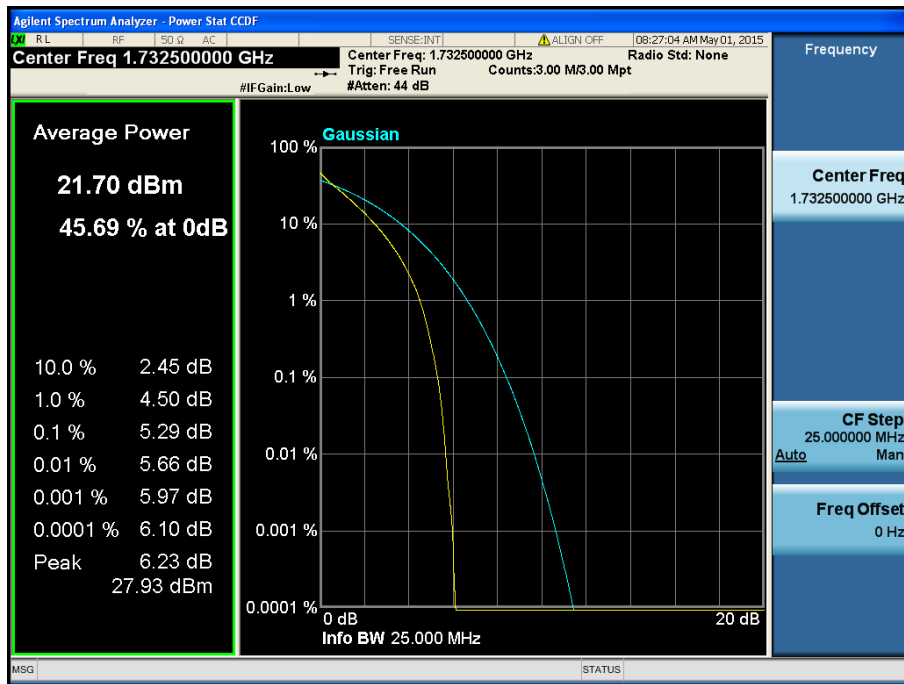

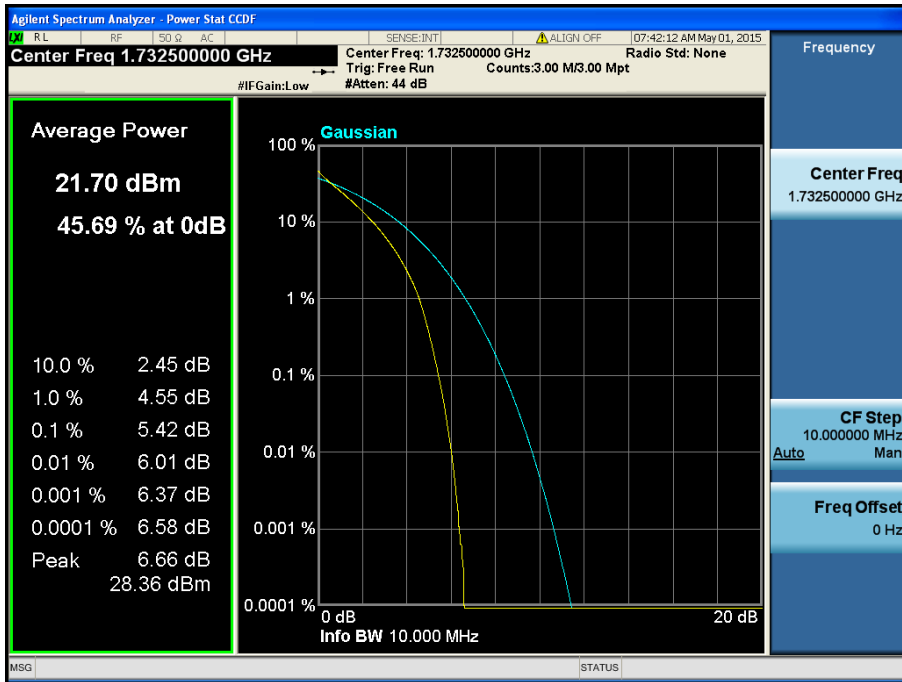

LTE Band 4 / 10 MHz / QPSK - RB Size 50

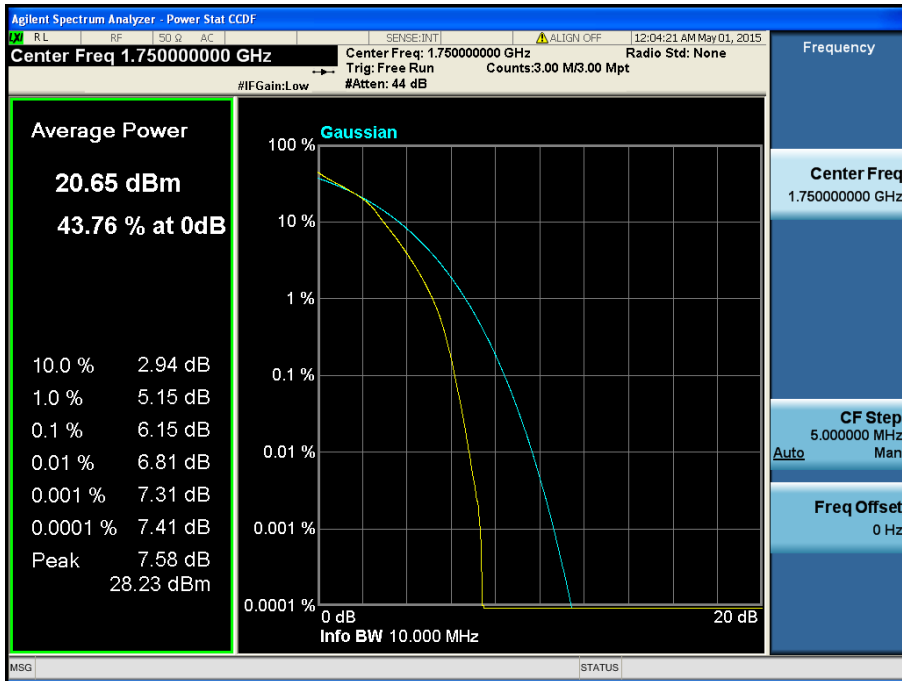

LTE Band 4 / 10 MHz / 16QAM - RB Size 50

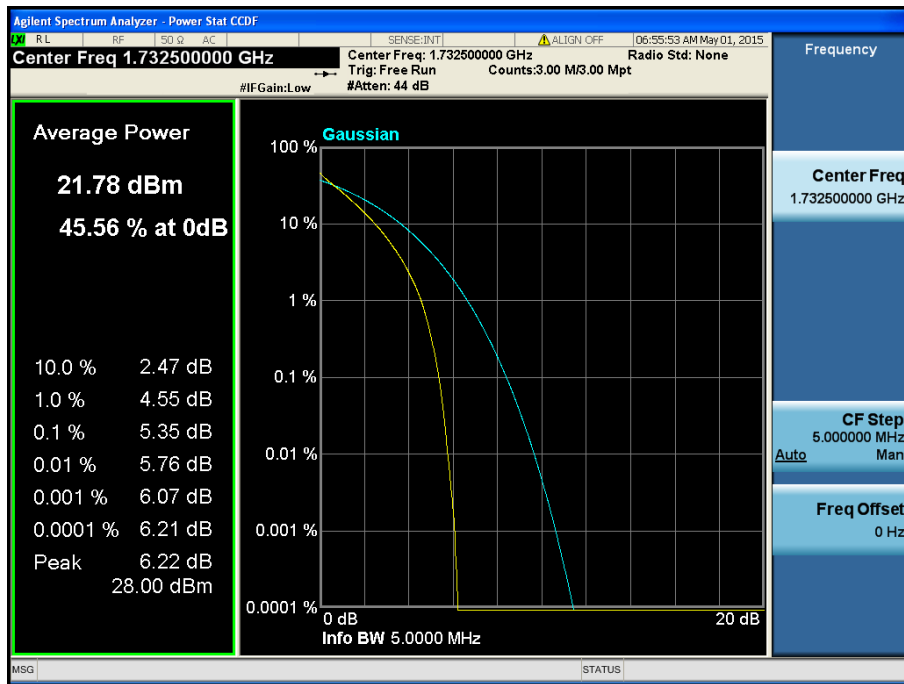

LTE Band 4 / 5 MHz / QPSK - RB Size 25

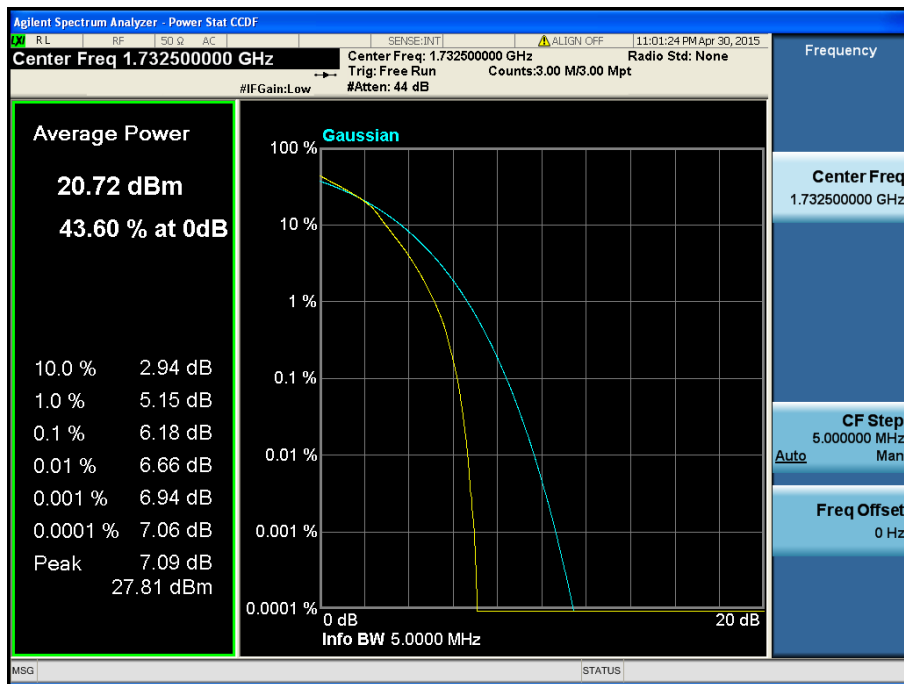

LTE Band 4 / 5 MHz / 16QAM - RB Size 25

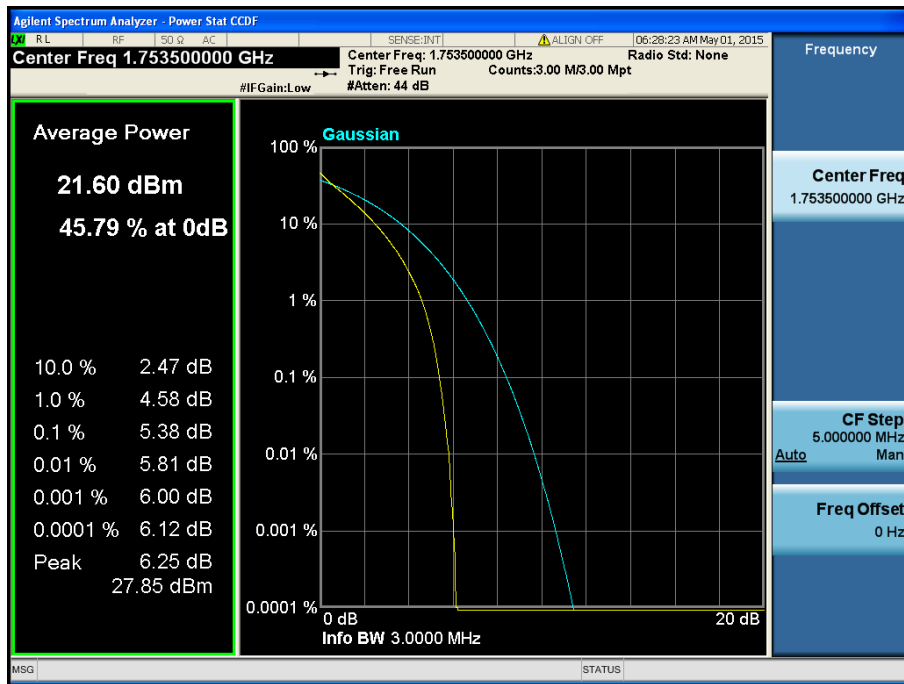

LTE Band 4 / 3 MHz / QPSK - RB Size 15

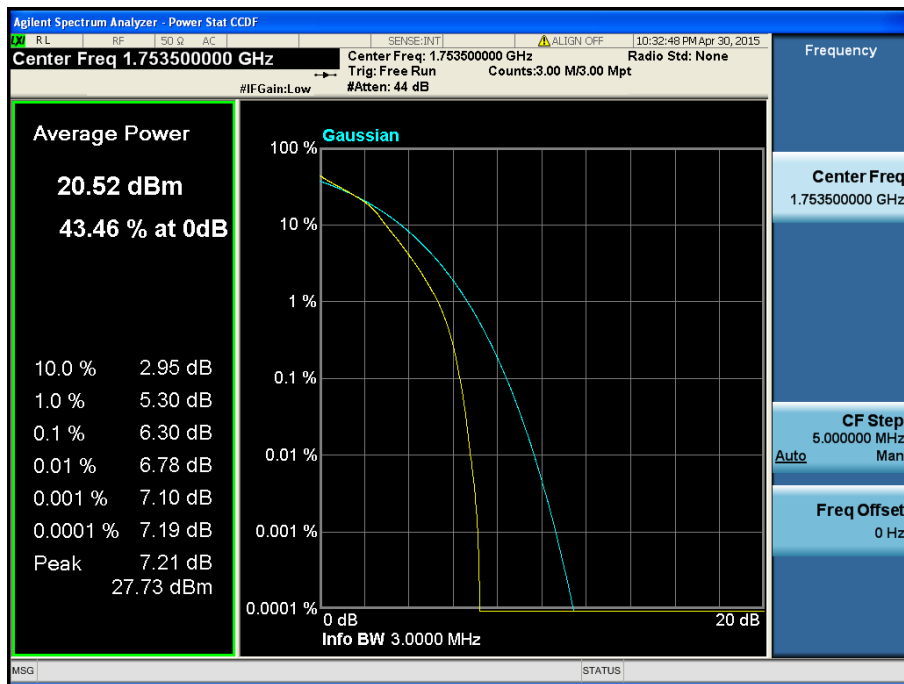

LTE Band 4 / 3 MHz / 16QAM - RB Size 15

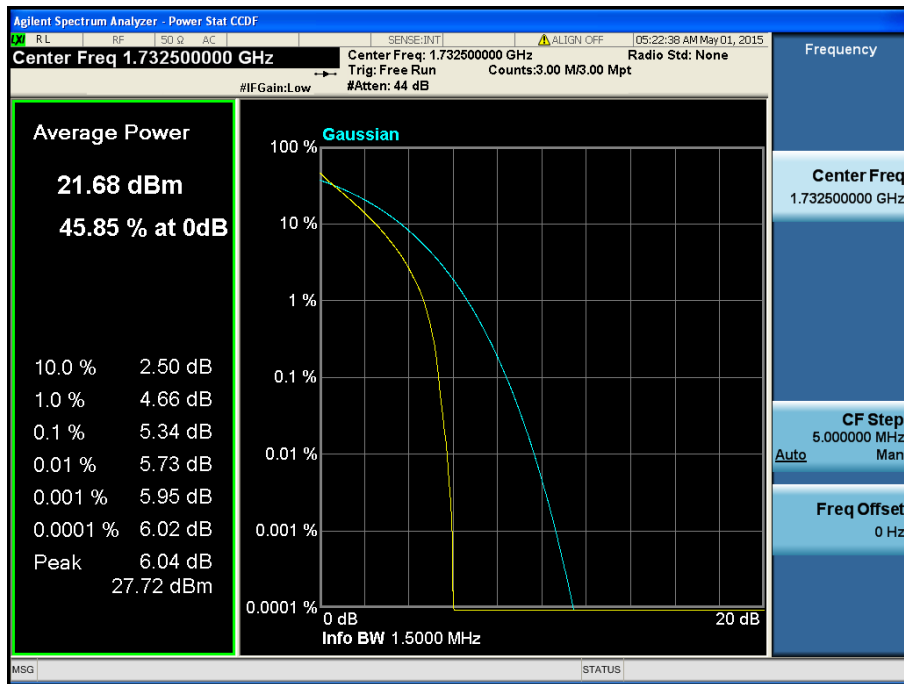

LTE Band 4 / 1.4 MHz / QPSK - RB Size 6

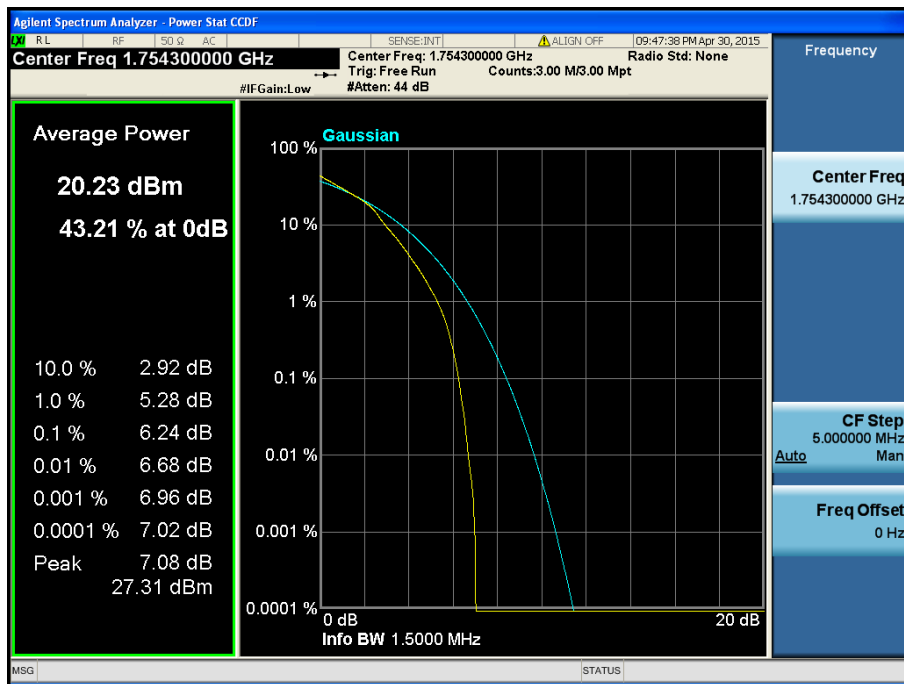

LTE Band 4 / 1.4 MHz / 16QAM - RB Size 6

8.2.2 LTE Band 2

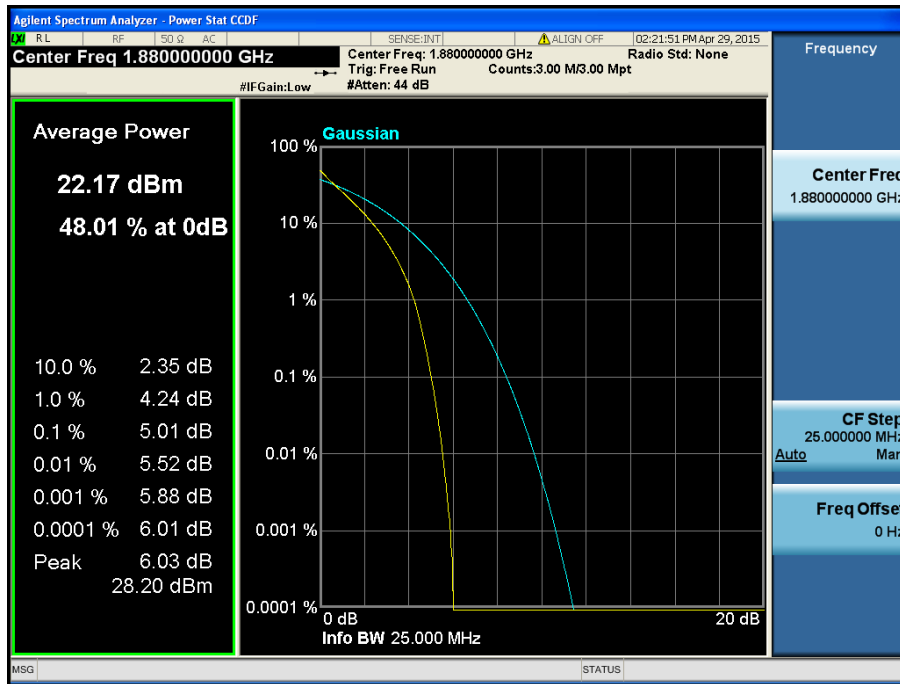

LTE Band 2 / 20 MHz / QPSK - RB Size 100

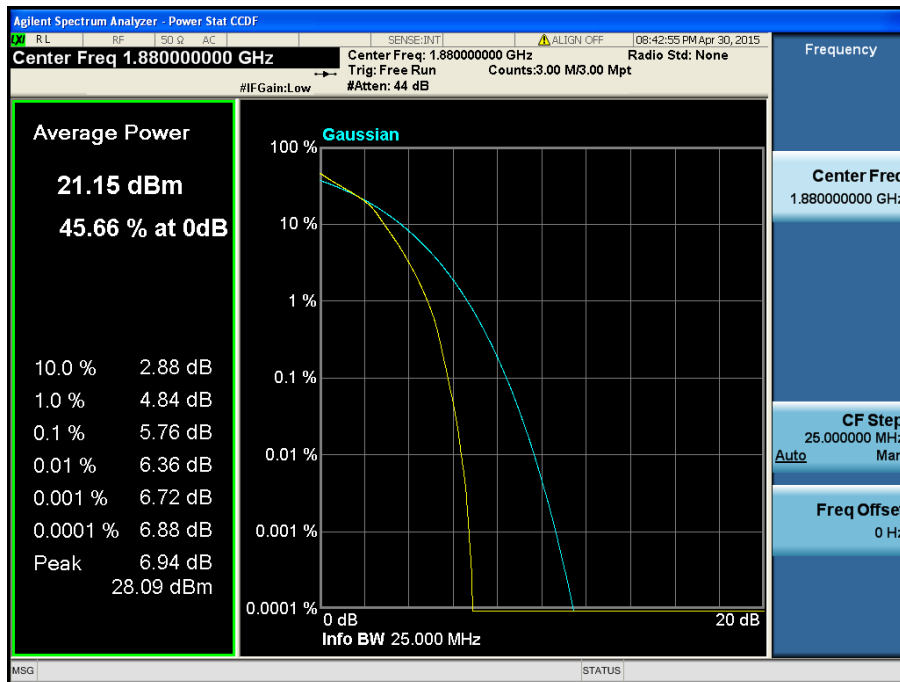

LTE Band 2 / 20 MHz / 16QAM - RB Size 100



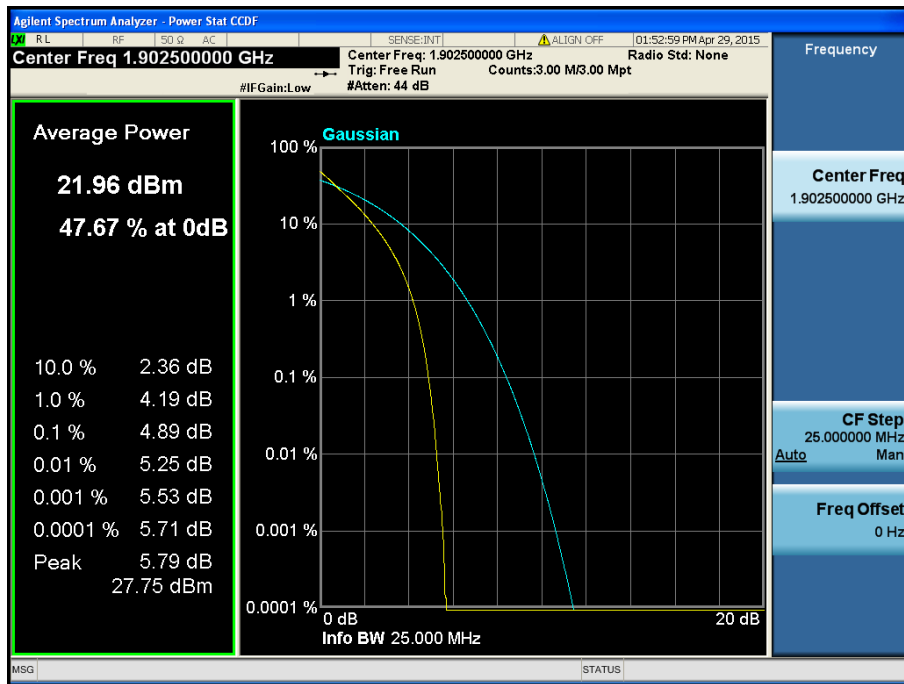

LTE Band 2 / 15 MHz / QPSK - RB Size 75

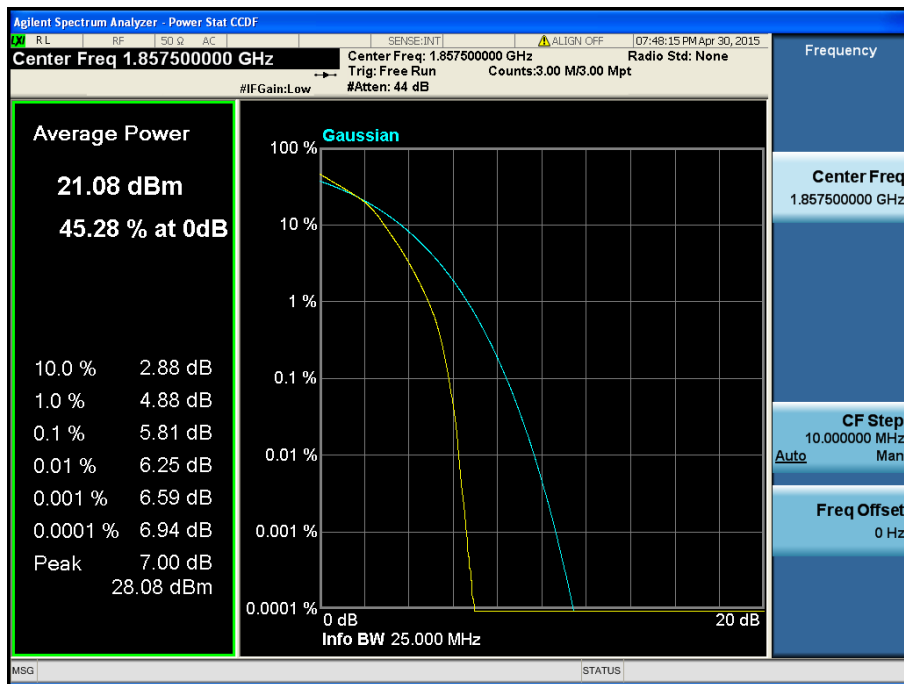

LTE Band 2 / 15 MHz / 16QAM - RB Size 75

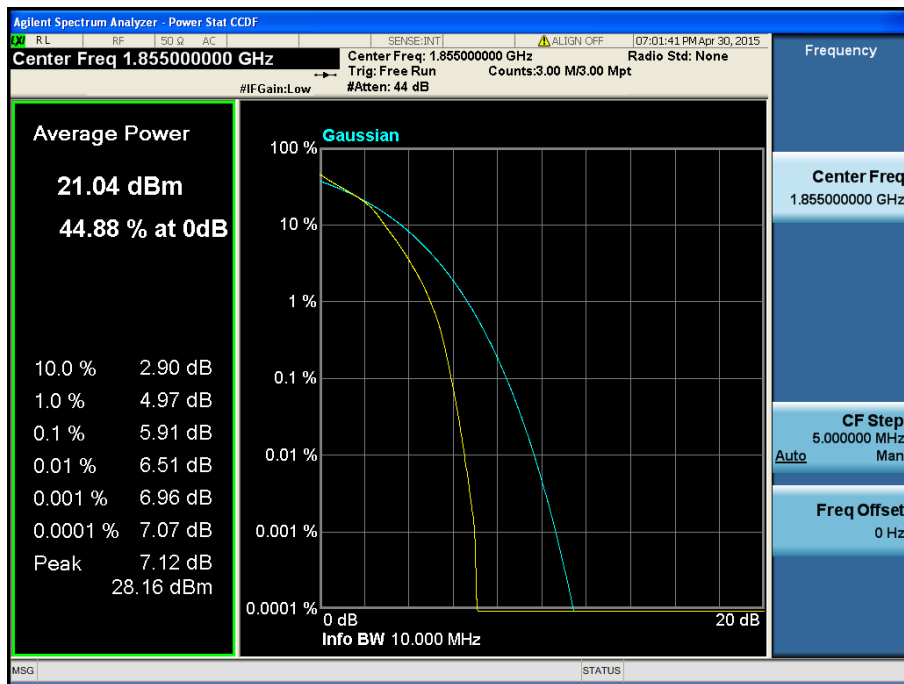
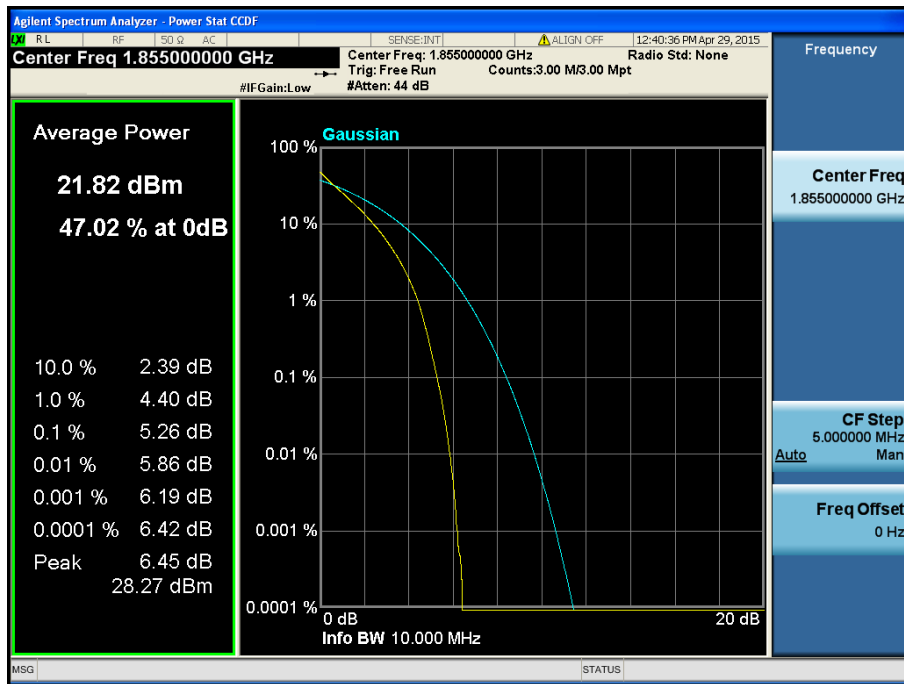

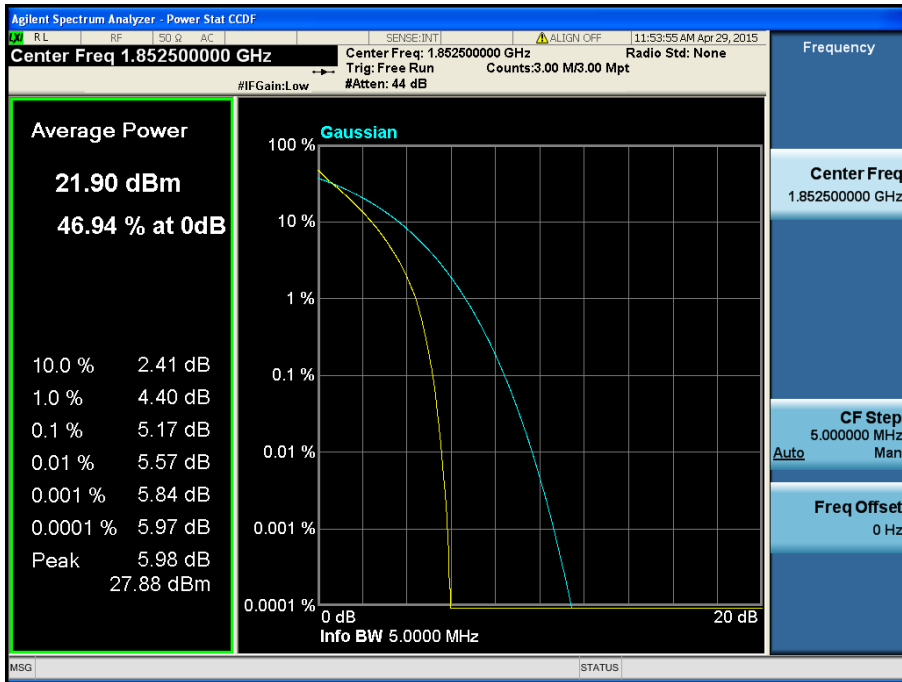

LTE Band 2 / 5 MHz / QPSK - RB Size 25

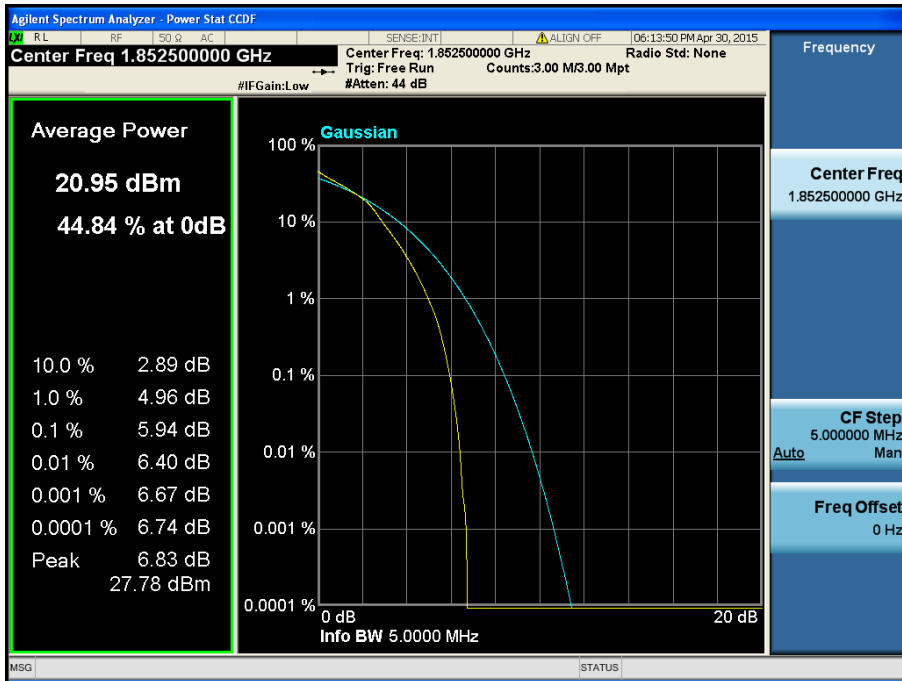

LTE Band 2 / 5 MHz / 16QAM - RB Size 25

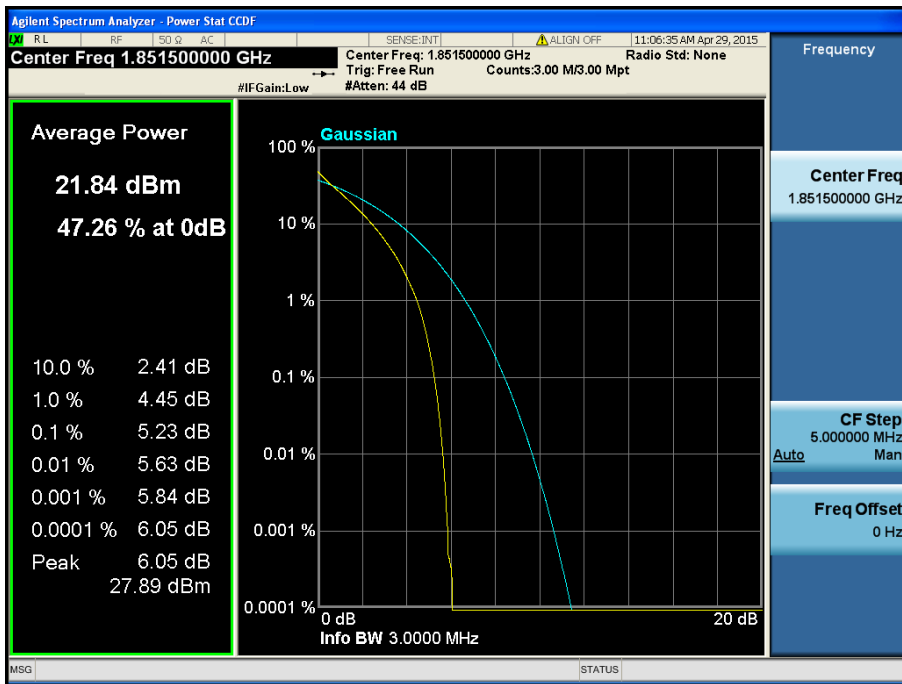

LTE Band 2 / 3 MHz / QPSK - RB Size 15

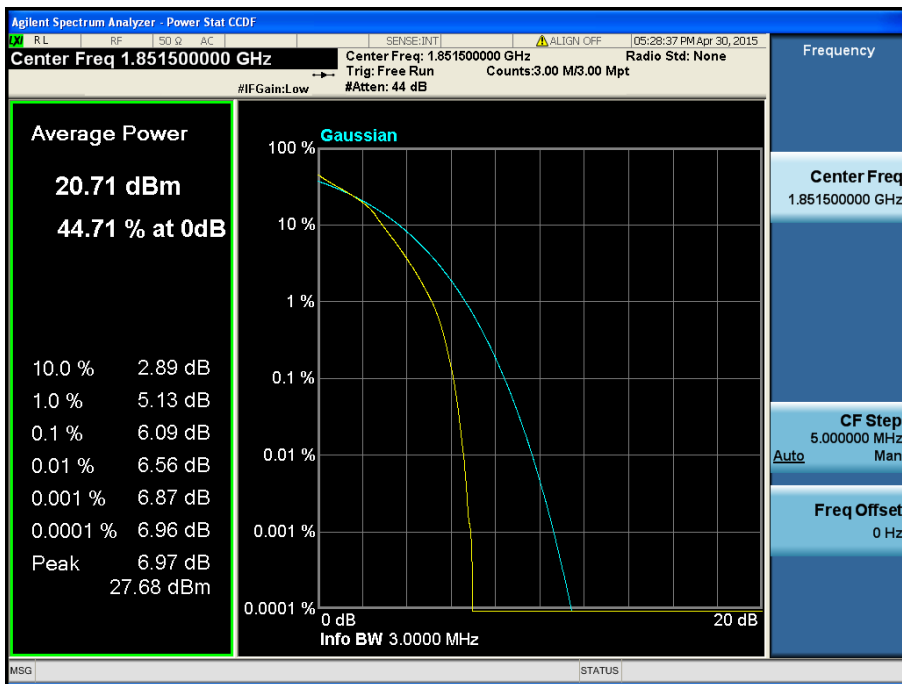

LTE Band 2 / 3 MHz / 16QAM - RB Size 15

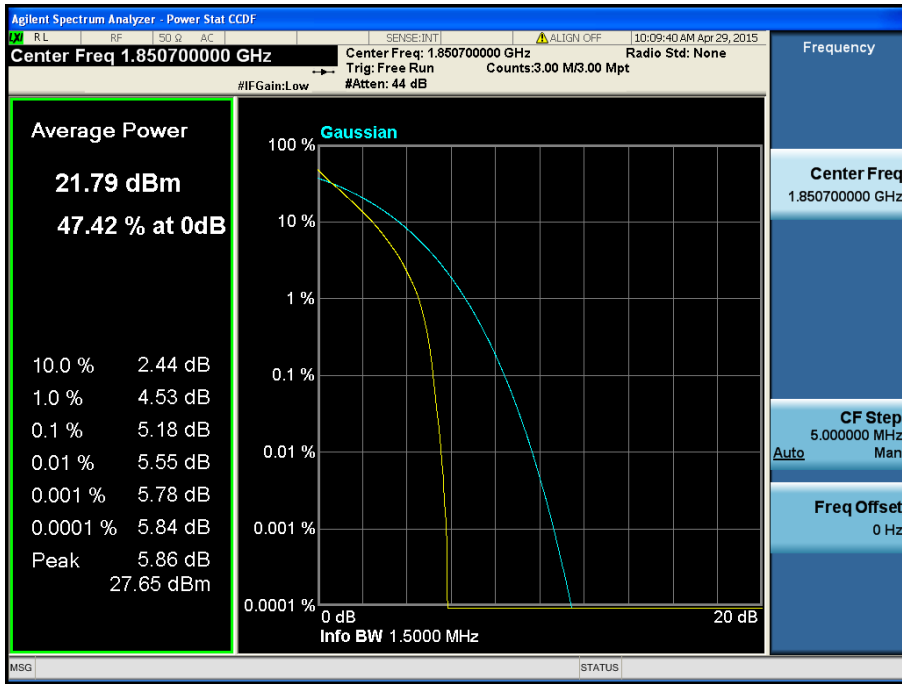

LTE Band 2 / 1.4 MHz / QPSK - RB Size 6

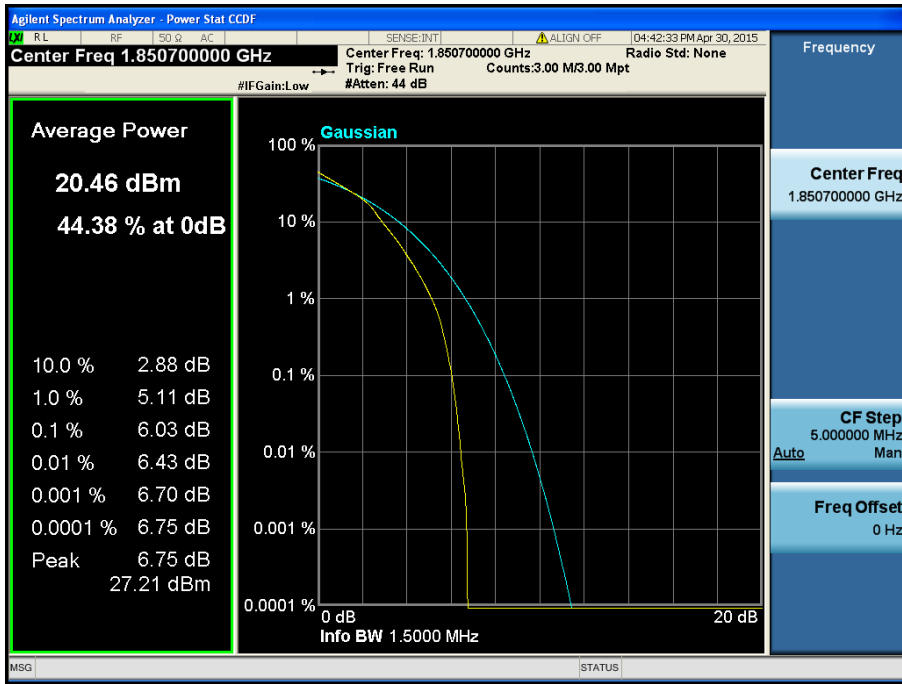

LTE Band 2 / 1.4 MHz / 16QAM - RB Size 6

### 8.3 BAND EDGE EMISSIONS(Conducted)

#### 8.3.1 LTE Band 4

- Lower Band Edge

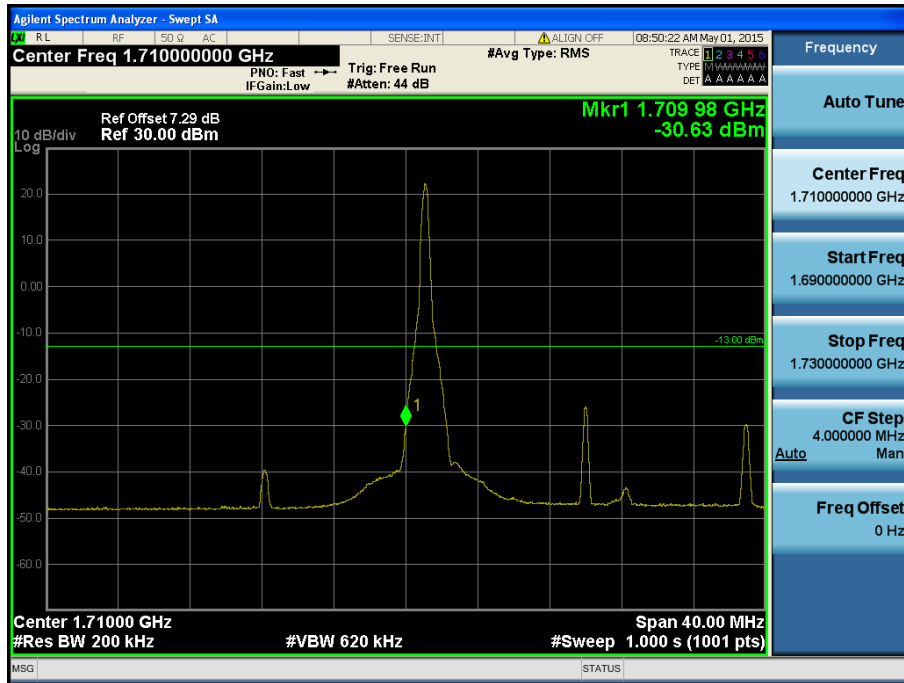

LTE Band 4 / 20MHz / QPSK - RB Size/Offset (1/0)

- Lower Extended Band Edge

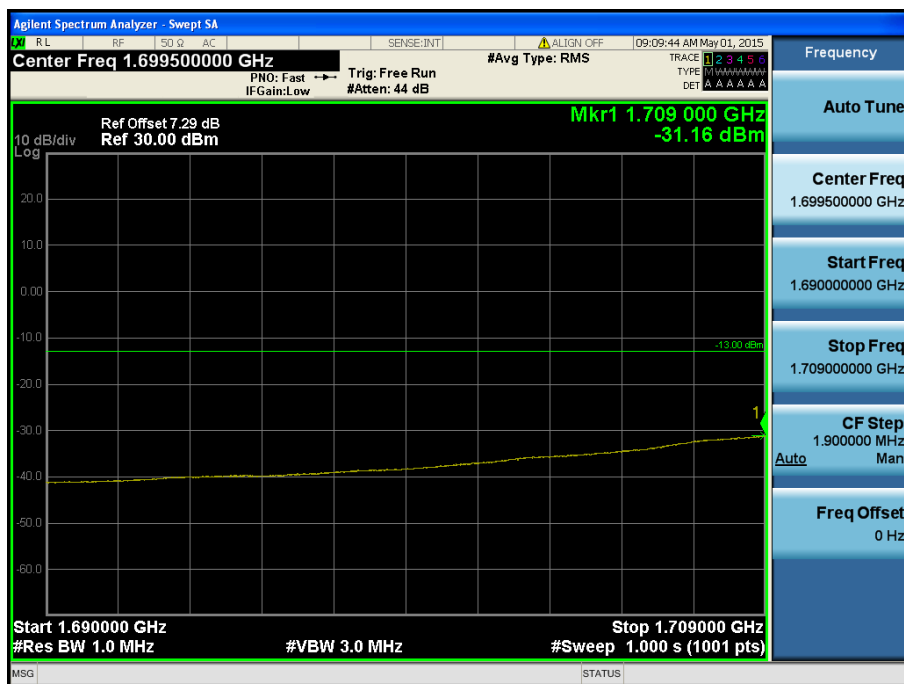

LTE Band 4 / 20MHz / QPSK - RB Size/Offset (100/0)

- Upper Band Edge

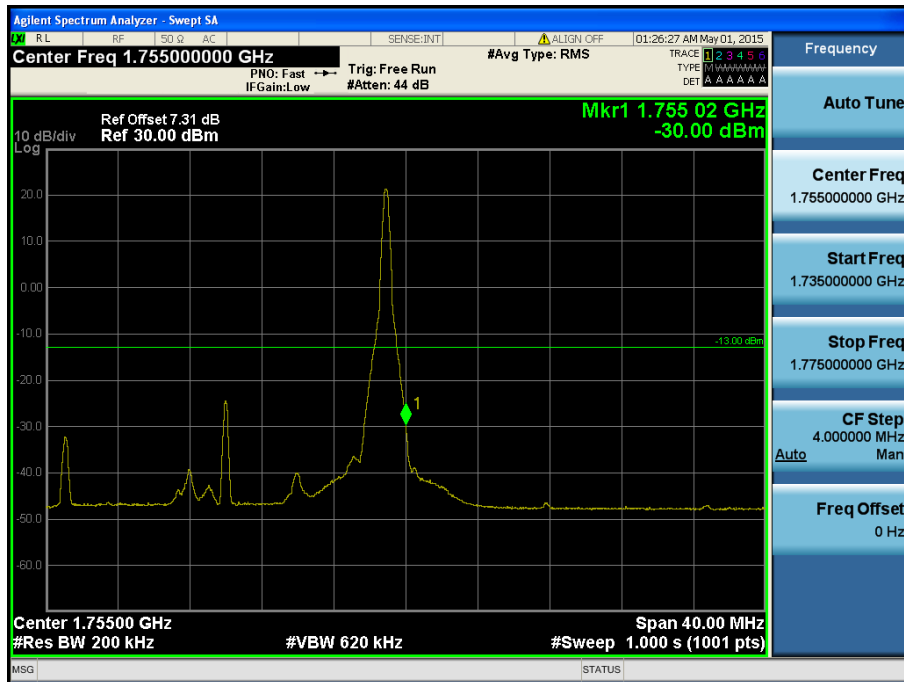

LTE Band 4 / 20MHz / 16QAM - RB Size/Offset (1/99)

- Upper Extended Band Edge

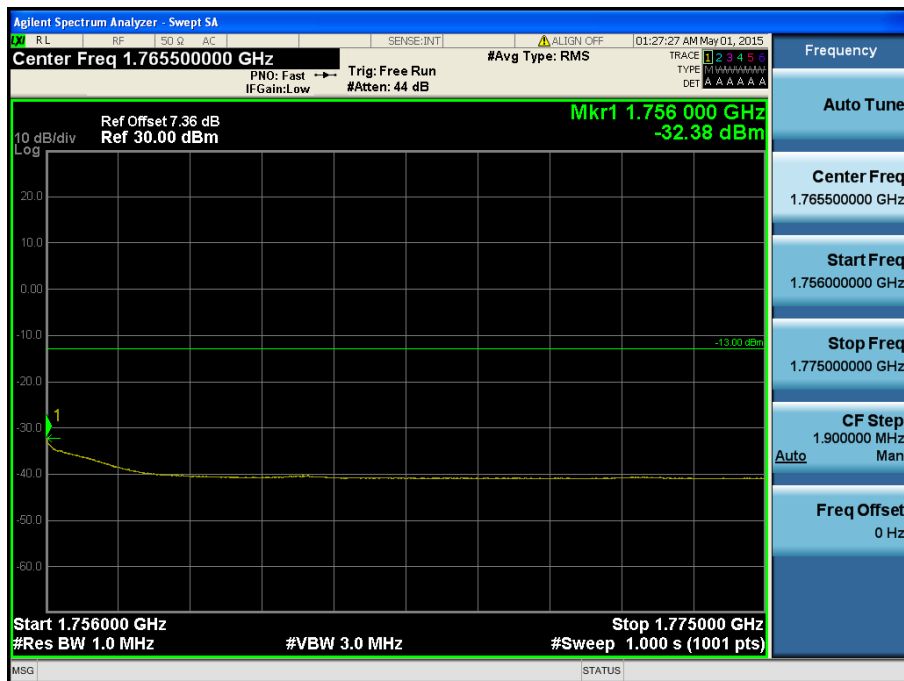

LTE Band 4 / 20MHz / 16QAM - RB Size/Offset (1/99)

- Lower Band Edge

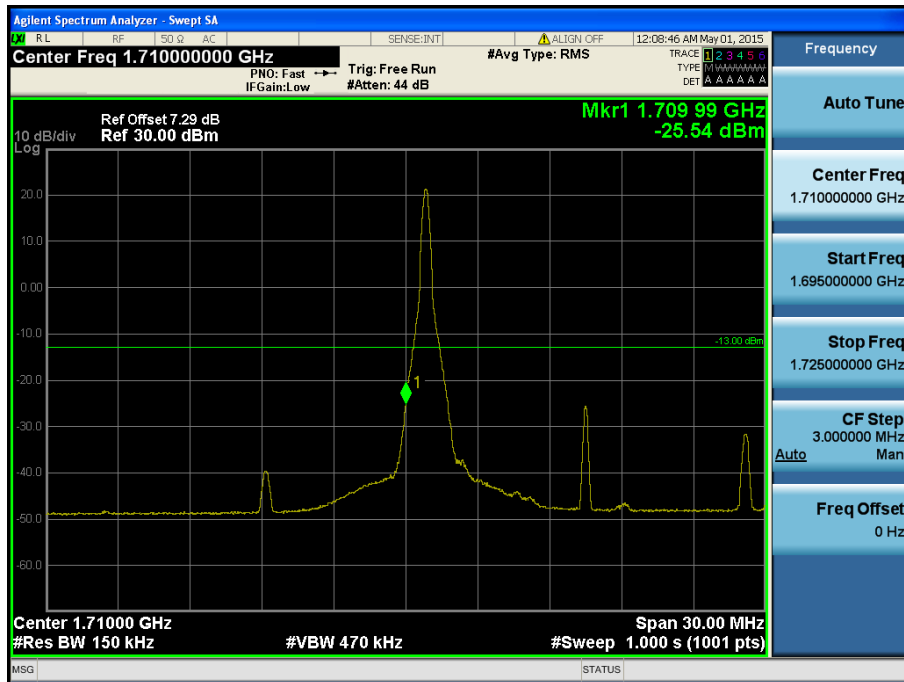

LTE Band 4 / 15MHz / 16QAM - RB Size/Offset (1/0)

- Lower Extended Band Edge

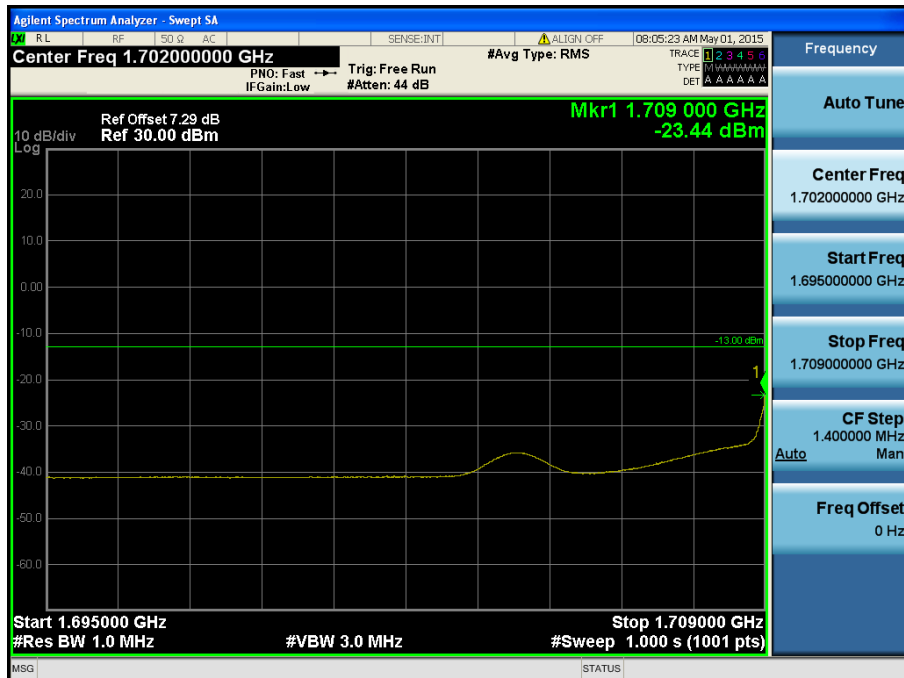

LTE Band 4 / 15MHz / QPSK - RB Size/Offset (1/0)



- Upper Band Edge

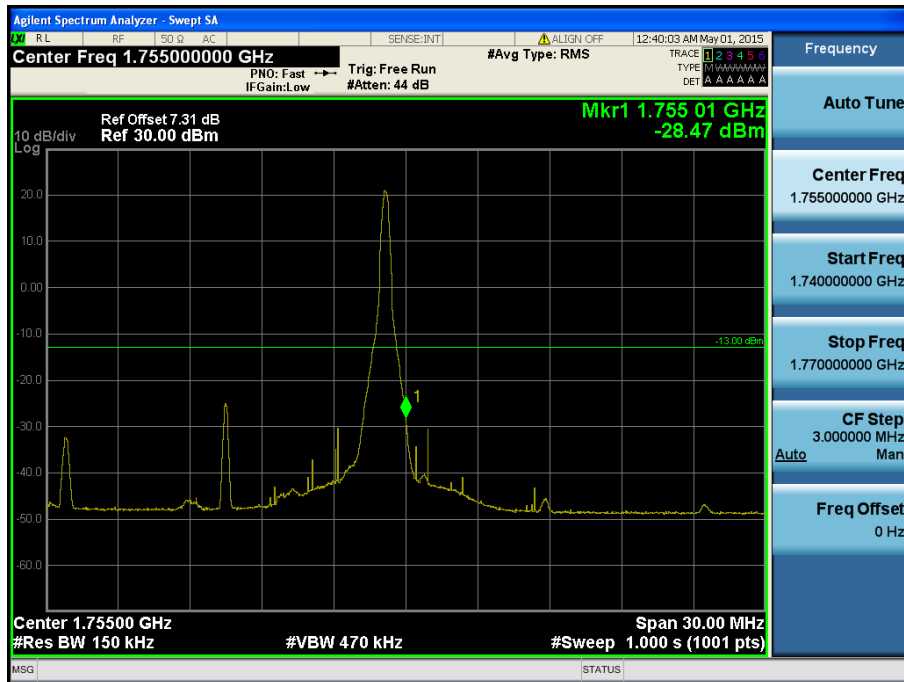

LTE Band 4 / 15MHz / 16QAM - RB Size/Offset (1/74)

- Upper Extended Band Edge

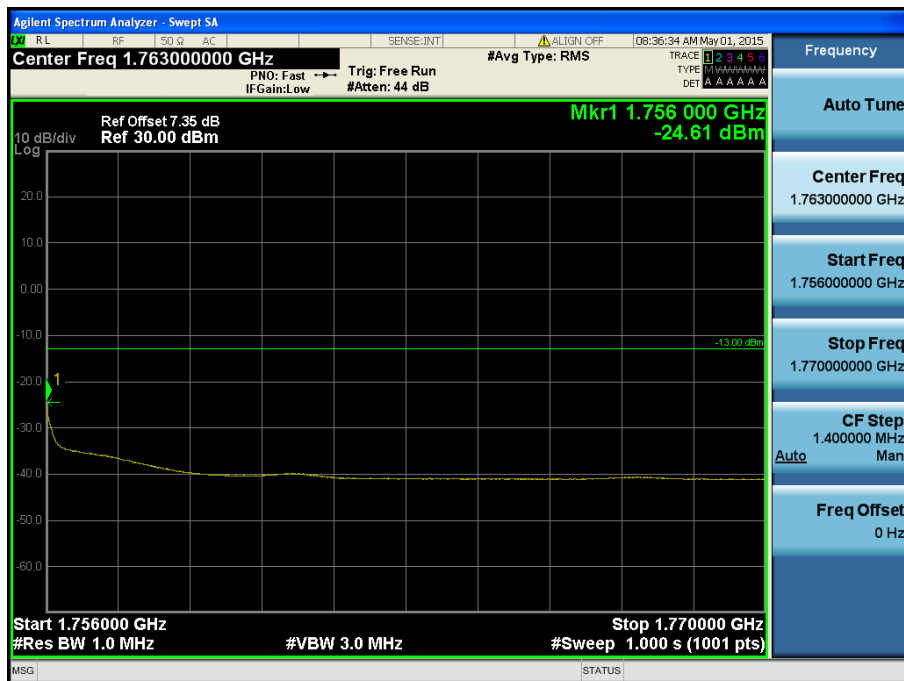

LTE Band 4 / 15MHz / QPSK - RB Size/Offset (1/74)

- Lower Band Edge

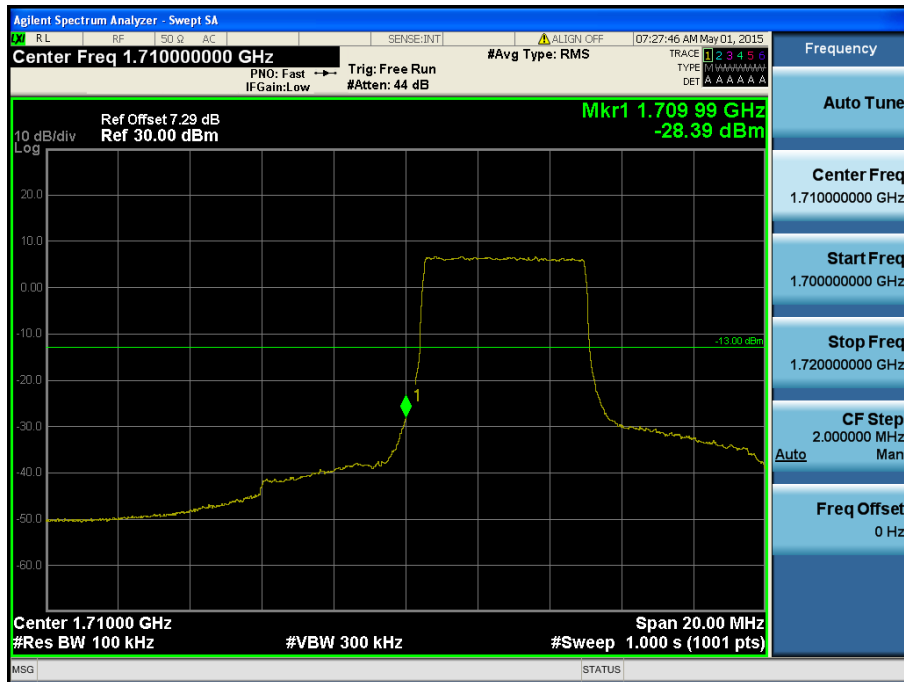

LTE Band 4 / 10MHz / QPSK - RB Size/Offset (25/0)

- Lower Extended Band Edge

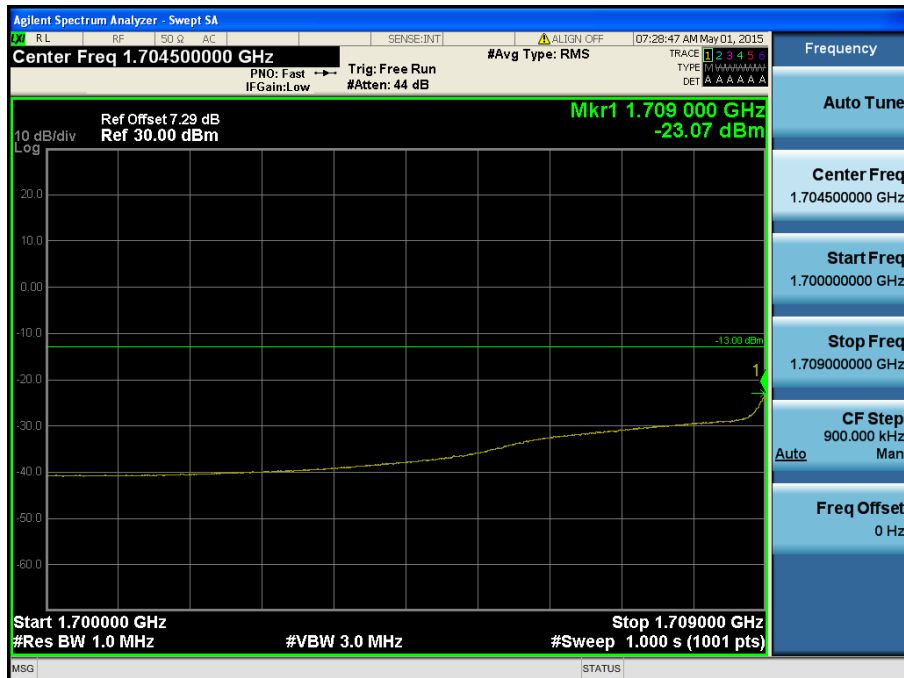

LTE Band 4 / 10MHz / QPSK - RB Size/Offset (25/0)

- Upper Band Edge

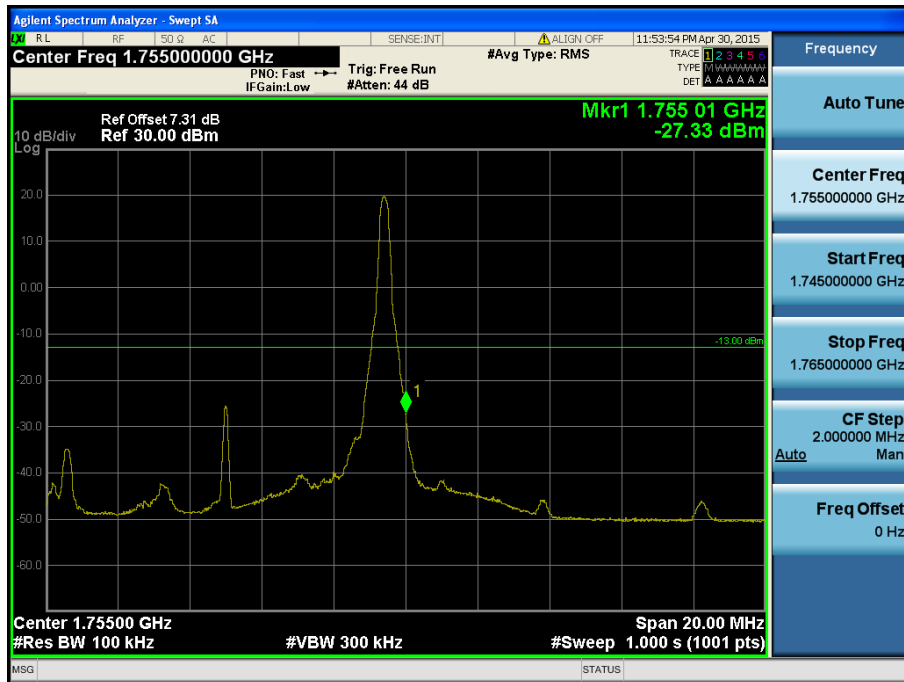

LTE Band 4 / 10MHz / 16QAM - RB Size/Offset (1/49)

- Upper Extended Band Edge



LTE Band 4 / 10MHz / QPSK - RB Size/Offset (25/25)

- Lower Band Edge

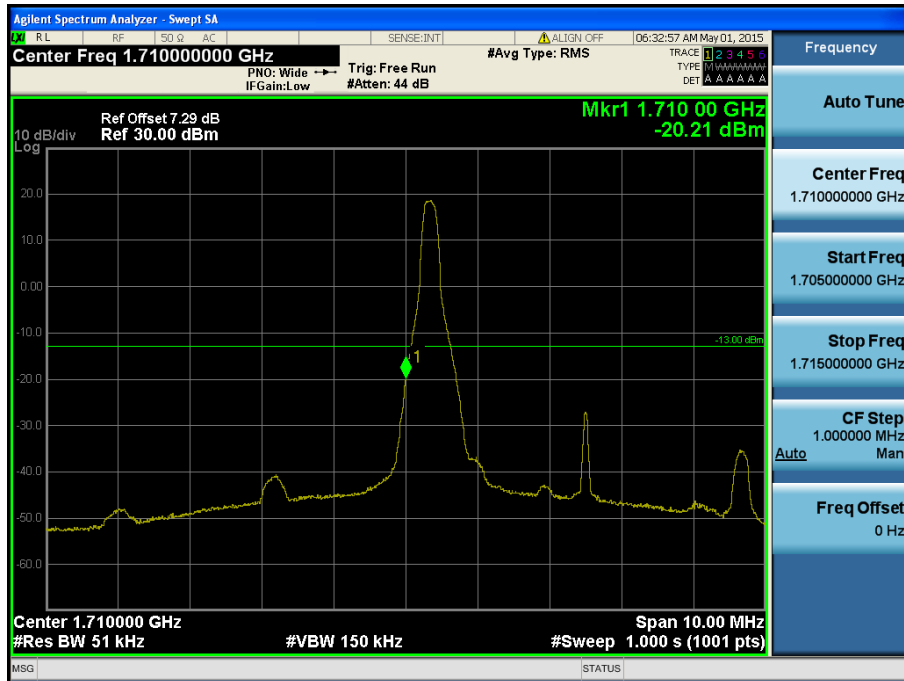

LTE Band 4 / 5MHz / QPSK Offset/Size (1/0)

- Lower Extended Band Edge

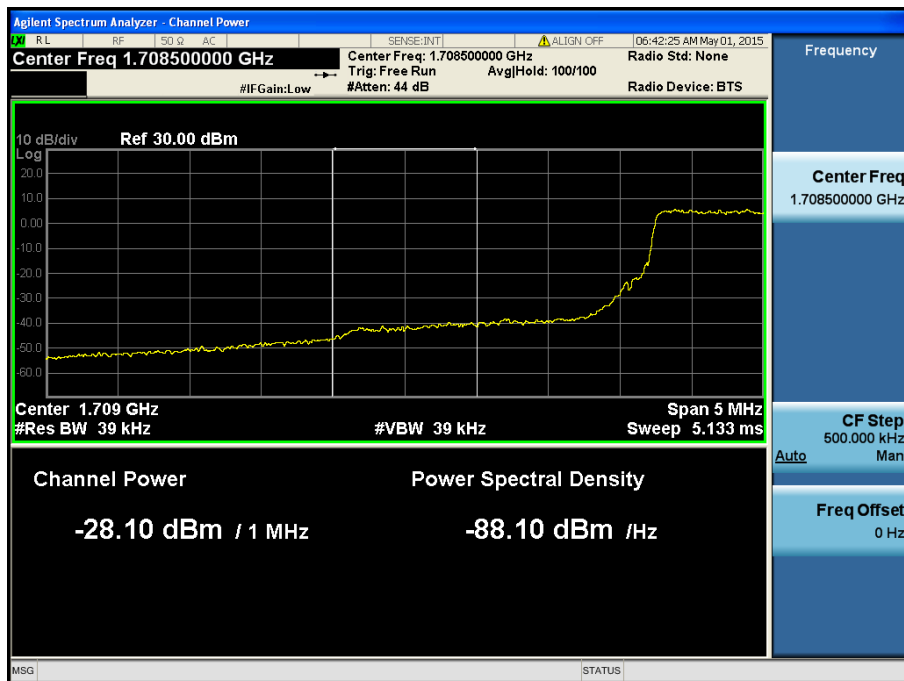

LTE Band 4 / 5MHz / QPSK Offset/Size (12/0)

- Upper Band Edge

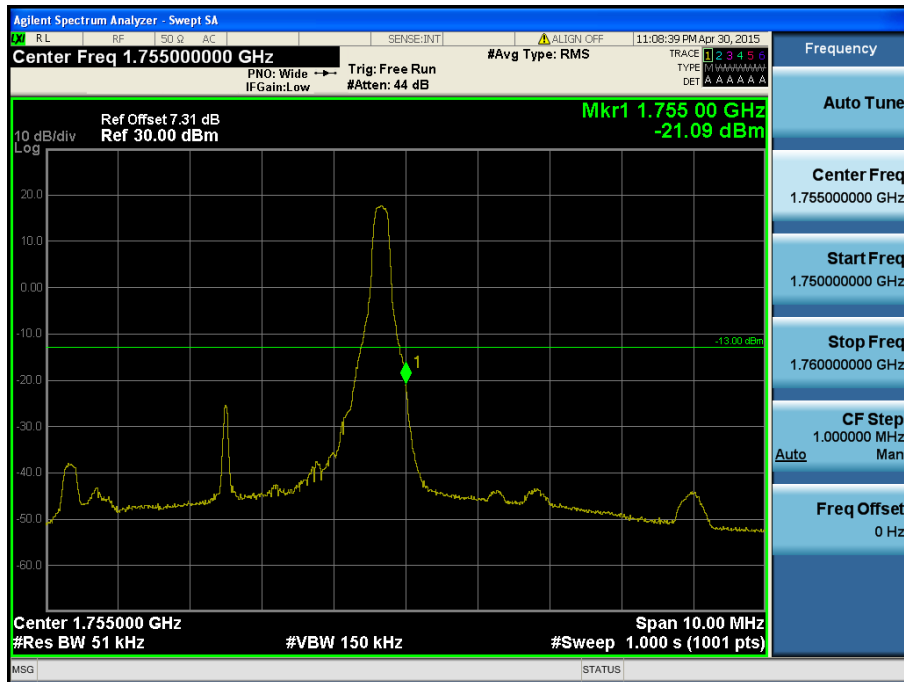

LTE Band 4 / 5MHz / 16QAM - RB Size/Offset (1/24)

- Upper Extended Band Edge

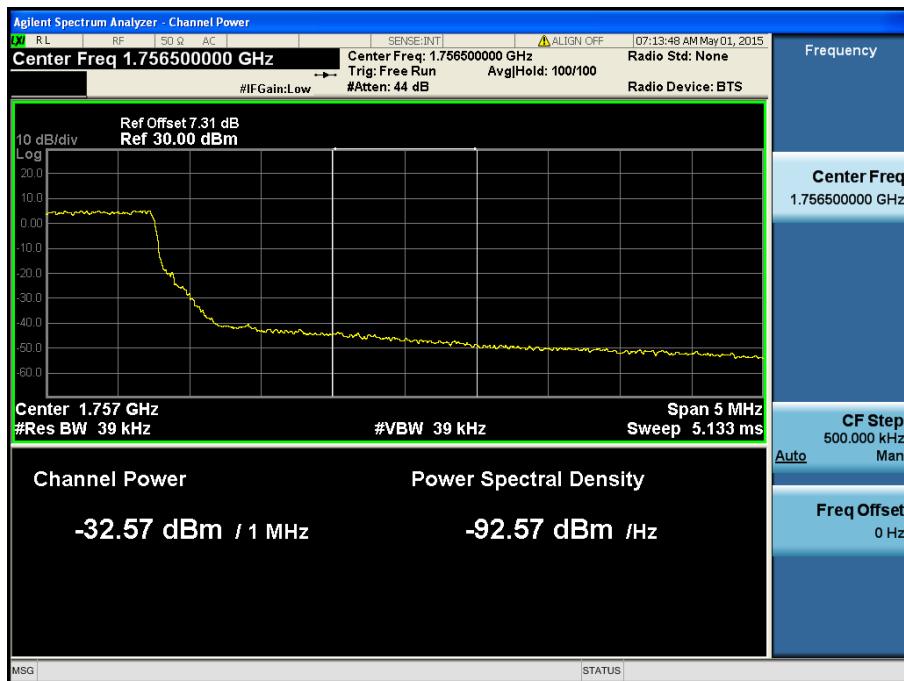

LTE Band 4 / 5MHz / QPSK - RB Size/Offset (12/13)

- Lower Band Edge

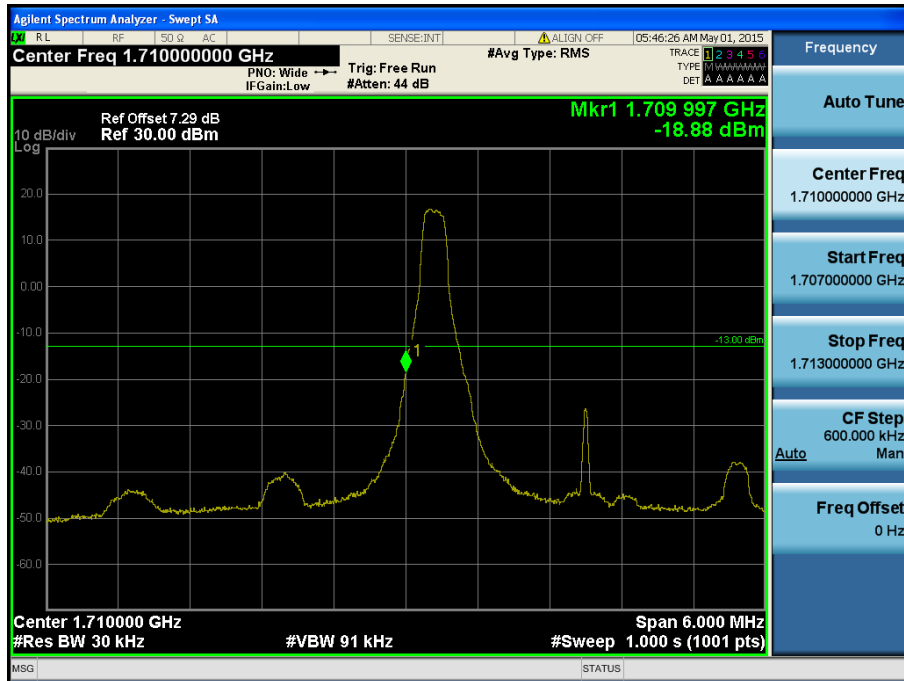

LTE Band 4 / 3MHz / QPSK - RB Size/Offset (1/0)

- Lower Extended Band Edge

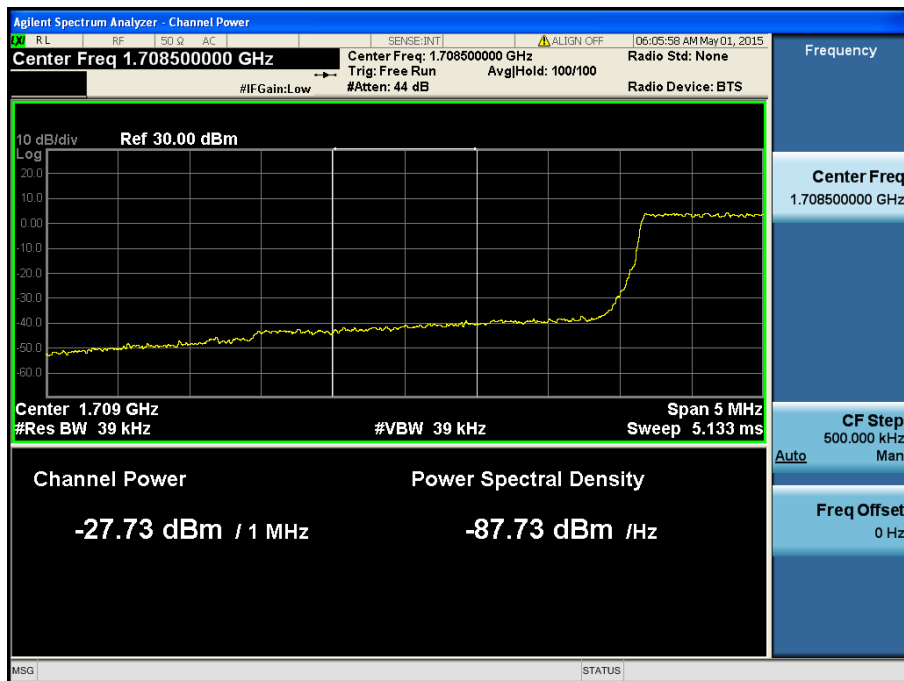

LTE Band 4 / 3MHz / QPSK - RB Size/Offset (15/0)

- Upper Band Edge

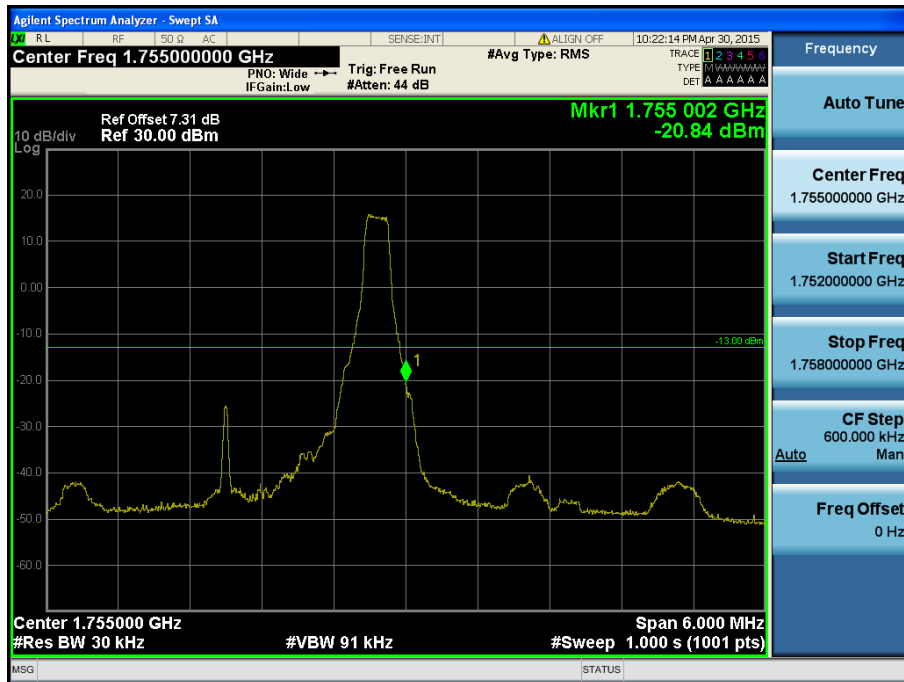

LTE Band 4 / 3MHz / 16QAM - RB Size/Offset (1/14)

- Upper Extended Band Edge



LTE Band 4 / 3MHz / QPSK - RB Size/Offset (8/4)

- Lower Band Edge



LTE Band 4 / 1.4MHz / 16QAM - RB Size/Offset (1/0)

- Lower Extended Band Edge



LTE Band 4 / 1.4MHz / QPSK - RB Size/Offset (3/2)



- Upper Band Edge

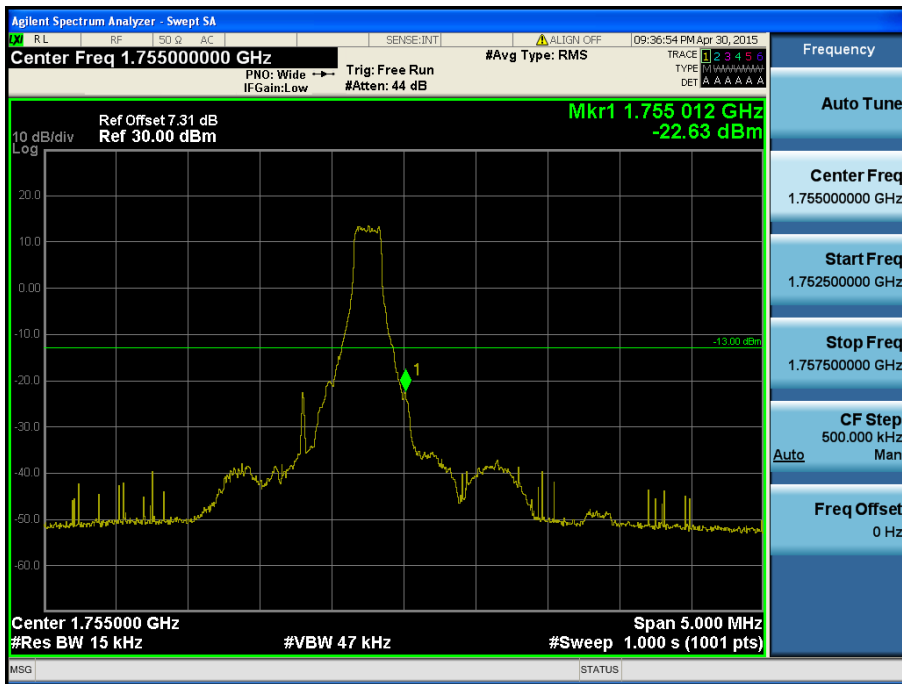

LTE Band 4 / 1.4MHz / 16QAM - RB Size/Offset (1/5)

- Upper Extended Band Edge



LTE Band 4 / 1.4MHz / QPSK - RB Size/Offset (3/0)