

# TEST REPORT



**DT&C Co., Ltd.**

42, Yurim-ro, 154Beon-gil, Cheoin-gu, Yongin-si, Gyeonggi-do, Korea, 17042  
Tel : 031-321-2664, Fax : 031-321-1664

1. Report No : DRTFCC2005-0144
2. Customer
  - Name : LG Electronics USA, Inc.
  - Address : 111 Sylvan Avenue, North Building Englewood Cliffs, NJ 07632
3. Use of Report : FCC Original Grant
4. Product Name / Model Name : Mobile Phone / LM-G910HMW  
FCC ID : ZNFG910HMW
5. Test Method Used : KDB971168 D01v03, ANSI/TIA-603-E-2016, ANSI C63.26-2015  
Test Specification : §2, §22, §24(E), §27
6. Date of Test : 2020.04.09 ~ 2020.05.18
7. Location of Test :  Permanent Testing Lab       On Site Testing
8. Testing Environment : Refer to appended test report.
9. Test Result : Refer to the attached test result.

The results shown in this test report refer only to the sample(s) tested unless otherwise stated.

Affirmation	Tested by		Reviewed by	
	Name : Inhee Bae	(Signature)	Name : Guenki Son	(Signature)

2020 . 05 . 29 .

**DT&C Co., Ltd.**

Not abided by KS Q ISO / IEC 17025 and KOLAS accreditation.

If this report is required to confirmation of authenticity, please contact to [report@dtnc.net](mailto:report@dtnc.net)

## Test Report Version

Test Report No.	Date	Description	Revised by	Reviewed by
DRTFCC2005-0144	May. 29, 2020	Initial issue	JaeHyeok Bang	Inhee Bae

# Table of Contents

<b>1. GENERAL INFORMATION .....</b>	<b>6</b>
<b>2. INTRODUCTION .....</b>	<b>8</b>
2.1 EUT DESCRIPTION .....	8
2.2. EUT CAPABILITIES .....	8
2.3. TESTING ENVIRONMENT .....	8
2.4 MEASURING INSTRUMENT CALIBRATION.....	8
2.5. MEASUREMENT UNCERTAINTY.....	8
2.6. TEST FACILITY.....	8
<b>3. DESCRIPTION OF TESTS.....</b>	<b>9</b>
3.1 ERP & EIRP (Effective Radiated Power & Equivalent Isotropic Radiated Power) .....	9
3.2 PEAK TO AVERAGE RATIO .....	11
3.3 OCCUPIED BANDWIDTH.....	12
3.4 BAND EDGE EMISSIONS AT ANTENNA TERMINAL .....	13
3.5 SPURIOUS AND HARMONIC EMISSIONS AT ANTENNA TERMINAL .....	14
3.6 UNDESIRABLE EMISSIONS .....	15
3.7 FREQUENCY STABILITY .....	16
<b>4. LIST OF TEST EQUIPMENT .....</b>	<b>17</b>
<b>5. SUMMARY OF TEST RESULTS .....</b>	<b>18</b>
<b>6. SAMPLE CALCULATION .....</b>	<b>19</b>
<b>7. TEST DATA.....</b>	<b>23</b>
7.1 OCCUPIED BANDWIDTH.....	23
7.2 PEAK TO AVERAGE RATIO.....	23
7.3 BAND EDEG EMISSIONS (Conducted).....	23
7.4 SPURIOUS AND HARMONICS EMISSIONS (Conducted) .....	23
7.5 ERP & EIRP .....	24
7.5.1 LTE Band 12, 17.....	24
7.5.2 LTE Band 12.....	25
7.5.3 LTE Band 13.....	26
7.5.4 LTE Band 26.....	27
7.5.5 LTE Band 5, 26.....	28
7.5.6 LTE Band 66, 4.....	30
7.5.7 LTE Band 25, 2.....	33
7.5.8 LTE Band 41.....	36
7.5.9LTE Band 7.....	38
7.6 UNDESIRABLE EMISSIONS (Radiated).....	40
7.6.1 LTE Band 12, 17.....	40
7.6.2 LTE Band 13.....	41
7.6.3 LTE Band 5, 26.....	42
7.6.4 LTE Band 66, 4.....	43

7.6.5 LTE Band 25, 2.....	46
7.6.6 LTE Band 41.....	48
7.6.7 LTE Band 7.....	49
7.7 FREQUENCY STABILITY .....	50
7.7.1 LTE Band 12, 17.....	50
7.7.2 LTE Band 13.....	51
7.7.3 LTE Band 5, 26.....	52
7.7.4 LTE Band 66, 4.....	53
7.7.5 LTE Band 25, 2.....	54
7.7.6 LTE Band 41.....	55
7.7.7 LTE Band 7.....	56
<b>8. TEST PLOTS .....</b>	<b>57</b>
8.1 OCCUPIED BANDWIDTH.....	57
8.1.1 LTE Band 12, 17.....	57
8.1.2 LTE Band 12.....	61
8.1.3 LTE Band 13.....	65
8.1.4 LTE Band 26.....	69
8.1.5 LTE Band 5, 26.....	71
8.1.6 LTE Band 66, 4.....	79
8.1.7 LTE Band 25, 2.....	91
8.1.8 LTE Band 41.....	103
8.1.9 LTE Band 7.....	111
8.2 PEAK TO AVERAGE RATIO .....	119
8.2.1 LTE Band 12, 17.....	119
8.2.2 LTE Band 12.....	123
8.2.3 LTE Band 13.....	127
8.2.4 LTE Band 26.....	131
8.2.5 LTE Band 5, 26.....	133
8.2.6 LTE Band 66, 4.....	141
8.2.7 LTE Band 25, 2.....	153
8.2.8 LTE Band 41.....	165
8.2.9 LTE Band 7.....	173
8.3 BAND EDGE EMISSIONS(Conducted).....	181
8.3.1 LTE Band 12, 17.....	181
8.3.2 LTE Band 12.....	185
8.3.3 LTE Band 13.....	189
8.3.4 LTE Band 26.....	197
8.3.5 LTE Band 5, 26.....	199
8.3.6 LTE Band 66, 4.....	207
8.3.7 LTE Band 25, 2.....	219
8.3.8 LTE Band 41.....	231
8.3.9 LTE Band 7.....	239
8.4 SPURIOUS AND HARMONICS EMISSIONS(Conducted) .....	245
8.4.1 LTE Band 12, 17.....	245
8.4.2 LTE Band 12.....	248

<b>8.4.3 LTE Band 13.....</b>	<b>252</b>
<b>8.4.4 LTE Band 26.....</b>	<b>254</b>
<b>8.4.5 LTE Band 5, 26.....</b>	<b>255</b>
<b>8.4.6 LTE Band 66, 4.....</b>	<b>261</b>
<b>8.4.7 LTE Band 25, 2.....</b>	<b>279</b>
<b>8.4.8 LTE Band 41.....</b>	<b>297</b>
<b>8.4.9 LTE Band 7.....</b>	<b>309</b>

## 1. GENERAL INFORMATION

**Applicant Name** : LG Electronics USA, Inc.  
**Address** : 111 Sylvan Avenue, North Building Englewood Cliffs, NJ 07632  
**FCC ID** : ZNFG910HMW  
**FCC Classification** : PCS Licensed Transmitter held to ear (PCE)  
**EUT Type** : Mobile Phone  
**Model Name** : LM-G910HMW  
**Add Model Name** : LMG910HMW, G910HMW, LM-G910HM, LMG910HM, G910HM  
**Supplying power** : DC 3.87 V  
**Antenna Information** : PIFA Antenna

Mode	TX Frequency (MHz)	Emission Designator	Modulation	ERP	
				Max power (dBm)	Max power (W)
LTE Band 12, 17	704 ~ 711	8M93G7D	QPSK	20.94	0.124
LTE Band 12, 17	704 ~ 711	8M95W7D	16QAM	19.75	0.094
LTE Band 12, 17	704 ~ 711	8M97W7D	64QAM	18.50	0.071
LTE Band 12, 17	701.5 ~ 713.5	4M48G7D	QPSK	21.16	0.131
LTE Band 12, 17	701.5 ~ 713.5	4M50W7D	16QAM	19.70	0.093
LTE Band 12, 17	701.5 ~ 713.5	4M50W7D	64QAM	18.66	0.073
LTE Band 12	700.5 ~ 714.5	2M70G7D	QPSK	20.70	0.117
LTE Band 12	700.5 ~ 714.5	2M69W7D	16QAM	19.23	0.084
LTE Band 12	700.5 ~ 714.5	2M69W7D	64QAM	18.15	0.065
LTE Band 12	699.7 ~ 715.3	1M09G7D	QPSK	20.23	0.105
LTE Band 12	699.7 ~ 715.3	1M09W7D	16QAM	18.93	0.078
LTE Band 12	699.7 ~ 715.3	1M09W7D	64QAM	18.01	0.063
LTE Band 13	782 ~ 782	8M90G7D	QPSK	19.67	0.093
LTE Band 13	782 ~ 782	8M90W7D	16QAM	18.17	0.066
LTE Band 13	782 ~ 782	8M94W7D	64QAM	17.09	0.051
LTE Band 13	779.5 ~ 784.5	4M49G7D	QPSK	19.59	0.091
LTE Band 13	779.5 ~ 784.5	4M47W7D	16QAM	18.21	0.066
LTE Band 13	779.5 ~ 784.5	4M48W7D	64QAM	17.02	0.050
LTE Band 26	831.5 ~ 841.5	13M4G7D	QPSK	20.63	0.116
LTE Band 26	831.5 ~ 841.5	13M4W7D	16QAM	19.52	0.090
LTE Band 26	831.5 ~ 841.5	13M4W7D	64QAM	18.36	0.069
LTE Band 5, 26	829 ~ 844	8M94G7D	QPSK	20.92	0.124
LTE Band 5, 26	829 ~ 844	8M94W7D	16QAM	19.80	0.095
LTE Band 5, 26	829 ~ 844	8M97W7D	64QAM	18.88	0.077
LTE Band 5, 26	826.5 ~ 846.5	4M49G7D	QPSK	20.70	0.117
LTE Band 5, 26	826.5 ~ 846.5	4M48W7D	16QAM	19.77	0.095
LTE Band 5, 26	826.5 ~ 846.5	4M50W7D	64QAM	18.93	0.078
LTE Band 5, 26	825.5 ~ 847.5	2M69G7D	QPSK	21.45	0.140
LTE Band 5, 26	825.5 ~ 847.5	2M69W7D	16QAM	20.13	0.103
LTE Band 5, 26	825.5 ~ 847.5	2M69W7D	64QAM	19.03	0.080
LTE Band 5, 26	824.7 ~ 848.3	1M08G7D	QPSK	20.37	0.109
LTE Band 5, 26	824.7 ~ 848.3	1M09W7D	16QAM	19.17	0.083
LTE Band 5, 26	824.7 ~ 848.3	1M09W7D	64QAM	18.05	0.064

Mode	TX Frequency (MHz)	Emission Designator	Modulation	EIRP	
				Max power(dBm)	Max power(W)
LTE Band 66, 4	1720 ~ 1770	17M9G7D	QPSK	21.66	0.147
LTE Band 66, 4	1720 ~ 1770	17M9W7D	16QAM	21.00	0.126
LTE Band 66, 4	1720 ~ 1770	17M9W7D	64QAM	19.95	0.099
LTE Band 66, 4	1717.5 ~ 1772.5	13M4G7D	QPSK	22.08	0.161
LTE Band 66, 4	1717.5 ~ 1772.5	13M5W7D	16QAM	21.25	0.133
LTE Band 66, 4	1717.5 ~ 1772.5	13M4W7D	64QAM	20.42	0.110
LTE Band 66, 4	1715 ~ 1775	8M96G7D	QPSK	21.57	0.144
LTE Band 66, 4	1715 ~ 1775	8M94W7D	16QAM	20.79	0.120
LTE Band 66, 4	1715 ~ 1775	8M97W7D	64QAM	20.04	0.101
LTE Band 66, 4	1712.5 ~ 1777.5	4M50G7D	QPSK	22.25	0.168
LTE Band 66, 4	1712.5 ~ 1777.5	4M50W7D	16QAM	21.61	0.145
LTE Band 66, 4	1712.5 ~ 1777.5	4M49W7D	64QAM	20.60	0.115
LTE Band 66, 4	1711.5 ~ 1778.5	2M69G7D	QPSK	21.96	0.157
LTE Band 66, 4	1711.5 ~ 1778.5	2M69W7D	16QAM	21.15	0.130
LTE Band 66, 4	1711.5 ~ 1778.5	2M69W7D	64QAM	20.17	0.104
LTE Band 66, 4	1710.7 ~ 1779.3	1M09G7D	QPSK	21.91	0.155
LTE Band 66, 4	1710.7 ~ 1779.3	1M09W7D	16QAM	21.22	0.132
LTE Band 66, 4	1710.7 ~ 1779.3	1M09W7D	64QAM	19.95	0.099
LTE Band 25, 2	1860 ~ 1905	17M9G7D	QPSK	21.97	0.157
LTE Band 25, 2	1860 ~ 1905	18M0W7D	16QAM	21.21	0.132
LTE Band 25, 2	1860 ~ 1905	17M9W7D	64QAM	20.33	0.108
LTE Band 25, 2	1857.5 ~ 1907.5	13M4G7D	QPSK	21.85	0.153
LTE Band 25, 2	1857.5 ~ 1907.5	13M4W7D	16QAM	21.28	0.134
LTE Band 25, 2	1857.5 ~ 1907.5	13M4W7D	64QAM	20.04	0.101
LTE Band 25, 2	1855 ~ 1910	8M96G7D	QPSK	21.68	0.147
LTE Band 25, 2	1855 ~ 1910	8M97W7D	16QAM	20.91	0.123
LTE Band 25, 2	1855 ~ 1910	8M95W7D	64QAM	19.71	0.094
LTE Band 25, 2	1852.5 ~ 1912.5	4M49G7D	QPSK	21.16	0.131
LTE Band 25, 2	1852.5 ~ 1912.5	4M49W7D	16QAM	20.24	0.106
LTE Band 25, 2	1852.5 ~ 1912.5	4M49W7D	64QAM	19.28	0.085
LTE Band 25, 2	1851.5 ~ 1913.5	2M69G7D	QPSK	21.21	0.132
LTE Band 25, 2	1851.5 ~ 1913.5	2M70W7D	16QAM	20.42	0.110
LTE Band 25, 2	1851.5 ~ 1913.5	2M70W7D	64QAM	19.37	0.086
LTE Band 25, 2	1850.7 ~ 1914.3	1M09G7D	QPSK	21.41	0.138
LTE Band 25, 2	1850.7 ~ 1914.3	1M09W7D	16QAM	20.57	0.114
LTE Band 25, 2	1850.7 ~ 1914.3	1M09W7D	64QAM	19.63	0.092
LTE Band 41	2506 ~ 2680	17M8G7D	QPSK	21.72	0.149
LTE Band 41	2506 ~ 2680	17M8W7D	16QAM	21.17	0.131
LTE Band 41	2506 ~ 2680	17M9W7D	64QAM	20.35	0.108
LTE Band 41	2503.5 ~ 2682.5	13M4G7D	QPSK	21.97	0.157
LTE Band 41	2503.5 ~ 2682.5	13M3W7D	16QAM	21.31	0.135
LTE Band 41	2503.5 ~ 2682.5	13M4W7D	64QAM	20.26	0.106
LTE Band 41	2501 ~ 2685	8M93G7D	QPSK	22.35	0.172
LTE Band 41	2501 ~ 2685	8M74W7D	16QAM	21.57	0.144
LTE Band 41	2501 ~ 2685	8M91W7D	64QAM	20.68	0.117
LTE Band 41	2498.5 ~ 2687.5	4M48G7D	QPSK	22.18	0.165
LTE Band 41	2498.5 ~ 2687.5	4M42W7D	16QAM	21.56	0.143
LTE Band 41	2498.5 ~ 2687.5	4M44W7D	64QAM	20.64	0.116
LTE Band 7	2510 ~ 2560	17M9G7D	QPSK	22.17	0.165
LTE Band 7	2510 ~ 2560	17M9W7D	16QAM	21.39	0.138
LTE Band 7	2510 ~ 2560	17M9W7D	64QAM	20.40	0.110
LTE Band 7	2507.5 ~ 2562.5	13M5G7D	QPSK	21.94	0.156
LTE Band 7	2507.5 ~ 2562.5	13M4W7D	16QAM	21.31	0.135
LTE Band 7	2507.5 ~ 2562.5	13M4W7D	64QAM	19.95	0.099
LTE Band 7	2505 ~ 2565	8M96G7D	QPSK	21.77	0.150
LTE Band 7	2505 ~ 2565	8M94W7D	16QAM	21.17	0.131
LTE Band 7	2505 ~ 2565	8M96W7D	64QAM	20.04	0.101
LTE Band 7	2502.5 ~ 2567.5	4M49G7D	QPSK	21.99	0.158
LTE Band 7	2502.5 ~ 2567.5	4M48W7D	16QAM	21.13	0.130
LTE Band 7	2502.5 ~ 2567.5	4M49W7D	64QAM	20.30	0.107

## 2. INTRODUCTION

### 2.1 EUT DESCRIPTION

The Equipment Under Test (EUT) supports GSM/WCDMA/LTE Phone with Bluetooth, WLAN, NFC, WPC.

### 2.2. EUT CAPABILITIES

This EUT contains the following capabilities:

850/1900 GSM/EDGE 850/1700/1900 WCDMA/HSUPA, Multi-band LTE, 802.11b/g/n/ac WLAN(2.4GHz)  
802.11a/n/ac WLAN(5GHz), Bluetooth(BDR, EDR, LE), NFC, WPC, Dual Display.

### 2.3. TESTING ENVIRONMENT

Ambient Condition	
▪ Temperature	+20 °C ~ +25 °C
▪ Relative Humidity	38 % ~ 45 %

### 2.4 MEASURING INSTRUMENT CALIBRATION

The measuring equipment, which was utilized in performing the tests documented herein, has been calibrated in accordance with the manufacturer's recommendations for utilizing calibration equipment, which is traceable to recognized national standards.

### 2.5. MEASUREMENT UNCERTAINTY

The measurement uncertainties shown below were calculated in accordance with requirements of ANSI C 63.4-2014. All measurement uncertainty values are shown with a coverage factor of  $k = 2$  to indicate a 95 % level of confidence.

Parameter	Measurement uncertainty
Radiated Disturbance (Below 1 GHz)	4.86 dB (The confidence level is about 95 %, $k = 2$ )
Radiated Disturbance (1 GHz ~ 18 GHz)	5.02 dB (The confidence level is about 95 %, $k = 2$ )
Radiated Disturbance (Above 18 GHz)	5.30 dB (The confidence level is about 95 %, $k = 2$ )

### 2.6. TEST FACILITY

<b>DT&amp;C Co., Ltd.</b>	
The 3 m test site and conducted measurement facility used to collect the radiated data are located at the 42, Yurim-ro, 154beon-gil, Cheoin-gu, Yongin-si, Gyeonggi-do, Korea 17042. The test site comply with the requirements of § 2.948 according to ANSI 63.4-2014.	
<b>- FCC MRA Accredited Test Firm No. : KR0034</b>	
<a href="http://www.dtnet.net">www.dtnet.net</a>	
Telephone	: + 82-31-321-2664
FAX	: + 82-31-321-1664



### 3. DESCRIPTION OF TESTS

#### 3.1 ERP & EIRP (Effective Radiated Power & Equivalent Isotropic Radiated Power)

##### Test Set-up

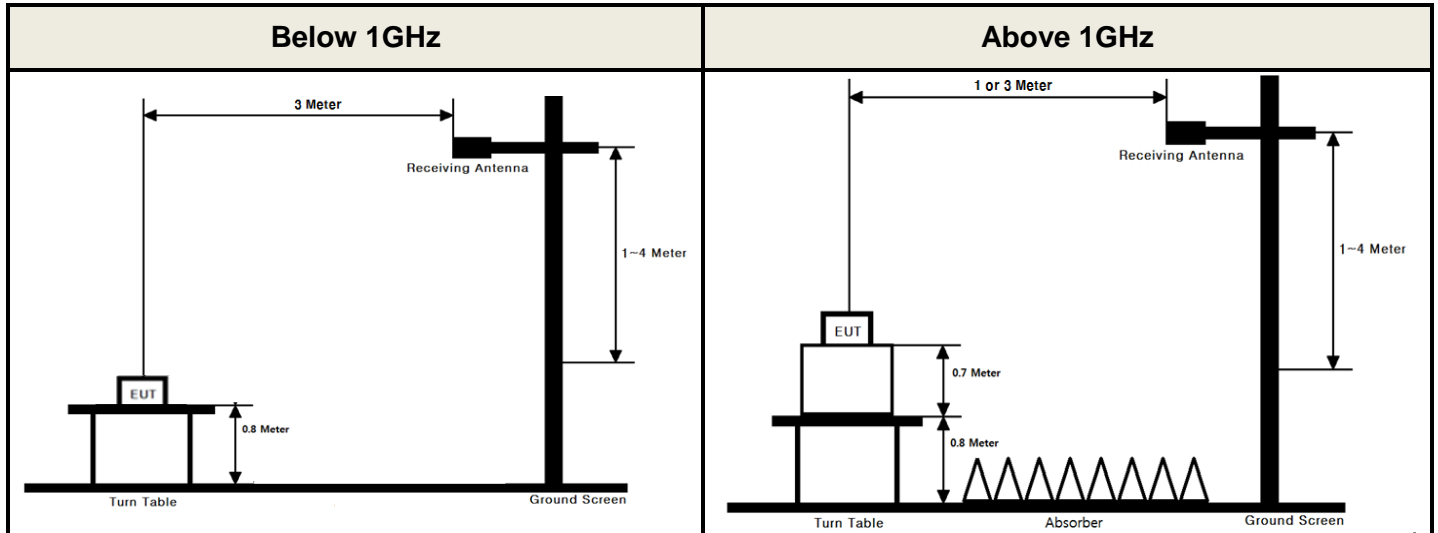

These measurements were performed at 3 m test site. The equipment under test is placed on a non-conductive table 1.5-meters above a turntable which is flush with the ground plane and 3 meters from the receive antenna. For measurements above 1GHz absorbers are placed on the floor between the turn table and the antenna mast in such a way so as to maximize the reduction of reflections. For measurements below 1 GHz, the absorbers are removed.

##### Test Procedure

- ANSI/TIA-603-E-2016 - Section 2.2.17
- KDB971168 D01v03 - Section 5.2.2
- ANSI C63.26-2015 – Section 5.2.4.4.1

##### Test setting

1. Set span to 2 x to 3 x the OBW.
2. Set RBW = 1% to 5% of the OBW.
3. Set VBW  $\geq$  3 x RBW.
4. Set number of points in sweep  $\geq$  2 x span / RBW.
5. Sweep time:
  - 1) Set = auto-couple, or
  - 2) Set  $\geq$  [10 x (number of points in sweep) x (transmission period)] for single sweep (automation-compatible) measurement. Transmission period is the on and off time of the transmitter.
6. Detector = power averaging (rms).
7. If the EUT can be configured to transmit continuously, then set the trigger to free run.
8. If the EUT cannot be configured to transmit continuously, then use a sweep trigger with the level set to enable triggering only on full power bursts and configure the EUT to transmit at full power for the entire duration of each sweep. Verify that the sweep time is less than or equal to the transmission burst duration. Time gating can also be used under similar constraints (i.e., configured such that measurement data is collected only during active full-power transmissions).
9. Trace average at least 100 traces in power averaging (rms) mode if sweep is set to auto-couple. To accurately determine the average power over multiple symbols, it can be necessary to increase the number of traces to be averaged above 100 or, if using a manually configured sweep time, increase the sweep time.

10. Compute the power by integrating the spectrum across the OBW of the signal using the instrument's band or channel power measurement function, with the band/channel limits set equal to the OBW band edges. If the instrument does not have a band or channel power function, then sum the spectrum levels (in linear power units) at intervals equal to the RBW extending across the entire OBW of the spectrum.

The receiver antenna height and turntable rotations were adjusted for the highest reading on the receive spectrum analyzer.

A half-wave dipole was substituted in place of the EUT. This dipole antenna was driven by a signal generator and the level of the signal generator was adjusted to obtain the same receive spectrum analyzer reading. The conducted power at the terminal of the substitute antenna is measured.

The ERP/EIRP is calculated using the following formula:

**ERP/EIRP = The conducted power at the substitute antenna's terminal [dBm] + Substitute Antenna gain [dBd for ERP , dBi for EIRP]**

For readings above 1 GHz, the above procedure is repeated using horn antennas and the difference between the gain of the horn antenna and an isotropic antenna are taken into consideration.

## 3.2 PEAK TO AVERAGE RATIO

### Test set-up

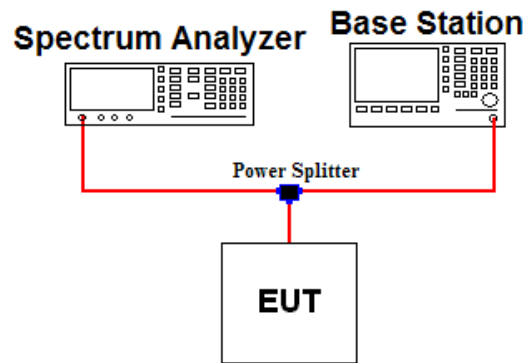

### Test Procedure

- KDB971168 D01v03 - Section 5.7.2
- ANSI C63.26-2015 – Section 5.2.3.4

A peak to average ratio measurement is performed at the conducted port of the EUT.

The spectrum analyzers Complementary Cumulative Distribution Function (CCDF) measurement profile is used to determine the largest deviation between the average and the peak power of the EUT in a given bandwidth. The CCDF curve shows how much time the peak waveform spends at or above a given average power level. The present of time the signal spends at or above the level defines the probability for that particular power level.

### Test setting

The spectrum Analyzer's CCDF measurement function is enabled.

1. Set resolution/measurement bandwidth  $\geq$  OBW or specified reference bandwidth.
2. Set the number of counts to a value that stabilizes the measured CCDF curve.
3. Set the measurement interval as follows:
  - 1) For continuous transmissions, set to the greater of  $[10 \times (\text{number of points in sweep}) \times (\text{transmission symbol period})]$  or 1 ms.
  - 2) For burst transmissions, employ an external trigger that is synchronized with the EUT burst timing sequence, or use the internal burst trigger with a trigger level that allows the burst to stabilize. Set the measurement interval to a time that is less than or equal to the burst duration.
  - 3) If there are several carriers in a single antenna port, the peak power shall be determined for each individual carrier (by disabling the other carriers while measuring the required carrier) and the total peak power calculated from the sum of the individual carrier peak powers.
4. Record the maximum PAPR level associated with a probability of 0.1%.
5. The peak power level is calculated from the sum of the PAPR value from step d) to the measured average power.

### 3.3 OCCUPIED BANDWIDTH.

#### *Test set-up*

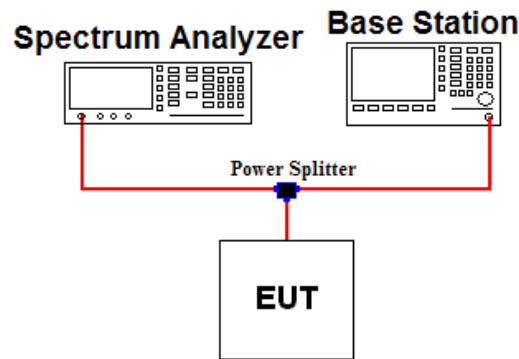

#### *Test Procedure*

- KDB971168 D01v03 - Section 4.3
- ANSI C63.26-2015 – Section 5.4.4

The occupied bandwidth, that is the frequency bandwidth such that, below its lower and above its upper frequency limits, the mean powers radiated are each equal to 0.5 percent of the total mean power of a given emission.

#### Test setting

1. The signal analyzer's automatic bandwidth measurement capability was used to perform the 99 % occupied bandwidth and the 26 dB bandwidth. The bandwidth measurement was not influenced by any intermediate power nulls in the fundamental emission.
2.  $RBW = 1 \sim 5 \%$  of the expected OBW &  $VBW \geq 3 \times RBW$
3. Detector = Peak
4. Trace mode = Max hold
5. Sweep = Auto couple
6. The trace was allowed to stabilize
7. If necessary, step 2 ~ 6 were repeated after changing the RBW such that it would be within 1 ~ 5 % of the 99 % occupied bandwidth observed in step 6.

### 3.4 BAND EDGE EMISSIONS AT ANTENNA TERMINAL

#### Test set-up

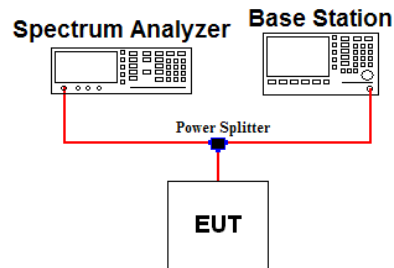

#### Test Procedure

- KDB971168 D01v03 - Section 6
- ANSI C63.26-2015 – Section 5.7

All out of band emissions are measured by means of a calibrated spectrum analyzer. The EUT was setup to maximum output power at its lowest and highest channel with all bandwidths, modulations and RB configurations.

The power of any spurious emission shall be attenuated below the transmitter power (P) by at least  $43 + 10 \log(P)$  dB.

#### Test setting

1. Start and stop frequency were set such that the band edge would be placed in the center of the plot
2. Span was set large enough so as to capture all out of band emissions near the band edge
3. RBW  $\geq 1\%$  of the emission bandwidth
4. VBW  $\geq 3 \times$  RBW
5. Detector = RMS & Trace mode = Max hold
6. Sweep time = Auto couple or 1 s for band edge
7. Number of sweep point  $\geq 2 \times$  span / RBW
8. The trace was allowed to stabilize

Note 1: Per Part 22.917(b)(1) / 24.238(b) / 27.53(h) in the 1 MHz bands immediately outside and adjacent to the frequency block a resolution bandwidth of at least one percent of the emission bandwidth of the fundamental emission of the transmitter may be employed to demonstrate compliance with the out-of-band emissions limit.

The emission bandwidth is defined as the width of the signal between two points, one below the carrier center frequency and one above the carrier center frequency, outside of which all emission are attenuated at least 26 dB below the transmitter power.

Note 2: Per Part 27(g) for operations in the 600 MHz band and the 698-746 MHz band, compliance with this provision is based on the use of measurement instrumentation employing a resolution bandwidth of 100 kilohertz or greater. However, in the 100 kilohertz bands immediately outside and adjacent to a licensee's frequency block, a resolution bandwidth of at least 30 kHz may be employed.

Note 3: For part 27.53(m)(4) the attenuation factor shall be not less than  $40 + 10 \log(P)$  dB on all frequencies between the channel edge and 5 megahertz from the channel edge,  $43 + 10 \log(P)$  dB on all frequencies between 5 megahertz and X megahertz from the channel edge, and  $55 + 10 \log(P)$  dB on all frequencies more than X megahertz from the channel edge, where X is the greater of 6 megahertz or the actual emission bandwidth as defined in paragraph (m)(6) of this section. In addition, the attenuation factor shall not be less than  $43 + 10 \log(P)$  dB on all frequencies between 2490.5 MHz and 2496 MHz and  $55 + 10 \log(P)$  dB at or below 2490.5 MHz.

Note 4: Per part 27.53(m)(6) in the 1 MHz bands immediately outside and adjacent to the frequency block a resolution bandwidth of at least two percent may be employed, except when the 1 MHz band is 2495-2496 MHz, in which case a resolution bandwidth of at least one percent may be employed.

### 3.5 SPURIOUS AND HARMONIC EMISSIONS AT ANTENNA TERMINAL

#### Test set-up

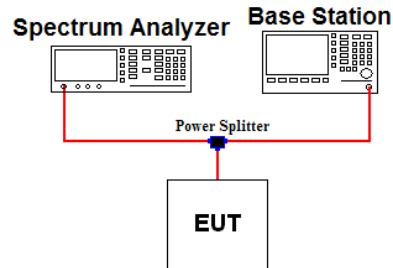

#### Test Procedure

- KDB971168 D01v03 - Section 6
- ANSI C63.26-2015 – Section 5.7

The level of the carrier and the various conducted spurious and harmonic frequencies is measured by means of a calibrated spectrum analyzer. The EUT was setup to maximum output power at its low, middle, high channel with all bandwidths, modulations and RB configurations. The spectrum is scanned from 9 kHz up to a frequency including its 10<sup>th</sup> harmonic.

The power of any spurious emission shall be attenuated below the transmitter power (P) by at least  $43 + 10 \log(P)$  dB.

#### Test setting

1. RBW = 100 kHz(Below 1 GHz) or 1 MHz(Above 1 GHz) & VBW  $\geq 3 \times$  RBW ( Refer to Note 1)
2. Detector = RMS & Trace mode = Max hold
3. Sweep time = Auto couple
4. Number of sweep point  $\geq 2 \times$  span / RBW
5. The trace was allowed to stabilize

Note 1: Compliance with these provisions is based on the use of measurement instrumentation employing a resolution bandwidth of 100 kHz or greater for frequencies less than 1GHz and 1MHz or greater for frequencies greater than 1GHz.

### 3.6 UNDESIRABLE EMISSIONS

#### Test Set-up

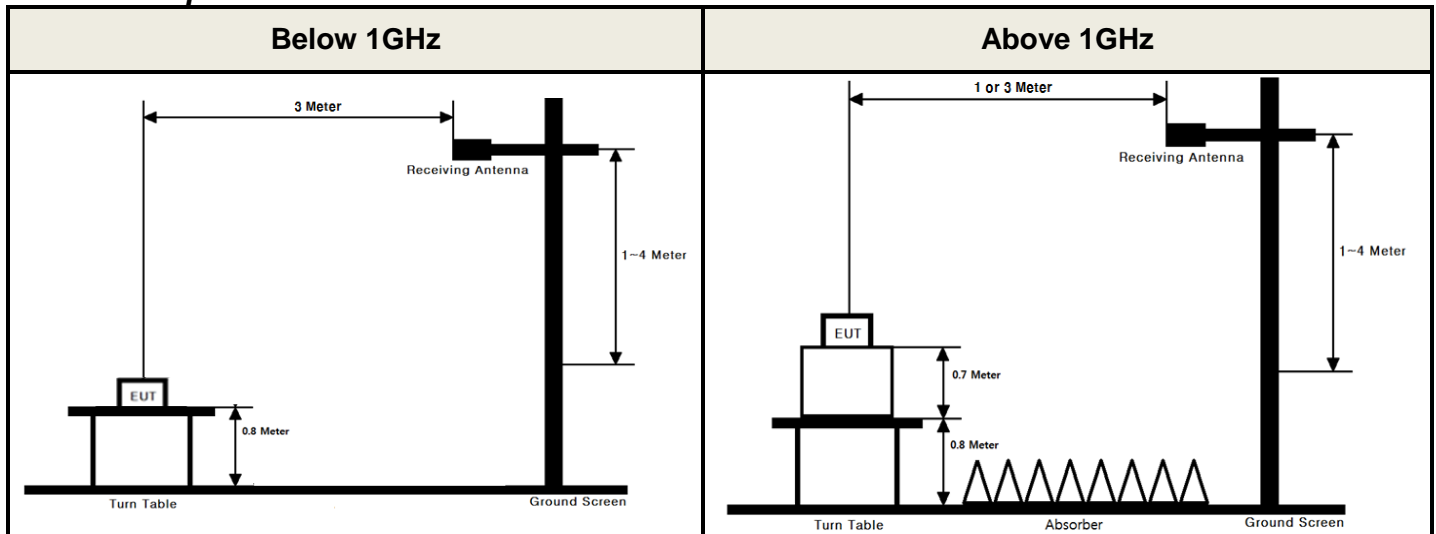

These measurements were performed at 3 test site. The equipment under test is placed on a non-conductive table 1.5-meters above a turntable which is flush with the ground plane and 3 meters from the receive antenna. For measurements above 1 GHz absorbers are placed on the floor between the turn table and the antenna mast in such a way so as to maximize the reduction of reflections. For measurements below 1 GHz, the absorbers are removed.

#### Test Procedure

- ANSI/TIA-603-E-2016 - Section 2.2.12
- KDB971168 D01v03 - Section 5.8
- ANSI C63.26-2015 – Section 5.5

#### Test setting

1. RBW = 100 kHz for below 1 GHz and 1 MHz for above 1 GHz / VBW  $\geq$  3 X RBW
2. Detector = RMS & Trace mode = Max hold
3. Sweep time = Auto couple
4. Number of sweep point  $\geq$  2 X span / RBW
5. The trace was allowed to stabilize

The receive antenna height and turntable rotations were adjusted for the highest reading on the receive spectrum analyzer.

For radiated power measurements below 1 GHz, a half-wave dipole was substituted in place of the EUT. This dipole antenna was driven by a signal generator and the level of the signal generator was adjusted to obtain the same spectrum analyzer reading.

For radiated power measurements above 1 GHz, a Horn antenna was substituted in place of the EUT. This Horn antenna was driven by a signal generator and the level of the signal generator was adjusted to obtain the same spectrum analyzer reading. The difference between the gain of the horn and an isotropic antenna are taken into consideration.

This measurement was performed with the EUT oriented in 3 orthogonal axis.

### 3.7 FREQUENCY STABILITY

#### Test Set-up

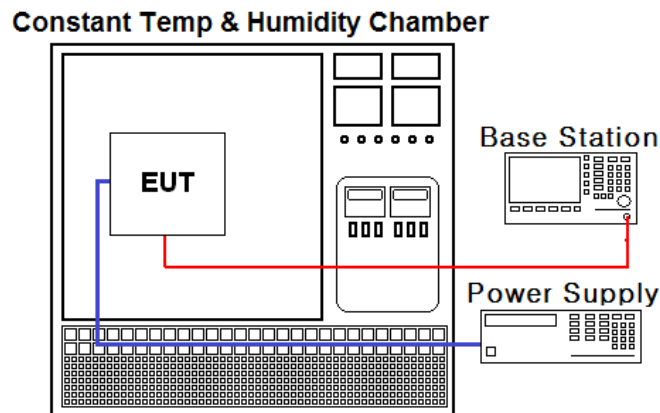

#### Test Procedure

- ANSI/TIA-603-E-2016
- KDB971168 D01v03 - Section 9

The frequency stability of the transmitter is measured by:

a.) **Temperature:**

The temperature is varied from - 30 °C to + 50 °C using an environmental chamber.

b.) **Primary Supply Voltage:**

The primary supply voltage is varied from 85 % to 115 % of the nominal value for non hand-carried battery and AC powered equipment. For hand-carried, battery-powered equipment, primary supply voltage is reduced to the battery operating end point which shall be specified by the manufacturer.

#### Specification:

The frequency stability shall be sufficient to ensure that the fundamental emission stays within the authorized frequency block for Part 24, 27. The frequency stability of the transmitter shall be maintained within  $\pm 0.00025\%$  ( $\pm 2.5$  ppm) of the center frequency for Part 22.

#### Time Period and Procedure:

1. The carrier frequency of the transmitter is measured at room temperature.  
(20 °C to provide a reference)
2. The equipment is turned on in a "standby" condition for one minute before applying power to the transmitter. Measurement of the carrier frequency of the transmitter is made within one minute after applying power to the transmitter.
3. Frequency measurements are made at 10 °C intervals ranging from -30 °C to +50 °C.  
A period of at least one half-hour is provided to allow stabilization of the equipment at each temperature level.



#### 4. LIST OF TEST EQUIPMENT

Type	Manufacturer	Model	Cal.Date (yy/mm/dd)	Next.Cal. Date (yy/mm/dd)	S/N
Spectrum Analyzer	Agilent Technologies	N9020A	19/06/26	20/06/26	MY50410163
Spectrum Analyzer	Agilent Technologies	N9030A	19/12/16	20/12/16	MY53310140
Spectrum Analyzer	Agilent Technologies	N9020A	19/06/26	20/06/26	US47360812
DC power supply	Agilent Technologies	66332A	19/06/25	20/06/25	MY43000394
Multimeter	FLUKE	17B+	19/12/17	20/12/17	36390701WS
Power Divider	Weinschel	WA1575	19/06/25	20/06/25	WA1575-1
I/O Adapter	Anritsu	MN8110B	NA	NA	6201468128
Temp & Humi	SJ Science	SJ-TH-S50	19/06/25	20/06/25	U5542113
Radio Communication Analyzer	Anritsu	MT8820C	19/06/26	20/06/26	6201127429
Thermohygrometer	BODYCOM	BJ5478	19/12/16	20/12/16	120612-2
Thermohygrometer	BODYCOM	BJ5478	19/12/16	20/12/16	120612-1
Signal Generator	Rohde Schwarz	SMBV100A	19/12/16	20/12/16	255571
Signal Generator	ANRITSU	MG3695C	19/12/16	20/12/16	173501
Loop Antenna	ETS-Lindgren	6502	19/09/18	21/09/18	00226186
Bilog Antenna	Schwarzbeck	VULB 9160	19/04/23	21/04/23	9160-3362
Dipole Antenna	Schwarzbeck	VHA9103	19/02/28	21/02/28	2116
Dipole Antenna	Schwarzbeck	VHA9103	18/04/13 20/04/10	20/04/13 22/04/10	2117
Dipole Antenna	Schwarzbeck	UHA9105	19/02/28	21/02/28	2261
Dipole Antenna	Schwarzbeck	UHA9105	18/04/13 20/04/10	20/04/13 22/04/10	2262
HORN ANT	ETS	3117	18/05/10 20/04/24	20/05/10 22/04/24	00140394
HORN ANT	ETS	3117	20/03/26	22/03/26	00152145
HORN ANT	A.H.Systems	SAS-574	19/04/23	21/04/23	154
HORN ANT	A.H.Systems	SAS-574	19/07/03	21/07/03	155
Amplifier	EMPOWER	BBS3Q7ELU	19/06/24	20/06/24	1020
PreAmplifier	H.P	8447D	19/12/16	20/12/16	2944A07774
PreAmplifier	Agilent	8449B	19/06/27	20/06/27	3008A02108
High-pass filter	Wainwright	WHKX12-935-1000-15000-40SS	19/06/24	20/06/24	7
High-pass filter	Wainwright	WHKX12-2580-3000-18000-80SS	19/06/24	20/06/24	3
High-pass filter	Wainwright	WHNX8.5/26.5G-6SS	19/06/24	20/06/24	1
Cable	DTNC	Cable	20/01/13	21/01/13	M-01
Cable	DTNC	Cable	20/01/13	21/01/13	M-02
Cable	Junkosha	MWX315	20/01/13	21/01/13	M-05
Cable	Junkosha	MWX221	20/01/13	21/01/13	M-06
Cable	DTNC	Cable	20/01/13	21/01/13	RF-84

Note1: The measurement antennas were calibrated in accordance to the requirements of ANSI C63.5-2017.

Note2: The cable is not a regular calibration item, so it has been calibrated by DT & C itself.

### 5. SUMMARY OF TEST RESULTS

FCC Part Section(s)	Test Description	Test Limit	Test Condition	Status Note 1
2.1046	Conducted Output Power	N/A	Conducted	C Note2
2.1049	Occupied Bandwidth	N/A		C
24.232(d) 27.50(d.5)	Peak to Average Ratio	< 13 dB		C
2.1051 22.917(a) 24.238(a) 27.53(c.2) 27.53(g) 27.53(h)	Band Edge / Conducted Spurious Emissions	> 43 + 10log <sub>10</sub> (P) dB at Band edge and for all out-of-band emissions		C
27.53(m)	Band Edge / Conducted Spurious Emissions	> 40 + 10log <sub>10</sub> (P) dB at channel edge and 5 MHz from the channel edge > 43 + 10log <sub>10</sub> (P) dB at 5 MHz and X MHz from the channel edge > 55 + 10log <sub>10</sub> (P) dB at all frequencies more than X MHz from the channel edge		C
2.1055 22.355 24.235 27.54	Frequency Stability	< 2.5 ppm (Part 22) Fundamental emissions must stay within Authorized frequency block (Part 24, 27)		C
27.50(b.10) 27.50(c.10)	Radiated Output Power (B12, 13, 17)	< 3 Watts max. ERP		Radiated
22.913(a.5)	Radiated Output Power (B5, 26)	< 7 Watts max. ERP	C	
27.50(d.4)	Radiated Output Power (B66, 4)	< 1 Watts max. EIRP	C	
24.232(c)	Radiated Output Power(B2, 25)	< 2 Watts max. EIRP	C	
27.50(h.2)	Radiated Output Power (B7, 41)	< 2 Watts max. EIRP	C	
2.1053 22.917(a) 24.238(a) 27.53(g) 27.53(h)	Undesirable Emissions	> 43 + 10log <sub>10</sub> (P) dB for all out-of-band emissions	C	
27.53(m)	Undesirable Emissions(B7, 41)	> 55 + 10log <sub>10</sub> (P) dB for all out-of-band emissions	C	

Note 1: **C**=Comply **NC**=Not Comply **NT**=Not Tested **NA**=Not Applicable

Note 2: Refer to RF Exposure Report (Test Report SAR)

Note 3: This device supports wireless charging & Can use Dual Screen.

So per KDB648474 D03v01r04, the radiated test items were performed all not charging, charging and Dual Screen conditions. For wireless charging condition, the handset is placed on the representative charging pad under normal conditions and in a simulated call configuration.

And the worst case data was reported.

## 6. SAMPLE CALCULATION

### A. Emission Designator

#### LTE Band 12, 17(QPSK)

Emission Designator = **8M93G7D**  
LTE OBW = 8.934 MHz  
G = Phase Modulation  
7 = Quantized/Digital Info  
D = Data Transmission

#### LTE Band 12, 17(64QAM)

Emission Designator = **8M97W7D**  
LTE OBW = 8.973 MHz  
W = Amplitude/Angle Modulated  
7 = Quantized/Digital Info  
D = Data Transmission

#### LTE Band 13(QPSK)

Emission Designator = **8M90G7D**  
LTE OBW = 8.904 MHz  
G = Phase Modulation  
7 = Quantized/Digital Info  
D = Data Transmission

#### LTE Band 13(64QAM)

Emission Designator = **8M94W7D**  
LTE OBW = 8.938 MHz  
W = Amplitude/Angle Modulated  
7 = Quantized/Digital Info  
D = Data Transmission

#### LTE Band 5, 26(QPSK)

Emission Designator = **13M4G7D**  
LTE OBW = 13.418 MHz  
G = Phase Modulation  
7 = Quantized/Digital Info  
D = Data Transmission

#### LTE Band 5, 26(64QAM)

Emission Designator = **13M4W7D**  
LTE OBW = 13.411 MHz  
W = Amplitude/Angle Modulated  
7 = Quantized/Digital Info  
D = Data Transmission

#### LTE Band 12, 17(16QAM)

Emission Designator = **8M95W7D**  
LTE OBW = 8.946 MHz  
W = Amplitude/Angle Modulated  
7 = Quantized/Digital Info  
D = Data Transmission

#### LTE Band 13(16QAM)

Emission Designator = **8M90W7D**  
LTE OBW = 8.903 MHz  
W = Amplitude/Angle Modulated  
7 = Quantized/Digital Info  
D = Data Transmission

#### LTE Band 5, 26(16QAM)

Emission Designator = **13M4W7D**  
LTE OBW = 13.416 MHz  
W = Amplitude/Angle Modulated  
7 = Quantized/Digital Info  
D = Data Transmission

**LTE Band 66, 4(QPSK)**

Emission Designator = **17M9G7D**  
LTE OBW = 17.892 MHz  
G = Phase Modulation  
7 = Quantized/Digital Info  
D = Data Transmission

**LTE Band 66, 4(64QAM)**

Emission Designator = **17M9W7D**  
LTE OBW = 17.883 MHz  
W = Amplitude/Angle Modulated  
7 = Quantized/Digital Info  
D = Data Transmission

**LTE Band 25, 2(QPSK)**

Emission Designator = **17M9G7D**  
LTE OBW = 17.890 MHz  
G = Phase Modulation  
7 = Quantized/Digital Info  
D = Data Transmission

**LTE Band 25, 2(64QAM)**

Emission Designator = **17M9W7D**  
LTE OBW = 17.902 MHz  
W = Amplitude/Angle Modulated  
7 = Quantized/Digital Info  
D = Data Transmission

**LTE Band 41(QPSK)**

Emission Designator = **17M8G7D**  
LTE OBW = 17.829 MHz  
G = Phase Modulation  
7 = Quantized/Digital Info  
D = Data Transmission

**LTE Band 41(64QAM)**

Emission Designator = **17M9W7D**  
LTE OBW = 17.941 MHz  
W = Amplitude/Angle Modulated  
7 = Quantized/Digital Info  
D = Data Transmission

**LTE Band 66, 4(16QAM)**

Emission Designator = **17M9W7D**  
LTE OBW = 17.892 MHz  
W = Amplitude/Angle Modulated  
7 = Quantized/Digital Info  
D = Data Transmission

**LTE Band 25, 2(16QAM)**

Emission Designator = **18M0W7D**  
LTE OBW = 17.963 MHz  
W = Amplitude/Angle Modulated  
7 = Quantized/Digital Info  
D = Data Transmission

**LTE Band 41(16QAM)**

Emission Designator = **17M8W7D**  
LTE OBW = 17.760 MHz  
W = Amplitude/Angle Modulated  
7 = Quantized/Digital Info  
D = Data Transmission

**LTE Band 7(QPSK)**Emission Designator = **17M9G7D**

LTE OBW = 17.884 MHz

G = Phase Modulation

7 = Quantized/Digital Info

D = Data Transmission

**LTE Band 7(16QAM)**Emission Designator = **17M9W7D**

LTE OBW = 17.882 MHz

W = Amplitude/Angle Modulated

7 = Quantized/Digital Info

D = Data Transmission

**LTE Band 7(64QAM)**Emission Designator = **17M9W7D**

LTE OBW = 17.896 MHz

W = Amplitude/Angle Modulated

7 = Quantized/Digital Info

D = Data Transmission

## **B. For substitution method**

- 1) The EUT was placed on a turntable with 0.8 meter height for frequency below 1GHz and 1.5 meter height for frequency above 1 GHz respectively above ground.
- 2) The EUT was set 3 meters from the receiving antenna mounted on the antenna tower.
- 3) During the test, the turn table is rotated until the maximum signal is found.
- 4) Record the field strength meter's level. (ex. Spectrum reading level is -8.5 dBm)
- 5) Replace the EUT with dipole/Horn antenna that is connected to a calibrated signal generator.
- 6) Increase the signal generator output till the field strength meter's level is equal to the item (4).  
(ex. Signal generator level is -18.04 dBm)
- 7) The gain of the cable and amplifier between the signal generator and terminals of substituted antenna is 46.92 dB at test frequency.
- 8) Record the level at substituted antenna terminal. (ex. 28.88dBm)
- 9) The result is calculated as below;

$$\text{EIRP(dBm)} = \text{LEVLE@ANTENNA TERMINAL} + \text{TX Antenna Gain (dBi)}$$

$$\text{ERP(dBm)} = \text{LEVLE@ANTENNA TERMINAL} + \text{TX Antenna Gain (dBd)}$$

$$\text{Where, TX Antenna Gain (dBd)} = \text{TX Antenna Gain (dBi)} - 2.15 \text{ dB}$$

## 7. TEST DATA

### 7.1 OCCUPIED BANDWIDTH

- Plots of the EUT's Occupied Bandwidth are shown in Clause 8.1

### 7.2 PEAK TO AVERAGE RATIO

- Plots of the EUT's Peak- to- Average Ratio are shown in Clause 8.2

### 7.3 BAND EDGE EMISSIONS (Conducted)

- Plots of the EUT's Band Edge Emissions are shown in Clause 8.3

### 7.4 SPURIOUS AND HARMONICS EMISSIONS (Conducted)

- Plots of the EUT's Spurious Emissions are shown in Clause 8.4

## 7.5 ERP & EIRP

### - Test Notes

- 1) This device was tested under all bandwidths, modulations and RB configurations and the worst case data are reported in the below table.

### 7.5.1 LTE Band 12, 17

#### - Measurement data: Without wireless charging pad

Channel Bandwidth (MHz)	Test Frequency (MHz)	Test Mode	RB Size/ Offset	Ant Pol (H/V)	Level(dBm) @ Ant Terminal	TX Ant Gain (dBd)	ERP (dBm)	ERP (W)	Note
10	704	QPSK	1/25	H	21.59	-0.65	20.94	0.124	-
		16QAM	1/25	H	20.40	-0.65	19.75	0.094	-
		64QAM	1/25	H	19.15	-0.65	18.50	0.071	-
	711	QPSK	1/0	H	21.26	-0.63	20.63	0.116	-
		16QAM	1/0	H	19.99	-0.63	19.36	0.086	-
		64QAM	1/0	H	18.85	-0.63	18.22	0.066	-
5	701.5	QPSK	1/24	H	21.82	-0.66	21.16	0.131	-
		16QAM	1/24	H	20.28	-0.66	19.62	0.092	-
		64QAM	1/24	H	19.32	-0.66	18.66	0.073	-
		QPSK	1/24	H	20.76	-0.66	20.10	0.102	With Dual Display (180°)
	707.5	QPSK	1/0	H	21.35	-0.64	20.71	0.118	-
		16QAM	1/0	H	20.34	-0.64	19.70	0.093	-
		64QAM	1/0	H	18.98	-0.64	18.34	0.068	-
	713.5	QPSK	1/0	H	20.28	-0.62	19.66	0.092	-
		16QAM	1/0	H	18.77	-0.62	18.15	0.065	-
		64QAM	1/0	H	17.85	-0.62	17.23	0.053	-



## 7.5.2 LTE Band 12

### - Measurement data: Without wireless charging pad

Channel Bandwidth (MHz)	Test Frequency (MHz)	Test Mode	RB Size/ Offset	Ant Pol (H/V)	Level(dBm) @ Ant Terminal	TX Ant Gain (dBd)	ERP (dBm)	ERP (W)	Note
3	700.5	QPSK	1/7	H	20.84	-0.66	20.18	0.104	-
		16QAM	1/7	H	19.76	-0.66	19.10	0.081	-
		64QAM	1/7	H	18.81	-0.66	18.15	0.065	-
	707.5	QPSK	1/7	H	21.34	-0.64	20.70	0.117	-
		16QAM	1/7	H	19.87	-0.64	19.23	0.084	-
		64QAM	1/7	H	18.79	-0.64	18.15	0.065	-
	714.5	QPSK	1/7	H	20.80	-0.62	20.18	0.104	-
		16QAM	1/7	H	19.31	-0.62	18.69	0.074	-
		64QAM	1/7	H	18.18	-0.62	17.56	0.057	-
1.4	699.7	QPSK	1/2	H	20.88	-0.66	20.22	0.105	-
		16QAM	1/2	H	19.59	-0.66	18.93	0.078	-
		64QAM	1/2	H	18.67	-0.66	18.01	0.063	-
	707.5	QPSK	1/2	H	20.77	-0.64	20.13	0.103	-
		16QAM	1/2	H	19.33	-0.64	18.69	0.074	-
		64QAM	1/2	H	18.30	-0.64	17.66	0.058	-
	715.3	QPSK	1/2	H	20.85	-0.62	20.23	0.105	-
		16QAM	1/2	H	19.34	-0.62	18.72	0.074	-
		64QAM	1/2	H	18.27	-0.62	17.65	0.058	-

### - Measurement data: With wireless charging pad

Channel Bandwidth (MHz)	Test Frequency (MHz)	Test Mode	RB Size/ Offset	Ant Pol (H/V)	Level(dBm) @ Ant Terminal	TX Ant Gain (dBd)	ERP (dBm)	ERP (W)	Note
10	704	QPSK	1/25	H	20.83	-0.65	20.18	0.104	-
		16QAM	1/25	H	19.70	-0.65	19.05	0.080	-
		64QAM	1/25	H	18.76	-0.65	18.11	0.065	-
5	701.5	QPSK	1/24	H	20.71	-0.66	20.05	0.101	-
		16QAM	1/24	H	19.76	-0.66	19.10	0.081	-
		64QAM	1/24	H	18.61	-0.66	17.95	0.062	-
		QPSK	1/24	H	19.45	-0.66	18.79	0.076	With Dual Display (180°)
3	707.5	QPSK	1/7	H	20.68	-0.64	20.04	0.101	-
		16QAM	1/7	H	19.37	-0.64	18.73	0.075	-
		64QAM	1/7	H	18.31	-0.64	17.67	0.058	-
1.4	715.3	QPSK	1/2	H	20.22	-0.62	19.60	0.091	-
		16QAM	1/2	H	19.17	-0.62	18.55	0.072	-
		64QAM	1/2	H	18.05	-0.62	17.43	0.055	-

### 7.5.3 LTE Band 13

#### - Measurement data: Without wireless charging pad

Channel Bandwidth (MHz)	Test Frequency (MHz)	Test Mode	RB Size/ Offset	Ant Pol (H/V)	Level(dBm) @ Ant Terminal	TX Ant Gain (dBd)	ERP (dBm)	ERP (W)	Note
10	782	QPSK	1/0	V	20.12	-0.45	19.67	0.093	-
		16QAM	1/0	V	18.62	-0.45	18.17	0.066	-
		64QAM	1/0	V	17.54	-0.45	17.09	0.051	-
		QPSK	1/0	V	18.22	-0.45	17.77	0.060	With Dual Display (180°)
5	779.5	QPSK	1/12	V	20.04	-0.45	19.59	0.091	-
		16QAM	1/12	V	18.66	-0.45	18.21	0.066	-
		64QAM	1/12	V	17.47	-0.45	17.02	0.050	-
	784.5	QPSK	1/0	V	19.99	-0.44	19.55	0.090	-
		16QAM	1/0	V	18.60	-0.44	18.16	0.065	-
		64QAM	1/0	V	17.23	-0.44	16.79	0.048	-

#### - Measurement data: With wireless charging pad

Channel Bandwidth (MHz)	Test Frequency (MHz)	Test Mode	RB Size/ Offset	Ant Pol (H/V)	Level(dBm) @ Ant Terminal	TX Ant Gain (dBd)	ERP (dBm)	ERP (W)	Note
10	782	QPSK	1/0	H	19.89	-0.45	19.44	0.088	-
		16QAM	1/0	H	18.53	-0.45	18.08	0.064	-
		64QAM	1/0	H	17.38	-0.45	16.93	0.049	-
		QPSK	1/0	H	18.08	-0.45	17.63	0.058	With Dual Display (180°)
5	779.5	QPSK	1/12	H	19.62	-0.45	19.17	0.083	-
		16QAM	1/12	H	18.31	-0.45	17.86	0.061	-
		64QAM	1/12	H	17.30	-0.45	16.85	0.048	-

### 7.5.4 LTE Band 26

#### - Measurement data: Without wireless charging pad

Channel Bandwidth (MHz)	Test Frequency (MHz)	Test Mode	RB Size/ Offset	Ant Pol (H/V)	Level(dBm) @ Ant Terminal	TX Ant Gain (dBd)	ERP (dBm)	ERP (W)	Note
15	831.5	QPSK	1/36	V	21.32	-0.69	20.63	0.116	-
		16QAM	1/36	V	20.21	-0.69	19.52	0.090	-
		64QAM	1/36	V	19.05	-0.69	18.36	0.069	-
	841.5	QPSK	1/36	V	20.31	-0.79	19.52	0.090	-
		16QAM	1/36	V	19.39	-0.79	18.60	0.072	-
		64QAM	1/36	V	18.45	-0.79	17.66	0.058	-

#### - Measurement data: With wireless charging pad

Channel Bandwidth (MHz)	Test Frequency (MHz)	Test Mode	RB Size/ Offset	Ant Pol (H/V)	Level(dBm) @ Ant Terminal	TX Ant Gain (dBd)	ERP (dBm)	ERP (W)	Note
15	831.5	QPSK	1/36	H	21.29	-0.69	20.60	0.115	-
		16QAM	1/36	H	19.96	-0.69	19.27	0.085	-
		64QAM	1/36	H	18.67	-0.69	17.98	0.063	-

**7.5.5 LTE Band 5, 26**
**- Measurement data: Without wireless charging pad**

Channel Bandwidth (MHz)	Test Frequency (MHz)	Test Mode	RB Size/ Offset	Ant Pol (H/V)	Level(dBm) @ Ant Terminal	TX Ant Gain (dBd)	ERP (dBm)	ERP (W)	Note
10	829	QPSK	1/25	V	21.28	-0.67	20.61	0.115	-
		16QAM	1/25	V	20.15	-0.67	19.48	0.089	-
		64QAM	1/25	V	19.25	-0.67	18.58	0.072	-
	836.5	QPSK	1/0	V	21.66	-0.74	20.92	0.124	-
		16QAM	1/0	V	20.54	-0.74	19.80	0.095	-
		64QAM	1/0	V	19.62	-0.74	18.88	0.077	-
	844	QPSK	1/0	V	18.37	-0.74	17.63	0.058	With Dual Display (180°)
		16QAM	1/0	V	20.52	-0.81	19.71	0.094	-
		64QAM	1/0	V	19.68	-0.81	18.87	0.077	-
5	826.5	QPSK	1/12	V	21.08	-0.65	20.43	0.110	-
		16QAM	1/12	V	20.13	-0.65	19.48	0.089	-
		64QAM	1/12	V	19.20	-0.65	18.55	0.072	-
	836.5	QPSK	1/0	V	21.44	-0.74	20.70	0.117	-
		16QAM	1/0	V	20.51	-0.74	19.77	0.095	-
		64QAM	1/0	V	19.67	-0.74	18.93	0.078	-
	846.5	QPSK	1/0	V	19.74	-0.83	18.91	0.078	-
		16QAM	1/0	V	18.85	-0.83	18.02	0.063	-
		64QAM	1/0	V	17.90	-0.83	17.07	0.051	-
3	825.5	QPSK	1/7	V	20.77	-0.64	20.13	0.103	-
		16QAM	1/7	V	19.49	-0.64	18.85	0.077	-
		64QAM	1/7	V	18.38	-0.64	17.74	0.059	-
	836.5	QPSK	1/7	V	20.86	-0.74	20.12	0.103	-
		16QAM	1/7	V	19.46	-0.74	18.72	0.074	-
		64QAM	1/7	V	18.40	-0.74	17.66	0.058	-
	847.5	QPSK	1/0	V	19.45	-0.84	18.61	0.073	-
		16QAM	1/0	V	18.10	-0.84	17.26	0.053	-
		64QAM	1/0	V	16.94	-0.84	16.10	0.041	-
1.4	824.7	QPSK	1/2	V	20.45	-0.63	19.82	0.096	-
		16QAM	1/2	V	19.47	-0.63	18.84	0.077	-
		64QAM	1/2	V	18.00	-0.63	17.37	0.055	-
	836.5	QPSK	1/2	V	20.37	-0.74	19.63	0.092	-
		16QAM	1/2	V	19.67	-0.74	18.93	0.078	-
		64QAM	1/2	V	18.08	-0.74	17.34	0.054	-
	848.3	QPSK	1/2	V	17.50	-0.85	16.65	0.046	-
		16QAM	1/2	V	16.58	-0.85	15.73	0.037	-
		64QAM	1/2	V	15.59	-0.85	14.74	0.030	-

**- Measurement data: With wireless charging pad**

Channel Bandwidth (MHz)	Test Frequency (MHz)	Test Mode	RB Size/ Offset	Ant Pol (H/V)	Level(dBm) @ Ant Terminal	TX Ant Gain (dBd)	ERP (dBm)	ERP (W)	Note
10	836.5	QPSK	1/0	H	21.32	-0.74	20.58	0.114	-
		16QAM	1/0	H	19.95	-0.74	19.21	0.083	-
		64QAM	1/0	H	18.68	-0.74	17.94	0.062	-
		QPSK	1/0	H	15.90	-0.74	15.16	0.033	With Dual Display (180°)
5	836.5	QPSK	1/0	H	21.06	-0.74	20.32	0.108	-
		16QAM	1/0	H	19.71	-0.74	18.97	0.079	-
		64QAM	1/0	H	18.52	-0.74	17.78	0.060	-
3	825.5	QPSK	1/7	H	22.09	-0.64	21.45	0.140	-
		16QAM	1/7	H	20.77	-0.64	20.13	0.103	-
		64QAM	1/7	H	19.67	-0.64	19.03	0.080	-
1.4	824.7	QPSK	1/2	H	21.00	-0.63	20.37	0.109	-
		16QAM	1/2	H	19.80	-0.63	19.17	0.083	-
		64QAM	1/2	H	18.68	-0.63	18.05	0.064	-

**7.5.6 LTE Band 66, 4**
**- Measurement data: Without wireless charging pad**

Channel Bandwidth (MHz)	Test Frequency (MHz)	Test Mode	RB Size/ Offset	Ant Pol (H/V)	Level(dBm) @ Ant Terminal	TX Ant Gain (dBi)	EIRP (dBm)	EIRP (W)	Note
20	1720	QPSK	1/50	V	15.33	5.28	20.61	0.115	-
		16QAM	1/50	V	14.58	5.28	19.86	0.097	-
		64QAM	1/50	V	13.68	5.28	18.96	0.079	-
	1745	QPSK	1/50	V	15.74	5.38	21.12	0.129	-
		16QAM	1/50	V	14.93	5.38	20.31	0.107	-
		64QAM	1/50	V	13.97	5.38	19.35	0.086	-
	1770	QPSK	1/99	V	16.46	5.20	21.66	0.147	-
		16QAM	1/99	V	15.80	5.20	21.00	0.126	-
		64QAM	1/99	V	14.75	5.20	19.95	0.099	-
15	1717.5	QPSK	1/36	V	15.36	5.27	20.63	0.116	-
		16QAM	1/36	V	14.69	5.27	19.96	0.099	-
		64QAM	1/36	V	13.41	5.27	18.68	0.074	-
	1745	QPSK	1/36	V	15.70	5.38	21.08	0.128	-
		16QAM	1/36	V	14.81	5.38	20.19	0.104	-
		64QAM	1/36	V	13.73	5.38	19.11	0.081	-
	1772.5	QPSK	1/74	V	16.90	5.18	22.08	0.161	-
		16QAM	1/74	V	16.07	5.18	21.25	0.133	-
		64QAM	1/74	V	15.24	5.18	20.42	0.110	-
10	1715	QPSK	1/25	V	14.80	5.26	20.06	0.101	-
		16QAM	1/25	V	14.15	5.26	19.41	0.087	-
		64QAM	1/25	V	13.03	5.26	18.29	0.067	-
	1745	QPSK	1/25	V	16.01	5.38	21.39	0.138	-
		16QAM	1/25	V	15.30	5.38	20.68	0.117	-
		64QAM	1/25	V	14.41	5.38	19.79	0.095	-
	1775	QPSK	1/25	V	16.42	5.15	21.57	0.144	-
		16QAM	1/25	V	15.64	5.15	20.79	0.120	-
		64QAM	1/25	V	14.89	5.15	20.04	0.101	-

Channel Bandwidth (MHz)	Test Frequency (MHz)	Test Mode	RB Size/ Offset	Ant Pol (H/V)	Level(dBm) @ Ant Terminal	TX Ant Gain (dBi)	EIRP (dBm)	EIRP (W)	Note
5	1712.5	QPSK	1/12	V	15.02	5.25	20.27	0.106	-
		16QAM	1/12	V	14.06	5.25	19.31	0.085	-
		64QAM	1/12	V	13.19	5.25	18.44	0.070	-
	1745	QPSK	1/12	V	15.66	5.38	21.04	0.127	-
		16QAM	1/12	V	14.72	5.38	20.10	0.102	-
		64QAM	1/12	V	13.77	5.38	19.15	0.082	-
	1777.5	QPSK	1/12	V	17.12	5.13	22.25	0.168	-
		16QAM	1/12	V	16.48	5.13	21.61	0.145	-
		64QAM	1/12	V	15.47	5.13	20.60	0.115	-
		QPSK	1/12	V	16.55	5.13	21.68	0.147	With Dual Display (180°)
3	1711.5	QPSK	1/7	V	15.11	5.25	20.36	0.109	-
		16QAM	1/7	V	14.28	5.25	19.53	0.090	-
		64QAM	1/7	V	13.32	5.25	18.57	0.072	-
	1745	QPSK	1/7	V	15.74	5.38	21.12	0.129	-
		16QAM	1/7	V	14.85	5.38	20.23	0.105	-
		64QAM	1/7	V	13.83	5.38	19.21	0.083	-
	1778.5	QPSK	1/7	V	16.84	5.12	21.96	0.157	-
		16QAM	1/7	V	16.03	5.12	21.15	0.130	-
		64QAM	1/7	V	15.05	5.12	20.17	0.104	-
1.4	1710.7	QPSK	1/2	V	15.05	5.24	20.29	0.107	-
		16QAM	1/2	V	14.13	5.24	19.37	0.086	-
		64QAM	1/2	V	13.37	5.24	18.61	0.073	-
	1745	QPSK	1/2	V	15.86	5.38	21.24	0.133	-
		16QAM	1/2	V	14.77	5.38	20.15	0.104	-
		64QAM	1/2	V	13.85	5.38	19.23	0.084	-
	1779.3	QPSK	1/2	V	16.80	5.11	21.91	0.155	-
		16QAM	1/2	V	16.11	5.11	21.22	0.132	-
		64QAM	1/2	V	14.84	5.11	19.95	0.099	-

**- Measurement data: With wireless charging pad**

Channel Bandwidth (MHz)	Test Frequency (MHz)	Test Mode	RB Size/Offset	Ant Pol (H/V)	Level(dBm) @ Ant Terminal	TX Ant Gain (dBi)	EIRP (dBm)	EIRP (W)	Note
20	1770	QPSK	1/99	H	14.59	5.20	19.79	0.095	-
		16QAM	1/99	H	14.05	5.20	19.25	0.084	-
		64QAM	1/99	H	12.98	5.20	18.18	0.066	-
15	1772.5	QPSK	1/74	H	15.06	5.18	20.24	0.106	-
		16QAM	1/74	H	14.23	5.18	19.41	0.087	-
		64QAM	1/74	H	13.28	5.18	18.46	0.070	-
10	1775	QPSK	1/25	H	14.62	5.15	19.77	0.095	-
		16QAM	1/25	H	13.86	5.15	19.01	0.080	-
		64QAM	1/25	H	13.06	5.15	18.21	0.066	-
5	1777.5	QPSK	1/12	H	15.34	5.13	20.47	0.111	-
		16QAM	1/12	H	14.70	5.13	19.83	0.096	-
		64QAM	1/12	H	13.68	5.13	18.81	0.076	-
		QPSK	1/12	H	14.89	5.13	20.02	0.100	With Dual Display (180°)
3	1778.5	QPSK	1/7	H	15.09	5.12	20.21	0.105	-
		16QAM	1/7	H	14.25	5.12	19.37	0.086	-
		64QAM	1/7	H	13.31	5.12	18.43	0.070	-
1.4	1779.3	QPSK	1/2	H	15.02	5.11	20.13	0.103	-
		16QAM	1/2	H	14.28	5.11	19.39	0.087	-
		64QAM	1/2	H	13.07	5.11	18.18	0.066	-



### 7.5.7 LTE Band 25, 2

#### - Measurement data: Without wireless charging pad

Channel Bandwidth (MHz)	Test Frequency (MHz)	Test Mode	RB Size/ Offset	Ant Pol (H/V)	Level(dBm) @ Ant Terminal	TX Ant Gain (dBi)	EIRP (dBm)	EIRP (W)	Note
20	1860	QPSK	1/50	V	16.35	4.80	21.15	0.130	-
		16QAM	1/50	V	15.70	4.80	20.50	0.112	-
		64QAM	1/50	V	14.72	4.80	19.52	0.090	-
	1882.5	QPSK	1/50	V	16.50	4.58	21.08	0.128	-
		16QAM	1/50	V	15.74	4.58	20.32	0.108	-
		64QAM	1/50	V	14.84	4.58	19.42	0.087	-
	1905	QPSK	1/50	V	17.55	4.42	21.97	0.157	-
		16QAM	1/50	V	16.79	4.42	21.21	0.132	-
		64QAM	1/50	V	15.91	4.42	20.33	0.108	-
		QPSK	1/50	V	16.92	4.42	21.34	0.136	With Dual Display (180°)
15	1857.5	QPSK	1/36	V	15.72	4.83	20.55	0.114	-
		16QAM	1/36	V	15.03	4.83	19.86	0.097	-
		64QAM	1/36	V	14.00	4.83	18.83	0.076	-
	1882.5	QPSK	1/36	V	16.48	4.58	21.06	0.128	-
		16QAM	1/36	V	15.84	4.58	20.42	0.110	-
		64QAM	1/36	V	14.61	4.58	19.19	0.083	-
	1907.5	QPSK	1/36	V	17.42	4.43	21.85	0.153	-
		16QAM	1/36	V	16.85	4.43	21.28	0.134	-
		64QAM	1/36	V	15.61	4.43	20.04	0.101	-
10	1855	QPSK	1/0	V	15.70	4.85	20.55	0.114	-
		16QAM	1/0	V	14.91	4.85	19.76	0.095	-
		64QAM	1/0	V	14.08	4.85	18.93	0.078	-
	1882.5	QPSK	1/0	V	16.88	4.58	21.46	0.140	-
		16QAM	1/0	V	15.66	4.58	20.24	0.106	-
		64QAM	1/0	V	14.88	4.58	19.46	0.088	-
	1910	QPSK	1/25	V	17.24	4.44	21.68	0.147	-
		16QAM	1/25	V	16.47	4.44	20.91	0.123	-
		64QAM	1/25	V	15.27	4.44	19.71	0.094	-

Channel Bandwidth (MHz)	Test Frequency (MHz)	Test Mode	RB Size/Offset	Ant Pol (H/V)	Level(dBm) @ Ant Terminal	TX Ant Gain (dBi)	EIRP (dBm)	EIRP (W)	Note
5	1852.5	QPSK	1/12	V	15.45	4.88	20.33	0.108	-
		16QAM	1/12	V	14.46	4.88	19.34	0.086	-
		64QAM	1/12	V	13.39	4.88	18.27	0.067	-
	1882.5	QPSK	1/12	V	16.54	4.58	21.12	0.129	-
		16QAM	1/12	V	15.66	4.58	20.24	0.106	-
		64QAM	1/12	V	14.54	4.58	19.12	0.082	-
	1912.5	QPSK	1/12	V	16.71	4.45	21.16	0.131	-
		16QAM	1/12	V	15.78	4.45	20.23	0.105	-
		64QAM	1/12	V	14.83	4.45	19.28	0.085	-
3	1851.5	QPSK	1/7	V	15.21	4.89	20.10	0.102	-
		16QAM	1/7	V	14.39	4.89	19.28	0.085	-
		64QAM	1/7	V	13.32	4.89	18.21	0.066	-
	1882.5	QPSK	1/7	V	16.35	4.58	20.93	0.124	-
		16QAM	1/7	V	15.65	4.58	20.23	0.105	-
		64QAM	1/7	V	14.60	4.58	19.18	0.083	-
	1913.5	QPSK	1/7	V	16.76	4.45	21.21	0.132	-
		16QAM	1/7	V	15.97	4.45	20.42	0.110	-
		64QAM	1/7	V	14.92	4.45	19.37	0.086	-
1.4	1850.7	QPSK	1/2	V	15.29	4.89	20.18	0.104	-
		16QAM	1/2	V	14.58	4.89	19.47	0.089	-
		64QAM	1/2	V	13.46	4.89	18.35	0.068	-
	1882.5	QPSK	1/2	V	16.61	4.58	21.19	0.132	-
		16QAM	1/2	V	15.83	4.58	20.41	0.110	-
		64QAM	1/2	V	14.76	4.58	19.34	0.086	-
	1914.3	QPSK	1/2	V	16.95	4.46	21.41	0.138	-
		16QAM	1/2	V	16.11	4.46	20.57	0.114	-
		64QAM	1/2	V	15.17	4.46	19.63	0.092	-

**- Measurement data: With wireless charging pad**

Channel Bandwidth (MHz)	Test Frequency (MHz)	Test Mode	RB Size/ Offset	Ant Pol (H/V)	Level(dBm) @ Ant Terminal	TX Ant Gain (dBi)	EIRP (dBm)	EIRP (W)	Note
20	1905	QPSK	1/50	H	16.94	4.42	21.36	0.137	-
		16QAM	1/50	H	16.12	4.42	20.54	0.113	-
		64QAM	1/50	H	15.26	4.42	19.68	0.093	-
		QPSK	1/50	H	16.02	4.42	20.44	0.111	With Dual Display (180°)
15	1907.5	QPSK	1/36	H	16.78	4.43	21.21	0.132	-
		16QAM	1/36	H	16.16	4.43	20.59	0.115	-
		64QAM	1/36	H	15.05	4.43	19.48	0.089	-
10	1910	QPSK	1/25	H	16.63	4.44	21.07	0.128	-
		16QAM	1/25	H	15.85	4.44	20.29	0.107	-
		64QAM	1/25	H	14.70	4.44	19.14	0.082	-
5	1912.5	QPSK	1/12	H	16.02	4.45	20.47	0.111	-
		16QAM	1/12	H	15.10	4.45	19.55	0.090	-
		64QAM	1/12	H	14.18	4.45	18.63	0.073	-
3	1913.5	QPSK	1/7	H	16.04	4.45	20.49	0.112	-
		16QAM	1/7	H	15.25	4.45	19.70	0.093	-
		64QAM	1/7	H	14.20	4.45	18.65	0.073	-
1.4	1914.3	QPSK	1/2	H	16.21	4.46	20.67	0.117	-
		16QAM	1/2	H	15.36	4.46	19.82	0.096	-
		64QAM	1/2	H	14.37	4.46	18.83	0.076	-

**7.5.8 LTE Band 41**
**- Measurement data: Without wireless charging pad**

Channel Bandwidth (MHz)	Test Frequency (MHz)	Test Mode	RB Size/ Offset	Ant Pol (H/V)	Level(dBm) @ Ant Terminal	TX Ant Gain (dBi)	EIRP (dBm)	EIRP (W)	Note
20	2506	QPSK	1/50	H	15.13	5.92	21.05	0.127	-
		16QAM	1/50	H	14.51	5.92	20.43	0.110	-
		64QAM	1/50	H	13.67	5.92	19.59	0.091	-
	2593	QPSK	1/50	H	15.53	6.19	21.72	0.149	-
		16QAM	1/50	H	14.98	6.19	21.17	0.131	-
		64QAM	1/50	H	14.16	6.19	20.35	0.108	-
	2680	QPSK	1/50	H	14.93	6.34	21.27	0.134	-
		16QAM	1/50	H	14.28	6.34	20.62	0.115	-
		64QAM	1/50	H	13.84	6.34	20.18	0.104	-
15	2503.5	QPSK	1/36	H	15.11	5.91	21.02	0.126	-
		16QAM	1/36	H	14.39	5.91	20.30	0.107	-
		64QAM	1/36	H	13.58	5.91	19.49	0.089	-
	2593	QPSK	1/36	H	15.78	6.19	21.97	0.157	-
		16QAM	1/36	H	15.12	6.19	21.31	0.135	-
		64QAM	1/36	H	14.04	6.19	20.23	0.105	-
	2682.5	QPSK	1/36	H	15.00	6.33	21.33	0.136	-
		16QAM	1/36	H	14.29	6.33	20.62	0.115	-
		64QAM	1/36	H	13.93	6.33	20.26	0.106	-
10	2501	QPSK	1/25	H	15.51	5.90	21.41	0.138	-
		16QAM	1/25	H	14.95	5.90	20.85	0.122	-
		64QAM	1/25	H	14.16	5.90	20.06	0.101	-
	2593	QPSK	1/25	H	16.16	6.19	22.35	0.172	-
		16QAM	1/25	H	15.38	6.19	21.57	0.144	-
		64QAM	1/25	H	14.49	6.19	20.68	0.117	-
	2685	QPSK	1/25	H	15.44	6.19	21.63	0.146	With Dual Display (180°)
		16QAM	1/25	H	15.16	6.32	21.48	0.141	-
		64QAM	1/25	H	14.52	6.32	20.84	0.121	-
5	2498.5	QPSK	1/12	H	15.87	5.89	21.76	0.150	-
		16QAM	1/12	H	14.92	5.89	20.81	0.121	-
		64QAM	1/12	H	14.01	5.89	19.90	0.098	-
	2593	QPSK	1/12	H	15.99	6.19	22.18	0.165	-
		16QAM	1/12	H	15.37	6.19	21.56	0.143	-
		64QAM	1/12	H	14.45	6.19	20.64	0.116	-
	2687.5	QPSK	1/12	H	14.92	6.31	21.23	0.133	-
		16QAM	1/12	H	14.48	6.31	20.79	0.120	-
		64QAM	1/12	H	13.63	6.31	19.94	0.099	-

**- Measurement data: With wireless charging pad**

Channel Bandwidth (MHz)	Test Frequency (MHz)	Test Mode	RB Size/ Offset	Ant Pol (H/V)	Level(dBm) @ Ant Terminal	TX Ant Gain (dBi)	EIRP (dBm)	EIRP (W)	Note
20	2593	QPSK	1/50	H	15.41	6.19	21.60	0.145	-
		16QAM	1/50	H	14.73	6.19	20.92	0.124	-
		64QAM	1/50	H	14.00	6.19	20.19	0.104	-
15	2593	QPSK	1/36	H	15.61	6.19	21.80	0.151	-
		16QAM	1/36	H	14.87	6.19	21.06	0.128	-
		64QAM	1/36	H	13.89	6.19	20.08	0.102	-
10	2593	QPSK	1/25	H	15.96	6.19	22.15	0.164	-
		16QAM	1/25	H	15.24	6.19	21.43	0.139	-
		64QAM	1/25	H	14.30	6.19	20.49	0.112	-
		QPSK	1/25	H	15.01	6.19	21.20	0.132	With Dual Display (180°)
5	2593	QPSK	1/12	H	15.72	6.19	21.91	0.155	-
		16QAM	1/12	H	15.19	6.19	21.38	0.137	-
		64QAM	1/12	H	14.26	6.19	20.45	0.111	-

**7.5.9LTE Band 7**
**- Measurement data: Without wireless charging pad**

Channel Bandwidth (MHz)	Test Frequency (MHz)	Test Mode	RB Size/ Offset	Ant Pol (H/V)	Level(dBm) @ Ant Terminal	TX Ant Gain (dBi)	EIRP (dBm)	EIRP (W)	Note
20	2510	QPSK	1/50	H	15.08	5.94	21.02	0.126	-
		16QAM	1/50	H	14.17	5.94	20.11	0.103	-
		64QAM	1/50	H	13.05	5.94	18.99	0.079	-
	2535	QPSK	1/50	H	15.46	6.04	21.50	0.141	-
		16QAM	1/50	H	14.89	6.04	20.93	0.124	-
		64QAM	1/50	H	13.91	6.04	19.95	0.099	-
	2560	QPSK	1/99	H	15.91	6.12	22.03	0.160	-
		16QAM	1/99	H	15.27	6.12	21.39	0.138	-
		64QAM	1/99	H	14.28	6.12	20.40	0.110	-
		QPSK	1/99	H	15.49	6.12	21.61	0.145	With Dual Display (180°)
15	2507.5	QPSK	1/36	H	15.59	5.93	21.52	0.142	-
		16QAM	1/36	H	15.01	5.93	20.94	0.124	-
		64QAM	1/36	H	13.94	5.93	19.87	0.097	-
	2535	QPSK	1/36	H	15.90	6.04	21.94	0.156	-
		16QAM	1/36	H	15.27	6.04	21.31	0.135	-
		64QAM	1/36	H	13.91	6.04	19.95	0.099	-
	2562.5	QPSK	1/36	H	15.64	6.13	21.77	0.150	-
		16QAM	1/36	H	15.00	6.13	21.13	0.130	-
		64QAM	1/36	H	13.79	6.13	19.92	0.098	-
10	2505	QPSK	1/25	H	15.07	5.92	20.99	0.126	-
		16QAM	1/25	H	14.22	5.92	20.14	0.103	-
		64QAM	1/25	H	13.07	5.92	18.99	0.079	-
	2535	QPSK	1/25	H	15.73	6.04	21.77	0.150	-
		16QAM	1/25	H	15.13	6.04	21.17	0.131	-
		64QAM	1/25	H	14.00	6.04	20.04	0.101	-
	2565	QPSK	1/25	H	15.19	6.13	21.32	0.136	-
		16QAM	1/25	H	14.55	6.13	20.68	0.117	-
		64QAM	1/25	H	13.34	6.13	19.47	0.089	-
5	2502.5	QPSK	1/12	H	15.85	5.91	21.76	0.150	-
		16QAM	1/12	H	15.08	5.91	20.99	0.126	-
		64QAM	1/12	H	13.87	5.91	19.78	0.095	-
	2535	QPSK	1/12	H	15.64	6.04	21.68	0.147	-
		16QAM	1/12	H	14.78	6.04	20.82	0.121	-
		64QAM	1/12	H	13.88	6.04	19.92	0.098	-
	2567.5	QPSK	1/12	H	15.85	6.14	21.99	0.158	-
		16QAM	1/12	H	14.99	6.14	21.13	0.130	-
		64QAM	1/12	H	14.16	6.14	20.30	0.107	-

**- Measurement data: With wireless charging pad**

Channel Bandwidth (MHz)	Test Frequency (MHz)	Test Mode	RB Size/Offset	Ant Pol (H/V)	Level(dBm) @ Ant Terminal	TX Ant Gain (dBi)	EIRP (dBm)	EIRP (W)	Note
20	2560	QPSK	1/99	H	15.43	6.12	21.55	0.143	-
		16QAM	1/99	H	14.72	6.12	20.84	0.121	-
		64QAM	1/99	H	13.96	6.12	20.08	0.102	-
		QPSK	1/99	H	16.05	6.12	22.17	0.165	With Dual Display (180°)
15	2535	QPSK	1/36	H	15.35	6.04	21.39	0.138	-
		16QAM	1/36	H	14.79	6.04	20.83	0.121	-
		64QAM	1/36	H	13.54	6.04	19.58	0.091	-
10	2535	QPSK	1/25	H	15.32	6.04	21.36	0.137	-
		16QAM	1/25	H	14.64	6.04	20.68	0.117	-
		64QAM	1/25	H	13.45	6.04	19.49	0.089	-
5	2567.5	QPSK	1/12	H	15.39	6.14	21.53	0.142	-
		16QAM	1/12	H	14.63	6.14	20.77	0.119	-
		64QAM	1/12	H	13.68	6.14	19.82	0.096	-

## 7.6 UNDESIRABLE EMISSIONS (Radiated)

### - Test Notes

- 1) This device was tested under all bandwidths, modulations and RB configurations and the worst case data are reported.
- 2) The frequency spectrum is examined from 9 kHz to the 10th harmonic of the fundamental frequency of the transmitter.  
No other spurious and harmonic emissions were reported greater than listed emissions.
- 3) Limit Calculation for Band 2/4/5/12/13/17/25/26/66 =  $43 + 10\log_{10}(P[\text{Watts}])$
- 4) Limit Calculation for Band 7/41 =  $55 + 10\log_{10}(P[\text{Watts}])$
- 5) Limit Calculation for 1559~1610MHz in Band 13 =  $-70 \text{ dBW/MHz}$  (equivalent isotropically radiated power for wideband signals)

### 7.6.1 LTE Band 12, 17

#### - Measurement data: Without wireless charging pad

B.W (MHz)	Test Freq. (MHz)	RB Size/ Offset	Test Mode	Freq.(MHz)	Ant Pol (H/V)	Level(dBm) @ Ant Terminal	TX Ant Gain(dBd)	Result		Limit (dBc)	Note
								(dBm)	(dBc)		
10	704	1/25	QPSK	1407.26	V	-56.88	2.48	-54.40	75.34	33.94	-
			16QAM	1407.14	V	-56.55	2.48	-54.07	73.82	32.75	-
			64QAM	1407.61	V	-56.55	2.48	-54.07	72.57	31.50	-
	711	1/0	QPSK	1412.34	V	-56.45	2.50	-53.95	74.58	33.63	-
			16QAM	1411.67	V	-56.42	2.50	-53.92	73.28	32.26	-
			64QAM	1412.06	V	-56.34	2.50	-53.84	72.06	31.22	-
5	701.5	1/24	QPSK	1409.06	V	-56.80	2.49	-54.31	75.47	34.16	-
			16QAM	1407.97	V	-56.97	2.48	-54.49	74.11	32.62	-
			64QAM	1408.33	V	-56.81	2.48	-54.33	72.99	31.66	-
			QPSK	1409.18	V	-57.12	2.49	-54.63	74.73	33.10	With Dual Display (180°)

#### - Measurement data: With wireless charging pad

B.W (MHz)	Test Freq. (MHz)	RB Size/ Offset	Test Mode	Freq.(MHz)	Ant Pol (H/V)	Level(dBm) @ Ant Terminal	TX Ant Gain(dBd)	Result		Limit (dBc)	Note
								(dBm)	(dBc)		
10	704	1/25	QPSK	1407.54	V	-57.90	2.48	-55.42	75.60	33.18	-
5	701.5	1/24	QPSK	1407.66	V	-57.28	2.48	-54.80	73.59	31.79	With Dual Display (180°)



## 7.6.2 LTE Band 13

### - Measurement data: Without wireless charging pad

B.W (MHz)	Test Freq. (MHz)	RB Size/ Offset	Test Mode	Freq.(MHz)	Ant Pol (H/V)	Level(dBm) @ Ant Terminal	TX Ant Gain(dBd)	Result		Limit (dBc)	Note
								(dBm)	(dBc)		
10	782	1/0	QPSK	1553.44	V	-58.30	4.18	-54.12	73.79	32.67	-
			16QAM	1553.76	V	-58.47	4.18	-54.29	72.46	31.17	-
			64QAM	1555.34	V	-58.23	4.19	-54.04	71.13	30.09	-
			QPSK	1554.39	V	-57.78	4.19	-53.59	71.36	30.77	With Dual Display (180°)

### - Measurement data: With wireless charging pad

B.W (MHz)	Test Freq. (MHz)	RB Size/ Offset	Test Mode	Freq.(MHz)	Ant Pol (H/V)	Level(dBm) @ Ant Terminal	TX Ant Gain(dBd)	Result		Limit (dBc)	Note
								(dBm)	(dBc)		
10	782	1/0	QPSK	1553.71	V	-58.59	4.18	-54.41	73.85	32.44	-
				1553.87	V	-58.04	4.18	-53.86	71.49	30.63	With Dual Display (180°)

## UNDESIRABLE EMISSIONS IN 1559~1610MHz (LTE Band 13)

### - Measurement data: Without wireless charging pad

B.W (MHz)	Test Freq. (MHz)	RB Size/ Offset	Test Mode	Freq.(MHz)	Ant Pol (H/V)	Level(dBm) @ Ant Terminal	TX Ant Gain(dBd)	Result	Margin	Limit (dBm/MHz)	Note
								(dBm)	(dB)		
10	782	1/25	QPSK	1563.92	V	-58.24	6.41	-51.83	11.83	-40.00	-
				1562.55	V	-58.12	6.40	-51.72	11.72	-40.00	With Dual Display (180°)

### - Measurement data: With wireless charging pad

B.W (MHz)	Test Freq. (MHz)	RB Size/ Offset	Test Mode	Freq.(MHz)	Ant Pol (H/V)	Level(dBm) @ Ant Terminal	TX Ant Gain(dBd)	Result	Margin	Limit (dBm/MHz)	Note
								(dBm)	(dB)		
10	782	1/25	QPSK	1563.17	V	-58.37	6.41	-51.96	11.96	-40.00	-
				1562.88	V	-57.95	6.40	-51.55	11.55	-40.00	With Dual Display (180°)

### 7.6.3 LTE Band 5, 26

#### - Measurement data: Without wireless charging pad

B.W (MHz)	Test Freq. (MHz)	RB Size/ Offset	Test Mode	Freq.(MHz)	Ant Pol (H/V)	Level(dBm) @ Ant Terminal	TX Ant Gain(dBd)	Result		Limit (dBc)	Note
								(dBm)	(dBc)		
15	831.5	1/36	QPSK	1662.57	V	-55.85	3.87	-51.98	72.61	33.63	-
			16QAM	1662.98	V	-55.65	3.86	-51.79	71.31	32.52	-
			64QAM	1662.21	V	-55.89	3.88	-52.01	70.37	31.36	-
	841.5	1/36	QPSK	1684.42	V	-55.29	3.39	-51.90	71.42	32.52	-
			16QAM	1682.27	V	-55.29	3.44	-51.85	70.45	31.60	-
			64QAM	1684.46	V	-55.54	3.39	-52.15	69.81	30.66	-
10	836.5	1/0	QPSK	1661.81	V	-55.59	3.89	-51.70	72.62	33.92	-
			16QAM	1662.93	V	-55.52	3.87	-51.65	71.45	32.80	-
			64QAM	1662.21	V	-55.80	3.88	-51.92	70.80	31.88	-
			QPSK	1663.37	V	-56.12	3.86	-52.26	69.89	30.63	With Dual Display (180°)

#### - Measurement data: With wireless charging pad

B.W (MHz)	Test Freq. (MHz)	RB Size/ Offset	Test Mode	Freq.(MHz)	Ant Pol (H/V)	Level(dBm) @ Ant Terminal	TX Ant Gain(dBd)	Result		Limit (dBc)	Note
								(dBm)	(dBc)		
15	831.5	1/36	QPSK	1662.84	V	-55.41	3.87	-51.54	72.14	33.60	-
10	836.5	1/0	QPSK	1662.80	V	-55.99	3.87	-52.12	67.28	28.16	With Dual Display (180°)
3	825.5	1/7	QPSK	1652.04	V	-55.42	4.11	-51.31	72.76	34.45	-

**7.6.4 LTE Band 66, 4**
**- Measurement data: Without wireless charging pad**

B.W (MHz)	Test Freq. (MHz)	RB Size/ Offset	Test Mode	Freq.(MHz)	Ant Pol (H/V)	Level(dBm) @ Ant Terminal	TX Ant Gain(dBi)	Result		Limit (dBc)	Note
								(dBm)	(dBc)		
20	1720	1/50	QPSK	3440.04	H	-46.96	7.78	-39.18	59.79	33.61	-
				5160.23	V	-44.79	10.32	-34.47	55.08		-
				6880.33	H	-33.84	11.30	-22.54	43.15		-
				8599.99	V	-45.36	13.20	-32.16	52.77		-
			16QAM	3440.21	H	-45.98	7.78	-38.20	58.06	32.86	-
				5160.52	V	-43.72	10.32	-33.40	53.26		-
				6880.74	H	-33.76	11.30	-22.46	42.32		-
				8600.84	V	-45.58	13.20	-32.38	52.24		-
			64QAM	3440.25	H	-45.69	7.78	-37.91	56.87	31.96	-
				5160.35	V	-43.16	10.32	-32.84	51.80		-
				6880.50	H	-34.16	11.30	-22.86	41.82		-
				8600.15	V	-46.33	13.20	-33.13	52.09		-
	1745	1/50	QPSK	3490.08	H	-44.64	7.88	-36.76	57.88	34.12	-
				5235.30	V	-41.37	10.33	-31.04	52.16		-
				6980.50	H	-33.19	11.46	-21.73	42.85		-
				8725.61	V	-43.94	13.30	-30.64	51.76		-
			16QAM	3490.26	H	-44.50	7.88	-36.62	56.93	33.31	-
				5235.11	V	-41.23	10.33	-30.90	51.21		-
				6980.32	H	-33.08	11.46	-21.62	41.93		-
				8725.40	V	-43.85	13.30	-30.55	50.86		-
			64QAM	3490.32	H	-44.73	7.88	-36.85	56.20	32.35	-
				5235.74	V	-41.94	10.33	-31.61	50.96		-
				6980.84	H	-33.51	11.46	-22.05	41.40		-
				8725.33	V	-44.46	13.30	-31.16	50.51		-
1770	1/99	QPSK	3557.89	H	-45.02	8.10	-36.92	58.58	34.66	-	
			5336.65	V	-42.31	10.47	-31.84	53.50		-	
			7115.67	H	-33.42	11.63	-21.79	43.45		-	
			8894.53	V	-43.97	13.20	-30.77	52.43		-	
		16QAM	3557.71	H	-44.91	8.10	-36.81	57.81	34.00	-	
			5336.78	V	-40.85	10.47	-30.38	51.38		-	
			7115.61	H	-32.75	11.63	-21.12	42.12		-	
			8894.48	V	-43.54	13.20	-30.34	51.34		-	
		64QAM	3557.84	H	-45.12	8.10	-37.02	56.97	32.95	-	
			5336.78	V	-40.92	10.47	-30.45	50.40		-	
			7115.85	H	-32.33	11.63	-20.70	40.65		-	
			8894.54	V	-44.42	13.20	-31.22	51.17		-	

**- Measurement data: Without wireless charging pad**

B.W (MHz)	Test Freq. (MHz)	RB Size/ Offset	Test Mode	Freq.(MHz)	Ant Pol (H/V)	Level(dBm) @ Ant Terminal	TX Ant Gain(dBi)	Result		Limit (dBc)	Note
								(dBm)	(dBc)		
5	1777.5	1/12	QPSK	3554.96	H	-44.99	8.10	-36.89	59.14	35.25	-
				5332.50	V	-43.11	10.46	-32.65	54.90		-
				7110.25	H	-32.85	11.62	-21.23	43.48		-
				8887.53	V	-44.11	13.20	-30.91	53.16		-
			QPSK	3553.75	H	-49.41	8.10	-41.31	62.99	34.68	With Dual Display (180°)
				5332.47	V	-46.91	10.46	-36.45	58.13		
				7110.72	H	-37.54	11.62	-25.92	47.60		
				8886.69	V	-47.35	13.20	-34.15	55.83		
			16QAM	3554.78	H	-44.91	8.10	-36.81	58.42	34.61	-
				5332.58	V	-43.00	10.47	-32.53	54.14		-
				7110.07	H	-32.00	11.62	-20.38	41.99		-
				8887.45	V	-43.66	13.20	-30.46	52.07		-
			64QAM	3554.92	H	-45.44	8.10	-37.34	57.94	33.60	-
				5332.42	V	-42.59	10.46	-32.13	52.73		-
				7110.17	H	-31.50	11.62	-19.88	40.48		-
				8887.40	V	-44.43	13.20	-31.23	51.83		-

**- Measurement data: With wireless charging pad**

B.W (MHz)	Test Freq. (MHz)	RB Size/ Offset	Test Mode	Freq.(MHz)	Ant Pol (H/V)	Level(dBm) @ Ant Terminal	TX Ant Gain(dBi)	Result		Limit (dBc)	Note
								(dBm)	(dBc)		
20	1770	1/99	QPSK	3558.39	H	-47.11	8.10	-39.01	58.80	32.79	-
				5337.03	V	-42.21	10.47	-31.74	51.53		-
				7116.47	V	-37.79	11.63	-26.16	45.95		-
				8895.13	V	-44.57	13.20	-31.37	51.16		-
5	1777.5	1/12	QPSK	3555.26	H	-47.33	8.10	-39.23	59.70	33.47	-
				5331.91	V	-42.36	10.46	-31.90	52.37		-
				7110.74	V	-37.99	11.62	-26.37	46.84		-
				8888.11	V	-44.39	13.20	-31.19	51.66		-
			QPSK	3555.12	H	-50.56	8.10	-42.46	62.48	33.02	With Dual Display (180°)
				5333.32	V	-44.62	10.47	-34.15	54.17		
				7110.81	V	-41.18	11.62	-29.56	49.58		

**7.6.5 LTE Band 25, 2**
**- Measurement data: Without wireless charging pad**

B.W (MHz)	Test Freq. (MHz)	RB Size/ Offset	Test Mode	Freq.(MHz)	Ant Pol (H/V)	Level(dBm) @ Ant Terminal	TX Ant Gain(dBi)	Result		Limit (dBc)	Note
								(dBm)	(dBc)		
20	1860	1/50	QPSK	3720.25	H	-50.46	8.34	-42.12	63.27	34.15	-
				5580.21	H	-47.10	10.68	-36.42	57.57		-
			16QAM	3720.22	H	-47.41	8.34	-39.07	59.57	33.50	-
				5580.37	H	-46.44	10.68	-35.76	56.26		-
			64QAM	3720.16	H	-46.99	8.34	-38.65	58.17	32.52	-
				5580.26	H	-46.48	10.68	-35.80	55.32		-
	1882.5	1/50	QPSK	3764.98	H	-53.18	8.43	-44.75	65.83	34.08	-
				5647.64	H	-48.80	10.70	-38.10	59.18		-
			16QAM	3765.16	H	-52.40	8.43	-43.97	64.29	33.32	-
				5647.84	H	-46.74	10.70	-36.04	56.36		-
			64QAM	3764.87	H	-52.37	8.43	-43.94	63.36	32.42	-
				5647.56	H	-47.29	10.70	-36.59	56.01		-
	1905	1/50	QPSK	3810.28	H	-52.86	8.50	-44.36	66.33	34.97	-
				5715.35	H	-47.63	10.60	-37.03	59.00		-
			16QAM	3809.69	H	-52.83	8.50	-44.33	65.54	34.21	-
				5715.33	H	-47.81	10.60	-37.21	58.42		-
			64QAM	3810.57	H	-53.29	8.50	-44.79	65.12	33.33	-
				5715.32	H	-47.49	10.60	-36.89	57.22		-
QPSK	3808.92	H	-53.27	8.50	-44.77	66.11	34.34	With Dual Display (180°)			
	5715.74	H	-49.39	10.60	-38.79	60.13					

**- Measurement data: With wireless charging pad**

B.W (MHz)	Test Freq. (MHz)	RB Size/ Offset	Test Mode	Freq.(MHz)	Ant Pol (H/V)	Level(dBm) @ Ant Terminal	TX Ant Gain(dBi)	Result		Limit (dBc)	Note
								(dBm)	(dBc)		
20	1905	1/50	QPSK	3809.64	H	-53.17	8.50	-44.67	66.03	34.36	-
				5715.02	V	-50.58	10.60	-39.98	61.34		-
			QPSK	3808.88	H	-53.56	8.50	-45.06	65.50	33.44	With Dual Display (180°)
				5715.61	V	-50.46	10.60	-39.86	60.30		

**7.6.6 LTE Band 41**
**- Measurement data: Without wireless charging pad**

B.W (MHz)	Test Freq. (MHz)	RB Size/ Offset	Test Mode	Freq.(MHz)	Ant Pol (H/V)	Level(dBm) @ Ant Terminal	TX Ant Gain(dBi)	Result		Limit (dBc)	Note
								(dBm)	(dBc)		
20	2506	1/50	QPSK	5010.66	H	-52.12	10.22	-41.90	62.95	46.05	-
				7518.01	H	-49.26	12.14	-37.12	58.17		-
			16QAM	5011.18	H	-52.16	10.22	-41.94	62.37	45.43	-
				7516.70	H	-48.90	12.13	-36.77	57.20		-
			64QAM	5012.64	H	-52.10	10.23	-41.87	61.46	44.59	-
				7519.41	H	-48.84	12.14	-36.70	56.29		-
	2593	1/50	QPSK	5186.35	H	-51.94	10.37	-41.57	63.29	46.72	-
				7778.62	H	-49.49	12.30	-37.19	58.91		-
			16QAM	5186.34	H	-52.29	10.37	-41.92	63.09	46.17	-
				7780.31	H	-49.19	12.30	-36.89	58.06		-
			64QAM	5187.02	H	-52.00	10.37	-41.63	61.98	45.35	-
				7779.95	H	-49.29	12.30	-36.99	57.34		-
	2680	1/50	QPSK	5359.38	H	-52.02	10.48	-41.54	62.81	46.27	-
				8041.42	H	-49.59	12.58	-37.01	58.28		-
			16QAM	5359.55	H	-52.09	10.48	-41.61	62.23	45.62	-
				8039.44	H	-49.23	12.58	-36.65	57.27		-
64QAM			5361.39	H	-51.60	10.48	-41.12	61.30	45.18	-	
			8038.70	H	-49.30	12.58	-36.72	56.90		-	
10	2593	1/25	QPSK	5186.13	H	-52.60	10.37	-42.23	64.58	47.35	-
				7779.57	H	-49.15	12.30	-36.85	59.19		-
			16QAM	5185.84	H	-51.91	10.37	-41.54	63.11	46.57	-
				7780.35	H	-49.38	12.30	-37.08	58.65		-
			64QAM	5185.17	H	-51.90	10.37	-41.53	62.21	45.68	-
				7779.67	H	-49.26	12.30	-36.96	57.64		-
			QPSK	5185.84	H	-51.93	10.37	-41.56	63.19	46.63	With Dual Display (180°)

**- Measurement data: With wireless charging pad**

B.W (MHz)	Test Freq. (MHz)	RB Size/ Offset	Test Mode	Freq.(MHz)	Ant Pol (H/V)	Level(dBm) @ Ant Terminal	TX Ant Gain(dBi)	Result		Limit (dBc)	Note
								(dBm)	(dBc)		
20	2593	1/50	QPSK	5185.36	H	-51.99	10.37	-41.62	63.22	46.60	-
10	2593	1/25	QPSK	5184.57	H	-51.78	10.37	-41.41	63.56	47.15	-
			QPSK	5185.57	H	-52.19	10.37	-41.82	63.02	46.20	With Dual Display (180°)



**7.6.7 LTE Band 7**
**- Measurement data: Without wireless charging pad**

B.W (MHz)	Test Freq. (MHz)	RB Size/ Offset	Test Mode	Freq.(MHz)	Ant Pol (H/V)	Level(dBm) @ Ant Terminal	TX Ant Gain(dBi)	Result		Limit (dBc)	Note
								(dBm)	(dBc)		
20	2510	1/50	QPSK	5020.98	V	-52.98	10.24	-42.74	63.76	46.02	-
				7530.87	V	-48.36	12.16	-36.20	57.22		-
			16QAM	5021.26	V	-52.99	10.24	-42.75	62.86	45.11	-
				7531.34	V	-48.42	12.16	-36.26	56.37		-
			64QAM	5018.64	V	-52.79	10.24	-42.55	61.54	43.99	-
				7530.32	V	-48.51	12.16	-36.35	55.34		-
	2535	1/50	QPSK	5069.56	V	-53.22	10.30	-42.92	64.42	46.50	-
				7605.63	V	-48.52	12.20	-36.32	57.82		-
			16QAM	5068.87	V	-53.25	10.30	-42.95	63.88	45.93	-
				7605.78	V	-48.53	12.20	-36.33	57.26		-
			64QAM	5069.74	V	-52.91	10.30	-42.61	62.56	44.95	-
				7603.52	V	-48.64	12.20	-36.44	56.39		-
	2560	1/99	QPSK	5140.07	V	-53.14	10.30	-42.84	64.87	47.03	-
				7710.30	V	-48.63	12.22	-36.41	58.44		-
			16QAM	5139.04	V	-53.35	10.30	-43.05	64.44	46.39	-
				7711.16	V	-48.76	12.22	-36.54	57.93		-
			64QAM	5139.11	V	-52.74	10.30	-42.44	62.84	45.40	-
				7711.84	V	-48.76	12.22	-36.54	56.94		-
QPSK	5139.08	V	-52.66	10.30	-42.36	63.97	46.61	With Dual Display (180°)			

**- Measurement data: With wireless charging pad**

B.W (MHz)	Test Freq. (MHz)	RB Size/ Offset	Test Mode	Freq.(MHz)	Ant Pol (H/V)	Level(dBm) @ Ant Terminal	TX Ant Gain(dBi)	Result		Limit (dBc)	Note
								(dBm)	(dBc)		
20	2560	1/99	QPSK	5141.36	V	-52.85	10.30	-42.55	64.10	46.55	-
				7710.54	V	-48.85	12.22	-36.63	58.18		-
			QPSK	5139.26	V	-52.58	10.30	-42.28	64.45	47.17	With Dual Display (180°)

## 7.7 FREQUENCY STABILITY

### - Test Notes

Based on the results of the frequency stability test at the center channel the frequency deviation results measured are very small. As such it is determined that the channels at the band edge would remain in-band when the maximum measured frequency deviation noted during the frequency stability tests is applied. Therefore the device is determined to remain operating in band over the temperature and voltage range as tested.

### 7.7.1 LTE Band 12, 17

OPERATING FREQUENCY : 707.5 MHz  
 REFERENCE VOLTAGE : 3.87 VDC  
 LIMIT : The frequency stability shall be sufficient to ensure that the fundamental emission stays within the authorized frequency block.

VOLTAGE (%)	POWER (V DC)	TEMP (°C)	FREQUENCY (Hz)	FREQ.Dev (Hz)	Deviation	
					(ppm)	(%)
100%	3.87	+20(Ref)	707,500,008	8	0.0113	0.000001131
100%		-30	707,500,009	9	0.0127	0.000001272
100%		-20	707,500,011	11	0.0155	0.000001555
100%		-10	707,499,990	-10	-0.0141	-0.000001413
100%		0	707,499,986	-14	-0.0198	-0.000001979
100%		+10	707,499,984	-16	-0.0226	-0.000002261
100%		+20	707,500,008	8	0.0113	0.000001131
100%		+30	707,499,993	-7	-0.0099	-0.000000989
100%		+40	707,500,008	8	0.0113	0.000001131
100%		+50	707,500,005	5	0.0071	0.000000707
115%		4.45	+20	707,500,006	6	0.0085
BATT.ENDPOINT	3.10	+20	707,499,990	-10	-0.0141	-0.000001413

**7.7.2 LTE Band 13**

OPERATING FREQUENCY : 782 MHz  
 REFERENCE VOLTAGE : 3.87 VDC  
 LIMIT : The frequency stability shall be sufficient to ensure that the fundamental emission stays within the authorized frequency block.

VOLTAGE (%)	POWER (V DC)	TEMP (°C)	FREQUENCY (Hz)	FREQ.Dev (Hz)	Deviation	
					(ppm)	(%)
100%	3.87	+20(Ref)	782,000,006	6	0.0077	0.000000767
100%		-30	782,000,012	12	0.0153	0.000001535
100%		-20	781,999,989	-11	-0.0141	-0.000001407
100%		-10	781,999,995	-5	-0.0064	-0.000000639
100%		0	782,000,010	10	0.0128	0.000001279
100%		+10	782,000,008	8	0.0102	0.000001023
100%		+20	782,000,006	6	0.0077	0.000000767
100%		+30	781,999,991	-9	-0.0115	-0.000001151
100%		+40	781,999,992	-8	-0.0102	-0.000001023
100%		+50	781,999,988	-12	-0.0153	-0.000001535
115%		4.45	+20	782,000,008	8	0.0102
BATT.ENDPOINT	3.10	+20	781,999,992	-8	-0.0102	-0.000001023

**7.7.3 LTE Band 5, 26**

OPERATING FREQUENCY : 836.5 MHz  
 REFERENCE VOLTAGE : 3.87 VDC  
 DEVIATION LIMIT :  $\pm 0.00025\%$  or 2.5 ppm

VOLTAGE (%)	POWER (V DC)	TEMP (°C)	FREQUENCY (Hz)	FREQ.Dev (Hz)	Deviation	
					(ppm)	(%)
100%	3.87	+20(Ref)	836,500,006	6	0.0072	0.000000717
100%		-30	836,499,988	-12	-0.0143	-0.000001435
100%		-20	836,499,992	-8	-0.0096	-0.000000956
100%		-10	836,499,990	-10	-0.0120	-0.000001195
100%		0	836,499,993	-7	-0.0084	-0.000000837
100%		+10	836,500,008	8	0.0096	0.000000956
100%		+20	836,500,006	6	0.0072	0.000000717
100%		+30	836,500,009	9	0.0108	0.000001076
100%		+40	836,500,013	13	0.0155	0.000001554
100%		+50	836,500,008	8	0.0096	0.000000956
115%		4.45	+20	836,499,990	-10	-0.0120
BATT.ENDPOINT	3.10	+20	836,499,989	-11	-0.0132	-0.000001315

**7.7.4 LTE Band 66, 4**

OPERATING FREQUENCY : 1745.0 MHz  
 REFERENCE VOLTAGE : 3.87 VDC  
 LIMIT : The frequency stability shall be sufficient to ensure that the fundamental emission stays within the authorized frequency block.

VOLTAGE (%)	POWER (V DC)	TEMP (°C)	FREQUENCY (Hz)	FREQ.Dev (Hz)	Deviation	
					(ppm)	(%)
100%	3.87	+20(Ref)	1,745,000,006	6	0.0034	0.000000344
100%		-30	1,745,000,008	8	0.0046	0.000000458
100%		-20	1,744,999,987	-13	-0.0074	-0.000000745
100%		-10	1,744,999,992	-8	-0.0046	-0.000000458
100%		0	1,744,999,989	-11	-0.0063	-0.000000630
100%		+10	1,744,999,990	-10	-0.0057	-0.000000573
100%		+20	1,745,000,006	6	0.0034	0.000000344
100%		+30	1,745,000,008	8	0.0046	0.000000458
100%		+40	1,745,000,010	10	0.0057	0.000000573
100%		+50	1,744,999,989	-11	-0.0063	-0.000000630
115%	4.45	+20	1,744,999,988	-12	-0.0069	-0.000000688
BATT.ENDPOINT	3.10	+20	1,744,999,990	-10	-0.0057	-0.000000573

**7.7.5 LTE Band 25, 2**

OPERATING FREQUENCY : 1882.5 MHz  
 REFERENCE VOLTAGE : 3.87 VDC  
 LIMIT : The frequency stability shall be sufficient to ensure that the fundamental emission stays within the authorized frequency block.

VOLTAGE (%)	POWER (V DC)	TEMP (°C)	FREQUENCY (Hz)	FREQ.Dev (Hz)	Deviation	
					(ppm)	(%)
100%	3.87	+20(Ref)	1,882,499,992	-8	-0.0042	-0.000000425
100%		-30	1,882,500,010	10	0.0053	0.000000531
100%		-20	1,882,499,994	-6	-0.0032	-0.000000319
100%		-10	1,882,500,010	10	0.0053	0.000000531
100%		0	1,882,499,992	-8	-0.0042	-0.000000425
100%		+10	1,882,500,014	14	0.0074	0.000000744
100%		+20	1,882,499,992	-8	-0.0042	-0.000000425
100%		+30	1,882,499,987	-13	-0.0069	-0.000000691
100%		+40	1,882,499,989	-11	-0.0058	-0.000000584
100%		+50	1,882,500,007	7	0.0037	0.000000372
115%		4.45	+20	1,882,500,011	11	0.0058
BATT.ENDPOINT	3.10	+20	1,882,499,987	-13	-0.0069	-0.000000691

**7.7.6 LTE Band 41**

OPERATING FREQUENCY : 2593 MHz  
 REFERENCE VOLTAGE : 3.87 VDC  
 LIMIT : The frequency stability shall be sufficient to ensure that the fundamental emission stays within the authorized frequency block.

VOLTAGE (%)	POWER (V DC)	TEMP (°C)	FREQUENCY (Hz)	FREQ.Dev (Hz)	Deviation	
					(ppm)	(%)
100%	3.87	+20(Ref)	2,593,000,013	13	0.0050	0.000000501
100%		-30	2,593,000,008	8	0.0031	0.000000309
100%		-20	2,592,999,993	-7	-0.0027	-0.000000270
100%		-10	2,592,999,994	-6	-0.0023	-0.000000231
100%		0	2,592,999,990	-10	-0.0039	-0.000000386
100%		+10	2,592,999,991	-9	-0.0035	-0.000000347
100%		+20	2,593,000,013	13	0.0050	0.000000501
100%		+30	2,593,000,014	14	0.0054	0.000000540
100%		+40	2,592,999,989	-11	-0.0042	-0.000000424
100%		+50	2,592,999,990	-10	-0.0039	-0.000000386
115%	4.45	+20	2,593,000,013	13	0.0050	0.000000501
BATT.ENDPOINT	3.10	+20	2,592,999,990	-10	-0.0039	-0.000000386

**7.7.7 LTE Band 7**

OPERATING FREQUENCY : 2535 MHz  
 REFERENCE VOLTAGE : 3.87 VDC  
 LIMIT : The frequency stability shall be sufficient to ensure that the fundamental emission stays within the authorized frequency block.

VOLTAGE (%)	POWER (V DC)	TEMP (°C)	FREQUENCY (Hz)	FREQ.Dev (Hz)	Deviation	
					(ppm)	(%)
100%	3.87	+20(Ref)	2,535,000,010	10	0.0039	0.000000394
100%		-30	2,534,999,985	-15	-0.0059	-0.000000592
100%		-20	2,534,999,989	-11	-0.0043	-0.000000434
100%		-10	2,534,999,986	-14	-0.0055	-0.000000552
100%		0	2,534,999,991	-9	-0.0036	-0.000000355
100%		+10	2,534,999,990	-10	-0.0039	-0.000000394
100%		+20	2,535,000,010	10	0.0039	0.000000394
100%		+30	2,535,000,012	12	0.0047	0.000000473
100%		+40	2,534,999,992	-8	-0.0032	-0.000000316
100%		+50	2,534,999,987	-13	-0.0051	-0.000000513
115%	4.45	+20	2,535,000,007	7	0.0028	0.000000276
BATT.ENDPOINT	3.10	+20	2,534,999,985	-15	-0.0059	-0.000000592



## 8. TEST PLOTS

### - Test Notes:

All bandwidths, RB configurations, and modulations were investigated. The worst case test results are reported.

### 8.1 OCCUPIED BANDWIDTH

#### 8.1.1 LTE Band 12, 17

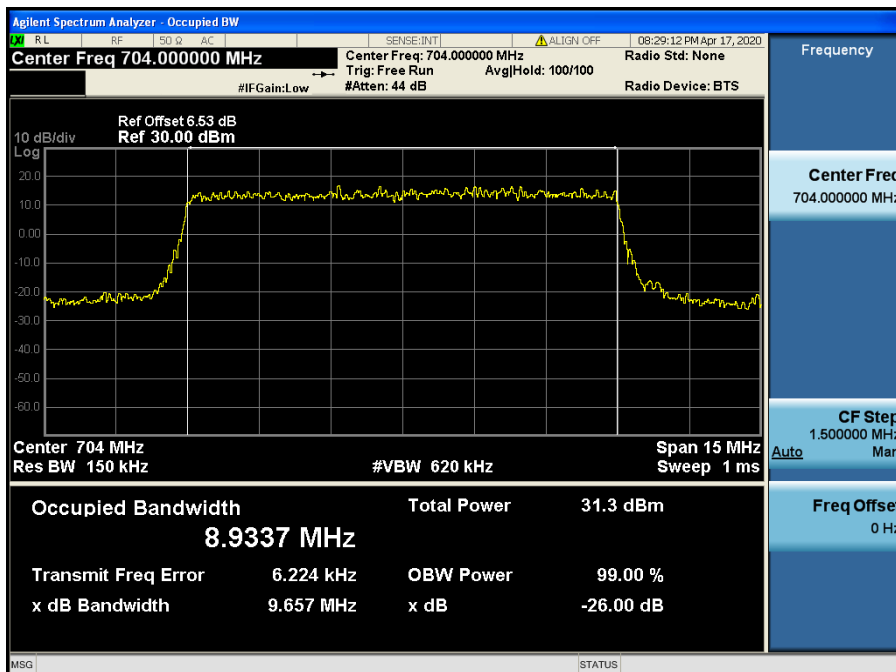

LTE Band 12, 17 / 10 MHz / QPSK - RB Size 50

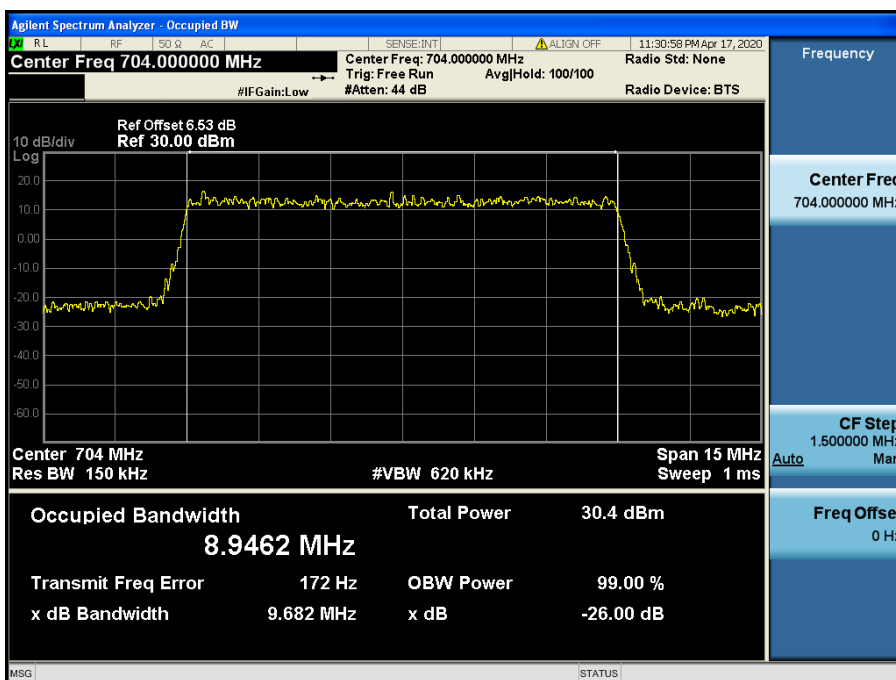

LTE Band 12, 17 / 10 MHz / 16QAM - RB Size 50

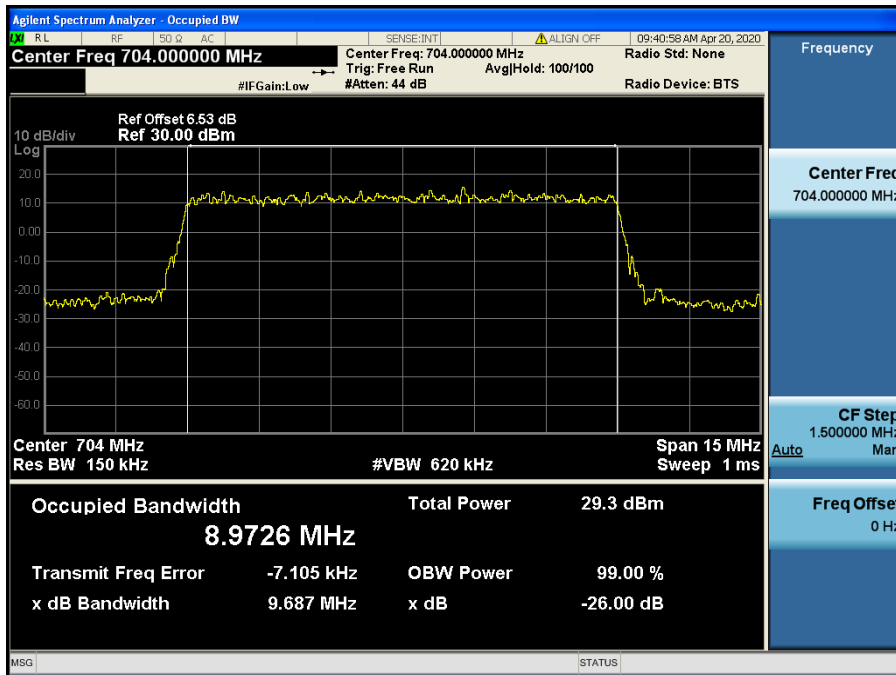

LTE Band 12, 17 / 10 MHz / 64QAM- RB Size 50

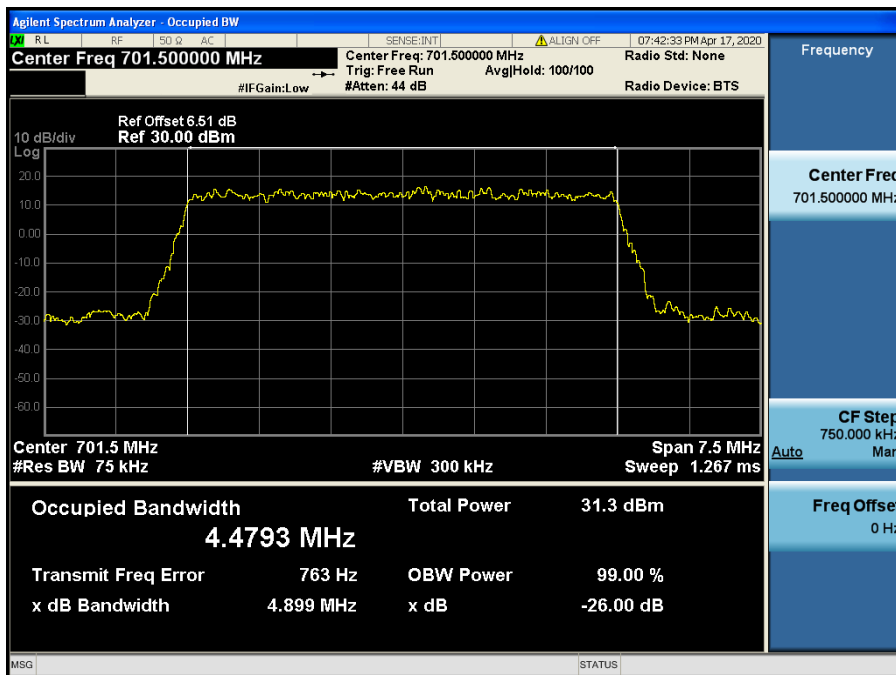

LTE Band 12, 17 / 5 MHz / QPSK - RB Size 25

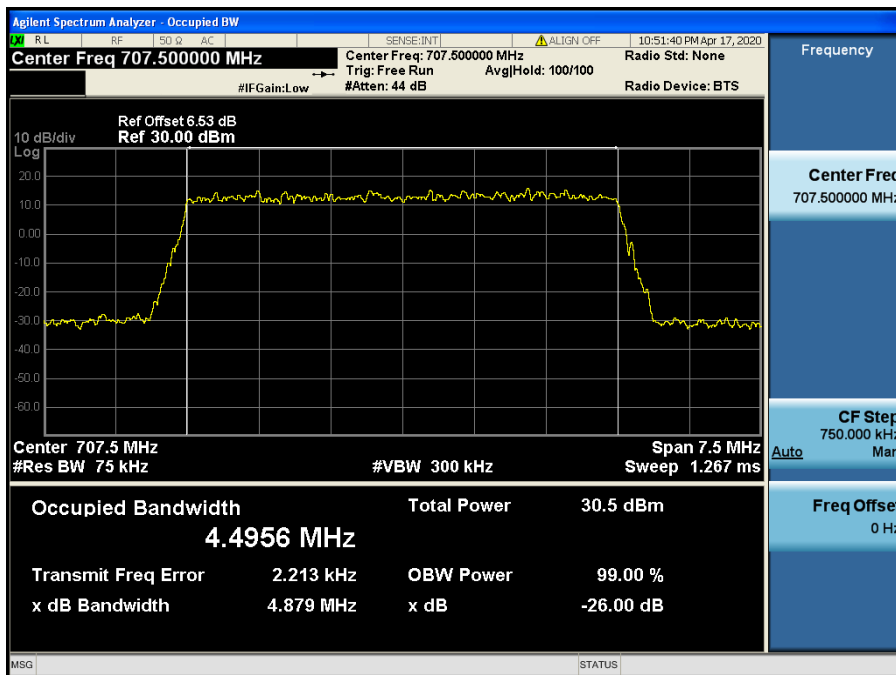

LTE Band 12, 17 / 5 MHz / 16QAM - RB Size 25



8.1.2 LTE Band 12

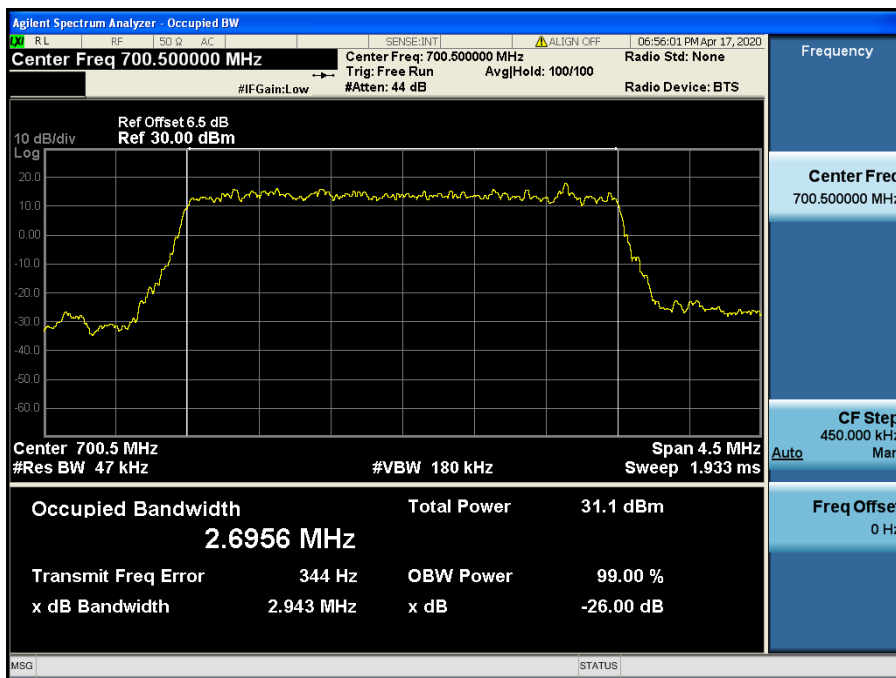

LTE Band 12 / 3 MHz / QPSK - RB Size 15

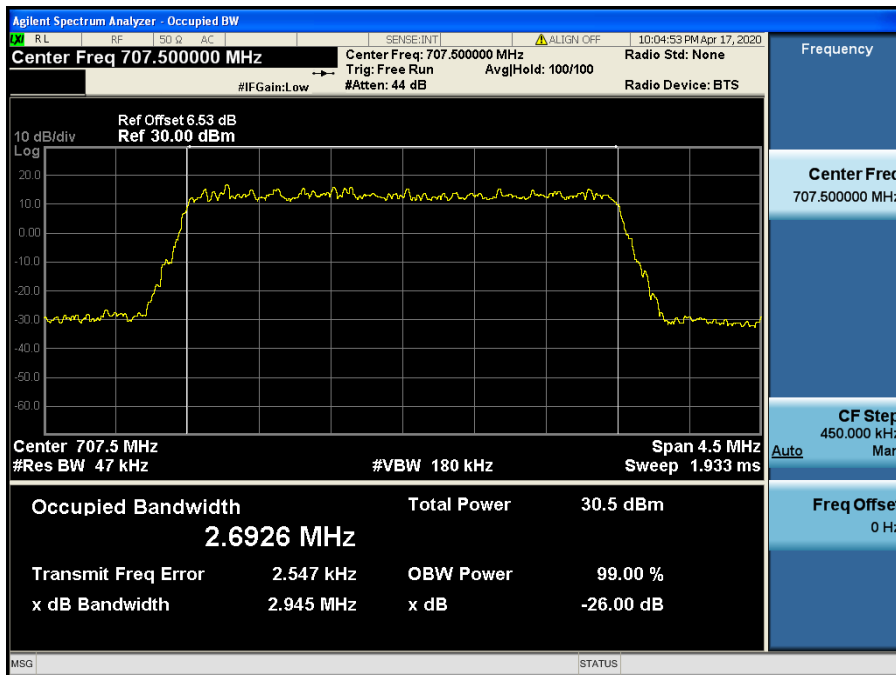

LTE Band 12 / 3 MHz / 16QAM - RB Size 15

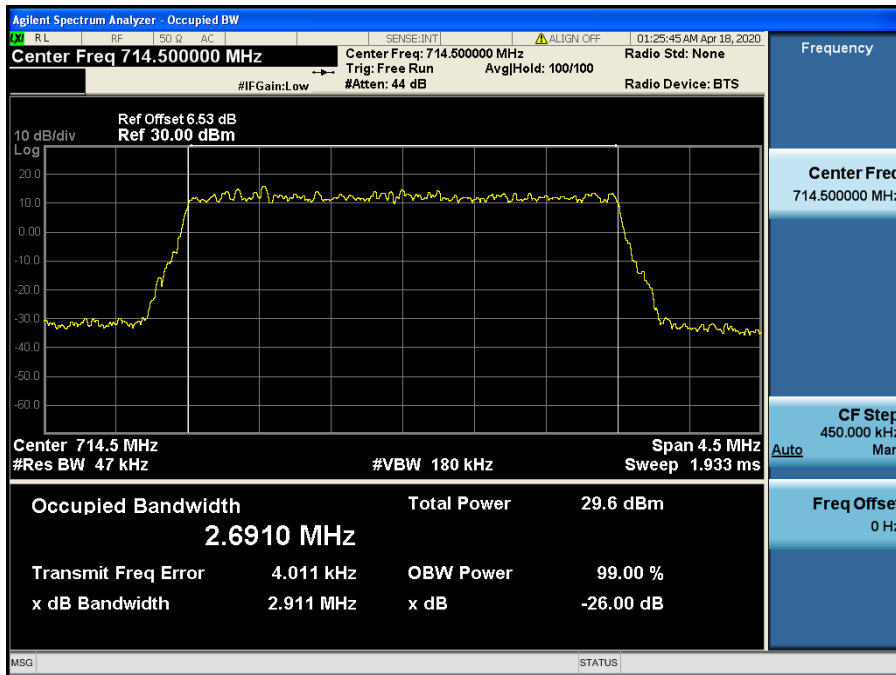

LTE Band 12 / 3 MHz / 64QAM - RB Size 15

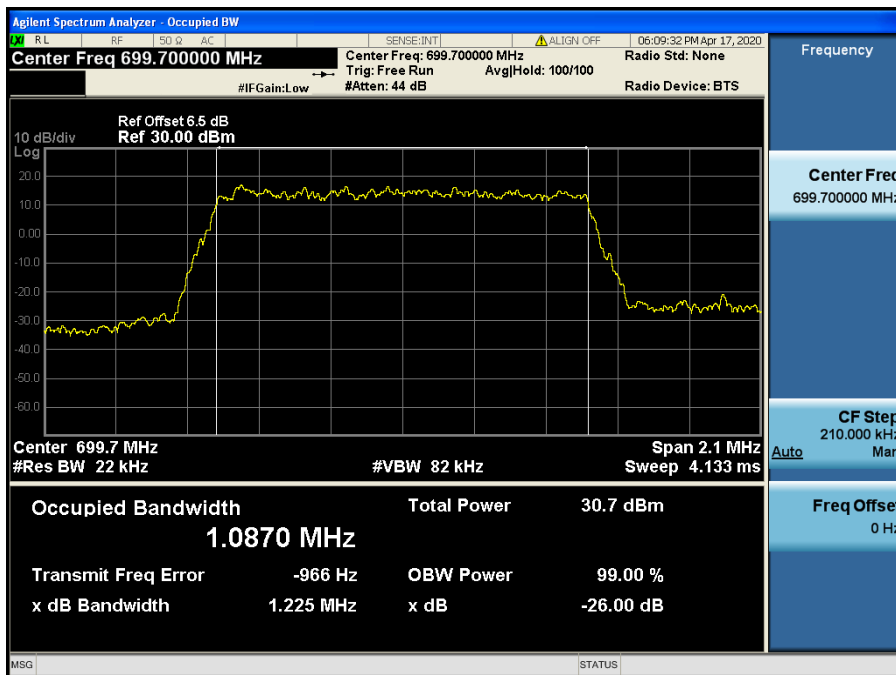

LTE Band 12 / 1.4 MHz / QPSK - RB Size 6

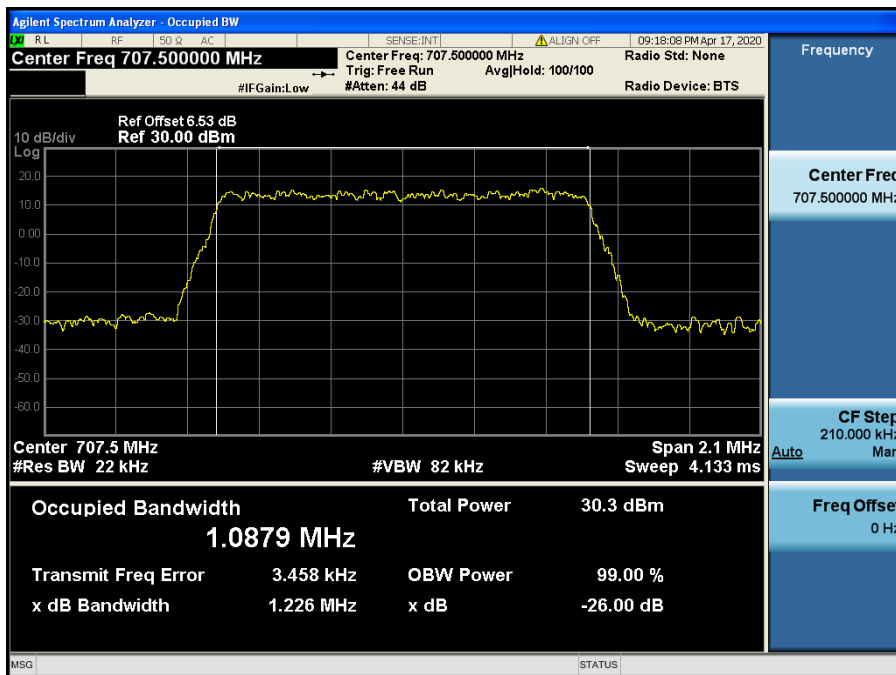

LTE Band 12 / 1.4 MHz / 16QAM - RB Size 6

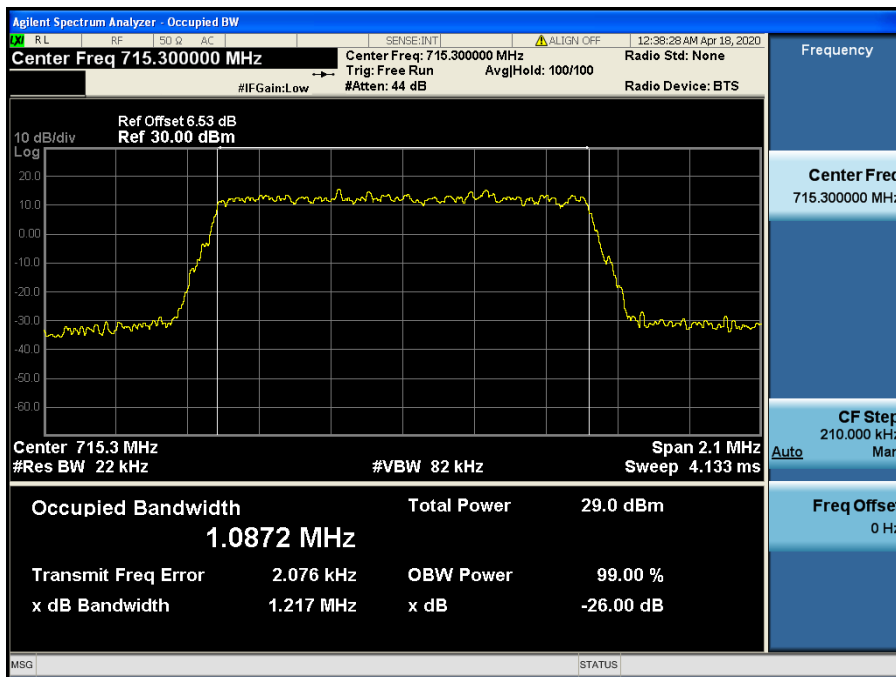

LTE Band 12 / 1.4 MHz / 64QAM - RB Size 6



8.1.3 LTE Band 13

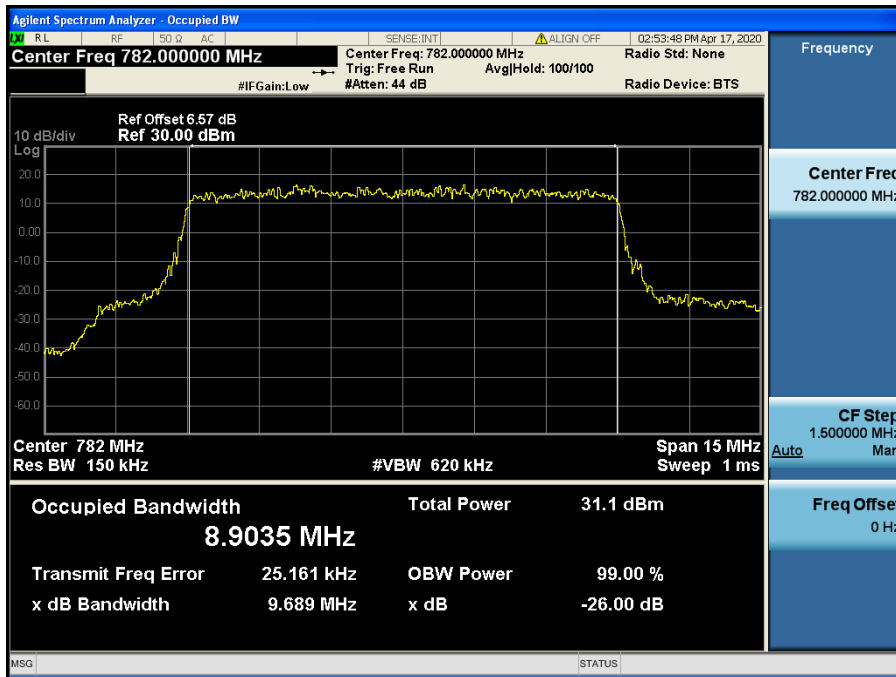

LTE Band 13 / 10 MHz / QPSK - RB Size 50

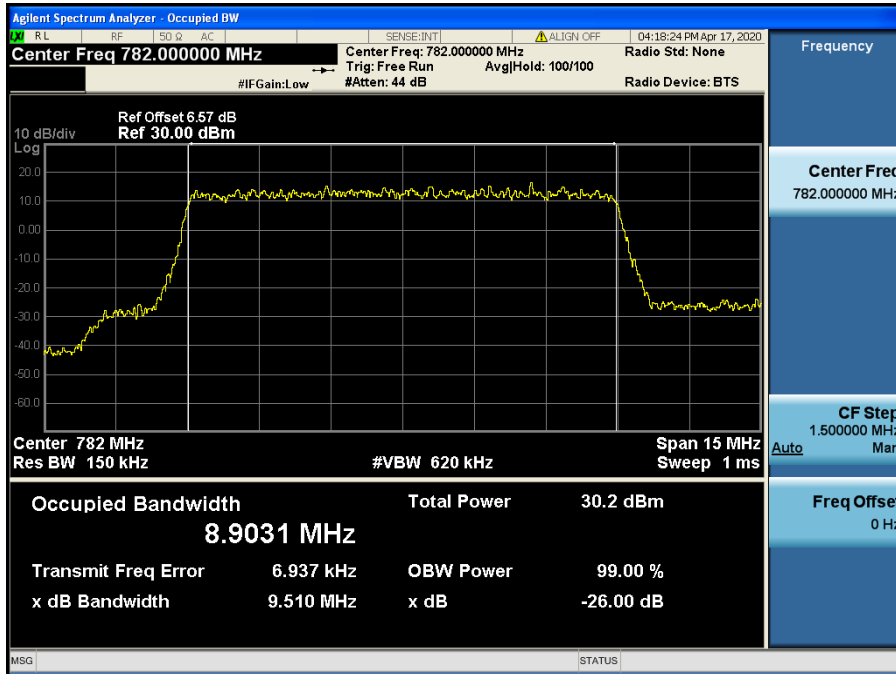

LTE Band 13 / 10 MHz / 16QAM - RB Size 50

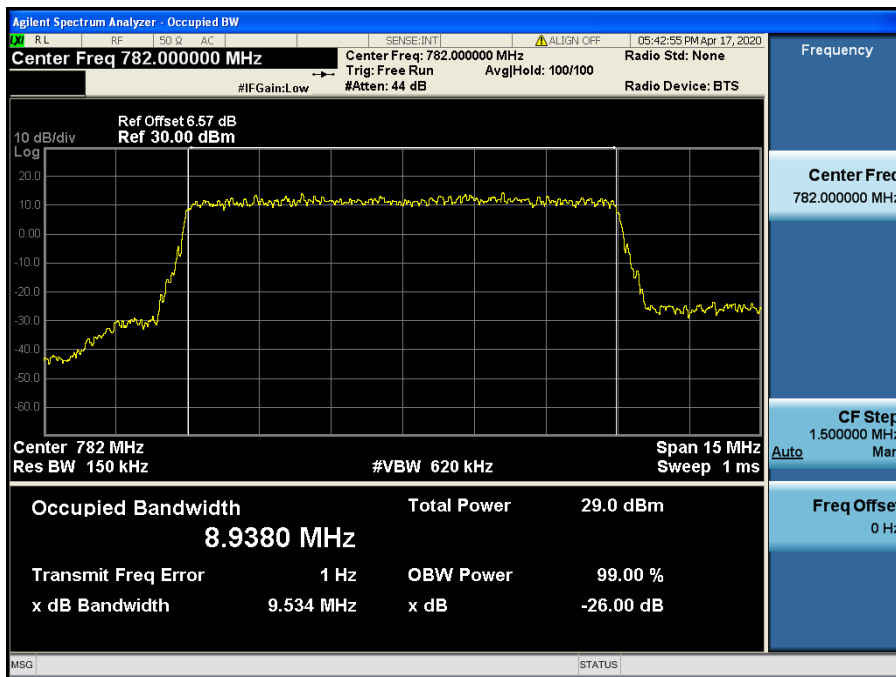

LTE Band 13 / 10 MHz / 64QAM - RB Size 50

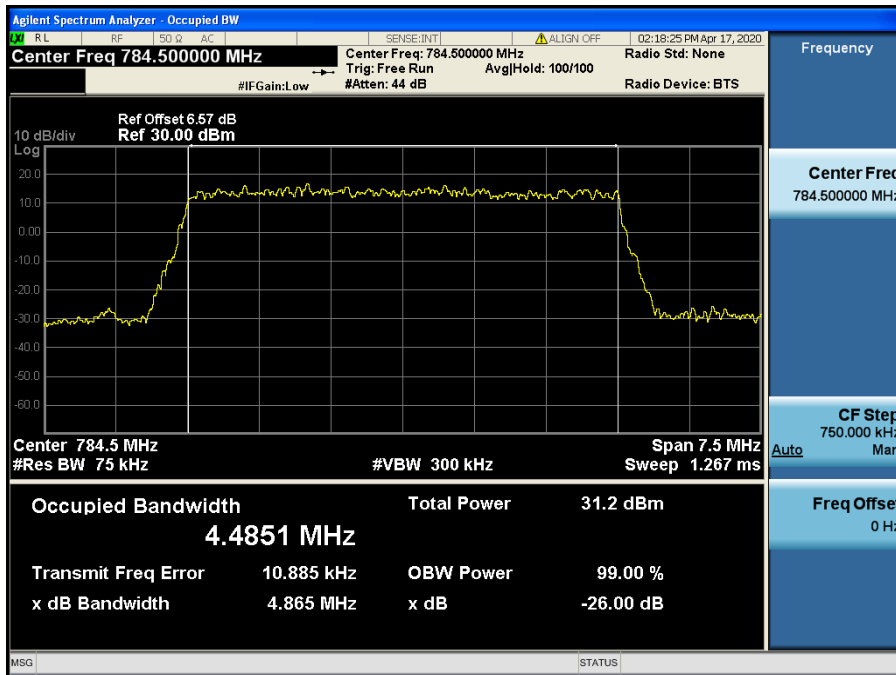

LTE Band 13 / 5 MHz / QPSK - RB Size 25

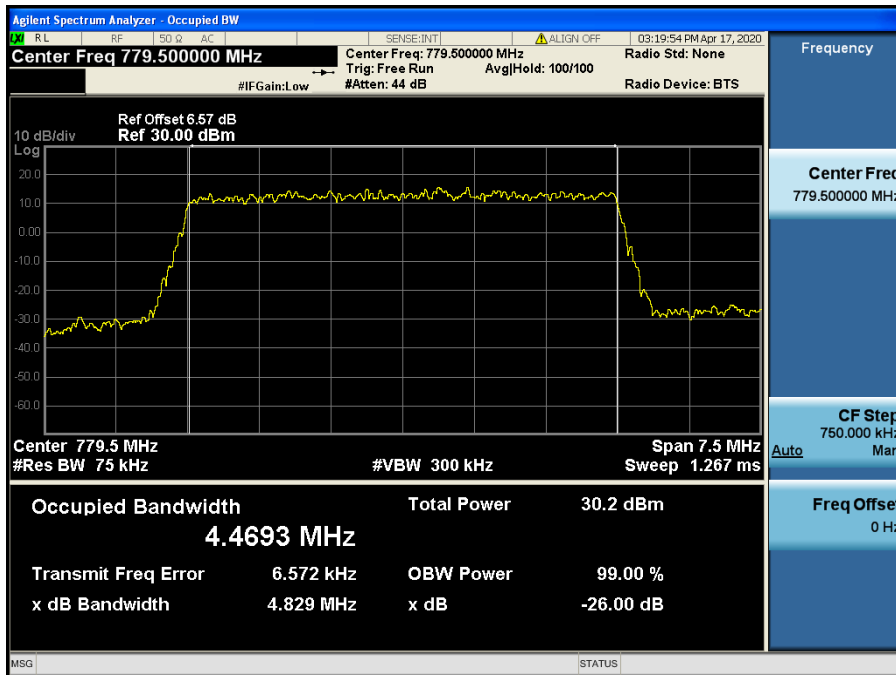

LTE Band 13 / 5 MHz / 16QAM - RB Size 25

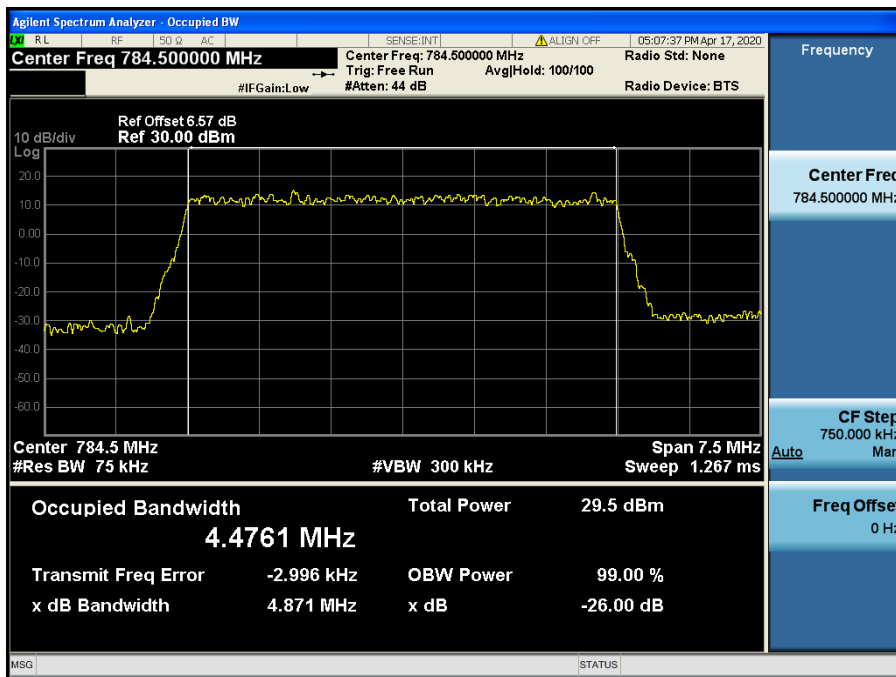

LTE Band 13 / 5 MHz / 64QAM - RB Size 25

8.1.4 LTE Band 26

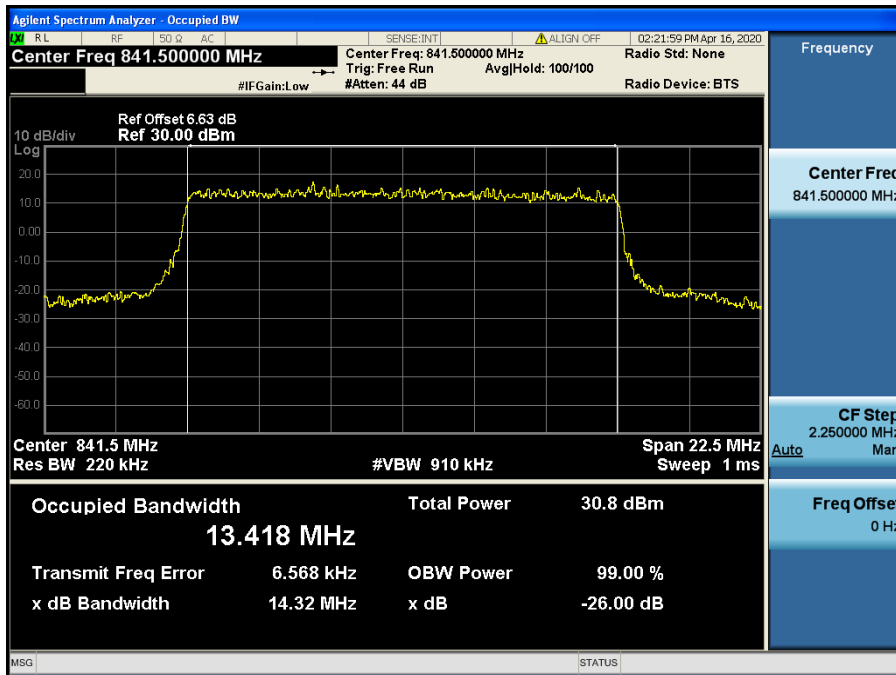

LTE Band 26 / 15 MHz / QPSK - RB Size 75

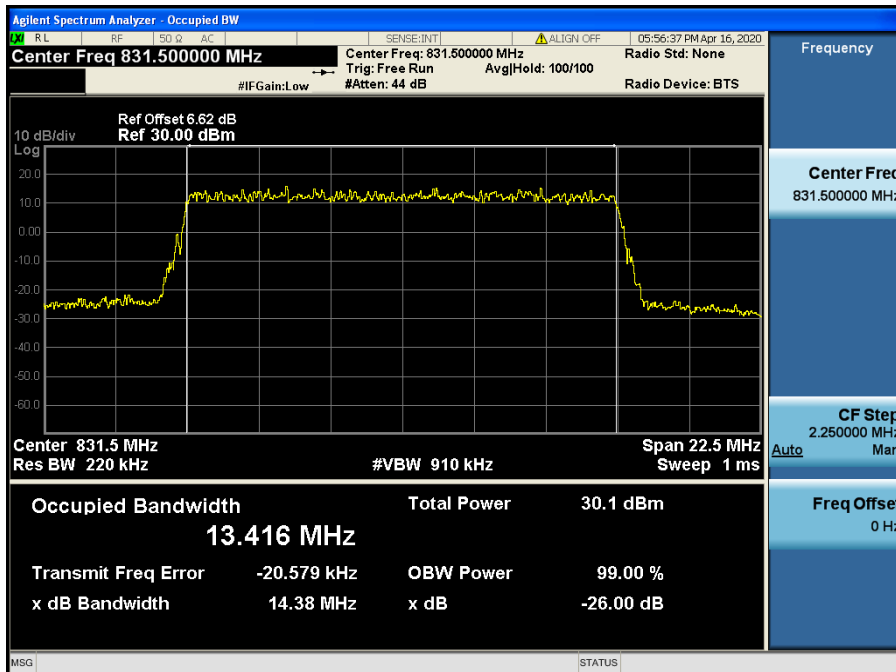

LTE Band 26 / 15 MHz / 16QAM - RB Size 75

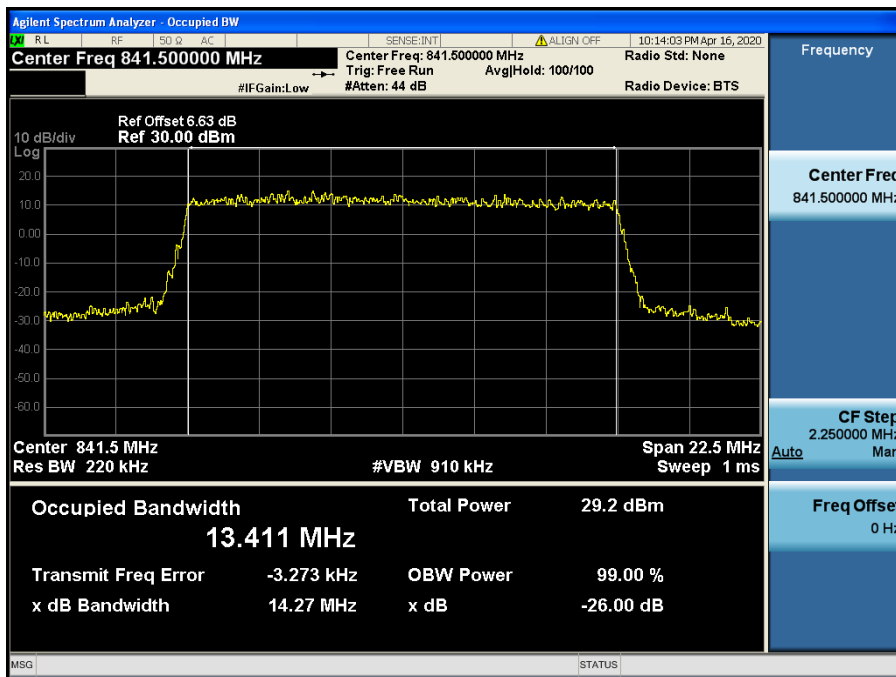

LTE Band 26 / 15 MHz / 64QAM - RB Size 75

8.1.5 LTE Band 5, 26

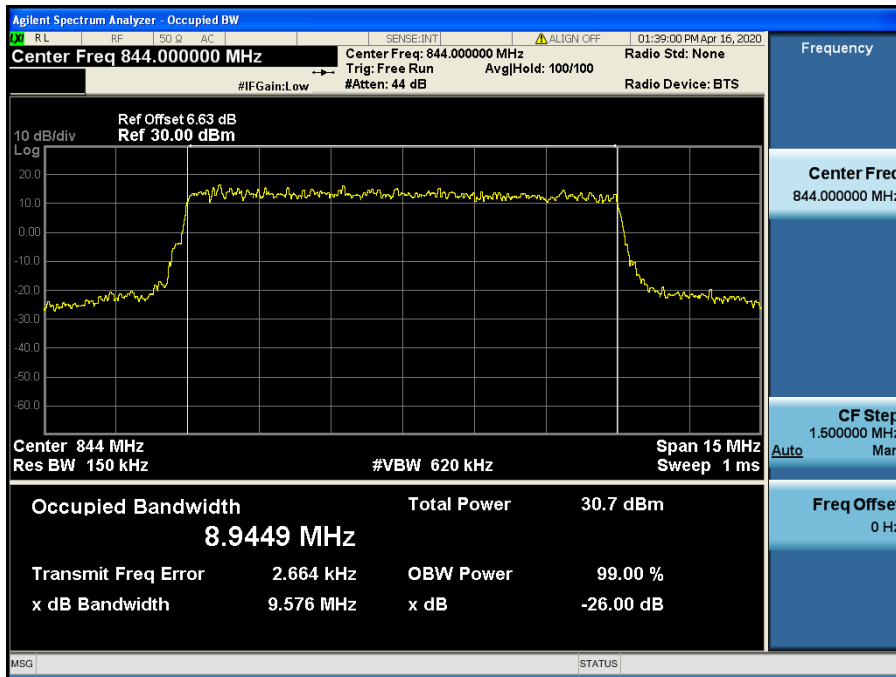

LTE Band 5, 26 / 10 MHz / QPSK - RB Size 50

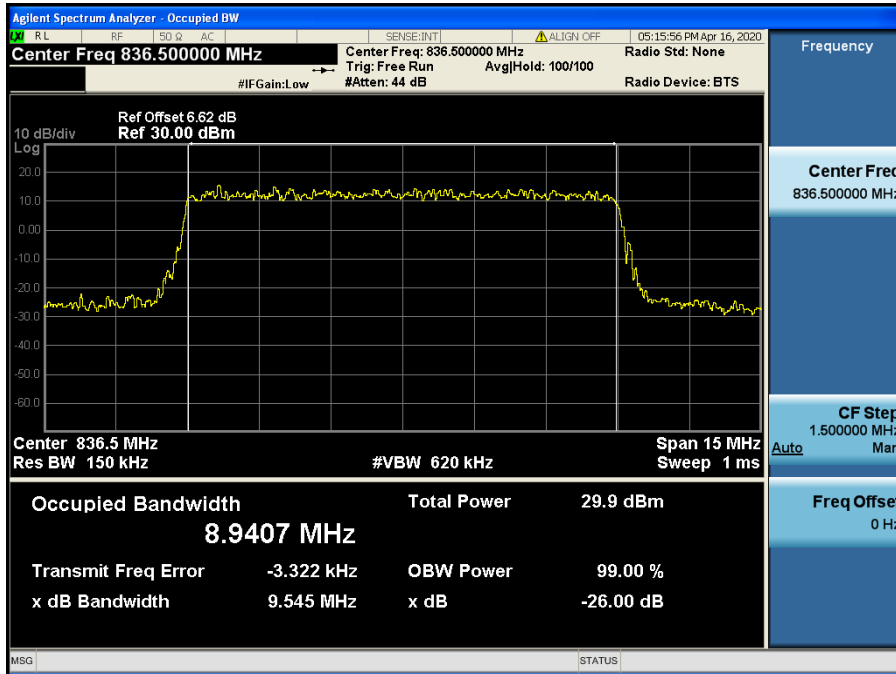

LTE Band 5, 26 / 10 MHz / 16QAM - RB Size 50

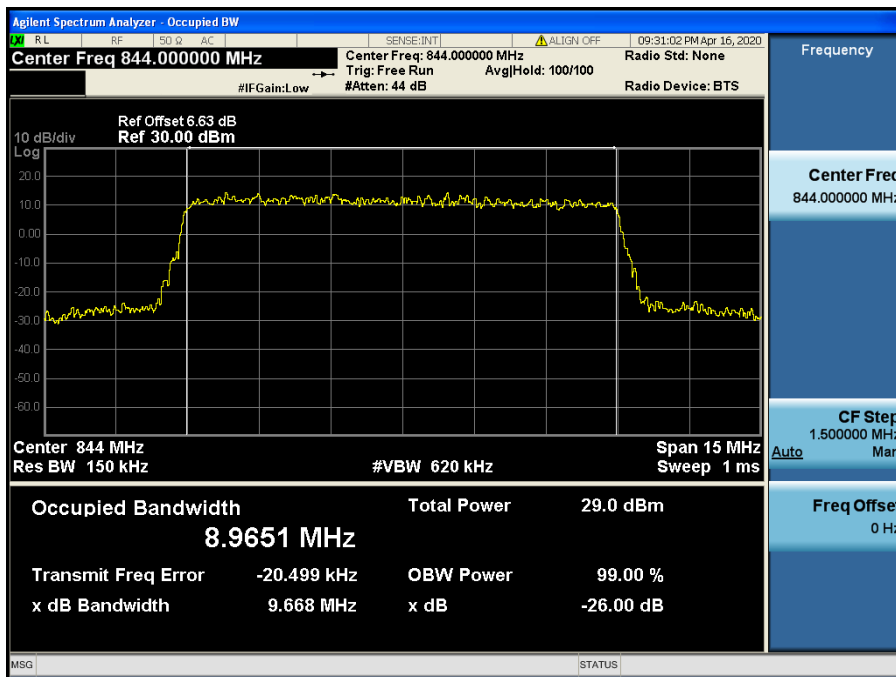

LTE Band 5, 26 / 10 MHz / 64QAM - RB Size 50



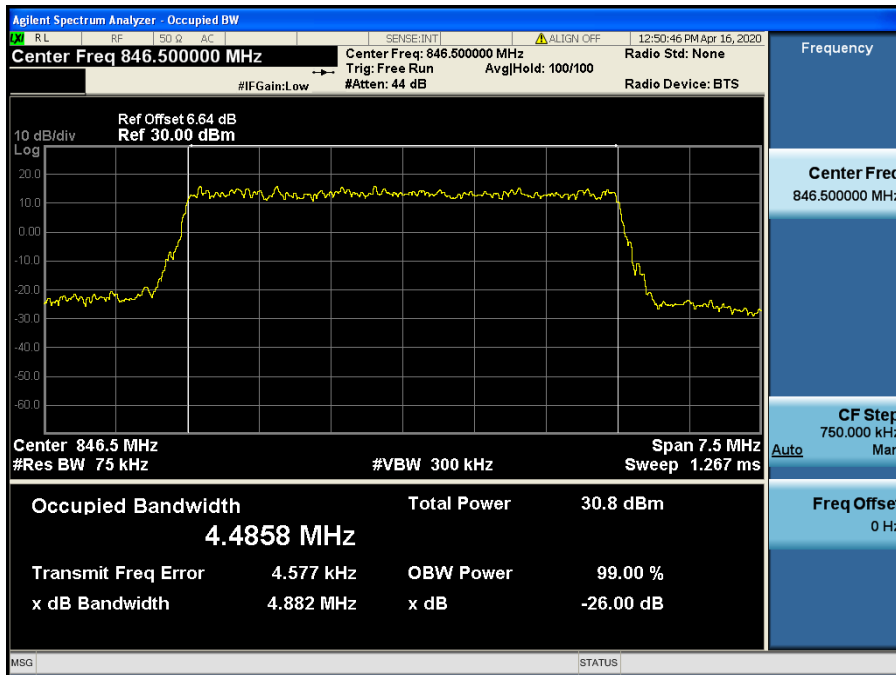

LTE Band 5, 26 / 5 MHz / QPSK - RB Size 25

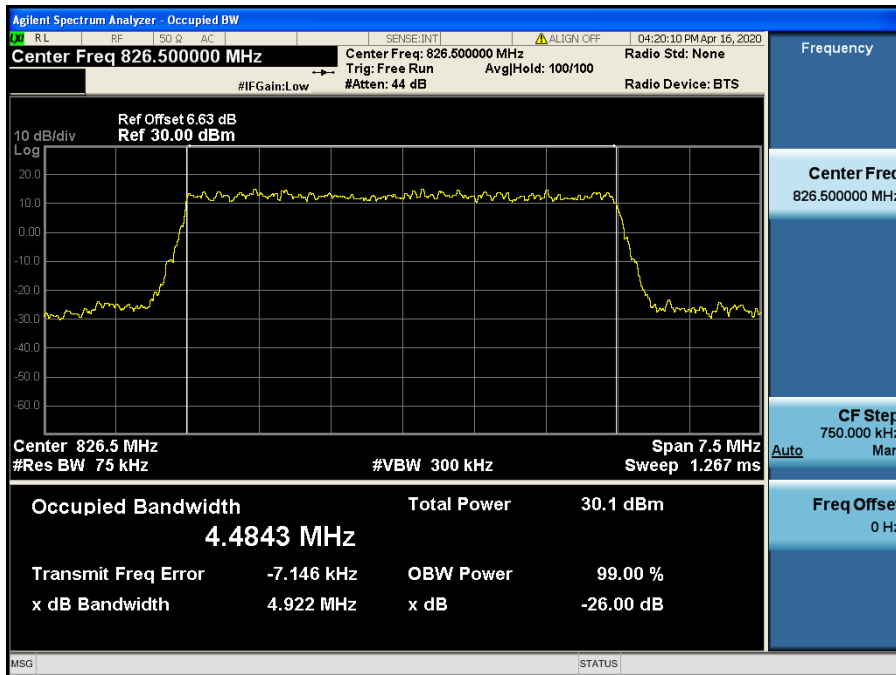

LTE Band 5, 26 / 5 MHz / 16QAM - RB Size 25

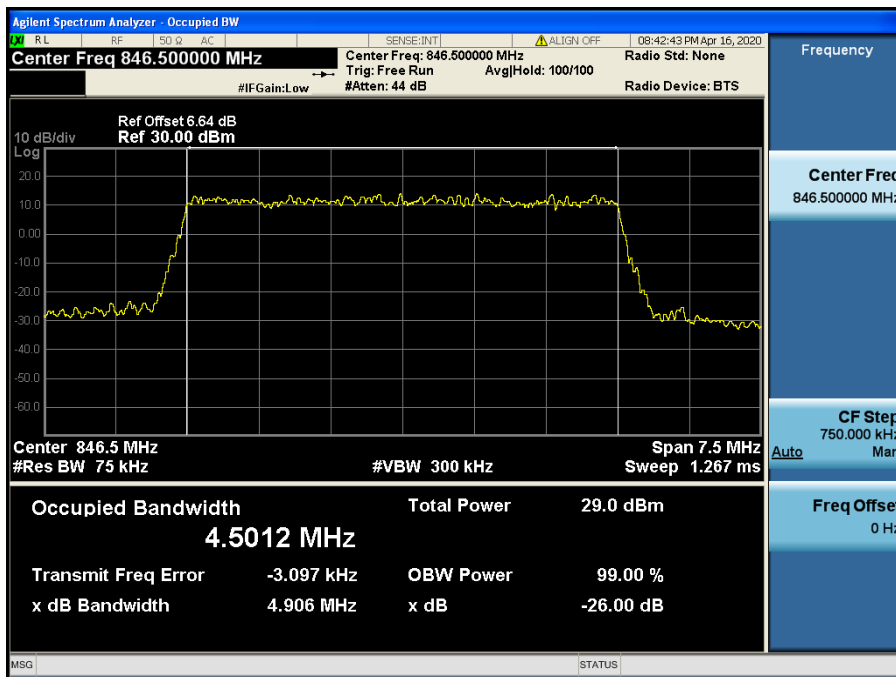

LTE Band 5, 26 / 5 MHz / 64QAM - RB Size 25

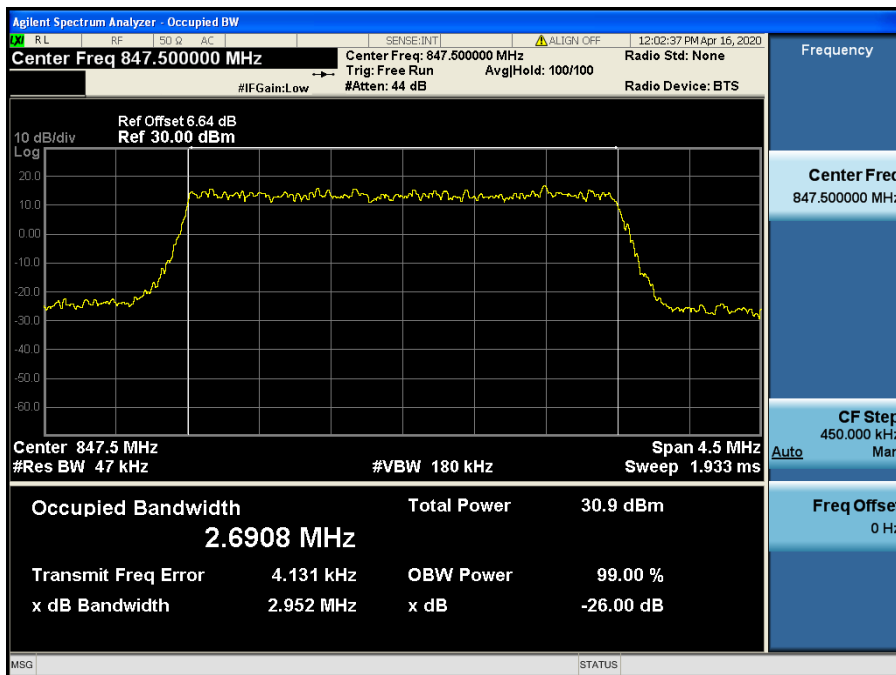

LTE Band 5, 26 / 3 MHz / QPSK - RB Size 15

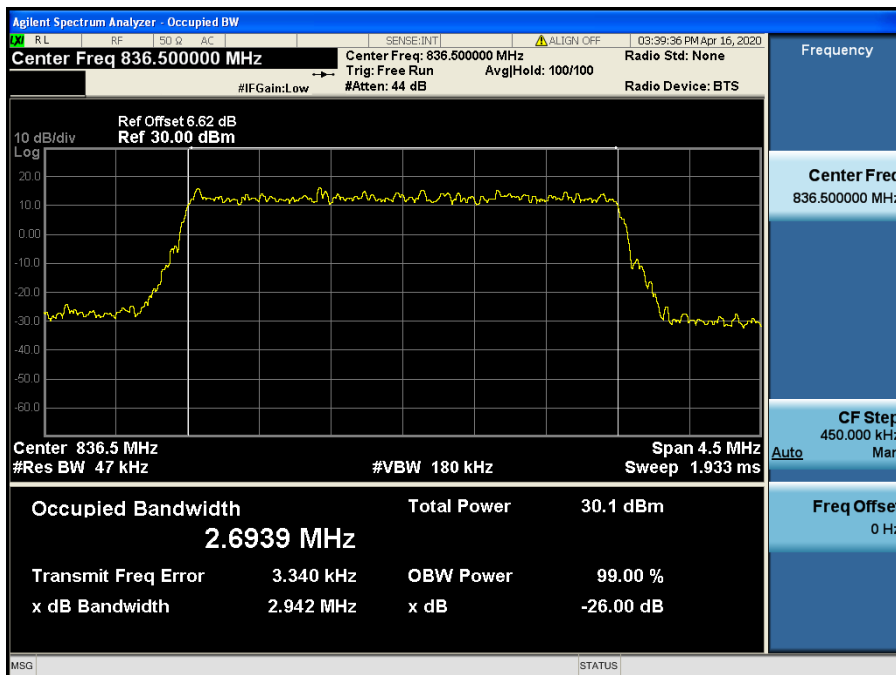

LTE Band 5, 26 / 3 MHz / 16QAM - RB Size 15

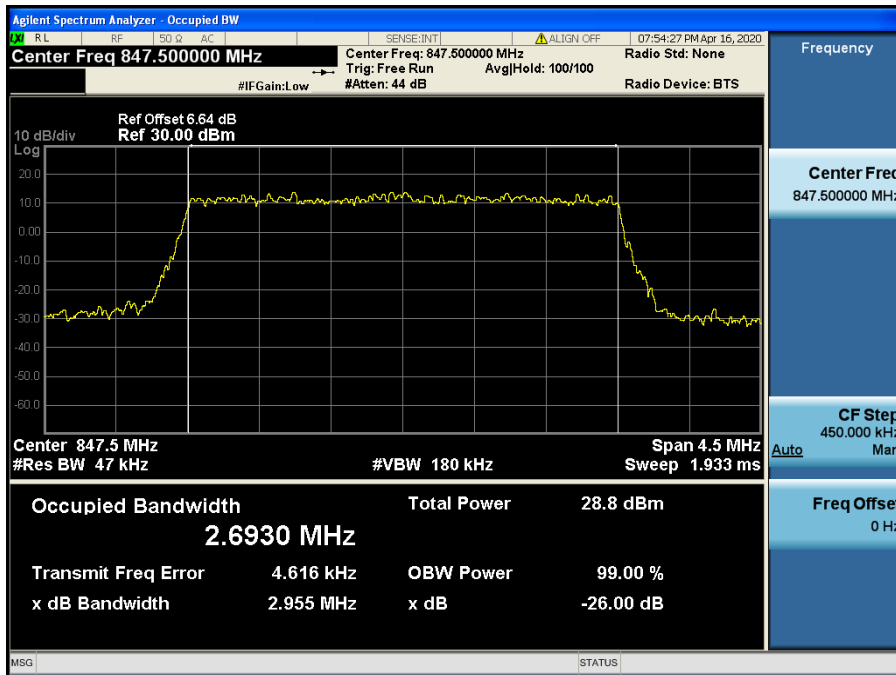

LTE Band 5, 26 / 3 MHz / 64QAM - RB Size 15

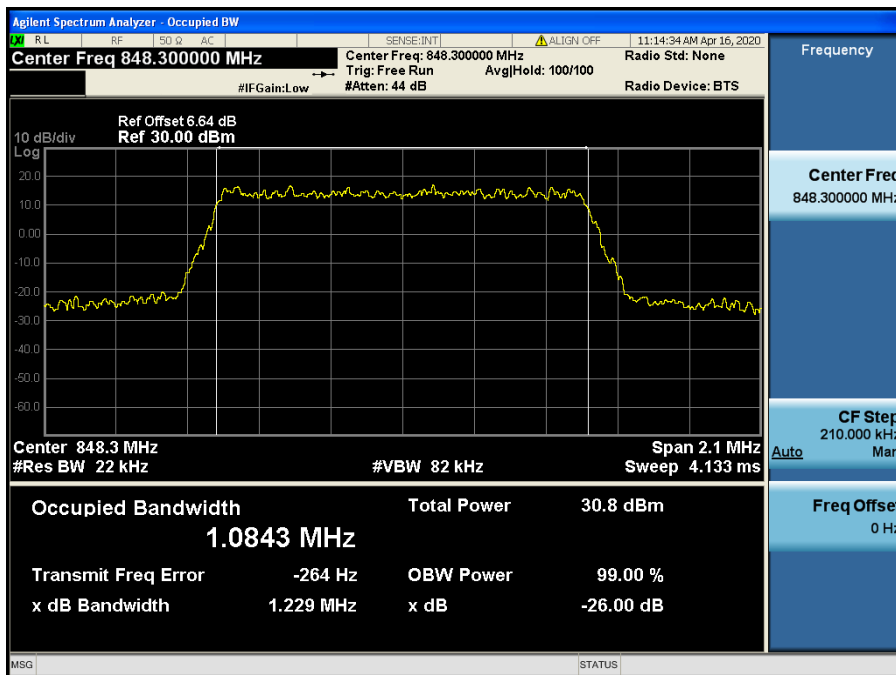

LTE Band 5, 26 / 1.4 MHz / QPSK - RB Size 6

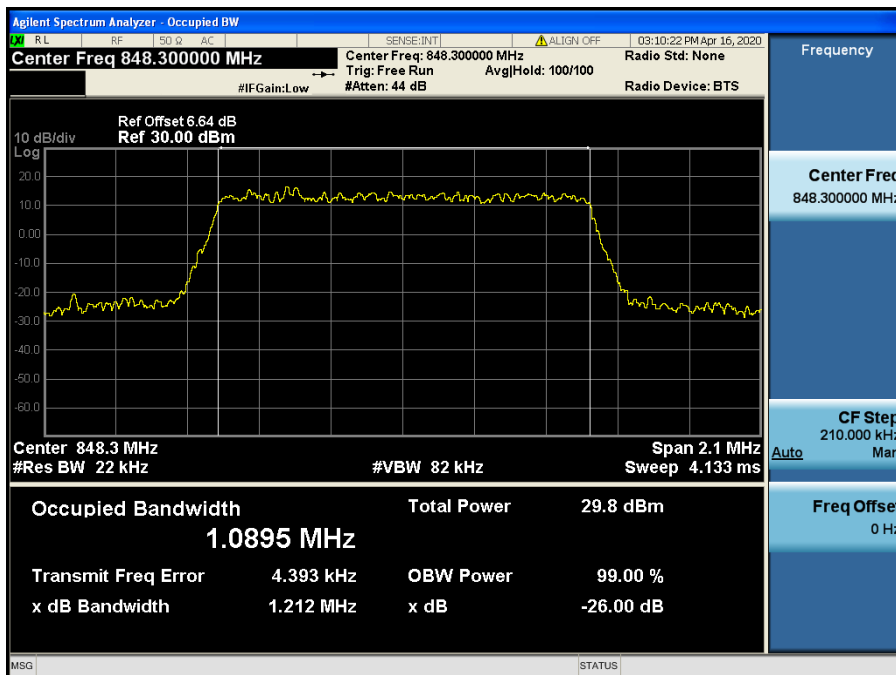

LTE Band 5, 26 / 1.4 MHz / 16QAM - RB Size 6

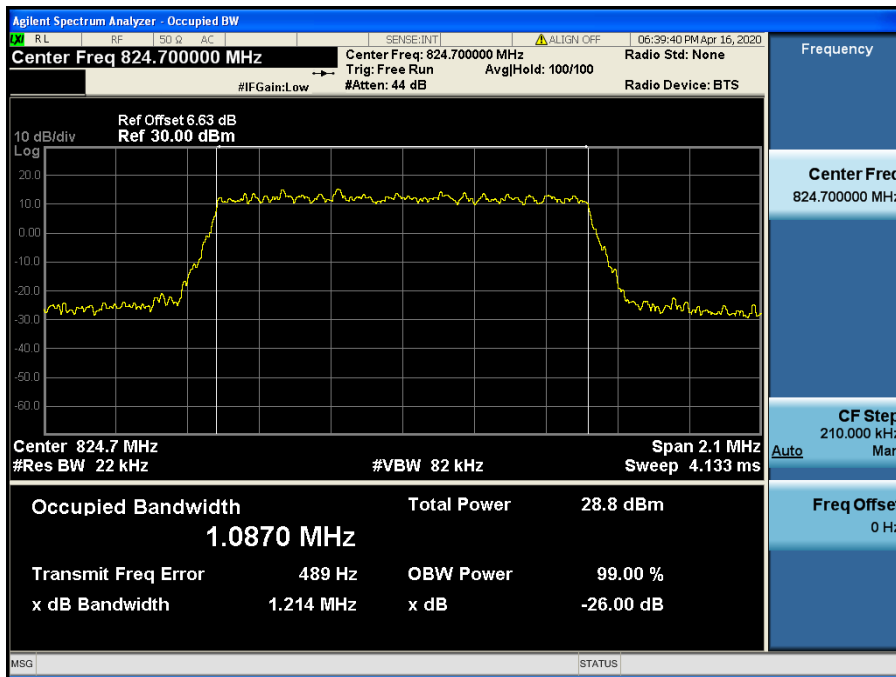

LTE Band 5, 26 / 1.4 MHz / 64QAM - RB Size 6

8.1.6 LTE Band 66, 4

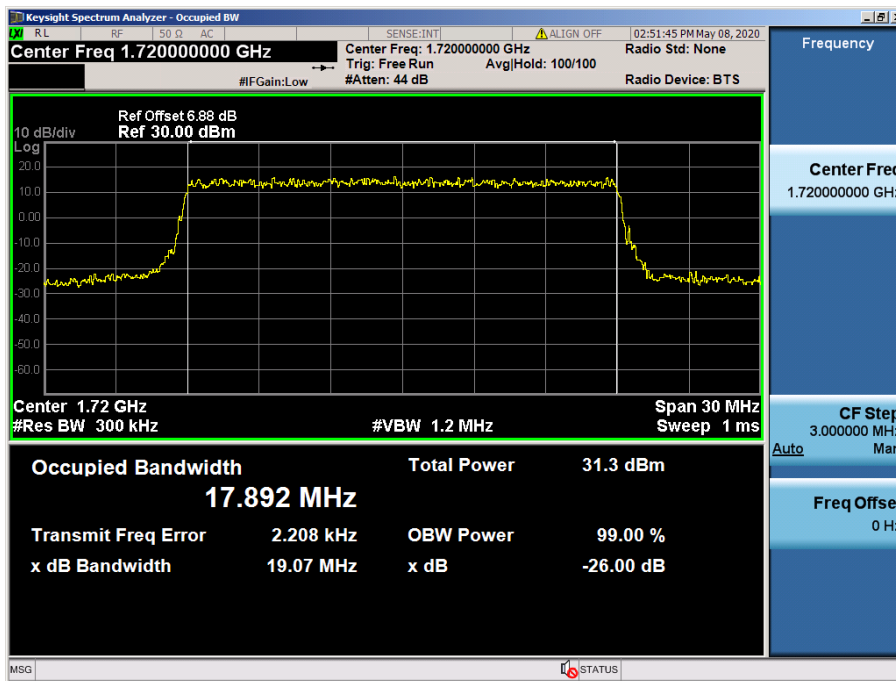

LTE Band 66, 4 / 20 MHz / QPSK - RB Size 100

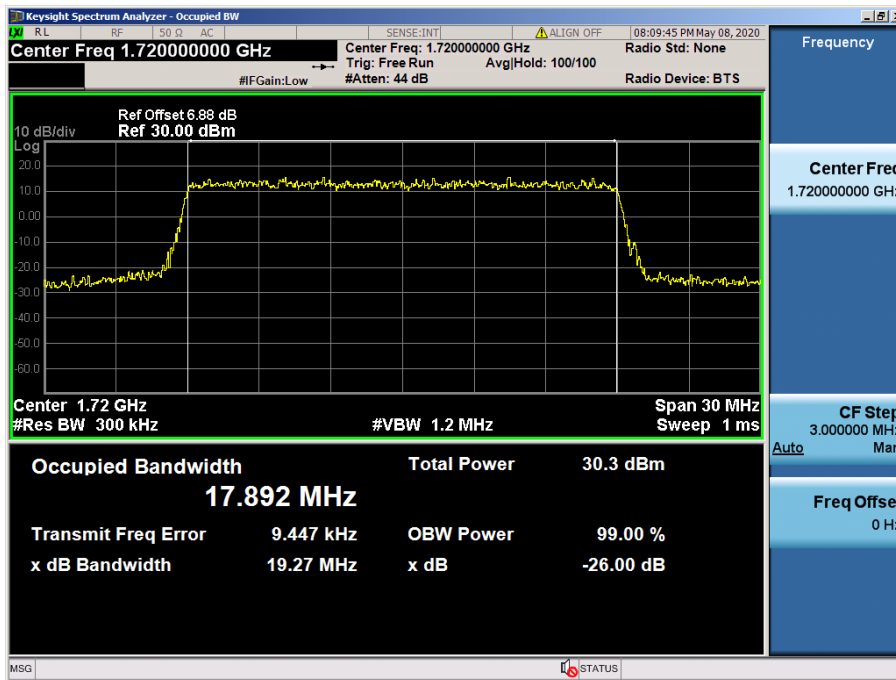

LTE Band 66, 4 / 20 MHz / 16QAM - RB Size 100

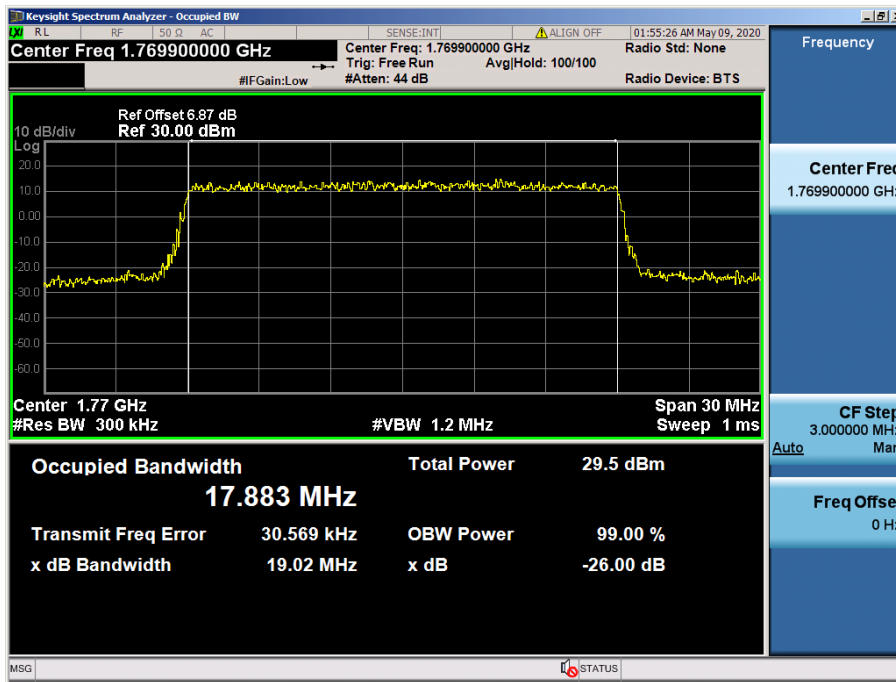

LTE Band 66, 4 / 20 MHz / 64QAM - RB Size 100



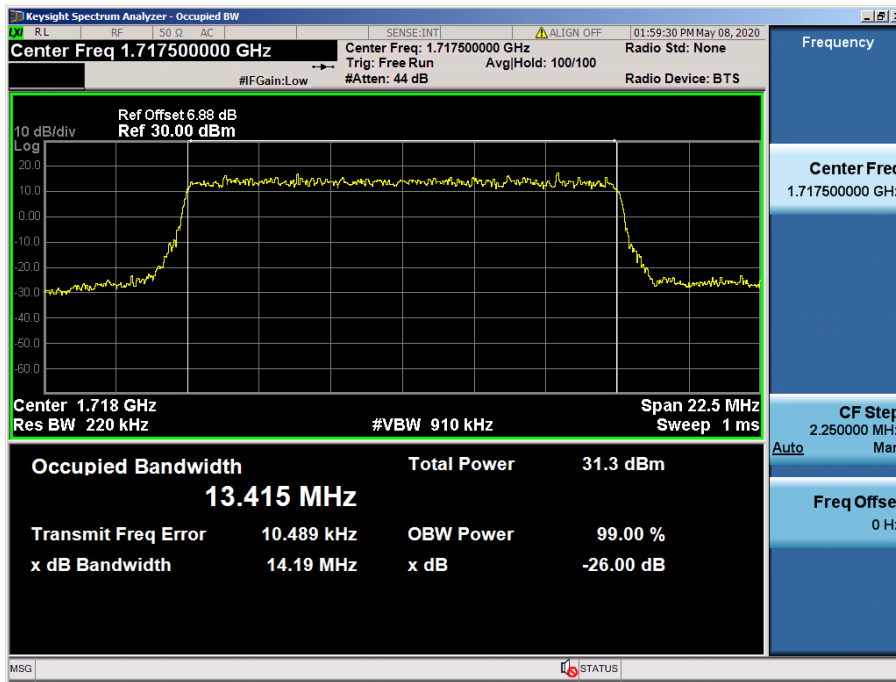

LTE Band 66, 4 / 15 MHz / QPSK - RB Size 75

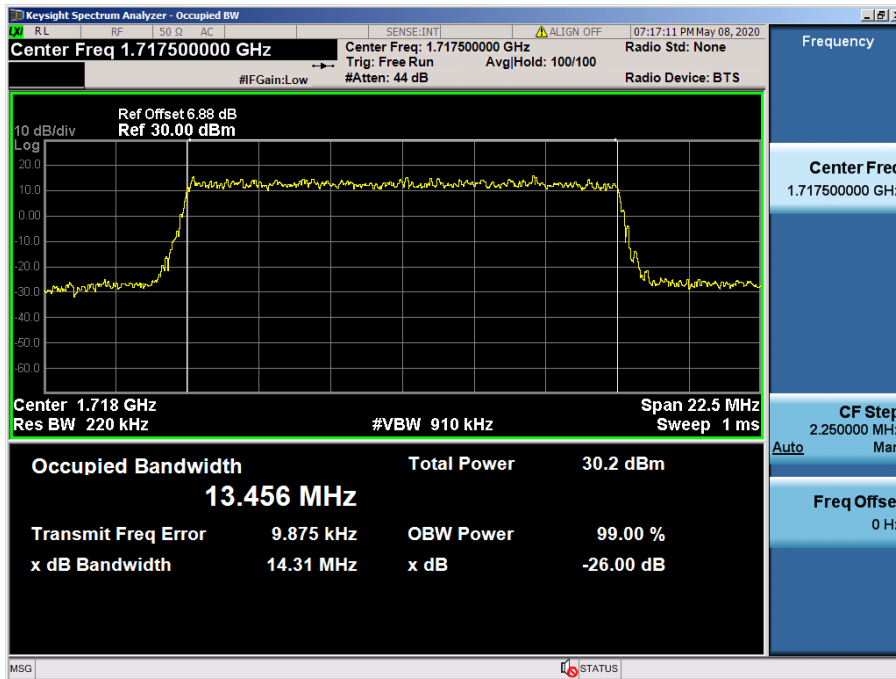

LTE Band 66, 4 / 15 MHz / 16QAM - RB Size 75

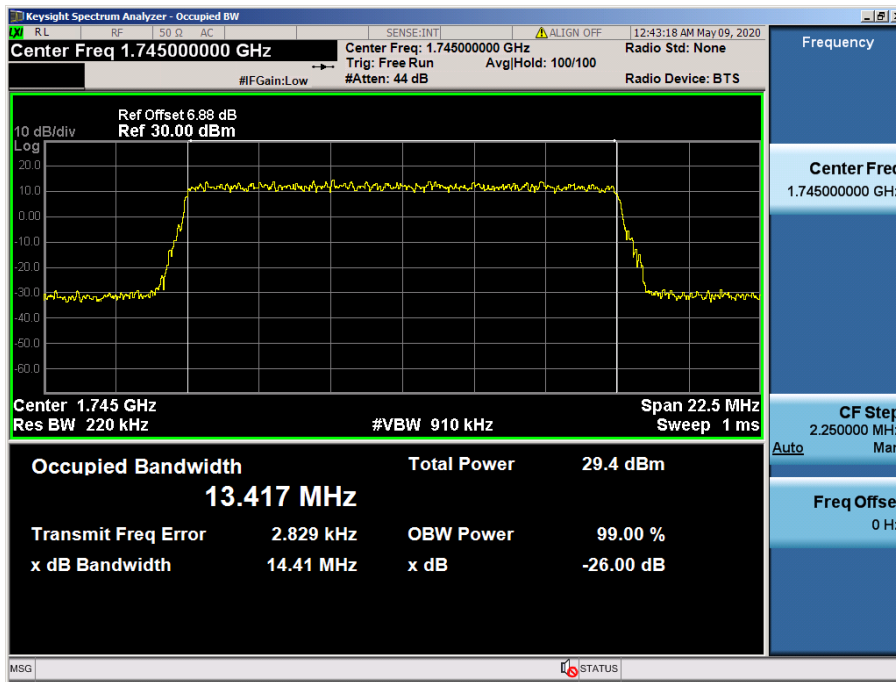

LTE Band 66, 4 / 15 MHz / 64QAM - RB Size 75

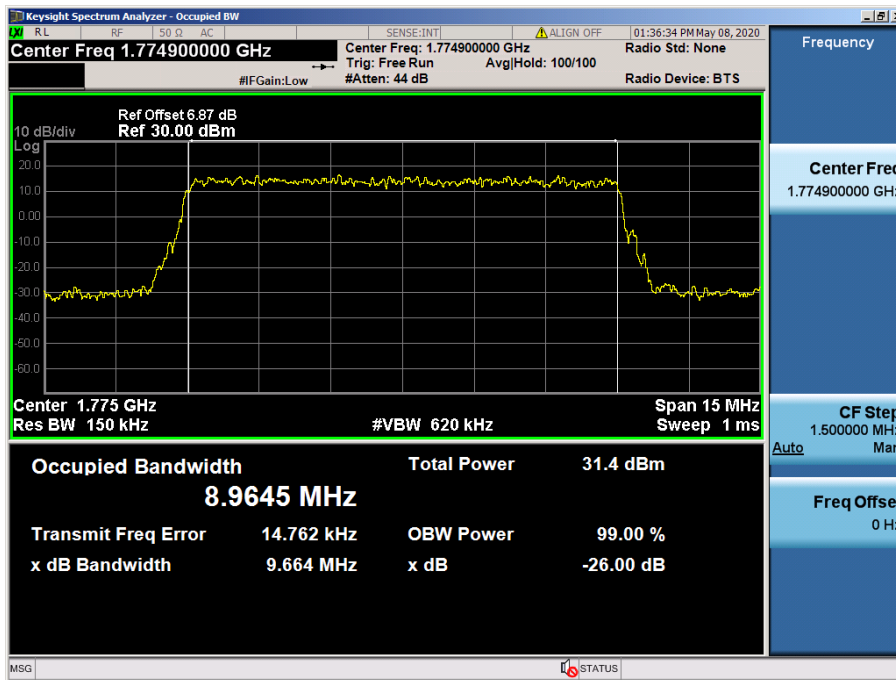

LTE Band 66, 4 / 10 MHz / QPSK - RB Size 50

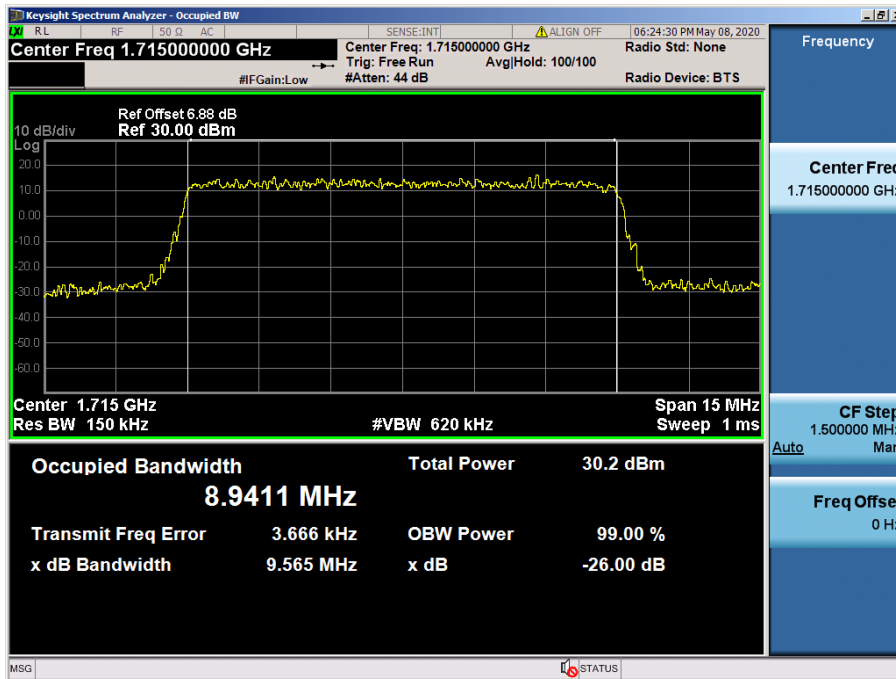

LTE Band 66, 4 / 10 MHz / 16QAM - RB Size 50

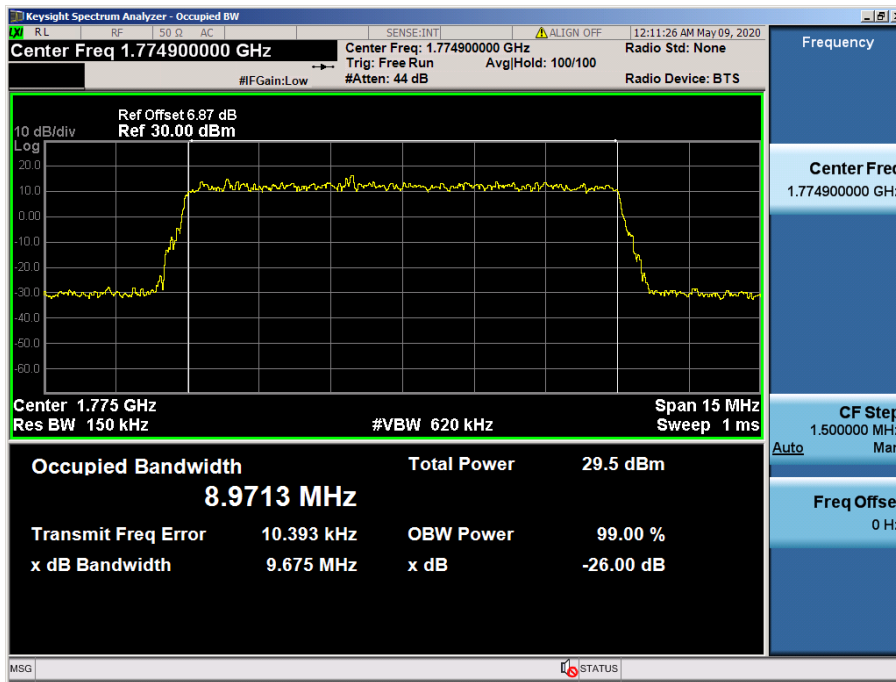

LTE Band 66, 4 / 10 MHz / 64QAM - RB Size 50

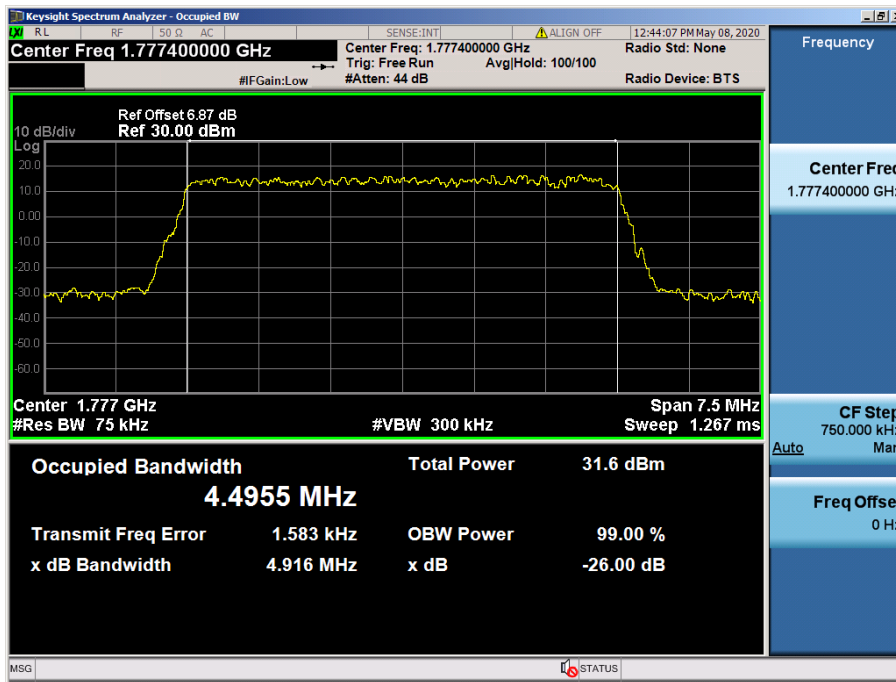

LTE Band 66, 4 / 5 MHz / QPSK - RB Size 25

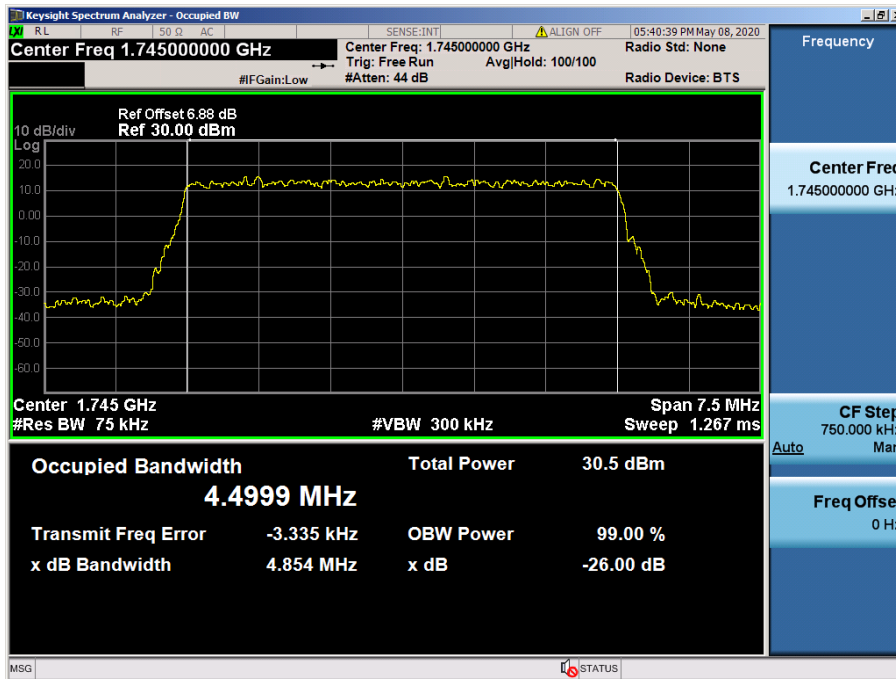

LTE Band 66, 4 / 5 MHz / 16QAM - RB Size 25

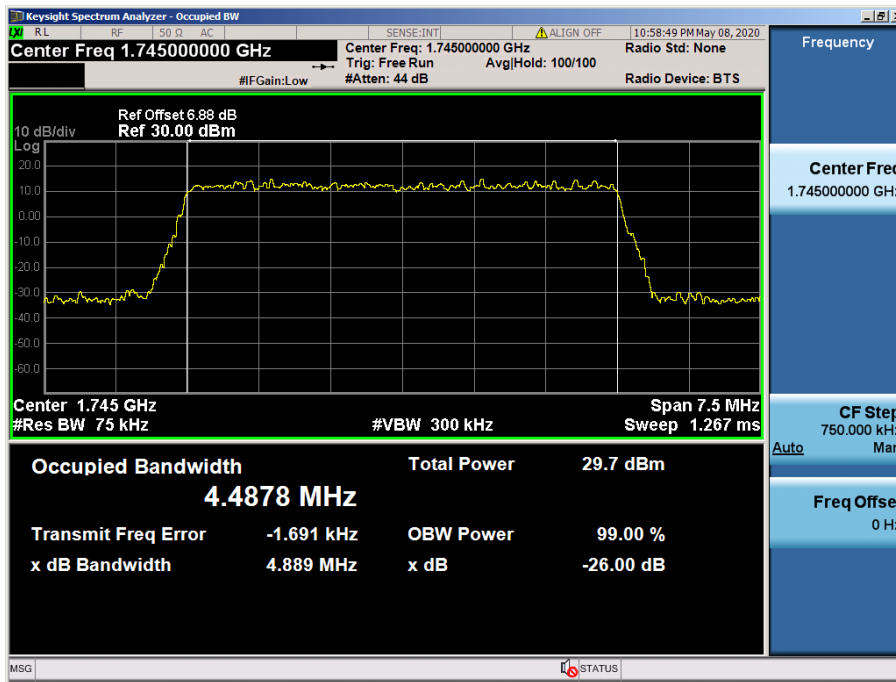

LTE Band 66, 4 / 5 MHz / 64QAM - RB Size 25

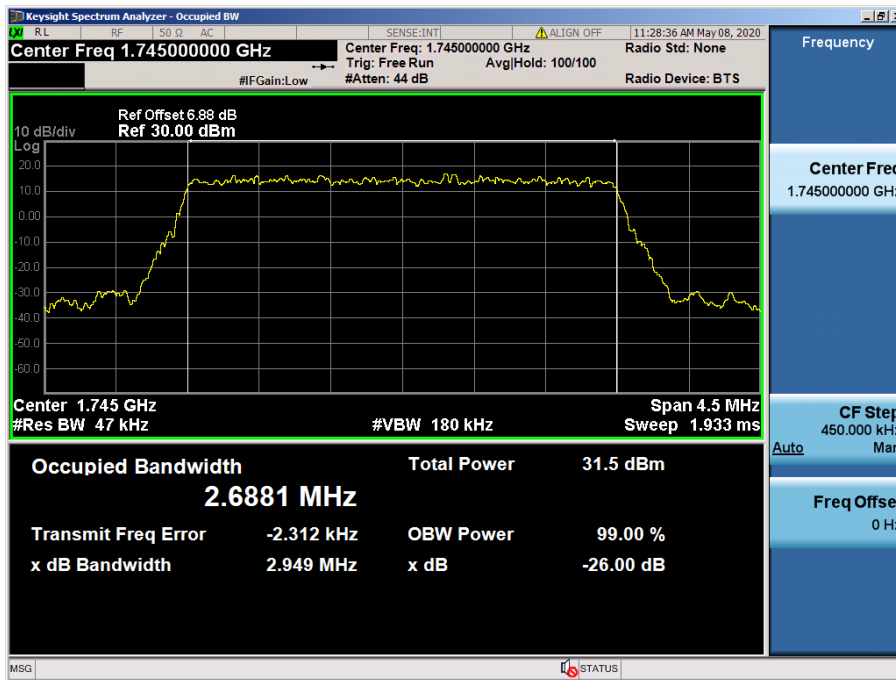

LTE Band 66, 4 / 3 MHz / QPSK - RB Size 15

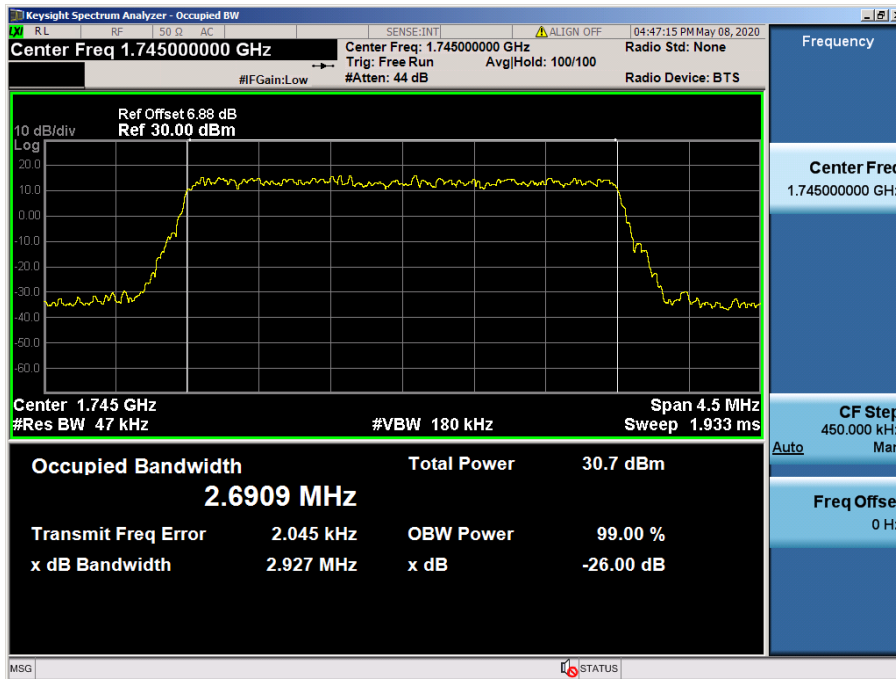

LTE Band 66, 4 / 3 MHz / 16QAM - RB Size 15

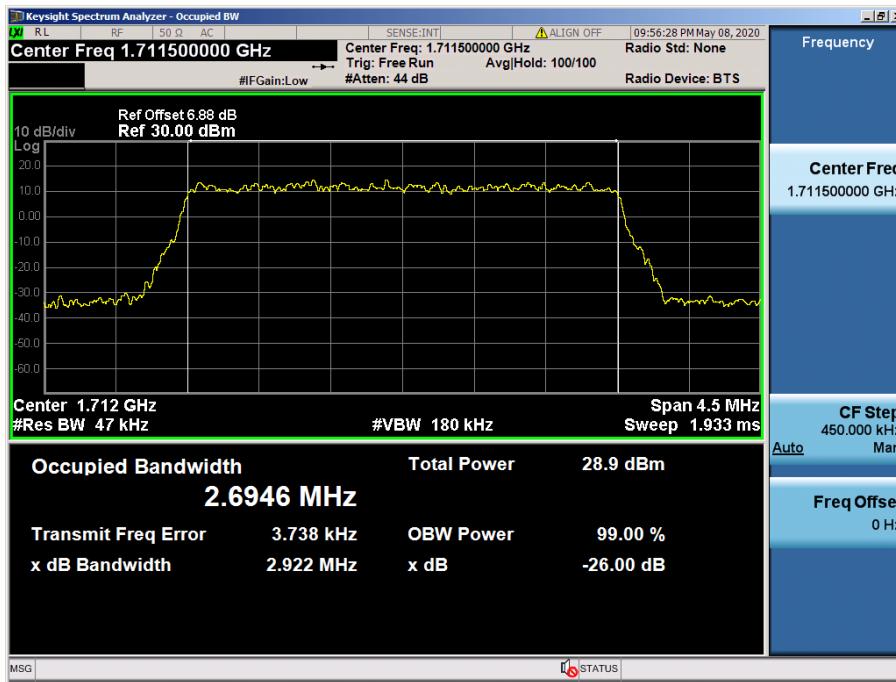

LTE Band 66, 4 / 3 MHz / 64QAM - RB Size 15



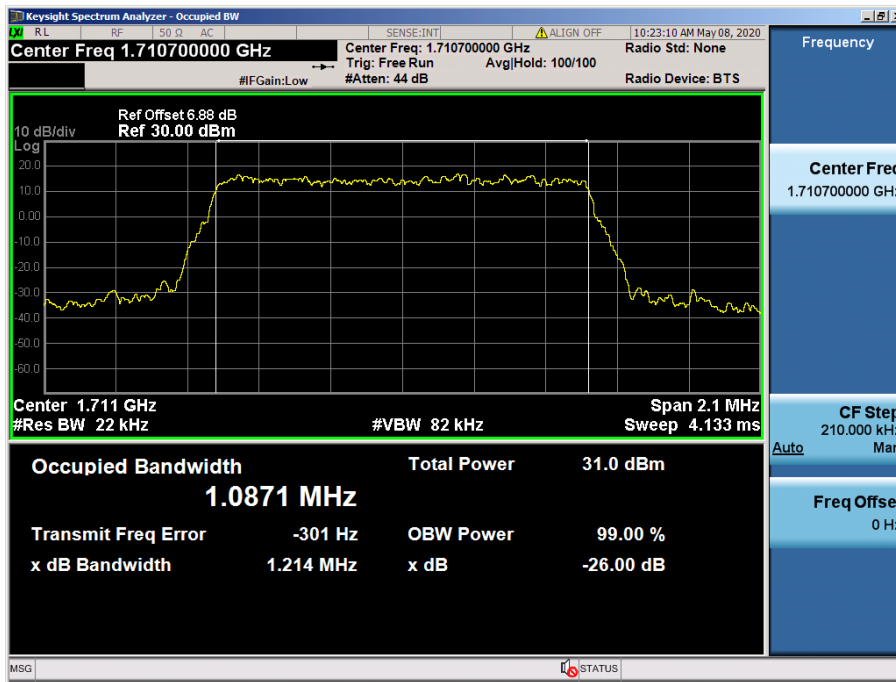

LTE Band 66, 4 / 1.4 MHz / QPSK - RB Size 6

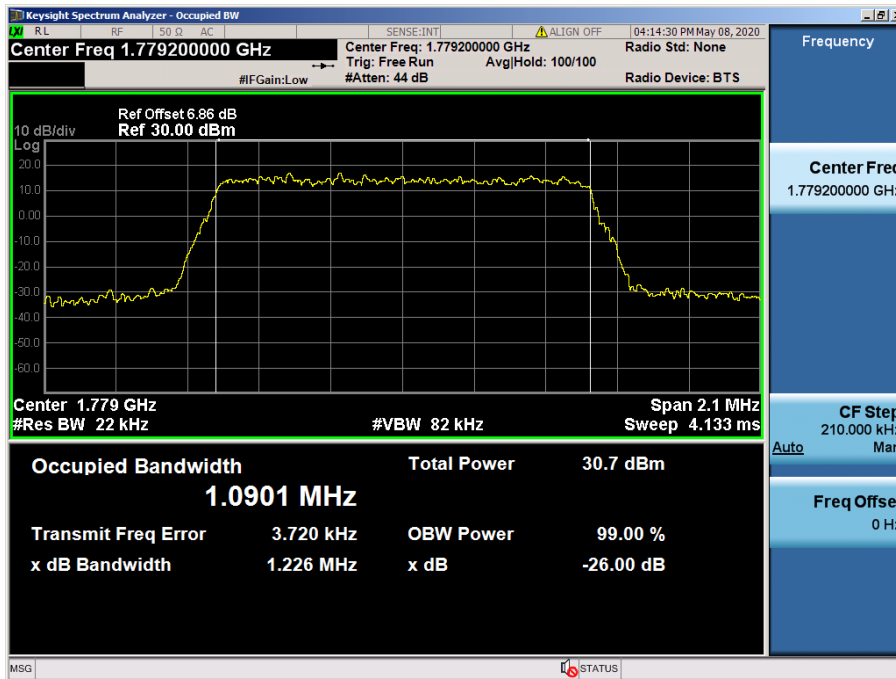

LTE Band 66, 4 / 1.4 MHz / 16QAM - RB Size 6

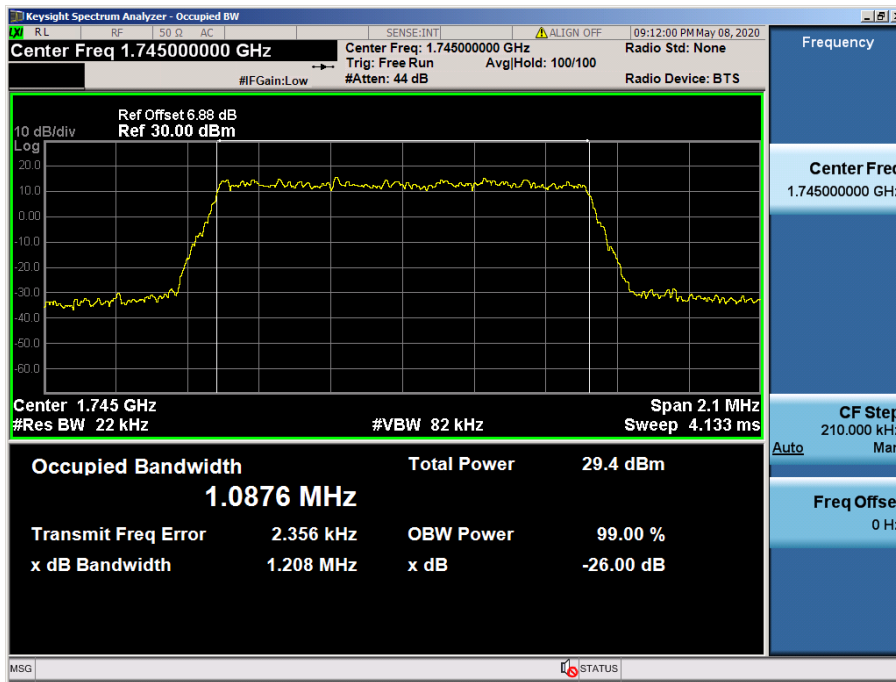

LTE Band 4 / 1.4 MHz / 64QAM - RB Size 6

8.1.7 LTE Band 25, 2

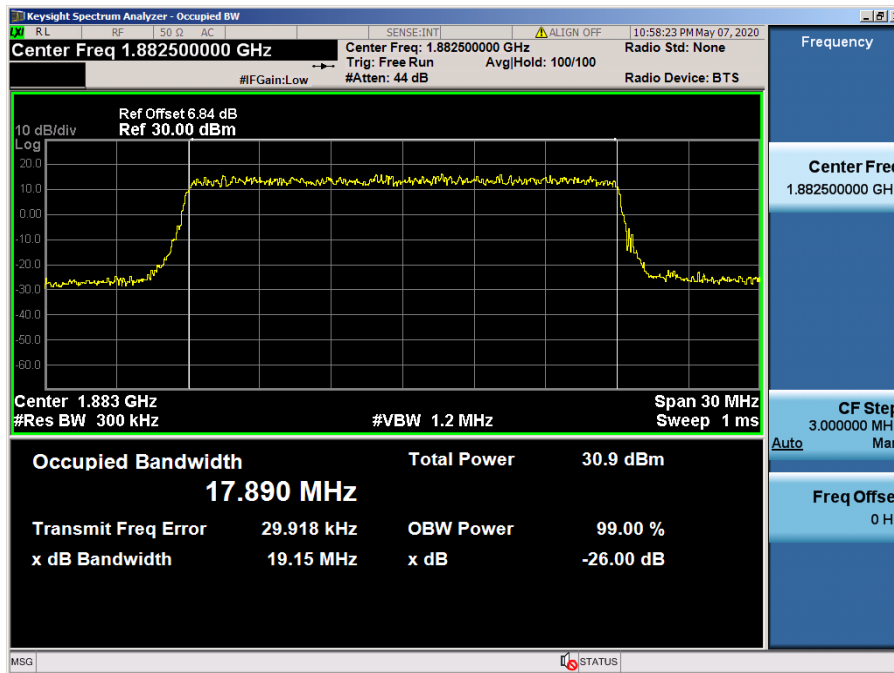

LTE Band 25, 2 / 20 MHz / QPSK - RB Size 100

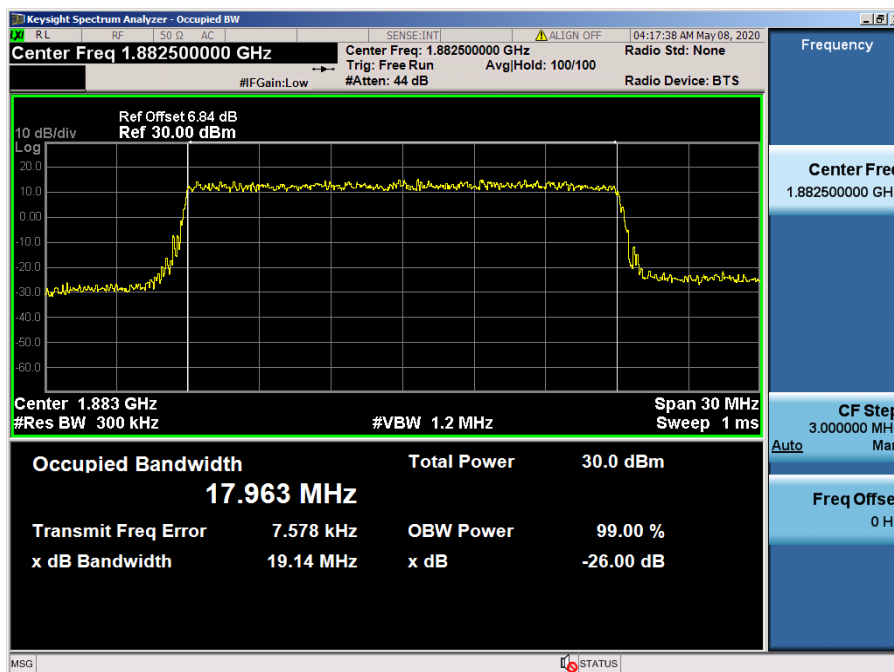

LTE Band 25, 2 / 20 MHz / 16QAM - RB Size 100

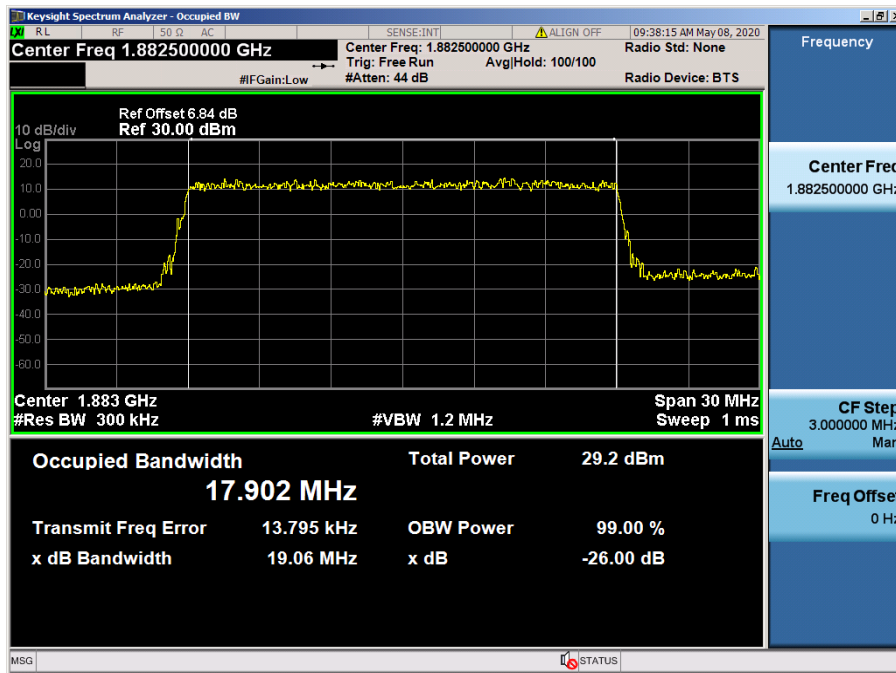

LTE Band 25, 2 / 20 MHz / 64QAM - RB Size 100

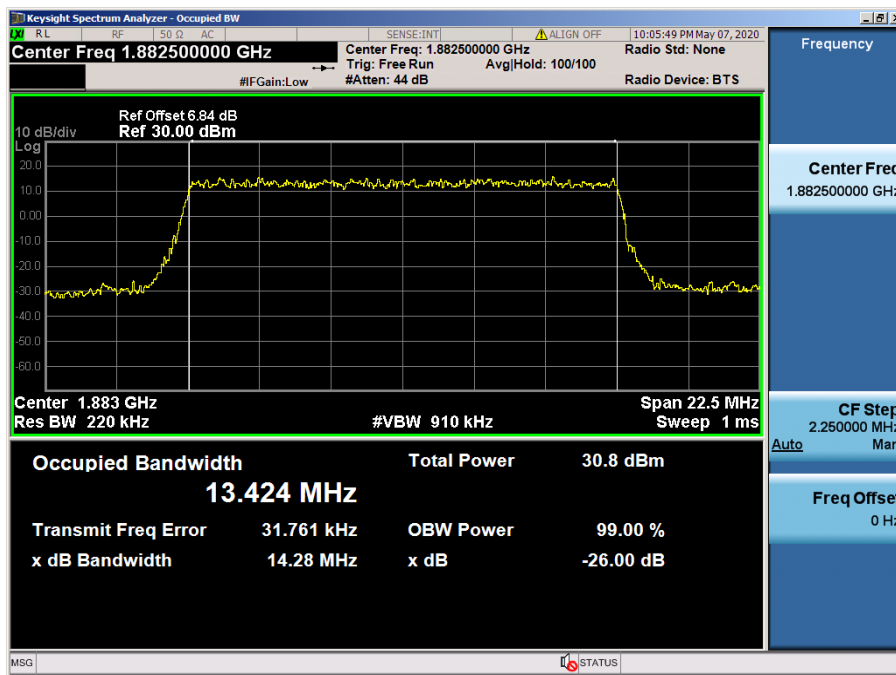

LTE Band 25, 2 / 15 MHz / QPSK - RB Size 75

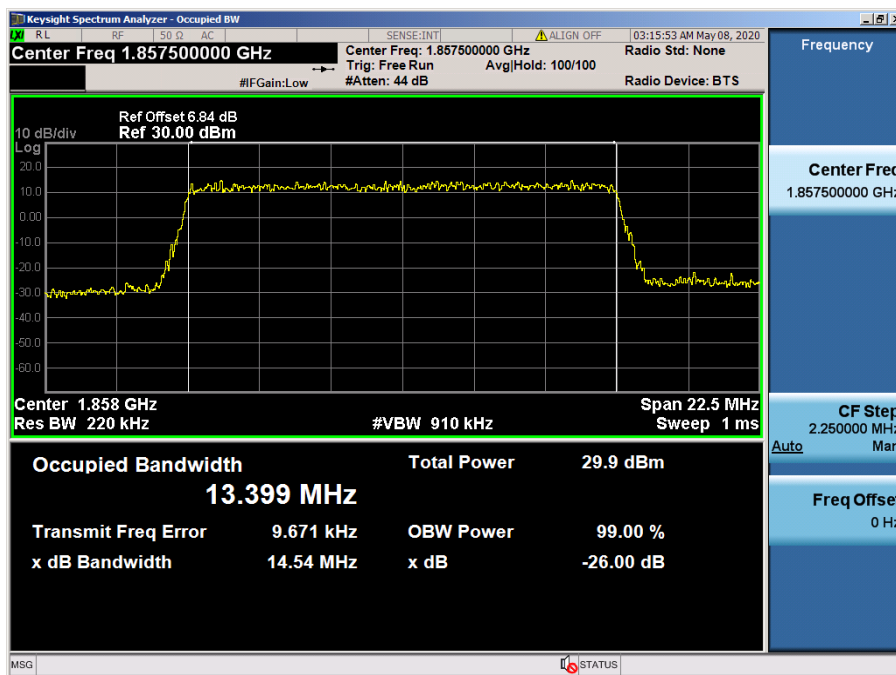

LTE Band 25, 2 / 15 MHz / 16QAM - RB Size 75

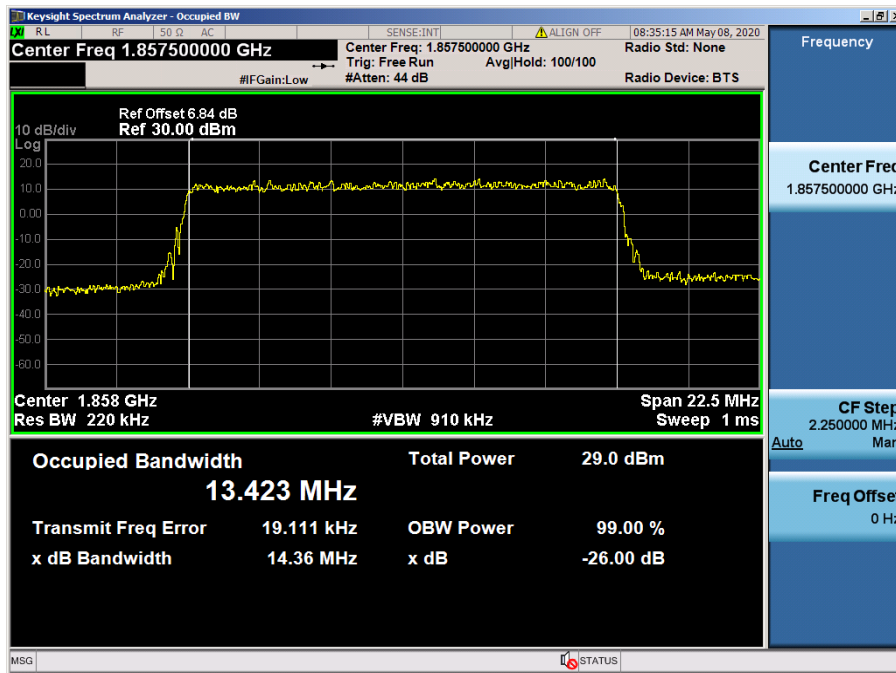

LTE Band 25, 2 / 15 MHz / 64QAM - RB Size 75

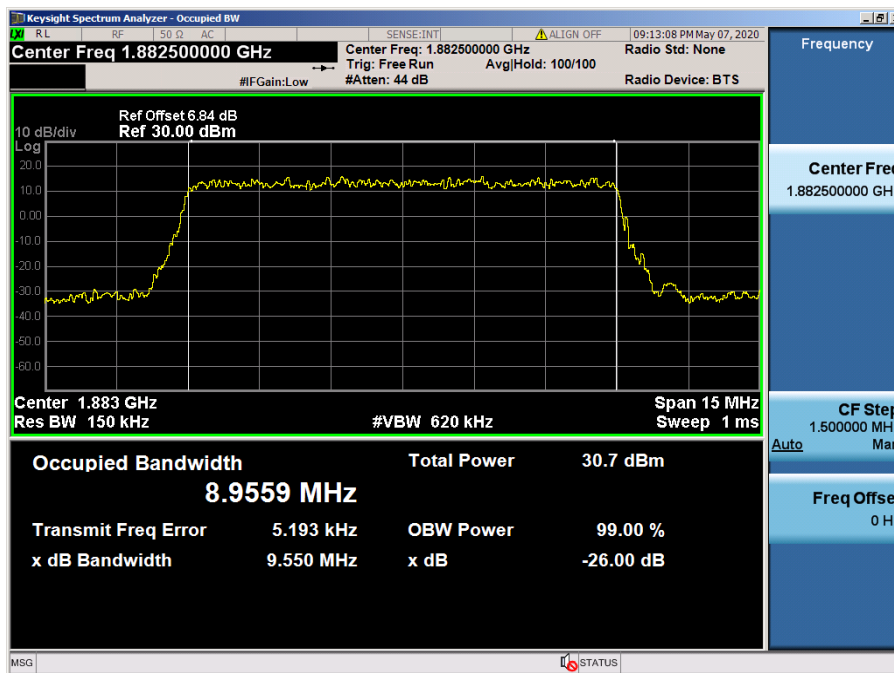

LTE Band 25, 2 / 10 MHz / QPSK - RB Size 50

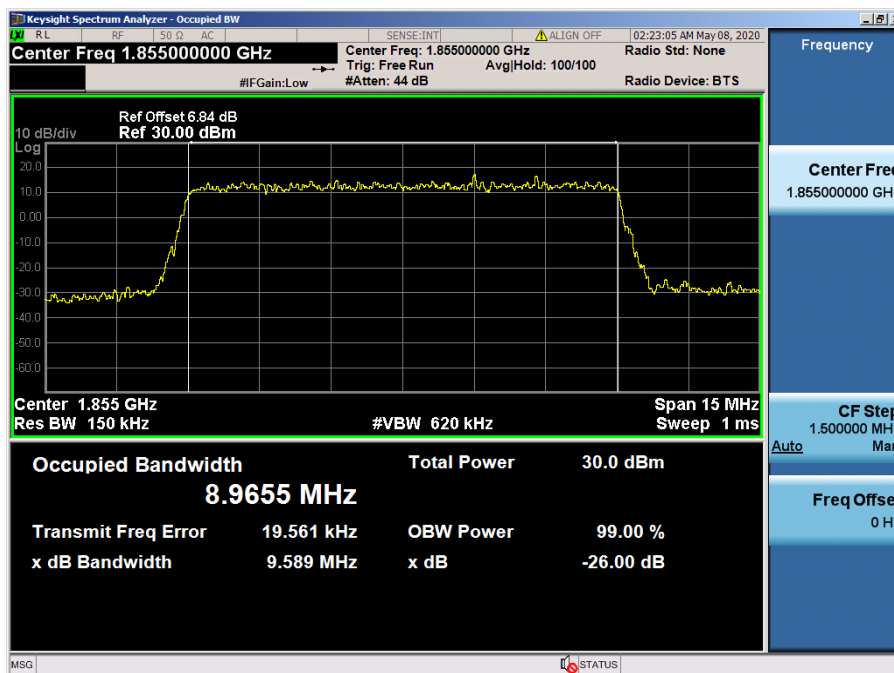

LTE Band 25, 2 / 10 MHz / 16QAM - RB Size 50

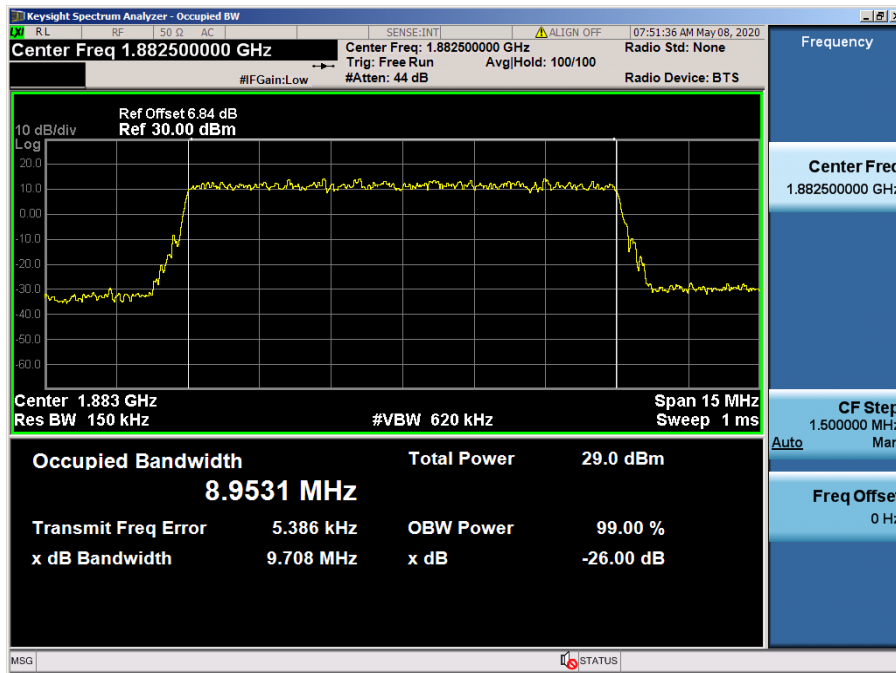

LTE Band 25, 2 / 10 MHz / 64QAM - RB Size 50



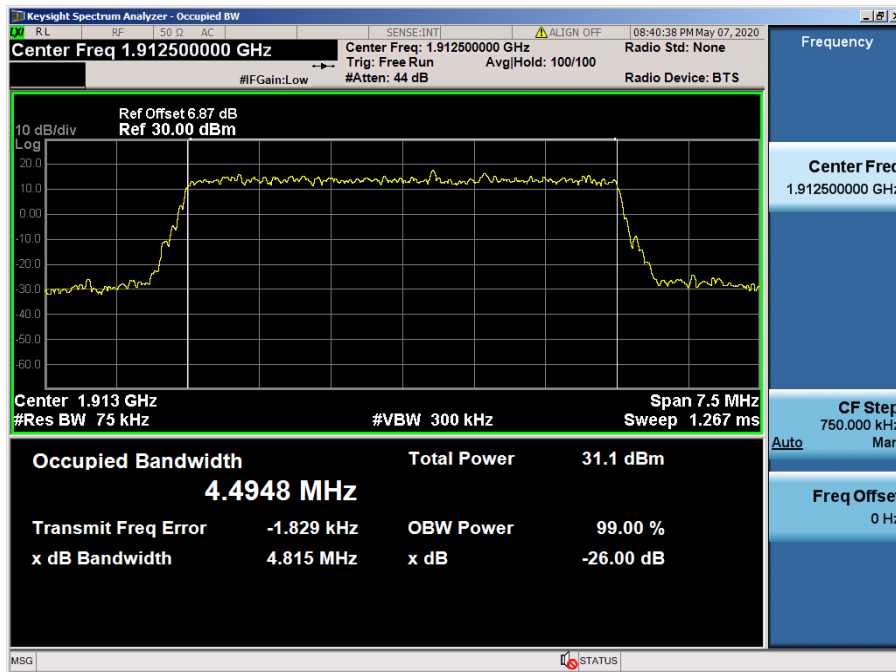

LTE Band 25, 2 / 5 MHz / QPSK - RB Size 25

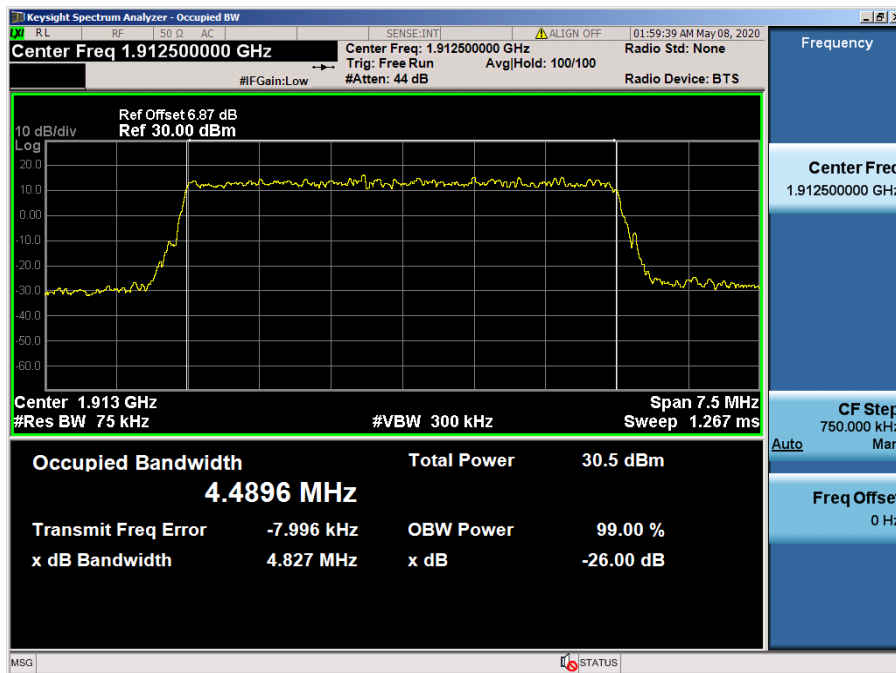

LTE Band 25, 2 / 5 MHz / 16QAM - RB Size 25

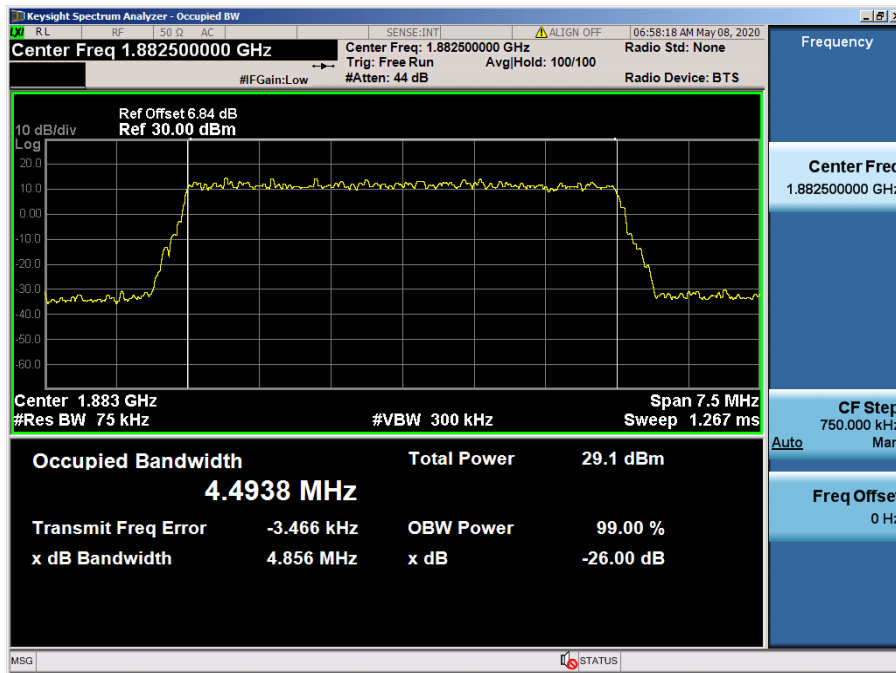

LTE Band 25, 2 / 5 MHz / 64QAM - RB Size 25

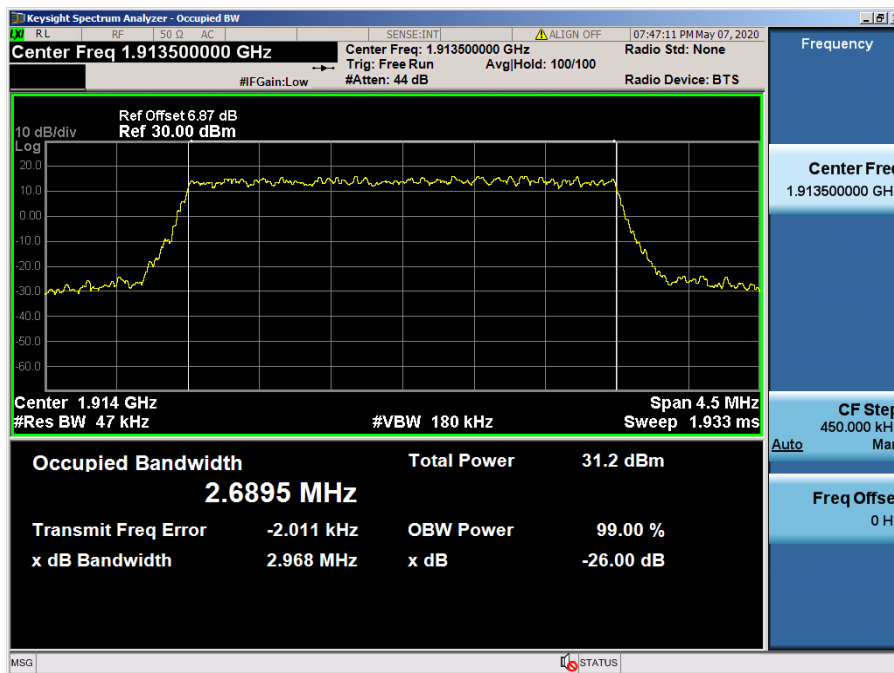

LTE Band 25, 2 / 3 MHz / QPSK - RB Size 15

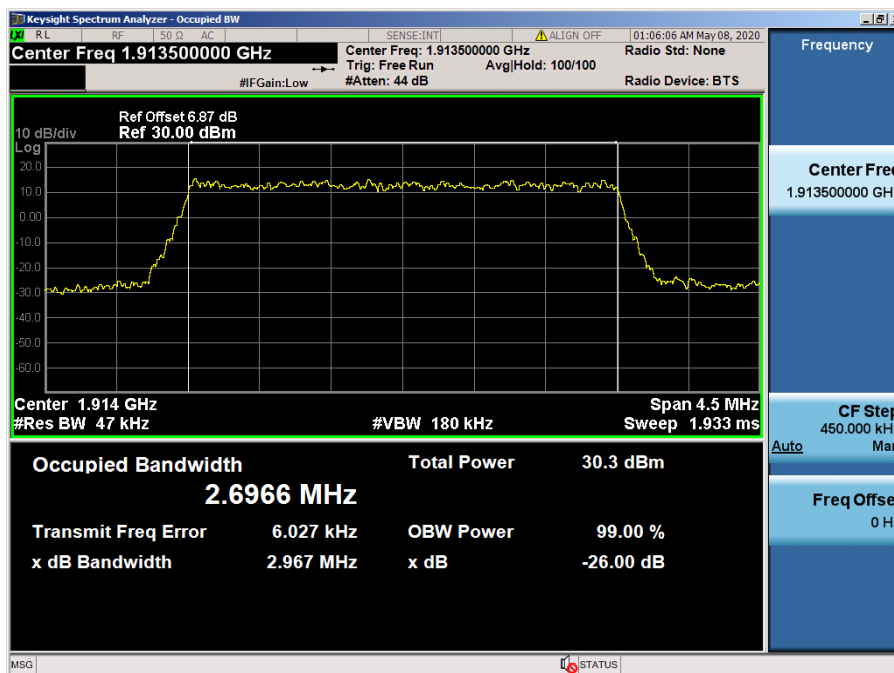

LTE Band 25, 2 / 3 MHz / 16QAM - RB Size 15

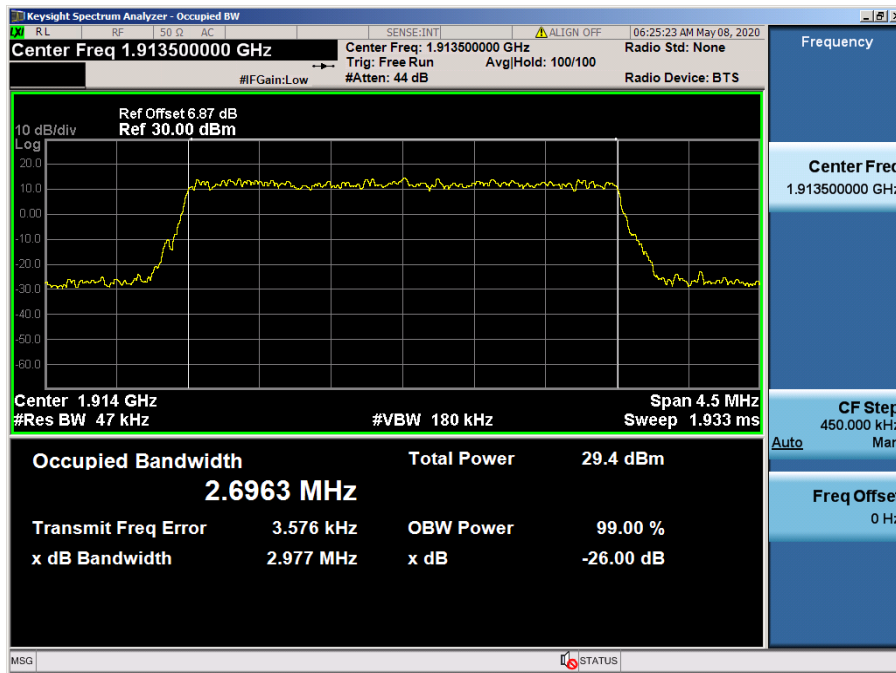

LTE Band 25, 2 / 3 MHz / 64QAM - RB Size 15

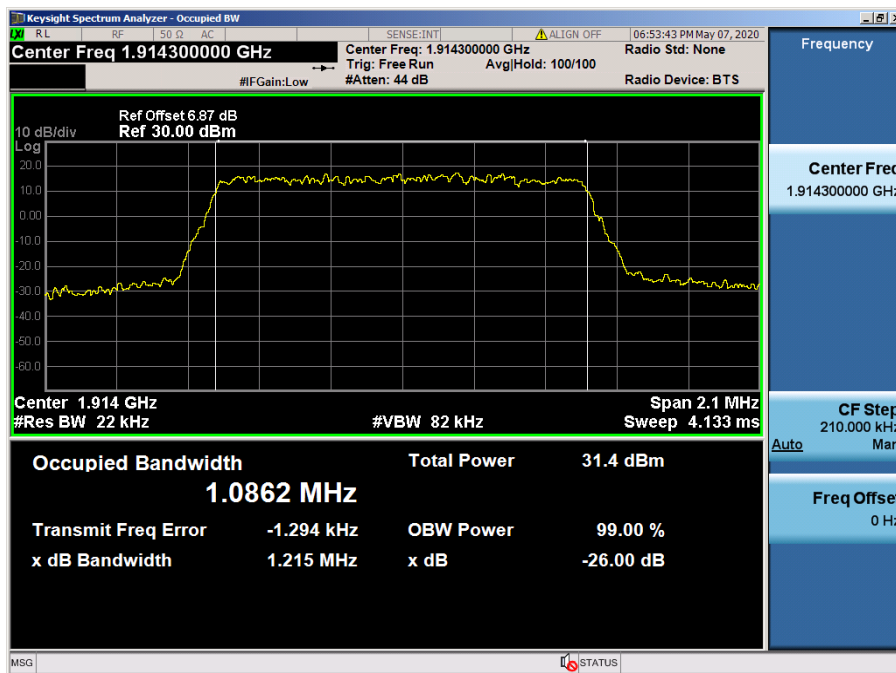

LTE Band 25, 2 / 1.4 MHz / QPSK - RB Size 6

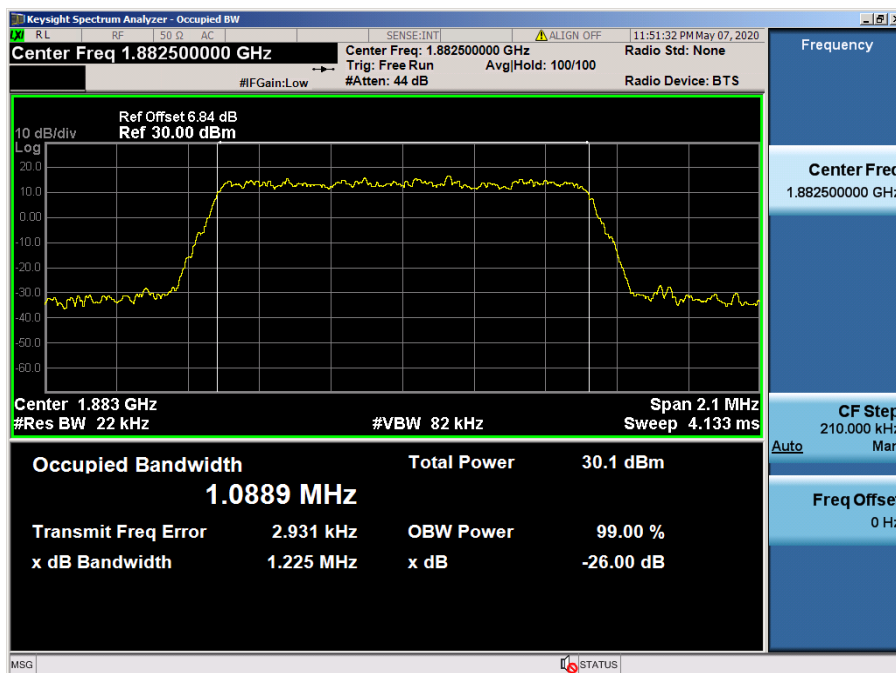

LTE Band 25, 2 / 1.4 MHz / 16QAM - RB Size 6

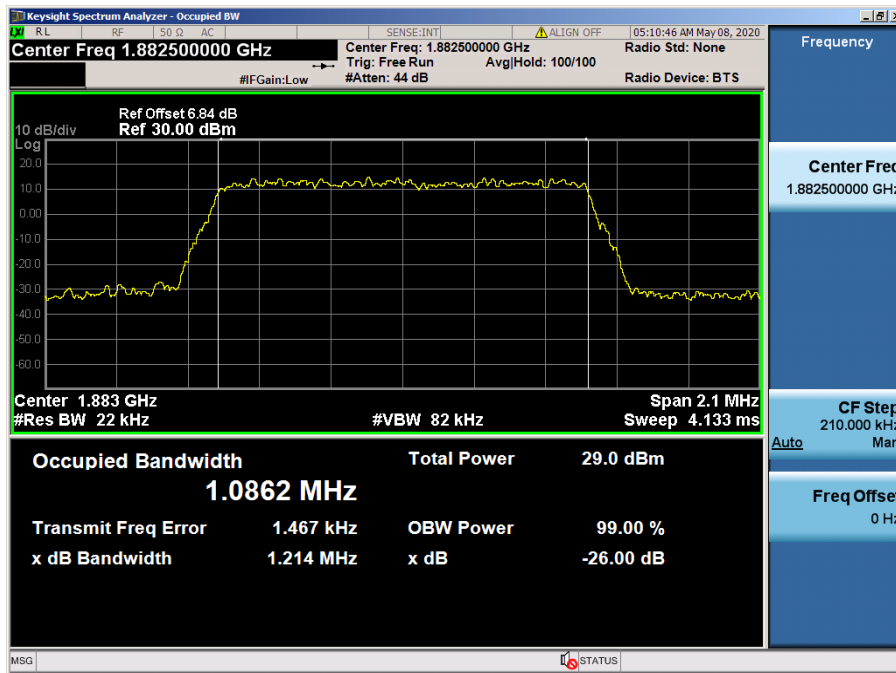

LTE Band 25, 2 / 1.4 MHz / 64QAM - RB Size 6

8.1.8 LTE Band 41

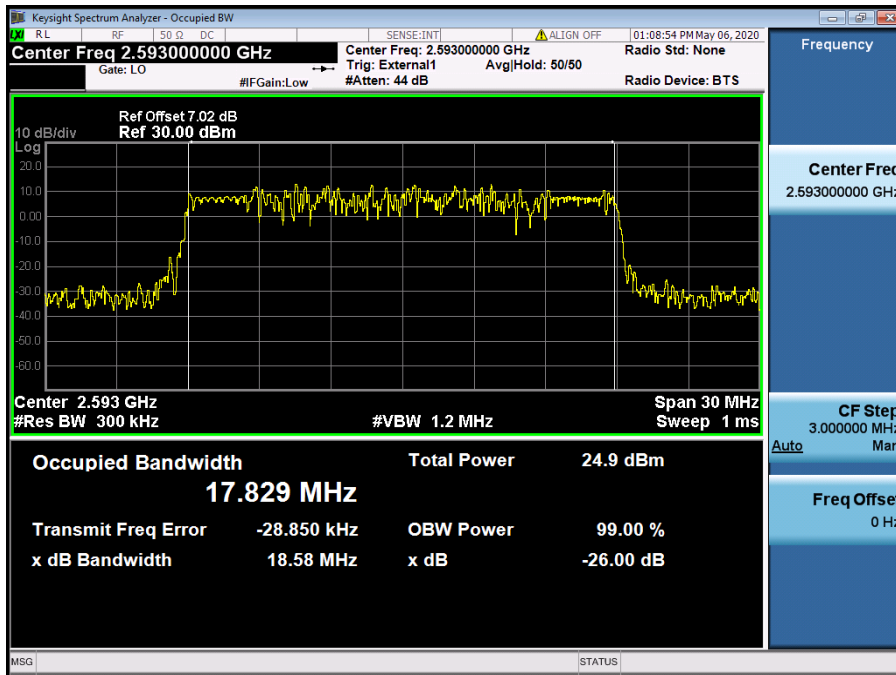

LTE Band 41 / 20 MHz / QPSK - RB Size 100

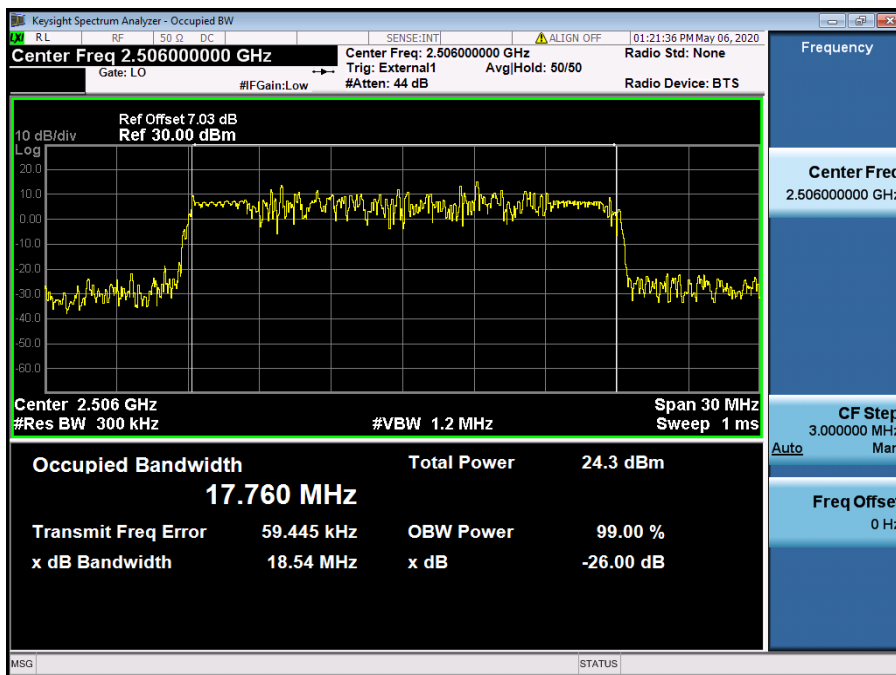

LTE Band 41 / 20 MHz / 16QAM - RB Size 100

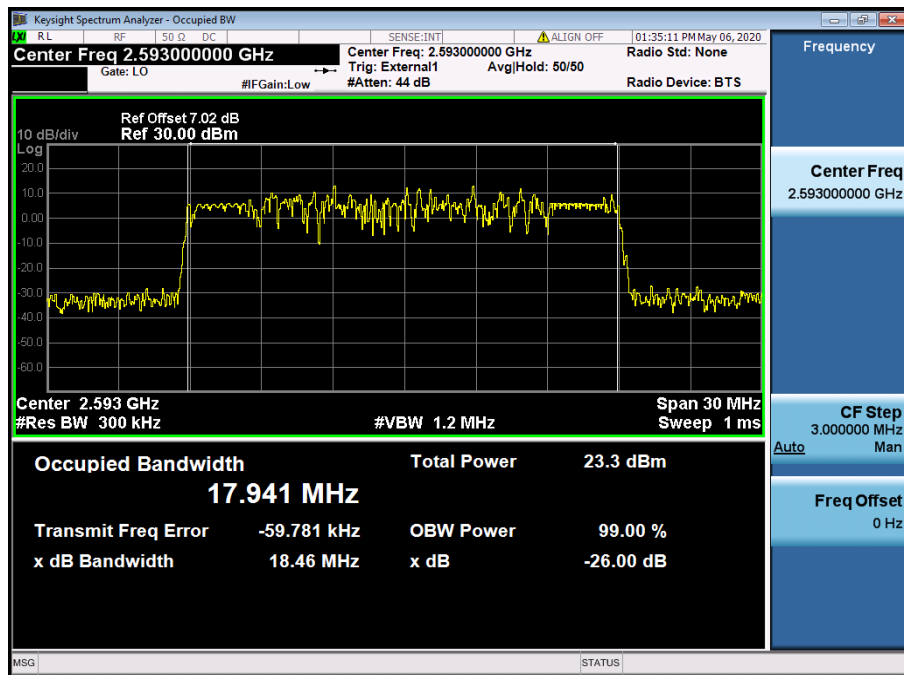

LTE Band 41 / 20 MHz / 64QAM - RB Size 100



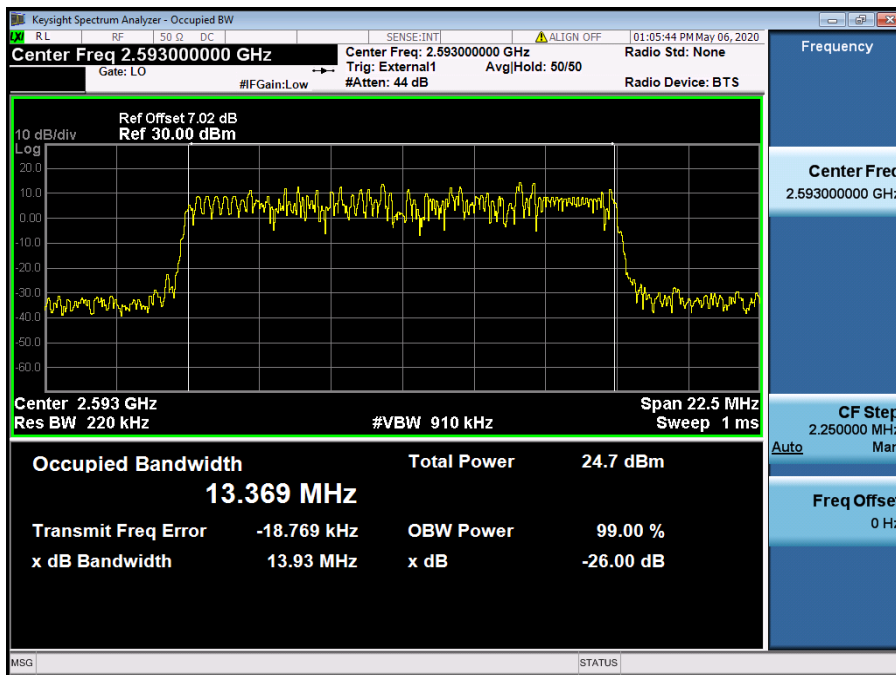

LTE Band 41 / 15 MHz / QPSK - RB Size 75

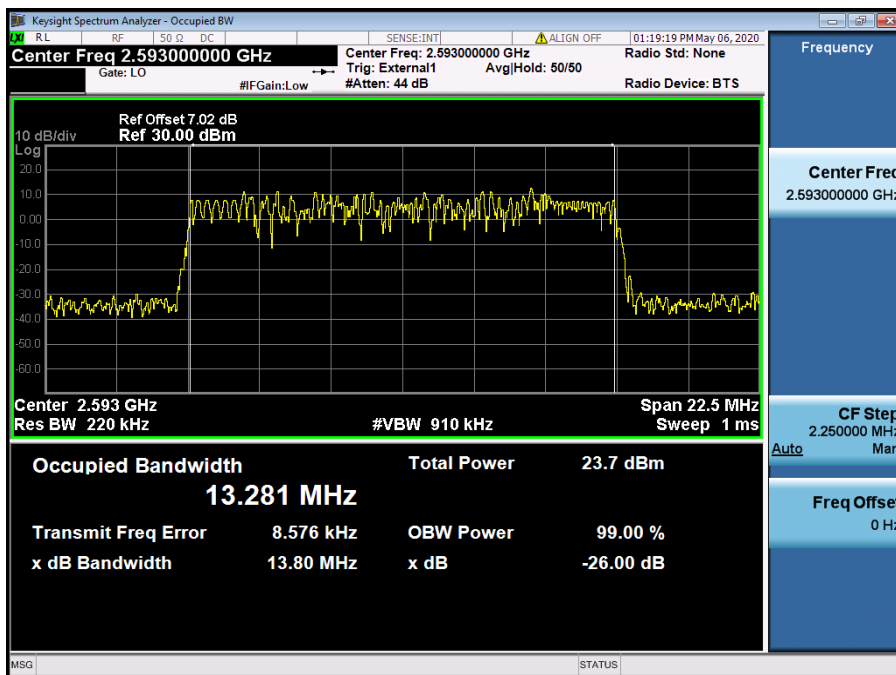

LTE Band 41 / 15 MHz / 16QAM - RB Size 75

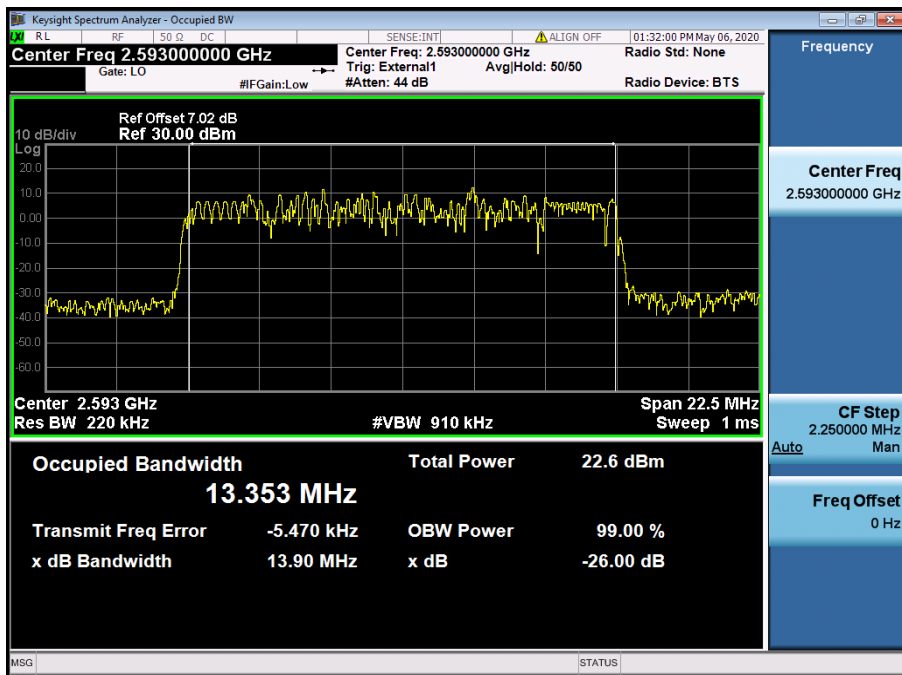

LTE Band 41 / 15 MHz / 64QAM - RB Size 75

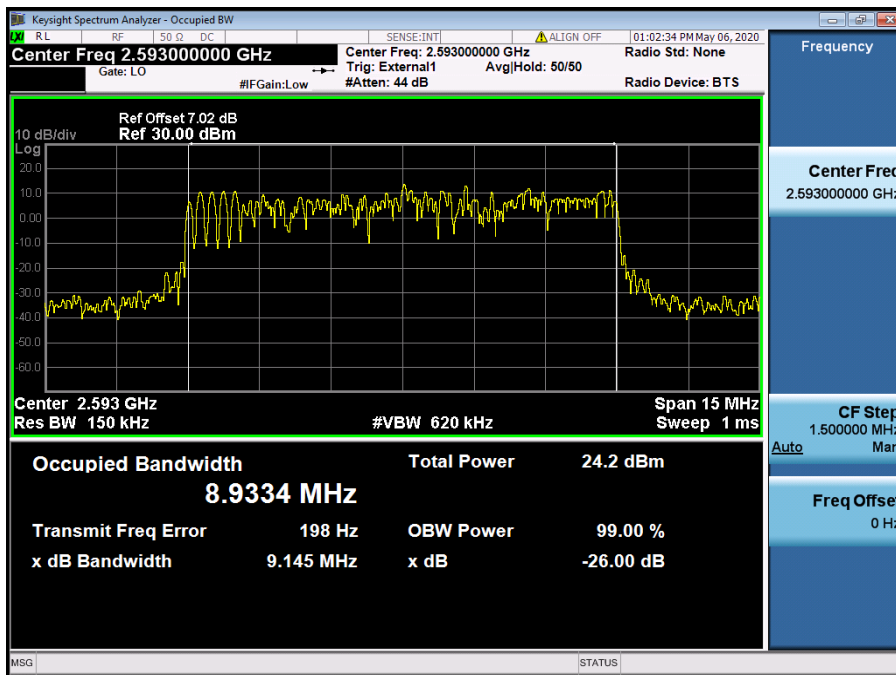

LTE Band 41 / 10 MHz / QPSK - RB Size 50

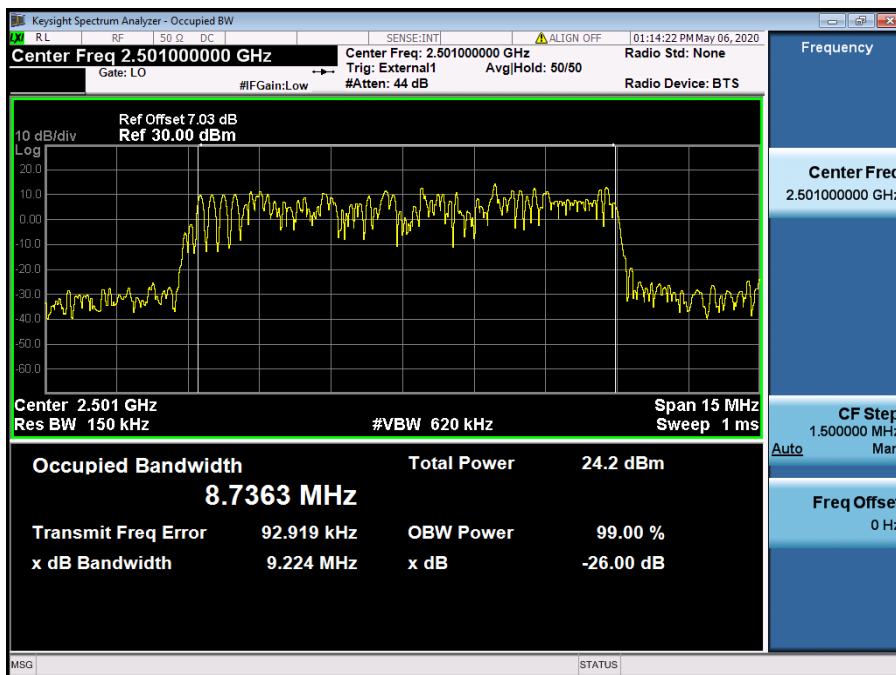

LTE Band 41 / 10 MHz / 16QAM - RB Size 50

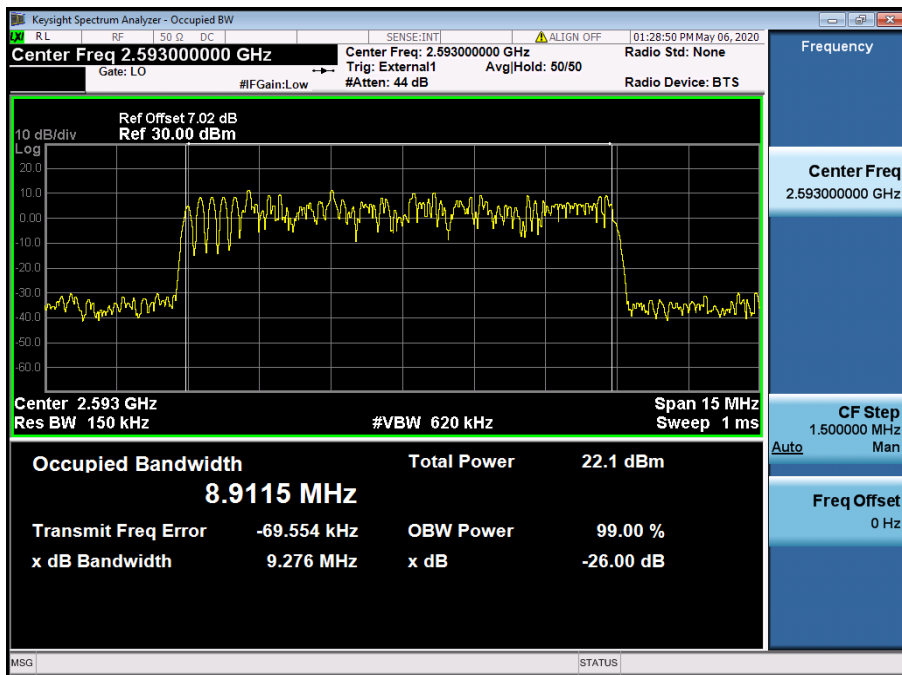

LTE Band 41 / 10 MHz / 64QAM - RB Size 50

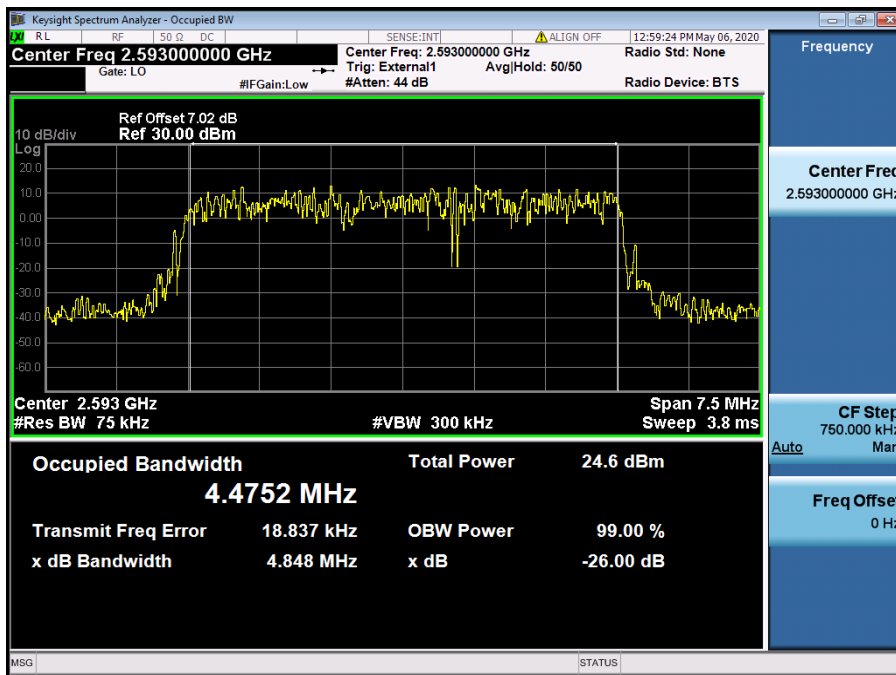

LTE Band 41 / 5 MHz / QPSK - RB Size 25

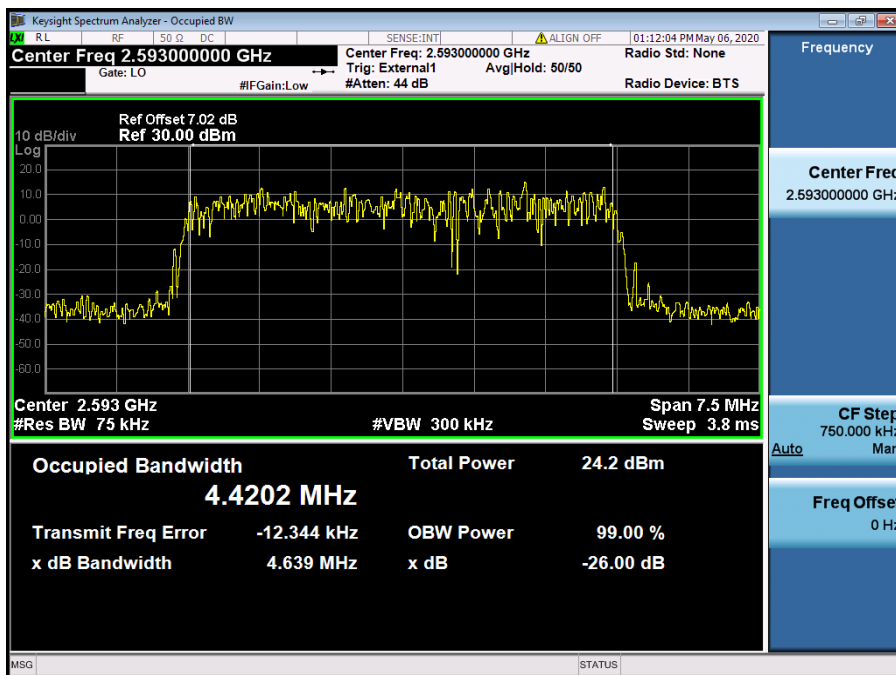

LTE Band 41 / 5 MHz / 16QAM - RB Size 25

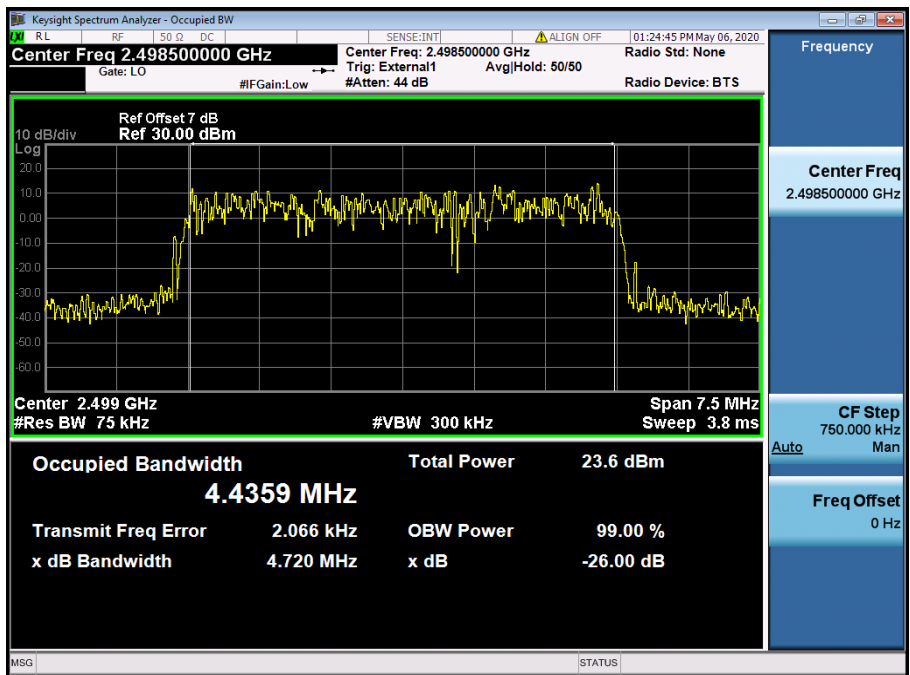

LTE Band 41 / 5 MHz / 64QAM - RB Size 25