

TEST REPORT

of

FCC Part 15 Subpart C §15.247

FCC ID: ZNFEHBSS80

Equipment Under Test : Bluetooth Stereo Headset
Model Name : HBS-S80
Applicant : LG Electronics MobileComm USA. Inc.
Manufacturer : EM-Tech Co., Ltd.
Date of Test(s) : 2016.06.20 ~ 2016.06.27
Date of Issue : 2016.06.27

In the configuration tested, the EUT complied with the standards specified above.

Tested By:



Youngmin Park

Date:

2016.06.27

Approved By:



Alvin Kim

Date:

2016.06.27

The results shown in this test report refer only to the sample(s) tested unless otherwise stated. This test report cannot be reproduced, except in full, without prior written permission of the Company.

SGS Korea Co., Ltd. (Gunpo Laboratory) 4, LS-ro 182beon-gil, Gunpo-si, Gyeonggi-do, Korea, 15807 <http://www.sgsgroup.kr>

INDEX

<u>Table of Contents</u>	Page
1. General Information -----	3
2. Transmitter Radiated Spurious Emissions and Conducted Spurious Emission -----	7
3. 20 dB Bandwidth -----	34
4. Maximum Peak Conducted Output power -----	40
5. Carrier Frequency Separation -----	42
6. Number of Hopping Frequencies -----	45
7. Time of Occupancy(Dwell Time) -----	49
8. Antenna Requirement -----	62

The results shown in this test report refer only to the sample(s) tested unless otherwise stated. This test report cannot be reproduced, except in full, without prior written permission of the Company.

SGS Korea Co., Ltd. (Gunpo Laboratory) 4, LS-ro 182beon-gil, Gunpo-si, Gyeonggi-do, Korea, 15807 <http://www.sgsgroup.kr>

RTT5041-20(2015.10.01)(3)

Tel. +82 31 428 5700 / Fax. +82 31 427 2370

A4(210 mm x 297 mm)

1. General Information

1.1. Testing Laboratory

SGS Korea Co., Ltd. (Gunpo Laboratory)

-Wireless Div. 2FL, 10-2, LS-ro 182beon-gil, Gunpo-si, Gyeonggi-do, Korea, 15807

All SGS services are rendered in accordance with the applicable SGS conditions of service available on request and accessible at <http://www.sgs.com/en/Terms-and-Conditions.aspx>.

Phone No. : +82 31 688 0901

Fax No. : +82 31 688 0921

1.2. Details of Applicant

Applicant : LG Electronics MobileComm USA. Inc.

Address : 1000 Sylvan Avenue Englewood Cliffs, New Jersey, United States

Contact Person : Kim, Kyung-Jung

Phone No. : +201 816 2003

1.3. Description of EUT

Kind of Product	Bluetooth Stereo Headset
Model Name	HBS-S80
Power Supply	DC 3.7 V
Frequency Range	2 402 MHz ~ 2 480 MHz
Modulation Technique	GFSK, $\pi/4$ DQPSK, 8DPSK
Number of Channels	79 channels
Antenna Type	PIFA antenna
Antenna Gain	0.5 dB i
H/W Version	1.0
S/W Version	1.0

The results shown in this test report refer only to the sample(s) tested unless otherwise stated. This test report cannot be reproduced, except in full, without prior written permission of the Company.

SGS Korea Co., Ltd. (Gunpo Laboratory) 4, LS-ro 182beon-gil, Gunpo-si, Gyeonggi-do, Korea, 15807 <http://www.sgsgroup.kr>

1.4. Declaration by the manufacturer

- Adaptive Frequency Hopping is supported and use at least 20 channels.
- The device supports Bluetooth 4.1 version, but it only uses Bluetooth 3.0 version.

1.5. Information about the FHSS characteristics:

1.5.1. Pseudorandom Frequency Hopping Sequence

The channel is represented by a pseudo-random hopping sequence hopping through the 79 RF channels. The hopping sequence is unique for the piconet and is determined by the Bluetooth device address of the master; the phase in the hopping sequence is determined by the Bluetooth clock of the master. The channel is divided into time slots where each slot corresponds to an RF hop frequency. Consecutive hops correspond to different RF hop frequencies. The nominal hop rate is 1 600 hops/s.

1.5.2. Equal Hopping Frequency Use

The channels of this system will be used equally over the long-term distribution of the hopsets.

1.5.3. Example of a 79 hopping sequence in data mode:

02, 05, 31, 24, 20, 10, 43, 36, 30, 23, 40, 06, 21, 50, 44, 09, 71, 78, 01, 13, 73, 07, 70, 72, 35, 62, 42, 11, 41, 08, 16, 29, 60, 15, 34, 61, 58, 04, 67, 12, 22, 53, 57, 18, 27, 76, 39, 32, 17, 77, 52, 33, 56, 46, 37, 47, 64, 49, 45, 38, 69, 14, 51, 26, 79, 19, 28, 65, 75, 54, 48, 03, 25, 66, 05, 16, 68, 74, 59, 63, 55

1.5.4. System Receiver Input Bandwidth

Each channel bandwidth is 1 MHz.

The system receivers have input bandwidths that match the hopping channel bandwidths of their corresponding transmitters and shift frequencies in synchronization with the transmitted signals.

1.5.5. Equipment Description

15.247(a)(1) that the rx input bandwidths shift frequencies in synchronization with the transmitted signals.

15.247(g): In accordance with the Bluetooth Industry Standard, the system is designed to comply with all of the regulations in Section 15.247 when the transmitter is presented with a continuous data (or information) system.

15.247(h): In accordance with the Bluetooth Industry Standard, the system does not coordinate its channels selection/ hopping sequence with other frequency hopping systems for the express purpose of avoiding the simultaneous occupancy of individual hopping frequencies by multiple transmitters.

The results shown in this test report refer only to the sample(s) tested unless otherwise stated. This test report cannot be reproduced, except in full, without prior written permission of the Company.

SGS Korea Co., Ltd. (Gunpo Laboratory) 4, LS-ro 182beon-gil, Gunpo-si, Gyeonggi-do, Korea, 15807 <http://www.sgsgroup.kr>

RTT5041-20(2015.10.01)(3)

Tel. +82 31 428 5700 / Fax. +82 31 427 2370

A4(210 mm x 297 mm)

1.6. Test Equipment List

Equipment	Manufacturer	Model	S/N	Cal. Date	Cal. Interval	Cal. Due
Signal Generator	Agilent	E8257D	MY51501169	Jul. 13, 2015	Annual	Jul. 13, 2016
Signal Generator	Agilent	8648D	3847M00534	Mar. 21, 2016	Annual	Mar. 21, 2017
Spectrum Analyzer	R&S	FSV30	103210	Dec. 23, 2015	Annual	Dec. 23, 2016
Spectrum Analyzer	Agilent	N9020A	MY53421758	Sep. 24, 2015	Annual	Sep. 24, 2016
Bluetooth Tester	TESCOM	TC-3000C	3000C000142	Dec. 02, 2015	Annual	Dec. 02, 2016
Directional Coupler	KRYTAR	152613	162412	Sep. 24, 2015	Annual	Sep. 24, 2016
High Pass Filter	Wainwright Instrument GmbH	WHK3.0/18G-10SS	344	Jun. 03, 2016	Annual	Jun. 03, 2017
High Pass Filter	Wainwright Instrument GmbH	WHNX7.5/26.5G-6SS	15	Jun. 18, 2016	Annual	Jun. 18, 2017
Low Pass Filter	Mini-Circuits	NLP-1200+	V 8979400903-2	Feb. 29, 2016	Annual	Feb. 28, 2017
Power Sensor	R&S	NRP-Z81	100669	Feb. 29, 2016	Annual	Feb. 28, 2017
DC Power Supply	Agilent	U8002A	MY50070064	Mar. 21, 2016	Annual	Mar. 21, 2017
Preamplifier	H.P.	8447F	2944A03909	Aug. 27, 2015	Annual	Aug. 27, 2016
Preamplifier	R&S	SCU-18	10117	Apr. 07, 2016	Annual	Apr. 07, 2017
Preamplifier	MITEQ Inc.	JS44-18004000-35-8P	1546891	May 12, 2016	Annual	May 12, 2017
Loop Antenna	Schwarzbeck Mess-Elektronik	FMZB 1519	1519-039	Aug. 19, 2015	Biennial	Aug. 19, 2017
Bilog Antenna	TESEQ	CBL6122D	25233	Jul. 17, 2015	Biennial	Jul. 17, 2017
Horn Antenna	R&S	HF906	100326	Feb. 01, 2016	Biennial	Feb. 01, 2018
Horn Antenna	Schwarzbeck Mess-Elektronik	BBHA 9170	BBHA9170223	Sep. 01, 2014	Biennial	Sep. 01, 2016
Antenna Master	INNCO systems	MA4640-XP-ET	N/A	N.C.R.	N/A	N.C.R.
Turn Table	INNCO systems	CONTROLLER CO3000	N/A	N.C.R.	N/A	N.C.R.
Test Receiver	R&S	ESU26	100109	Mar. 07, 2016	Annual	Mar. 07, 2017
Anechoic Chamber	SY Corporation	L × W × H (9.6 m × 6.4 m × 6.6 m)	N/A	N.C.R.	N/A	N.C.R.

The results shown in this test report refer only to the sample(s) tested unless otherwise stated. This test report cannot be reproduced, except in full, without prior written permission of the Company.

SGS Korea Co., Ltd. (Gunpo Laboratory) 4, LS-ro 182beon-gil, Gunpo-si, Gyeonggi-do, Korea, 15807 <http://www.sgsgroup.kr>

RTT5041-20(2015.10.01)(3)

Tel. +82 31 428 5700 / Fax. +82 31 427 2370

A4(210 mm × 297 mm)

1.7. Summary of Test Results

The EUT has been tested according to the following specifications:

APPLIED STANDARD:FCC Part15 subpart C		
Standard Section	Test Item	Result
15.205(a) 15.209 15.247(d)	Transmitter Radiated Spurious Emissions and Conducted Spurious Emission	Complied
15.247(a)(1)	20 dB Bandwidth	Complied
15.247(b)(1)	Maximum Peak Conducted Output Power	Complied
15.247(a)(1)	Carrier Frequency Separation	Complied
15.247(a)(1)(iii)	Number of Hopping Frequencies	Complied
15.247(a)(1)(iii)	Time of Occupancy (Dwell Time)	Complied

1.8. Test Procedure(s)

The measurement procedures described in the American National Standard of Procedure for Compliance Testing of unlicensed Wireless Devices (ANSI C63.10-2013) and the guidance provided in DA 00-705 were used in the measurement of the DUT.

1.9. Sample calculation

Where relevant, the following sample calculation is provided:

1.9.1. Conducted test

Offset value (dB) = Directional Coupler (dB) + Cable loss (dB)

1.9.2. Radiation test

Field strength level (dB μ V/m) = Measured level (dB μ V) + Antenna factor (dB) + Cable loss (dB) - Amplifier gain (dB)

1.10. Test report revision

Revision	Report number	Date of Issue	Description
0	F690501/RF-RTL010057	2016.06.27	Initial

The results shown in this test report refer only to the sample(s) tested unless otherwise stated. This test report cannot be reproduced, except in full, without prior written permission of the Company.

SGS Korea Co., Ltd. (Gunpo Laboratory) 4, LS-ro 182beon-gil, Gunpo-si, Gyeonggi-do, Korea, 15807 <http://www.sgsgroup.kr>

RTT5041-20(2015.10.01)(3)

Tel. +82 31 428 5700 / Fax. +82 31 427 2370

A4(210 mm x 297 mm)

2. Transmitter Radiated Spurious Emissions and Conducted Spurious Emission

2.1. Test Setup

2.1.1. Transmitter Radiated Spurious Emissions

The diagram below shows the test setup that is utilized to make the measurements for emission below 30 MHz Emissions.

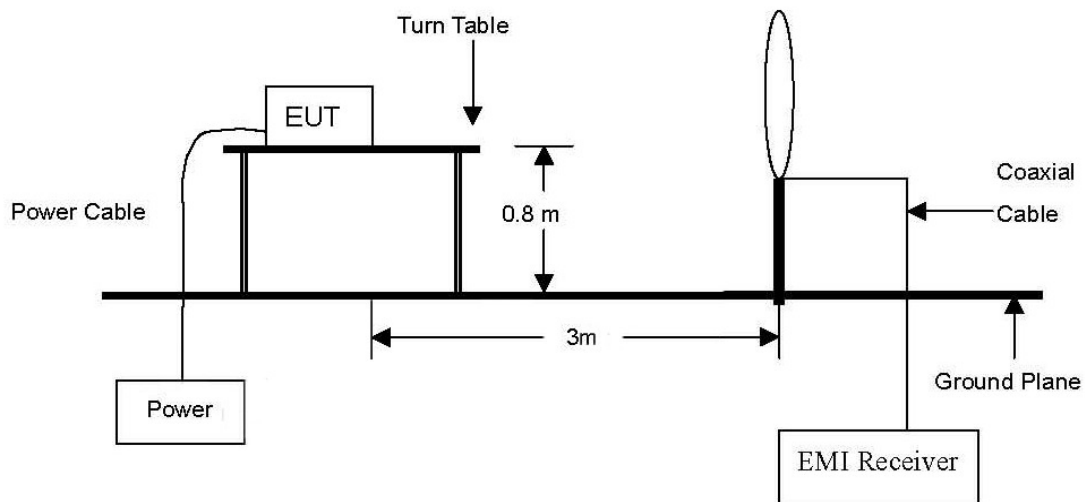

The diagram below shows the test setup that is utilized to make the measurements for emission from 30 MHz to 1 GHz Emissions.

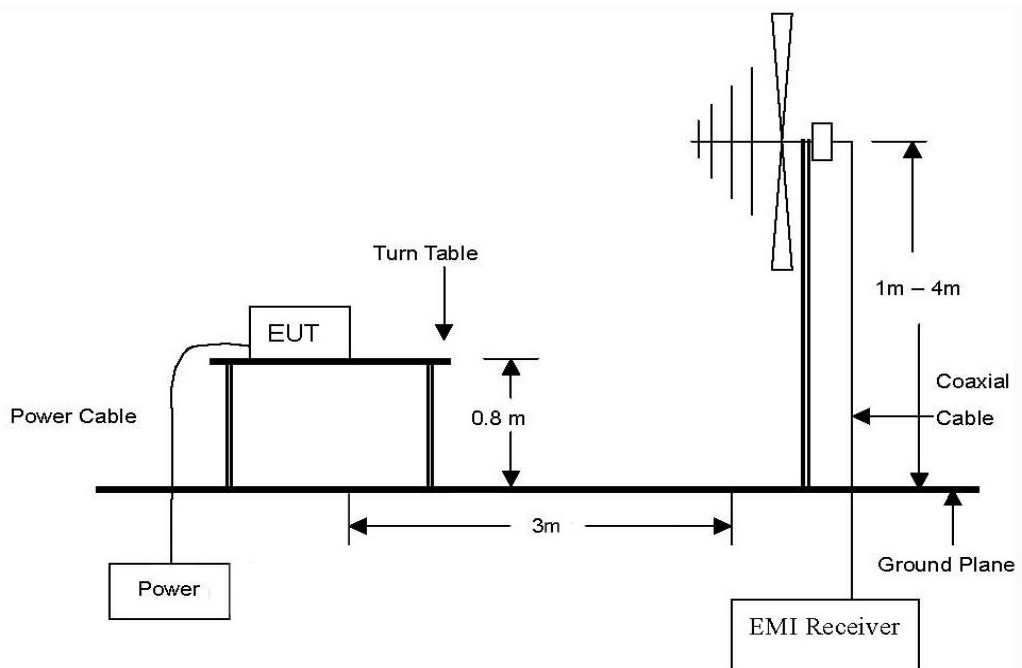

The results shown in this test report refer only to the sample(s) tested unless otherwise stated. This test report cannot be reproduced, except in full, without prior written permission of the Company.

The diagram below shows the test setup that is utilized to make the measurements for emission. The spurious emissions were investigated from 1 GHz to the 10th harmonic of the highest fundamental frequency or 40 GHz, whichever is lower.

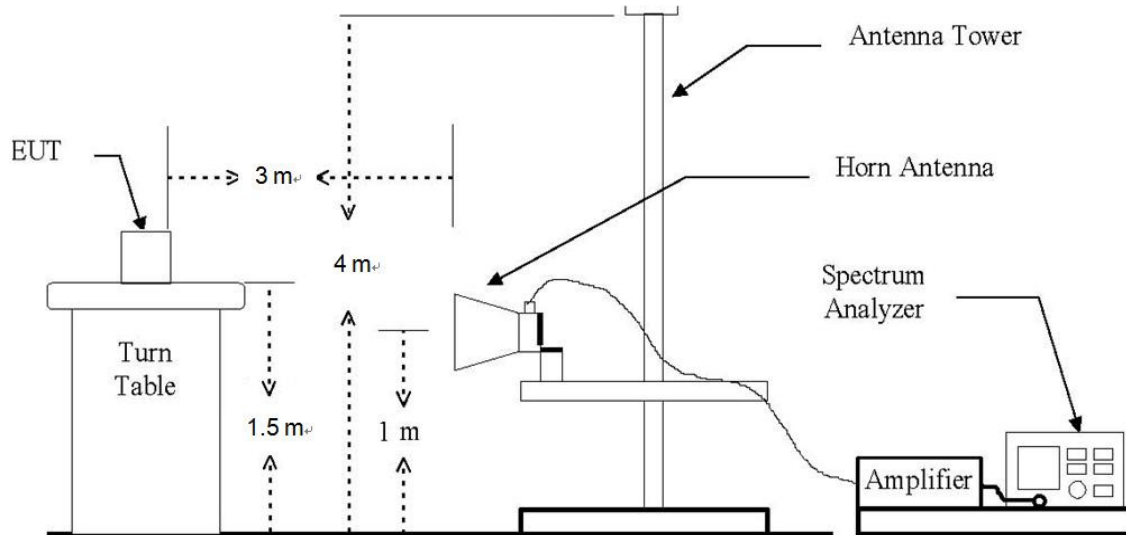

The results shown in this test report refer only to the sample(s) tested unless otherwise stated. This test report cannot be reproduced, except in full, without prior written permission of the Company.

SGS Korea Co., Ltd. (Gunpo Laboratory) 4, LS-ro 182beon-gil, Gunpo-si, Gyeonggi-do, Korea, 15807 <http://www.sgsgroup.kr>

2.1.2. Conducted Spurious Emissions

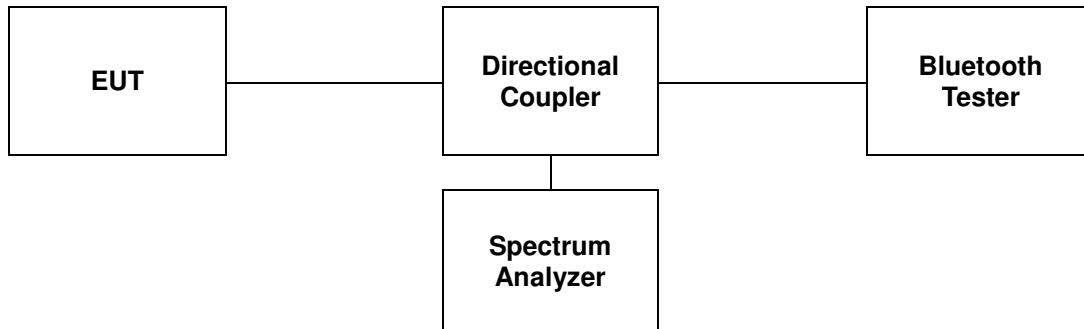

2.2. Limit

According to §15.247(d), in any 100 kHz bandwidth outside the frequency band in which the spread spectrum or digitally modulated intentional radiator is operating, the radio frequency power that is produced by the intentional radiator shall be at least 20 dB below that in the 100 kHz bandwidth within the band that contains the highest level of the desired power, based on either an RF conducted or a radiated measurement, provided the transmitter demonstrates compliance with the peak conducted power limits. If the transmitter complies with the conducted power limits based on the use of RMS averaging over a time interval, as permitted under paragraph(b)(3) of this section, the attenuation required under this paragraph shall be 30 dB instead of 20 dB. Attenuation below the general limits specified in section §15.209(a) is not required. In addition, radiated emission which in the restricted band, as define in section §15.205(a), must also comply the radiated emission limits specified in section §15.209(a) (see section §15.205(c))

According to §15.209(a), Except as provided elsewhere in this Subpart, the emissions from an intentional radiator shall not exceed the field strength levels specified in the following table :

Frequency (MHz)	Distance (Meters)	Field Strength (dBµV/m)	Field Strength (µV/m)
0.009 – 0.490	300	20 log (2 400/F(kHz))	2 400/F(kHz)
0.490 – 1.705	30	20 log (24 000/F(kHz))	24 000/F(kHz)
1.705 – 30.0	30	29.54	30
30 – 88	3	40.0	100
88 – 216	3	43.5	150
216 – 960	3	46.0	200
Above 960	3	54.0	500

The results shown in this test report refer only to the sample(s) tested unless otherwise stated. This test report cannot be reproduced, except in full, without prior written permission of the Company.

2.3. Test Procedures

Radiated emissions from the EUT were measured according to the dictates of ANSI C63.10-2013.

2.3.1. Test Procedures for emission below 30 MHz

1. The EUT was placed on the top of a rotating table 0.8 meters above the ground at a 3 meter anechoic chamber test site. The table was rotated 360 degrees to determine the position of the highest radiation.
2. Then antenna is a loop antenna is fixed at one meter above the ground to determine the maximum value of the field strength. Both parallel and perpendicular of the antenna are set to make the measurement.
3. For each suspected emission, the EUT was arranged to its worst case and then the table was turned from 0 degrees to 360 degrees to find the maximum reading.
4. The test-receiver system was set to average or quasi peak detect function and Specified Bandwidth with Maximum Hold Mode.

2.3.2. Test Procedures for emission from above 30 MHz

1. The EUT was placed on the top of a rotating table 0.8 meters above the ground at a 3 meter anechoic chamber test site below 1 GHz and 1.5 meter above the ground at a 3 meter anechoic chamber test site above 1 GHz. The table was rotated 360 degrees to determine the position of the highest radiation.
2. During performing radiated emission below 1 GHz, the EUT was set 3 meters away from the interference receiving antenna, which was mounted on the top of a variable-height antenna tower. During performing radiated emission above 1 GHz, the EUT was set 3 meter away from the interference-receiving antenna.
3. The antenna is a bi-log antenna, a horn antenna and its height is varied from one meter to four meters above the ground to determine the maximum value of the field strength. Both horizontal and vertical polarizations of the antenna are set to make the measurement.
4. For each suspected emission, the EUT was arranged to its worst case and then the antenna was tuned to heights from 1 meter to 4 meters and the table was turned from 0 degrees to 360 degrees to find the maximum reading.
5. The test-receiver system was set to Peak Detect Function and Specified Bandwidth with Maximum Hold Mode.
6. If the emission level of the EUT in peak mode was 10 dB lower than the limit specified, then testing could be stopped and the peak values of the EUT would be reported. Otherwise the emissions that did not have 10 dB margin would be re-tested one by one using peak, quasi-peak or average method as specified and then reported in a data sheet.

The results shown in this test report refer only to the sample(s) tested unless otherwise stated. This test report cannot be reproduced, except in full, without prior written permission of the Company.

SGS Korea Co., Ltd. (Gunpo Laboratory) 4, LS-ro 182beon-gil, Gunpo-si, Gyeonggi-do, Korea, 15807 <http://www.sgsgroup.kr>

RTT5041-20(2015.10.01)(3)

Tel. +82 31 428 5700 / Fax. +82 31 427 2370

A4(210 mm x 297 mm)

NOTE;

All data rates and modes were investigated for radiated spurious emissions. Only the radiated emissions of the configuration that produced the worst case emissions are reported in this section.

1. The resolution bandwidth and video bandwidth of test receiver/spectrum analyzer is 120 kHz for Peak detection (PK) and Quasi-peak detection (QP) at frequency below 1 GHz.
2. The resolution bandwidth and video bandwidth of test receiver/spectrum analyzer is 1 MHz for Peak detection and frequency above 1 GHz.
3. According to 15.35 (c), as a "duty cycle correction factor", pulse averaging with $20 \log(\text{worst case dwell time} / 100 \text{ ms})$ has to be used for average result.
4. Definition of DUT Axis.
Definition of the test orthogonal plans for EUT was described in the test setup photo.
The test orthogonal plan of EUT is **Y-axis** during radiation test.

2.3.3. Test Procedures for Conducted Spurious Emissions**2.3.3.1. Band-edge Compliance of RF Conducted Emissions**

The transmitter output was connected to the spectrum analyzer.

Span = wide enough to capture the peak level of the emission operating on the channel closest to the band edge, as well as any modulation products which fall outside of the authorized band of operation.

RBW \geq 100 kHz

VBW \geq RBW

Sweep = auto

Detector function = peak

Trace = max hold

2.3.3.2. Spurious RF Conducted Emissions

The transmitter output was connected to the spectrum analyzer.

RBW = 100 kHz

VBW \geq RBW

Sweep = auto

Detector function = peak

Trace = max hold

2.3.3.3. TDF function

- For plots showing conducted spurious emissions from 9 kHz to 25 GHz, all path loss of wide frequency range was investigated and compensated to spectrum analyzer as TDF function.
So, the reading values shown in plots were final result.

The results shown in this test report refer only to the sample(s) tested unless otherwise stated. This test report cannot be reproduced, except in full, without prior written permission of the Company.

SGS Korea Co., Ltd. (Gunpo Laboratory) 4, LS-ro 182beon-gil, Gunpo-si, Gyeonggi-do, Korea, 15807 <http://www.sgsgroup.kr>

RTT5041-20(2015.10.01)(3)

Tel. +82 31 428 5700 / Fax. +82 31 427 2370

A4(210 mm x 297 mm)

2.4. Test Results

Ambient temperature : (23 ± 1) °C
 Relative humidity : 47 % R.H.

2.4.1. Radiated Spurious Emission below 1 000 MHz

The frequency spectrum from 9 kHz to 1 000 MHz was investigated. All reading values are peak values.

Radiated Emissions			Ant.	Correction Factors		Total	Limit	
Frequency (MHz)	Reading (dBμV)	Detect Mode	Pol.	AF (dB/m)	AMP + CL (dB)	Actual (dBμV/m)	Limit (dBμV/m)	Margin (dB)
184.59	52.40	Peak	H	11.03	-25.78	37.65	43.50	5.85
221.54	45.40	Peak	H	11.97	-25.51	31.86	46.00	14.14
230.79	46.80	Peak	H	12.48	-25.45	33.83	46.00	12.17
584.64	38.50	Peak	V	19.66	-25.66	32.50	46.00	13.50
728.16	34.50	Peak	H	21.16	-25.15	30.51	46.00	15.49
836.80	42.40	Peak	H	21.06	-24.61	38.85	46.00	7.15
Above 900.00	Not detected	-	-	-	-	-	-	-

Test plot

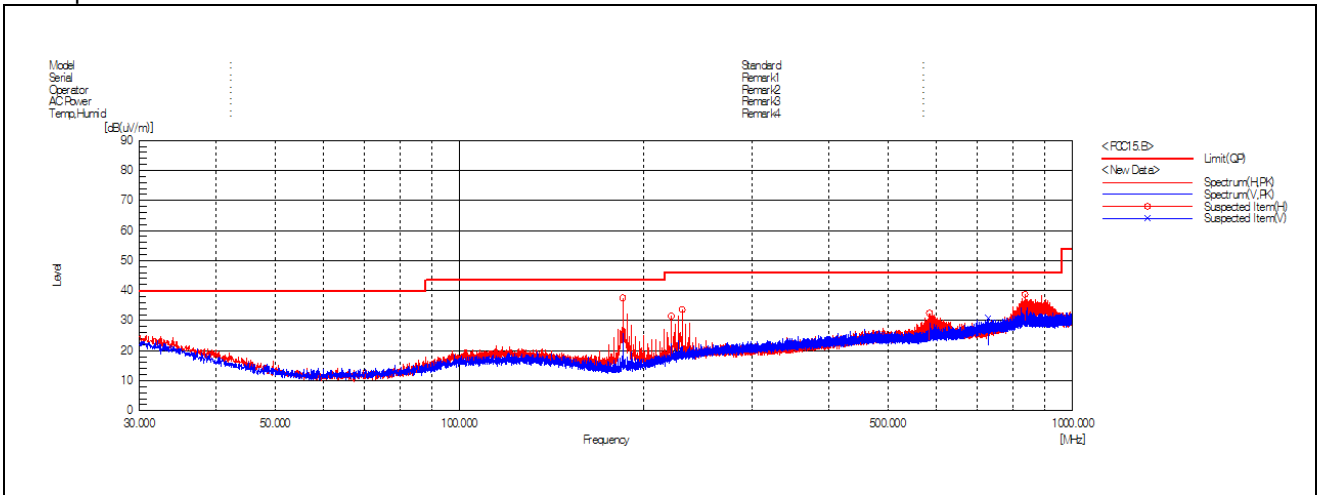

Remark:

1. Spurious emissions for all channels and modes were investigated and almost the same below 1 GHz.
2. Reported spurious emissions are in **BDR / DH5 / Middle channel** as worst case among other modes.
3. Radiated spurious emission measurement as below.
(Actual = Reading + AF + AMP+ CL)
4. According to §15.31(o), emission levels are not report much lower than the limits by over 20 dB.

The results shown in this test report refer only to the sample(s) tested unless otherwise stated. This test report cannot be reproduced, except in full, without prior written permission of the Company.

2.4.2. Radiated Spurious Emission above 1 000 MHz

The frequency spectrum above 1 000 MHz was investigated. All reading values are peak and average values.

Operating Mode: GFSK (1 Mbps)

A. Low Channel (2 402 MHz)

Radiated Emissions			Ant.	Correction Factors			Total	Limit	
Frequency (MHz)	Reading (dB μ V)	Detect Mode	Pol.	AF (dB/m)	CL (dB)	Duty Factor	Actual (dB μ V/m)	Limit (dB μ V/m)	Margin (dB)
2 310.00	23.31	Peak	H	28.07	5.69	-	57.07	74.00	16.93
2 310.00	23.31	Average	H	28.07	5.69	-24.70	32.37	54.00	21.63
2 378.32	25.67	Peak	H	28.14	5.81	-	59.62	74.00	14.38
2 378.32	25.67	Average	H	28.14	5.81	-24.70	34.92	54.00	19.08
2 390.00	23.68	Peak	H	28.15	5.79	-	57.62	74.00	16.38
2 390.00	23.68	Average	H	28.15	5.79	-24.70	32.92	54.00	21.08

Radiated Emissions			Ant.	Correction Factors			Total	Limit	
Frequency (MHz)	Reading (dB μ V)	Detect Mode	Pol.	AF (dB/m)	AMP+CL (dB)	Duty Factor	Actual (dB μ V/m)	Limit (dB μ V/m)	Margin (dB)
Above 1 000.00	Not detected	-	-	-	-	-	-	-	-

The results shown in this test report refer only to the sample(s) tested unless otherwise stated. This test report cannot be reproduced, except in full, without prior written permission of the Company.

B. Middle Channel (2 441 MHz)

Radiated Emissions			Ant.	Correction Factors			Total	Limit	
Frequency (MHz)	Reading (dB μ V)	Detect Mode	Pol.	AF (dB/m)	AMP+CL (dB)	Duty Factor	Actual (dB μ V/m)	Limit (dB μ V/m)	Margin (dB)
*7 322.51	46.79	Peak	H	35.75	-26.91	-	55.63	74.00	18.37
*7 322.51	46.79	Average	H	35.75	-26.91	-24.70	30.93	54.00	23.07
Above 7 400.00	Not detected	-	-	-	-	-	-	-	-

C. High Channel (2 480 MHz)

Radiated Emissions			Ant.	Correction Factors			Total	Limit	
Frequency (MHz)	Reading (dB μ V)	Detect Mode	Pol.	AF (dB/m)	CL (dB)	Duty Factor	Actual (dB μ V/m)	Limit (dB μ V/m)	Margin (dB)
2 483.50	27.31	Peak	H	28.24	5.82	-	61.37	74.00	12.63
2 483.50	27.31	Average	H	28.24	5.82	-24.70	36.67	54.00	17.33
2 484.39	27.36	Peak	H	28.24	5.82	-	61.42	74.00	12.58
2 484.39	27.36	Average	H	28.24	5.82	-24.70	36.72	54.00	17.28
2 500.00	25.91	Peak	H	28.26	5.85	-	60.02	74.00	13.98
2 500.00	25.91	Average	H	28.26	5.85	-24.70	35.32	54.00	18.68

Radiated Emissions			Ant.	Correction Factors			Total	Limit	
Frequency (MHz)	Reading (dB μ V)	Detect Mode	Pol.	AF (dB/m)	AMP+CL (dB)	Duty Factor	Actual (dB μ V/m)	Limit (dB μ V/m)	Margin (dB)
*7 439.63	45.66	Peak	H	35.90	-24.50	-	57.06	74.00	16.94
*7 439.63	45.66	Average	H	35.90	-24.50	-24.70	32.36	54.00	21.64
Above 7 500.00	Not detected	-	-	-	-	-	-	-	-

The results shown in this test report refer only to the sample(s) tested unless otherwise stated. This test report cannot be reproduced, except in full, without prior written permission of the Company.

Operating Mode: 8DPSK (3 Mbps)

A. Low Channel (2 402 MHz)

Radiated Emissions			Ant.	Correction Factors			Total	Limit	
Frequency (MHz)	Reading (dB μ V)	Detect Mode	Pol.	AF (dB/m)	CL (dB)	Duty Factor	Actual (dB μ V/m)	Limit (dB μ V/m)	Margin (dB)
2 310.00	24.86	Peak	H	28.07	5.69	-	58.62	74.00	15.38
2 310.00	24.86	Average	H	28.07	5.69	-24.70	33.92	54.00	20.08
2 319.47	27.33	Peak	H	28.08	5.68	-	61.09	74.00	12.91
2 319.47	27.33	Average	H	28.08	5.68	-24.70	36.39	54.00	17.61
2 390.00	24.46	Peak	H	28.15	5.79	-	58.40	74.00	15.60
2 390.00	24.46	Average	H	28.15	5.79	-24.70	33.70	54.00	20.30

Radiated Emissions			Ant.	Correction Factors			Total	Limit	
Frequency (MHz)	Reading (dB μ V)	Detect Mode	Pol.	AF (dB/m)	AMP+CL (dB)	Duty Factor	Actual (dB μ V/m)	Limit (dB μ V/m)	Margin (dB)
Above 1 000.00	Not detected	-	-	-	-	-	-	-	-

B. Middle Channel (2 441 MHz)

Radiated Emissions			Ant.	Correction Factors			Total	Limit	
Frequency (MHz)	Reading (dB μ V)	Detect Mode	Pol.	AF (dB/m)	AMP+CL (dB)	Duty Factor	Actual (dB μ V/m)	Limit (dB μ V/m)	Margin (dB)
Above 1 000.00	Not detected	-	-	-	-	-	-	-	-

The results shown in this test report refer only to the sample(s) tested unless otherwise stated. This test report cannot be reproduced, except in full, without prior written permission of the Company.

C. High Channel (2 480 MHz)

Radiated Emissions			Ant.	Correction Factors			Total	Limit	
Frequency (MHz)	Reading (dB μ V)	Detect Mode	Pol.	AF (dB/m)	CL (dB)	Duty Factor	Actual (dB μ V/m)	Limit (dB μ V/m)	Margin (dB)
2 483.50	25.04	Peak	H	28.24	5.82	-	59.10	74.00	14.90
2 483.50	25.04	Average	H	28.24	5.82	-24.70	34.40	54.00	19.60
2 488.73	26.79	Peak	H	28.25	5.83	-	60.87	74.00	13.13
2 488.73	26.79	Average	H	28.25	5.83	-24.70	36.17	54.00	17.83
2 500.00	25.91	Peak	H	28.26	5.85	-	60.02	74.00	13.98
2 500.00	25.91	Average	H	28.26	5.85	-24.70	35.32	54.00	18.68

Radiated Emissions			Ant.	Correction Factors			Total	Limit	
Frequency (MHz)	Reading (dB μ V)	Detect Mode	Pol.	AF (dB/m)	AMP+CL (dB)	Duty Factor	Actual (dB μ V/m)	Limit (dB μ V/m)	Margin (dB)
Above 1 000.00	Not detected	-	-	-	-	-	-	-	-

Remarks;

1. "*" means the restricted band.
2. Measuring frequencies from 1 GHz to the 10th harmonic of highest fundamental frequency.
3. Radiated emissions measured in frequency above 1 000 MHz were made with an instrument using peak/average detector mode.
4. Actual = Reading + AF + AMP + CL + Duty Factor or Reading + AF + CL + Duty Factor.
5. According to § 15.31(o), emission levels are not reported much lower than the limits by over 20 dB.
6. Duty Cycle Correction factor formula:
 - Time to cycle through all channels = $\Delta t = T [\text{ms}] \times 20 \text{ channels} = 58.2 \text{ ms}$, where T = pulse width
 - $100 \text{ ms} / \Delta t [\text{ms}] = H \rightarrow$ Round up to next highest integer, $H' = 2$
 - Worst Case Dwell Time = $T[\text{ms}] \times H' = 5.82 \text{ ms}$
 - Duty Cycle Correction = $20\log (\text{Worst Case Dwell Time} / 100 \text{ ms}) \text{ dB} = -24.70 \text{ dB}$

The results shown in this test report refer only to the sample(s) tested unless otherwise stated. This test report cannot be reproduced, except in full, without prior written permission of the Company.

SGS Korea Co., Ltd. (Gunpo Laboratory) 4, LS-ro 182beon-gil, Gunpo-si, Gyeonggi-do, Korea, 15807 <http://www.sgsgroup.kr>

2.4.3. Spurious RF Radiated Emissions: Plot of Spurious RF Radiated Emission

Operating Mode: GFSK (1 Mbps)

Low Channel Band edge (Peak)

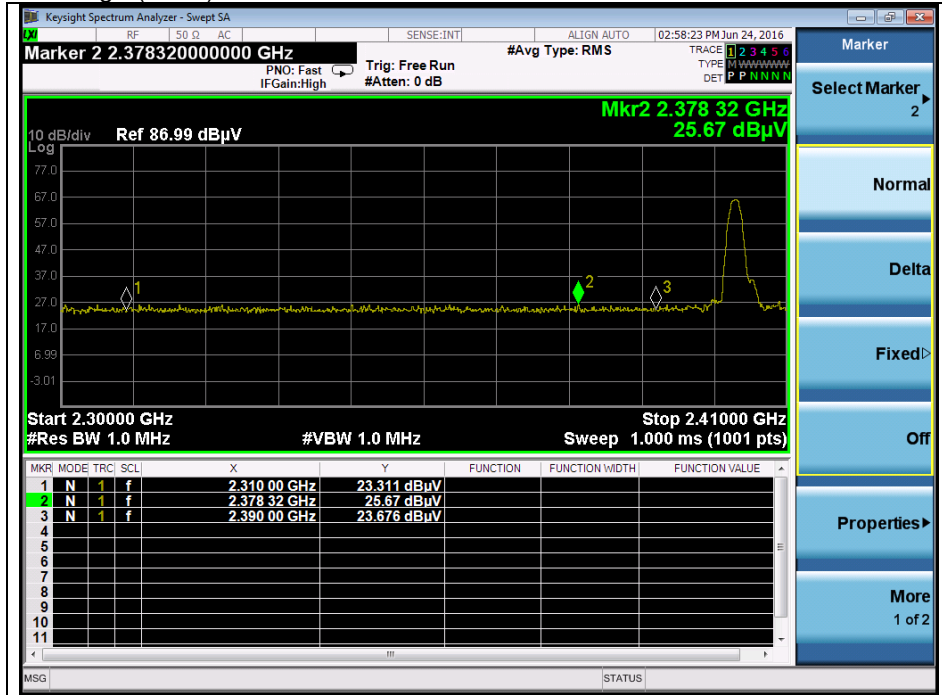

High Channel Band edge (Peak)

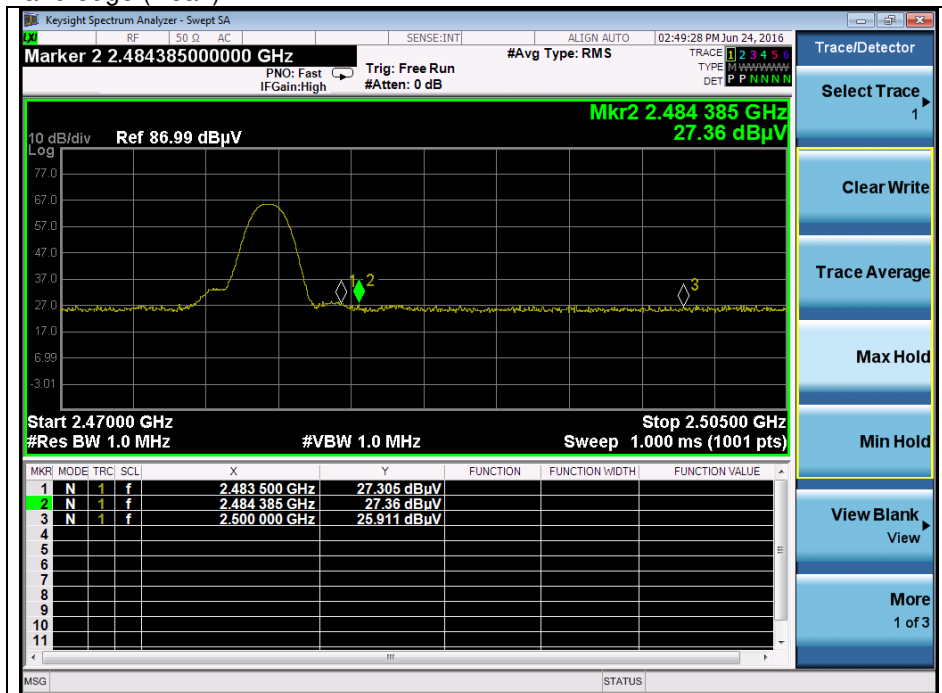

The results shown in this test report refer only to the sample(s) tested unless otherwise stated. This test report cannot be reproduced, except in full, without prior written permission of the Company.

Middle channel 3rd harmonic (Peak)

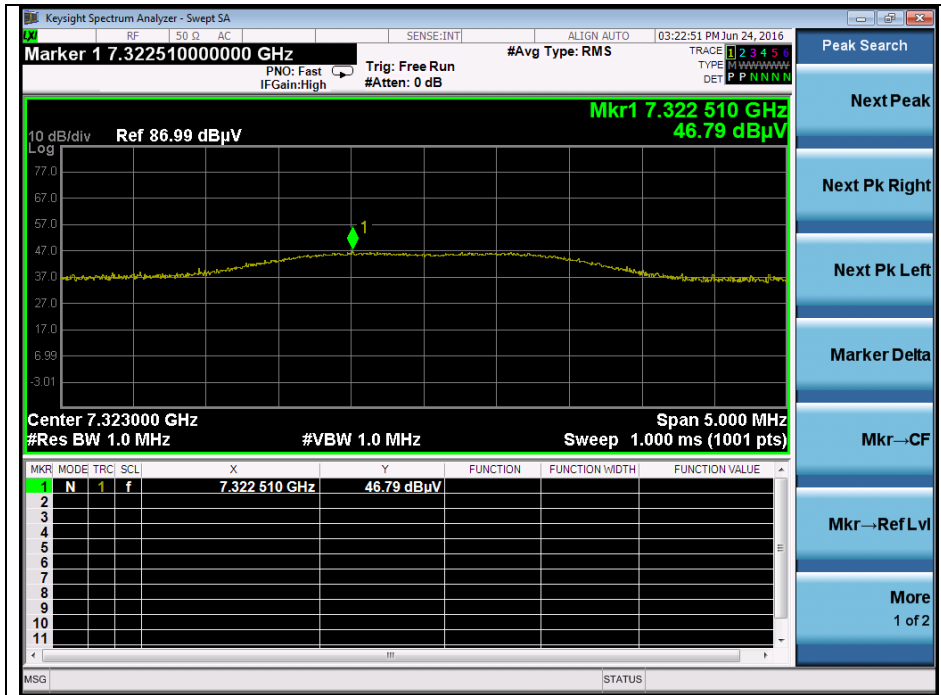

High channel 3rd harmonic (Peak)

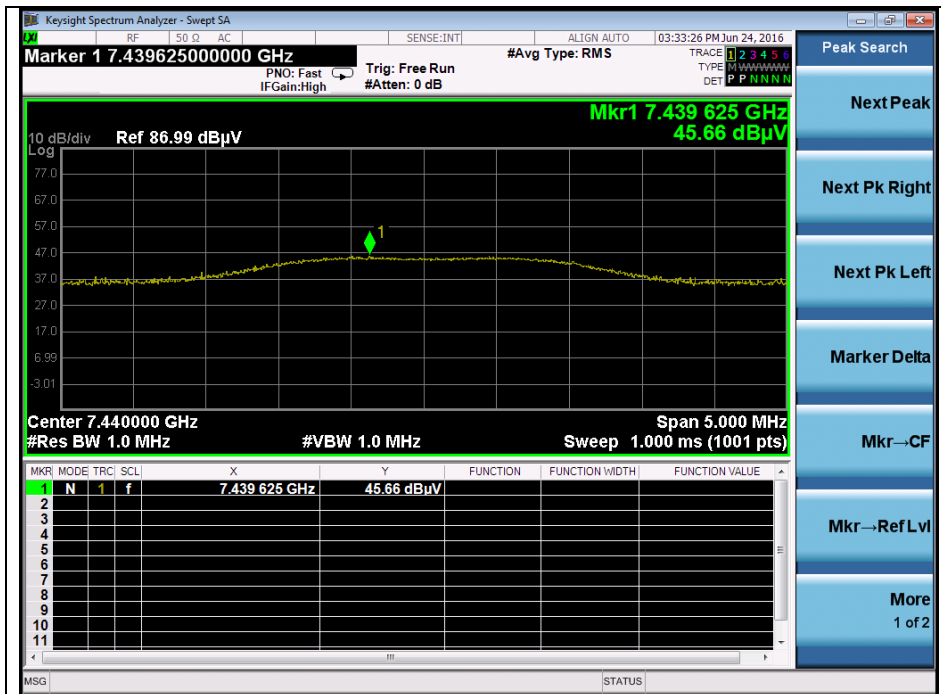

The results shown in this test report refer only to the sample(s) tested unless otherwise stated. This test report cannot be reproduced, except in full, without prior written permission of the Company.

Operating Mode: 8DPSK (3 Mbps)

Low Channel Band edge (Peak)

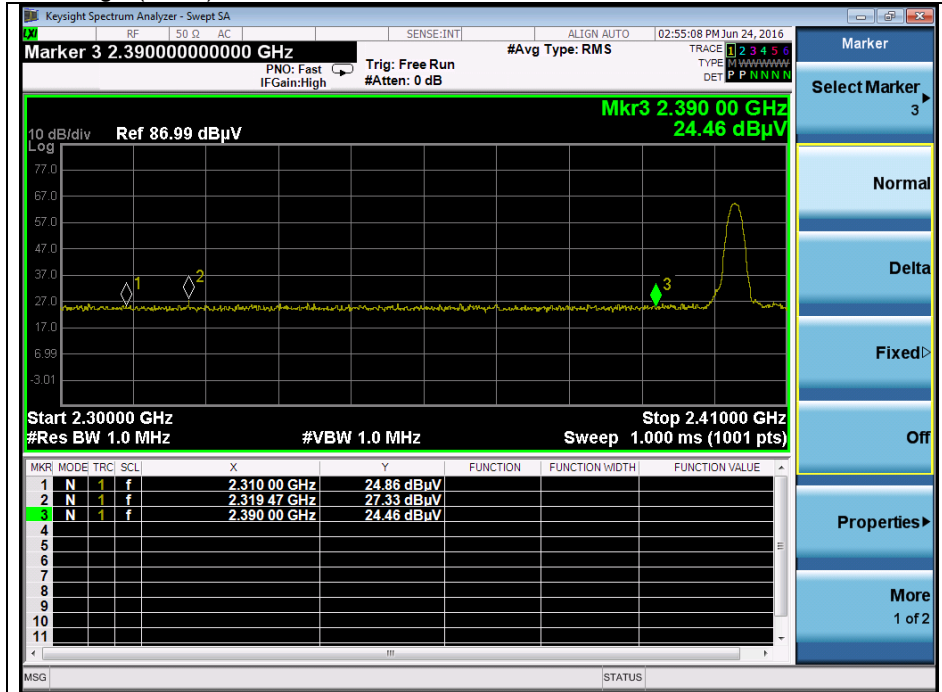

High Channel Band edge (Peak)

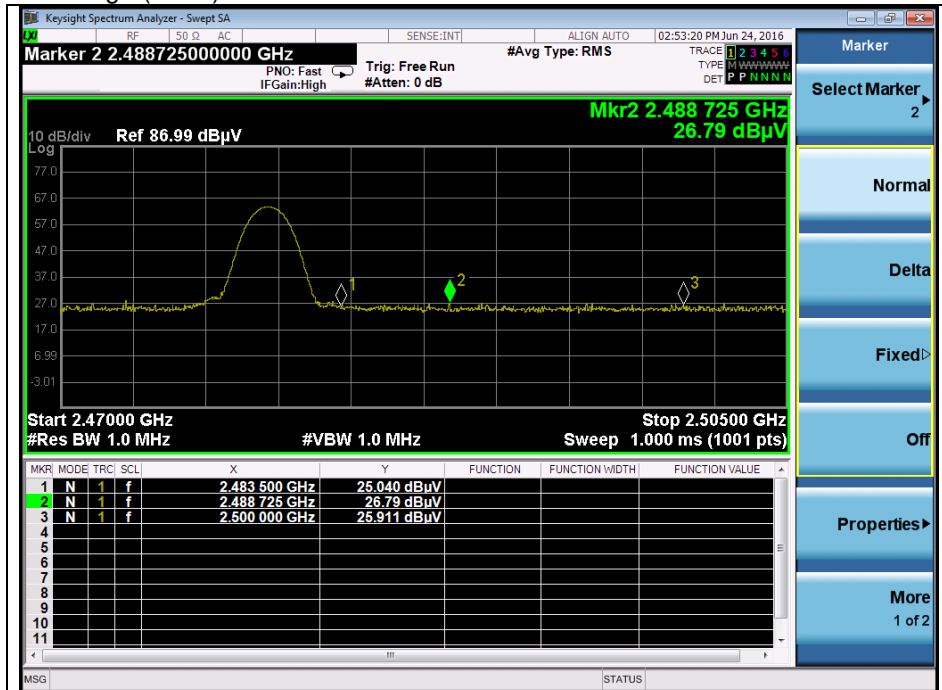

The results shown in this test report refer only to the sample(s) tested unless otherwise stated. This test report cannot be reproduced, except in full, without prior written permission of the Company.

2.4.4. Spurious RF Conducted Emissions: Plot of Spurious RF Conducted Emission

Operating Mode: GFSK (1 Mbps)

Low Channel

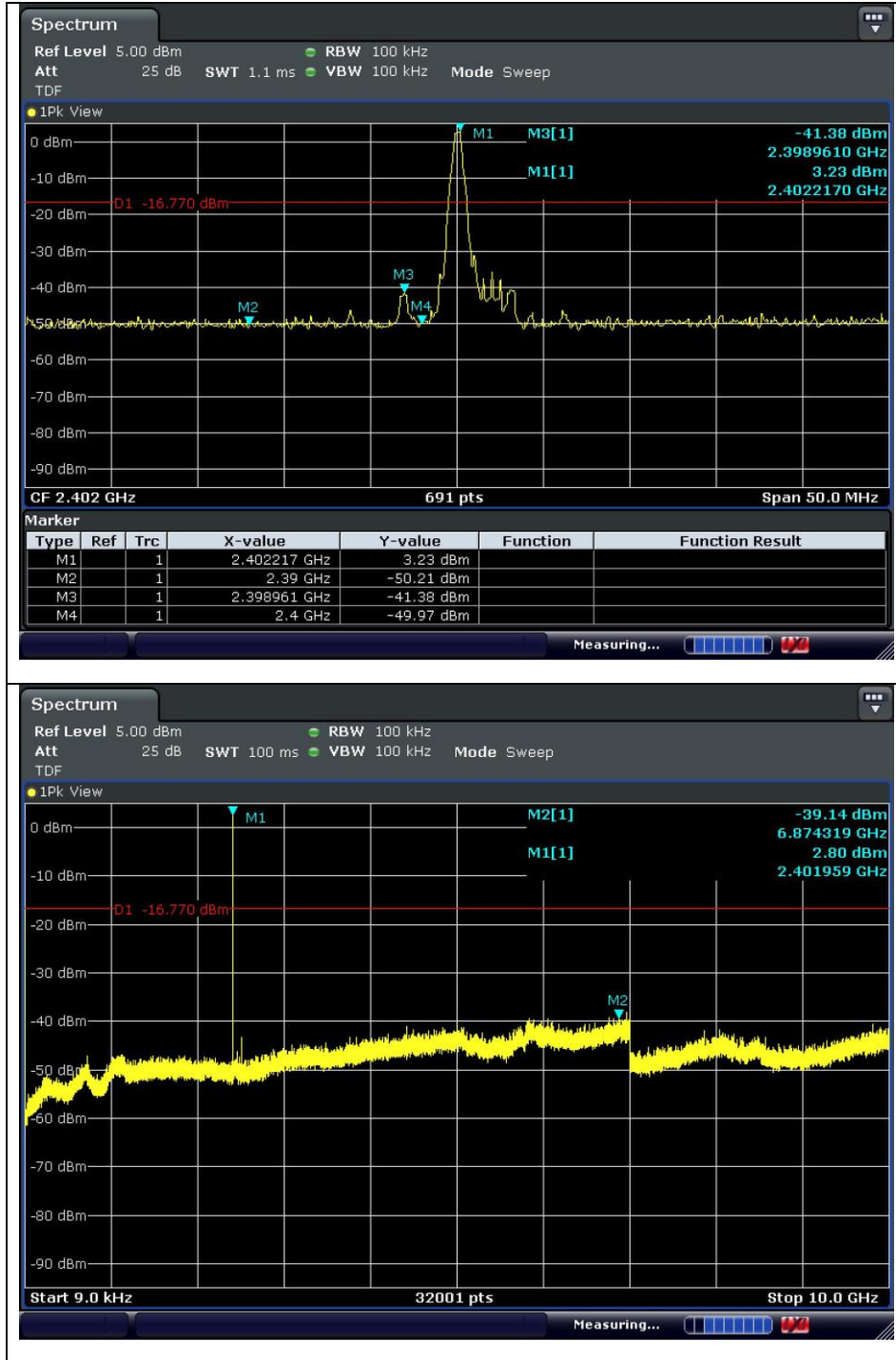

The results shown in this test report refer only to the sample(s) tested unless otherwise stated. This test report cannot be reproduced, except in full, without prior written permission of the Company.

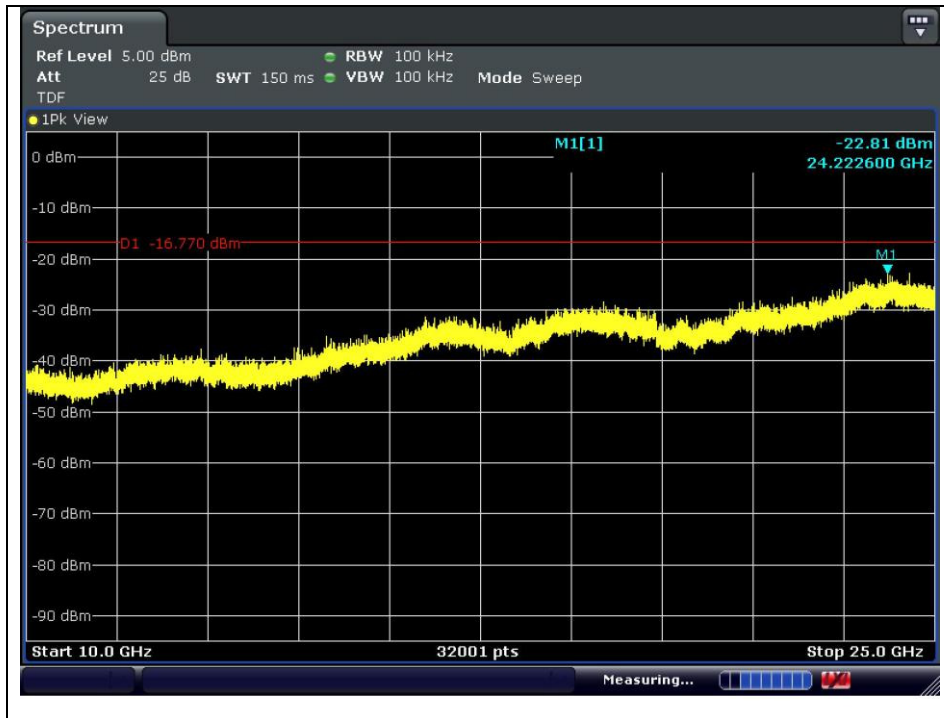

The results shown in this test report refer only to the sample(s) tested unless otherwise stated. This test report cannot be reproduced, except in full, without prior written permission of the Company.

SGS Korea Co., Ltd. (Gunpo Laboratory) 4, LS-ro 182beon-gil, Gunpo-si, Gyeonggi-do, Korea, 15807 <http://www.sgsgroup.kr>

Middle Channel

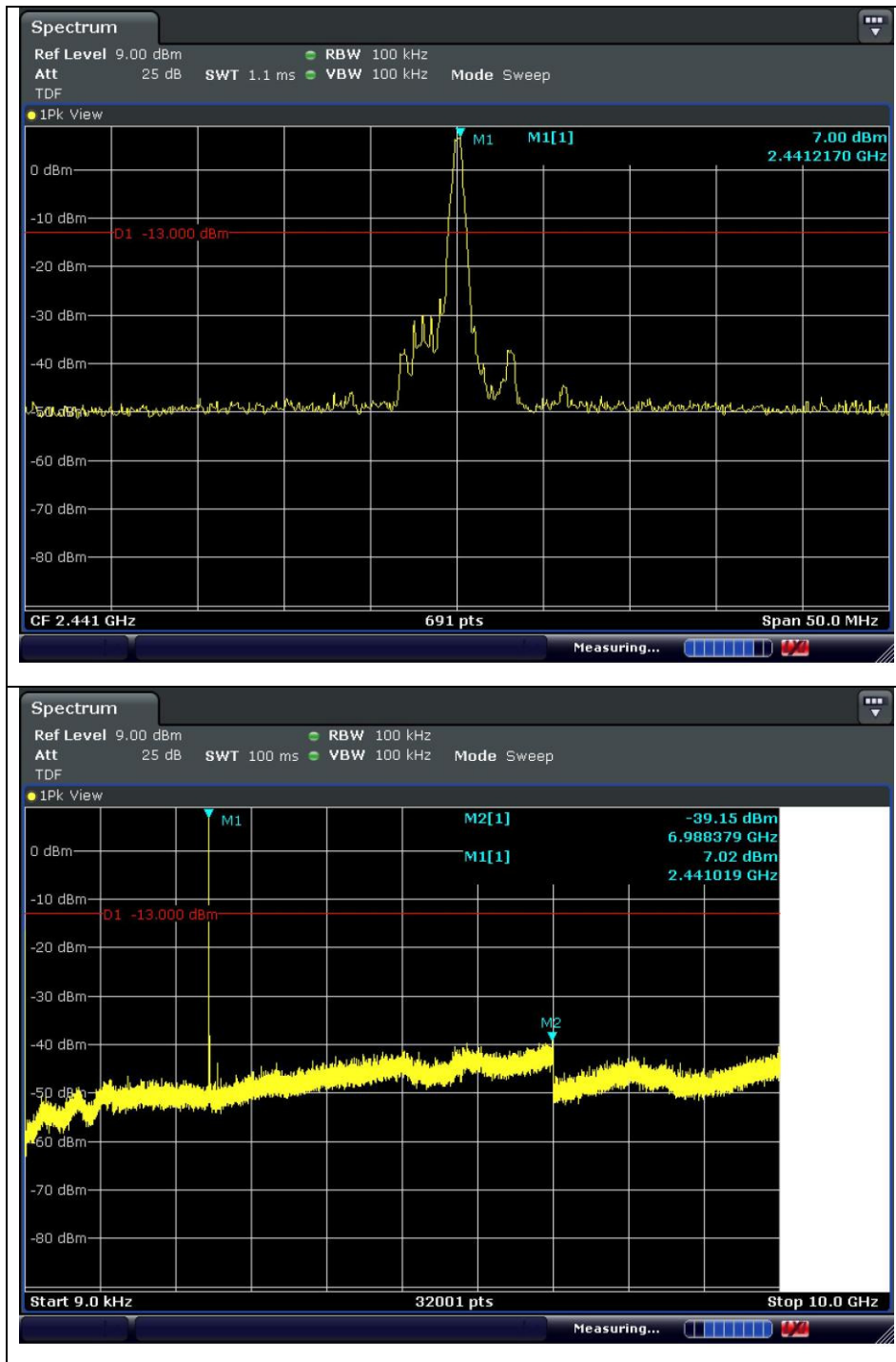

The results shown in this test report refer only to the sample(s) tested unless otherwise stated. This test report cannot be reproduced, except in full, without prior written permission of the Company.

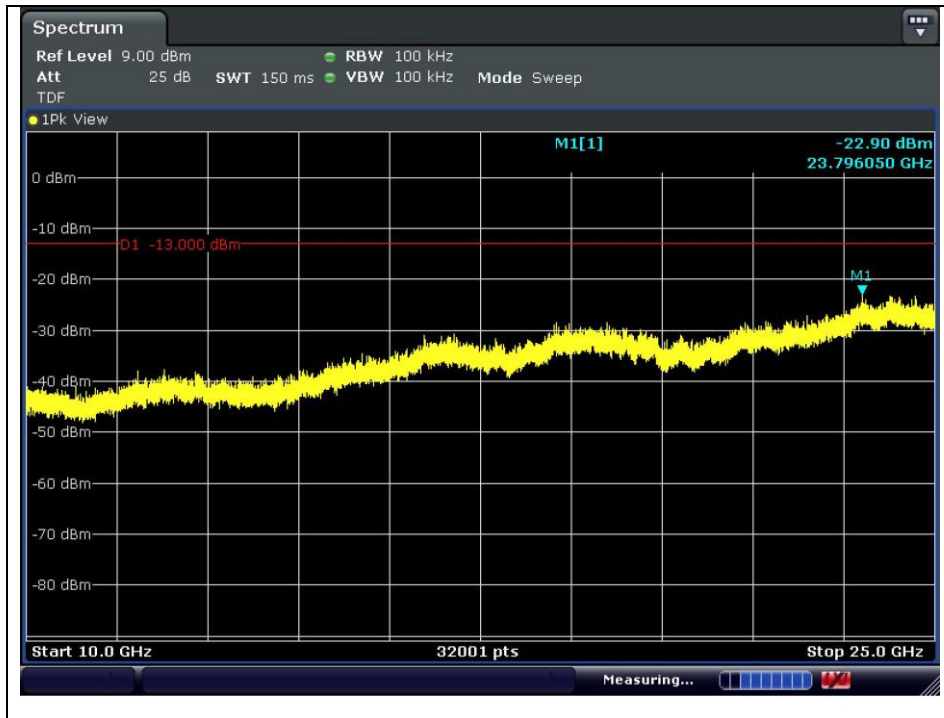

The results shown in this test report refer only to the sample(s) tested unless otherwise stated. This test report cannot be reproduced, except in full, without prior written permission of the Company.

SGS Korea Co., Ltd. (Gunpo Laboratory) 4, LS-ro 182beon-gil, Gunpo-si, Gyeonggi-do, Korea, 15807 <http://www.sgsgroup.kr>

High Channel

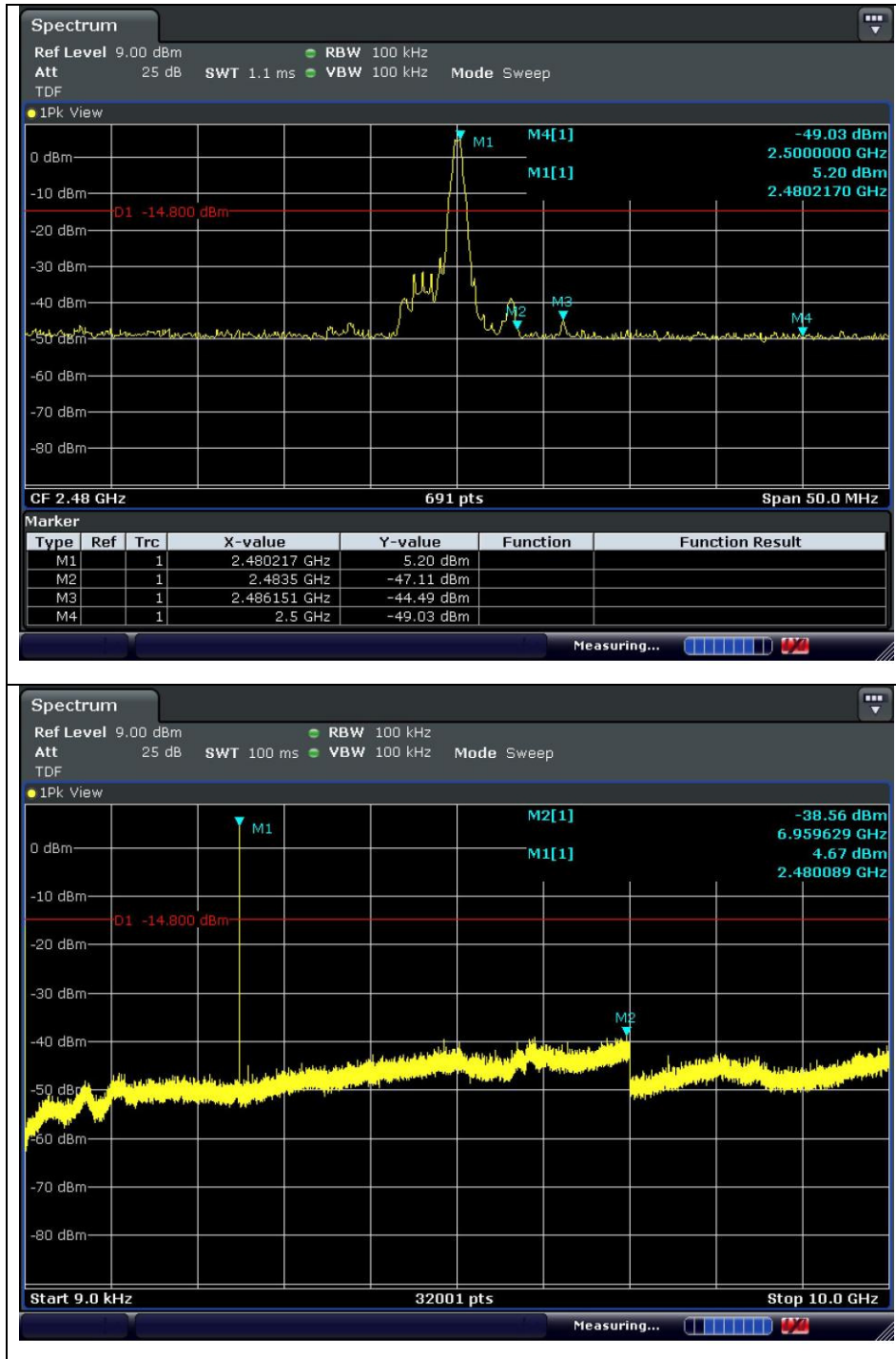

The results shown in this test report refer only to the sample(s) tested unless otherwise stated. This test report cannot be reproduced, except in full, without prior written permission of the Company.

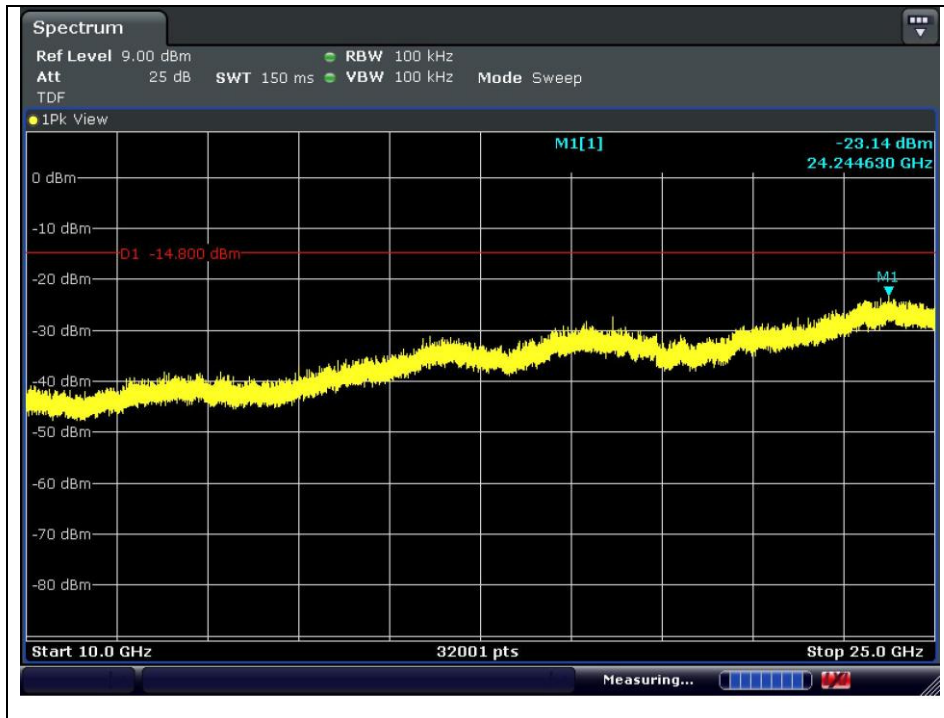

The results shown in this test report refer only to the sample(s) tested unless otherwise stated. This test report cannot be reproduced, except in full, without prior written permission of the Company.

SGS Korea Co., Ltd. (Gunpo Laboratory) 4, LS-ro 182beon-gil, Gunpo-si, Gyeonggi-do, Korea, 15807 <http://www.sgsgroup.kr>

Band edge Compliance with Hopping Enabled

Low channel

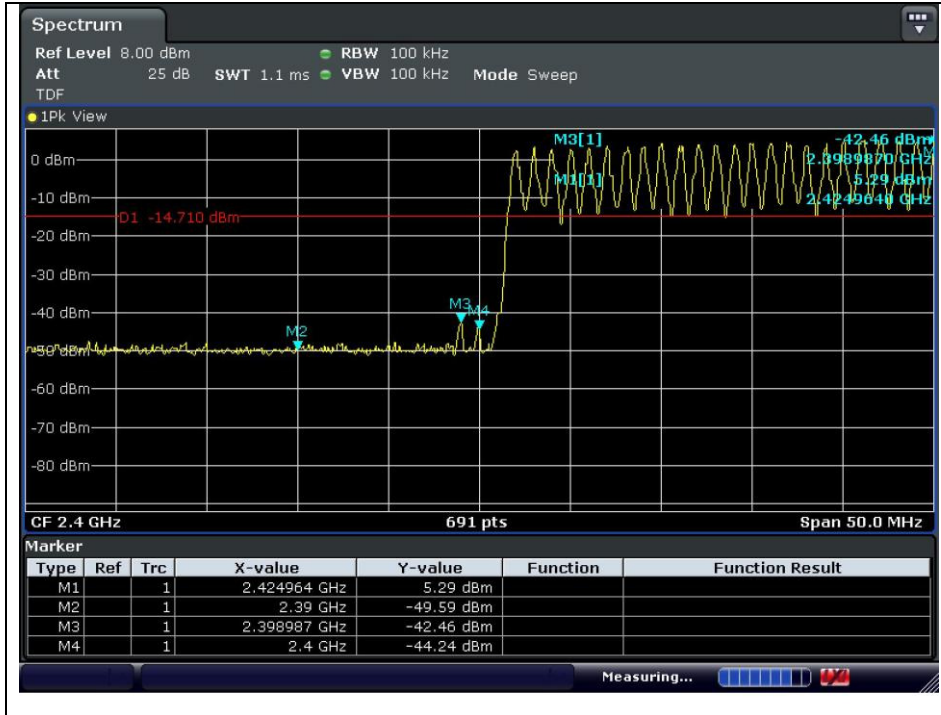

High channel

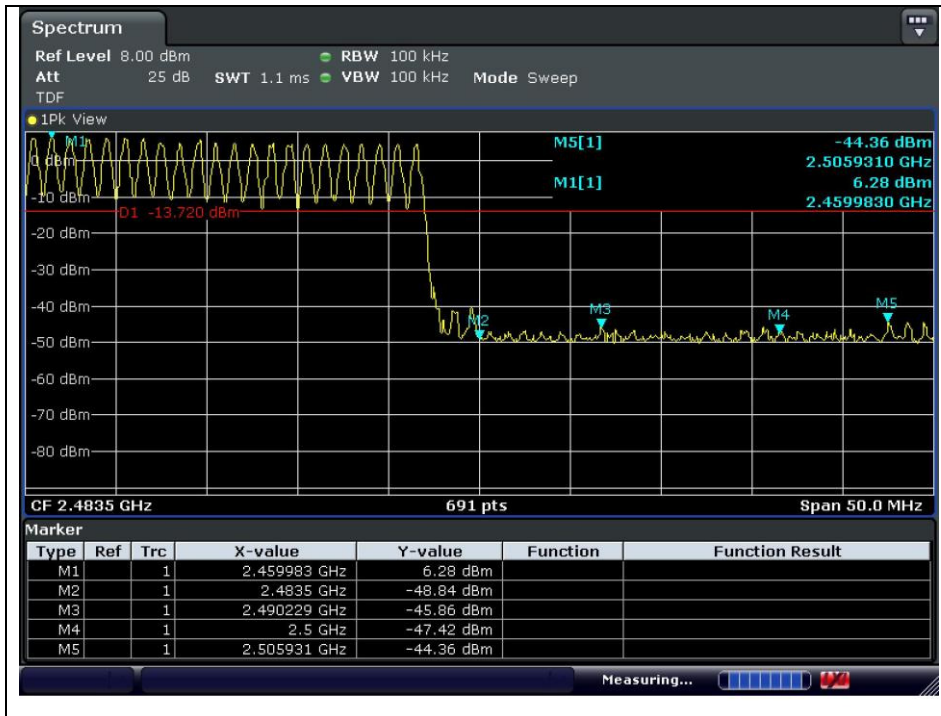

The results shown in this test report refer only to the sample(s) tested unless otherwise stated. This test report cannot be reproduced, except in full, without prior written permission of the Company.

Operating Mode: 8DPSK (3 Mbps)

Low Channel

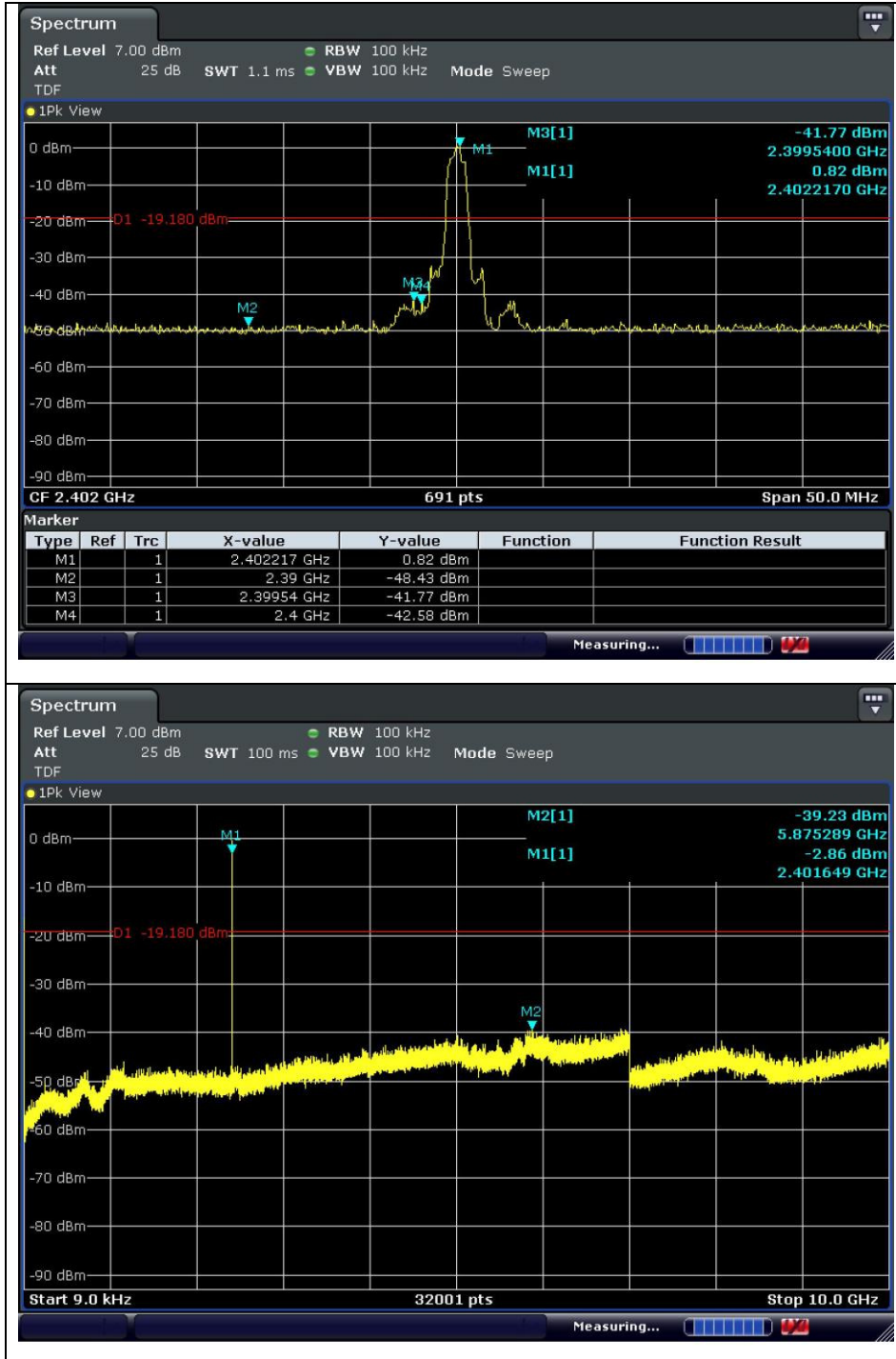

The results shown in this test report refer only to the sample(s) tested unless otherwise stated. This test report cannot be reproduced, except in full, without prior written permission of the Company.

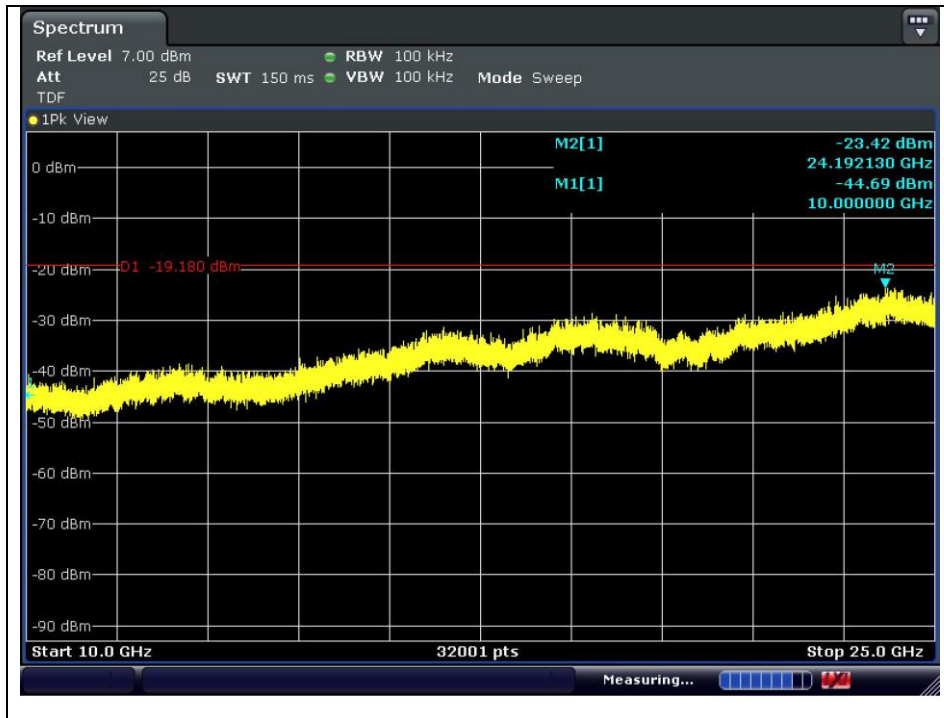

The results shown in this test report refer only to the sample(s) tested unless otherwise stated. This test report cannot be reproduced, except in full, without prior written permission of the Company.

SGS Korea Co., Ltd. (Gunpo Laboratory) 4, LS-ro 182beon-gil, Gunpo-si, Gyeonggi-do, Korea, 15807 <http://www.sgsgroup.kr>

Middle Channel

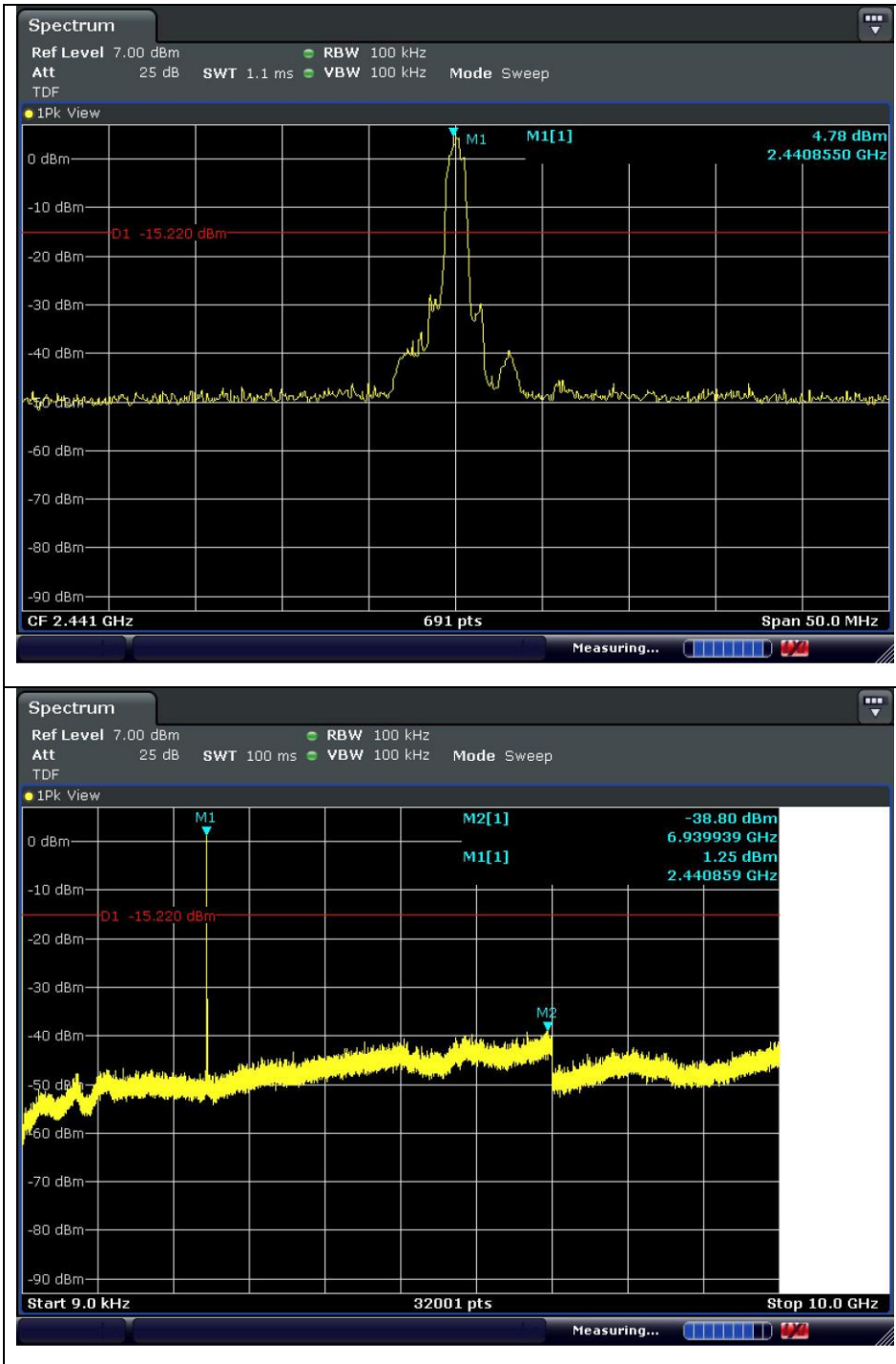

The results shown in this test report refer only to the sample(s) tested unless otherwise stated. This test report cannot be reproduced, except in full, without prior written permission of the Company.

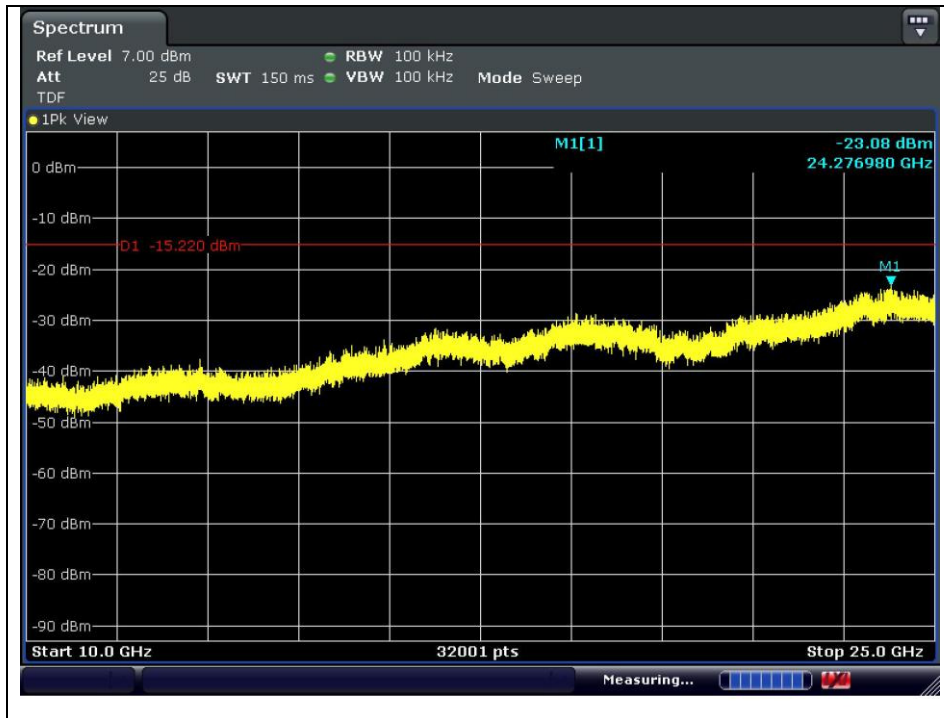

The results shown in this test report refer only to the sample(s) tested unless otherwise stated. This test report cannot be reproduced, except in full, without prior written permission of the Company.

SGS Korea Co., Ltd. (Gunpo Laboratory) 4, LS-ro 182beon-gil, Gunpo-si, Gyeonggi-do, Korea, 15807 <http://www.sgsgroup.kr>

High Channel

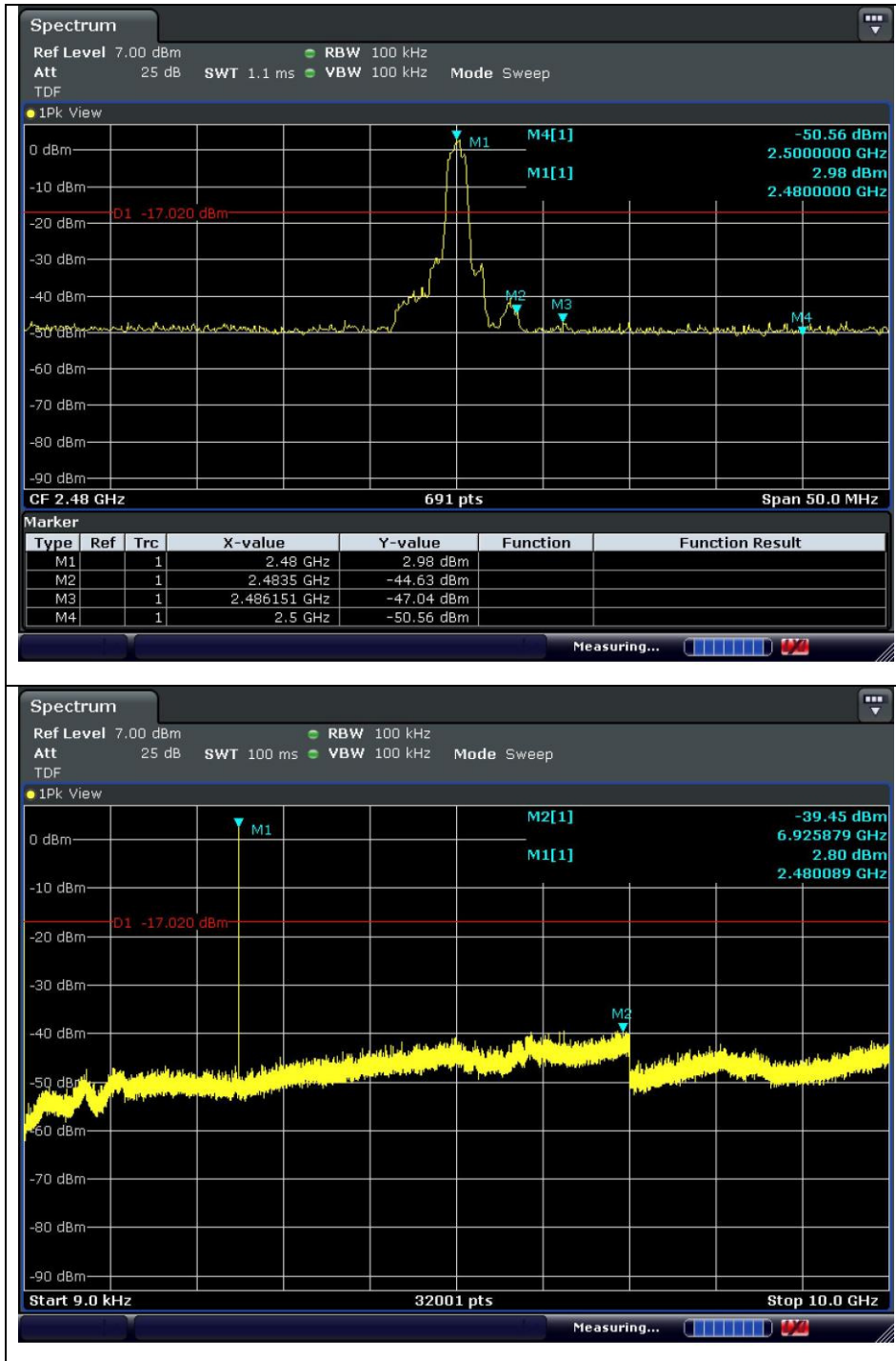

The results shown in this test report refer only to the sample(s) tested unless otherwise stated. This test report cannot be reproduced, except in full, without prior written permission of the Company.

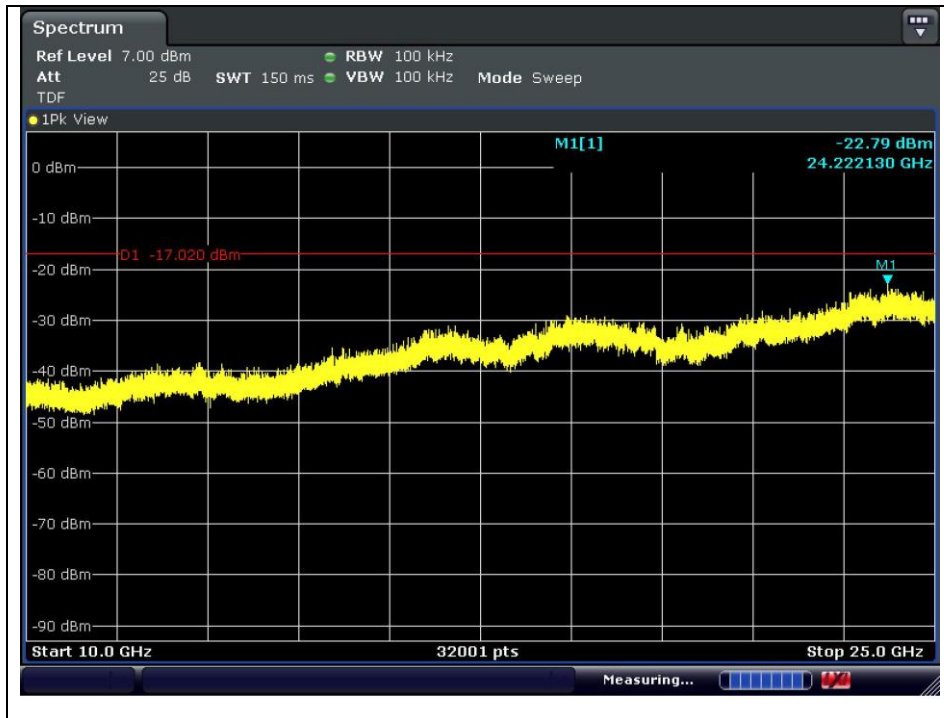

The results shown in this test report refer only to the sample(s) tested unless otherwise stated. This test report cannot be reproduced, except in full, without prior written permission of the Company.

SGS Korea Co., Ltd. (Gunpo Laboratory) 4, LS-ro 182beon-gil, Gunpo-si, Gyeonggi-do, Korea, 15807 <http://www.sgsgroup.kr>

Band edge Compliance with Hopping Enabled

Low channel



High channel

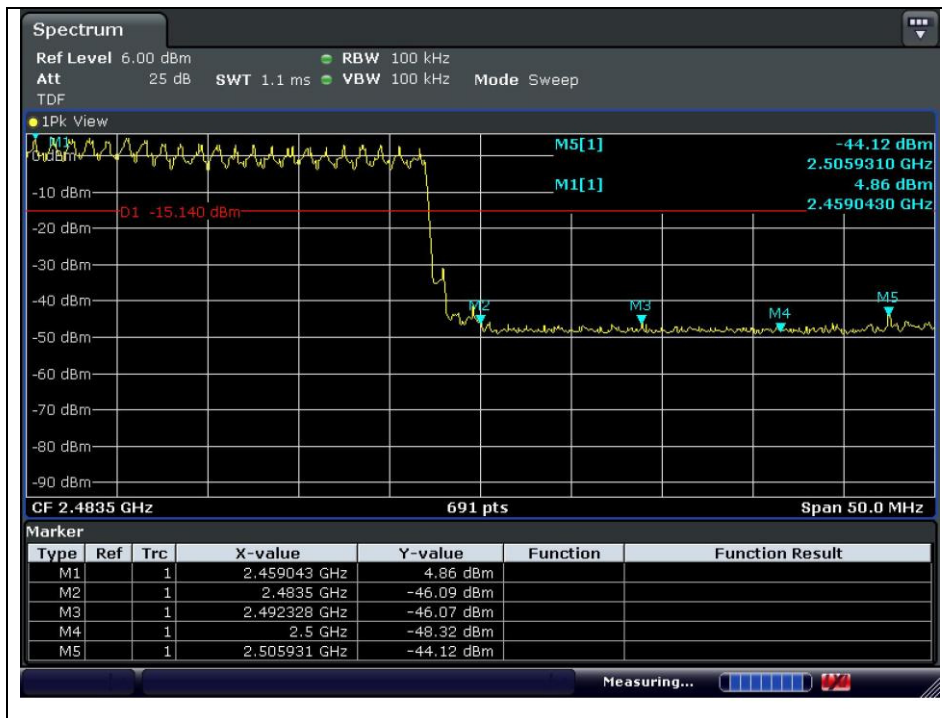

The results shown in this test report refer only to the sample(s) tested unless otherwise stated. This test report cannot be reproduced, except in full, without prior written permission of the Company.

3. 20 dB Bandwidth

3.1. Test Setup

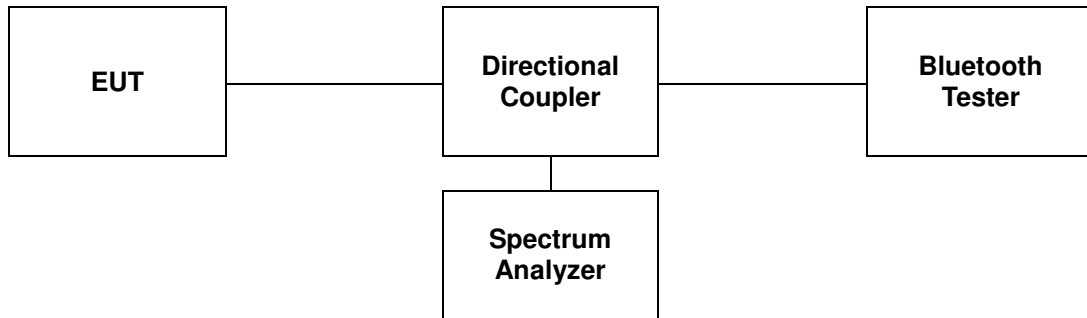

3.2. Limit

Limit: Not Applicable

3.3. Test Procedure

3.3.1. 20 dB Bandwidth

The test follows DA 00-705.

The 20 dB bandwidth was measured with a spectrum analyzer connected to RF antenna connector (conducted measurement) while EUT was operating in transmit mode at the appropriate center frequency.

Use the following spectrum analyzer setting :

Span = approximately 2 to 3 times the 20 dB bandwidth, centered on a hopping channel.

RBW \geq 1 % of the 20 dB bandwidth

VBW \geq RBW

Sweep = auto

Detector = peak

Trace = max hold

The marker-to-peak function to set the mark to the peak of the emission. Use the marker-delta function to measure 20 dB down one side of the emission. Reset the function, and move the marker to the other side of the emission, until it is (as close as possible to) even with the reference marker level. The marker-delta reading at this point is 20 dB bandwidth of the emission.

The results shown in this test report refer only to the sample(s) tested unless otherwise stated. This test report cannot be reproduced, except in full, without prior written permission of the Company.

SGS Korea Co., Ltd. (Gunpo Laboratory) 4, LS-ro 182beon-gil, Gunpo-si, Gyeonggi-do, Korea, 15807 <http://www.sgsgroup.kr>

RTT5041-20(2015.10.01)(3)

Tel. +82 31 428 5700 / Fax. +82 31 427 2370

A4(210 mm x 297 mm)

3.4. Test Results

Ambient temperature : (23 ± 1) °C
 Relative humidity : 47 % R.H.

Operation Mode	Data Rate	Channel	Frequency (MHz)	20 dB Bandwidth (kHz)
GFSK	1 Mbps	Low	2 402	955.10
		Middle	2 441	950.80
		High	2 480	950.80
π/4DQPSK	2 Mbps	Low	2 402	1 246.00
		Middle	2 441	1 246.00
		High	2 480	1 246.00
8DPSK	3 Mbps	Low	2 402	1 272.10
		Middle	2 441	1 267.70
		High	2 480	1 272.10

Operating Mode: GFSK
 Low Channel

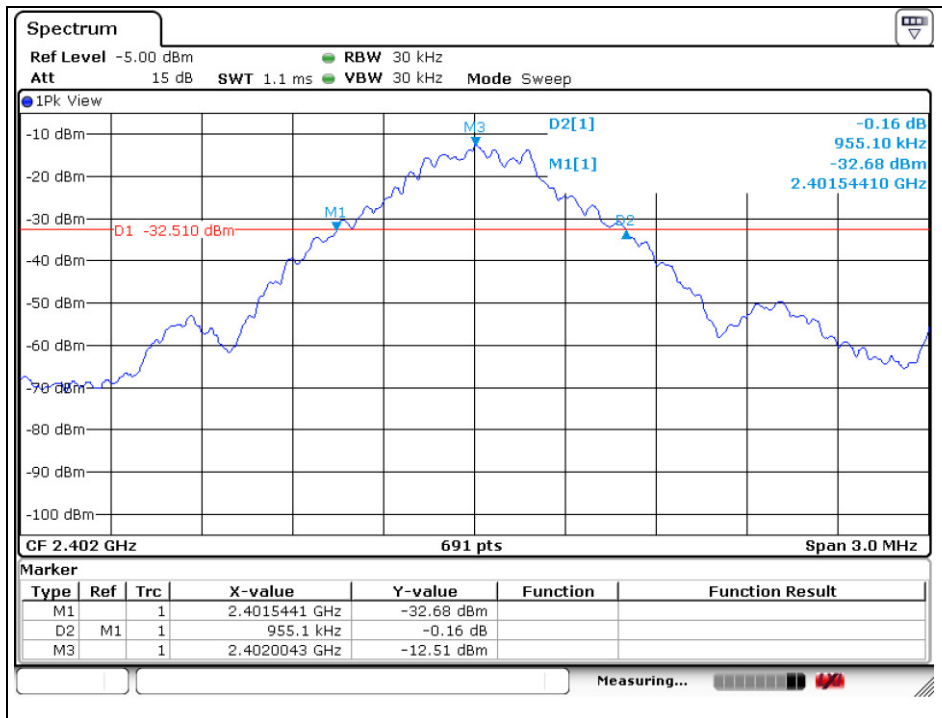

The results shown in this test report refer only to the sample(s) tested unless otherwise stated. This test report cannot be reproduced, except in full, without prior written permission of the Company.

Middle Channel

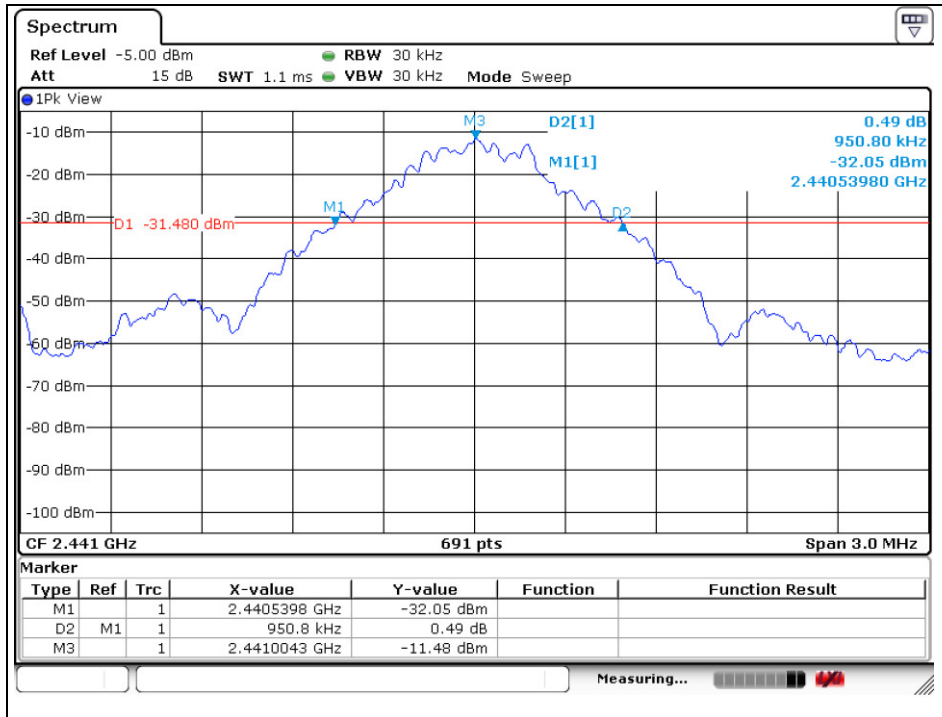

High Channel

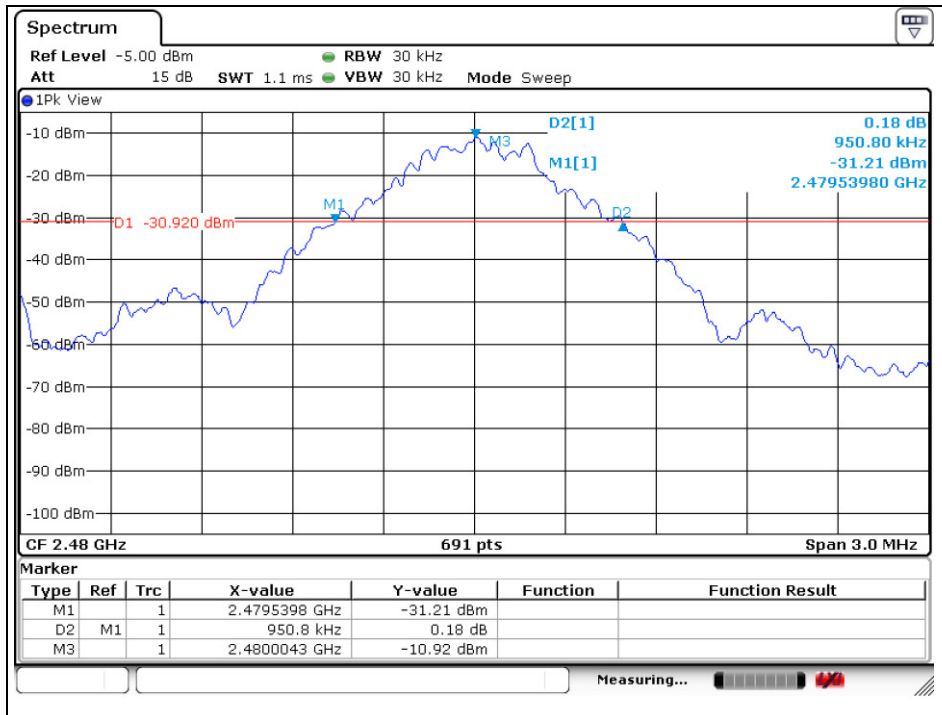

The results shown in this test report refer only to the sample(s) tested unless otherwise stated. This test report cannot be reproduced, except in full, without prior written permission of the Company.

Operating Mode: $\pi/4$ DQPSK

Low Channel

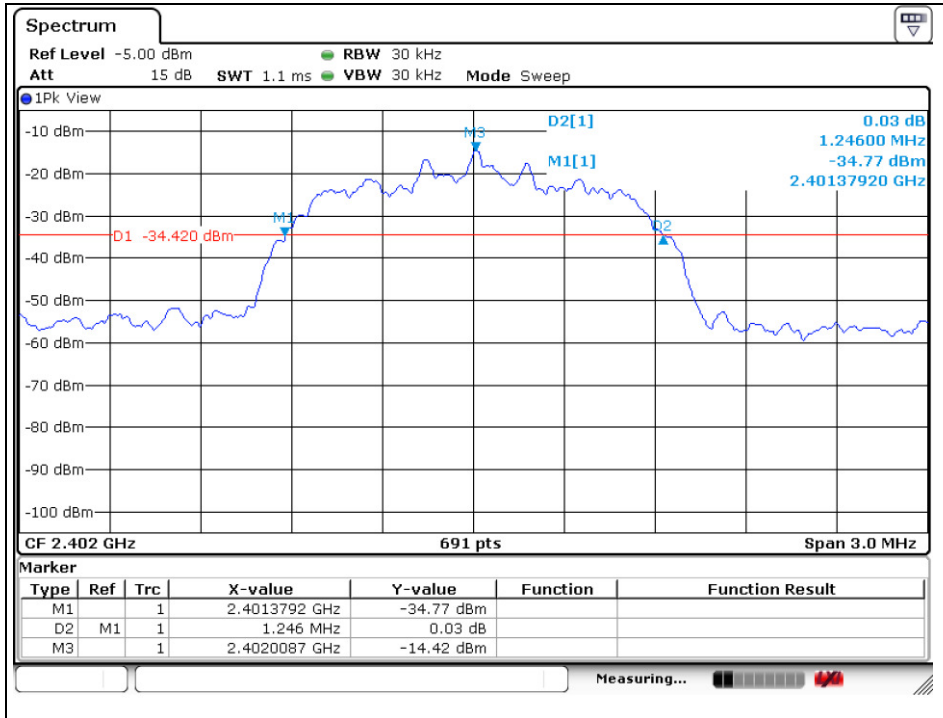

Middle Channel

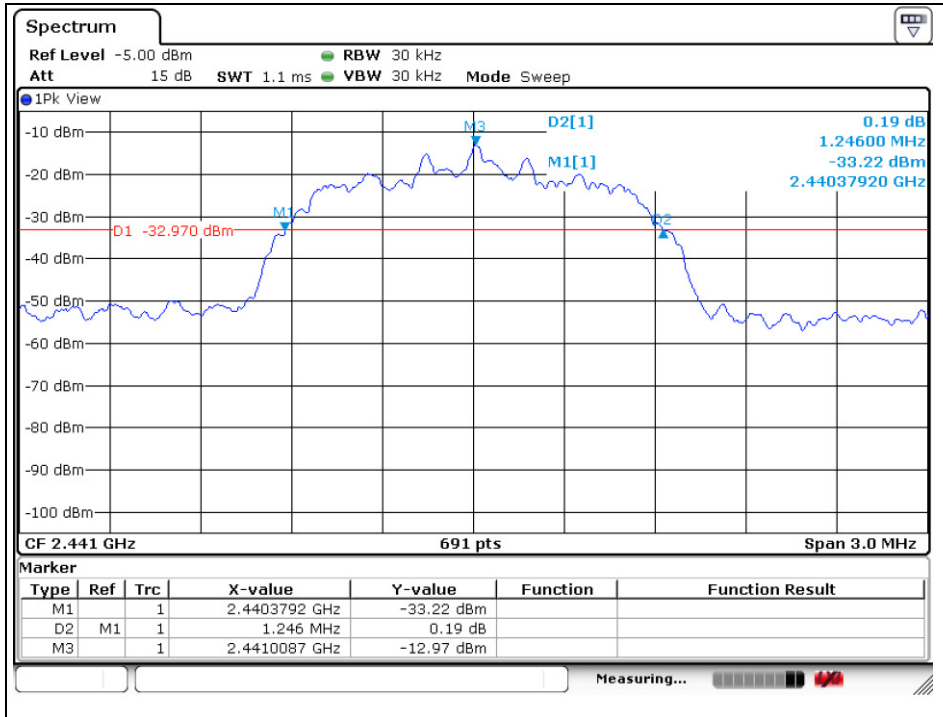

The results shown in this test report refer only to the sample(s) tested unless otherwise stated. This test report cannot be reproduced, except in full, without prior written permission of the Company.

High Channel

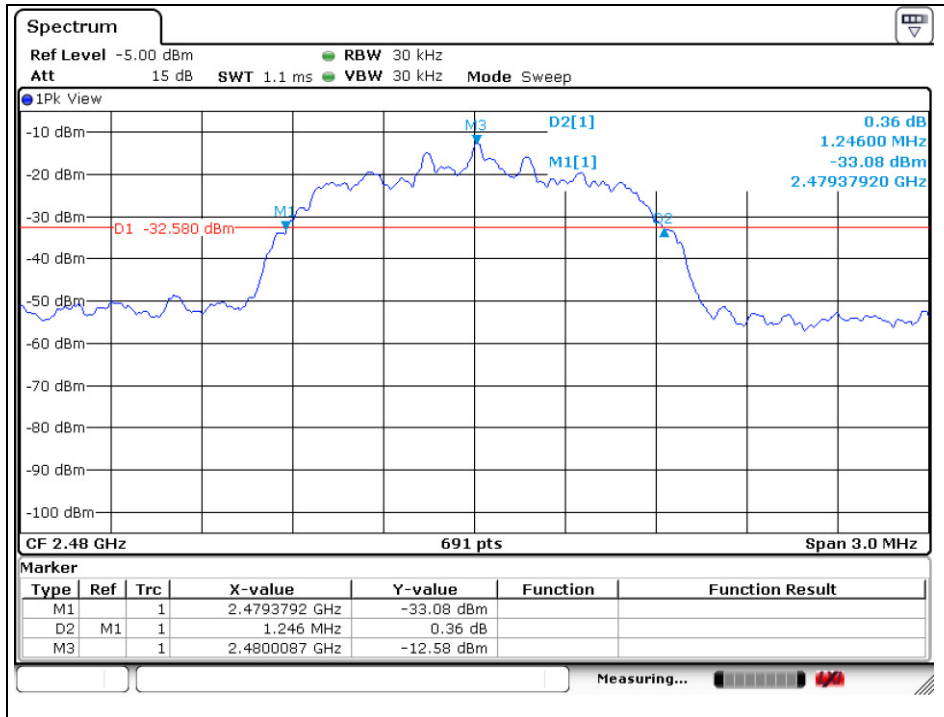

Operating Mode: 8DPSK

Low Channel

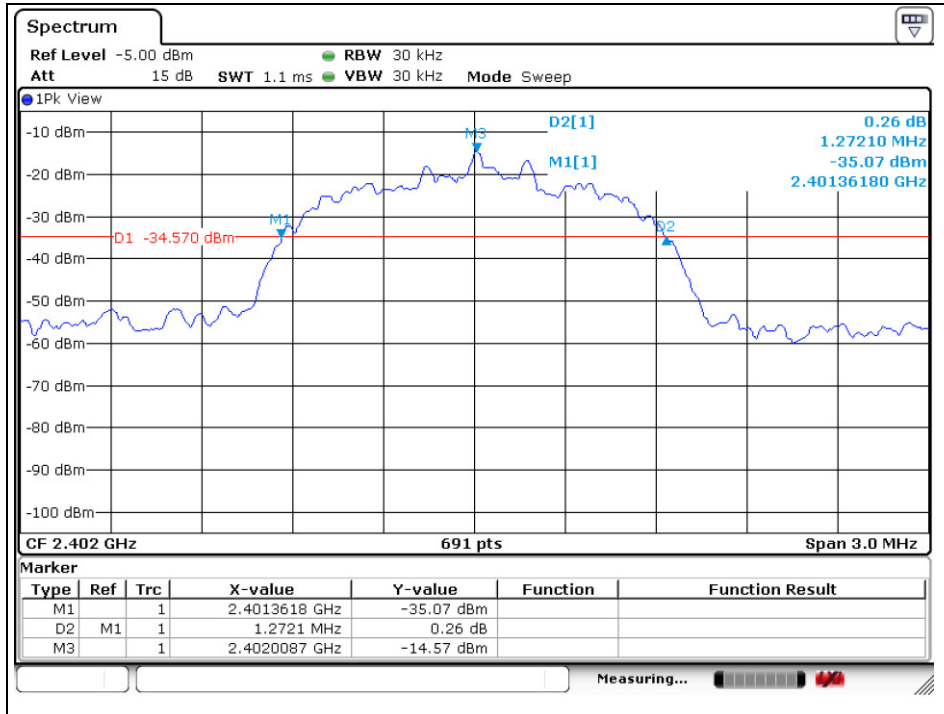

The results shown in this test report refer only to the sample(s) tested unless otherwise stated. This test report cannot be reproduced, except in full, without prior written permission of the Company.

Middle Channel

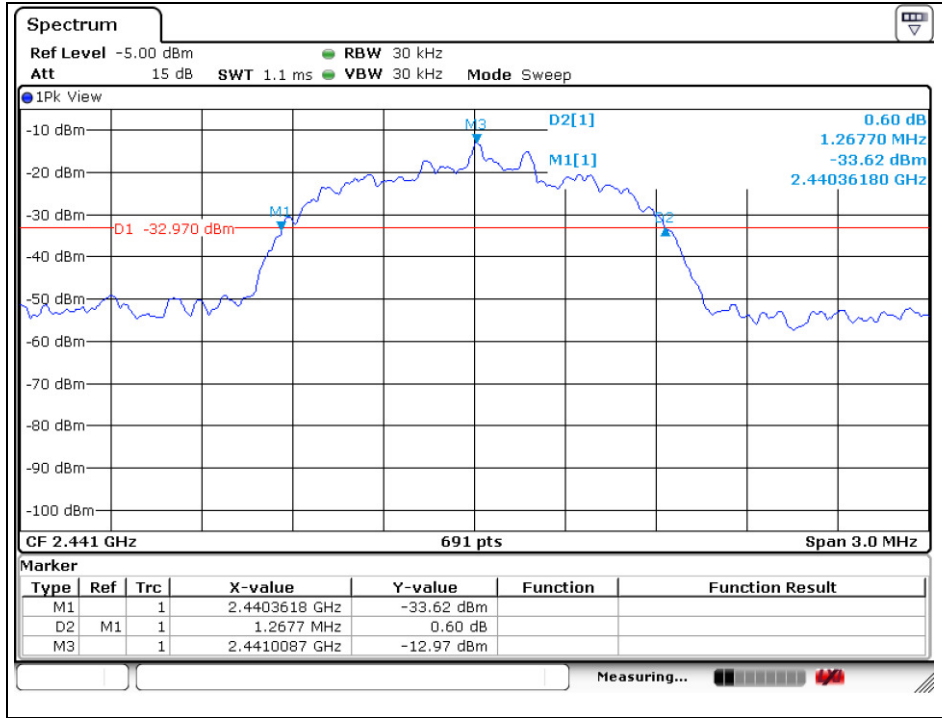

High Channel

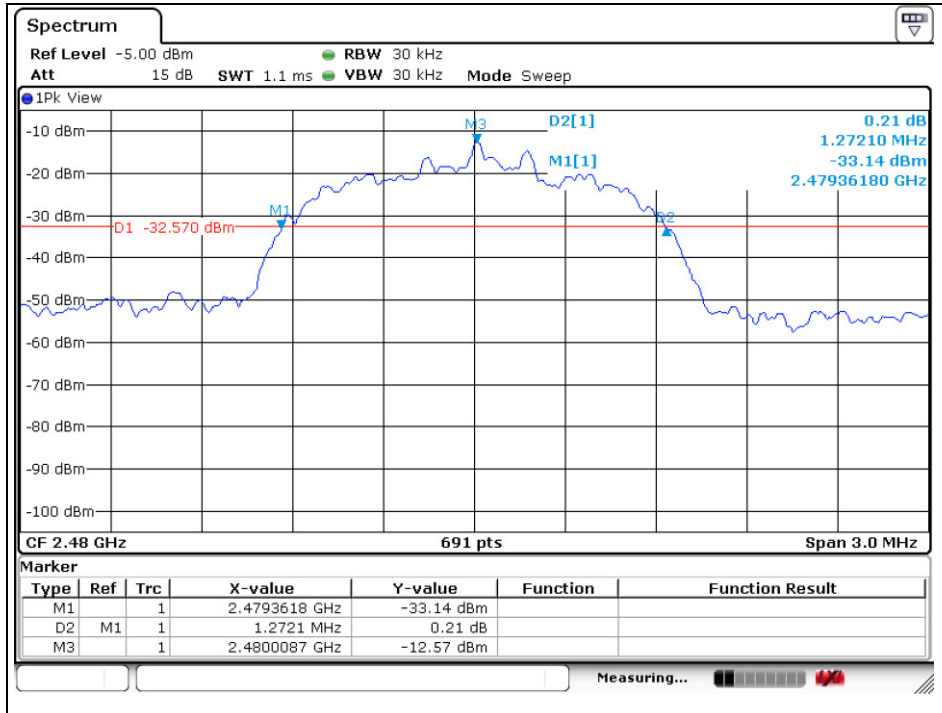

The results shown in this test report refer only to the sample(s) tested unless otherwise stated. This test report cannot be reproduced, except in full, without prior written permission of the Company.

4. Maximum Peak Conducted Output Power

4.1. Test Setup

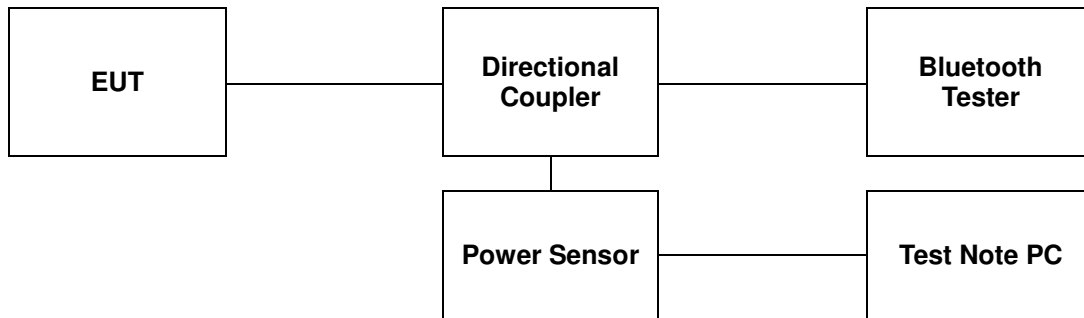

4.2. Limit

The maximum peak output power of the intentional radiator shall not exceed the following :

1. §15.247(a)(1), Frequency hopping systems shall have hopping channel carrier frequencies separated by a minimum of 25 kHz or the 20 dB bandwidth of the hopping channel, whichever is greater, provided the systems operate with an output power no greater than 125 mW.
2. §15.247(b)(1), For frequency hopping systems operating in the 2 400-2 483.5 MHz employing at least 75 non-overlapping hopping channels, and all frequency hopping systems in the 5 725-5 805 MHz band : 1 Watt.

4.3. Test Procedure

The test follows DA 00-705. Using the power sensor instead of a spectrum analyzer.

1. Place the EUT on the table and set it in the transmitting mode.
2. Remove the antenna from the EUT and then connect a low loss RF cable from the antenna port to the Power sensor.
3. Test program : (S/W name : R&S Power Viewer, Version : 3.2.0)
4. Measure peak power each channel.

The results shown in this test report refer only to the sample(s) tested unless otherwise stated. This test report cannot be reproduced, except in full, without prior written permission of the Company.

SGS Korea Co., Ltd. (Gunpo Laboratory) 4, LS-ro 182beon-gil, Gunpo-si, Gyeonggi-do, Korea, 15807 <http://www.sgsgroup.kr>

4.4. Test Results

Ambient temperature : (23 ± 1) °C
 Relative humidity : 47 % R.H.

Operation Mode	Data Rate	Channel	Frequency (MHz)	Directional Coupler + Cable offset (dB)	Peak Power Result (dB m)	Peak Power Limit (dB m)
GFSK	1 Mbps	Low	2 402	15.67	4.49	30
		Middle	2 441	16.44	6.95	30
		High	2 480	15.26	6.69	30
π/4DQPSK	2 Mbps	Low	2 402	15.67	3.68	20.97
		Middle	2 441	16.44	6.13	20.97
		High	2 480	15.26	5.83	20.97
8DPSK	3 Mbps	Low	2 402	15.67	3.71	20.97
		Middle	2 441	16.44	6.18	20.97
		High	2 480	15.26	5.91	20.97

Remark:

In the case of AFH, the limit for peak power is 0.125 W

Directional coupler and cable offset compensate for test program (R&S Power Viewer) before measuring.

The results shown in this test report refer only to the sample(s) tested unless otherwise stated. This test report cannot be reproduced, except in full, without prior written permission of the Company.

SGS Korea Co., Ltd. (Gunpo Laboratory) 4, LS-ro 182beon-gil, Gunpo-si, Gyeonggi-do, Korea, 15807 <http://www.sgsgroup.kr>

5. Carrier Frequency Separation

5.1. Test Setup

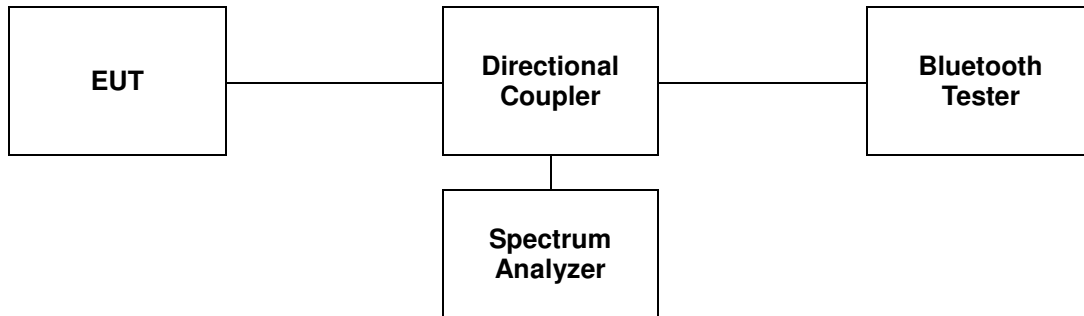

5.2. Limit

§15.247(a)(1) Frequency hopping system operating in 2 400-2 483.5 MHz. Band may have hopping channel carrier frequencies that are separated by 25 kHz or two-third of 20 dB bandwidth of the hopping channel, whichever is greater, provided the systems operate with an output power no greater than 125 mW.

5.3. Test Procedure

All data rates and modes were investigated for this test. The full data for the worst case data rate are reported in this section. The test follows DA 00-705.

The device is operating in hopping mode between 79 channels and also supporting Adaptive Frequency Hopping with hopping between 20 channels. As compared with each operating mode, 79 channels are chosen as a representative for test.

Use the following spectrum analyzer settings:

Span = wide enough to capture the peaks of two adjacent channels.

RBW \geq 1 % of the span

VBW \geq RBW

Sweep = auto

Detector = peak

Trace = max hold

Allow the trace to stabilize. Use the marker-delta function to determine the between the peaks of the adjacent channels.

The results shown in this test report refer only to the sample(s) tested unless otherwise stated. This test report cannot be reproduced, except in full, without prior written permission of the Company.

SGS Korea Co., Ltd. (Gunpo Laboratory) 4, LS-ro 182beon-gil, Gunpo-si, Gyeonggi-do, Korea, 15807 <http://www.sgsgroup.kr>

RTT5041-20(2015.10.01)(3)

Tel. +82 31 428 5700 / Fax. +82 31 427 2370

A4(210 mm x 297 mm)

5.4. Test Results

Ambient temperature : (23 ± 1) °C
 Relative humidity : 47 % R.H.

Operation Mode	Frequency (MHz)	Adjacent Hopping Channel Separation (kHz)	Two-third of 20 dB Bandwidth (kHz)	Minimum Bandwidth (kHz)
GFSK	2 441	1 000	634	25
8DPSK	2 441	1 000	845	25

Note;

Measurement is made with EUT operating in hopping mode between 79 channels providing a worse case scenario as compared to AFH mode hopping between 20 channels.

The results shown in this test report refer only to the sample(s) tested unless otherwise stated. This test report cannot be reproduced, except in full, without prior written permission of the Company.

SGS Korea Co., Ltd. (Gunpo Laboratory) 4, LS-ro 182beon-gil, Gunpo-si, Gyeonggi-do, Korea, 15807 <http://www.sgsgroup.kr>

Operating Mode: GFSK

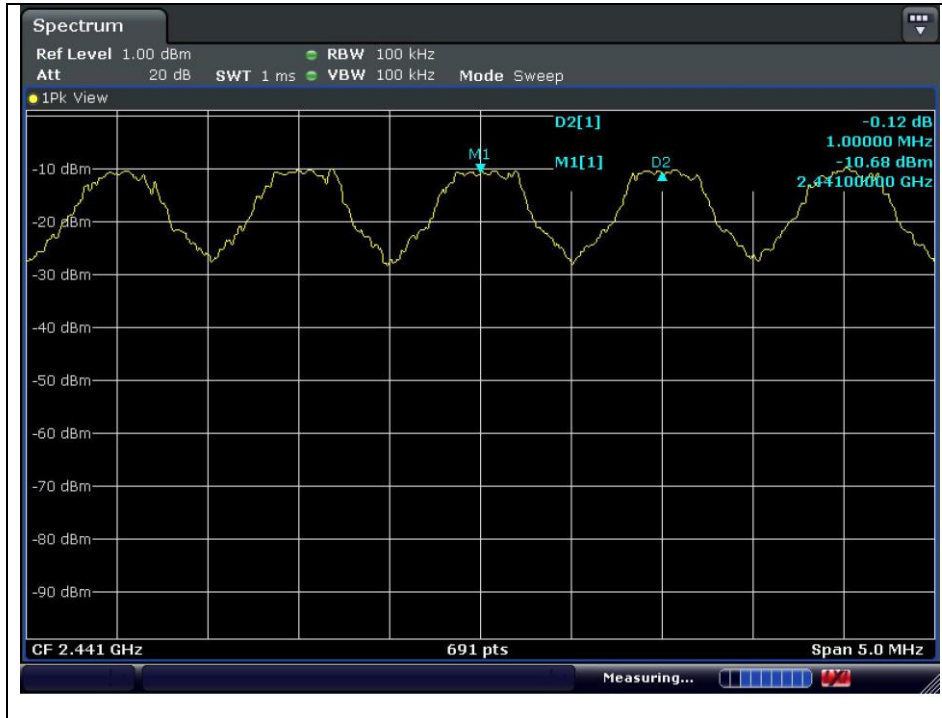

Operating Mode: 8DPSK

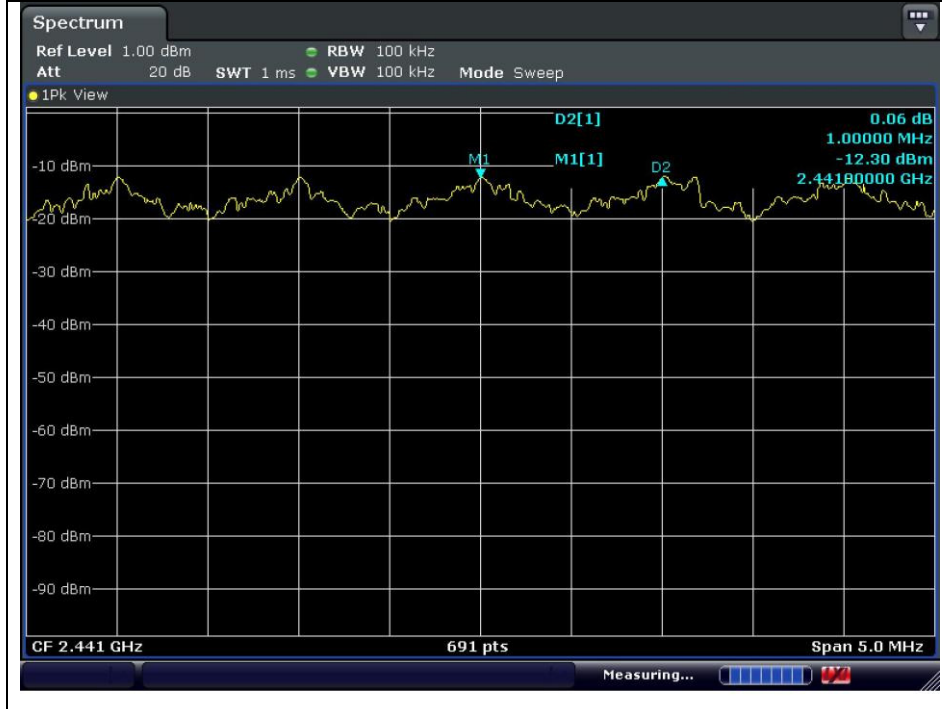

The results shown in this test report refer only to the sample(s) tested unless otherwise stated. This test report cannot be reproduced, except in full, without prior written permission of the Company.

6. Number of Hopping Frequencies

6.1. Test Setup

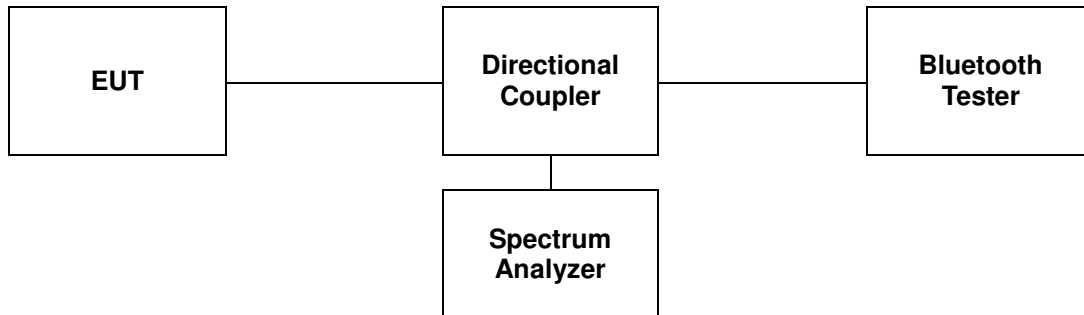

6.2. Limit

§15.247(a)(1)(iii), Frequency hopping systems in the 2 400-2 483.5 MHz band shall use at least 15 channels. The average time of occupancy on any channel shall not be greater than 0.4 seconds within a period of 0.4 seconds multiplied by the number of hopping channels employed. Frequency hopping systems may avoid or suppress transmissions on a particular hopping frequency provided that a minimum of 15 channels are used.

6.3. Test Procedure

All data rates and modes were investigated for this test. The full data for the worst case data rate are reported in this section. The test follows DA 00-705.

The device supports Adaptive Frequency Hopping and will use a minimum of 20 channels of the 79 available channels.

The EUT must have its hopping function enabled. Use the following spectrum analyzer settings:

1. Remove the antenna from the EUT and then connect a low loss RF cable from the antenna the port to the Spectrum analyzer.
3. Set spectrum analyzer Start = 2 400 MHz, Stop = 2 441.5 MHz, Sweep=sweep and Start = 2 441.5 MHz, Stop = 2 483.5 MHz, Sweep = auto, Detector = peak.
4. Set the spectrum analyzer as RBW, VBW = 500 kHz.
5. Max hold, allow the trace to stabilize and count how many channel in the band.

The results shown in this test report refer only to the sample(s) tested unless otherwise stated. This test report cannot be reproduced, except in full, without prior written permission of the Company.

SGS Korea Co., Ltd. (Gunpo Laboratory) 4, LS-ro 182beon-gil, Gunpo-si, Gyeonggi-do, Korea, 15807 <http://www.sgsgroup.kr>

6.4. Test Results

Ambient temperature : (23 ± 1) °C
 Relative humidity : 47 % R.H.

Operation Mode	Number of Hopping Frequency	Limit
GFSK	79	≥ 15
8DPSK	79	≥ 15

Remark:

Measurement is made with EUT operating in hopping mode between 79 channels providing a worse case scenario as compared to AFH mode hopping between 20 channels.

The results shown in this test report refer only to the sample(s) tested unless otherwise stated. This test report cannot be reproduced, except in full, without prior written permission of the Company.

SGS Korea Co., Ltd. (Gunpo Laboratory) 4, LS-ro 182beon-gil, Gunpo-si, Gyeonggi-do, Korea, 15807 <http://www.sgsgroup.kr>

Operating Mode: GFSK

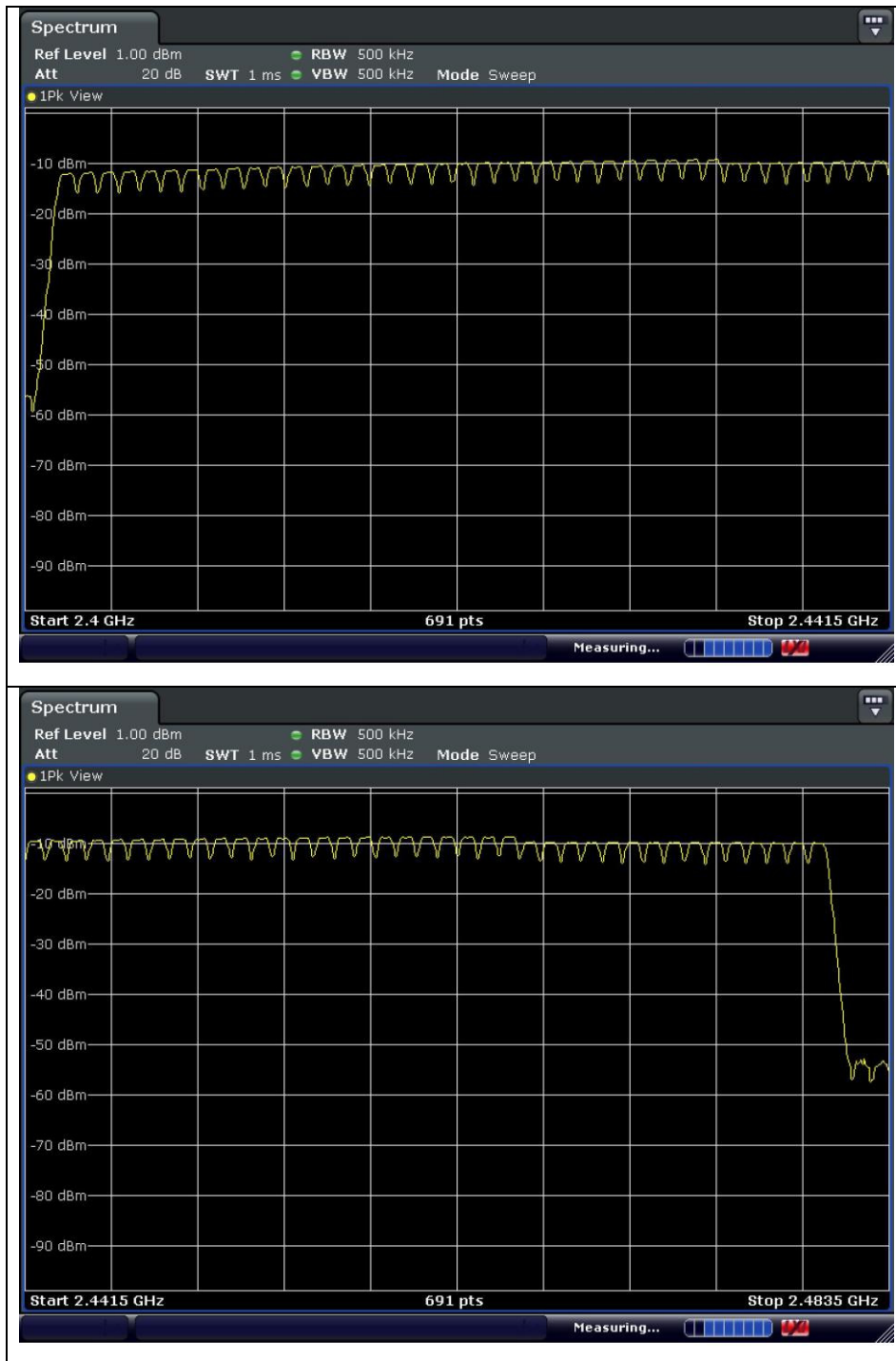

The results shown in this test report refer only to the sample(s) tested unless otherwise stated. This test report cannot be reproduced, except in full, without prior written permission of the Company.

SGS Korea Co., Ltd. (Gunpo Laboratory) 4, LS-ro 182beon-gil, Gunpo-si, Gyeonggi-do, Korea, 15807 <http://www.sgsgroup.kr>

Operating Mode : 8DPSK

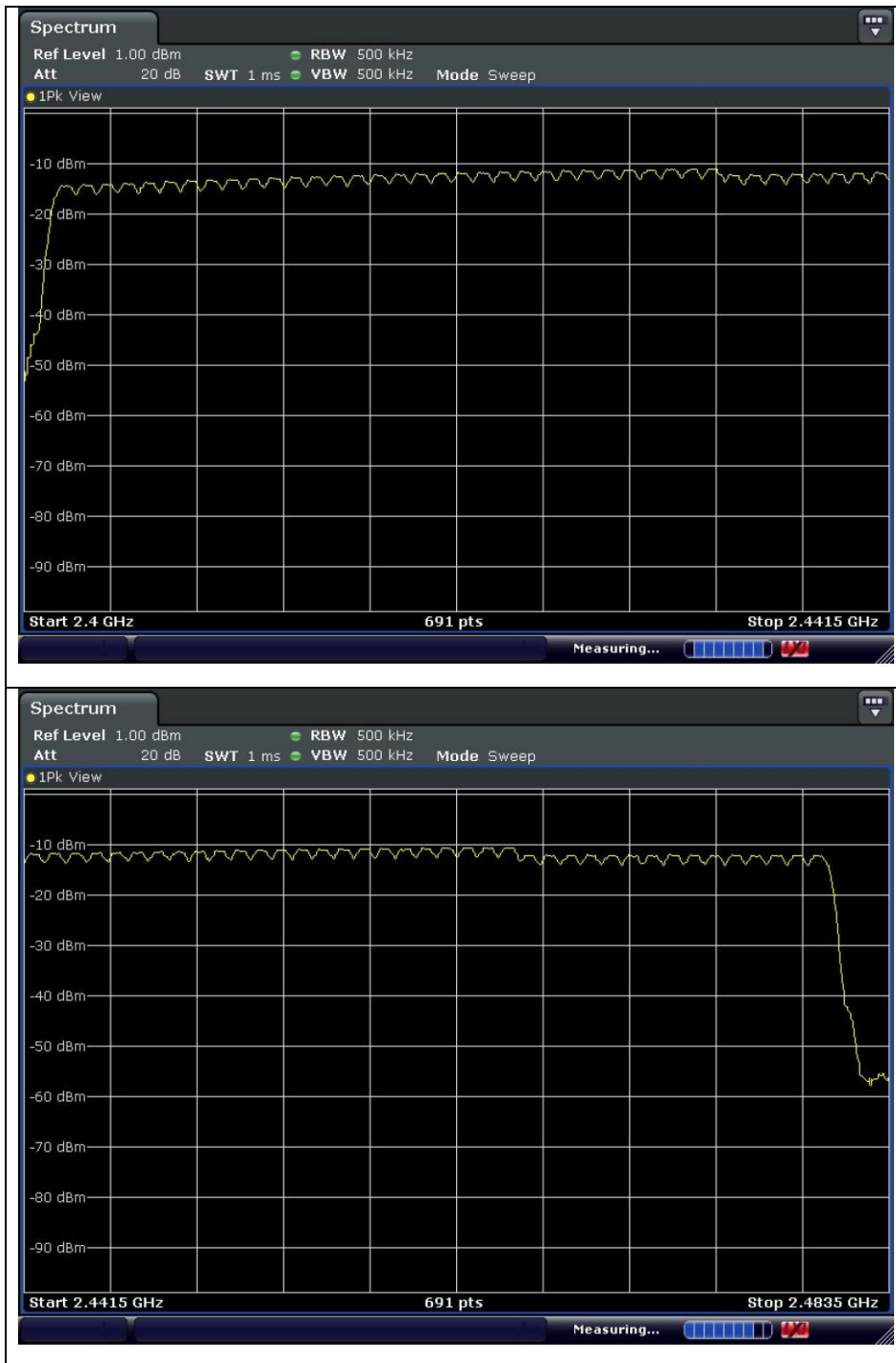

The results shown in this test report refer only to the sample(s) tested unless otherwise stated. This test report cannot be reproduced, except in full, without prior written permission of the Company.

SGS Korea Co., Ltd. (Gunpo Laboratory) 4, LS-ro 182beon-gil, Gunpo-si, Gyeonggi-do, Korea, 15807 <http://www.sgsgroup.kr>

7. Time of Occupancy (Dwell Time)

7.1. Test Set up

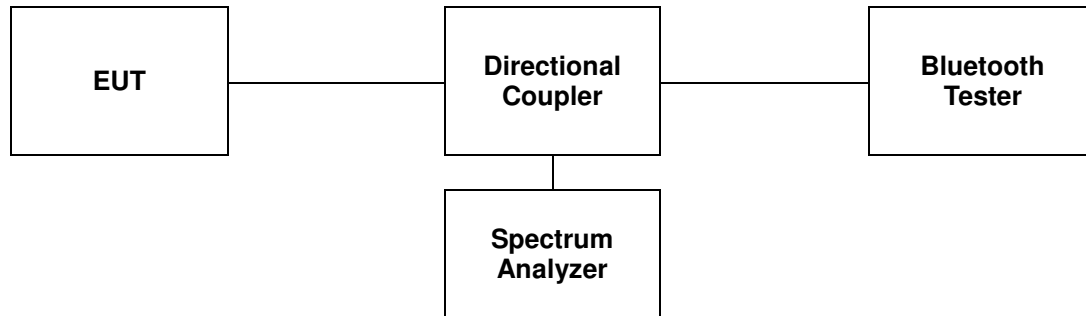

7.2. Limit

§15.247(a)(1)(iii) For frequency hopping system operating in the 2 400-2 483.5 MHz band, the average time of occupancy on any frequency shall not be greater than 0.4 second within a 31.6 second period.

A period time = 0.4 (s) * 79 = 31.6 (s)

*Adaptive Frequency Hopping

A period time = 0.4 (s) * 20 = 8 (s)

7.3. Test Procedure

All data rates and modes were investigated for this test. The full data for the worst case data rate are reported in this section. The test follows DA 00-705.

1. Check the calibration of the measuring instrument using either an internal calibrator or a known signal from an external generator.
2. Position the EUT as shown in test setup without connection to measurement instrument. Turn on the EUT and connect its antenna terminal to measurement instrument via a low loss cable.
3. Measure the time duration of one transmission on the measured frequency. And then plot the result with time difference of this time duration.
4. The Bluetooth has 3 type of payload, DH1, DH3, DH5 and 3DH1, 3DH3, 3DH5. The hopping rate is insisted of 1 600 per second.

The EUT must have its hopping function enabled. Use the following spectrum analyzer setting:

Span = zero span, centered on a hopping channel

RBW = 1 MHz

VBW ≥ RBW

Sweep = as necessary to capture the entire dwell time per hopping channel

Detector = peak

Trace = max hold

Use the marker-delta function to determine the dwell time. If this value varies with different modes of operation repeat this test for each variation.

The results shown in this test report refer only to the sample(s) tested unless otherwise stated. This test report cannot be reproduced, except in full, without prior written permission of the Company.

SGS Korea Co., Ltd. (Gunpo Laboratory) 4, LS-ro 182beon-gil, Gunpo-si, Gyeonggi-do, Korea, 15807 <http://www.sgsgroup.kr>

RTT5041-20(2015.10.01)(3)

Tel. +82 31 428 5700 / Fax. +82 31 427 2370

A4(210 mm x 297 mm)

7.4. Test Results

Ambient temperature : (23 ± 1) °C
 Relative humidity : 47 % R.H.

7.4.1. Packet Type: DH1, 3DH1

Operation Mode	Frequency (MHz)	Dwell Time (ms)	Time of occupancy on the Tx Channel in 31.6 sec (ms)	Limit for time of occupancy on the Tx Channel in 31.6 sec (ms)
GFSK	2 441	0.38	121.60	400
8DPSK	2 441	0.41	131.20	400

Note:

Time of occupancy on the TX channel in 31.6 sec

In case of GFSK: $0.38 \times \{(1\ 600 \div 2) / 79\} \times 31.6 = 121.60$ ms

In case of 8DPSK: $0.41 \times \{(1\ 600 \div 2) / 79\} \times 31.6 = 131.20$ ms

The results shown in this test report refer only to the sample(s) tested unless otherwise stated. This test report cannot be reproduced, except in full, without prior written permission of the Company.

SGS Korea Co., Ltd. (Gunpo Laboratory) 4, LS-ro 182beon-gil, Gunpo-si, Gyeonggi-do, Korea, 15807 <http://www.sgsgroup.kr>

Operating Mode: GFSK

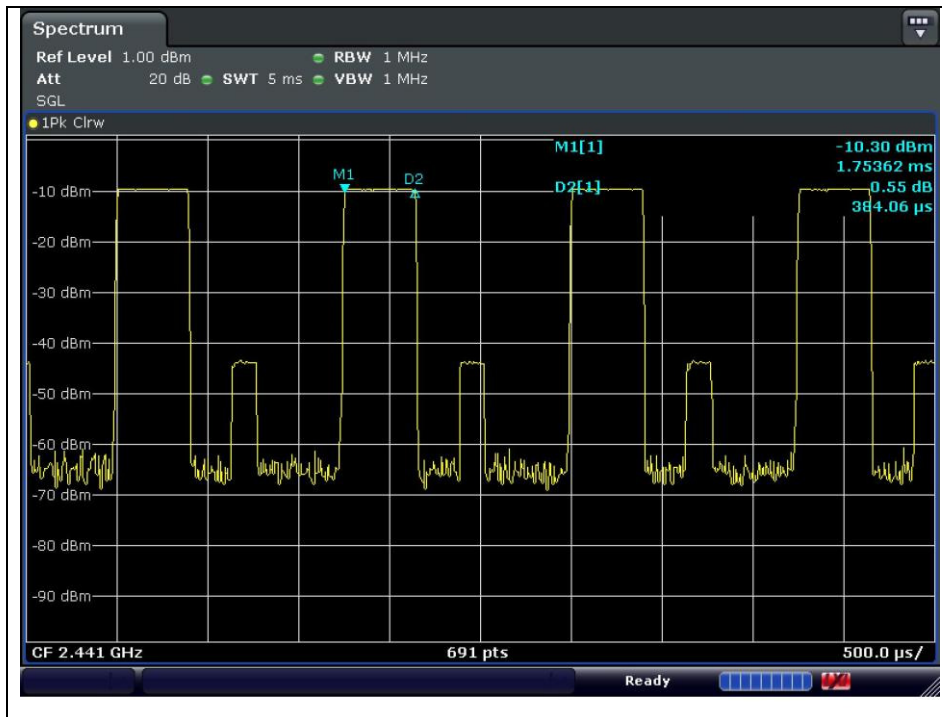

Operating Mode: 8DPSK

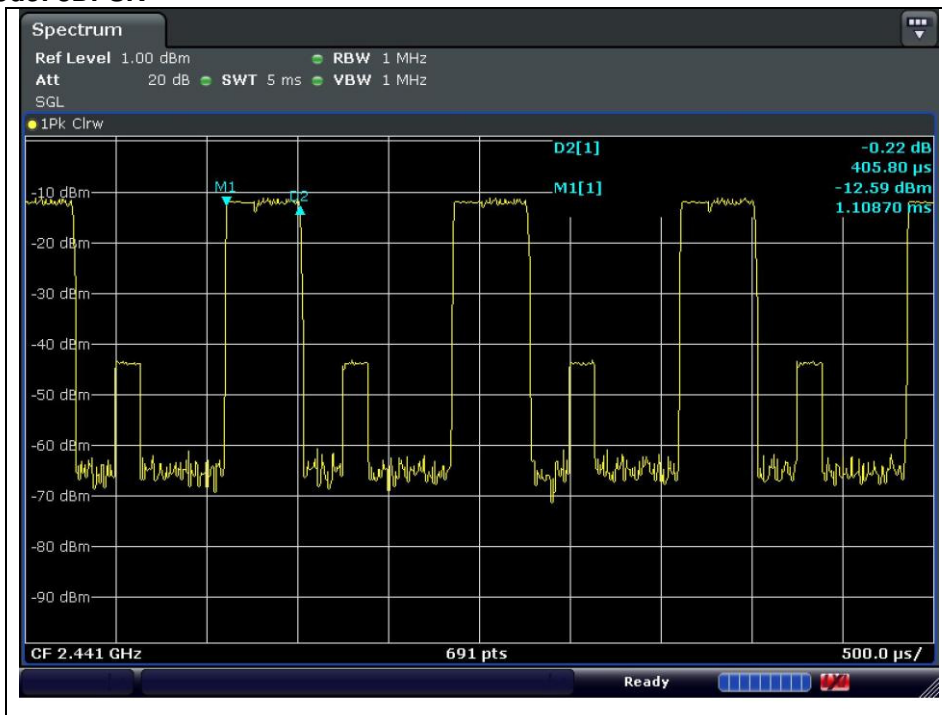

The results shown in this test report refer only to the sample(s) tested unless otherwise stated. This test report cannot be reproduced, except in full, without prior written permission of the Company.

7.4.2. Packet Type: DH3, 3DH3

Operation Mode	Frequency (MHz)	Dwell Time (ms)	Time of occupancy on the Tx Channel in 31.6 sec (ms)	Limit for time of occupancy on the Tx Channel in 31.6 sec (ms)
GFSK	2 441	1.62	259.20	400
8DPSK	2 441	1.64	262.40	400

Note:

Time of occupancy on the TX channel in 31.6 sec

 In case of GFSK: $1.62 \times \{(1\ 600 \div 4) / 79\} \times 31.6 = 259.20$ ms

 In case of 8DPSK: $1.64 \times \{(1\ 600 \div 4) / 79\} \times 31.6 = 262.40$ ms

The results shown in this test report refer only to the sample(s) tested unless otherwise stated. This test report cannot be reproduced, except in full, without prior written permission of the Company.

SGS Korea Co., Ltd. (Gunpo Laboratory) 4, LS-ro 182beon-gil, Gunpo-si, Gyeonggi-do, Korea, 15807 <http://www.sgsgroup.kr>

RTT5041-20(2015.10.01)(3)

Tel. +82 31 428 5700 / Fax. +82 31 427 2370

A4(210 mm x 297 mm)

Operating Mode: GFSK

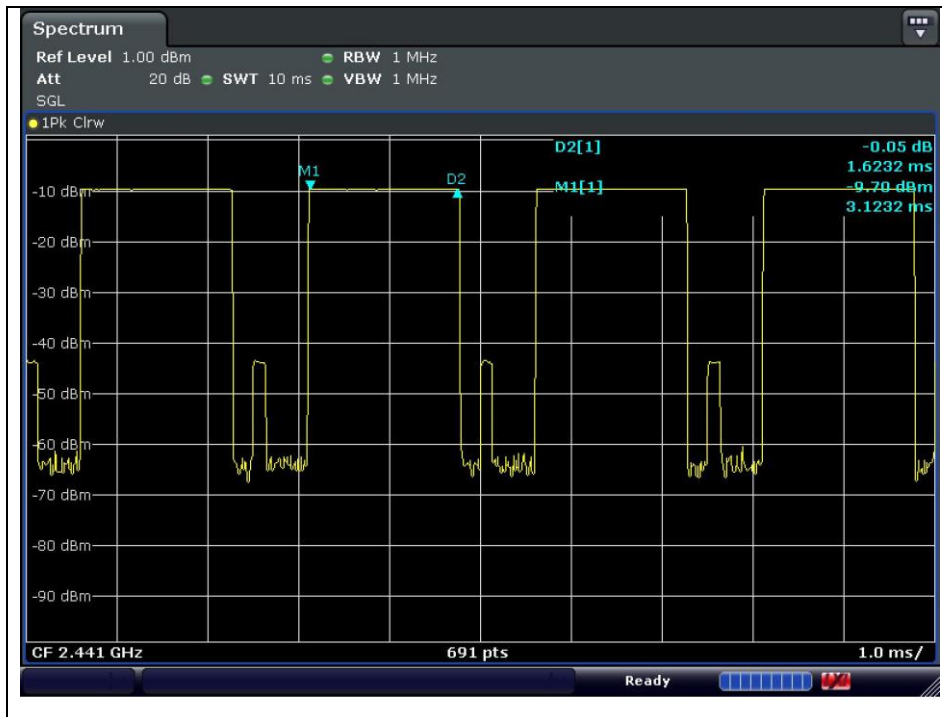

Operating Mode: 8DPSK

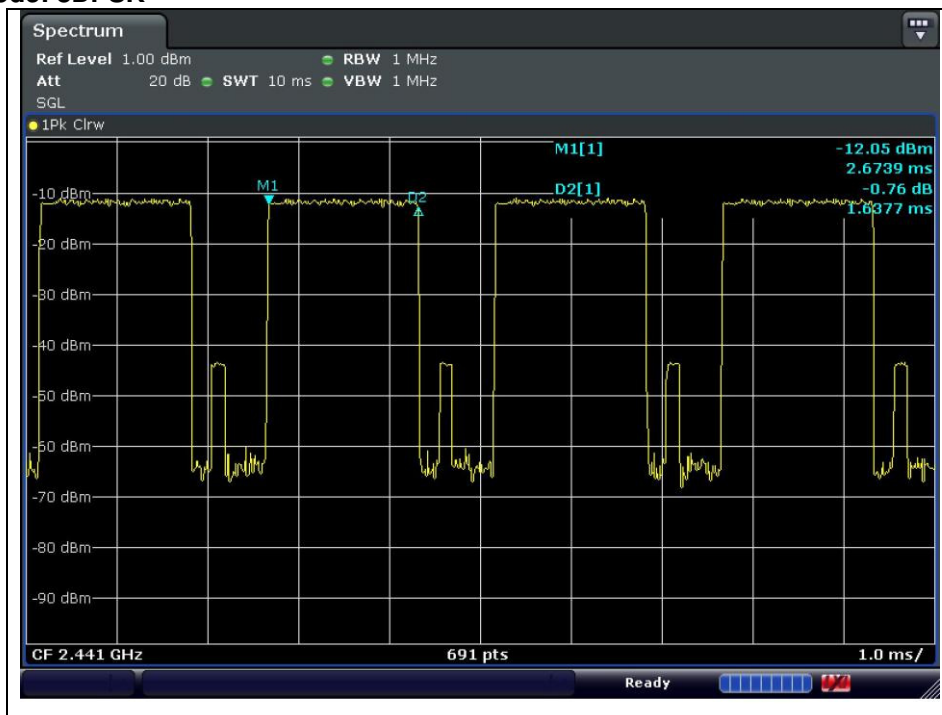

The results shown in this test report refer only to the sample(s) tested unless otherwise stated. This test report cannot be reproduced, except in full, without prior written permission of the Company.

SGS Korea Co., Ltd. (Gunpo Laboratory) 4, LS-ro 182beon-gil, Gunpo-si, Gyeonggi-do, Korea, 15807 <http://www.sgsgroup.kr>

7.4.3. Packet Type: DH5, 3DH5

Operation Mode	Frequency (MHz)	Dwell Time (ms)	Time of occupancy on the Tx Channel in 31.6 sec (ms)	Limit for time of occupancy on the Tx Channel in 31.6 sec (ms)
GFSK	2 441	2.87	306.13	400
8DPSK	2 441	2.88	307.20	400

Note:

Time of occupancy on the TX channel in 31.6 sec

 In case of GFSK: $2.87 \times \{(1\ 600 \div 6) / 79\} \times 31.6 = 306.13$ ms

 In case of 8DPSK: $2.88 \times \{(1\ 600 \div 6) / 79\} \times 31.6 = 307.20$ ms

The results shown in this test report refer only to the sample(s) tested unless otherwise stated. This test report cannot be reproduced, except in full, without prior written permission of the Company.

SGS Korea Co., Ltd. (Gunpo Laboratory) 4, LS-ro 182beon-gil, Gunpo-si, Gyeonggi-do, Korea, 15807 <http://www.sgsgroup.kr>

RTT5041-20(2015.10.01)(3)

Tel. +82 31 428 5700 / Fax. +82 31 427 2370

A4(210 mm x 297 mm)

Operating Mode: GFSK

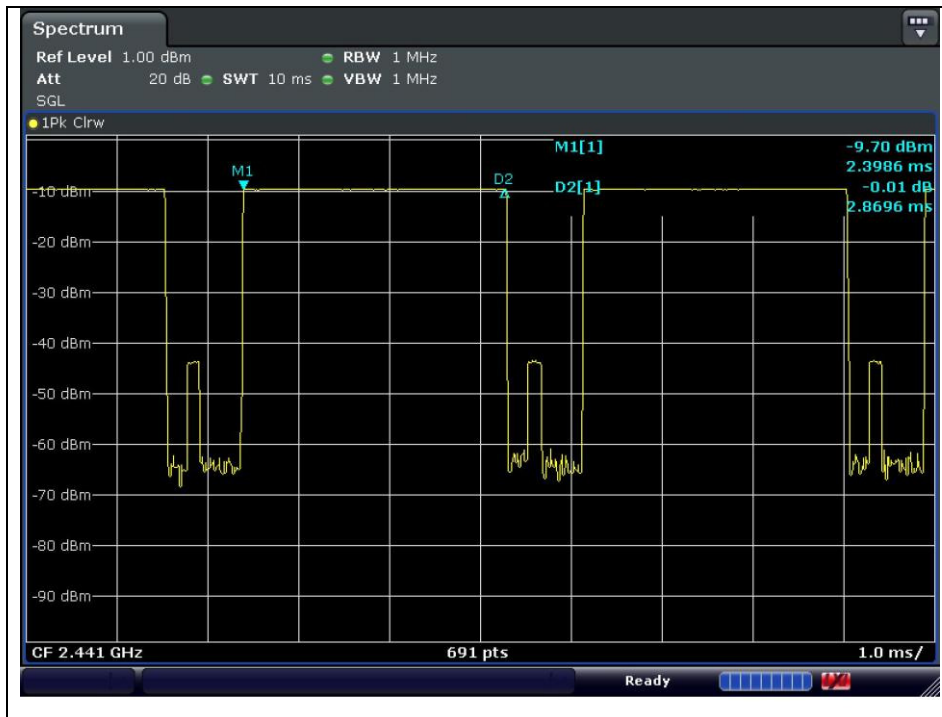

Operating Mode: 8DPSK

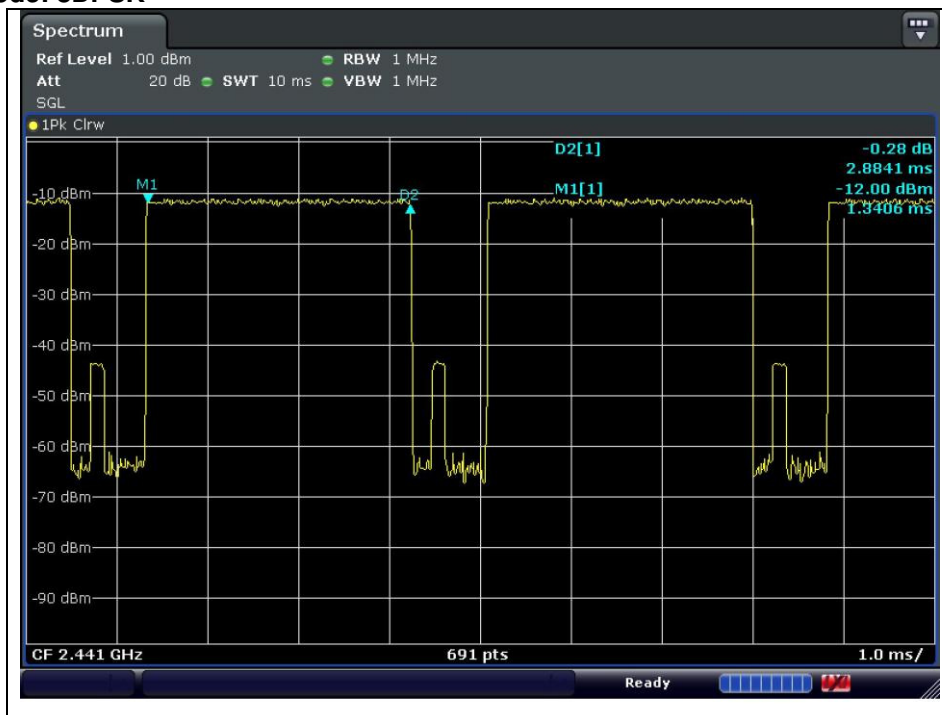

The results shown in this test report refer only to the sample(s) tested unless otherwise stated. This test report cannot be reproduced, except in full, without prior written permission of the Company.

7.4.4. Packet Type: DH1, 3DH1 (Adaptive Frequency Hopping)

Operation Mode	Frequency (MHz)	Dwell Time (ms)	Time of occupancy on the Tx Channel in 8 sec (ms)	Limit for time of occupancy on the Tx Channel in 8 sec (ms)
GFSK	2 441	0.38	60.80	400
8DPSK	2 441	0.41	65.60	400

Note:

Time of occupancy on the TX channel in 8 sec

In case of GFSK: $0.38 \times \{(800 \div 2) / 20\} \times 8 = 60.80$ ms

In case of 8DPSK: $0.41 \times \{(800 \div 2) / 20\} \times 8 = 65.60$ ms

The results shown in this test report refer only to the sample(s) tested unless otherwise stated. This test report cannot be reproduced, except in full, without prior written permission of the Company.

SGS Korea Co., Ltd. (Gunpo Laboratory) 4, LS-ro 182beon-gil, Gunpo-si, Gyeonggi-do, Korea, 15807 <http://www.sgsgroup.kr>

RTT5041-20(2015.10.01)(3)

Tel. +82 31 428 5700 / Fax. +82 31 427 2370

A4(210 mm x 297 mm)

Operating Mode: GFSK

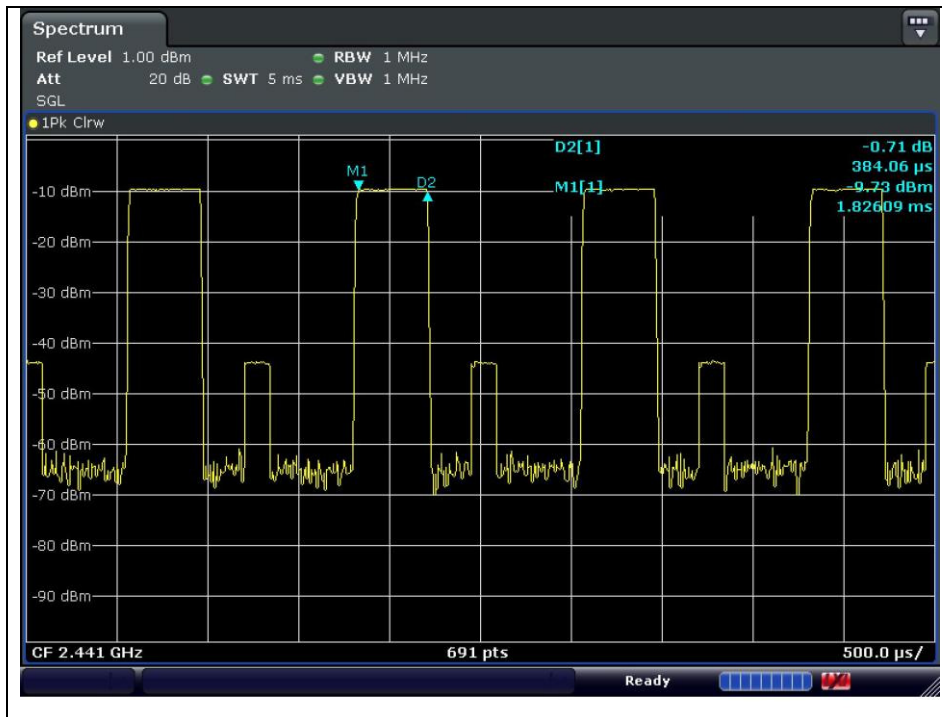

Operating Mode: 8DPSK

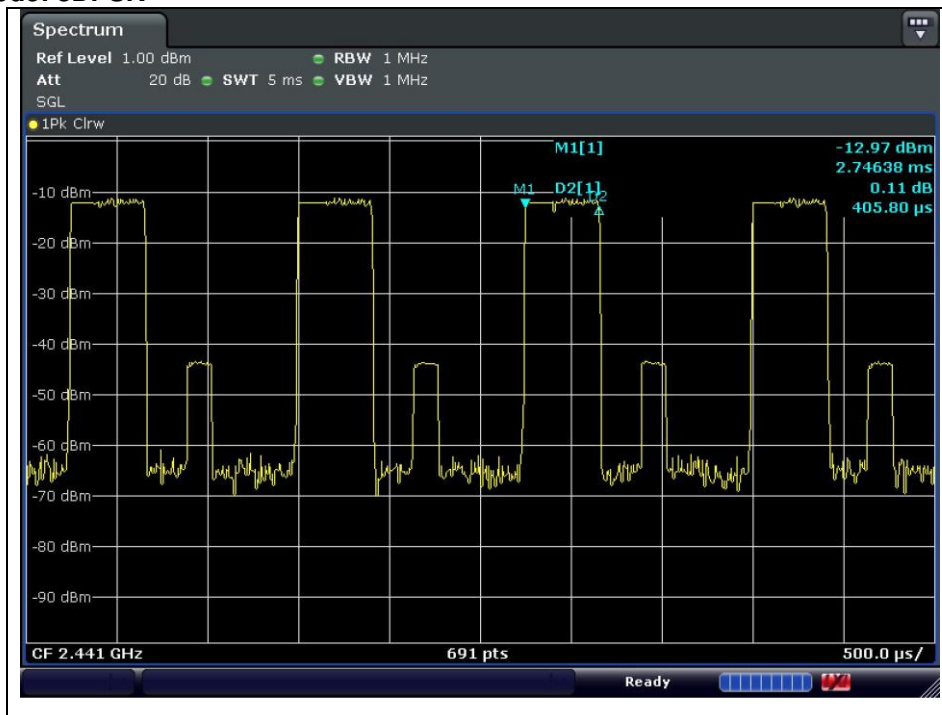

The results shown in this test report refer only to the sample(s) tested unless otherwise stated. This test report cannot be reproduced, except in full, without prior written permission of the Company.

7.4.5. Packet Type: DH3, 3DH3 (Adaptive Frequency Hopping)

Operation Mode	Frequency (MHz)	Dwell Time (ms)	Time of occupancy on the Tx Channel in 8 sec (ms)	Limit for time of occupancy on the Tx Channel in 8 sec (ms)
GFSK	2 441	1.64	131.20	400
8DPSK	2 441	1.65	132.00	400

Note:

Time of occupancy on the TX channel in 8 sec

In case of GFSK: $1.64 \times \{(800 \div 4) / 20\} \times 8 = 131.20$ ms

In case of 8DPSK: $1.65 \times \{(800 \div 4) / 20\} \times 8 = 132.00$ ms

The results shown in this test report refer only to the sample(s) tested unless otherwise stated. This test report cannot be reproduced, except in full, without prior written permission of the Company.

SGS Korea Co., Ltd. (Gunpo Laboratory) 4, LS-ro 182beon-gil, Gunpo-si, Gyeonggi-do, Korea, 15807 <http://www.sgsgroup.kr>

RTT5041-20(2015.10.01)(3)

Tel. +82 31 428 5700 / Fax. +82 31 427 2370

A4(210 mm x 297 mm)

Operating Mode: GFSK

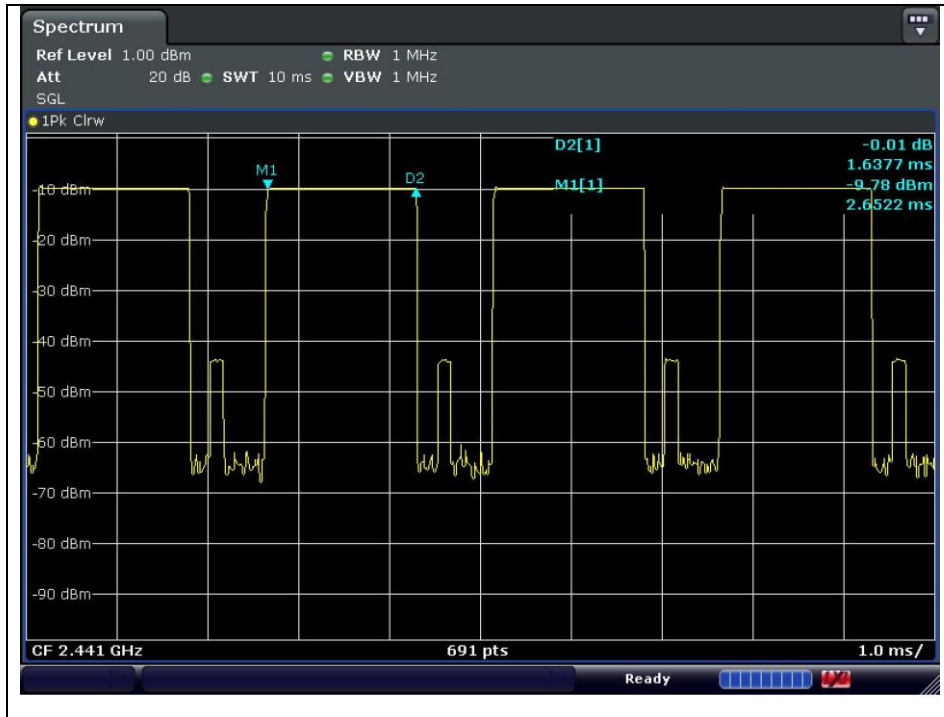

Operating Mode: 8DPSK



The results shown in this test report refer only to the sample(s) tested unless otherwise stated. This test report cannot be reproduced, except in full, without prior written permission of the Company.

7.4.6. Packet Type: DH5, 3DH5 (Adaptive Frequency Hopping)

Operation Mode	Frequency (MHz)	Dwell Time (ms)	Time of occupancy on the Tx Channel in 8 sec (ms)	Limit for time of occupancy on the Tx Channel in 8 sec (ms)
GFSK	2 441	2.88	153.60	400
8DPSK	2 441	2.91	155.20	400

Note:

Time of occupancy on the TX channel in 8 sec

 In case of GFSK: $2.88 \times \{(800 \div 6) / 20\} \times 8 = 153.60$ ms

 In case of 8DPSK: $2.91 \times \{(800 \div 6) / 20\} \times 8 = 155.20$ ms

The results shown in this test report refer only to the sample(s) tested unless otherwise stated. This test report cannot be reproduced, except in full, without prior written permission of the Company.

SGS Korea Co., Ltd. (Gunpo Laboratory) 4, LS-ro 182beon-gil, Gunpo-si, Gyeonggi-do, Korea, 15807 <http://www.sgsgroup.kr>

Operating Mode: GFSK

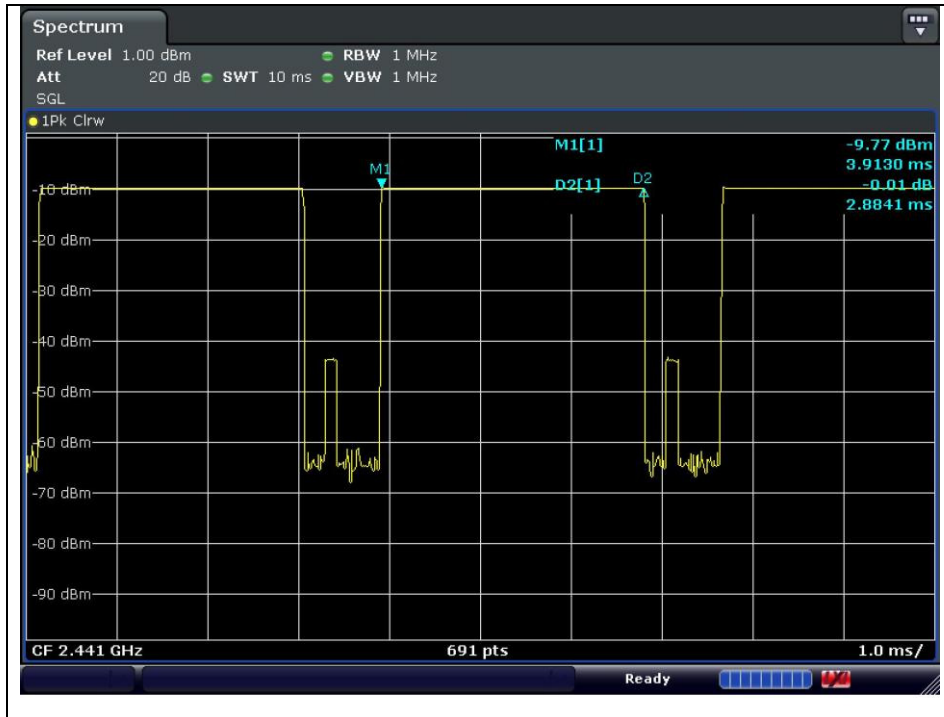

Operating Mode: 8DPSK



The results shown in this test report refer only to the sample(s) tested unless otherwise stated. This test report cannot be reproduced, except in full, without prior written permission of the Company.

8. Antenna Requirement

8.1. Standard Applicable

For intentional device, according to FCC 47 CFR Section §15.203, an intentional radiator shall be designed to ensure that no antenna other than that furnished by the responsible party shall be used with the device. And according to FCC 47 CFR Section §15.247 (b) if transmitting antennas of directional gain greater than 6 dB i are used, the power shall be reduced by the amount in dB that the gain of the antenna exceeds 6 dB i.

8.2. Antenna Connected Construction

Antenna used in this product is PIFA Antenna type with gain of 0.5 dB i.

The results shown in this test report refer only to the sample(s) tested unless otherwise stated. This test report cannot be reproduced, except in full, without prior written permission of the Company.

SGS Korea Co., Ltd. (Gunpo Laboratory) 4, LS-ro 182beon-gil, Gunpo-si, Gyeonggi-do, Korea, 15807 <http://www.sgsgroup.kr>

RTT5041-20(2015.10.01)(3)

Tel. +82 31 428 5700 / Fax. +82 31 427 2370

A4(210 mm x 297 mm)