



ENGLISH

LG-E435f User Guide

This guide helps you to get started using your phone.

- Some of the contents of this manual may not apply to your phone, depending on the software and your service provider.
- This handset is not suitable for people who have a visual impairment due to the touch screen keyboard.
- Copyright ©2012 LG Electronics, Inc. All rights reserved. LG and the LG logo are registered trademarks of LG Group and its related entities. All other trademarks are the property of their respective owners.
- Google™, Google Maps™, Gmail™, YouTube™, Google Talk™ and Android Market™ are trademarks of Google, Inc.

Contents

For your safety	4		
Safety instructions	9		
Getting to know your phone	14		
Device components.....	19		
Installing the SIM card and battery	21		
Charging your phone.....	22		
Using the memory card	22		
Locking and unlocking the screen	23		
Secure your lock screen	24		
Your Home screen	26		
Touch screen tips.....	26		
Home screen	26		
Customising the Home screen	26		
Add or remove panels to the Home screen	27		
Returning to recently-used applications....	27		
Notification drawer.....	27		
To customise the notification panel	27		
Viewing the status bar	28		
Onscreen keyboard	29		
Entering accented letters.....	29		
Google account set up	30		
Connecting to Networks and Devices ..	31		
Wi-Fi.....	31		
Connecting to Wi-Fi networks	31		
Bluetooth.....	31		
Sharing your phone's data connection.....	33		
SmartShare	34		
Using SmartShare	35		
PC connections with a PC data cable	36		
Calls	38		
Making a call.....	38		
Calling your contacts.....	38		
Answering and rejecting a call	38		
Adjusting call volume	38		
Making a second call	38		
Viewing your call logs.....	39		
Call settings	39		
Contacts	41		
Searching for a contact	41		
Adding a new contact.....	41		
Favourite contacts.....	41		
Import or export contacts.....	41		
Moving contacts from your old device to your new device.....	42		
Messaging	43		
Sending a message	43		
Threaded box	43		
Using emoticons	43		
Changing your message settings	43		
E-mail	44		
Managing an email account.....	44		
Email account screen.....	44		
Working with account folders.....	44		
Composing and sending email.....	44		

Camera	46	The web	61
Getting to know the viewfinder	46	Internet	61
Taking a quick photo	47	Using the web toolbar	61
Using the advanced settings	47	Using options	61
View a photo	48	Settings	62
Video camera	50	Access the Settings menu	62
Getting to know the viewfinder	50	WIRELESS & NETWORKS	62
Shooting a quick video	51	DEVICE	65
Using the advanced settings	51	PERSONAL	66
Play a video	51	SYSTEM	68
Multimedia	53	Phone software update	71
Gallery	53	Trademarks	72
QuickMemo	54	DivX Mobile	72
Music player	55	Accessories	73
FM Radio	56	Troubleshooting	74
Searching for stations	56	FAQ	76
LG Tag+	57		
LG SmartWorld	58		
How to get to LG SmartWorld from your phone	58		
How to use LG SmartWorld	58		
Utilities	59		
Setting your alarm	59		
Using your calculator	59		
Adding an event to your calendar	59		
Polaris Office	59		

This device is not intended for sale in the U.S.A

Part 15.21 statement

" Change or Modifications that are not expressly approved by the manufacturer could void the user's authority to operate the equipment. "

Part 15.105 statement

This equipment has been tested and found to comply with the limits for a class B digital device, pursuant to Part 15 of the FCC Rules.

These limits are designed to provide reasonable protection against harmful interference in a residential installation. This equipment generates uses and can radiate radio frequency energy and, if not installed and used in accordance with the instructions, may cause harmful interference to radio communications. However, there is no guarantee that interference will not occur in a particular installation. If this equipment does cause harmful interference to radio or television reception, which can be determined by turning the equipment off and on, the user is encouraged to try to correct the interference by one or more of the following measures:

- Reorient or relocate the receiving antenna.
- Increase the separation between the equipment and receiver.
- Connect the equipment into an outlet on a circuit different from that to which the receiver is connected.
- Consult the dealer or an experienced radio/TV technician for help.

FCC Part 15.19 statement

This device complies with part 15 of FCC rules and ICES-003 Class B digital apparatus requirements for Industry Canada. Operation is subject to the following two conditions:(1) This device may not cause harmful interference, and (2) this device must accept any interference received, including interference that may cause undesired operation.

Body-worn Operation

This device was tested for typical body-worn operations with the back of the phone kept 1.0cm (0.39 inches) between the user's body and the back of the phone. To comply with FCC RF exposure requirements, a minimum separation distance of 1.0cm (0.39 inches) must be maintained between the user's body and the back of the phone. Third-party belt-clips, holsters, and similar accessories containing metallic components may not be used. Body-worn accessories that cannot maintain 1.0cm (0.39 inches) separation distance between the user's body and the back of the phone, and have not been tested for typical body-worn operations may not comply with FCC RF exposure limits and should be avoided.

For your safety

Important Information

This user's guide contains important information about the use and operation of this phone. Read all information carefully for optimal performance and to avoid any damage or misuse of the phone. Any changes or modifications not expressly approved in this user's guide could void your warranty for this equipment.

Before you begin

Safety Guidelines

 **WARNING!** To reduce the possibility of electric shock, do not expose your product to high humidity areas, such as bathroom or swimming pool.

Keep the phone away from heat. Never store your phone in environment that may expose it to temperatures below 0°C or above 40°C, such as outdoor during snowstorm, or in your car in hot days. Exposure to cold or heat will result in malfunction, damage or permanent failure. Be careful when using your phone near other electronic devices. The RF emissions from mobile phones may affect nearby electronic equipment that not adequately shielded. You should consult manufacturers of any personal medical devices, as in the case of pacemakers and hearing aides, to determine whether they are

susceptible to interference from cell phones. Turn off your phone in medical facilities or at gas stations. Never place your phone in microwaves, as it will cause the battery to explode.

Important! Before using your phone, please read the SAFETY INFORMATION OF THE TELECOMMUNICATIONS INDUSTRY ASSOCIATION (TIA).

Safety Information

Read these simple guidelines. Breaking the rules may be illegal or dangerous.

More detailed information is provided in this user's guide.

- Never use an unapproved battery that could cause damages to the phone or the battery itself, or even explode.
- Never place your phone in a microwave oven, as this will result in an explosion of the battery.
- Do not dispose of your battery in fire or with hazardous or flammable materials.
- Make sure the battery does not come into contact with sharp-edged items, such as animal teeth or claws. This could cause a fire.
- Store the battery in a place out of the reach of children.

- Be careful so that children do not swallow any parts of the phone, such as rubber plugs (earpiece, parts that connect to the phone, etc.). This could cause asphyxiation or suffocation.
- Disconnect the plug and charger from the outlet when the phone shows that the battery has been fully charged, because it may cause electric shock or fire hazard.
- When in the car, do not leave your phone, or install a hands-free kit, near the airbag. If wireless equipment is improperly installed, you can be seriously injured if the airbag is deployed.
- Do not use mobile phone while driving.
- Do not use the phone in areas where its usage is prohibited. (For example: in airplanes).
- Do not expose the battery charger or adapter to direct sunlight, or use it in places with high humidity, such as bathroom.
- Never store your phone in temperatures lower than -20°C or higher than 50°C .
- Do not use harsh chemicals (such as alcohol, benzene, solvents, etc.) or detergents to clean the phone. This could cause fire.
- Do not drop the phone, strike it, or shake it hard.
Such actions may harm the phone's internal circuit boards.
- Do not use your phone in high explosive areas, as this may generate sparks.
- Do not damage the power cord by bending, twisting, pulling, or heating it. Do not use the plug if it is loose as it may cause fire or electric shock.
- Do not handle the phone with wet hands while it is charging. This can cause electric shock or seriously damage your phone.
- Do not disassemble the phone.
- Do not make or answer calls while charging the phone, which can cause a short circuit, electric shock, or fire.
- Use only batteries and chargers provided by LG. The warranty does not apply to products provided by other providers.
- Only authorized personnel should service the phone and its accessories. Installation or service may result in accidents and consequently invalidate the warranty.
- Do not hold or let the antenna come in contact with your body during a call.
- Emergency calls can be made only within a service area. To make an emergency call, make sure you are within a service area and the phone is on.
- Use your accessories, such as headphones or headsets, with caution, ensuring that the

For your safety

cables are plugged properly and that they do not touch the antenna unnecessarily.

Information about the RF exposure from FCC

 **WARNING!** Read this information before operating the phone.

In August 1996, the Federal Communications Commission (FCC) of the United States, with its action in Report and Order FCC 96-326, adopted an updated safety standard for human exposure to radio frequency (RF) electromagnetic

energy emitted by FCC regulated transmitters. Those guidelines are consistent with the safety standard previously set by both international and U.S. standards.

The design of this phone complies with FCC guidelines and these international standards.

Caution

Use only the supplied antenna. Use of unauthorized antennas, or modifications, could impair call quality, damage the phone, void your warranty, or result in a violation of FCC regulations.

Do not use the phone with a damaged antenna.

A damaged antenna in contact with the skin could cause a singe. Contact your local dealer for an antenna replacement.

Body effects

This device was tested for typical body operation, keeping a distance of 1 cm (0.39 inch) between the user's body and the back of the phone. To comply with RF exposure requirements of the FCC standards, a minimum distance of 1 cm (0.39 inch) between the user's body and the back of the phone is required.

Belt-clips, holsters, and similar accessories containing metallic components from others manufacturers should not be used.

Accessories worn close to the body, without keeping a minimum distance of 1 cm (0.39 inch) between the user's body and the back of the phone, and that have not been tested for typical body operation, may not comply with FCC's RF exposure limits and should be avoided.

External antenna mounted on the vehicle (optional, if available)

It must keep a minimum distance of 20 cm (8 inches) between the user / bystander and the vehicle mounted external antenna, in order to satisfy FCC's RF exposure requirements.

For more information about RF exposure, visit the FCC Website at www.fcc.gov

Class B Compliance under article 15 of the FCC

This device and its accessories comply with Article 15 of the FCC rules.

The operation is subject to the following conditions:

(1) This device, and its accessories, will not cause harmful interference and (2) this device and its accessories must accept any interference received, including interference that could cause an undesired operation.

Battery Precautions

- Do not disassemble.
- Do not short-circuit.
- Do not expose to high temperatures, over 60 °C (140 °F).
- Do not incinerate.

Battery Disposal

- Please dispose off your battery properly, or bring it to your wireless provider for recycling.
- Do not dispose off your battery in fire or with hazardous or flammable materials.

Adapter Precautions (Charger)

- Using the wrong battery charger could damage your phone and void your warranty.
- The adapter or battery charger is only

designed for indoor use.

- Do not expose the battery charger or adapter to direct sunlight, or use it in places with high humidity, such as the bathroom.

Cautions for Battery

- Do not disassemble or open crush, bend or deform, puncture or shred.
- Do not modify or remanufacture, attempt to insert foreign objects into the battery, immerse or expose to water or other liquids, expose to fire, explosion or other hazard.
- Only use the battery for the system for which it is specified.
- Only use the battery with a charging system that has been qualified with the system per this standard. Use of an unqualified battery or charger may present a risk of fire, explosion, leakage, or other hazard.
- Do not short circuit a battery or allow metallic conductive objects to contact battery terminals.
- Replace the battery only with another battery that has been qualified with the system per this standard, IEEE-Std-1725-200x. Use of an unqualified battery may present a risk of fire, explosion, leakage or other hazard.

For your safety

- Promptly dispose of used batteries in accordance with local regulations.
- Battery usage by children should be supervised.
- Avoid dropping the phone or battery. If the phone or battery is dropped, especially on a hard surface, and the user suspects damage, take it to a service center for inspection.
- Improper battery use may result in a fire, explosion or other hazard.
- For those host devices that utilize a USB port as a charging source, the host device's user manual shall include a statement that the phone shall only be connected to products that bear the USB-IF logo or have completed the USB-IF compliance program.

Avoid damage to your ear

- Damage to your hear can occur due to constant exposure to excessive high sound. We, therefore, recommend that you do not turn on or off the phone near your ear. We also recommend you be reasonable with the music and volume level.
- If you listen to music, please ensure that the volume level is adequate, so that you are aware of your surroundings. This is particularly important when attempting to cross a street.

Safety instructions

TIA's Safety Information

This includes complete security information on wireless phones from TIA (Telecommunications Industry Association).

It's required, for CTIA Certification, the inclusion in the user manual of text covering pacemakers, hearing aids and other medical devices. It's encouraged the use of the remaining TIA language when relevant.

Exposure to Radio Frequency Signal

Your wireless handheld portable telephone is a low power radio transmitter and receiver. When it is ON, it receives and also sends out radio frequency (RF) signals.

In August, 1996, the Federal Communications Commission (FCC) adopted RF exposure guidelines with safety levels for handheld wireless phones. Those guidelines are consistent with the safety standards previously set by both U.S. and international standards bodies:

ANSI C95.1 (1992) *

NCRP Report 86 (1986)

ICNIRP (1996)

Those standards were based on comprehensive and periodic evaluations of the relevant scientific literature. For example, over 120 scientists, engineers, and

physicians from universities, government health agencies, and industry reviewed the available body of research to develop the ANSI Standard (C95.1).

* American National Standards Institute; National Council on Radiation Protection and Measurements; International Commission on Non-Ionizing Radiation Protection.

The design of your phone complies with the FCC guidelines (and those standards).

Antenna Care

Use only the supplied or an approved replacement antenna. Unauthorized antennas, modifications, or attachments could damage the phone and may violate FCC regulations.

Phone Operation

NORMAL POSITION: Hold the phone as you would any other telephone with the antenna pointed up and over your shoulder.

Suggestions for a more efficient operation

For your phone to operate most efficiently:

- Do not touch the antenna unnecessarily, when the phone is in use. The contact with the antenna affects call quality, and may cause the phone to operate at a higher power level than otherwise would be need.

For your safety

Driving

Check the laws and regulations related to the use of wireless phones in the areas where you drive. Always obey these regulations. Also, if using your phone while driving, make sure to:

- Pay full attention to driving; driving safely is your first responsibility;
- Use hands-free operation, if available;
- Pull off the road and park, before making or answering a call, if driving conditions demand so.

Electronic Devices

Most modern electronic equipment is shielded from RF signals.

However, certain electronic equipment may not be shielded against the RF signals from your wireless phone.

Pacemaker

The Medical Industry Manufacturers Association recommends a minimum distance of fifteen (15) centimeters, or six (6) inches, between a handheld wireless phone and a pacemaker, in order to avoid potential interference between them.

These advices are consistent with independent researches, and with recommendations based on wireless technology research.

People with pacemakers should:

- ALWAYS keep the phone at least fifteen centimeters (six inches) from their pacemaker, whenever the phone is turned on;
- Do not carry the phone in shirt pocket;
- Use the ear opposite to the pacemaker, to minimize the potential interference;
- If you have any reason to suspect that interference is taking place, switch off your phone immediately.

Hearing Aids

Some digital wireless phones may interfere with some hearing aids. In the event of such interference, we recommend that you contact your service provider.

Other Medical Devices

If you use any other personal medical devices, consult your device manufacturer to determine if they are adequately shielded from external RF energy. Your doctor can help you obtain this information.

Health Care Facilities

Turn off your phone in health care facilities, whenever there are signs asking you to do so. Hospitals or health care facilities may use equipment that could be sensitive to external RF energy.

Vehicles

RF signals may affect improperly installed or inadequately shielded devices in motor vehicles.

Check with the manufacturer, or its representative, regarding your vehicle.

You should also consult the manufacturer about any equipment that has been added to your vehicle.

Facilities with signs

Turn off the phone in any facility where warning signs request you to do so.

Airplanes

FCC regulations prohibit the use of phones while in the air. Turn off your phone before boarding an airplane.

Blasting Areas

To avoid interfering with blasting operations, turn your phone off when in a 'blasting area' or in areas with signs that read: 'Turn off two-way radios' . Obey all signs and instructions.

Potentially Explosive Atmosphere

Turn off the phone when in an area with a potentially explosive atmosphere, and obey all signs and instructions.

Sparks in such areas could cause an explosion or fire that could result in personal injury or death.

Areas with a potentially explosive atmosphere are often clearly marked, but not always. Among the potentially dangerous areas are:

Fueling areas (such as gas stations), areas below deck on boats, facilities where chemical products are transferred or stored, vehicles using liquefied petroleum gas (as propane or butane), areas where the air contains chemicals or particles (such as grain, dust or metal powders), and any other areas where you would normally be advised to turn off your vehicle engine.

For your safety

For vehicles equipped with air bags

Air bags inflate with strong force. Do not place objects in the area over the air bag or in its deployment area, including wireless equipment, either installed or portable.

Serious injuries could occur if wireless equipment is improperly installed into the car when the air bag inflates.

Safety Information

Read and observe the following information for the safe and proper use of your phone, and to prevent any damage.

Also, keep the user's guide in an accessible place at all times after reading it.

Charger, Adapter and Battery Security

- The charger and adapter are designed only for indoor use.
- Dispose of your battery properly, or bring it to your wireless provider for recycling.
- The battery doesn't need to be fully discharged before recharging.
- Only use LG approved chargers that are specifically made for your phone model, since they are designed to maximize the battery life.
- Do not disassemble or short-circuit it.
- Keep the metal contacts on the battery

clean.

- Replace the battery when it no longer provides acceptable performance. The battery can be recharged several hundred times before replacement.
- Charge the battery after long periods without use to maximize its life.
- The battery life will vary depending on usage patterns and environmental conditions.
- Intensive use of backlighting, browser, and packet data connectivity affect battery life and talk/standby times.
- The role of self-protection interrupts the phone when its operation is in an abnormal state. In this case, remove the battery from the phone, reinstall it, and turn on the phone.

Explosion, Shock and Fire Danger

- Do not place the phone in a place exposed to excessive dust, and keep the minimum required distance between the power cord and heat sources.
- Unplug the power cord before cleaning the phone, and clean the power plug whenever it is dirty.
- When using the power plug, make sure it is firmly connected. Otherwise, it can overheat or start a fire.

- Placing the phone in a pocket or bag without covering the receptacle (power plug pin), metallic articles (such as a coin, clip or pen) may short-circuit the phone. Always cover the receptacle when not in use.
- Do not short-circuit the battery. Metal items, such as coins, paper clips, or pens, in your pocket or bag may cause a short-circuit between the + and - terminals of the battery (metal strips on the battery). The short-circuit of the terminals may damage the battery and cause an explosion.

General Notice

- Using a damaged battery, or inserting it into the mouth can cause serious injuries.
- Do not place the phone in proximity to items containing magnetic components, such as credit cards, calling cards, bank books, or subway tickets. The phone magnetism may damage the data stored in the magnetic strip.
- Talking on the phone for a long period of time may reduce call quality, because of the heat generated during use.
- When the phone has not been in use for a long time, store it in a safe place, with the power cord unplugged.
- Using the phone close to a receiving equipment (such as TV or radio) may cause interference.
- Do not use the phone if the antenna is damaged. If a damaged antenna contacts skin, it may cause a slight singe. Contact an LG Authorized Service Facility to replace the damaged antenna.
- Do not immerse your phone in water. If this happens, immediately turn it off and remove the battery. If your phone does not work, take it to an LG Authorized Service Facility.
- The power supply contains elements that could be harmful to your health, if components are handled directly. If this happens, we recommend immediate hand-washing.
- Do not paint the phone.
- Data stored in your phone might be deleted due to careless use, hardware repair or software upgrade. Please backup your important phone numbers (ringtones, text or voice messages, images, and videos might also get deleted). The manufacturer is not liable for damages due to loss of data.
- When using the phone in public places, you may set the ringer on vibrate to avoid disturbing others.
- Do not switch the phone on/off while it is in your ear.

Getting to know your phone

Before you start using the phone, please read this!

Please check to see whether any problems you encountered with your phone are described in this section before taking the phone in for service or calling a service representative.

1. Phone memory

When there is less than 10% of space available in your phone memory, your phone cannot receive new messages. You need to check your phone memory and delete some data, such as applications or messages, to make more memory available.

To uninstall applications:

- 1 Touch  > **Apps** tab > **Settings** > **Apps** from the DEVICE category.
- 2 Once all applications appear, scroll to and select the application you want to uninstall.
- 3 Touch **Uninstall**.

2. Optimising battery life

Extend your battery's life between charges by turning off features that you don't need to having running constantly in the background. You can monitor how applications and system resources consume battery power.

Extending your phone's battery life:

- Turn off radio communications you are not using. If you are not using Wi-Fi, Bluetooth or GPS, turn them off.
- Reduce screen brightness and set a shorter screen timeout.
- Turn off automatic syncing for Google Mail™, Calendar, Contacts and other applications.
- Some applications you have downloaded may reduce battery power.

To check the battery power level:

- Touch  > **Apps** tab > **Settings** > **About phone** under SYSTEM > **Status**
- The battery status (charging or not charging) and level (percentage charged) are displayed.

To monitor and control how battery power is being used:

- Touch  > **Apps** tab > **Settings** > **Power Saver** from the DEVICE > **Battery use** category under BATTERY INFORMATION.

Battery usage time is displayed on the screen. It tells you how long it has been since you last connected your phone to a power source or, if currently connected, how long the phone was last running on battery power. The screen shows the applications or

services using battery power, listed in order from the greatest to smallest amount used.

3. Using folders

You can combine several app icons in a folder. Drop one app icon over another on a Home screen, and the two icons will be combined.

NOTE: After you open an app, you can usually adjust its settings by choosing items from its Menu icon near the top or bottom of the screen.

4. Before installing an open source application and OS

WARNING

If you install and use an OS other than the one provided by the manufacturer, it may cause your phone to malfunction. In addition, your phone will no longer be covered by the warranty.

WARNING

To protect your phone and personal data, only download applications from trusted sources, such as Android Market™. If there are improperly installed applications on your phone, it may not work normally or a serious error may occur. You must uninstall those applications and all associated data and settings from the phone.

5. Using the hard reset (factory reset)

If your phone does not restore to the original condition, use a hard reset (factory reset) to initialise it.

- 1 When the phone is switched off, press and hold the **Volume down key + Power key** with your left hand.
- 2 When the LED on the bottom of the phone lights up, release **Volume down key + Power keys** and press and hold the **Home key** (for about 2 seconds) at the same time.
- 3 The phone will turn on and perform a factory reset immediately.

Do not operate your phone for at least a minute, while the hard reset is carried out. You will then be able to switch your phone back on.

Getting to know your phone

WARNING

If you perform a hard reset, all user applications, user data and DRM licences will be deleted. Please remember to back up any important data before performing a Hard Reset.

6. Opening and switching applications

Multitasking is easy with Android because you can keep more than one application running at the same time. There's no need to quit an application before opening another. Use and switch between several open applications. Android manages each application, stopping and starting them as needed to ensure that idle applications don't consume resources unnecessarily.

To view the list of recently used applications:

Simply press and hold the **Home** key.

To stop applications:

- 1 Touch  > **Apps** tab > **Settings** > **Apps** from the **DEVICE** > **RUNNING** tab.
- 2 Scroll and touch the desired application and touch **Stop** to stop it.

7. Installing PC software (LG PC Suite)

The LG PC Suite is a software package that helps you connect your device to a PC via a USB cable and Wi-Fi. Once connected, you can use the functions of your device from your PC.

With the LG PC Suite software, you can...

- Manage and play your media content (music, movies, pictures) on your PC.
- Send multimedia content to your device.
- Synchronise data (schedules, contacts, bookmarks) between your device and PC.
- Backup the applications in your device.
- Update the software in your device.
- Backup and restore the device.
- Play multimedia content from your PC on your device.

NOTE: You can use the application's Help menu to find out how to use your LG PC Suite software.

Installing the LG PC Suite software

The LG PC Suite software can be downloaded from the LG webpage.

- 1 Go to www.lg.com and select a country of your choice.
- 2 Go to **Support** > **Mobile Phone Support** > Select the Model (LG-E435f).

- 3 Click **PC Sync** from **Download**, and click **WINDOW PC Sync Download** to download the **LG PC Suite** software.

System Requirements for the LG PC Suite software

- OS: Windows XP 32 bit (Service Pack 2), Windows Vista 32 bit/64 bit, Windows 7 32 bit/64 bit
- CPU: 1 GHz (or faster) processors
- Memory: 512 MB (or more) RAM
- Graphic card: 1024 x 768 resolution, 32-bit colour (or higher)
- HDD: 100 MB (or more) free hard disk space (more free hard disk space may be needed depending on the volume of data stored)
- Required software: LG integrated drivers

NOTE: LG integrated USB driver

LG integrated USB driver is required to connect an LG device and PC and is installed automatically when you install the LG PC Suite software.

8. Synchronising your phone to a computer

Data from your device and PC can be synchronised easily using the LG PC Suite software. Contacts, schedules, and bookmarks can be synchronised.

The procedure is as follows:

- 1 Connect your device to your PC (use a USB cable or Wi-Fi connection).
- 2 After connection, run the program and select the device section from the category on the left side of the screen.
- 3 Click [Personal information] to select it.
- 4 Tick the checkboxes of the content you want to synchronise, and click the **Sync** button.

9. Synchronising your phone to a computer via USB

NOTE: To synchronise your phone with your PC using the USB cable, you need to install LG PC Suite on your PC. Please refer to previous pages to install LG PC Suite.

- 1 Touch  > **Apps** tab > **Settings** > **Storage** from the **DEVICE** tab to check out the storage media. (If you want to transfer files to or from a memory card, insert a memory card into the phone.)

Getting to know your phone

- 2 Connect the phone to your PC using the USB cable.
- 3 The USB connection mode list will appear; select the **Media sync (MTP)** option.
- 4 Open the removable memory folder on your PC. You can view the mass storage content on your PC and transfer the files.
- 5 Copy the files from your PC to the drive folder.
- 6 Select the charge only option to disconnect the phone.

TIP! To use the microSD card on your phone again, you need to open the notification drawer and touch  > **Charge only**.

To disconnect your phone from the computer:

Open the notification drawer and touch  > **Charge only** to disconnect your phone from the computer safely.

10. Hold your phone upright

Hold your mobile phone vertically, as you would a regular phone. The LG-E435f has an internal antenna. Be careful not to scratch or damage the back of the phone, as this may affect performance.

While making/receiving calls or sending/

receiving data, avoid holding the lower part of the phone where the antenna is located. Doing so may affect call quality.

11. When the screen freezes

If the screen freezes or the phone does not respond when you try to operate it:

Remove the battery, reinsert it, then turn the phone on.

OR

Press and hold the **Power/Lock** key for 10 seconds to turn it off.

If it still does not work, please contact the service centre.

Device components

Earpiece

Proximity sensor

Home key

Return to the Home screen from any screen.

Back key

Return to the previous screen.

Power/Lock key

- Switch your phone on/off by pressing and holding this key.
- Short press to lock/unlock the screen.

Menu key

- Check what options are available.

NOTE: Proximity sensor

When receiving and making calls, the proximity sensor automatically turns the backlight off and locks the touch screen by sensing when the phone is near your ear. This extends battery life and prevents you from unintentionally activating the touch screen during calls.

⚠ WARNING

Placing a heavy object on the phone or sitting on it can damage the LCD and touch screen functions. Do not cover the LCD proximity sensor with protective film. This could cause the sensor to malfunction.

Getting to know your phone

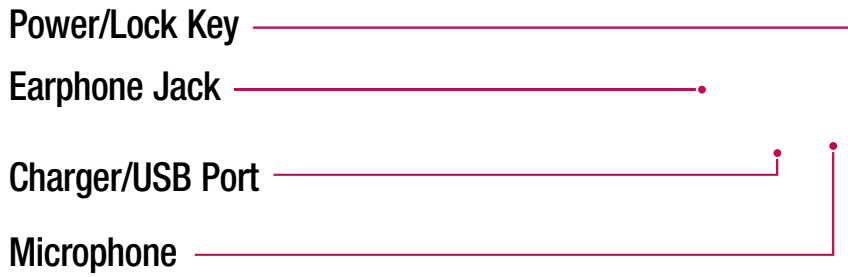

Volume Keys

- In the Home screen: Control ringer volume.
- During a call: Control your earpiece volume.
- When playing a song: Control volume continuously.

TIP! Press and hold the Volume Up and Volume Down Keys for one second to use the **QuickMemo** function.

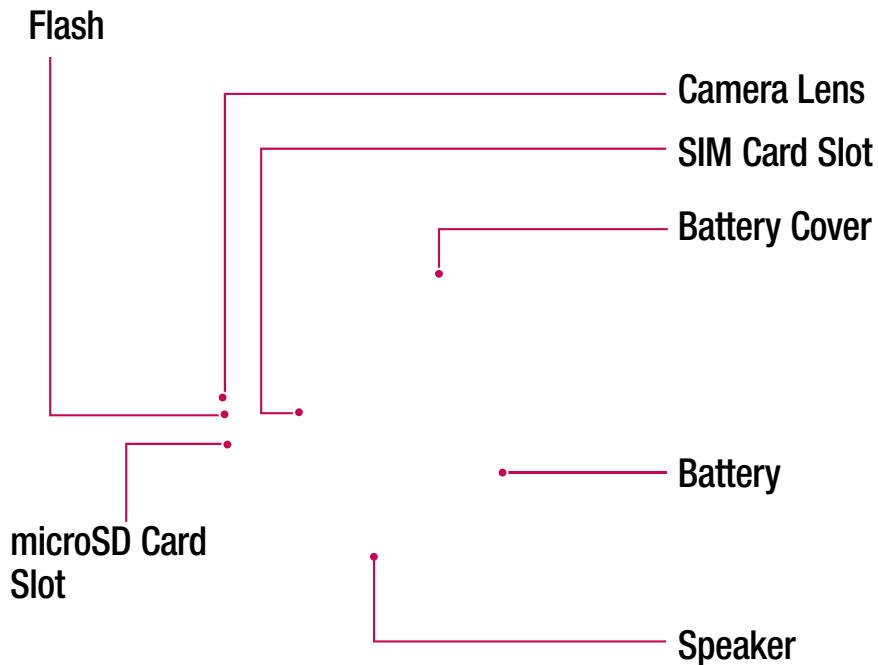

Installing the SIM card and battery

Before you can start exploring your new phone, you'll need to set it up. To insert the SIM card and battery:

- 1 To remove the battery cover, hold the phone firmly in one hand. With your other hand, lift off the battery cover with your thumbnail as shown in figure.
- 2 Slide the SIM card into the SIM card slot. Make sure the gold contact area on the card is facing downwards.
- 3 Insert the battery into place by aligning the gold contacts on the phone and the battery (1) and pressing it down until it clicks into place (2).
- 4 Align the battery cover over the battery compartment (1) and press it down until it clicks into place (2).

Getting to know your phone

Charging your phone

The charger connector is at the bottom of the phone. Insert the charger and plug it into an electrical outlet.

To insert a memory card:

Insert the memory card into the slot. Make sure the gold contact area is facing downwards.

To safely remove the memory card:

Touch  > **Apps** tab > **Settings** > **Storage** and then **DEVICE** > **Unmount SD card** > **OK**.

NOTE: The battery must be fully charged initially to improve battery lifetime.

NOTE: Do not open the battery cover while your phone is charging.

Using the memory card

Your phone supports the use of microSD™ or microSDHC™ memory cards of up to 32 GB capacity. These memory cards are specifically designed for mobile phones and other ultra-small devices, and are ideal for storing media-rich files such as music, programs, videos, and photographs for use with your phone.

NOTE:

- Use only compatible memory cards with your phone. Using incompatible memory cards may damage the card and data stored on the card, as well as the phone.
- As the device uses FAT32, the maximum size for any given file is 4 GB.

WARNING

Do not insert or remove the memory card when the phone is on. Doing so may damage the memory card as well as your phone, and the data stored on the memory card may become corrupt.

To format the memory card:

Your memory card may already be formatted. If it isn't, you must format it before you can use it.

NOTE: All files on your memory card are deleted when it is formatted.

- 1 Touch  to open the application list.
- 2 Scroll and touch **Settings** > **Storage** from the DEVICE tab.
- 3 Touch **Unmount SD card** and touch **OK** to confirm.
- 4 Touch **Erase SD card** > **Erase SD card** > **Erase everything**, and then confirm your choice.
- 5 If you have set a pattern lock, input the pattern lock then select **Erase everything**.

NOTE: If there is content on your memory card, the folder structure may be different after formatting, as all the files will have been deleted.

Locking and unlocking the screen

If you do not use the phone for a while, the screen is turned off and locked automatically. This helps to prevent accidental touches and saves battery power.

When you are not using the LG-E435f, press the **Power/Lock key**  to lock your phone.

If there are any programs running when you set lock screen, they may be still running in Lock mode. It is recommended that you exit all programs before entering Lock mode to avoid unnecessary charges (e.g. phone calls, web access and data communications).

To wake up your phone, press the **Power/Lock key** . The lock screen will appear. Touch and slide the lock screen in any direction to unlock your home screen. The last screen you viewed will open.

TIP! To wake up your phone, you can alternatively use the home key while the screen is turned off.

Getting to know your phone

Secure your lock screen

You can lock the touch screen by activating the screen lock feature. Your phone will require the unlock code each time you turn on the phone or unlock the touch screen.

- LG is not responsible for any loss of security codes or private information or other damage caused by illegal software.

Set a swipe unlock

- 1 On the Home screen, touch  to open the application list and select **Settings** > **Lock screen** > **Select screen lock** > **Swipe**.
- 2 Swipe the screen to unlock the screen.

Set an unlock pattern

- 1 On the Home screen, touch  to open the application list and select **Settings** > **Lock screen** > **Select screen lock** > **Pattern**.
- 2 See the on-screen instructions and example patterns and select **Next**.
- 3 Draw a pattern by dragging your finger to connect at least 4 dots.
- 4 Select **Continue**.
- 5 Draw a pattern again to confirm.
- 6 Select **Confirm**.

Set an unlock PIN code

- 1 On the Home screen, touch  to open the application list and select **Settings** > **Lock screen** > **Select screen lock** > **PIN**.
- 2 Enter a new PIN (numeric) and select **Continue**.
- 3 Enter the PIN again and select **OK**.

Set an unlock password

- 1 On the Home screen, touch  to open the application list and select **Settings** > **Lock screen** > **Select screen lock** > **Password**.
- 2 Enter a new password (alphanumeric) and select **Continue**.
- 3 Enter the password again and select **OK**.

NOTE:

Precautions to take when using pattern lock.

It is very important to remember the unlock pattern you set. You will not be able to access your phone if you use an incorrect pattern five times. You have five chances to enter your unlock pattern, PIN or password. If you have used all 5 opportunities, you can try again after 30 seconds.

When you cannot recall your unlock pattern:

If you logged in to your Google account on the phone but failed to enter the correct pattern 5 times, tap the **Forgot pattern** button (or, if you preset the backup PIN, you can use the backup PIN code to unlock the pattern). > page 20). You are then required to log in with your Google account to unlock your phone.

If you have not created a Google account on the phone or you forgot it, you have to perform a hard reset.

If you have forgotten your PIN or password: If you have forgotten your PIN or password, you need to perform a hard reset.

Your Home screen

Touch screen tips

Here are some tips on how to navigate around your phone.

Touch – To choose a menu/option or open an application, touch it.

Touch and hold – To open an options menu or grab an object you want to move, touch and hold it.

Drag – To scroll through a list or move slowly, drag across the touch screen.

Flick – To scroll through a list or move quickly, flick across the touch screen (drag quickly and release).

NOTE:

- To select an item, touch the centre of the icon.
- Do not press too hard; the touch screen is sensitive enough to pick up a light, firm touch.
- Use the tip of your finger to touch the option you want. Be careful not to touch any other keys.

Home screen

Simply swipe your finger to the left or right to view the panels. You can customise each panel with apps, downloads, widgets and wallpapers.

NOTE: Some screen images may vary depending on your phone provider.

On your Home screen, you can view quick keys at the bottom of the screen. Quick keys provide easy, one-touch access to the functions you use the most.

 Touch the **Phone** icon to bring up the touch screen dialpad to make a call.

 Touch the **Messaging** icon to access the messaging menu. This is where you can create a new message.

 Touch the **Contacts** icon to open your contacts.

 Touch the **Apps** icon at the bottom of the screen. You can then view all your installed applications. To open any application, simply touch the icon in the applications list.

Customising the Home screen

You can customise your Home screen by adding apps, downloads, widgets or wallpapers. For more convenience using your phone, add your favourite Application Shortcuts to the Home screen.

- 1 Home screen > .
- or
- Touch and hold the empty part of the Home screen go to the Edit mode screen.

- 2 The multiple panels of the Home screen and items in Apps, Downloads, Widgets or Wallpapers will be displayed on the Edit mode screen.
- 3 Scroll left or right to the panel that contains the item, and then tap and hold an item you want to move and drag the item to the desired location or panel.

To remove an item from the Home screen:

- **Home screen** > touch and hold the icon you want to remove > drag it to .

TIP! To add an application icon to the Home screen from the Applications menu, touch and hold the application you want to add.

Add or remove panels to the Home screen

You can add or remove panels of the Home screen to organise widgets according to your preferences and needs.

- 1 Place two fingers on the screen and pinch to switch to Edit mode. Then you can add, remove or change the order of the panels.

Returning to recently-used applications

- 1 Touch and hold the **Home** key. The screen displays a pop-up with icons of applications you used recently.
- 2 Touch an icon to open the application. Or touch the **Back** key to return to your current application.

Notification drawer

The notification drawer runs across the top of your screen.

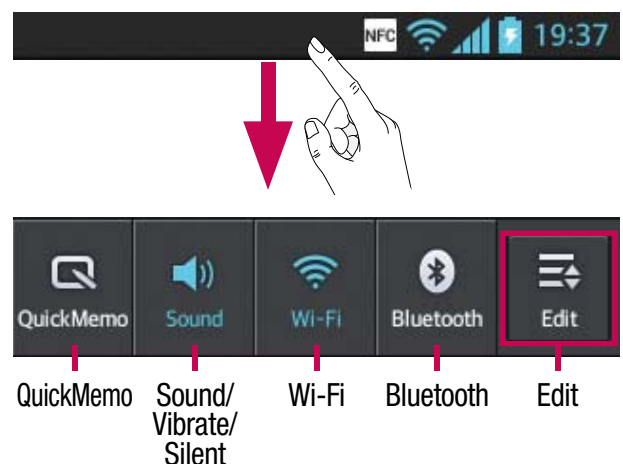

To customise the notification panel

You can customise the notification panel to match your preferences.

To rearrange items on the notification panel

Touch . Then, you can check and rearrange items on the notification panel.



Your Home screen

To view further notification settings

Touch  > .

You can add and remove the items on the notification panel like Sound profile, Wi-Fi, Bluetooth, Airplane mode, and so on.

Touch and slide the notification drawer down with your finger.





Touch  >  to manage the Notifications. Here you can check and manage Sound, Wi-Fi, Bluetooth, Airplane mode, Accounts & sync, Auto-rotate screen, Brightness, Data enabled, GPS, Portable Wi-Fi Hotspot, and so on.

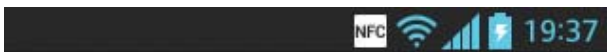

Viewing the status bar

The status bar uses different icons to display phone information such as signal strength, new messages, battery life, and active Bluetooth and data connections.



Below is a table explaining the meaning of icons you're likely to see in the status bar.

Icon	Description
	No SIM card
	No signal
	Flight mode
	Connected to a Wi-Fi network

Icon	Description
	Power saver is on
	Wired headset
	Call in progress
	Call on hold
	Speakerphone
	Phone microphone is muted
	Missed call
	Bluetooth is on
	System warning
	Alarm is set
	New voicemail
	Ringer is silenced
	Vibrate mode
	Battery fully charged
	Battery is charging
	Phone is connected to PC via USB cable

Icon	Description
	Downloading data
	Uploading data
	GPS is acquiring
	Receiving location data from GPS
	Data is syncing
	New Gmail
	New Google Talk message
	New message
	Song is playing
	FM radio turned on in the background
	USB tethering is active
	Portable Wi-Fi hotspot is active
	Both USB tethering and portable hotspot are active

NOTE: Icons shown on the display may vary depending on your region or service provider.

Onscreen keyboard

You can enter text using the onscreen keyboard. The on-screen keyboard appears automatically on the screen when you need to enter text. To manually display the keyboard, simply touch a text field where you want to enter text.

Using the keypad & entering text

 Tap once to capitalise the next letter you type. Double-tap or touch and hold for all caps.

 Tap to switch to the numbers and symbols keyboard. You can also touch and hold this tab to view the Settings menu.

 Tap to enter a space.

 Tap to create a new line in the message field.

 Tap to delete the previous character.

Entering accented letters

When you select French or Spanish as the text entry language, you can enter special French or Spanish characters (e.g. 'á').

For example, to input 'á', touch and hold the 'a' key until the zoom-in key grows bigger and displays characters from different languages. Then select the special character you want.

Google account set up

When you first turn on your phone, you have the opportunity to activate the network, to sign into your Google Account and to decide how you want to use some Google services.

To set up your Google account:

- Sign into a Google Account from the prompted set up screen.

OR

- Touch  > **Apps** tab > select a Google application (such as **Gmail**) > select **New** to create a new account.

If you have a Google account, touch **Existing**, enter your email address and password, then touch **Sign in**.

Once you have set up your Google account on your phone, your phone automatically synchronises with your Google account on the web.

Your phone is synchronised with your contacts, Gmail messages, Calendar events and other information from these applications and services on the web. (This depends on your synchronisation settings.)

After signing in, you can use Gmail™ and take advantage of Google services on your phone.

Connecting to Networks and Devices

Wi-Fi

With Wi-Fi, you can use high-speed Internet access within the coverage of the wireless access point (AP). Enjoy wireless Internet using Wi-Fi, without extra charges.

Connecting to Wi-Fi networks

To use Wi-Fi on your phone, you need to access a wireless access point or 'hotspot'. Some access points are open and you can simply connect to them. Others are hidden or use security features; you must configure your phone to be able to connect to them. Turn off Wi-Fi when you're not using it to extend the life of your battery.

NOTE: If you are out of the Wi-Fi zone or have set Wi-Fi to **OFF**, additional charges may be applied by your mobile operator for mobile data use.

Turning Wi-Fi on and connecting to a Wi-Fi network

- 1 Touch  > **Apps** tab > **Settings** > **Wi-Fi** from the WIRELESS & NETWORKS tab.
- 2 Set **Wi-Fi** to **ON** to turn it on and start scanning for available Wi-Fi networks.
- 3 Tap the Wi-Fi menu again to see a list of active and in-range Wi-Fi networks.
 - Secured networks are indicated by a lock icon.

- 4 Touch a network to connect to it.
 - If the network is open, you are asked to confirm that you want to connect to that network by touching **Connect**.
 - If the network is secured, you are prompted to enter a password or other credentials. (Ask your network administrator for details)
- 5 The status bar displays icons that indicate Wi-Fi status.

Bluetooth

You can use Bluetooth to send data by running a corresponding application, not from the Bluetooth menu as on most other mobile phones.

NOTE:

- LG is not responsible for the loss, interception or misuse of data sent or received via the Bluetooth wireless feature.
- Always ensure that you share and receive data with devices that are trusted and properly secured. If there are obstacles between the devices, the operating distance may be reduced.

Connecting to Networks and Devices

- Some devices, especially those that are not tested or approved by Bluetooth SIG, may be incompatible with your device.

Turning on Bluetooth and pairing up your phone with a Bluetooth device

You must pair up your device with another device before you connect to it.

- 1 Touch  > **Apps** tab > **Settings** > Set **Bluetooth** to **ON** from the WIRELESS & NETWORKS tab.
- 2 Tap the **Bluetooth** menu again. Your phone will scan for and display the IDs of all available Bluetooth devices that are in range. If the device you want to pair with isn't on the list, make sure the target device is set to be discoverable, then tap **Search for devices** again.
- 3 Choose the device you want to pair up with from the list.

Once the pairing is successful, your device will connect to the device.

NOTE: Some devices, especially headsets or hands-free car kits, may have a fixed Bluetooth PIN, such as 0000. If the other device has a PIN, you must enter it.

Send data using the Bluetooth wireless feature

- 1 Select a file or item, such as a contact, calendar event, or media file, from an appropriate application or **Downloads**.
- 2 Select an option for sending data via Bluetooth.

NOTE: The method for selecting an option may vary by data type.

- 3 Search for and pair with a Bluetooth-enabled device.

Receive data using the Bluetooth wireless feature

- 1 Touch  > **Apps** tab > **Settings** > Set **Bluetooth** to ON  and touch **Make phone visible** to be visible on other devices.

NOTE: To select the length of time that your device will be visible, touch  > **Visibility timeout**.

- 2 Select **Pair** to confirm that you are willing to receive data from the device.

Sharing your phone's data connection

USB tethering and portable Wi-Fi hotspot are great features when there are no wireless connections available. You can share your phone's mobile data connection with a single computer via a USB cable (USB tethering). You can also share your phone's data connection with more than one device at a time by turning your phone into a portable Wi-Fi hotspot.

When your phone is sharing its data connection, an icon appears in the status bar and as an ongoing notification in the notifications drawer.

For the latest information about tethering and portable hotspots, including supported operating systems and other details, visit <http://www.android.com/tether>.

To change Portable Wi-Fi hotspot settings:

- Touch  > **Apps** tab > **Settings** > **More** from the WIRELESS & NETWORKS tab > **Portable Wi-Fi hotspot** > Choose options that you want to adjust.

TIP! If your computer is running Windows 7 or a recent distribution of some flavours of Linux (such as Ubuntu), you don't usually need to prepare your computer for tethering. But if you're running an earlier version of Windows or another operating system, you may need to prepare your computer to establish a network connection via USB. For the most current information about which operating systems support USB tethering and how to configure them, visit <http://www.android.com/tether>.

To rename or secure your portable hotspot

You can change the name of your phone's Wi-Fi network name (SSID) and secure its Wi-Fi network.

- 1 On the Home screen, touch  > **Apps** tab > **Settings**.
- 2 Touch **More** from the WIRELESS & NETWORKS tab and select **Portable Wi-Fi hotspot**.
- 3 Ensure **Portable Wi-Fi hotspot** is ticked.
- 4 Touch **Configure Wi-Fi hotspot**.
 - The **Configure Wi-Fi hotspot** dialogue box will open.
 - You can change the network SSID (name) that other computers see when scanning for Wi-Fi networks.

Connecting to Networks and Devices

- You can also touch the **Security** menu to configure the network with Wi-Fi Protected Access 2 (WPA2) security using a pre-shared key (PSK).
- If you touch the **WPA2 PSK** security option, a password field is added to the **Configure Wi-Fi hotspot** dialogue box. If you enter a password, you will need to enter that password when you connect to the phone's hotspot with a computer or other device. You can set **Open** in the **Security** menu to remove security from your Wi-Fi network.

5 Touch **Save**.

ATTENTION!

If you set the security option as Open, you cannot prevent unauthorised usage of online services by other people and additional charges can be incurred. To avoid unauthorised usage, you are advised to keep the security option active.

Connecting to Networks and Devices

PC connections with a PC data cable

Learn to connect your device to a PC with a PC data cable in USB connection modes. By connecting the device to a PC you can transfer data to and from your device directly and use the PC software (LG PC Suite).

Sync your phone with your computer

To synchronise your phone with your PC using the USB cable, you need to install the PC software (LG PC Suite) on your PC.

Download the program from the LG website (www.lg.com).

- 1 Use the USB data cable to connect your phone to the PC. The USB connection type list will appear; select LG software.
- 2 Run the LG PC Suite program on your PC. Refer to the PC software (LG PC Suite) help for more information.

NOTE: The LG integrated USB driver is required to connect an LG device to a PC. It is installed automatically when you install the LG PC Suite software.

Transferring music, photos and videos using USB mass storage mode

- 1 Connect the LG-E435f to a PC using a USB cable.
- 2 If you haven't installed LG Android Platform Driver on your PC, you need to change the settings manually. Choose **System settings > Connectivity > USB Connection type**, then select **Media sync (MTP)**.
- 3 You can view the mass storage content on your PC and transfer the files.

NOTE: If you installed LG Android Platform Driver, you will immediately see a pop-up saying Turn on USB storage.

Synchronise with Windows Media Player

Ensure that Windows Media Player is installed on your PC.





- 1 Use the USB cable to connect the phone to a PC on which Windows Media Player is installed.
 - 2 Select the **Media sync (MTP)** option. When connected, a popup window will appear on the PC.
 - 3 Open Windows Media Player to synchronise music files.
 - 4 Edit or enter your device's name in the popup window (if necessary).
 - 5 Select and drag the music files you want to the sync list.
 - 6 Start synchronisation.
- The following requirements must be satisfied to synchronise with Windows Media Player.

Items	Requirement
OS	Microsoft Windows XP SP2, Vista or higher
Window Media Player version	Windows Media Player 10 or higher

- If the Windows Media Player version is lower than 10, install version 10 or higher.

Calls

Making a call

- 1 Touch  to open the keypad.
- 2 Enter the number using the keypad. To delete a digit, touch the .
- 3 Touch  to make a call.
- 4 To end a call, touch the **End** icon .

TIP! To enter '+' to make international calls, touch and hold .

Calling your contacts

- 1 Touch  to open your contacts.
- 2 Scroll through the contact list or enter the first few letters of the contact you want to call by touching **Search contacts**.
- 3 In the list, touch the contact you want to call.

Answering and rejecting a call

When you receive a call in Lock state, hold and slide the  to answer the incoming call.

Hold and slide the  to decline an incoming call.

Hold and slide the **Quick msg** icon at the bottom if you want to send a quick message.





TIP! Quick msg

You can send a message quickly using this function. This is useful if you need to reply the message during a meeting.

Adjusting call volume

To adjust the in-call volume during a call, use the volume up and down keys on the left-hand side of the phone.

Making a second call

- 1 During your first call, touch **Menu** > **Add call** and dial the number. You can also see a list of recently dialed numbers by touching , or you can search your contacts by touching  and select the number you want to call.
- 2 Touch  to make the call.
- 3 Both calls are displayed on the call screen. Your initial call is locked and put on hold.
- 4 Touch the displayed number to toggle between calls. Or touch  **Merge call** to make a conference call.
- 5 To end active calls, touch **End** or press the **Home** Key and slide the notification bar down and select the **End call** icon .

NOTE: You are charged for each call you make.

Viewing your call logs

On the Home screen, touch  and choose the **Call logs** tab .

View a complete list of all dialled, received and missed voice calls.

TIP! Touch any call log entry to view the date, time and duration of the call.

TIP! Touch the **Menu** key, and then touch **Delete all** to delete all the recorded items.

Call settings

You can configure phone call settings such as call forwarding and other special features offered by your carrier.

- 1 On the Home screen, touch .
- 2 Touch the **Menu** key.
- 3 Tap **Call settings** and choose the options that you want to adjust.

Fixed dialling numbers – To turn on and compile a list of numbers that can be called from your phone. You'll need your PIN2, which is available from your operator. Only numbers on the fixed dial list can be called

from your phone.

Voicemail service – Allows you to select your carrier's voicemail service.

Voicemail settings – If you are using your carrier's voicemail service, this option allows you to enter the phone number to use for listening to and managing your voicemail.

Save unknown numbers – Add unknown numbers to contacts after a call.

Call reject – Allows you to set the call reject function. Choose from **Disabled**, **Reject calls on list** or **Reject all calls**.

Quick messages – When you want to reject a call, you can send a quick message using this function. This is useful if you need to reject a call during a meeting.

Call forwarding – Choose whether to divert all calls when the line is busy, when there is no answer or when you have no signal.

Call barring – Select when you would like calls to be barred. Enter the call barring password. Please check with your network operator about this service.

Call duration – View the duration of calls, including all calls, dialled calls, received calls and last call.

Call costs – View the charges applied to your calls. (This service is network dependent; some operators do not support this function.)

Calls

Additional settings – This lets you change the following settings:

Caller ID: Choose whether to display your number on an outgoing call.

Call waiting: If call waiting is activated, the handset will notify you of an incoming call while you are on the phone (depending on your network provider).

Contacts



Add contacts to your phone and synchronise them with the contacts in your Google account or other accounts that support contact syncing.

Searching for a contact



In the Home screen

- 1 Touch  to open your contacts.
- 2 Touch **Search contacts** and enter the contact name using the keyboard.

Adding a new contact

- 1 Touch  to open your contacts.
- 2 Select .
- 3 Select a memory location. If you have more than one account, select an account to which you want to add the contact, such as **Phone** or **Google**.
- 4 Touch a contact information category and enter your contact's details.
- 5 Touch **Save** to add the contact to memory.

You can also create a contact from the dialling screen.

- 1 Touch  >  to open the dial screen.
- 2 Enter a phone number.
- 3 Select **Add to Contacts** > **Create new contact**.
- 4 Select a memory location. If you have more than one account, select an account to which you want to add the contact,

such as **Phone** or **Google**.

- 5 Enter the contact information.
- 6 Touch a contact information category and enter your contact's details.
- 7 Touch **Save** to add the contact to memory.

Favourite contacts

You can classify frequently called contacts as favourites.

Adding a contact to your favourites

- 1 Touch  to open your contacts.
- 2 Touch a contact to view their details.
- 3 Touch the star to the right of the contact's name. The star turns yellow.

Removing a contact from your favourites list

- 1 Touch  to open your contacts.
- 2 Touch the **Favourites** tab, and choose a contact to view its details.
- 3 Touch the yellow star to the right of the contact's name. The star will turn grey and the contact will be removed from favourites.

Import or export contacts

To import/export contact files (in vcf format) between a storage memory (internal storage/memory card) or SIM or USIM card and your device.

Contacts

- 1 Touch  to open your contacts.
- 2 Touch the **Menu** key > **Import/Export**.
- 3 Select a desired import/export option. If you have more than one account, select an account to which you want to add the contact.
- 4 Select contact files to import/export and select **Import** to confirm.
- 7 Click the [OK] button to import a new contact from the PC to the device.

Moving contacts from your old device to your new device



Export your contacts as a CSV file from your old phone to your PC, using a PC sync programme.

- 1 First install LG PC Suite on the PC. Run the programme, and connect your Android mobile phone to the PC using a USB cable.
- 2 From the top of the screen, select **Device** > **Import personal information** > **Import contacts**.
- 3 A pop-up to open a contacts file will appear.
- 4 Select a contacts file and click **Open**.
- 5 A pop-up to import a new contact from the PC to the contacts in the device will appear.
- 6 If the contacts in the device and new contacts from the PC are different, select a contact you want to import from the PC.

Messaging

Your LG-E435f combines SMS and MMS into one intuitive, easy-to-use menu.

Sending a message

- 1 Touch  on the home screen, and touch  to open a blank message.
- 2 Enter a contact name or contact number in the **To** field. As you enter the contact name, matching contacts will appear. You can touch a suggested recipient. You can add multiple contacts.

NOTE: You will be charged for a text message for every person you send the message to.

- 3 Touch the **Enter message** field and start to compose your message.
- 4 Touch the **Menu** key to open the Options menu. Choose from **Add subject**, **Discard**, **Attach**, **Insert smiley** or **All messages**.
- 5 Touch **Send** to send your message.
- 6 The message screen opens, with your message after Recipient Name/Number. Responses will appear on the screen. As you view and send additional messages, a message thread will be created.

 **WARNING:** The 160-character limit may vary from country to country depending on the language and how the SMS is coded.

 **WARNING:** If an image, video or audio file is added to an SMS message, it is automatically converted into an MMS message and you are charged accordingly.

Threaded box

Messages (SMS, MMS) exchanged with another party can be displayed in chronological order so that you can conveniently see an overview of your conversation.

Using emoticons

Liven up your messages using emoticons. When writing a new message, touch the **Menu** key, then choose **Insert smiley**.

Changing your message settings

Your LG-E435f message settings are predefined, so you can send messages immediately. You can change the settings based on your preferences.

Touch  on the home screen, and touch the **Menu** key, then tap **Settings**.

E-mail

You can use the Email application to read emails from services other than Google Mail. The email application supports the following account types: POP3, IMAP and Exchange. Your service provider or system administrator can provide the account settings you need.

Managing an email account

The first time you open the **E-mail** application, a setup wizard opens to help you to set up an email account.

To add another email account:

- Touch  > **Apps** tab > **E-mail** > in the account screen, touch  > **Settings** > **ADD ACCOUNT**

After the initial setup, Email displays the contents of your inbox. If you have added more than one account, you can switch among accounts.

To change the settings of an email account:

- Touch  > **Apps** tab > **E-mail** > in the account screen, touch  > **Settings**

To delete an email account:

- Touch  > **Apps** tab > **E-mail** > in the account screen, touch  > **Settings** > touch an account you want to delete > **Remove account**

Email account screen

You can touch an account to view its Inbox. The account from which you send email by default is indicated with a tick.

 – Touch the folder icon to open the account folders.



Only the most recent emails in your account are downloaded to your phone.

Working with account folders

Each account has an Inbox, Outbox, Sent and Drafts folder. Depending on the features supported by your account's service provider, you may have additional folders.

Composing and sending email

To compose and send a message

- 1 While in the **E-mail** application, touch the .
- 2 Enter an address for the message's intended recipient. As you enter text, matching addresses are offered from your Contacts. Separate multiple addresses with semicolons.
- 3 Add Cc/Bcc and add attachment files if required.
- 4 Enter the text of the message.
- 5 Touch the .
If you aren't connected to a network, for example, if you're working in airplane mode, the messages that you send

are stored in your Outbox folder until you're connected to a network again. If it contains any pending messages, the Outbox will be displayed on the Accounts screen.

TIP! When a new email arrives in the inbox, you will receive a notification by sound or vibration. Tap the email notification to stop notifications.

Camera

Getting to know the viewfinder

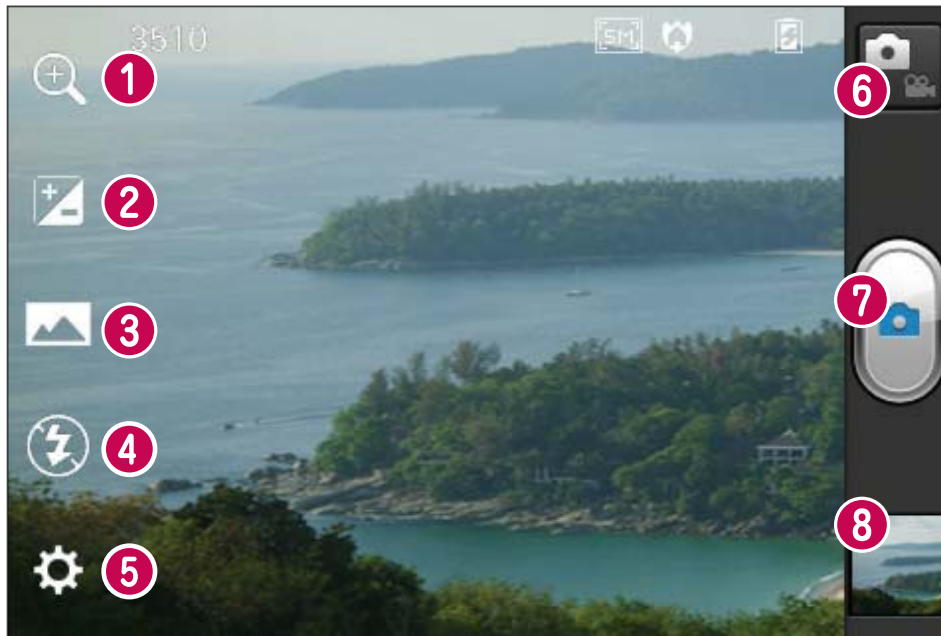

- 1 **Zoom** – Zoom in or zoom out.
- 2 **Brightness** – This defines and controls the amount of sunlight entering the image.
- 3 **Shot mode** – Choose from **Normal**, **Panorama** or **Continuous shot**.
- 4 **Flash** – Allows you to turn on the flash when taking a photo in a dark place.
- 5 **Settings** – Touch this icon to open the Settings menu.
- 6 **Video mode** – Touch this icon to switch to video mode.
- 7 **Capture** – Takes a photo.
- 8 **Gallery** – Touch to view the last photo you captured. This enables you to access your gallery and view saved photos within camera mode.

NOTE: The memory capacity may differ depending on the shooting scene or shooting conditions.

Taking a quick photo

- 1 Open the **Camera** application.
- 2 Hold the phone, point the lens towards the subject you want to photograph.
- 3 Touch your finger on the subject from the screen and a focus box will appear on touched area.
- 4 When the focus box turns green, the camera has focused on your subject.
- 5 Touch the **Capture** icon  to take the picture. Alternatively you can use the side volume keys.

Using the advanced settings



In the viewfinder, touch  to open all advanced options.

-  - Restore all camera default settings.
-  - Touch whenever you want to see camera help guide for **Panorama**, or **Continuous shot**.
-  - Focuses on the specific spot.
-  - Select the image resolution. If you choose high resolution, the file size will increase, which means you will be able to store fewer photos in the memory.
-  - Finds the colour and light settings appropriate for the current environment. Choose from Normal, Portrait, Landscape, Sports, Sunset and Night.
-  - The ISO rating determines the

sensitivity of the camera's light sensor. The higher the ISO, the more sensitive the camera is. This is useful in darker conditions when you cannot use the flash.

-  - Improves colour qualities in different lighting conditions.
-  - Choose a colour tone to use for your new view.
-  - Takes pictures a few seconds after clicking the shutter. This option is ideal if you want to be in the picture.
-  - Activate to use your phone's location-based services. Take pictures wherever you are and tag them with the location. If you upload tagged pictures to a blog that supports geotagging, you can see the pictures displayed on a map.

NOTE: This function is only available when GPS is active.

-  - Select one of the four shutter sounds.
-  - Allows you to review images after taking pictures.
-  - Select storage to save images.

TIP! When you exit camera mode, some settings return to their defaults, such as white balance, timer and scene mode. Check these before you take your next photo.

Camera

TIP! The Settings menu is superimposed over the viewfinder so, when you change elements of the image colour or quality, you see a preview of the image change behind the Settings menu.

After taking photos, select the image viewer icon to view the photos you have taken.

- To view more photos, scroll left or right.
- To zoom in or out, place two fingers on the screen and spread them apart (move your fingers closer together to zoom out) or double-tap the screen.
- To send a photo to others, touch **Share** via  > desired item like Bluetooth, E-mail, Memo, Picasa and so on.
- To delete a photo, touch **Delete** .

View a photo

Learn to view photos saved in your phone's storage.

- 1 On the Home screen, open the application list and select **Gallery**.
- 2 Select a photo to view.

While viewing a photo, use the following options:

- To view more photos, scroll left or right.
- To zoom in or out, tap the screen with two fingers and spread them apart (move your

fingers closer together to zoom out).

- To send a photo to others, touch **Share** via  > desired item like Bluetooth, Email, Memo, Picasa and so on.

TIP! If you have an SNS account and set it up on your phone, you can share your photo with the SNS community.

- To delete a photo, touch **Delete** .

Touch the Menu key to open all advanced options.

Set image as – Touch to use the image as a **Contact photo, Lockscreen Wallpaper** or **Wallpaper**.

Move – Touch to move the image to a different place.

Rename – Touch to edit the name of the selected picture.

Rotate left/Rotate right – Rotate left or right.

Crop – crop your photo. Move your finger across the screen to select an area.

Edit – View and edit the picture.

 - Select the image resolution. If you choose high resolution, the file size will increase, which means you will be able to store fewer photos in the memory.

 - Improves colour qualities in different lighting conditions.

 - Applies artistic effects to the pictures.

 - Applies the additional options for pictures.

Slideshow – Auto review automatically shows you the picture you just recorded.

Details – Show the picture information.

NOTE: Some file formats are not supported, depending on the device software.

NOTE: If the file size exceeds the available memory, an error can occur when you open files.

Video camera

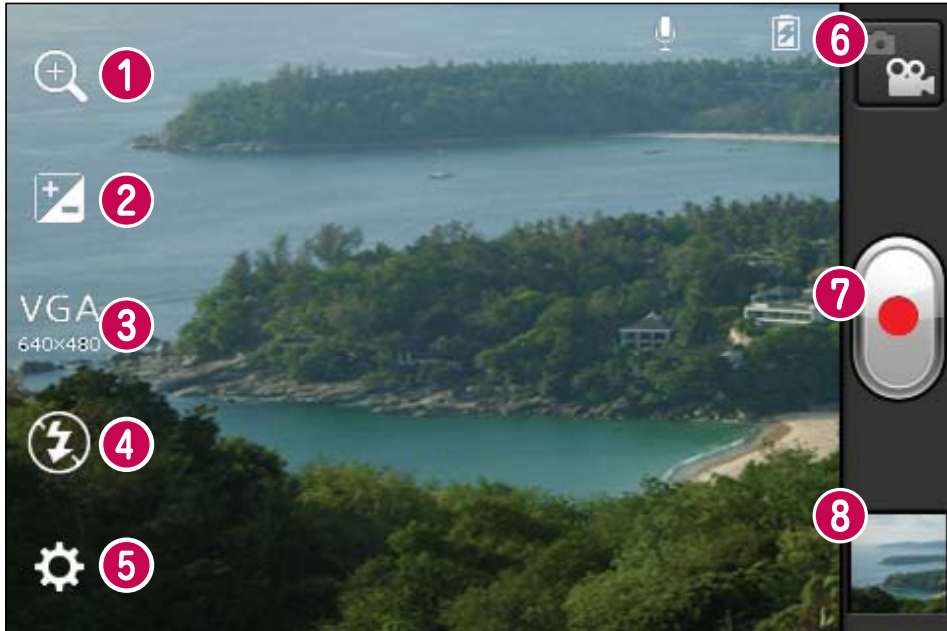

Getting to know the viewfinder



- ① **Zoom** – Zoom in or zoom out.
- ② **Brightness** – This defines and controls the amount of sunlight entering the video.
- ③ **Video size** – Touch to set the size (in pixels) of the video you are recording.
- ④ **Flash** – Allows you to turn on the flash when recording a video in dark conditions.
- ⑤ **Settings** – Touch this icon to open the settings menu.
- ⑥ **Camera mode** – Touch this icon to switch to camera mode.
- ⑦ **Record** – Starts recording.
- ⑧ **Gallery** – Touch to view the last video you recorded. This enables you to access your gallery and view your saved videos from within video mode.





NOTE: The zoom function is not available while recording a video.

Shooting a quick video



- 1 Press the **Camera** mode button down and the icon changes to .
- 2 The video camera viewfinder appears on the screen.
- 3 Holding the phone, point the lens towards the subject you want to capture in your video.
- 4 Press the Record  button once to start recording.
- 5 A red light appears at the top corner of the viewfinder with a timer showing the length of the video.
- 6 Touch  on the screen to stop recording. Alternatively you can use the side volume keys.

Using the advanced settings



Using the viewfinder, touch  to open all the advanced options.

-  - Restore all video camera default settings.
-  - Improves colour qualities in different lighting conditions.
-  - Apply a special effect, such as mono, sepia or negative tones.
-  - Activate to use your phone's location-based services. Records videos wherever you are and tag them with the location. If you upload

tagged videos to a blog that supports geotagging, you can see the videos displayed on a map.

-  - Choose Off to record a video without sound.
-  - Auto review automatically shows you the video you just recorded.
-  - Select storage to save videos.

After recording videos, select the image viewer icon to view the recorded videos.

- To view more videos, scroll left or right.
- To send a video to others, select **Share via** , a desired item like **Bluetooth**, **Messaging**, **YouTube** and so on.
- To play a video, select **Play** .
- To delete a video, select **Delete** .

Play a video

Learn to use the video player to play various kinds of videos.

- 1 On the Home screen, open the application list and select Gallery.
- 2 Select a video (with the  icon) to play.
- 3 Rotate the device to landscape view.
- 4 Control playback with the virtual keys.

Video camera

NOTE:

- Some file formats are not supported, depending on the device software.
- If the file size exceeds the available memory, an error can occur when you open files.

Touch the Menu key to open all advanced options.

Screen ratio – Tap to select desired screen ratio.

Brightness – Check for adjusting brightness level for comfortable video viewing.

Smart Share – Tap to share this video file through Smart Share.

Details – Tap to see a detailed information, such as the name, date, time, size and type.

Adjusting the volume when viewing a video

To adjust the volume of a video while it is playing, use the volume keys on the left-hand side of the phone.

Multimedia

You can store multimedia files on a memory card for easy access to all your image and video files.

Gallery

Learn to view photos and play videos saved in your device's memory and memory card.

1 Touch  > **Apps** tab > **Gallery**. Open a list of catalogue bars that store all your multimedia files.

- **Supported file formats (type format)**
 - **Image:** bmp, gif, jpg, png
 - **Video:** 3gp, mp4, avi, wmv, flv, mkv (Codec: MPEG4, H.263, Sorenson H.263, H.264, VC-1, DivX/XviD)
- Avoid locking the device's screen while playing a DivX Video-On-Demand. Each time you lock the screen while playing a DivX Video-On-Demand, your available rental counts will be decremented by one.
- Some file formats are not supported, depending on the device software.
- If the file size exceeds the available memory, an error can occur when you open files.

Multimedia

QuickMemo

Use **QuickMemo** to practically and efficiently create memos during a call, with a saved picture or on the current phone screen.

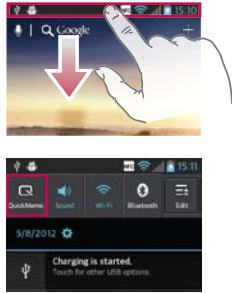



1 Enter the **QuickMemo** screen by pressing both the Volume Up and Volume Down Keys for one second on the screen you want to capture. Or touch and slide the Status Bar downwards and touch .

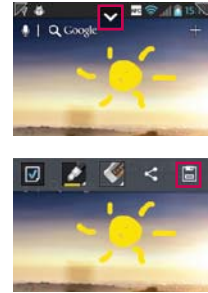

2 Select the desired menu option from **Pen type**, **Color**, **Eraser**, and create a memo.









3 Touch  in the Edit menu and select  to save the memo with the current screen.

NOTE: Please use a fingertip while using the QuickMemo function. Do not use your fingernail.

Using the QuickMemo options

While using the QuickMemo function, you can easily use the QuickMenu options.

-  - Select whether you want to use the background screen or not.
-  - Select the pen type and the colour.
-  - Erase the memo that you created.
-  - Set the location where you want to save the memo.
-  - Save the memo with the current screen.
-  - Send or share the current QuickMemo to/with others.

Viewing the saved QuickMemo

Touch **Gallery** and select the QuickMemo album.

Music player

Your phone has a built-in music player that lets you play all your favourite tracks. The music player supports the following file formats: mp3, m4a, mp4, 3gp, 3ga, asf/wma, ogg, aac, flac, wav.

Add music files to your phone



Start by transferring files to your phone or memory card:







- Transferring music, photos and videos using USB mass storage mode => page 32
- Download from the wireless web => page 57
- Sync your phone with your computer => page 32
- Receive via Bluetooth => page 27
- Copy to your memory card.

Play music

After transferring music files to your phone or memory card.



- 1 Touch  > **Apps** tab > **Music Player**.
- 2 Select a music category.
- 3 Select a music file. Refer to the following icons for playback control.

	Touch to pause playback.
	Touch to resume playback.
	Touch to skip to the next track in the album, playlist or shuffle.

	Touch to go back to the beginning of the song. Touch twice to return to the previous song.
	Touch to manage the music volume.
	Touch to set repeat mode.
	Touch to play the current playlist in shuffle mode.
	Touch to see the current playlist.
	Touch to see lyrics. This option is on only if the song includes the lyrics.

To change the volume while listening to music, press the up and down volume keys on the left-hand side of the phone.

Create a playlist

- 1 Touch  > **Apps** tab > **Music Player**.
- 2 Select **Playlists**.
- 3 Press  > **New playlist**.
- 4 Enter a title for your new playlist and select **OK**.
- 5 Select **Add music**.
- 6 Select the files you want to include and select **Add**.



TIP! During playback, you can add files to a playlist by pressing  > **Add to playlist**.

Multimedia

Add songs to the favourite playlist

You can add your favourite song quickly as a favourite playlist. During playback, press  > **Add to favourites** to add the current song to the quick list.

Customise music player settings

- 1 Touch  > **Apps** tab > **Music Player**.
- 2 Press  > **Settings**.
- 3 Adjust the settings to customise your music player:

NOTE:

- Some file formats are not supported, depending on the device software.
- If the file size exceeds the available memory, an error can occur when you open files.

NOTE: Music file copyrights may be protected by international treaties and national copyright laws.

Therefore, it may be necessary to obtain permission or a licence to reproduce or copy music.

In some countries, national laws prohibit private copying of copyrighted material. Before downloading or copying the file, check the national laws of the relevant country concerning the use of such material.

FM Radio

Your LG-E435f has a built-in FM radio so you can tune in to your favourite stations and listen on the go.

NOTE: You need to use your headphones to listen to the radio. Insert it into the headphone jack.

Searching for stations

You can tune in to radio stations by searching for them manually or automatically. They are then saved to specific channel numbers, so you don't have to find them again. You can store up to 48 channels on your phone.

Tuning in automatically

- 1 On the Home screen, touch  > **Apps** tab > **FM Radio**.
- 2 Touch , then select **Scan**.
- 3 During auto scanning, touch **Stop** if you want to stop scanning. Only scanned channels are saved before you stop scanning.

NOTE: You can also manually tune in to a station using the on-screen wheel.

TIP! To improve radio reception, extend the headset cord as this also functions as the radio antenna.
If you connect a headset not specifically made for radio reception, radio reception may be poor.

LG SmartWorld

LG SmartWorld offers an assortment of exciting content – games, applications, wallpaper and ringtones – giving LG phone users the chance to enjoy richer ‘Mobile Life’ experiences.

How to get to LG SmartWorld from your phone

- 1 Touch  > **Apps** tab > **LG SmartWorld**.
- 2 Tap Sign in and enter ID/PW for LG SmartWorld. If you have not yet signed up, tap Register and get an LG SmartWorld membership.
- 3 Download the content you want.

NOTE: What if there is no icon?

- 1 Using a mobile web browser, access LG SmartWorld (www.lgworld.com) and select your country.
- 2 Download LG SmartWorld App.
- 3 Execute and install the downloaded file.
- 4 Access LG SmartWorld by tapping the **LG SmartWorld** application.

How to use LG SmartWorld

- Participate in monthly LG SmartWorld promotions.
- Try the easy ‘Menu’ buttons to find what you're looking for fast.

Categories – Find content by category (e.g. Education, Entertainment, Games, etc.).

Search – Search content.

Apps for you – Recommended content based on your previous choices.

My Apps – List of downloaded/to-be-updated content.

Settings – Set profile and display.



Sign in – Set your ID and password.

- Try other useful functions as well. (Content Detail screen)



NOTE: LG SmartWorld may not be available from all carriers or in all countries.

Utilities

Setting your alarm

- 1 Touch  > **Apps** tab > **Alarm/Clock** > .
- 2 After you set the time, the LG-E435f lets you know how much time is left before the alarm will sound.
- 3 Set **Repeat**, **Snooze duration**, **Vibration**, **Alarm sound**, **Puzzle lock** and **Memo**. Touch **Save**.

Using your calculator

- 1 Touch  > **Apps** tab > **Calculator**
- 2 Touch the number keys to enter numbers.
- 3 For simple calculations, touch the function you want (+, -, x or ÷) followed by =.
- 4 For more complex calculations, touch , select the **Advanced panel**, then choose sin, cos, tan, log and so on.

Adding an event to your calendar

- 1 Touch  > **Apps** tab > **Calendar**
- 2 Tap the month displayed at left top corner; here you can find the different calendar views (Day, Week, Month, Agenda).
- 3 Tap the date for the event you want to add.

- 4 Tap  to add the event.
- 5 Touch **Event name**, then enter the event name.
- 6 Touch **Location** and enter the location. Check the date and enter the time you want your event to start and finish.
- 7 If you want to add a note to your event, touch **Description** and enter the details.
- 8 If you want to repeat the alarm, set **REPEAT**, and set **REMINDERS** if necessary.
- 9 Touch **Save** to save the event in the calendar.

Polaris Office

Polaris Office is a professional mobile office solution that lets users conveniently view various types of office documents, including Word, Excel and PowerPoint files, anywhere, anytime, using their mobile devices.

Touch  > **Apps** tab > **Polaris Office**

Managing files

Polaris Office provides mobile users with convenient file management features, including copying, moving and pasting, and deleting files and folders right on the device.

Viewing files

Mobile users can now easily view a wide variety of file types, including Microsoft Office and Adobe PDF documents, right

Utilities

on their mobile devices. When viewing documents using Polaris Office, the objects and layout remain the same as in the original documents.





The web

Internet

Internet gives you a fast, full-colour world of games, music, news, sport, entertainment and much more, right on your mobile phone. Wherever you are and whatever you enjoy.

NOTE: Additional charges apply when connecting to these services and downloading content. Check data charges with your network provider.

Using the web toolbar

-  Touch to go back a page.
-  Touch to go forward a page, to the page you connected to after the current one. This is the opposite of what happens when you press the **Back** key, which goes to the previous page.
-  Touch and hold, up and down to zoom in or out of browser.
-  Touch to add a new window.
-  Touch to open a list of saved bookmarks.

Using options

Press  to view options.

Refresh – Update the current web page.

Save to bookmarks – Add the current web page as a bookmark.

Go to Homepage – Allows you to go to the homepage.

Share page – Allows you to share the web page with others.

Find on page – Allows you to find letters or words on the current web page.

Request desktop site – Allows you to view the web page on the desktop.

Save for offline reading – Allows you to save current web page and read it on offline later.



Brightness – Allows you to adjust the brightness of the screen.

Settings – Displays Internet settings.

Exit – Allows you to exit from the browser.

Settings

Access the Settings menu

- 1 On the Home screen, touch  > **Apps** tab > **Settings**.
or
On the Home screen, touch  > **System settings**.
- 2 Select a setting category and select an option.

WIRELESS & NETWORKS

Here you can manage Wi-Fi and Bluetooth. You can also set up mobile networks and switch to airplane mode.

< Wi-Fi >

Wi-Fi – Turns on Wi-Fi to connect to available Wi-Fi networks.

Wi-Fi settings – Allows you to set up and manage wireless access points. Set network notification or add a Wi-Fi network. The advanced Wi-Fi settings screen is accessed from the Wi-Fi settings screen. Press the  and touch **Advanced**.

TIP! How to obtain the MAC address

To set up a connection in some wireless networks with MAC filters, you may need to enter the MAC address of your LG-E435f into the router.

You can find the MAC address in the following user interface: Touch **Apps** tab > **Settings** > **Wi-Fi** >  > **Advanced** > **MAC address**..

< Bluetooth >

Turns the Bluetooth wireless feature on or off. Refer to the Bluetooth information for more details => page 27

< Data usage >

Displays data usage and allows you to customise the settings for your data limit.

- **Mobile data:** Set to use data connections on any mobile network.
- **Set mobile data limit:** Set a limit for the mobile data usage.
- **Data usage cycle:** Customise the settings for the limit cycle.

< Call >

You can configure phone call settings such as call forwarding and other special features offered by your carrier.

- **Fixed dialling numbers** - Select Fixed Dialling Numbers to turn on this feature and compile a list of numbers that can

be called from your phone. You'll need your PIN2, which is available from your operator. Only numbers on the fixed dial list can be called from your phone.

VOICE MAIL

- **Voicemail service** - Allows you to select your carrier's voicemail service. You can obtain this number from your service provider.
- **Voicemail settings** - If you are using your carrier's voicemail service, this option allows you to enter the phone number to use for listening to and managing your voicemail.

END CALL SETTINGS

- **Save unknown numbers** - Add unknown numbers to contacts after a call.

OTHER CALL SETTINGS

- **Call reject** - Allows you to set the call reject function. Choose from **Disabled**, **Reject calls on list** or **Reject all calls**.
- **Quick messages** - When you want to reject a call, you can send a quick message using this function. This is useful if you need to reject a call during a meeting.
- **Call forwarding** - Choose whether to divert all calls when the line is busy, when there is no answer or when you have no signal.

- **Call barring** - Select when you would like calls to be barred. Enter the call barring password. Please check with your network operator about this service.
- **Call duration** - View the duration of calls including all calls, dialled calls, received calls and last call.
- **Call costs** - View the charges applied to your calls. (This service is network dependent; some operators do not support this function.)
- **Additional settings** - This lets you change the following settings:
 - **Caller ID** - Choose whether to display your number on an outgoing call.
 - **Call waiting** - If call waiting is activated the handset will notify you of an incoming call while you are on the phone (depending on your network provider).

< More ... >

- **Airplane mode** - After switching to airplane mode, all wireless connections are disabled.
- **Wi-Fi Direct** - Activate the Wi-Fi Direct feature to connect two devices via a WLAN without requiring an access point. Refer to the Wi-Fi information for more details => page 30

Settings

- **Portable Wi-Fi hotspot** - Activate the Portable WLAN hotspot feature to share your device's mobile network connection with PCs or other devices through the WLAN feature.
 - **Configure Wi-Fi hotspot:** Configure network settings for your WLAN hotspot.
 - **Timeout:** Set the time for the portable hotspot timeout.
 - **Help:** View information about using the tethering features.
- **Android Beam** - You can beam a web page, contact, email address, map position, link related with downloaded app. from your screen to another device by bringing the devices together (typically back to back).
- **VPN settings** - Displays the list of Virtual Private Networks (VPNs) that you've previously configured. Allows you to add different types of VPN.

NOTE: You must set a lock screen PIN or password before you can use credential storage.
- **Mobile networks** - Set options for data roaming, network mode & operators, access point names (APNs) and so on.
 - **Data enabled:** Set to enable data access over a mobile network.
 - **Data roaming:** Set the device to connect to another network when you

are roaming or your home network is not available.

- **Network mode:** Select a network type.
- **Access point names:** Set up access point names (APNs).
- **Use only 2G networks:** Select a network type.
- **Network operators:** Search for available networks and select a network for roaming.

DEVICE

< Sound >

- **Sound profile** - You can choose from **Sound**, **Vibrate only** or **Silent**.
- **Volumes** - You can manage the volume of music, video, games, other media, and ringtones & notifications. See 'Touch feedback & system'.

RINGTONE & NOTIFICATIONS

- **Phone ringtone** - Allows you to set your default incoming call ringtone.
- **Notification sound** - Allows you to set your default notification sound.
- **Ringtone with vibration** - Vibration feedback for calls and notifications.
- **Quiet time** - Set times to turn off all sounds except alarm and media.

TOUCH FEEDBACK & SYSTEM

- **Dial pad touch tones** - Allows you to set

the phone to play tones when using the dialpad to dial numbers.

- **Touch sounds** - Allows you to set your phone to play a sound when you touch buttons, icons and other onscreen items that react to your touch.
- **Screen lock sound** - Allows you to set your phone to play a sound when locking and unlocking the screen.

< Display >

- **Brightness** - Adjust the screen brightness.
- **Auto-rotate screen** - Set to switch orientation automatically when you rotate the phone.
- **Screen timeout** - Set the time for screen timeout.
- **Font size** - Change the display size.
- **Front key light** - Set the front key LED time.

< Home screen >

Home screen - Select a background image for the Home screen. You can set the Animation, Screen effect or Wallpaper.

< Lock screen >

Set how to unlock the screen.

- **Select screen lock** - Set an unlock pattern to secure your phone. This opens a set of screens that guide you through drawing a screen unlock pattern.

Settings

- **None:** Disable the screen lock.
- **Swipe:** Set to use the screen lock without a PIN, password, pattern, or face detection.
- **Pattern:** Set an unlock pattern to unlock the screen.
- **PIN:** Set a PIN (numeric) to unlock the screen.
- **Password:** Set to display your own message for the locked screen.

< Storage >

View memory information for your device and memory card. You can also format the USB storage and the memory card.

WARNING

Formatting a memory card will permanently delete all data from the memory card.

- **INTERNAL STORAGE** - View the internal storage usage.
- **SD CARD** - Check total available SD card space. Touch Unmount SD card for safe removal. Erase SD card if you want to delete all data from the SD card.

< Power Saver >

Here you can manage the battery and check the power saving items. You can also check the battery usage.

- **Turn Power saver on:** Activate power saving mode to limit some system resource usage.
- **Power saver tips:** Learn how to reduce battery consumption by using the power saving items.

POWER SAVING ITEMS

Set to activate power saving mode according to your custom settings.

BATTERY INFORMATION

View the amount of power consumed by your device.

< Apps >

You can view and manage the applications.

PERSONAL

< Accounts & sync >

Permits applications to synchronise data in the background, whether or not you are actively working in them. Deselecting this setting can save battery power and reduces (but does not eliminate) data usage.

< Location services >

Change the settings for GPS functionality.

- **Google's location service** - If you select Google's location service, your phone determines your approximate location using Wi-Fi and mobile networks. When you select this option, you're asked whether you consent to allowing Google

to use your location when providing these services.

- **GPS satellites** - If you select GPS satellites, your phone determines your location with street level accuracy.
- **Location & Google search** - Set the device to use your current location for Google search and other Google services.

< Security >

Change the settings for securing your device and the SIM or USIM card.

SIM CARD LOCK

- **Set up SIM card lock** - Set up SIM card lock or change the SIM PIN.
 - **Lock SIM card**: Activate or deactivate the PIN lock feature to require the PIN before using the device.
 - **Change SIM PIN**: Change the PIN used to access SIM or USIM data.

PASSWORDS

- **Make passwords visible** - Show password as you type.

DEVICE ADMINISTRATION

- **Device administrators** - View device administrators configured on your device. You can activate device administrators to apply new policies to your device.
- **Unknown sources** - View device administrators configured on your device. You can activate device administrators to apply new policies to your device.

CREDENTIAL STORAGE

- **Trusted credentials** - Select certificates and credentials to ensure secure use of various applications
- **Install from storage** - Install encrypted certificates that are stored in the USB storage device.
- **Clear credentials** - Erase the credential contents from the device and reset the password.

< Language & input >

Use the language & input settings to select the language for the text on your phone and for configuring the onscreen keyboard, including words you've added to its dictionary.

< Backup & reset >

Change the settings for managing your settings and data.

BACKUP & RESTORE

Change the settings for managing your settings and data.

- **Back up my data** - Set to back up your settings and application data to the Google server.
- **Backup account** - Add and view your Google account to back up your data.
- **Automatic restore** - Set to restore your settings and application data when the applications are reinstalled on your device.

Settings

PERSONAL DATA

- **Factory data reset** - Reset your settings to the factory default values and delete all your data. If you reset the phone in this way, you are prompted to re-enter the same information that you did when you first started Android.

NOTE: If you select factory data reset, it will erase all of your personal data from your phone's system memory, including information about your Google account, any other accounts, your system/application data and settings as well as any downloaded applications and DRM licences. Resetting the phone does not erase any system software updates you have downloaded or any files on your microSD card or internal memory, such as music or photos.

So, if you want to erase all the data in the internal memory while resetting the phone, select the 'Erase internal memory' checkbox.

SYSTEM

< Date & time >

Use Date & time settings to set how dates are displayed. You can also use these settings to set your own time and time zone rather than obtaining the current time from

the mobile network.

- **Automatic date & time:** Automatically update the time when you set a time zone.
- **Automatic time zone:** Automatically update the time when you move across time zones.
- **Set date:** Set the current date manually.
- **Set time:** Set the current time manually.
- **Select time zone:** Set your home time zone.
- **Use 24-hour format:** Set to the time to be displayed in 24-hour format.
- **Select date format:** Select a date format.

< Accessibility >

Use the Accessibility settings to configure accessibility plug-ins you have installed on your phone.

NOTE: Requires additional plug-ins.

SYSTEM

- **Large text:** Set the text size to large.
- **Power button ends call:** Set the device to end a call when you press the Power/Lock key.
- **Auto-rotate screen:** Set whether or not to rotate the content automatically when the device is rotated.
- **Touch & hold delay:** Set the recognition time for tapping and holding the screen.

- **Install web scripts:** Set applications to install web scripts to make their web content more accessible.

< Connectivity >

USB CONNECTION

- **USB connection type** - You can set the desired mode (**Charge only**, **Media sync (MTP)**, **USB tethering** or **LG software**).
- **Ask on connection** - Ask to confirm USB connection mode when connecting to a computer.
- **Help** - View information about using the USB connection type.

LG SOFTWARE

- **PC Suite Wi-Fi connection** - Tick this checkbox to use LG PC Suite with Wi-Fi connection. Please note that the Wi-Fi network should be connected for LG PC Suite via Wi-Fi connection from the **WIRELESS & NETWORKS** tab.

<Developer options>

Change the settings for application development.

- **USB debugging:** Select to connect your device to a PC using a USB cable. This is for application development.
- **Development device ID:** View your device's development ID.
- **Stay awake:** Screen will never sleep while charging.

- **Allow mock locations:** Allow mock locations and service information to be sent to a Location Manager service for testing. This is for application development.
- **Desktop backup password:** Set a password to secure your backup data.

USER INTERFACE

- **Strict mode enabled:** Set the device to flash the screen when applications perform long operations.
- **Pointer location:** Set to show the coordinates and traces of the pointer when you touch the screen.
- **Show touches:** Set to show the pointer when you touch the screen.
- **Show screen updates:** Set to flash areas of the screen when they are updated.
- **Show CPU usage:** Set to list all active processes.
- **Force GPU rendering:** Set to use 2D hardware acceleration to improve graphic performance.
- **Window animation scale:** Select a speed for opening and closing pop-up windows.
- **Transition animation scale:** Select a speed for switching between screens.

APPS

- **Don't keep activities:** Set to end a running application when you launch a new application.

Settings

- **Background process limit:** Set to limit the number of processes that can run in the background.
- **Show all ANRs:** Set the device to alert you to unresponsive applications that are running in the background.

< About phone >

View legal information and check phone status and software version.

Phone software update

LG Mobile phone software update from the Internet

For more information about using this function, please visit <http://update.lgmobile.com> or <http://www.lg.com/common/index.jsp> → select country and language.

This feature allows you to update the firmware on your phone to a newer version conveniently from the Internet without you needing to visit a service centre. This feature will only be available if and when LG makes a newer firmware version available for your device.

As the mobile phone firmware update requires the user's full attention for the duration of the update process, please make sure you check all instructions and notes that appear at each step before proceeding. Please note that removing the USB data cable or battery during the upgrade may seriously damage your mobile phone.

NOTE: LG reserves the right to make firmware updates available only for selected models at its own discretion and does not guarantee the availability of the newer version of the firmware for all handset models.

LG Mobile Phone software update via Over-the-Air (OTA)

This feature allows you to update your phone's software to a newer version conveniently via OTA, without connecting with a USB data cable. This feature will only be available if and when LG makes a newer firmware version available for your device.

First, you can check the software version on your mobile phone: **System settings > About phone > Software update > Check now for update.**

You can also delay the update by 1 hour, 4 hours, 8 hours or 1 day. In this case, the application will notify you to update when the time is up. You can also perform an update manually.

NOTE: This feature is dependent on your network service provider, region and country.

Phone software update

Trademarks

- Copyright 2012 LG Electronics, Inc. All rights reserved. LG and the LG logo are registered trademarks of LG Group and its related entities.
- Bluetooth® is a registered trademark of the Bluetooth SIG, Inc. worldwide.
- Wi-Fi®, the Wi-Fi CERTIFIED logo, and the Wi-Fi logo are registered trademarks of the Wi-Fi Alliance.
- All other trademarks and copyrights are the property of their respective owners.

DivX Mobile **DivX**

ABOUT DIVX VIDEO: DivX® is a digital video format created by DivX, LLC, a subsidiary of Rovi Corporation. This is an official DivX Certified® device that plays DivX video. Visit divx.com for more information and software tools to convert your files into DivX videos.

ABOUT DIVX VIDEO-ON-DEMAND: This DivX Certified® device must be registered in order to play purchased DivX Video-on-Demand (VOD) movies. To obtain your registration code, locate the DivX VOD section in your device setup menu. Go to vod.divx.com for more information on how to complete your registration.

DivX Certified® to play DivX® video up to 320x240.

DivX®, DivX Certified® and associated

logos are trademarks of Rovi Corporation or its subsidiaries and are used under licence.

Accessories

These accessories are available for use with the LG-E435f. (Items described below may be optional.)

Travel adaptor

Battery

Data cable

Connect your LG-E435f to a PC.

User Guide

Learn more about your LG-E435f.

Stereo headset

LG Tag + sticker

NOTE:

- Always use genuine LG accessories. Failure to do this may void your warranty.
- Accessories may vary in different regions.

Troubleshooting

This chapter lists some problems you might encounter while using your phone. Some problems require you to call your service provider, but most are easy to fix yourself.

Message	Possible causes	Possible corrective measures
SIM error	There is no SIM card in the phone, or it is inserted incorrectly.	Make sure the SIM card is correctly inserted.
No network connection / Losing network	Signal is weak or you're outside the carrier network. Operator applied new services.	Move towards a window or into an open area. Check the network operator coverage map. Check whether the SIM card is more than 6~12 months old. If so, change your SIM at your network provider's nearest branch. Contact your service provider.
Codes do not match	To change a security code, you will need to confirm the new code by re-entering it. The two codes you have entered do not match.	If you forget the code, contact your service provider.
An application cannot be set	Not supported by service provider or registration required.	Contact your service provider.
Calls not available	Dialling error New SIM card inserted. Pre-paid charge limit reached.	New network not authorised. Check for new restrictions. Contact service provider or reset limit with PIN2.
Phone cannot be switched on	On/Off key pressed too briefly. Battery is not charged. Battery contacts are dirty.	Hold the On/Off key down for at least two seconds. Charge battery. Check charging indicator on the display. Clean the battery contacts.

Message	Possible causes	Possible corrective measures
Charging error	Battery is not charged.	Charge battery.
	Outside temperature is too hot or cold.	Make sure the phone is charging at a normal temperature.
	Contact problem	Check the charger and connection to the phone. Check the battery contacts, and clean them if necessary.
	No voltage	Plug the charger into a different socket.
	Charger defective	Replace charger.
	Wrong charger	Only use original LG accessories.
	Battery defective	Replace battery.
Number not permitted	The Fixed dialling number function is on.	Check the Settings menu and turn the function off.
Impossible to send/receive SMS & picture	Memory full	Delete some messages from the phone.
Files not opening	Unsupported file format	Check the file formats that can be supported.
SD card not working	FAT16, FAT32 file system supported	Check SD card file system via card reader, or format SD card using the phone.
The screen does not come on when I receive a call.	Proximity sensor problem	If you use any protection tape or case, check to see if it has covered the area around the proximity sensor. Make sure the area around the proximity sensor is clean.
No sound	Vibration mode	Check the settings status of the sound menu to make sure you are not in vibrate or silent mode.
Hang up or freeze	Intermittent software problem	Remove the battery, reinsert it and switch on the phone. Try to perform a software update via the website.



FAQ

Please check to see if any problems you have encountered with your phone are described in this section before taking the phone in for service or calling a service representative.

Category Sub-Category	Question	Answer
BT Bluetooth Devices	What are the functions available via Bluetooth?	You can connect a Bluetooth audio device such as a Stereo/Mono headset or Car Kit and share pictures, videos, contacts, etc. via Gallery/Contacts menu. Also, when the FTP server is connected to a compatible device, you can share content stored in the storage media (internal memory or SD card).
BT Bluetooth Headset	If my Bluetooth headset is connected, can I listen to my music through my 3.5 mm wired headphones?	When a Bluetooth headset is connected, all system sounds are played over the headset. As a result, you will not be able to listen to music through your wired headphones.
Data Contacts Back up	How can I back up Contacts?	The Contacts data can be synchronized between your phone and Gmail™.
Data Synchronisation	Is it possible to set up one-way sync with Gmail?	Only two-way synchronisation is available.
Data Synchronisation	Is it possible to synchronise all the email folders?	The Inbox is automatically synchronised. You can view other folders by pressing the Menu Key  and touching Folders to choose a folder.

Category Sub-Category	Question	Answer
Google™ Service Gmail Log-In	Do I have to log into Gmail whenever I want to access Gmail?	Once you log into Gmail, you don't need to log into Gmail again.
Google Service Google Account	Is it possible to filter emails?	No, email filtering is not supported via the phone.
Phone Function Email	What happens when I execute another application while writing an email?	Your email will automatically be saved as a draft.
Phone Function Ringtone	Is there a file size limitation for when I want to use a .MP3 file as a ring tone?	There is no file size limitation.
Phone Function Message Time	My phone does not display the time of receipt for messages older than 24 hrs. How can I change this?	You will only be able to see the times for messages received the same day.
Phone Function microSD Card	What is the maximum supported size for a memory card?	32 GB memory cards are compatible.
Phone Function Navigation	Is it possible to install another navigation application on my phone?	Any application that is available on Android Market™ and is compatible with the hardware can be installed and used.

FAQ

Category Sub-Category	Question	Answer
Phone Function Synchronisation	Is it possible to synchronise my contacts from all my email accounts?	Only Gmail and MS Exchange server (company email server) contacts can be synchronised.
Phone Function Wait and Pause	Is it possible to save a contact with Wait and Pause in the numbers?	<p>If you transferred a contact with the W & P functions saved into the number, you will not be able to use those features. You will need to re-save each number.</p> <p>How to save with Wait and Pause:</p> <ol style="list-style-type: none">1. From the Home screen, press the Phone icon .2. Dial the number, then press the Menu Key .3. Touch Add 2-sec pause or Add wait.
Phone Function Security	What are the phone's security functions?	You are able to set the phone to require the entry of an Unlock Pattern before the phone can be accessed or used.



Category Sub-Category	Question	Answer
Phone Function Unlock Pattern	How do I create the Unlock Pattern?	<ol style="list-style-type: none"> 1. From the Home screen, press the Menu Key . 2. Touch System Settings > Lock screen. 3. Touch Select screen lock > Pattern. The first time you do this, a short tutorial about creating an Unlock Pattern appears. 4. Set up by drawing your pattern once, then again for confirmation. <p>Precautions to take when using pattern lock.</p> <p>It is very important to remember the unlock pattern you set. You will not be able to access your phone if you use an incorrect pattern five times. You have five chances to enter your unlock pattern, PIN or password. If you have used all 5 opportunities, you can try again after 30 seconds. (Or, if you preset the backup PIN, you can use the backup PIN code to unlock the pattern => page 20)</p>

FAQ

Category Sub-Category	Question	Answer
Phone Function Unlock Pattern	What should I do if I forget the unlock pattern and I didn't create the Google account on the phone?	<p>If you have forgotten your pattern:</p> <p>If you logged in to your Google account on the phone but failed to enter the correct pattern 5 times, touch the forgot pattern button. You are then required to log in with your Google account to unlock your phone. If you have not created a Google account on the phone or you forgot it, you have to perform a hard reset.</p> <p>Caution: If you perform a factory reset, all user applications and user data will be deleted. Please remember to back up any important data before performing a factory reset.</p> <p>How to perform a factory reset:</p> <ol style="list-style-type: none">1. When the phone is switched off, press and hold the Volume down key + Power key with your left hand.2. When the LED on the bottom of the phone lights up, release Volume down key + Power keys and press and hold the Home key (for about 2 seconds) at the same time.3. The phone will turn on and perform a factory reset immediately.

Category Sub-Category	Question	Answer
		<p>3. When the LG logo is displayed on the screen, continue to hold the keys for around two seconds, and then release all them at the same time, before the LG logo disappears.</p> <p>Do not operate your phone for at least a minute, while the hard reset is carried out. You will then be able to switch your phone back on.</p>
Phone Function Memory	Will I know when my memory is full?	Yes, you will receive a notification.
Phone Function Language Support	Is it possible to change the language?	<p>The phone has multilingual capabilities. To change the language:</p> <ol style="list-style-type: none"> 1. From the Home screen, press the Menu Key  and touch System Settings. 2. Touch Language & input > Select language. 3. Touch the desired language.
Phone Function VPN	How do I set up a VPN?	VPN access configuration is different according to each company. To configure VPN access from your phone, you must obtain the details from your company's network administrator.

FAQ

Category Sub-Category	Question	Answer
Phone Function Screen time out	My screen turns off after only 15 seconds. How can I change the amount of time for the backlight to turn off?	<ol style="list-style-type: none">1. From the Home screen, press the Menu Key .2. Touch System Settings > Display.3. Under Display settings, touch Screen timeout.4. Touch the preferred screen backlight timeout time.
Phone Function Wi-Fi & 3G	When Wi-Fi and 3G are both available, which service will my phone use?	<p>When using data, your phone may default to the Wi-Fi connection (if Wi-Fi connectivity on your phone is set to On). However, there will be no notification when your phone switches from one to the other.</p> <p>To know which data connection is being used, view the 3G or Wi-Fi icon at the top of your screen.</p>
Phone Function Home screen	Is it possible to remove an application from the Home screen?	Yes. Just touch and hold the icon until the dustbin icon appears at the Top-center of the screen. Then, without lifting your finger, drag the icon to the rubbish bin.
Phone Function Application	I downloaded an application and it causes a lot of errors. How do I remove it?	<ol style="list-style-type: none">1. From the Home screen, press the Menu Key .2. Touch App settings > Downloaded.3. Touch the application, then touch Uninstall.

Category Sub-Category	Question	Answer
Phone Function Charger	Is it possible to charge my phone by USB data cable without installing the necessary USB driver?	Yes, the phone will be charged by the USB cable irrespective of whether the necessary drivers are installed or not.
Phone Function Alarm	Can I use music files for my alarm?	Yes. After saving a music file as a ringtone, you can use it for your alarm. 1. Touch and hold a song in a library list. In the menu that opens, touch Set as ringtone . 2. In an alarm clock setting screen, select the song as a ringtone.
Phone Function Alarm	Will my alarm be audible or will it go off if the phone is turned off?	No, this is not supported.
Phone Function Alarm	If my ringer volume is set to Off or Vibrate, will I hear my Alarm?	Your Alarm is programmed to be audible even in these scenarios.
Recovery Solution Hard Reset (Factory Reset)	How can I perform a factory reset if I can't access the phone's setting menu?	If your phone does not restore to the original condition, use a hard reset (factory reset) to initialise it. =>page 11

