

# FCC RADIO TEST REPORT

according to

47 CFR FCC Part 15 Subpart C § 15.225

**Equipment** : **Mobile Phone**  
**Brand Name** : **LG**  
**Model No.** : **LG-D805, LG-D806**  
**Filing Type** : **New Application**  
**Applicant** : **LG Electronics Inc.**  
60-39, Kasan-dong, Kumchon-gu, Seoul 135-801, Korea  
**FCC ID** : **ZNFD805**  
**Manufacturer** : **LG Electronics Inc.**  
60-39, Kasan-dong, Kumchon-gu, Seoul 135-801, Korea  
**Received Date** : Jun. 28, 2013  
**Final Test Date** : Aug. 04, 2013

## Statement

The test result in this report refers exclusively to the presented test model / sample.

Without written approval of SPORTON International Inc., the test report shall not be reproduced except in full.

The measurements and test results shown in this test report were made in accordance with the procedures and found in compliance with the limit given in **ANSI C63.4-2003** and **47 CFR FCC Part 15 Subpart C**.

The test equipment used to perform the test is calibrated and traceable to NML/ROC.



**SPORTON INTERNATIONAL INC.**

**No. 52, Hwa Ya 1<sup>st</sup> Rd., Hwa Ya Technology Park, Kwei-Shan Hsiang, Tao Yuan Hsien, Taiwan, R.O.C.**

**SPORTON INTERNATIONAL INC.**

Report Format Version: a

**Table of Contents**

**1. SUMMARY OF THE TEST RESULT ..... 2**

**2. GENERAL INFORMATION..... 3**

2.1 Product Details ..... 3

2.2 Accessories ..... 3

2.3 Table for Test Modes ..... 4

2.4 Table for Testing Locations ..... 4

2.5 Table for Supporting Units ..... 4

2.6 Test Configurations ..... 5

**3. TEST RESULT ..... 6**

3.1 AC Power Line Conducted Emissions Measurement ..... 6

3.2 Field Strength of Fundamental Emissions and Mask Measurement ..... 11

3.3 20dB Spectrum Bandwidth Measurement ..... 15

3.4 Radiated Emissions Measurement ..... 17

3.5 Frequency Stability Measurement ..... 24

3.6 Antenna Requirements ..... 27

**4. LIST OF MEASURING EQUIPMENT ..... 28**

**5. TEST LOCATION..... 29**

**6. TAF CERTIFICATE OF ACCREDITATION ..... 30**

**APPENDIX A. SETUP PHOTOGRAPHS**

### REVISION HISTORY

REPORT NO.	VERSION	DESCRIPTION	ISSUED DATE
FR362801E	Rev. 01	Initial issue of report	Aug. 09, 2013

# CERTIFICATE OF COMPLIANCE

according to

47 CFR FCC Part 15 Subpart C § 15.225

**Equipment** : **Mobile Phone**  
**Brand Name** : **LG**  
**Model No.** : **LG-D805, LG-D806**  
**Applicant** : **LG Electronics Inc.**  
60-39, Kasan-dong, Kumchon-gu, Seoul 135-801, Korea

Sporton International as requested by the applicant to evaluate the EMC performance of the product sample received on Jun. 28, 2013 would like to declare that the tested sample has been evaluated and found to be in compliance with the tested rule parts. The data recorded as well as the test configuration specified is true and accurate for showing the sample's EMC nature.



Reviewed by: Joseph Lin / Supervisor



Approved by: Jones Tsai / Manager

**SPORTON INTERNATIONAL INC.**

No. 52, Hwa Ya 1<sup>st</sup> Rd., Hwa Ya Technology Park, Kwei-Shan Hsiang, Tao Yuan Hsien, Taiwan, R.O.C.



### 1. SUMMARY OF THE TEST RESULT

Applied Standard: 47 CFR FCC Part 15 Subpart C					
Part	FCC Rule	IC Rule	Description of Test	Result	Under Limit
3.1	15.207	Gen 7.2.2	AC Power Line Conducted Emissions	Complies	11.80dB at 2.374MHz
3.2	15.225(a)(b)(c)	A2.6	Field Strength of Fundamental Emissions	Complies	72.08dB at 13.56MHz
3.3	2.1049	-	20dB Spectrum Bandwidth	Complies	-
3.4	15.225(d) 15.209	A2.6	Radiated Emissions	Complies	8.37dB at 31.350MHz
3.5	15.225(e)	A2.6	Frequency Stability	Complies	-
3.6	15.203	-	Antenna Requirements	Complies	-

Test Items	Uncertainty	Remark
AC Power Line Conducted Emissions	±2.3dB	Confidence levels of 95%
Field Strength of Fundamental Emissions	±0.8dB	Confidence levels of 95%
20dB Spectrum Bandwidth / Frequency Stability	±8.5×10 <sup>-8</sup>	Confidence levels of 95%
Radiated / Band Edge Emissions (9kHz~30MHz)	±0.8dB	Confidence levels of 95%
Radiated Emissions (30MHz~1000MHz)	±1.9dB	Confidence levels of 95%
Temperature	±0.7°C	Confidence levels of 95%
Humidity	±3.2%	Confidence levels of 95%
DC / AC Power Source	±1.4%	Confidence levels of 95%

## 2. GENERAL INFORMATION

### 2.1 Product Details

For more detailed features description, please refer to the manufacturer's specifications or user's manual.

Items	Description
Power Type	5Vdc from Adapter 3.8Vdc from Li-ion Battery
Modulation	ASK
Channel Number	1
Channel Band Width (99%)	2.260kHz
Max. Field Strength	51.92dB $\mu$ V/m
Test Freq. Range	13.553 ~ 13.567MHz
Carrier Frequencies	13.56 MHz (Ch. 1)
Antenna	Loop Antenna

### 2.2 Accessories

Specification of Accessory		
<b>Adapter</b>	<b>Brand Name</b>	LG Electronics Inc.
	<b>Model Name</b>	MCS-04WT
<b>Battery</b>	<b>Brand Name</b>	LG Chem
	<b>Model Name</b>	BL-T7

### 2.3 Table for Test Modes

Investigation has been done on all the possible configurations for searching the worst cases. The following table is a list of the test modes shown in this test report.

Test Items	Mode	Channel
AC Power Line Conducted Emissions	CTX	-
Field Strength of Fundamental Emissions	CTX	1
20dB Spectrum Bandwidth	CTX	1
Radiated Emissions 9kHz~30MHz	CTX	1
Radiated Emissions 9kHz~10 <sup>th</sup> Harmonic Band Edge Emissions	CTX	1
Frequency Stability	Un-modulation	1

Note:

- 1, CTX=continuously transmitting.
- 2, The EUT choose "NFC Test". Then, the EUT will get into the engineering modes to continuously transmit at 13.56MHz.

### 2.4 Table for Testing Locations

Test Site No.	Site Category	Location
CO05-HY	Conduction	Hwa Ya
TH02-HY	OVEN Room	Hwa Ya
03CH07-HY	SAC	Hwa Ya

Semi Anechoic Chamber (SAC).

### 2.5 Table for Supporting Units

Support Unit	Manufacturer	Model	FCC ID
System Simulator	R&S	CMU 200	N/A
WLAN AP	D-Link	DIR-628	KA2DIR628A2
Bluetooth Earphone	Sony Ericsson	MW600	PY70DA2029
Notebook	DELL	Latitude E6320	FCC DoC
SD Card	SanDisk	MicroSD HC	FCC DoC
NFC Card	Winso	Type A	N/A
NFC Card	Winso	Type B	N/A
NFC Card	Winso	Type F	N/A
NFC Card	Winso	Type V	N/A

## 2.6 Test Configurations

### <AC Conducted Emissions>

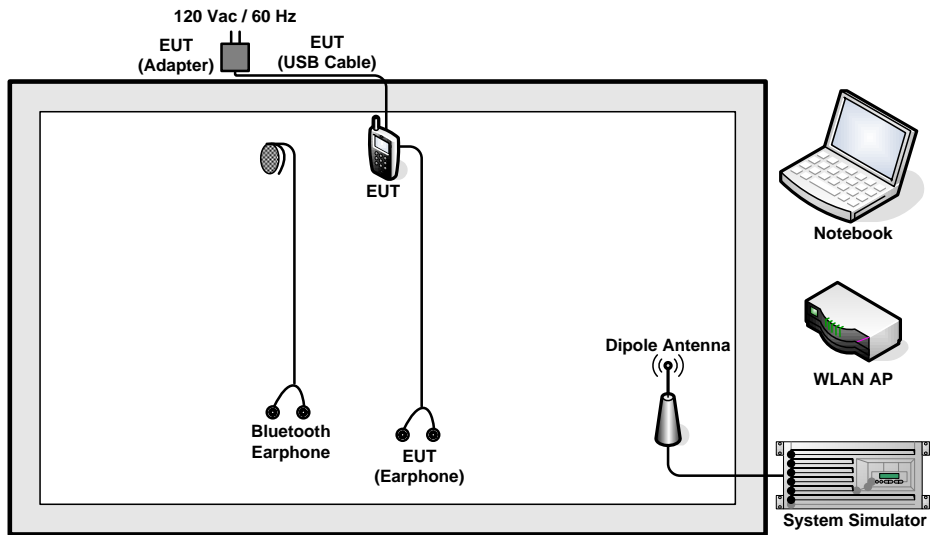

### Fundamental Emissions and Mask Measurement

For radiated emissions 9kHz~30MHz

For radiated emissions 30MHz~1GHz

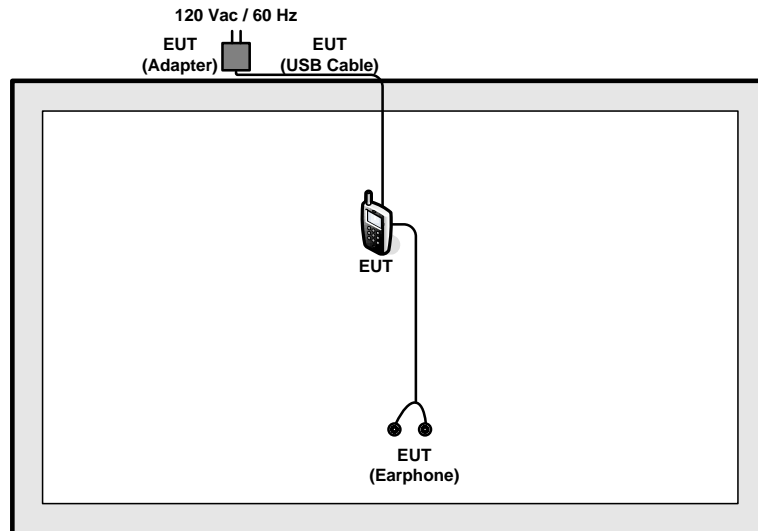



### 3. TEST RESULT

#### 3.1 AC Power Line Conducted Emissions Measurement

##### 3.1.1 Limit

For a Low-power Radio-frequency device which is designed to be connected to the AC power line, the radio frequency voltage that is conducted back onto the AC power line on any frequency or frequencies within the band 150 kHz to 30 MHz shall not exceed below limits table.

Frequency (MHz)	QP Limit (dB $\mu$ V)	AV Limit (dB $\mu$ V)
0.15~0.5	66~56	56~46
0.5~5	56	46
5~30	60	50

##### 3.1.2 Measuring Instruments and Setting

Please refer to section 4 of equipments list in this report. The following table is the setting of the receiver.

Receiver Parameters	Setting
Attenuation	10 dB
Start Frequency	0.15 MHz
Stop Frequency	30 MHz
IF Bandwidth	9 kHz

##### 3.1.3 Test Procedures

1. Configure the EUT according to ANSI C63.4. The EUT or host of EUT has to be placed 0.4 meter far from the conducting wall of the shielding room and at least 80 centimeters from any other grounded conducting surface.
2. Connect EUT or host of EUT to the power mains through a line impedance stabilization network (LISN).
3. All the support units are connected to the other LISNs. The LISN should provide 50uH/50ohms coupling impedance.
4. The frequency range from 150 kHz to 30 MHz was searched.
5. Set the test-receiver system to Peak Detect Function and Specified Bandwidth with Maximum Hold Mode.
6. The measurement has to be done between each power line and ground at the power terminal.

3.1.4 Test Setup Layout

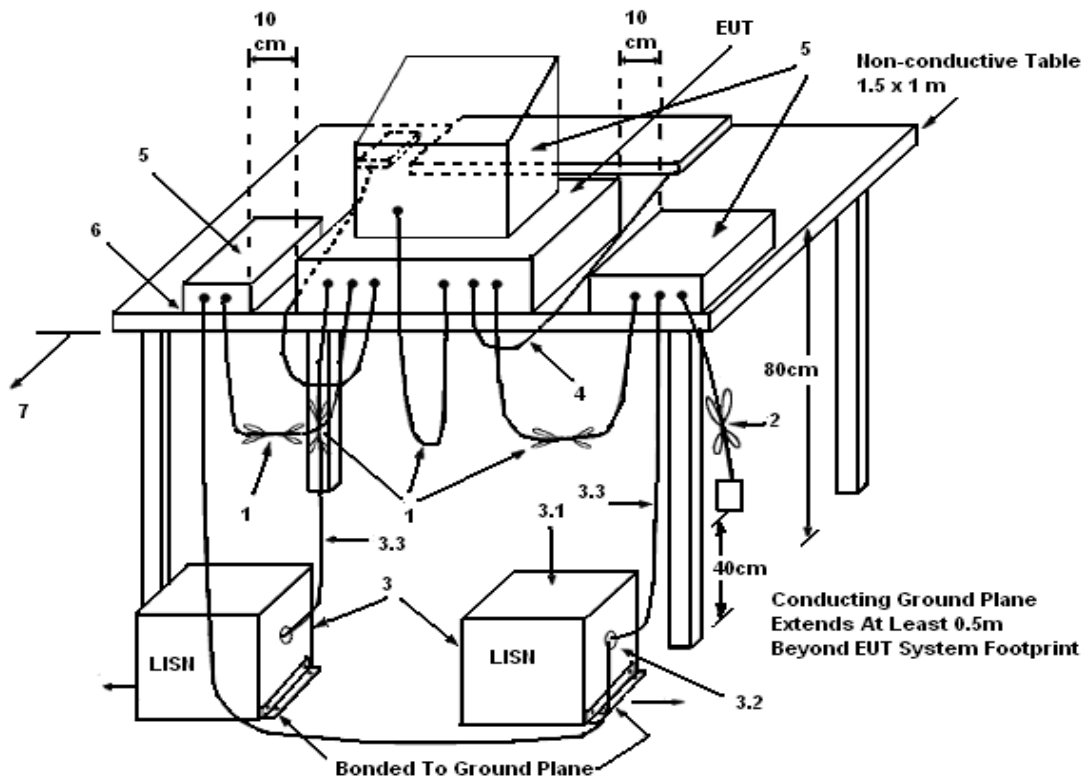

LEGEND:

- (1) Interconnecting cables that hang closer than 40 cm to the ground plane shall be folded back and forth in the center forming a bundle 30 to 40 cm long.
- (2) I/O cables that are not connected to a peripheral shall be bundled in the center. The end of the cable may be terminated, if required, using the correct terminating impedance. The overall length shall not exceed 1 m.
- (3) EUT connected to one LISN. Unused LISN measuring port connectors shall be terminated in 50 Ω. LISN can be placed on top of, or immediately beneath, reference ground plane.
  - (3.1) All other equipment powered from additional LISN(s).
  - (3.2) Multiple outlet strip can be used for multiple power cords of non-EUT equipment.
  - (3.3) LISN at least 80 cm from nearest part of EUT chassis.
- (4) Cables of hand-operated devices, such as keyboards, mice, etc., shall be placed as for normal use.
- (5) Non-EUT components of EUT system being tested.
- (6) Rear of EUT, including peripherals, shall all be aligned and flush with rear of tabletop.
- (7) Rear of tabletop shall be 40 cm removed from a vertical conducting plane that is bonded to the ground plane.



**3.1.5 Test Deviation**

There is no deviation with the original standard.

**3.1.6 EUT Operation during Test**

The EUT was placed on the test table and programmed in transmitting function.

3.1.7 Results of AC Power Line Conducted Emissions Measurement

<b>Final Test Date</b>	Jul. 19, 2013	<b>Test Site No.</b>	CO05-HY
<b>Temperature</b>	20~22°C	<b>Humidity</b>	45~47%
<b>Test Engineer</b>	Slash Huang	<b>Configuration</b>	Transmitting Mode (13.56MHz)
<b>Mode</b>	NFC Tx + GSM850 Idle + Bluetooth Link + WLAN Link + Earphone + USB Cable (Charging from Adapter)		

Line

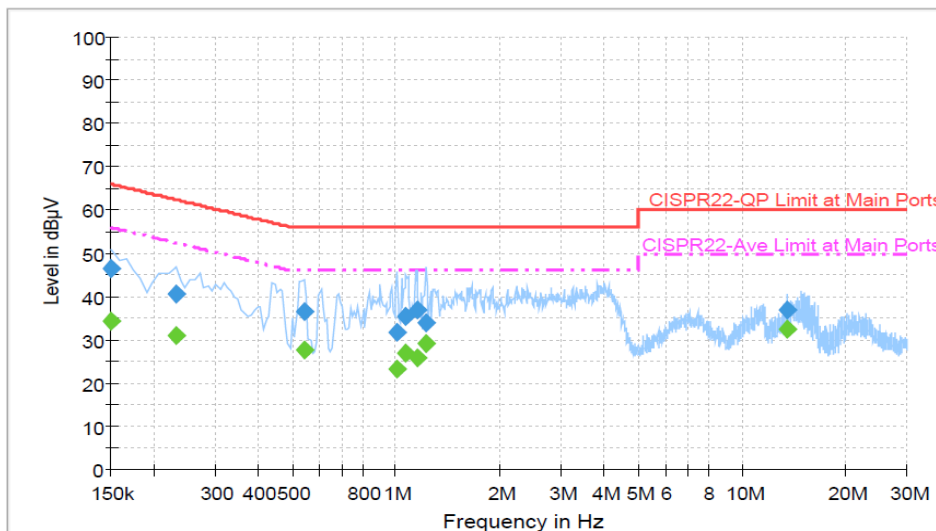

Final Result: Quasi-Peak

Frequency (MHz)	Quasi-Peak (dBµV)	Filter	Line	Corr. (dB)	Margin (dB)	Limit (dBµV)
0.150000	46.6	Off	L1	19.4	19.4	66.0
0.230000	40.5	Off	L1	19.4	21.9	62.4
0.542000	36.4	Off	L1	19.4	19.6	56.0
1.006000	31.9	Off	L1	19.4	24.1	56.0
1.070000	35.3	Off	L1	19.4	20.7	56.0
1.150000	37.0	Off	L1	19.5	19.0	56.0
1.222000	34.1	Off	L1	19.5	21.9	56.0
13.558000	36.9	Off	L1	19.9	23.1	60.0

Final Result: Average

Frequency (MHz)	Average (dBµV)	Filter	Line	Corr. (dB)	Margin (dB)	Limit (dBµV)
0.150000	34.3	Off	L1	19.4	21.7	56.0
0.230000	31.0	Off	L1	19.4	21.4	52.4
0.542000	27.7	Off	L1	19.4	18.3	46.0
1.006000	23.3	Off	L1	19.4	22.7	46.0
1.070000	26.8	Off	L1	19.4	19.2	46.0
1.150000	26.0	Off	L1	19.5	20.0	46.0
1.222000	29.2	Off	L1	19.5	16.8	46.0
13.558000	32.5	Off	L1	19.9	17.5	50.0



Neutral

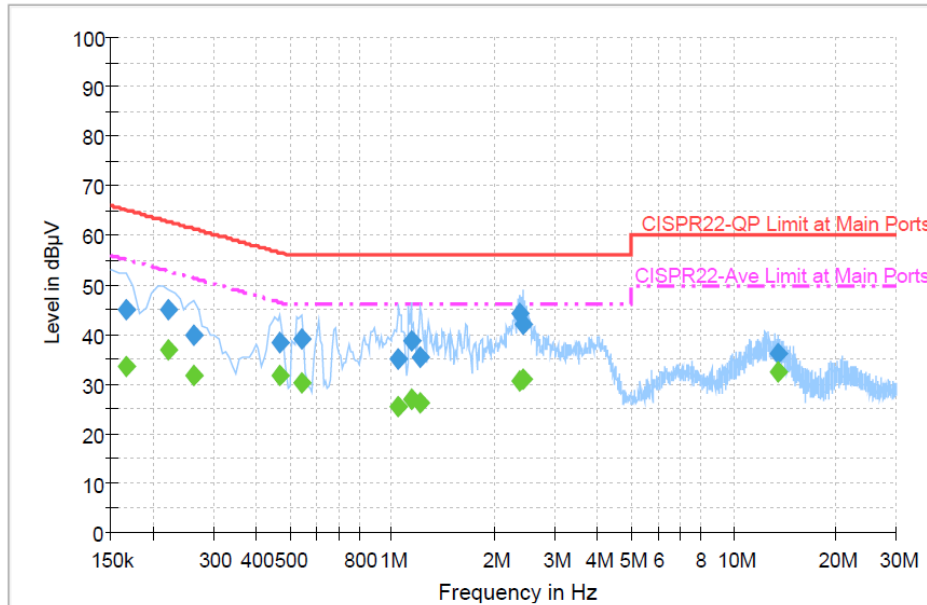

Final Result: Quasi-Peak

Frequency (MHz)	Quasi-Peak (dBµV)	Filter	Line	Corr. (dB)	Margin (dB)	Limit (dBµV)
0.166000	45.2	Off	N	19.4	20.0	65.2
0.222000	45.1	Off	N	19.4	17.6	62.7
0.262000	40.0	Off	N	19.4	21.4	61.4
0.470000	38.2	Off	N	19.4	18.3	56.5
0.542000	39.2	Off	N	19.4	16.8	56.0
1.046000	35.1	Off	N	19.5	20.9	56.0
1.134000	38.6	Off	N	19.5	17.4	56.0
1.206000	35.5	Off	N	19.5	20.5	56.0
2.374000	44.2	Off	N	19.7	11.8	56.0
2.414000	42.2	Off	N	19.7	13.8	56.0
13.558000	36.3	Off	N	19.9	23.7	60.0

Final Result: Average

Frequency (MHz)	Average (dBµV)	Filter	Line	Corr. (dB)	Margin (dB)	Limit (dBµV)
0.166000	33.6	Off	N	19.4	21.6	55.2
0.222000	36.8	Off	N	19.4	15.9	52.7
0.262000	31.8	Off	N	19.4	19.6	51.4
0.470000	31.8	Off	N	19.4	14.7	46.5
0.542000	30.3	Off	N	19.4	15.7	46.0
1.046000	25.4	Off	N	19.5	20.6	46.0
1.134000	26.8	Off	N	19.5	19.2	46.0
1.206000	26.1	Off	N	19.5	19.9	46.0
2.374000	30.6	Off	N	19.7	15.4	46.0
2.414000	31.0	Off	N	19.7	15.0	46.0
13.558000	32.4	Off	N	19.9	17.6	50.0

### 3.2 Field Strength of Fundamental Emissions and Mask Measurement

#### 3.2.1 Limit

Field strength of fundamental emissions limit:

The field strength of fundamental emissions shall not exceed 15848 microvolts/meter at 30 meters.

The emissions limit in this paragraph is based on measurement instrumentation employing a QP detector.

Frequencies (MHz)	Field Strength (microvolts/meter)	Field Strength (dBµV/m) at 10m	Field Strength (dBµV/m) at 3m
13.553 ~ 13.567MHz	15848 at 30m	103.08 (QP)	124 (QP)

Mask limit:

Rules and specifications	CFR 47 Part 15 section 15.225(a)-(d)				
Description	Compliance with the spectrum mask is tested using a spectrum analyzer with RBW set to a 9kHz for the band 13.553~13.567MHz				
Limit	Freq. of Emission (MHz)	Field Strength (µV/m) at 30m	Field Strength (dBµV/m) at 30m	Field Strength (dBµV/m) at 10m	Field Strength (dBµV/m) at 3m
	1.705~13.110	30	29.5	48.58	69.5
	13.110~13.410	106	40.5	59.58	80.5
	13.410~13.553	334	50.5	69.58	90.5
	13.553~13.567	15848	84.0	103.08	124.0
	13.567~13.710	334	50.5	69.58	90.5
	13.710~14.010	106	40.5	59.58	80.5
	14.010~30.000	30	29.5	48.58	69.5

#### 3.2.2 Measuring Instruments and Setting

Please refer to section 4 of equipments list in this report. The following table is the setting of the receiver.

Receiver Parameter	Setting
Attenuation	Auto
Center Frequency	Fundamental Frequency
RBW	9 kHz
Detector	QP

### 3.2.3 Test Procedures

1. Configure the EUT according to ANSI C63.4. The EUT was placed on the top of the turntable 0.8 meter above ground. The phase center of the loop receiving antenna mounted antenna tower was placed 3 meters far away from the turntable.
2. Power on the EUT and all the supporting units. The turntable was rotated by 360 degrees to determine the position of the highest radiation.
3. The height of the receiving antenna was fixed at one meter above ground to find the maximum emissions field strength.
4. For Fundamental emissions, use the receiver to measure QP reading.
5. When the radiated emissions limits are expressed in terms of the average value of the emissions, and pulsed operation is employed, the measurement field strength shall be determined by averaging over one complete pulse train, including blanking intervals, as long as the pulse train does not exceed 0.1 seconds. As an alternative (provided the transmitter operates for longer than 0.1 seconds) or in cases where the pulse train exceeds 0.1 seconds, the measured field strength shall be determined from the average absolute voltage during a 0.1 second interval during which the field strength is at its maximum value.
6. Compliance with the spectrum mask is tested using a spectrum analyzer with RBW set to a 1kHz for the band 13.553~13.567MHz.

### 3.2.4 Test Setup Layout

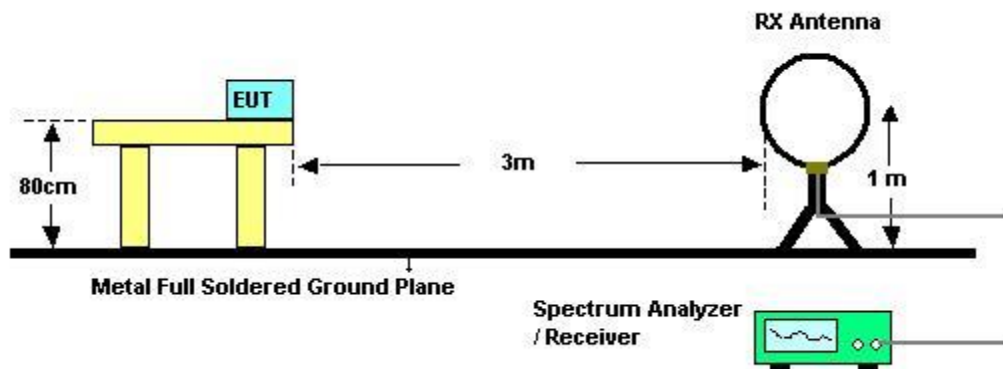

### 3.2.5 Test Deviation

There is no deviation with the original standard.

### 3.2.6 EUT Operation during Test

The EUT was programmed to be in continuously transmitting mode.



3.2.7 Test Result of Field Strength of Fundamental Emissions

Final Test Date	Aug. 03, 2013	Test Site No.	03CH07-HY
Temperature	22~24°C	Humidity	51 ~53%
Test Engineer	Eric Shih	Configurations	Ch. 1

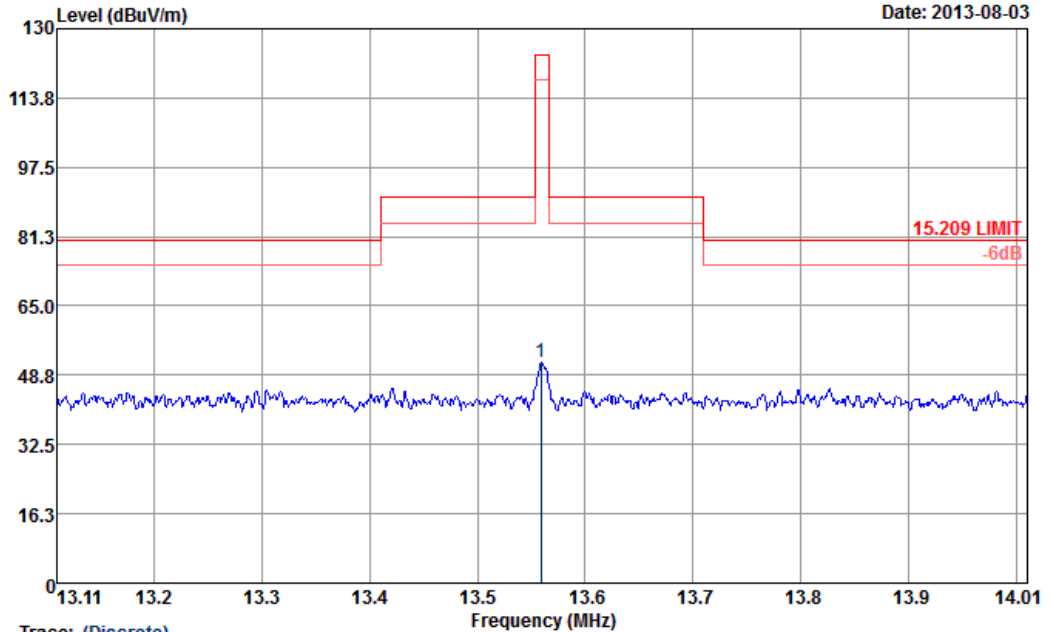

Trace: (Discrete)  
 Site : 03CH07-HY  
 Condition : 15.209 LIMIT 3m NFC FACTOR(120912)-H HORIZONTAL  
 : RBW:9.000KHz VBW:9.000KHz SWT:Auto

Mode : 1

	Over	Limit	ReadAntenna	Cable Preamp	A/Pos	T/Pos	Remark
Freq	Level	Limit	Level	Factor			
MHz	dBUV/m	dB	dBUV/m	dBuV	dB/m	dB	dB
1	13.56	51.92	-72.08	124.00	31.77	19.75	0.40 0.00 100 5 QP



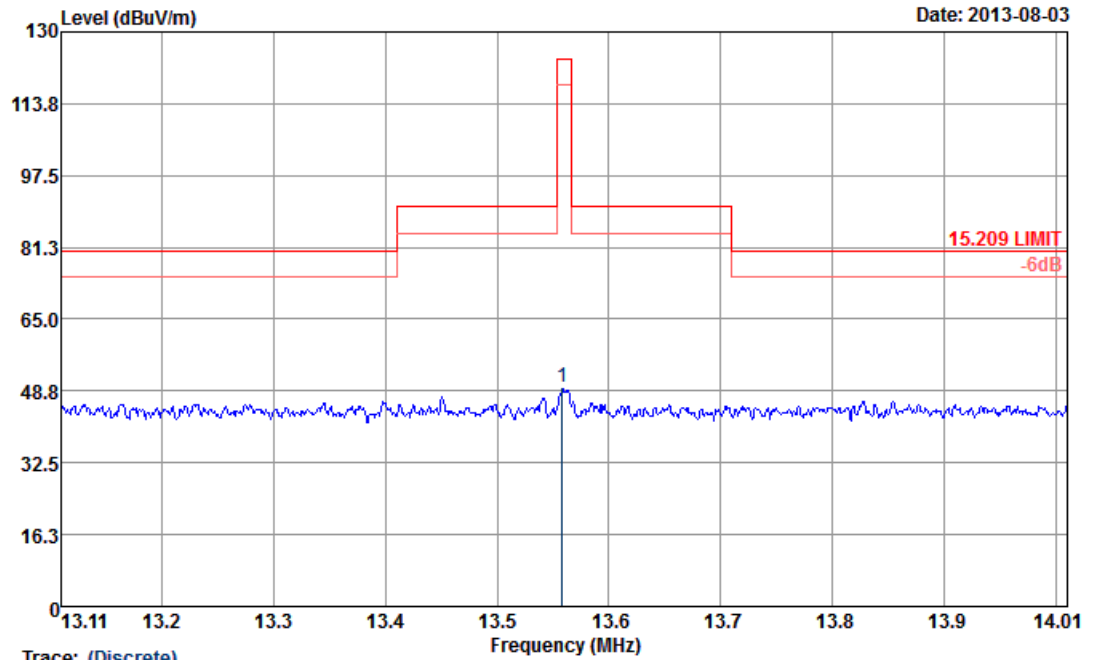

Trace: (Discrete)  
 Site : 03CH07-HY  
 Condition : 15.209 LIMIT 3m NFC FACTOR(120912)-V VERTICAL  
 : RBW:9.000KHz VBW:9.000KHz SWT:Auto

Mode : 1

Freq	Level	Over Limit	Limit Line	ReadAntenna Level	Antenna Factor	Cable Loss	Preamp Factor	A/Pos	T/Pos	Remark
MHz	dBuV/m	dB	dBuV/m	dBuV	dB/m	dB	dB	cm	deg	
1	13.56	49.66	-74.34	124.00	29.51	19.75	0.40	0.00	100	278 QP

Note:

Emission level (dBµV/m) = 20 log Emission level (µV/m).

Measured distance is 3m.

All emissions emit form non-NFC function of digital unintentional emissions. All NFC's spurious emissions are below 20dB of limits.

### 3.3 20dB Spectrum Bandwidth Measurement

#### 3.3.1 Limit

Intentional radiators must be designed to ensure that the 20 dB bandwidth of the emissions in the specific band (13.553 ~ 13.567MHz).

#### 3.3.2 Measuring Instruments and Setting

Please refer to section 4 of equipments list in this report. The following table is the setting of the spectrum analyzer.

Spectrum Parameters	Setting
Attenuation	Auto
Span Frequency	> 20dB Bandwidth
RBW	1 kHz
VBW	3 kHz
Detector	Peak
Trace	Max Hold
Sweep Time	Auto

#### 3.3.3 Test Procedures

1. The transmitter output (antenna port) was connected to the spectrum analyzer in peak hold mode.
2. The resolution bandwidth of 1 kHz and the video bandwidth of 3 kHz were used.
3. Measured the spectrum width with power higher than 20dB below carrier.

#### 3.3.4 Test Setup Layout

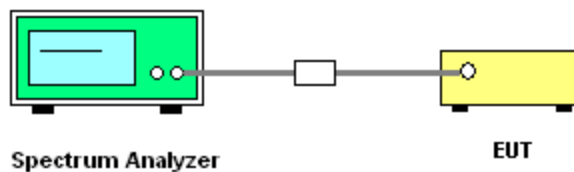

#### 3.3.5 Test Deviation

There is no deviation with the original standard.

#### 3.3.6 EUT Operation during Test

The EUT was programmed to be in continuously transmitting mode.



3.3.7 Test Result of 20dB Spectrum Bandwidth

Final Test Date	Aug. 04, 2013	Test Site No.	TH02-HY
Temperature	22~24°C	Humidity	53~55%
Test Engineer	Tommy Lee	Configurations	Ch. 1

Frequency	20dB BW (kHz)	99% OBW (kHz)	Frequency range (MHz) $f_L > 13.553\text{MHz}$	Frequency range (MHz) $f_H < 13.567\text{MHz}$	Test Result
13.56 MHz	2.640	2.260	13.55860	13.56124	Complies

20 dB / 99% Bandwidth Plot on 13.56 MHz

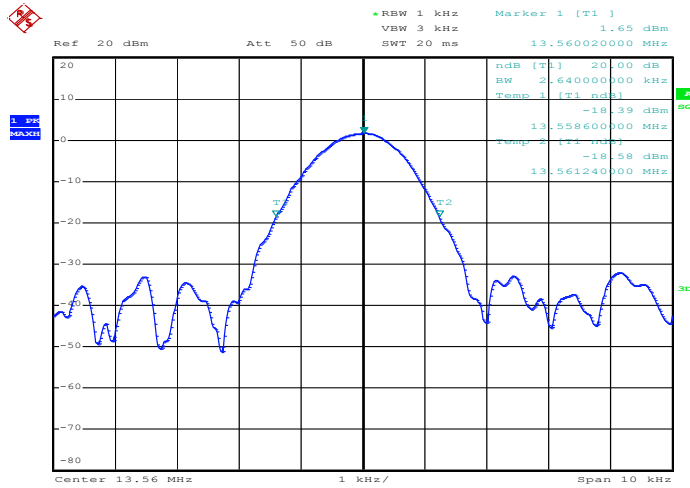

Date: 4.AUG.2013 13:20:04

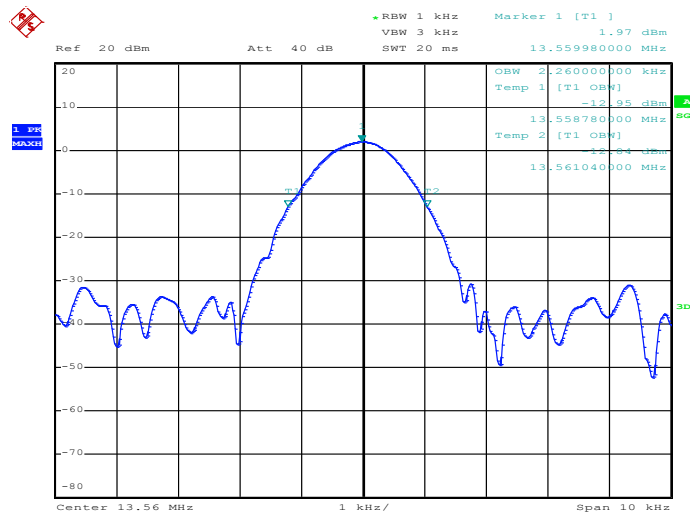

Date: 4.AUG.2013 13:27:48

### 3.4 Radiated Emissions Measurement

#### 3.4.1 Limit

The field strength of any emissions which appear outside of 13.553 ~ 13.567MHz band shall not exceed the general radiated emissions limits.

<b>Frequencies (MHz)</b>	<b>Field Strength (<math>\mu</math>V/m)</b>	<b>Measurement Distance (meters)</b>
0.009~0.490	2400/F(kHz)	300
0.490~1.705	24000/F(kHz)	30
1.705~30.0	30	30
30~88	100	3
88~216	150	3
216~960	200	3
Above 960	500	3

#### 3.4.2 Measuring Instruments and Setting

Please refer to section 4 of equipments list in this report. The following table is the setting of receiver.

<b>Receiver Parameter</b>	<b>Setting</b>
Attenuation	Auto
Start ~ Stop Frequency	9kHz~150kHz / RBW 200Hz for QP
Start ~ Stop Frequency	150kHz~30MHz / RBW 9kHz for QP
Start ~ Stop Frequency	30MHz~1000MHz / RBW 120kHz for Peak

#### 3.4.3 Test Procedures

1. Configure the EUT according to ANSI C63.4. The EUT was placed on the top of the turntable 0.8 meter above ground. The phase center of the receiving antenna mounted on the top of a height-variable antenna tower was placed 3 meters far away from the turntable.
2. Power on the EUT and all the supporting units. The turntable was rotated by 360 degrees to determine the position of the highest radiation.
3. The height of the broadband receiving antenna was varied between one meter and four meters above ground to find the maximum emissions field strength of both horizontal and vertical polarization.
4. For each suspected emissions, the antenna tower was scan (from 1 M to 4 M) and then the turntable was rotated (from 0 degree to 360 degrees) to find the maximum reading.
5. Set the test-receiver system to Peak or CISPR quasi-peak Detect Function with specified bandwidth under Maximum Hold Mode.
6. When the radiated emissions limits are expressed in terms of the average value of the emissions,



and pulsed operation is employed, the measurement field strength shall be determined by averaging over one complete pulse train, including blanking intervals, as long as the pulse train does not exceed 0.1 seconds. As an alternative (provided the transmitter operates for longer than 0.1 seconds) or in cases where the pulse train exceeds 0.1 seconds, the measured field strength shall be determined from the average absolute voltage during a 0.1 second interval during which the field strength is at its maximum value.

7. In case the emission is lower than 30MHz, loop antenna has to be used for measurement and the recorded data should be QP measured by receiver. High – Low scan is not required in this case.

### 3.4.4 Test Setup Layout

For radiated emissions below 30MHz

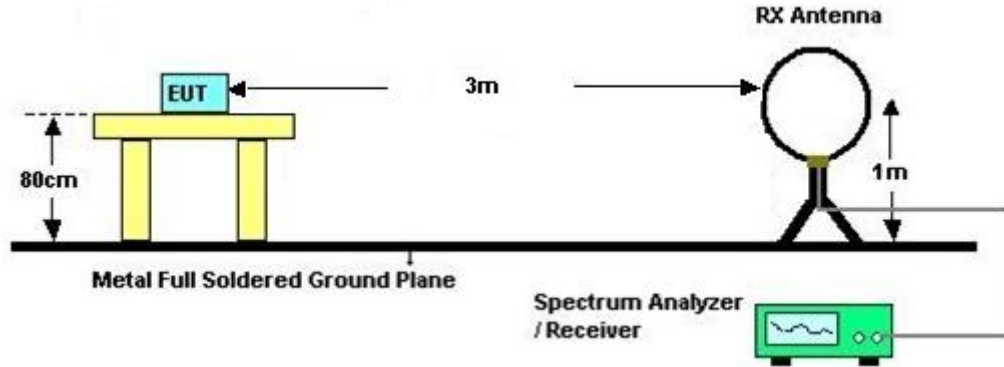

For radiated emissions above 30MHz

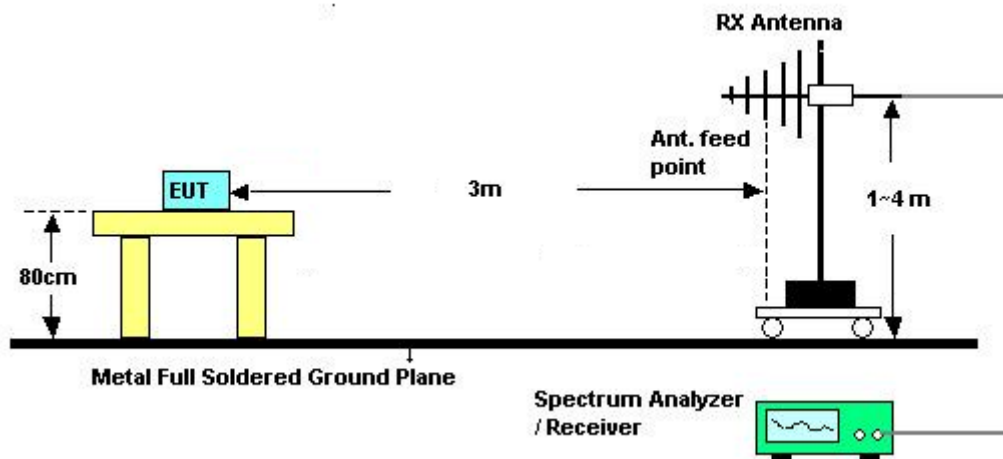

### 3.4.5 Test Deviation

There is no deviation with the original standard.

### 3.4.6 EUT Operation during Test

The EUT was programmed to be in continuously transmitting mode.



3.4.7 Results of Radiated Emissions (9 kHz~30MHz)

Final Test Date	Aug. 03, 2013	Test Site No.	03CH07-HY
Temperature	22~24°C	Humidity	51~53%
Test Engineer	Eric Shih	Configurations	Ch. 1

Horizontal

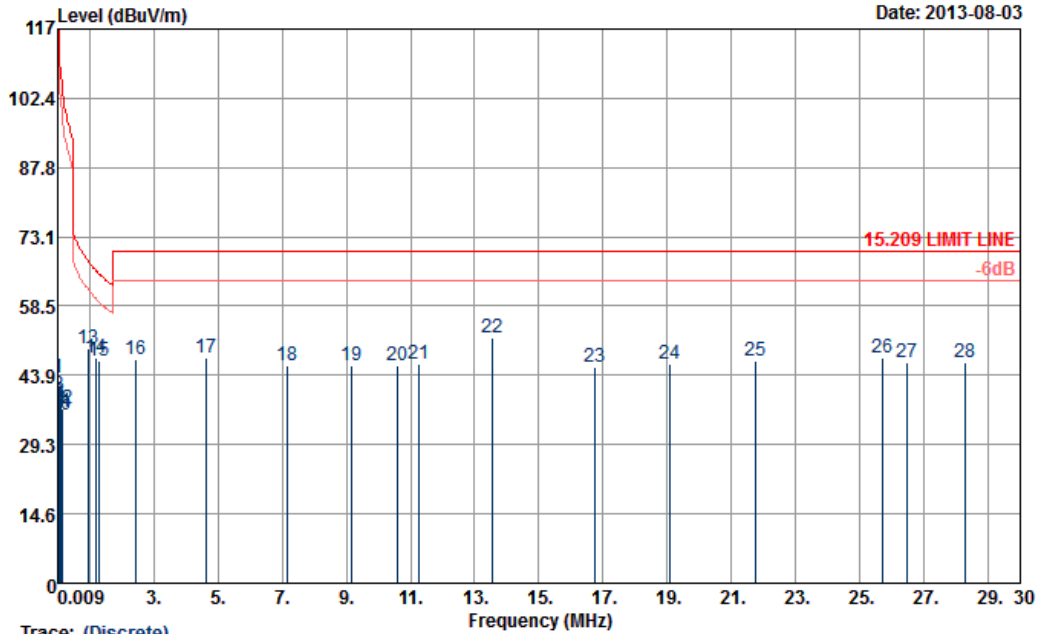

Trace: (Discrete)  
 Site : 03CH07-HY  
 Condition : 15.209 LIMIT LINE 3m NFC FACTOR(120912)-H HORIZONTAL

Mode : 1

	Freq	Level	Over	Limit	ReadAntenna	Cable	Preamp	A/Pos	T/Pos	Remark
	MHz	dBuV/m	Limit	Line	Level	Factor	Loss	Factor	cm	deg
			dB	dBuV/m	dBuV	dB/m	dB	dB		
1	0.02	43.26	-79.20	122.46	22.71	20.26	0.29	0.00	---	QP
2	0.04	39.83	-76.87	116.70	19.37	20.17	0.29	0.00	---	QP
3	0.05	38.10	-75.82	113.92	17.64	20.17	0.29	0.00	---	QP
4	0.06	37.47	-74.33	111.80	17.07	20.11	0.29	0.00	---	QP
5	0.07	37.58	-73.68	111.26	17.18	20.11	0.29	0.00	---	QP
6	0.09	36.45	-72.41	108.86	16.09	20.07	0.29	0.00	---	QP
7	0.09	35.64	-72.70	108.34	15.28	20.07	0.29	0.00	---	QP
8	0.10	38.36	-69.37	107.73	18.00	20.07	0.29	0.00	---	QP
9	0.10	36.31	-70.97	107.28	15.95	20.07	0.29	0.00	---	QP
10	0.12	35.55	-70.27	105.82	15.20	20.06	0.29	0.00	---	QP
11	0.13	36.04	-69.59	105.63	15.69	20.06	0.29	0.00	---	QP
12	0.14	36.86	-67.56	104.42	16.53	20.04	0.29	0.00	---	QP
13	0.98	49.40	-18.34	67.74	29.09	20.00	0.31	0.00	---	QP
14	1.20	47.49	-18.50	65.99	27.17	20.01	0.31	0.00	---	QP
15	1.31	46.95	-18.28	65.23	26.63	20.01	0.31	0.00	100	29 QP
16	2.43	47.21	-22.79	70.00	26.85	20.03	0.33	0.00	---	QP
17	4.62	47.46	-22.54	70.00	27.12	19.98	0.36	0.00	---	QP
18	7.18	46.01	-23.99	70.00	25.81	19.83	0.37	0.00	---	QP
19	9.18	45.82	-24.18	70.00	25.68	19.76	0.38	0.00	---	QP
20	10.62	45.84	-24.16	70.00	25.68	19.77	0.39	0.00	---	QP
21	11.28	46.18	-23.82	70.00	26.02	19.77	0.39	0.00	---	QP
22	13.56	51.80	-18.20	70.00	31.65	19.75	0.40	0.00	---	QP
23	16.77	45.59	-24.41	70.00	25.35	19.82	0.42	0.00	---	QP
24	19.11	46.14	-23.86	70.00	25.68	20.03	0.43	0.00	---	QP
25	21.75	46.94	-23.06	70.00	26.21	20.29	0.44	0.00	---	QP
26	25.72	47.49	-22.51	70.00	26.63	20.39	0.47	0.00	---	QP
27	26.46	46.45	-23.55	70.00	25.58	20.40	0.47	0.00	---	QP
28	28.29	46.63	-23.37	70.00	25.82	20.31	0.50	0.00	---	QP



Vertical

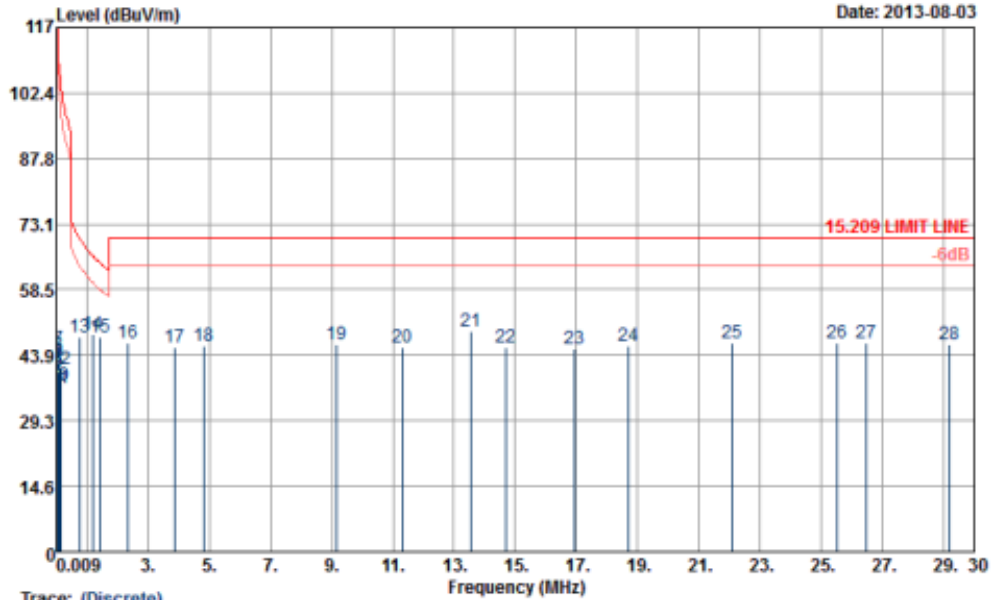

Trace: (Discrete)  
 Site : 03CH07-HY  
 Condition : 15.209 LIMIT LINE 3m NFC FACTOR(120912)-V VERTICAL

Mode	1												
	Freq	Level	Over	Limit	ReadAntenna	Cable	Preamp	A/Pos	T/Pos	Remark			
	MHz	dBuV/m	dB	dBuV/m	dBuV	dB/m	dB	dB	cm	deg			
1	0.02	42.61	-79.88	122.49	22.06	20.26	0.29	0.00	---	---	QP		
2	0.04	40.14	-76.56	116.70	19.68	20.17	0.29	0.00	---	---	QP		
3	0.05	38.47	-75.44	113.91	18.01	20.17	0.29	0.00	---	---	QP		
4	0.06	36.62	-75.29	111.91	16.22	20.11	0.29	0.00	---	---	QP		
5	0.07	36.79	-73.63	110.42	16.39	20.11	0.29	0.00	---	---	QP		
6	0.08	40.52	-68.94	109.46	20.12	20.11	0.29	0.00	---	---	QP		
7	0.10	45.27	-62.63	107.90	24.91	20.07	0.29	0.00	---	---	QP		
8	0.10	44.12	-63.61	107.73	23.76	20.07	0.29	0.00	---	---	QP		
9	0.10	42.43	-65.22	107.65	22.07	20.07	0.29	0.00	---	---	QP		
10	0.12	37.18	-68.63	105.81	16.83	20.06	0.29	0.00	---	---	QP		
11	0.13	36.56	-68.84	105.40	16.21	20.06	0.29	0.00	---	---	QP		
12	0.15	40.81	-63.56	104.37	20.48	20.04	0.29	0.00	---	---	QP		
13	0.79	47.75	-21.88	69.63	27.44	20.00	0.31	0.00	---	---	QP		
14	1.20	48.42	-17.59	66.01	28.10	20.01	0.31	0.00	---	---	QP		
15	1.45	48.06	-16.32	64.38	27.74	20.01	0.31	0.00	100	293	QP		
16	2.36	46.48	-23.52	70.00	26.12	20.03	0.33	0.00	---	---	QP		
17	3.87	45.71	-24.29	70.00	25.35	20.01	0.35	0.00	---	---	QP		
18	4.83	45.90	-24.10	70.00	25.57	19.97	0.36	0.00	---	---	QP		
19	9.16	46.16	-23.84	70.00	26.02	19.76	0.38	0.00	---	---	QP		
20	11.33	45.62	-24.38	70.00	25.46	19.77	0.39	0.00	---	---	QP		
21	13.57	49.36	-20.64	70.00	29.21	19.75	0.40	0.00	---	---	QP		
22	14.69	45.74	-24.26	70.00	25.57	19.76	0.41	0.00	---	---	QP		
23	16.95	45.23	-24.77	70.00	24.98	19.83	0.42	0.00	---	---	QP		
24	18.69	46.09	-23.91	70.00	25.68	19.98	0.43	0.00	---	---	QP		
25	22.08	46.65	-23.35	70.00	25.91	20.30	0.44	0.00	---	---	QP		
26	25.52	46.53	-23.47	70.00	25.67	20.39	0.47	0.00	---	---	QP		
27	26.47	46.55	-23.45	70.00	25.68	20.40	0.47	0.00	---	---	QP		
28	29.19	46.41	-23.59	70.00	25.69	20.21	0.51	0.00	---	---	QP		

Note:

1. Remark 22 of horizontal plot and 21 of vertical plot are transmitter's fundamental signals.
2. The amplitude of spurious emissions which are attenuated by more than 20dB below the permissible value has no need to be reported.

Distance extrapolation factor = 40 log (specific distance / test distance) (dB);

Limit line = specific limits (dBuV) + distance extrapolation factor.





3.4.8 Results for Radiated Emissions (30MHz~1GHz)

<b>Final Test Date</b>	Aug. 03, 2013	<b>Test Site No.</b>	03CH07-HY
<b>Temperature</b>	22~24°C	<b>Humidity</b>	51~53%
<b>Test Engineer</b>	Eric Shih	<b>Configurations</b>	Ch. 1

Horizontal

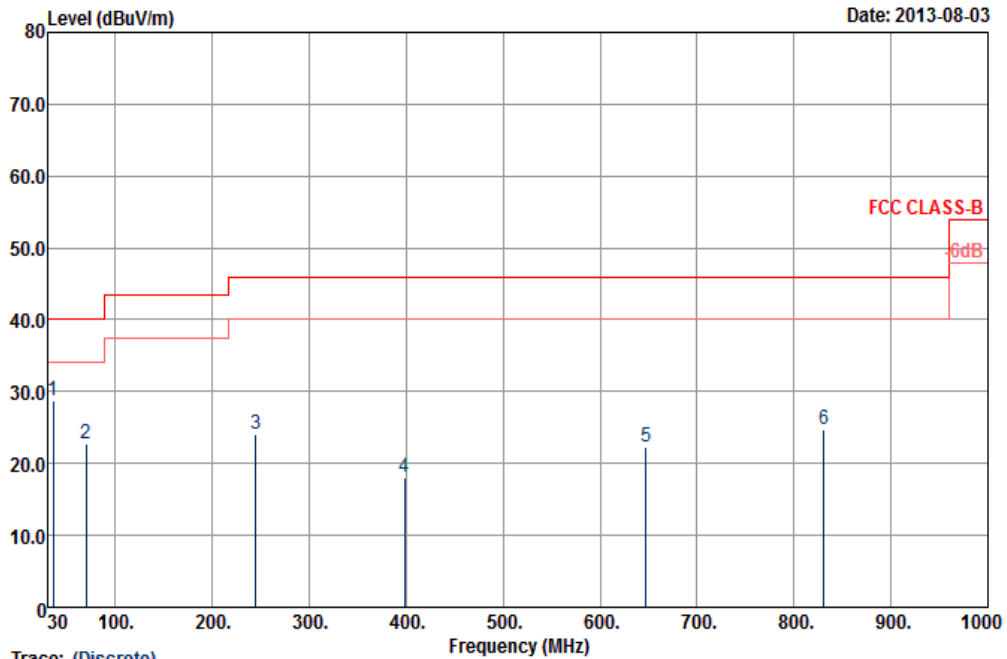

Trace: (Discrete)  
 Site : 03CH07-HY  
 Condition : FCC CLASS-B 3m LF-ANT(111116) HORIZONTAL

Mode : 1

	Freq	Level	Over	Limit	ReadAntenna	Cable	Preamp	A/Pos	T/Pos	Remark
	MHz	dBuV/m	Limit	Line	Level	Factor	Loss	Factor	cm	deg
			dB	dBuV/m	dBuV	dB/m	dB	dB		
1	35.67	28.85	-11.15	40.00	43.72	15.82	0.59	31.28	103	96 Peak
2	69.42	22.81	-17.19	40.00	46.97	6.30	0.84	31.30	---	Peak
3	244.92	23.98	-22.02	46.00	41.19	12.26	1.53	31.00	---	Peak
4	398.00	18.15	-27.85	46.00	30.97	15.95	2.14	30.91	---	Peak
5	647.20	22.23	-23.77	46.00	29.74	20.17	2.83	30.51	---	Peak
6	830.60	24.67	-21.33	46.00	29.41	22.40	3.22	30.36	---	Peak



Vertical

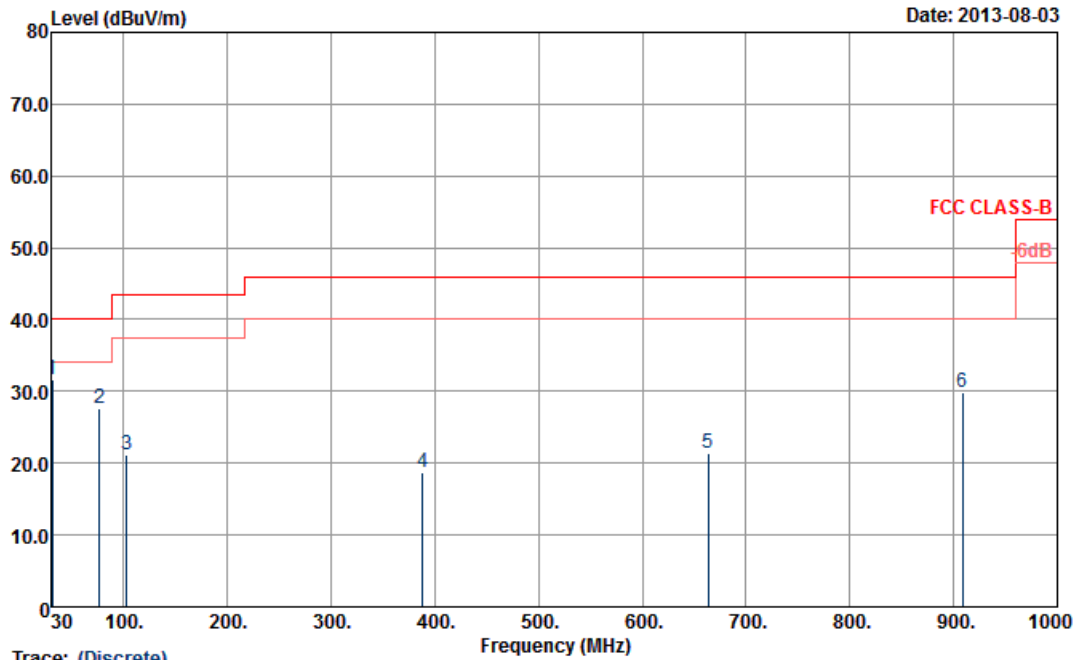

Trace: (Discrete)  
 Site : 03CH07-HY  
 Condition : FCC CLASS-B 3m LF-ANT(111116) VERTICAL

Mode : 1

	Freq	Level	Over Limit	Limit Line	ReadAntenna Level	Antenna Factor	Cable Loss	Preamp Factor	A/Pos	T/Pos	Remark
	MHz	dBuV/m	dB	dBuV/m	dBuV	dB/m	dB	dB	cm	deg	
1	31.35	31.63	-8.37	40.00	43.23	19.28	0.54	31.42	158	39	Peak
2	76.71	27.70	-12.30	40.00	50.85	7.19	0.86	31.20	---	---	Peak
3	103.17	21.22	-22.28	43.50	41.27	10.07	1.01	31.13	---	---	Peak
4	388.20	18.72	-27.28	46.00	31.87	15.69	2.12	30.96	---	---	Peak
5	663.30	21.46	-24.54	46.00	28.76	20.30	2.87	30.47	---	---	Peak
6	909.00	29.90	-16.10	46.00	33.63	23.23	3.36	30.32	---	---	Peak

Note:  
 The amplitude of spurious emissions which are attenuated by more than 20dB below the permissible value has no need to be reported.  
 Emission level (dBuV/m) = 20 log Emission level (uV/m).  
 Corrected Reading: Antenna Factor + Cable Loss + Read Level - Preamp Factor= Level.



### 3.5 Frequency Stability Measurement

#### 3.5.1 Limit

The frequency tolerance of the carrier signal shall be maintained within +/- 0.01% (100ppm) of the operating frequency over a temperature variation of -20 degrees to +50 degrees C at normal supply voltage, and for a variation in the primary supply voltage from 85% to 115% of the rated supply voltage at a temperature of 20 degrees C. For battery operated equipment, the equipment tests shall be performed using a new battery.

#### 3.5.2 Measuring Instruments and Setting

Please refer to section 4 of equipments list in this report. The following table is the setting of the spectrum analyzer.

Spectrum Parameter	Setting
Attenuation	Auto
Span Frequency	Entire absence of modulation emissions bandwidth
RBW	1 kHz
VBW	3 kHz
Sweep Time	Auto

#### 3.5.3 Test Procedures

1. The transmitter output (antenna port) was connected to the spectrum analyzer.
2. EUT have transmitted absence of modulation signal and fixed channelize.
3. Set the spectrum analyzer span to view the entire absence of modulation emissions bandwidth.
4. Set RBW = 1 kHz, VBW = 3 kHz with peak detector and maxhold settings.
5. fc is declaring of channel frequency. Then the frequency error formula is  $(f_c - f) / f_c \times 10^6$  ppm and the limit is less than  $\pm 100$ ppm.
6. The test extreme voltage is to change the primary supply voltage from 85 to 115 percent of the nominal value
7. Extreme temperature rule is -20°C~50°C.

### 3.5.4 Test Setup Layout

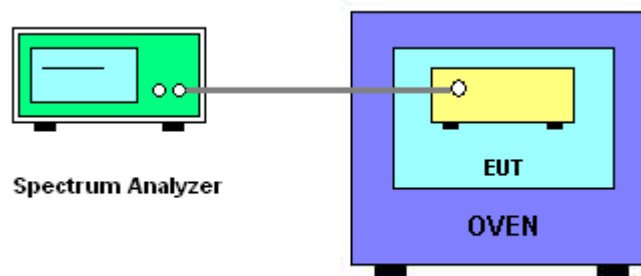

### 3.5.5 Test Deviation

There is no deviation with the original standard.

### 3.5.6 EUT Operation during Test

The EUT was programmed to be in continuously un-modulation transmitting mode.



3.5.7 Test Result of Frequency Stability

<b>Final Test Date</b>	Aug. 04, 2013	<b>Test Site No.</b>	TH02-HY
<b>Temperature</b>	22~24°C	<b>Humidity</b>	53~55%
<b>Test Engineer</b>	Tommy Lee	<b>Configurations</b>	Ch. 1

Voltage vs. Frequency Stability

Voltage(V)	Measurement Frequency (MHz)
120	13.55993
102	13.55993
138	13.55993
Max. Deviation (MHz)	-0.000070
Max. Deviation (ppm)	-5.1622

Temperature vs. Frequency Stability

Temperature (°C)	Measurement Frequency (MHz)
-20	13.5599
-10	13.55993
0	13.55996
10	13.55995
20	13.55994
30	13.55993
40	13.55991
50	13.55987
Max. Deviation (MHz)	-0.000130
Max. Deviation (ppm)	-9.5870



## **3.6 Antenna Requirements**

### **3.6.1 Limit**

Except for special regulations, the Low-power Radio-frequency Devices must not be equipped with any jacket for installing an antenna with extension cable. An intentional radiator shall be designed to ensure that no antenna other than that furnished by the responsible party shall be used with the device. The use of a permanently attached antenna or of an antenna that uses a unique coupling to the intentional radiator shall be considered sufficient to comply with the provisions of this Section. The manufacturer may design the unit so that the user can replace a broken antenna, but the use of a standard antenna jack or electrical connector is prohibited.

### **3.6.2 Antenna Connector Construction**

Embedded in Antenna.

**4. LIST OF MEASURING EQUIPMENT**

Instrument	Manufacturer	Model No.	Serial No.	Characteristics	Calibration Date	Test Date	Due Date	Remark
Spectrum Analyzer	Rohde & Schwarz	FSP40	100055	9kHz~40GHz	Jun. 07, 2013	Aug. 04, 2013	Jun. 06, 2014	Conducted (TH02-HY)
Thermal Chamber	Ten Billion	TTH-D3SP	TBN-930701	N/A	Jul. 19, 2013	Aug. 04, 2013	Jul. 18, 2014	Conducted (TH02-HY)
EMI Test Receiver	Rohde & Schwarz	ESCS 30	100356	9kHz ~ 2.75GHz	Nov. 13, 2012	Jul. 19, 2013	Nov. 12, 2013	Conduction (CO05-HY)
Two-LISN (for auxiliary equipment)	Rohde & Schwarz	ENV216	100081	9kHz ~ 30MHz	Dec. 12, 2012	Jul. 19, 2013	Dec. 11, 2013	Conduction (CO05-HY)
Two-LISN	Rohde & Schwarz	ENV216	100080	9kHz ~ 30MHz	Dec. 06, 2012	Jul. 19, 2013	Dec. 05, 2013	Conduction (CO05-HY)
AC Power Source	APC	APC-1000W	N/A	N/A	N/A	Jul. 19, 2013	N/A	Conduction (CO05-HY)
EMI Test Receiver	Rohde & Schwarz	ESCI 7	100724	9kHz~7GHz	Sep. 03, 2012	Aug. 03, 2013	Sep. 02, 2013	Radiation (03CH07-HY)
Loop Antenna	Rohde & Schwarz	HFH2-Z2	860004/0001	9kHz~30MHz	Jul. 03, 2012	Aug. 03, 2013	Jul. 02, 2014	Radiation (03CH07-HY)
Bilog Antenna	Schaffner	CBL6111C	2726	30MHz~1GHz	Oct. 06, 2012	Aug. 03, 2013	Oct. 05, 2013	Radiation (03CH07-HY)
Preamplifier	COM-POWER	PA-103A	161241	30MHz~1GHz	Feb. 26, 2013	Aug. 03, 2013	Feb. 25, 2014	Radiation (03CH07-HY)
Turn Table	ChainTek	ChainTek 3000	N/A	0 ~ 360 degree	N/A	Aug. 03, 2013	N/A	Radiation (03CH07-HY)
Antenna Mast	ChainTek	ChainTek 3000	N/A	N/A	N/A	Aug. 03, 2013	N/A	Radiation (03CH07-HY)



## 5. TEST LOCATION

HWA YA	ADD : No. 52, Hwa Ya 1st Rd., Kwei-Shan Hsiang, Tao Yuan Hsien, Taiwan, R.O.C.
	TEL : 886-3-327-3456
	FAX : 886-3-318-0055



## 6. TAF CERTIFICATE OF ACCREDITATION



Certificate No. : L1190-130110

財團法人全國認證基金會  
Taiwan Accreditation Foundation

### Certificate of Accreditation

This is to certify that

**Sporton International Inc.**  
**EMC & Wireless Communications Laboratory**  
No.52, Hwa Ya 1st Rd., Hwa Ya Technology Park, Kwei-Shan Hsiang, Tao Yuan Hsien,  
Taiwan, R.O.C.

**is accredited in respect of laboratory**

<b>Accreditation Criteria</b>	: ISO/IEC 17025:2005
<b>Accreditation Number</b>	: 1190
<b>Originally Accredited</b>	: December 15, 2003
<b>Effective Period</b>	: January 10, 2013 to January 09, 2016
<b>Accredited Scope</b>	: Testing Field, see described in the Appendix
<b>Specific Accreditation Program</b>	: Accreditation Program for Designated Testing Laboratory for Commodities Inspection Accreditation Program for Telecommunication Equipment Testing Laboratory Accreditation Program for BSMI Mutual Recognition Arrangement with Foreign Authorities

  
Jay-San Chen  
President, Taiwan Accreditation Foundation  
Date: January 10, 2013

P1, total 20 pages

The Appendix forms an integral part of this Certificate, which shall be invalid when use without the Appendix

