



FCC RF Test Report

APPLICANT : LG Electronics Inc.
EQUIPMENT : Mobile Phone
BRAND NAME : LG
MODEL NAME : LG-D802, LG-D802T, LG-D802a
FCC ID : ZNFD802
STANDARD : FCC Part 15 Subpart C §15.247
CLASSIFICATION : (DSS) Spread Spectrum Transmitter

The product was received on Jun. 21, 2013 and completely tested on Jul. 10, 2013. We, SPORTON INTERNATIONAL INC., would like to declare that the tested sample has been evaluated in accordance with the procedures and shown the compliance with the applicable technical standards.

The test results in this report apply exclusively to the tested model / sample. Without written approval of SPORTON INTERNATIONAL INC., the test report shall not be reproduced except in full.

Reviewed by: Joseph Lin / Supervisor

Approved by: Jones Tsai / Manager



SPORTON INTERNATIONAL INC.

No. 52, Hwa Ya 1st Rd., Hwa Ya Technology Park, Kwei-Shan Hsiang, Tao Yuan Hsien, Taiwan, R.O.C.



TABLE OF CONTENTS

REVISION HISTORY 3

SUMMARY OF TEST RESULT 4

1 GENERAL DESCRIPTION..... 5

 1.1 Applicant 5

 1.2 Manufacturer..... 5

 1.3 Feature of Equipment Under Test 5

 1.4 Product Specification of Equipment Under Test..... 5

 1.5 Modification of EUT 6

 1.6 Testing Site..... 6

 1.7 Applied Standards 6

2 TEST CONFIGURATION OF EQUIPMENT UNDER TEST..... 7

 2.1 Descriptions of Test Mode 7

 2.2 Test Mode..... 8

 2.3 Connection Diagram of Test System..... 9

 2.4 Support Unit used in test configuration and system 10

 2.5 Description of RF Function Operation Test Setup..... 10

 2.6 Measurement Results Explanation Example..... 10

3 TEST RESULT 11

 3.1 Number of Channel Measurement 11

 3.2 Hopping Channel Separation Measurement 13

 3.3 Dwell Time Measurement..... 20

 3.4 20dB Bandwidth Measurement 23

 3.5 Peak Output Power Measurement 30

 3.6 Conducted Band Edges Measurement..... 32

 3.7 Conducted Spurious Emission Measurement 39

 3.8 Radiated Band Edges and Spurious Emission Measurement 49

 3.9 AC Conducted Emission Measurement..... 60

 3.10 Antenna Requirements..... 64

4 LIST OF MEASURING EQUIPMENT..... 65

5 UNCERTAINTY OF EVALUATION..... 66



REVISION HISTORY

REPORT NO.	VERSION	DESCRIPTION	ISSUED DATE
FR362142A	Rev. 01	Initial issue of report	Jul. 29, 2013



SUMMARY OF TEST RESULT

Report Section	FCC Rule	IC Rule	Description	Limit	Result	Remark
3.1	15.247(a)(1)	RSS-210 A8.4(2)	Number of Channels	≥ 15Chs	Pass	-
3.2	15.247(a)(1)	RSS-210 A8.1(b)	Hopping Channel Separation	≥ 2/3 of 20dB BW	Pass	-
3.3	15.247(a)(1)	RSS-210 A8.1(d)	Dwell Time of Each Channel	≤ 0.4sec in 31.6sec period	Pass	-
3.4	15.247(a)(1)	RSS-210 A8.1(a)	20dB Bandwidth	NA	Pass	-
3.5	15.247(b)(1)	RSS-210 A8.1(b)	Peak Output Power	≤ 1 W for 1Mbps ≤ 125 mW for 2, 3Mbps	Pass	-
3.6	15.247(d)	RSS-210 A8.5	Conducted Band Edges	≤ 20dBc	Pass	-
3.7	15.247(d)	RSS-210 A8.5	Conducted Spurious Emission	≤ 20dBc	Pass	-
3.8	15.247(d)	RSS-210 A8.5	Radiated Band Edges and Radiated Spurious Emission	15.209(a) & 15.247(d)	Pass	Under limit 9.67 dB at 35.940 MHz
3.9	15.207	RSS-Gen 7.2.4	AC Conducted Emission	15.207(a)	Pass	Under limit 13.60 dB at 0.440 MHz
3.10	15.203 & 15.247(b)	RSS-210 A8.4	Antenna Requirement	N/A	Pass	-

1 General Description

1.1 Applicant

LG Electronics Inc.

60-39, Kasan-dong, Kumchon-gu, Seoul 135-801, Korea

1.2 Manufacturer

LG Electronics Inc.

60-39, Kasan-dong, Kumchon-gu, Seoul 135-801, Korea

1.3 Feature of Equipment Under Test

Product Feature	
Equipment	Mobile Phone
Brand Name	LG
Model Name	LG-D802, LG-D802T, LG-D802a
FCC ID	ZNFD802
EUT supports Radios application	GSM/EGPRS/WCDMA/HSPA/LTE/ WLAN 2.4GHz 802.11b/g/n/ac, WLAN 5GHz 802.11a/n/ac/ Bluetooth 3.0/4.0+LE/NFC
HW Version	Rev.d
SW Version	D80207a
EUT Stage	Production Unit

Remark: The above EUT's information was declared by manufacturer. Please refer to the specifications or user's manual for more detailed description.

1.4 Product Specification of Equipment Under Test

Product Specification subjective to this standard	
Tx/Rx Frequency Range	2402 MHz ~ 2480 MHz
Number of Channels	79
Carrier Frequency of Each Channel	2402+n*1 MHz; n=0~78
Maximum Output Power to Antenna	Bluetooth BR(1Mbps) : 8.80 dBm (0.0076 W) Bluetooth EDR (2Mbps) : 8.13 dBm (0.0065 W) Bluetooth EDR (3Mbps) : 8.49 dBm (0.0071 W)
Antenna Type	PIFA Antenna type with gain -1.99 dBi
Type of Modulation	Bluetooth 3.0 BR (1Mbps) : GFSK Bluetooth 3.0 EDR (2Mbps) : π /4-DQPSK Bluetooth 3.0 EDR (3Mbps) : 8-DPSK

1.5 Modification of EUT

No modifications are made to the EUT during all test items.

1.6 Testing Site

Test Site	SPORTON INTERNATIONAL INC.			
Test Site Location	No. 52, Hwa Ya 1 st Rd., Hwa Ya Technology Park, Kwei-Shan Hsiang, Tao Yuan Hsien, Taiwan, R.O.C. TEL: +886-3-3273456 / FAX: +886-3-3284978			
Test Site No.	Sporton Site No.			FCC/IC Registration No.
	TH02-HY	CO05-HY	03CH06-HY	722060/4086B-1

Note: The test site complies with ANSI C63.4 2003 requirement.

1.7 Applied Standards

According to the specifications of the manufacturer, the EUT must comply with the requirements of the following standards:

- FCC Part 15 Subpart C §15.247
- FCC Public Notice DA 00-705
- ANSI C63.10-2009

Remark:

1. All test items were verified and recorded according to the standards and without any deviation during the test.
2. This EUT has also been tested and complied with the requirements of FCC Part 15, Subpart B, recorded in a separate test report.

For Bluetooth modes operating under the 15.247 and RSS 210 rules for frequency hopping systems the device complies with the Bluetooth specifications to ensure compliance with 15.247 (a) (1), (g) and (h) with respect to the pseudo random hopping sequence, receiver bandwidth, receiver hopping synchronously with the transmitter, and equal use of all channels (for both continuous and short burst transmissions)

2 Test Configuration of Equipment Under Test

2.1 Descriptions of Test Mode

Preliminary tests were performed in different data rates and recorded the RF output power in the following table:

Channel	Frequency	Bluetooth RF Output Power		
		Data Rate / Modulation		
		GFSK	$\pi/4$ -DQPSK	8-DPSK
		1Mbps	2Mbps	3Mbps
Ch00	2402MHz	8.00 dBm	7.40 dBm	7.69 dBm
Ch39	2441MHz	8.33 dBm	7.82 dBm	7.93 dBm
Ch78	2480MHz	8.80 dBm	8.13 dBm	8.49 dBm

Remark:

1. All the test data for each data rate were verified, but only the worst case was reported.
 2. The data rate was set in 1Mbps for all the test items due to the highest RF output power.
- a. The EUT has been associated with peripherals pursuant to ANSI C63.10-2009 and configuration operated in a manner tended to maximize its emission characteristics in a typical application. Frequency range investigated: conduction (150 kHz to 30 MHz), radiation (9 kHz to the 10th harmonic of the highest fundamental frequency or to 40 GHz, whichever is lower). Pre-scanned tests, X, Y, Z in three orthogonal panels, and different data rates were conducted to determine the final configuration (X plane as worst plane) from all possible combinations, and the worst mode of radiated spurious emissions is Bluetooth 1Mbps mode, and recorded in this report.
 - b. AC power line Conducted Emission was tested under maximum output power.

2.2 Test Mode

The following summary table is showing all test modes to demonstrate in compliance with the standard.

Summary table of Test Cases			
Test Item	Data Rate / Modulation		
	Bluetooth BR 1Mbps GFSK	Bluetooth EDR 2Mbps $\pi/4$ -DQPSK	Bluetooth EDR 3Mbps 8-DPSK
Conducted Test Cases	Mode 1: CH00_2402 MHz Mode 2: CH39_2441 MHz Mode 3: CH78_2480 MHz	Mode 4: CH00_2402 MHz Mode 5: CH39_2441 MHz Mode 6: CH78_2480 MHz	Mode 7: CH00_2402 MHz Mode 8: CH39_2441 MHz Mode 9: CH78_2480 MHz
Radiated Test Cases	Bluetooth BR 1Mbps GFSK Mode 1: CH00_2402 MHz Mode 2: CH39_2441 MHz Mode 3: CH78_2480 MHz		
AC Conducted Emission	Mode 1 :GSM850 Idle + Bluetooth Link + WLAN (2.4GHz) Link + USB Cable (Charging from Adapter) + Earphone + MP3		
Remark: For radiated test cases, the worst mode data rate 1Mbps was reported only, because this data rate has the highest RF output power at preliminary tests.			

2.3 Connection Diagram of Test System

<Bluetooth Tx Mode>

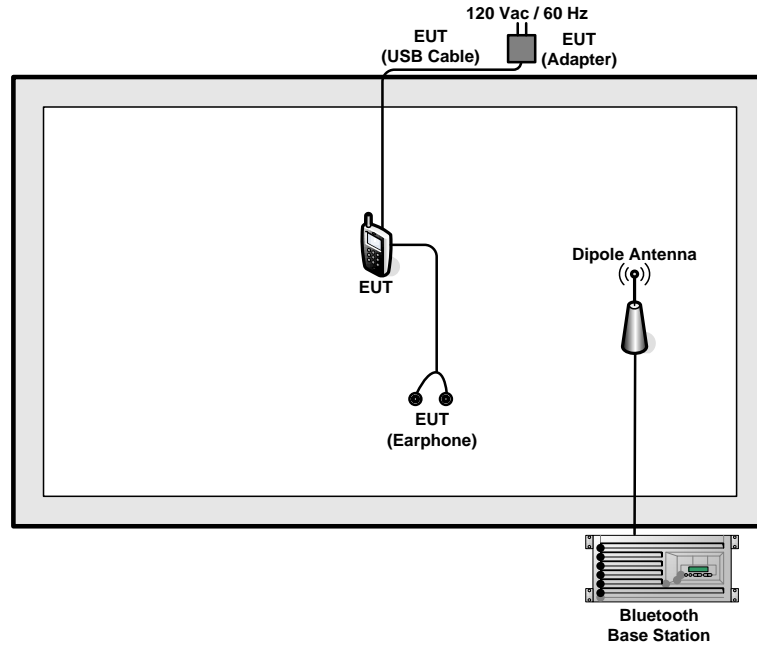

<AC Conducted Emission Mode>

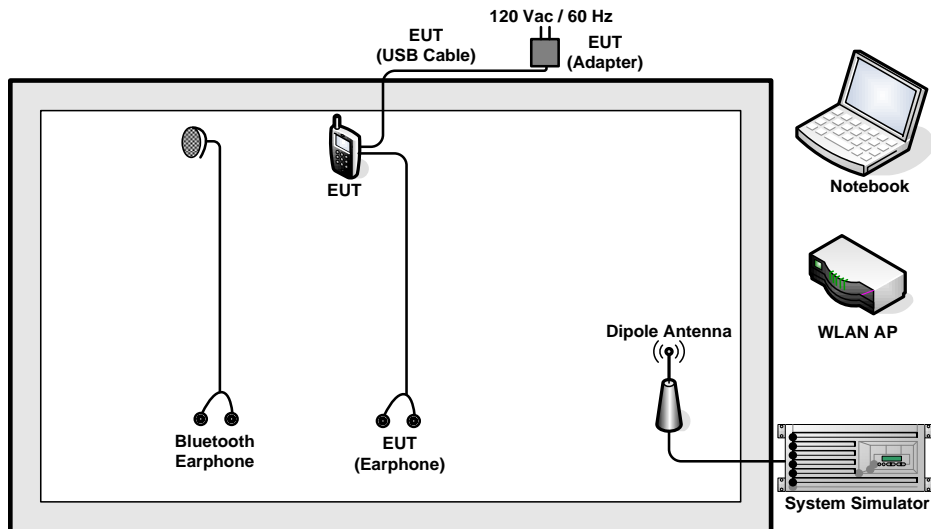

2.4 Support Unit used in test configuration and system

Item	Equipment	Trade Name	Model Name	FCC ID	Data Cable	Power Cord
1.	Base Station	R&S	CBT32	N/A	N/A	Unshielded, 1.8 m
2.	System Simulator	R&S	CMU 200	N/A	N/A	Unshielded, 1.8 m
3.	WLAN AP	D-Link	DIR-628	KA2DIR628A2	N/A	Unshielded, 1.8 m
4.	Notebook	DELL	Latitude E6320	FCC DoC	N/A	AC I/P: Unshielded, 1.2 m DC O/P: Shielded, 1.8 m
5.	Bluetooth Earphone	SonyEricsson	MW600	PY700A2029	N/A	N/A

2.5 Description of RF Function Operation Test Setup

For WLAN RF test items, an engineering test program (SW D80206d) was provided and enabled to make the EUT provides functions like channel selection and power level for continuous transmitting and receiving signals.

2.6 Measurement Results Explanation Example

For all conducted test items:

The offset level is set in the spectrum analyzer to compensate the RF cable loss and attenuator factor between EUT conducted output port and spectrum analyzer. With the offset compensation, the spectrum analyzer reading level is exactly the EUT RF output level.

Example:

The spectrum analyzer offset is derived from RF cable loss and attenuator factor.

Offset = RF cable loss + attenuator factor.

Following shows an offset computation example with cable loss 4.2 dB and 10dB attenuator.

$$\begin{aligned}
 \text{Offset(dB)} &= \text{RF cable loss(dB)} + \text{attenuator factor(dB)}. \\
 &= 4.2 + 10 = 14.2 \text{ (dB)}
 \end{aligned}$$

3 Test Result

3.1 Number of Channel Measurement

3.1.1 Limits of Number of Hopping Frequency

Frequency hopping systems in the 2400-2483.5 MHz band shall use at least 15 channels.

3.1.2 Measuring Instruments

See list of measuring instruments of this test report.

3.1.3 Test Procedure

1. The testing follows FCC Public Notice DA 00-705 Measurement Guidelines.
2. The RF output of EUT was connected to the spectrum analyzer by RF cable and attenuator. The path loss was compensated to the results for each measurement.
3. Set to the maximum power setting and enable the EUT transmit continuously.
4. Enable the EUT hopping function.
5. Use the following spectrum analyzer settings: Span = the frequency band of operation; RBW \geq 1% of the span; VBW \geq RBW; Sweep = auto; Detector function = peak; Trace = max hold.
6. The number of hopping frequency used is defined as the number of total channel.
7. Record the measurement data derived from spectrum analyzer.

3.1.4 Test Setup

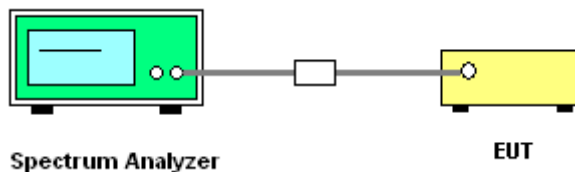

3.1.5 Test Result of Number of Hopping Frequency

Test Mode :	1Mbps	Temperature :	24~26°C
Test Engineer :	Bill Kuo	Relative Humidity :	50~53%

Number of Hopping (Channel)	Adaptive Frequency Hopping (Channel)	Limits (Channel)	Pass/Fail
79	20	> 15	Pass



Number of Hopping Channel Plot on Channel 00 - 78

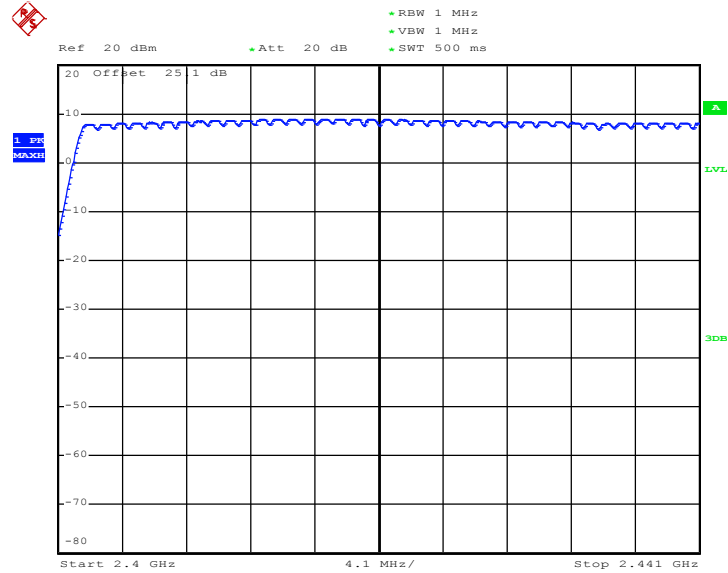

Date: 1.JUL.2013 22:08:30

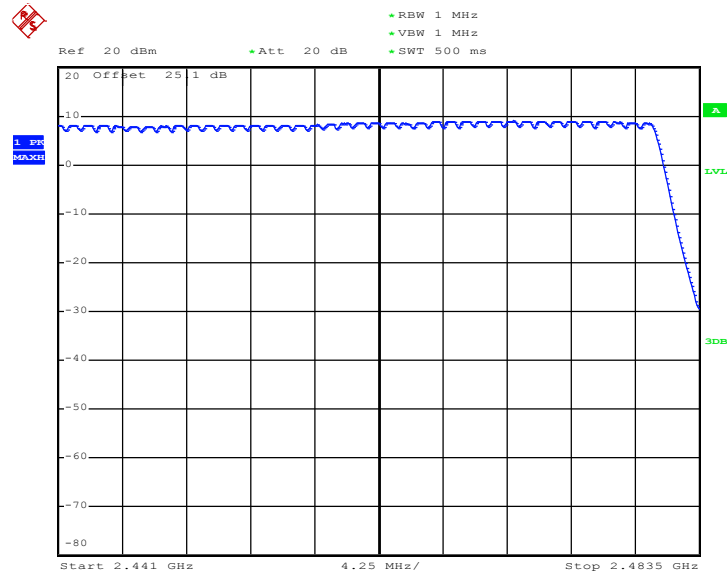

Date: 1.JUL.2013 22:13:08

3.2 Hopping Channel Separation Measurement

3.2.1 Limit of Hopping Channel Separation

Frequency hopping systems operating in the 2400-2483.5 MHz band may have hopping channel carrier frequencies that are separated by 25 kHz or two-thirds of the 20 dB bandwidth of the hopping channel, whichever is greater.

3.2.2 Measuring Instruments

See list of measuring instruments of this test report.

3.2.3 Test Procedures

1. The testing follows FCC Public Notice DA 00-705 Measurement Guidelines.
2. The RF output of EUT was connected to the spectrum analyzer by RF cable and attenuator. The path loss was compensated to the results for each measurement.
3. Set to the maximum power setting and enable the EUT transmit continuously.
4. Enable the EUT hopping function.
5. Use the following spectrum analyzer settings:
Span = wide enough to capture the peaks of two adjacent channels; $RBW \geq 1\%$ of the span;
 $VBW \geq RBW$; Sweep = auto; Detector function = peak; Trace = max hold.
6. Measure and record the results in the test report.

3.2.4 Test Setup

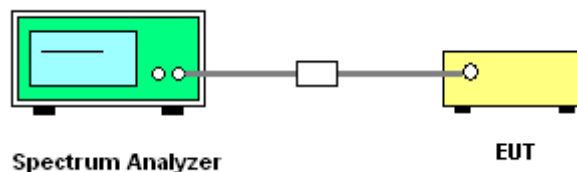



3.2.5 Test Result of Hopping Channel Separation

Test Mode :	1Mbps	Temperature :	24~26°C
Test Engineer :	Bill Kuo	Relative Humidity :	50~53%

Channel	Frequency (MHz)	Frequency Separation (MHz)	(2/3 of 20dB BW) Limits (MHz)	Pass/Fail
00	2402	1.002	0.6240	Pass
39	2441	1.002	0.6027	Pass
78	2480	1.008	0.6133	Pass

Channel Separation Plot on Channel 00 - 01

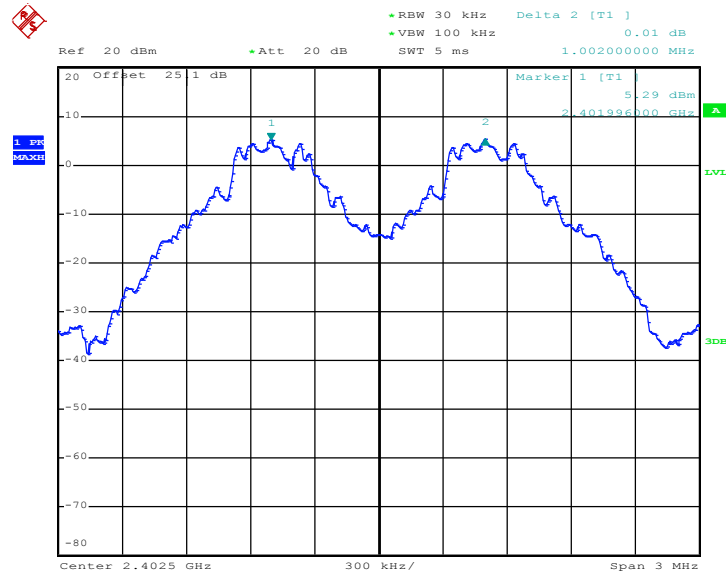

Date: 1.JUL.2013 20:43:31



Channel Separation Plot on Channel 39 - 40

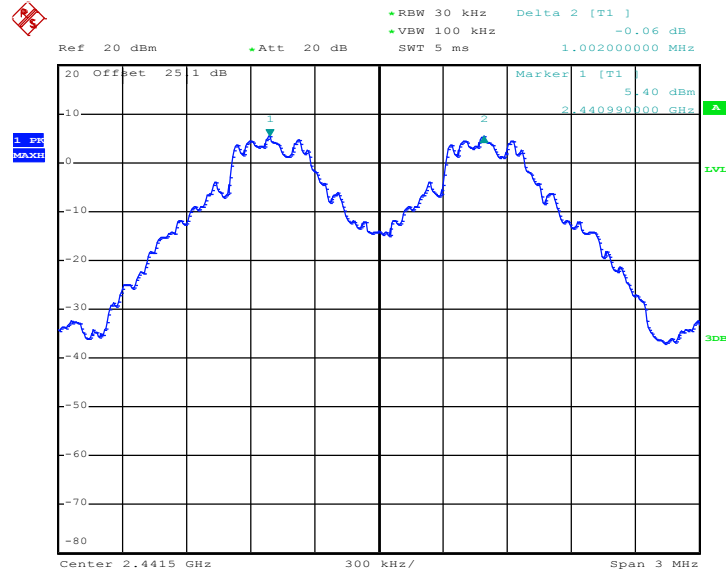

Date: 1.JUL.2013 20:44:18

Channel Separation Plot on Channel 77 - 78

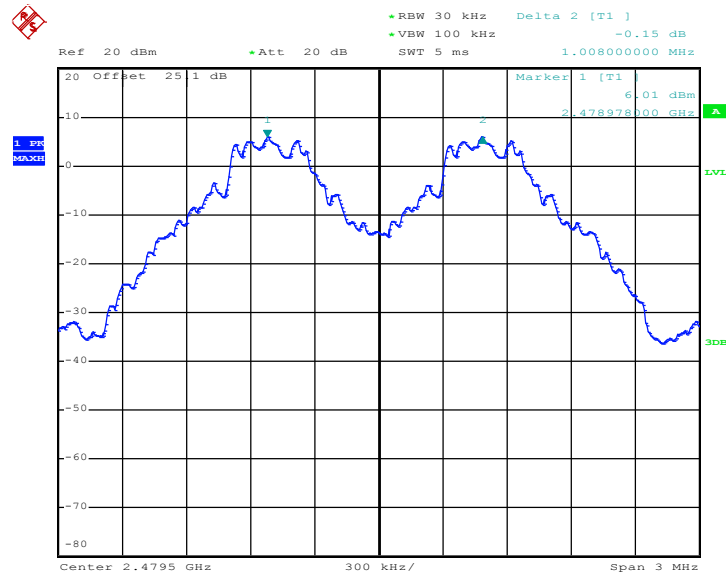

Date: 1.JUL.2013 20:45:09



Test Mode :	2Mbps	Temperature :	24~26°C
Test Engineer :	Bill Kuo	Relative Humidity :	50~53%

Channel	Frequency (MHz)	Frequency Separation (MHz)	(2/3 of 20dB BW) Limits (MHz)	Pass/Fail
00	2402	1.002	0.9040	Pass
39	2441	1.002	0.9040	Pass
78	2480	1.008	0.9040	Pass

Channel Separation Plot on Channel 00 - 01

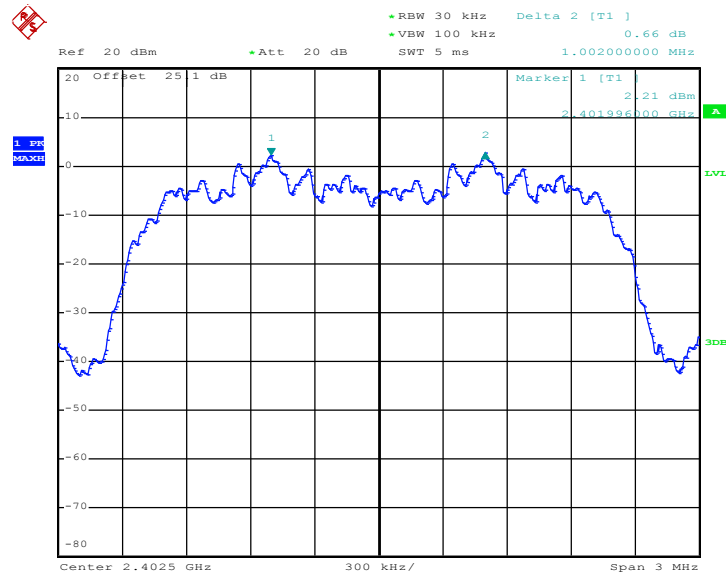

Date: 1.JUL.2013 20:50:39



Channel Separation Plot on Channel 39 - 40

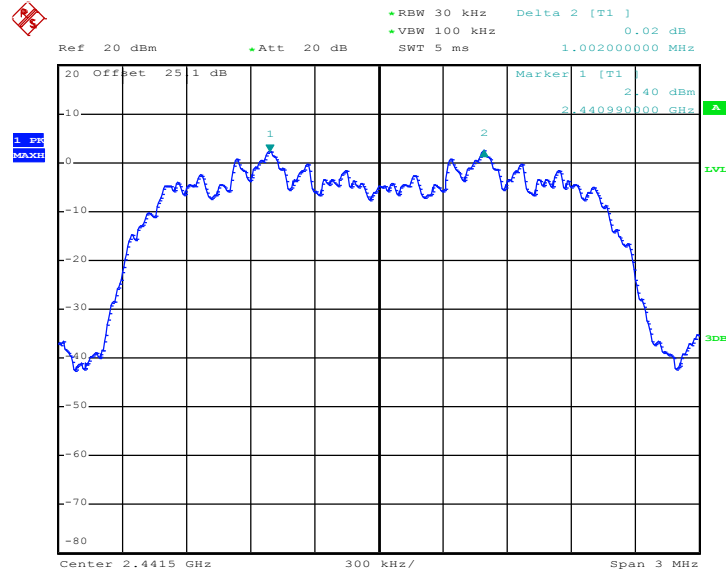

Date: 1.JUL.2013 20:52:26

Channel Separation Plot on Channel 77 - 78

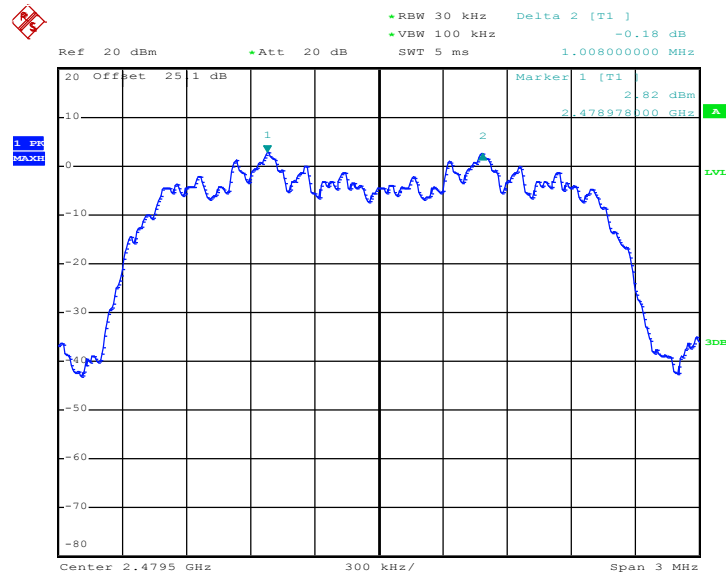

Date: 1.JUL.2013 20:53:57



Test Mode :	3Mbps	Temperature :	24~26°C
Test Engineer :	Bill Kuo	Relative Humidity :	50~53%

Channel	Frequency (MHz)	Frequency Separation (MHz)	(2/3 of 20dB BW) Limits (MHz)	Pass/Fail
00	2402	1.002	0.8960	Pass
39	2441	1.008	0.8960	Pass
78	2480	1.002	0.8960	Pass

Channel Separation Plot on Channel 00 - 01

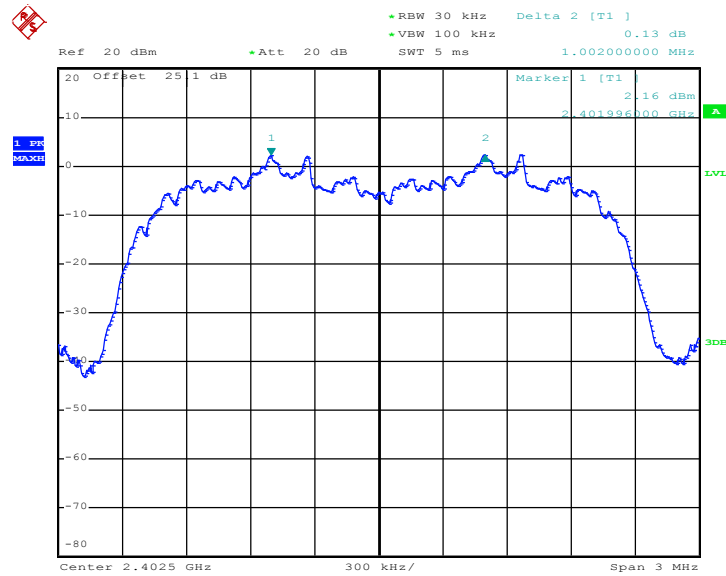

Date: 1.JUL.2013 21:04:36



Channel Separation Plot on Channel 39 - 40

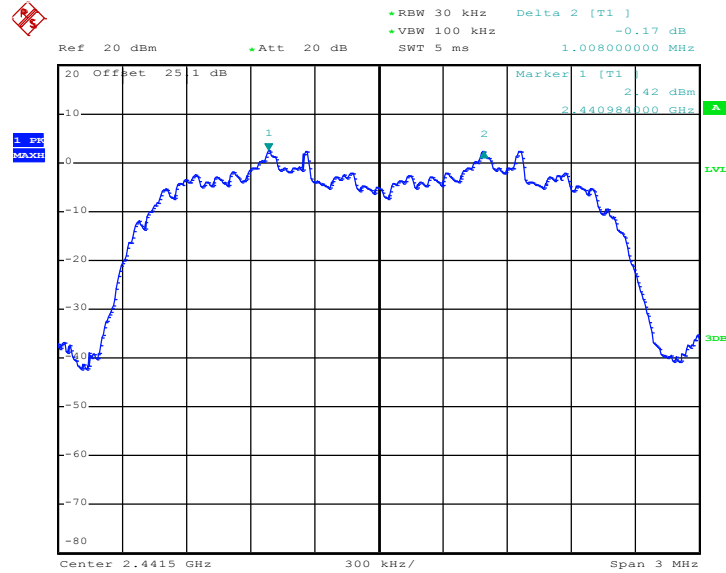

Date: 1.JUL.2013 21:02:39

Channel Separation Plot on Channel 77 - 78

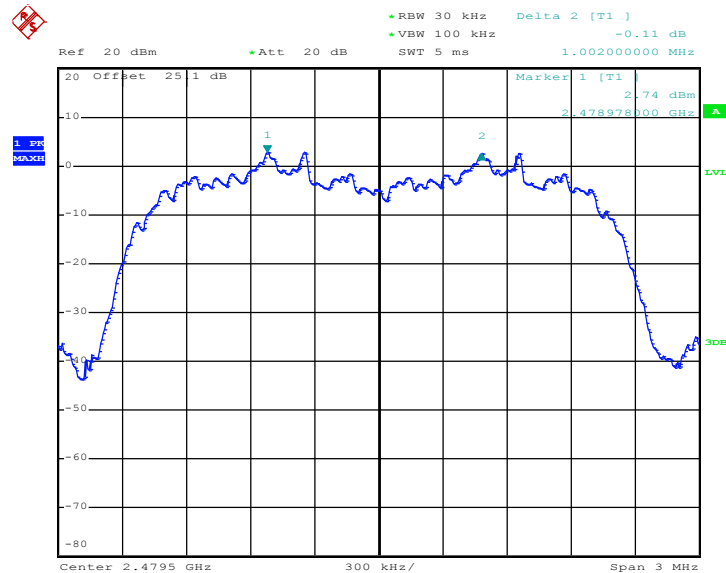

Date: 1.JUL.2013 21:00:51

3.3 Dwell Time Measurement

3.3.1 Limit of Dwell Time

The average time of occupancy on any channel shall not be greater than 0.4 seconds within a period of 0.4 seconds multiplied by the number of hopping channels employed.

3.3.2 Measuring Instruments

See list of measuring instruments of this test report.

3.3.3 Test Procedures

1. The testing follows FCC Public Notice DA 00-705 Measurement Guidelines.
2. The RF output of EUT was connected to the spectrum analyzer by RF cable and attenuator. The path loss was compensated to the results for each measurement.
3. Set to the maximum power setting and enable the EUT transmit continuously.
4. Enable the EUT hopping function.
5. Use the following spectrum analyzer settings: Span = zero span, centered on a hopping channel; RBW = 1 MHz; VBW \geq RBW; Sweep = as necessary to capture the entire dwell time per hopping channel; Detector function = peak; Trace = max hold.
6. Measure and record the results in the test report.

3.3.4 Test Setup

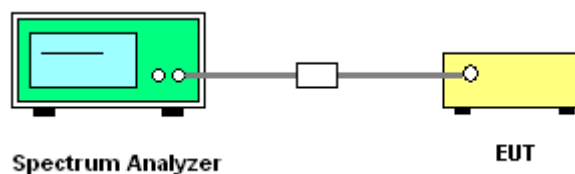



3.3.5 Test Result of Dwell Time

Test Mode :	DH5	Temperature :	24~26°C
Test Engineer :	Bill Kuo	Relative Humidity :	50~53%

Mode	Hopping Channel Number	Hops Over Occupancy Time(hops)	Package Transfer Time (msec)	Dwell Time (sec)	Limits (sec)	Pass/Fail
Normal	79	106.67	2.91	0.31	0.4	Pass
AFH	20	53.34	2.91	0.16	0.4	Pass

Remark:

1. In normal mode, hopping rate is 1600hops/s with 6 slots in 79 hopping channels.
With channel hopping rate (1600 / 6 / 79) in Occupancy Time Limit (0.4 x 79) (s),
Hops Over Occupancy Time comes to (1600 / 6 / 79) x (0.4 x 79) = 106.67 hops.
2. In AFH mode, hopping rate is 800hops/s with 6 slots in 20 hopping channels.
With channel hopping rate (800 / 6 / 20) in Occupancy Time Limit (0.4 x 20) (s),
Hops Over Occupancy Time comes to (800 / 6 / 20) x (0.4 x 20) = 53.33 hops.
3. Dwell Time(s) = Hops Over Occupancy Time (hops) x Package Transfer Time



Package Transfer Time Plot

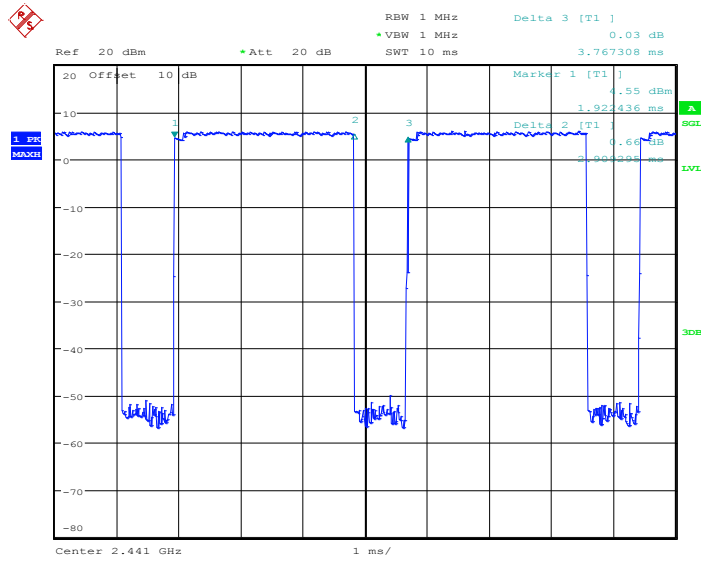

Date: 10.JUL.2013 16:55:36

3.4 20dB Bandwidth Measurement

3.4.1 Limit of 20dB Bandwidth

Reporting only

3.4.2 Measuring Instruments

See list of measuring instruments of this test report.

3.4.3 Test Procedures

1. The testing follows FCC Public Notice DA 00-705 Measurement Guidelines.
2. The RF output of EUT was connected to the spectrum analyzer by RF cable and attenuator. The path loss was compensated to the results for each measurement.
3. Set to the maximum power setting and enable the EUT transmit continuously.
4. Use the following spectrum analyzer settings for 20dB Bandwidth measurement.
Span = approximately 2 to 3 times the 20 dB bandwidth, centered on a hopping channel;
RBW \geq 1% of the 20 dB bandwidth; VBW \geq RBW; Sweep = auto; Detector function = peak;
Trace = max hold.
5. Measure and record the results in the test report.

3.4.4 Test Setup

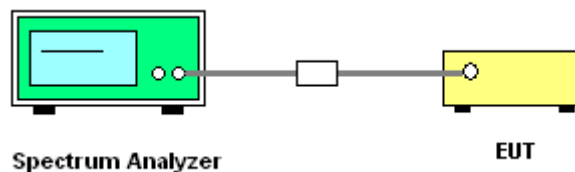



3.4.5 Test Result of 20dB Bandwidth

Test Mode :	1Mbps	Temperature :	24~26°C
Test Engineer :	Bill Kuo	Relative Humidity :	50~53%

Channel	Frequency (MHz)	20dB Bandwidth (MHz)
00	2402	0.936
39	2441	0.904
78	2480	0.920

20 dB Bandwidth Plot on Channel 00

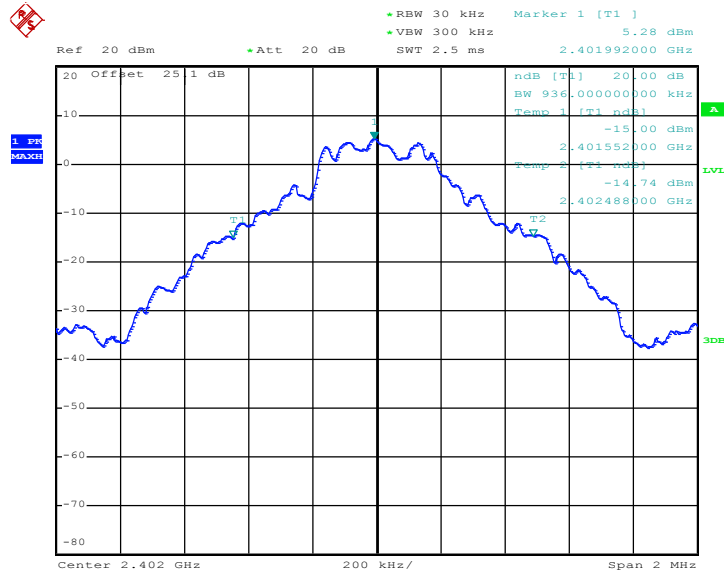

Date: 1.JUL.2013 21:05:17



20 dB Bandwidth Plot on Channel 39

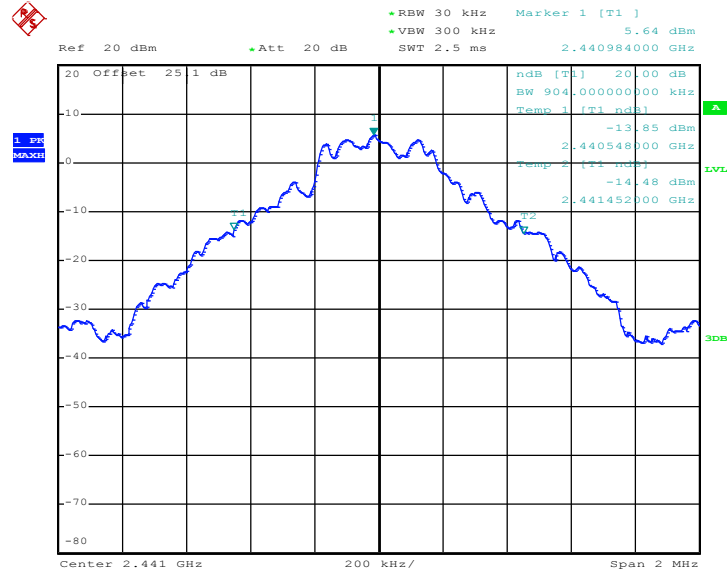

Date: 1.JUL.2013 21:05:43

20 dB Bandwidth Plot on Channel 78

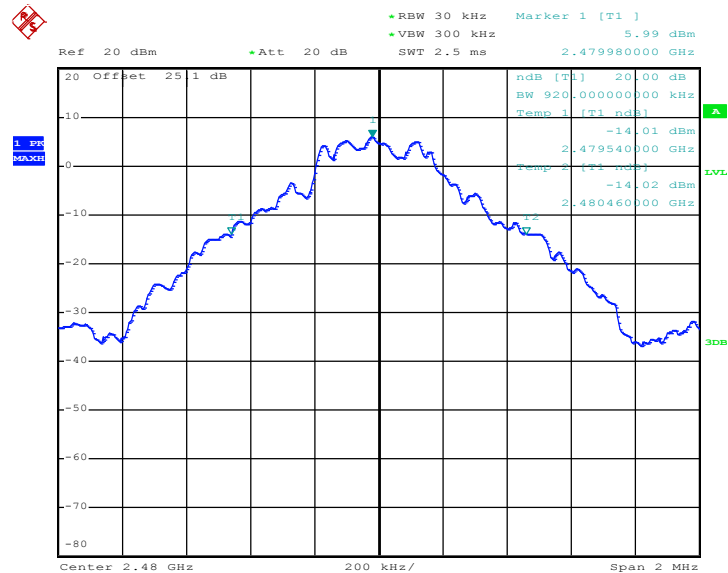

Date: 1.JUL.2013 21:06:12



Test Mode :	2Mbps	Temperature :	24~26°C
Test Engineer :	Bill Kuo	Relative Humidity :	50~53%

Channel	Frequency (MHz)	20dB Bandwidth (MHz)
00	2402	1.356
39	2441	1.356
78	2480	1.356

20 dB Bandwidth Plot on Channel 00

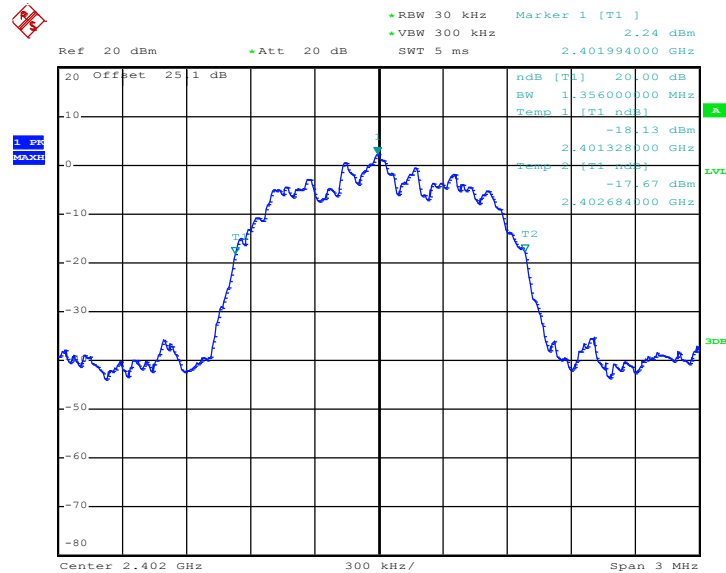

Date: 1.JUL.2013 21:06:42



20 dB Bandwidth Plot on Channel 39

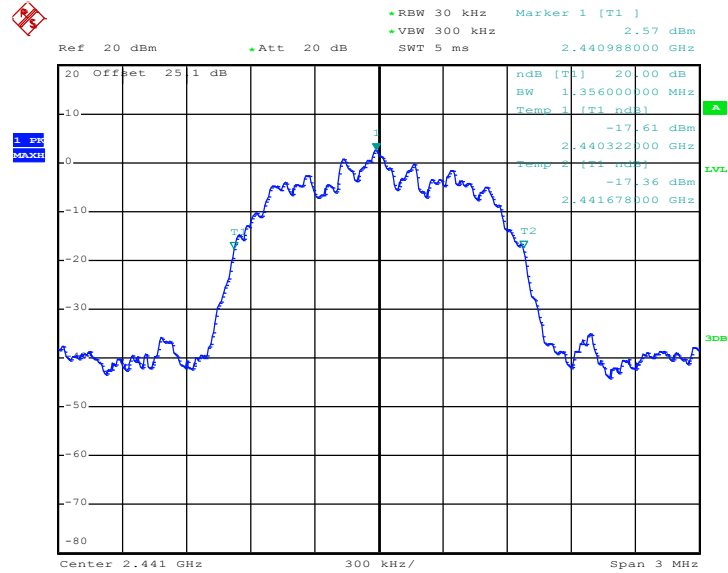

Date: 1.JUL.2013 21:07:44

20 dB Bandwidth Plot on Channel 78

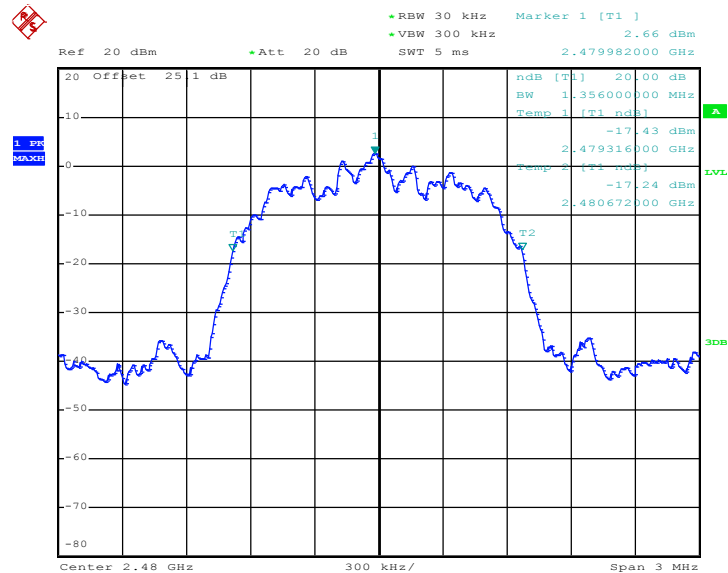

Date: 1.JUL.2013 21:08:17



Test Mode :	3Mbps	Temperature :	24~26°C
Test Engineer :	Bill Kuo	Relative Humidity :	50~53%

Channel	Frequency (MHz)	20dB Bandwidth (MHz)
00	2402	1.344
39	2441	1.344
78	2480	1.344

20 dB Bandwidth Plot on Channel 00

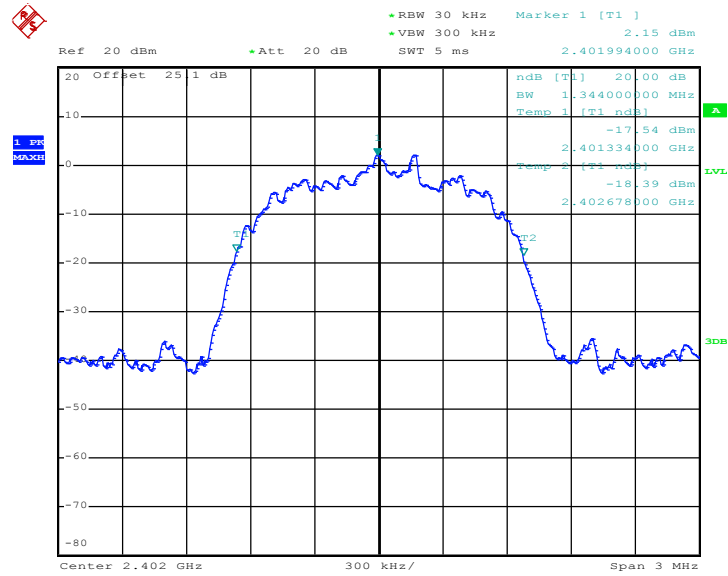

Date: 1.JUL.2013 21:08:47



20 dB Bandwidth Plot on Channel 39

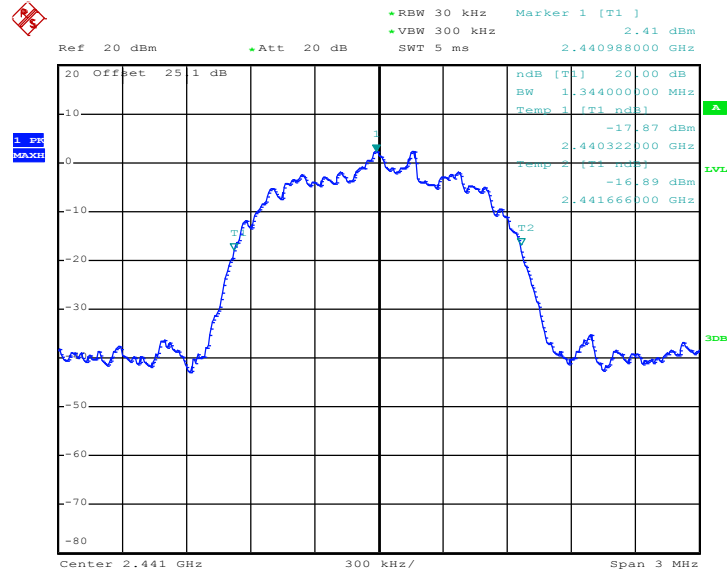

Date: 1.JUL.2013 21:16:24

20 dB Bandwidth Plot on Channel 78

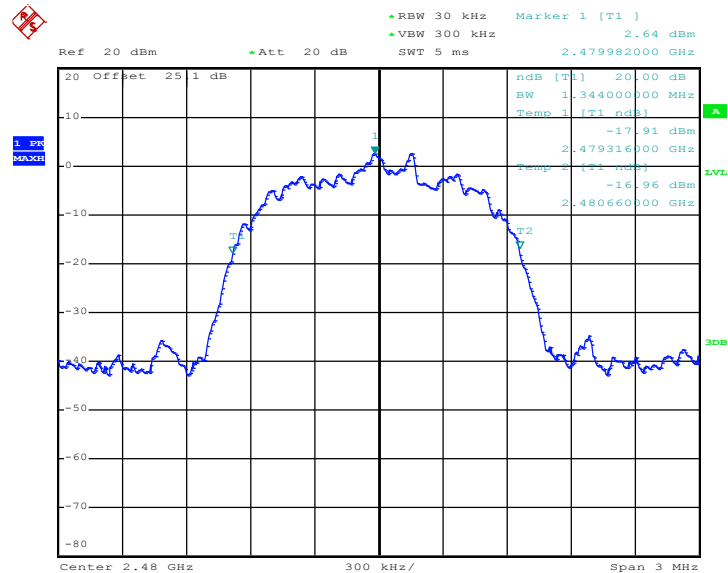

Date: 1.JUL.2013 21:09:56

3.5 Peak Output Power Measurement

3.5.1 Limit of Peak Output Power

Section 15.247 (b) The maximum peak conducted output power of the intentional radiator shall not exceed the following: (1) For frequency hopping systems operating in the 2400-2483.5 MHz band employing at least 75 non-overlapping hopping channels, and all frequency hopping systems in the 5725-5850 MHz band: 1 watt. For all other frequency hopping systems in the 2400-2483.5 MHz band 0.125 watts. The power limit for 1Mbps is 1watt, and for 2Mbps, 3Mbps and AFH are 0.125 watts.

3.5.2 Measuring Instruments

See list of measuring instruments of this test report.

3.5.3 Test Procedures

1. The testing follows FCC Public Notice DA 00-705 Measurement Guidelines.
2. The RF output of EUT was connected to the power meter by RF cable and attenuator. The path loss was compensated to the results for each measurement.
3. Set to the maximum power setting and enable the EUT transmit continuously.
4. Measure the conducted output power with cable loss and record the results in the test report.
5. Measure and record the results in the test report.

3.5.4 Test Setup

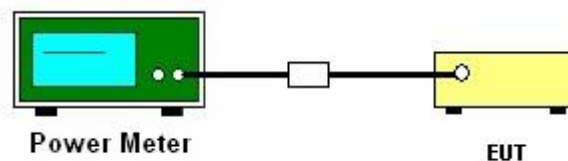



3.5.5 Test Result of Peak Output Power

Test Mode :	1Mbps	Temperature :	24~26°C
Test Engineer :	Bill Kuo	Relative Humidity :	50~53%

Channel	Frequency (MHz)	RF Power (dBm)		
		GFSK	Max. Limits (dBm)	Pass/Fail
		1 Mbps		
00	2402	8.00	20.97	Pass
39	2441	8.33	20.97	Pass
78	2480	8.80	20.97	Pass

Note: For AFH mode using 20 hopping channels, the maximum output power limit is 20.97dBm.

Test Mode :	2Mbps	Temperature :	24~26°C
Test Engineer :	Bill Kuo	Relative Humidity :	50~53%

Channel	Frequency (MHz)	RF Power (dBm)		
		$\pi/4$ -DQPSK	Max. Limits (dBm)	Pass/Fail
		2 Mbps		
00	2402	7.40	20.97	Pass
39	2441	7.82	20.97	Pass
78	2480	8.13	20.97	Pass

Test Mode :	3Mbps	Temperature :	24~26°C
Test Engineer :	Bill Kuo	Relative Humidity :	50~53%

Channel	Frequency (MHz)	RF Power (dBm)		
		8-DPSK	Max. Limits (dBm)	Pass/Fail
		3 Mbps		
00	2402	7.69	20.97	Pass
39	2441	7.93	20.97	Pass
78	2480	8.49	20.97	Pass

3.6 Conducted Band Edges Measurement

3.6.1 Limit of Band Edges

In any 100 kHz bandwidth outside the intentional radiation frequency band, the radio frequency power shall be at least 20 dB below the highest level of the radiated power. In addition, radiated emissions which fall in the restricted bands must also comply with the radiated emission limits.

3.6.2 Measuring Instruments

See list of measuring instruments of this test report.

3.6.3 Test Procedures

1. The testing follows the guidelines in Band-edge Compliance of RF Conducted Emissions of FCC Public Notice DA 00-705 Measurement Guidelines.
2. Set to the maximum power setting and enable the EUT transmit continuously.
3. Set RBW = 300kHz ($\geq 1\%$ span=30MHz), VBW = 300kHz (\geq RBW). Band edge emissions must be at least 20 dB down from the highest emission level within the authorized band as measured with a 300kHz RBW. The attenuation shall be 30 dB instead of 20 dB when RMS conducted output power procedure is used.
4. Enable hopping function of the EUT and then repeat step 2. and 3.
5. Measure and record the results in the test report.

3.6.4 Test Setup

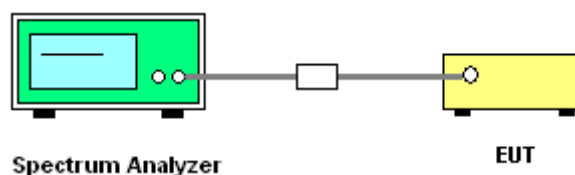



3.6.6 Test Result of Conducted Band Edges

Test Mode :	1Mbps	Temperature :	24~26°C
Test Channel :	00 and 78	Relative Humidity :	50~53%
		Test Engineer :	Bill Kuo

Low Band Edge Plot on Channel 00

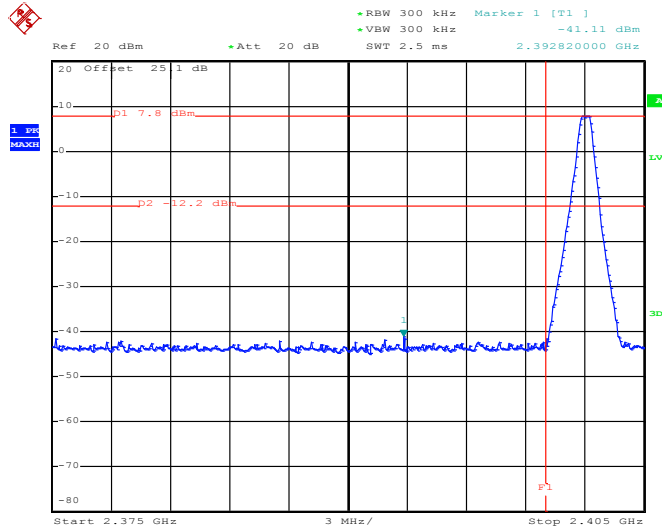

Date: 1.JUL.2013 21:10:49

High Band Edge Plot on Channel 78

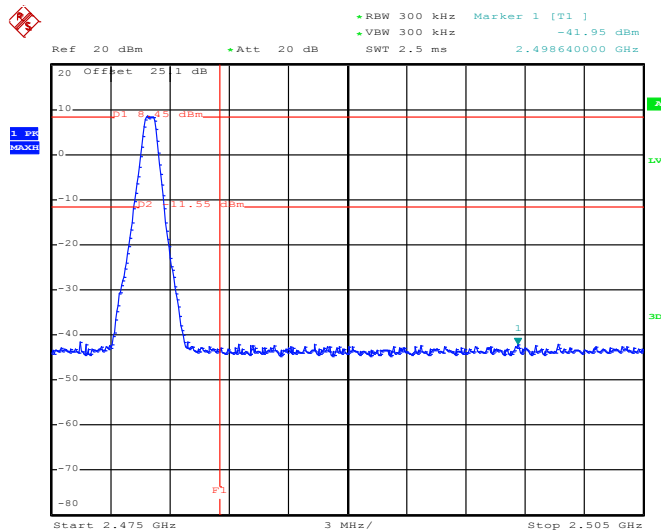

Date: 1.JUL.2013 21:11:52



Test Mode :	2Mbps	Temperature :	24~26°C
Test Channel :	00 and 78	Relative Humidity :	50~53%
		Test Engineer :	Bill Kuo

Low Band Edge Plot on Channel 00

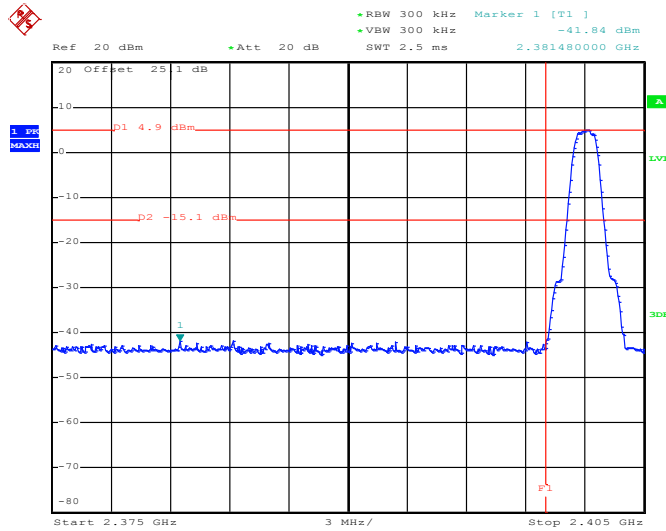

Date: 1.JUL.2013 21:12:44

High Band Edge Plot on Channel 78

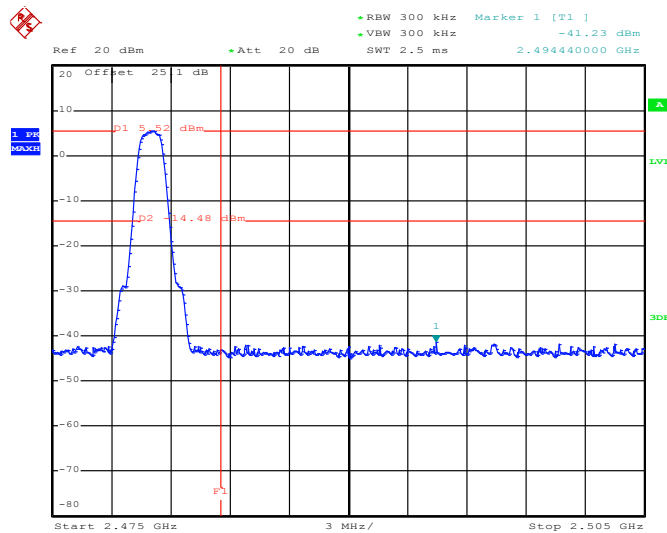

Date: 1.JUL.2013 21:13:47



Test Mode :	3Mbps	Temperature :	24~26°C
Test Channel :	00 and 78	Relative Humidity :	50~53%
		Test Engineer :	Bill Kuo

Low Band Edge Plot on Channel 00

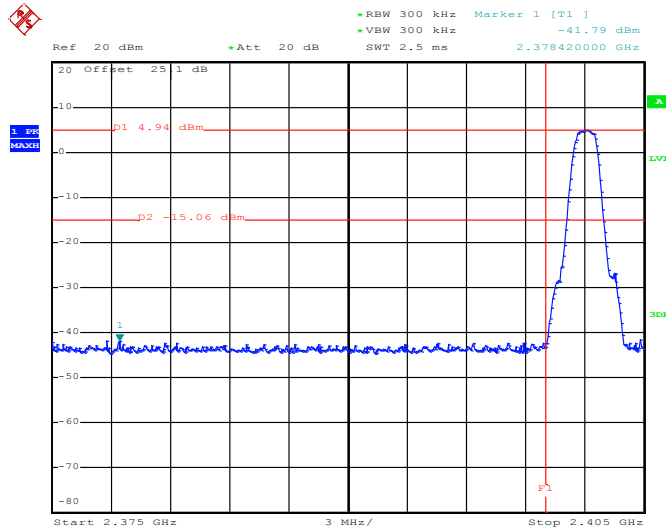

Date: 1.JUL.2013 21:14:39

High Band Edge Plot on Channel 78

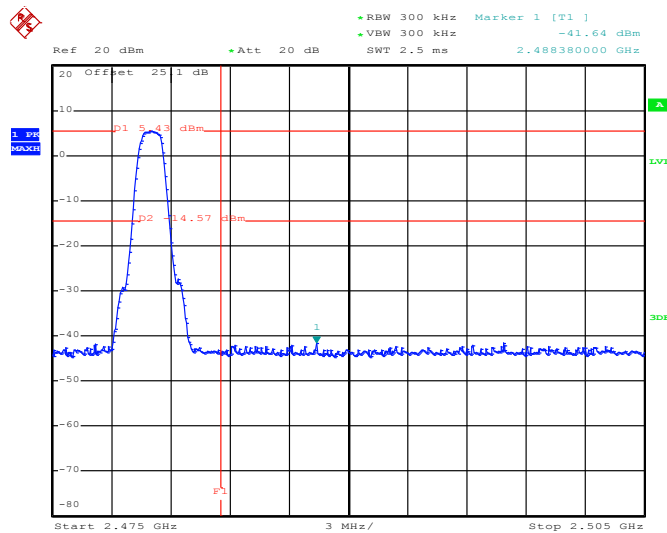

Date: 1.JUL.2013 21:15:42

3.6.7 Test Result of Conducted Hopping Mode Band Edges

Test Mode :	1Mbps	Temperature :	24~26°C
Test Engineer :	Bill Kuo	Relative Humidity :	50~53%

1Mbps Hopping Mode Low Band Edge Plot

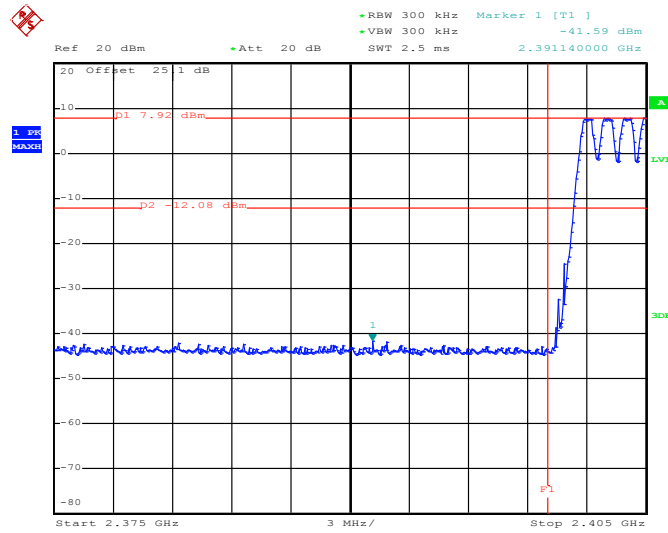

Date: 1.JUL.2013 22:26:41

1Mbps Hopping Mode High Band Edge Plot

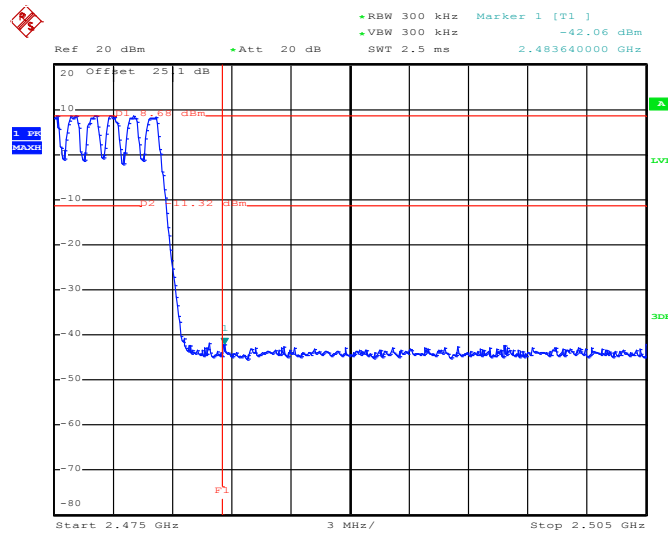

Date: 1.JUL.2013 22:27:27



Test Mode :	2Mbps	Temperature :	24~26°C
Test Engineer :	Bill Kuo	Relative Humidity :	50~53%

2Mbps Hopping Mode Low Band Edge Plot

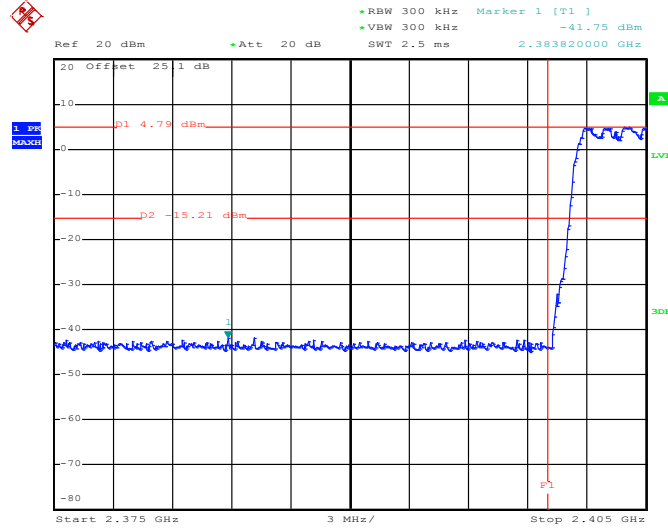

Date: 1.JUL.2013 22:29:22

2Mbps Hopping Mode High Band Edge Plot

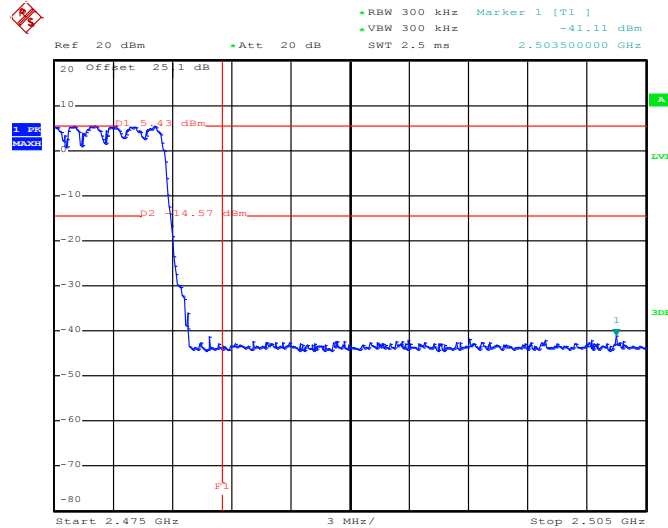

Date: 1.JUL.2013 22:28:32



Test Mode :	3Mbps	Temperature :	24~26°C
Test Engineer :	Bill Kuo	Relative Humidity :	50~53%

3Mbps Hopping Mode Low Band Edge Plot

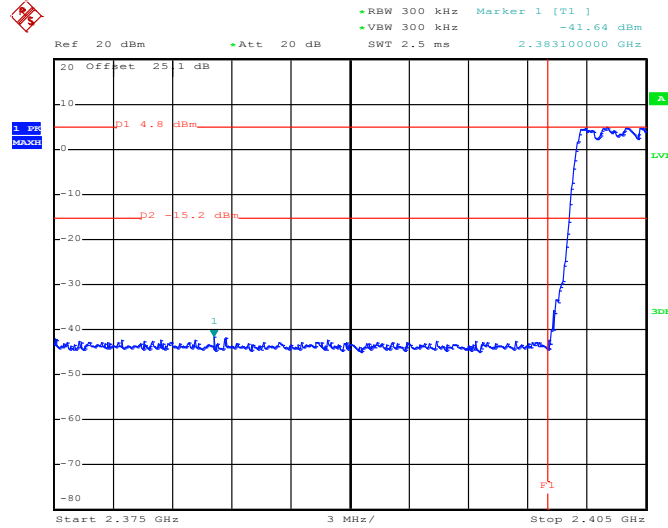

Date: 1.JUL.2013 22:30:28

3Mbps Hopping Mode High Band Edge Plot

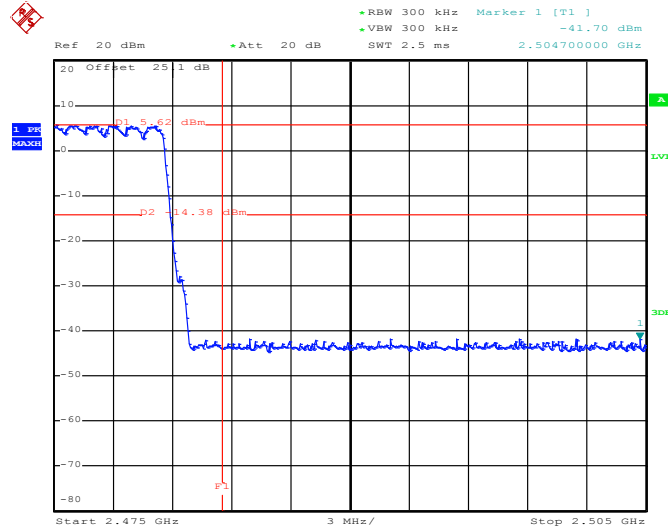

Date: 1.JUL.2013 22:31:51

3.7 Conducted Spurious Emission Measurement

3.7.1 Limit of Spurious Emission Measurement

In any 100 kHz bandwidth outside the intentional radiation frequency band, the radio frequency power shall be at least 20 dB below the highest level of the radiated power. In addition, radiated emissions which fall in the restricted bands must also comply with the radiated emission limits.

3.7.2 Measuring Instruments

See list of measuring instruments of this test report.

3.7.3 Test Procedure

1. The testing follows the guidelines in Spurious RF Conducted Emissions of FCC Public Notice DA 00-705 Measurement Guidelines
2. The RF output of EUT was connected to the spectrum analyzer by RF cable and attenuator. The path loss was compensated to the results for each measurement.
3. Set to the maximum power setting and enable the EUT transmit continuously.
4. Set RBW = 100 kHz, VBW = 300kHz, scan up through 10th harmonic. All harmonics / spurs must be at least 20 dB down from the highest emission level within the authorized band as measured with a 100 kHz RBW.
5. Measure and record the results in the test report.
6. The RF fundamental frequency should be excluded against the limit line in the operating frequency band.

3.7.4 Test Setup

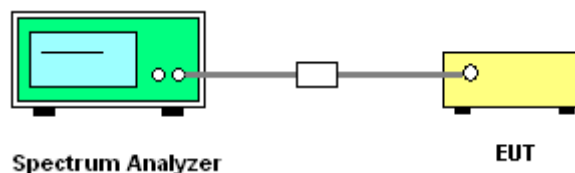

3.7.5 Test Result of Conducted Spurious Emission

Test Mode :	1Mbps	Temperature :	24~26°C
Test Channel :	00	Relative Humidity :	50~53%
		Test Engineer :	Bill Kuo

1Mbps CSE Plot on Ch 00 between 30MHz ~ 3 GHz

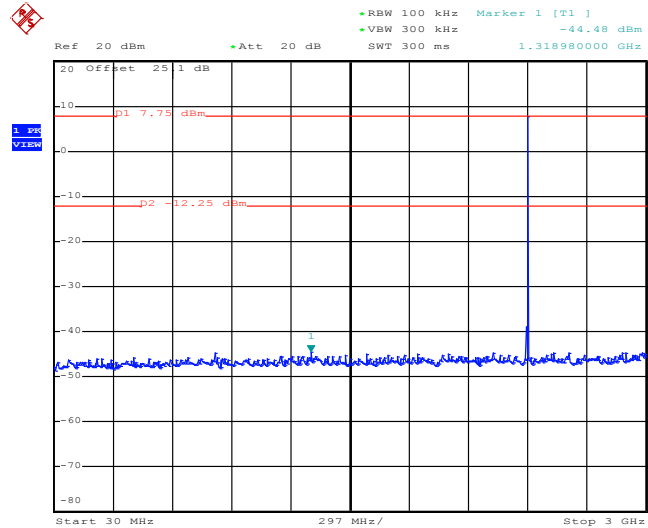

Date: 1.JUL.2013 21:53:08

1Mbps CSE Plot on Ch 00 between 2 GHz ~ 25 GHz

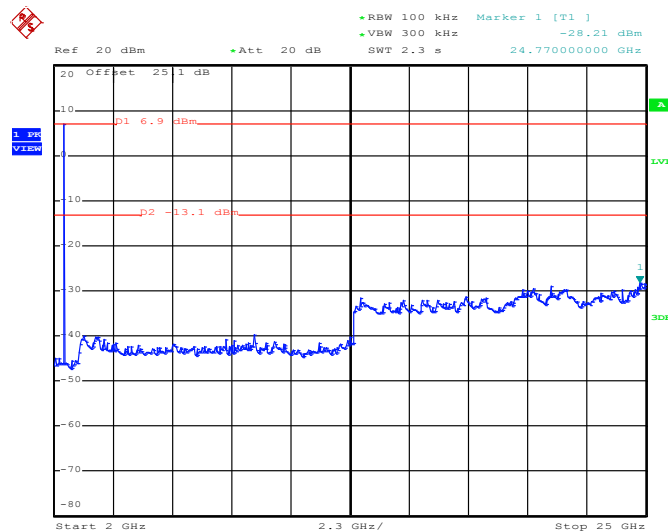

Date: 1.JUL.2013 21:53:29



Test Mode :	1Mbps	Temperature :	24~26°C
Test Channel :	39	Relative Humidity :	50~53%
		Test Engineer :	Bill Kuo

1Mbps CSE Plot on Ch 39 between 30MHz ~ 3 GHz

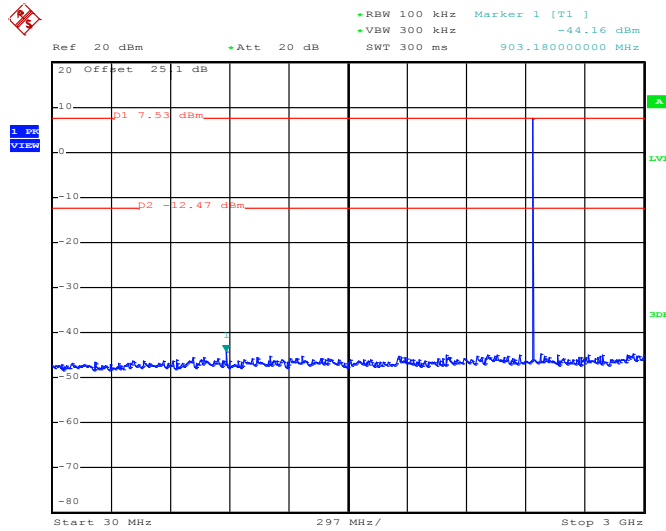

Date: 1.JUL.2013 21:48:42

1Mbps CSE Plot on Ch 39 between 2 GHz ~ 25 GHz

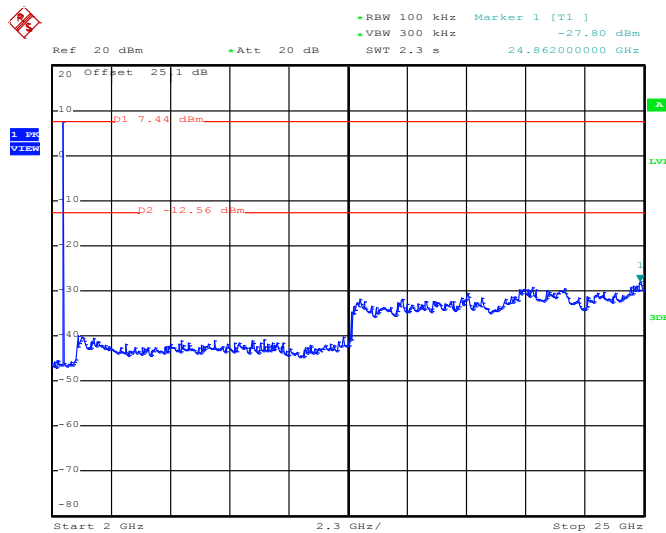

Date: 1.JUL.2013 21:49:04



Test Mode :	1Mbps	Temperature :	24~26°C
Test Channel :	78	Relative Humidity :	50~53%
		Test Engineer :	Bill Kuo

1Mbps CSE Plot on Ch 78 between 30MHz ~ 3 GHz

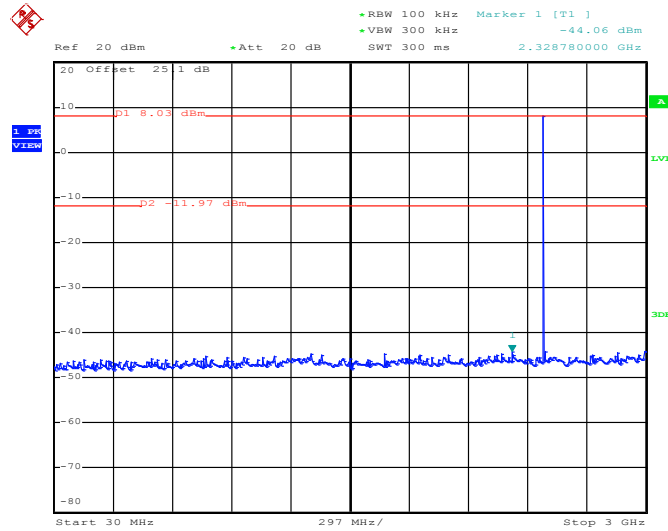

Date: 1.JUL.2013 21:52:17

1Mbps CSE Plot on Ch 78 between 2 GHz ~ 25 GHz

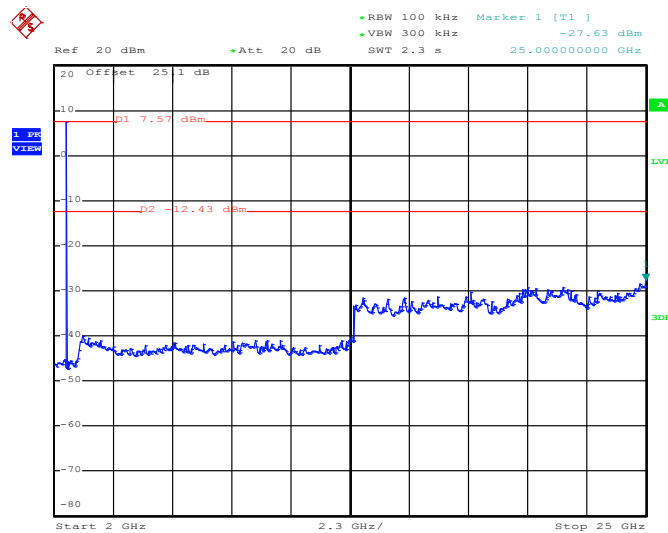

Date: 1.JUL.2013 21:52:39



Test Mode :	2Mbps	Temperature :	24~26°C
Test Channel :	00	Relative Humidity :	50~53%
		Test Engineer :	Bill Kuo

2Mbps CSE Plot on Ch 00 between 30MHz ~ 3 GHz

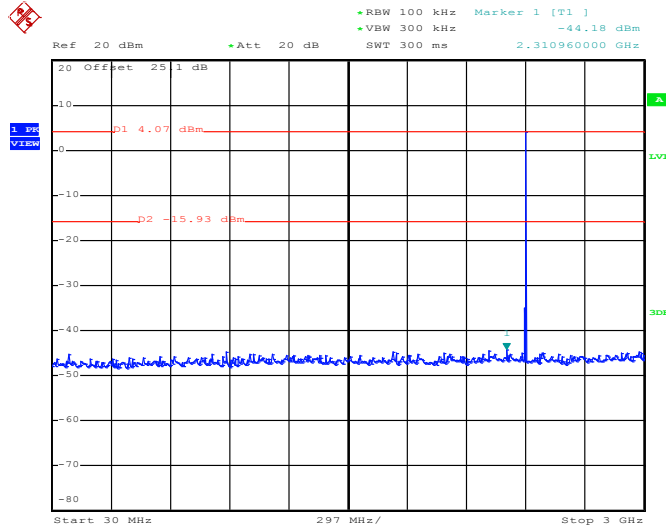

Date: 1.JUL.2013 21:57:07

2Mbps CSE Plot on Ch 00 between 2 GHz ~ 25 GHz

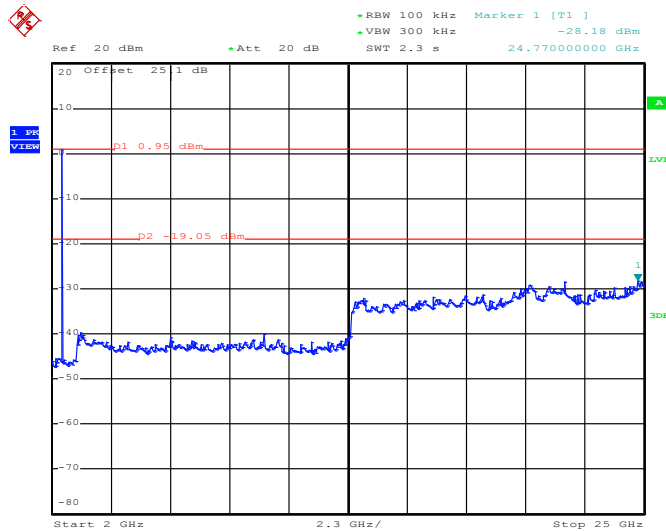

Date: 1.JUL.2013 21:57:29



Test Mode :	2Mbps	Temperature :	24~26°C
Test Channel :	39	Relative Humidity :	50~53%
		Test Engineer :	Bill Kuo

2Mbps CSE Plot on Ch 39 between 30MHz ~ 3 GHz

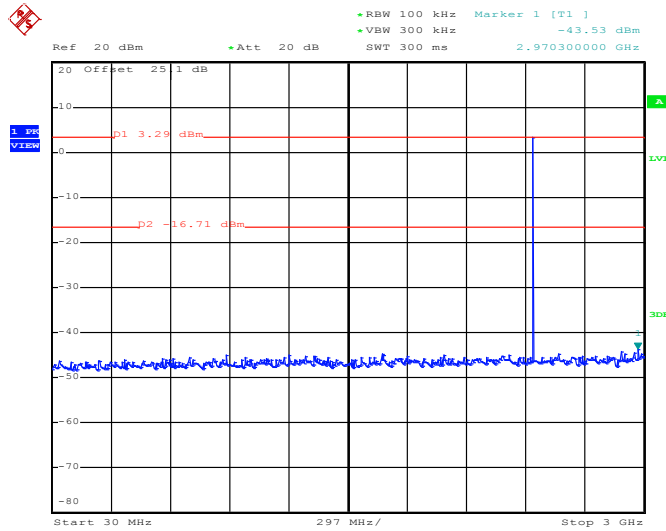

Date: 1.JUL.2013 21:58:01

2Mbps CSE Plot on Ch 39 between 2 GHz ~ 25 GHz

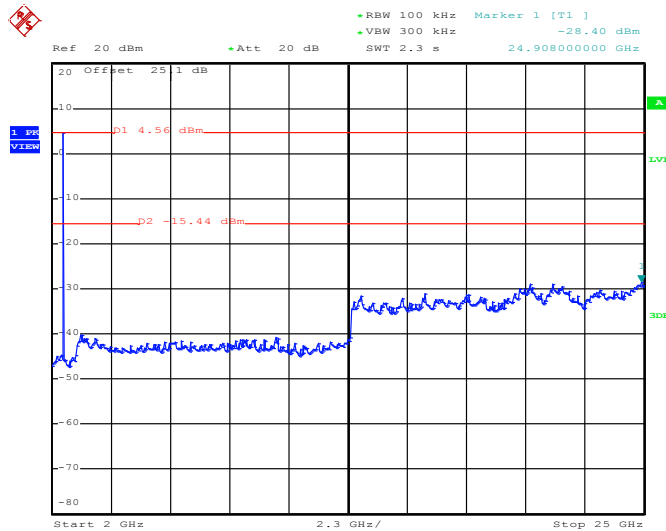

Date: 1.JUL.2013 21:58:23



Test Mode :	2Mbps	Temperature :	24~26°C
Test Channel :	78	Relative Humidity :	50~53%
		Test Engineer :	Bill Kuo

2Mbps CSE Plot on Ch 78 between 30MHz ~ 3 GHz

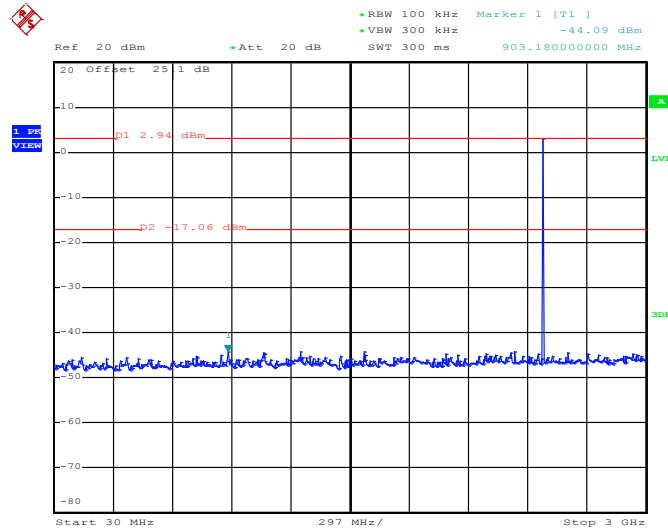

Date: 1.JUL.2013 21:58:51

2Mbps CSE Plot on Ch 78 between 2 GHz ~ 25 GHz

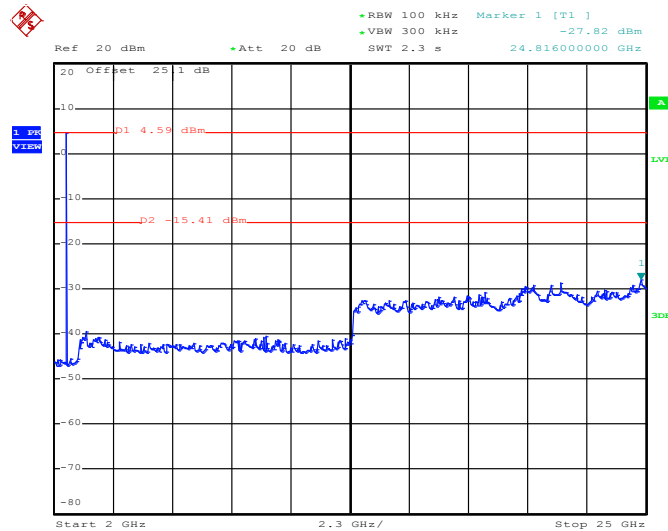

Date: 1.JUL.2013 21:59:12



Test Mode :	3Mbps	Temperature :	24~26°C
Test Channel :	00	Relative Humidity :	50~53%
		Test Engineer :	Bill Kuo

3Mbps CSE Plot on Ch 00 between 30MHz ~ 3 GHz

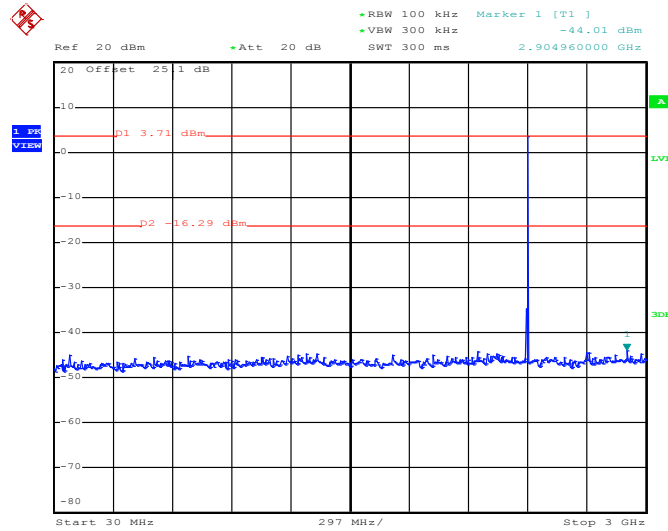

Date: 1.JUL.2013 22:02:58

3Mbps CSE Plot on Ch 00 between 2 GHz ~ 25 GHz

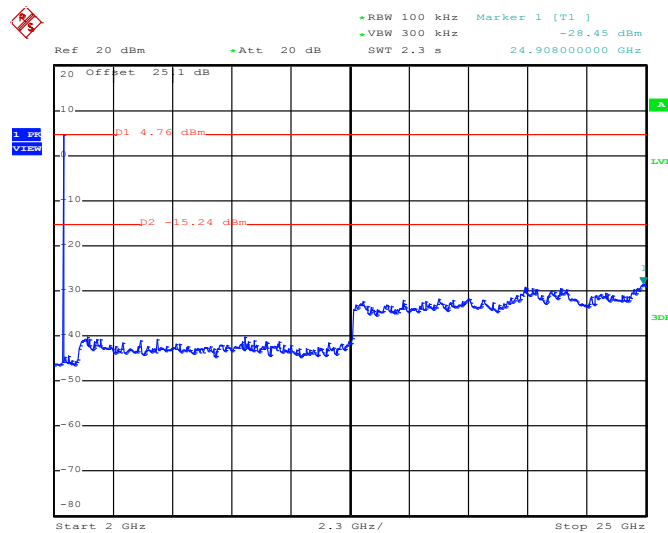

Date: 1.JUL.2013 22:03:20



Test Mode :	3Mbps	Temperature :	24~26°C
Test Channel :	39	Relative Humidity :	50~53%
		Test Engineer :	Bill Kuo

3Mbps CSE Plot on Ch 39 between 30MHz ~ 3 GHz

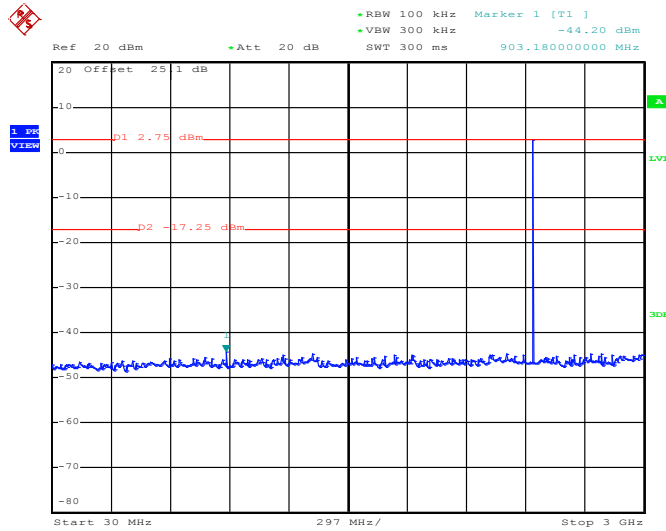

Date: 1.JUL.2013 22:00:28

3Mbps CSE Plot on Ch 39 between 2 GHz ~ 25 GHz

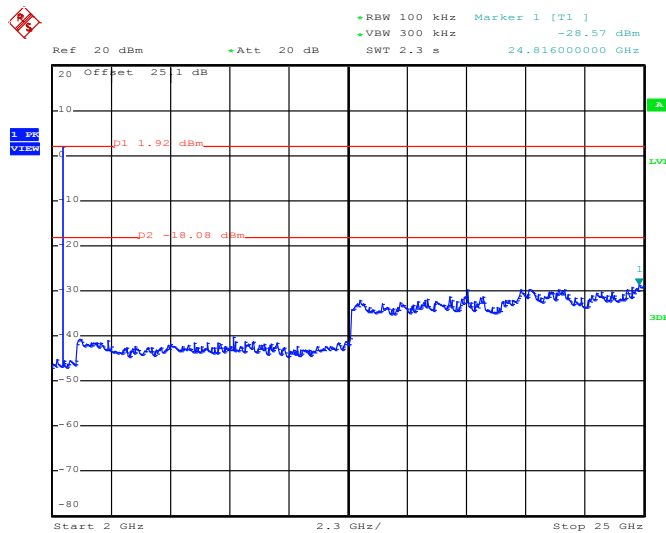

Date: 1.JUL.2013 22:00:50



Test Mode :	3Mbps	Temperature :	24~26°C
Test Channel :	78	Relative Humidity :	50~53%
		Test Engineer :	Bill Kuo

3Mbps CSE Plot on Ch 78 between 30MHz ~ 3 GHz

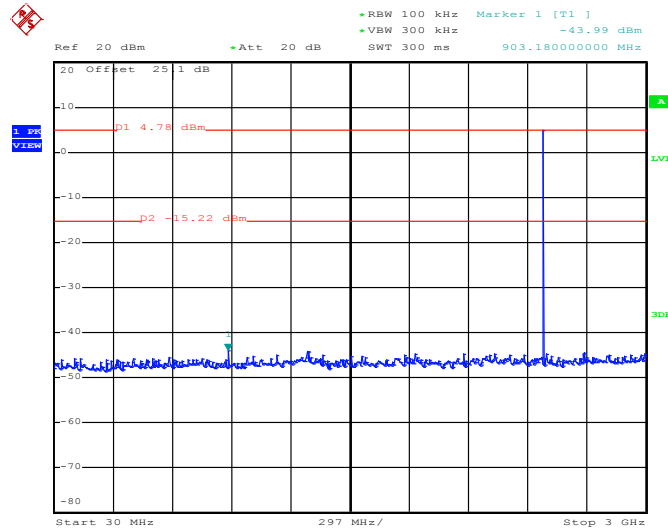

Date: 1.JUL.2013 21:59:41

3Mbps CSE Plot on Ch 78 between 2 GHz ~ 25 GHz

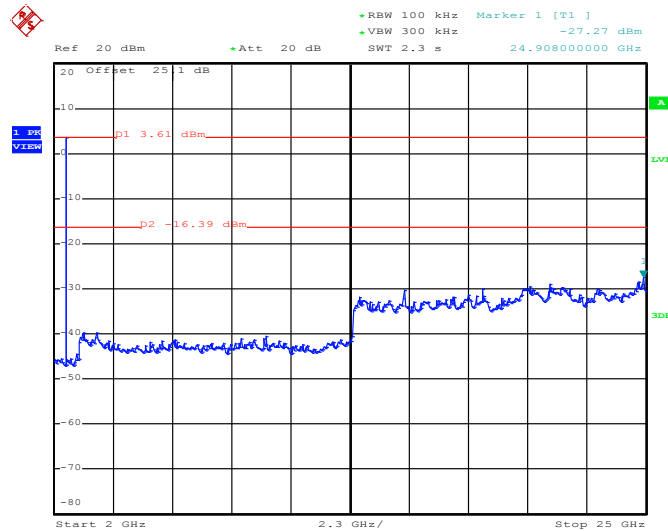

Date: 1.JUL.2013 22:00:03



3.8 Radiated Band Edges and Spurious Emission Measurement

3.8.1 Limit of Radiated Band Edges and Spurious Emission

In any 100 kHz bandwidth outside the intentional radiator frequency band, all harmonics/spurious must be at least 20 dB below the highest emission level within the authorized band. In addition, radiated emissions which fall in the restricted bands must also comply with the FCC section 15.209 limits as below.

Frequency (MHz)	Field Strength (microvolts/meter)	Measurement Distance (meters)
0.009 – 0.490	2400/F(kHz)	300
0.490 – 1.705	24000/F(kHz)	30
1.705 – 30.0	30	30
30 – 88	100	3
88 – 216	150	3
216 - 960	200	3
Above 960	500	3

3.8.2 Measuring Instruments

See list of measuring instruments of this test report.



3.8.3 Test Procedures

1. The testing follows the guidelines in Spurious Radiated Emissions of FCC Public Notice DA 00-705 Measurement Guidelines and the guidelines in ANSI C63.10-2009.
2. The EUT was placed on a turntable with 0.8 meter above ground.
3. The EUT was set 3 meters from the interference receiving antenna, which was mounted on the top of a variable height antenna tower.
4. For each suspected emission, the EUT was arranged to its worst case and then tune the Antenna tower (from 1 m to 4 m) and turntable (from 0 degree to 360 degrees) to find the maximum reading. A pre-amp and a high pass filter are used for the test in order to get better signal level to comply with the guidelines.
5. Set to the maximum power setting and enable the EUT transmit continuously.
6. Use the following spectrum analyzer settings:
 - (1) Span shall wide enough to fully capture the emission being measured;
 - (2) Set RBW=100 kHz for $f < 1$ GHz, RBW=1MHz for $f > 1$ GHz ; VBW \geq RBW; Sweep = auto; Detector function = peak; Trace = max hold for peak
 - (3) For average measurement: use duty cycle correction factor method per 15.35(c).
Duty cycle = On time/100 milliseconds
On time = $N_1 * L_1 + N_2 * L_2 + \dots + N_{n-1} * L_{n-1} + N_n * L_n$
Where N_1 is number of type 1 pulses, L_1 is length of type 1 pulses, etc.
Average Emission Level = Peak Emission Level + $20 * \log(\text{Duty cycle})$
7. Corrected Reading: Antenna Factor + Cable Loss + Read Level - Preamp Factor = Level

Note: The average levels were calculated from the peak level corrected with duty cycle correction factor (24.79dB) derived from $20 \log(\text{dwell time}/100\text{ms})$.

3.8.4 Test Setup

For radiated emissions below 30MHz

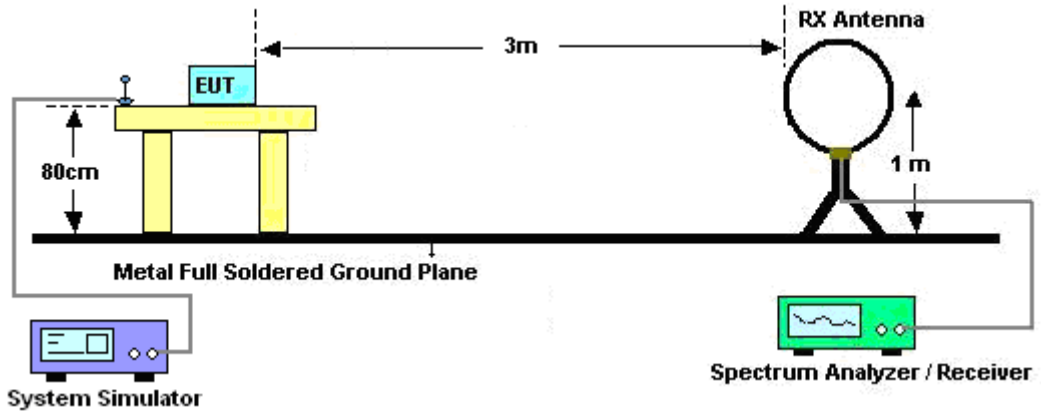

For radiated emissions from 30MHz to 1GHz

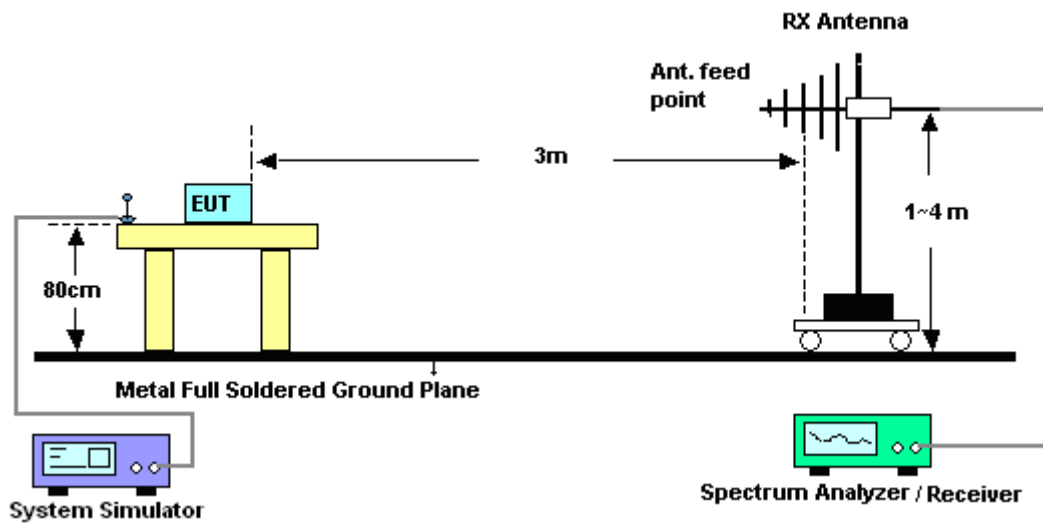

For radiated emissions above 1GHz

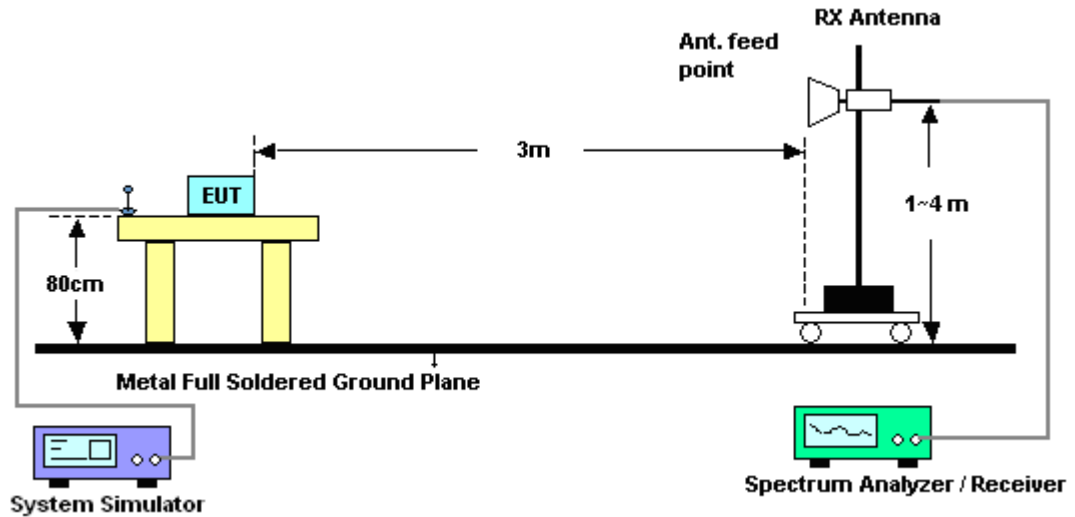

3.8.5 Test Results of Radiated Spurious Emissions (9 kHz ~ 30 MHz)

The low frequency, which started from 9 kHz to 30MHz, was pre-scanned and the result which was 20dB lower than the limit line per 15.31(o) was not reported.

3.8.6 Duty cycle correction factor for average measurement

DH5 on time (One Pulse) Plot on Channel 39

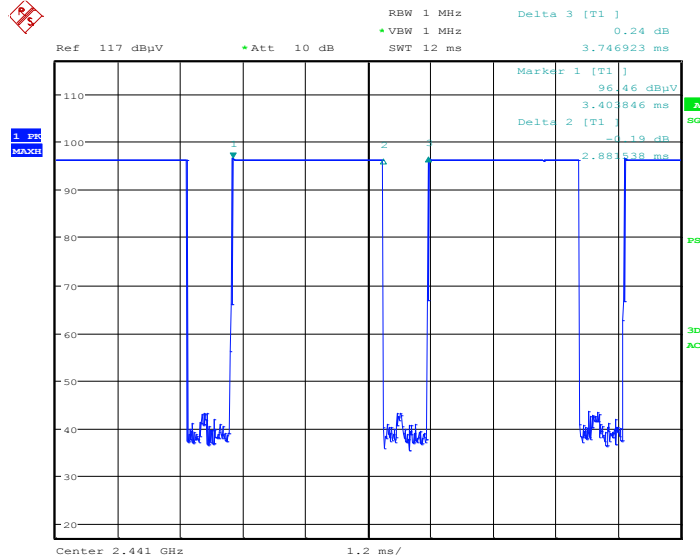

Date: 5.JUL.2013 10:56:50

DH5 on time (Count Pulses) Plot on Channel 39

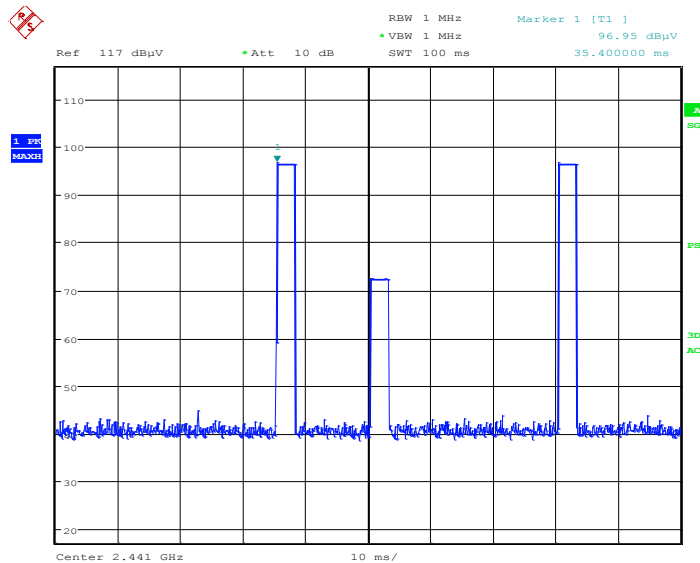

Date: 5.JUL.2013 10:59:18

Note:

1. Worst case Duty cycle = on time/100 milliseconds = $2 * 2.88 / 100 = 5.76 \%$
2. Worst case Duty cycle correction factor = $20 * \log(\text{Duty cycle}) = -24.79 \text{ dB}$
3. DH5 has the highest duty cycle worst case and is reported.



Duty Cycle Correction Factor Consideration for AFH mode:

Bluetooth normal hopping rate is 1600Hz and reduced to 800Hz in AFH mode; due to the reduced number of hopping frequencies, with the same packet configuration the dwell time in each channel frequency within 100msec period is longer in AFH mode than normal mode.

In AFH mode, the minimum hopping frequencies are 20, to get the longest dwell time DH5 packet is observed; the period to have DH5 packet completing one hopping sequence is

$$2.88 \text{ ms} \times 20 \text{ channels} = 57.6 \text{ ms}$$

There cannot be 2 complete hopping sequences within 100ms period, considering the random hopping behavior, maximum 2 hops can be possibly observed within the period. $[100\text{ms} / 57.6\text{ms}] = 2$ hops

Thus, the maximum possible ON time:

$$2.88 \text{ ms} \times 2 = 5.76 \text{ ms}$$

Worst case Duty Cycle Correction factor, which is derived from the maximum possible ON time,

$$20 \times \log(5.76 \text{ ms}/100\text{ms}) = -24.79 \text{ dB}$$



3.8.7 Test Result of Radiated Spurious at Band Edges

Test Mode :	1Mbps	Temperature :	24~25°C
Test Channel :	00	Relative Humidity :	50~52%
		Test Engineer :	David Ke

ANTENNA POLARITY : HORIZONTAL										
Frequency (MHz)	Level (dBμV/m)	Over Limit (dB)	Limit Line (dBμV/m)	Read Level (dBμV)	Antenna Factor (dB)	Cable Loss (dB)	Preamp Factor (dB)	Ant Pos (cm)	Table Pos (deg)	Remark
2369.58	48.75	-25.25	74	44.33	32.33	6.42	34.33	168	276	Peak
2369.58	23.96	-30.04	54	-	-	-	-	-	-	Average

ANTENNA POLARITY : VERTICAL										
Frequency (MHz)	Level (dBμV/m)	Over Limit (dB)	Limit Line (dBμV/m)	Read Level (dBμV)	Antenna Factor (dB)	Cable Loss (dB)	Preamp Factor (dB)	Ant Pos (cm)	Table Pos (deg)	Remark
2322.6	48.65	-25.35	74	44.39	32.26	6.35	34.35	200	248	Peak
2322.6	23.86	-30.14	54	-	-	-	-	-	-	Average

Test Mode :	1Mbps	Temperature :	24~25°C
Test Channel :	78	Relative Humidity :	50~52%
		Test Engineer :	David Ke

ANTENNA POLARITY : HORIZONTAL										
Frequency (MHz)	Level (dBμV/m)	Over Limit (dB)	Limit Line (dBμV/m)	Read Level (dBμV)	Antenna Factor (dB)	Cable Loss (dB)	Preamp Factor (dB)	Ant Pos (cm)	Table Pos (deg)	Remark
2483.5	57.72	-16.28	74	52.95	32.48	6.59	34.3	101	35	Peak
2483.5	32.93	-21.07	54	-	-	-	-	-	-	Average

ANTENNA POLARITY : VERTICAL										
Frequency (MHz)	Level (dBμV/m)	Over Limit (dB)	Limit Line (dBμV/m)	Read Level (dBμV)	Antenna Factor (dB)	Cable Loss (dB)	Preamp Factor (dB)	Ant Pos (cm)	Table Pos (deg)	Remark
2483.5	54.97	-19.03	74	50.2	32.48	6.59	34.3	200	306	Peak
2483.5	30.18	-23.82	54	-	-	-	-	-	-	Average

3.8.8 Test Result of Radiated Spurious Emission (30MHz ~ 10th Harmonic)

Note: Pre-scanned all test modes and only choose the worst case mode recorded in the test report for radiated spurious emission below 1GHz.

Test Mode :	1Mbps	Temperature :	24~25°C
Test Channel :	00	Relative Humidity :	50~52%
Test Engineer :	David Ke	Polarization :	Horizontal
Remark :	1. 2402 MHz is fundamental signal which can be ignored. 2. 7206MHz is not within a restricted band, and its limit line is 20dB below the highest emission level. For example, 102.19dBμV/m - 20dB = 82.19 dBμV/m.		

Frequency (MHz)	Level (dBμV/m)	Over Limit (dB)	Limit Line (dBμV/m)	Read Level (dBμV)	Antenna Factor (dB)	Cable Loss (dB)	Preamp Factor (dB)	Ant Pos (cm)	Table Pos (deg)	Remark
2402	102.19	-	-	97.71	32.36	6.45	34.33	168	276	Peak
2402	77.40	-	-	-	-	-	-	-	-	Average
4804	48.72	-25.28	74	59.24	34.88	10.16	55.56	100	0	Peak
4804	23.93	-30.07	54	-	-	-	-	-	-	Average
7206	48.96	-33.23	82.19	58.32	36.16	10.97	56.49	100	0	Peak

Note: Other harmonics are lower than background noise.

Test Mode :	1Mbps	Temperature :	24~25°C
Test Channel :	00	Relative Humidity :	50~52%
Test Engineer :	David Ke	Polarization :	Vertical
Remark :	1. 2404 MHz is fundamental signal which can be ignored. 2. 7206 MHz is not within a restricted band, and its limit line is 20dB below the highest emission level.		

Frequency (MHz)	Level (dBμV/m)	Over Limit (dB)	Limit Line (dBμV/m)	Read Level (dBμV)	Antenna Factor (dB)	Cable Loss (dB)	Preamp Factor (dB)	Ant Pos (cm)	Table Pos (deg)	Remark
2404	99.73	-	-	95.23	32.38	6.45	34.33	200	248	Peak
2404	74.94	-	-	-	-	-	-	-	-	Average
4804	48.78	-25.22	74	59.3	34.88	10.16	55.56	100	0	Peak
4804	23.99	-30.01	54	-	-	-	-	-	-	Average
7206	49.02	-30.71	79.73	58.38	36.16	10.97	56.49	100	0	Peak

Note: Other harmonics are lower than background noise.



Test Mode :	1Mbps	Temperature :	24~25°C
Test Channel :	39	Relative Humidity :	50~52%
Test Engineer :	David Ke	Polarization :	Horizontal
Remark :	2442 MHz is fundamental signal which can be ignored.		

Frequency (MHz)	Level (dBμV/m)	Over Limit (dB)	Limit Line (dBμV/m)	Read Level (dBμV)	Antenna Factor (dB)	Cable Loss (dB)	Preamp Factor (dB)	Ant Pos (cm)	Table Pos (deg)	Remark
2442	101.42	-	-	96.78	32.43	6.52	34.31	200	30	Peak
2442	76.63	-	-	-	-	-	-	-	-	Average
4882	48.86	-25.14	74	59.5	34.85	10.19	55.68	100	0	Peak
4882	24.07	-29.93	54	-	-	-	-	-	-	Average
7323	48.76	-25.24	74	57.93	36.13	10.94	56.24	100	0	Peak
7323	23.97	-30.03	54	-	-	-	-	-	-	Average

Note: Other harmonics are lower than background noise.

Test Mode :	1Mbps	Temperature :	24~25°C
Test Channel :	39	Relative Humidity :	50~52%
Test Engineer :	David Ke	Polarization :	Vertical
Remark :	2442 MHz is fundamental signal which can be ignored.		

Frequency (MHz)	Level (dBμV/m)	Over Limit (dB)	Limit Line (dBμV/m)	Read Level (dBμV)	Antenna Factor (dB)	Cable Loss (dB)	Preamp Factor (dB)	Ant Pos (cm)	Table Pos (deg)	Remark
2442	96.96	-	-	92.32	32.43	6.52	34.31	175	307	Peak
2442	72.17	-	-	-	-	-	-	-	-	Average
4882	47.71	-26.29	74	58.35	34.85	10.19	55.68	100	0	Peak
4882	22.92	-31.08	54	-	-	-	-	-	-	Average
7323	48.69	-25.31	74	57.86	36.13	10.94	56.24	100	0	Peak
7323	23.90	-30.10	54	-	-	-	-	-	-	Average

Note: Other harmonics are lower than background noise.



Test Mode :	1Mbps	Temperature :	24~25°C
Test Channel :	78	Relative Humidity :	50~52%
Test Engineer :	David Ke	Polarization :	Horizontal
Remark :	2480 MHz is fundamental signal which can be ignored.		

Frequency (MHz)	Level (dBμV/m)	Over Limit (dB)	Limit Line (dBμV/m)	Read Level (dBμV)	Antenna Factor (dB)	Cable Loss (dB)	Preamp Factor (dB)	Ant Pos (cm)	Table Pos (deg)	Remark
62.94	20.87	-19.13	40	45.61	6.14	0.89	31.77	122	203	Peak
167.16	18.75	-24.75	43.5	39	9.92	1.58	31.75	-	-	Peak
280.56	22.54	-23.46	46	39.63	12.8	1.84	31.73	-	-	Peak
406.4	20.6	-25.4	46	34.2	16.02	2.21	31.83	-	-	Peak
671	21.16	-24.84	46	31.26	19.09	2.84	32.03	-	-	Peak
830.6	22.38	-23.62	46	30.94	20.1	3.16	31.82	-	-	Peak
2480	101.57	-	-	96.8	32.48	6.59	34.3	101	35	Peak
2480	76.78	-	-	-	-	-	-	-	-	Average
4960	48.93	-25.07	74	59.75	34.81	10.21	55.84	100	0	Peak
4960	24.14	-29.86	54	-	-	-	-	-	-	Average
7440	49.91	-24.09	74	58.9	36.11	10.9	56	100	0	Peak
7440	25.12	-28.88	54	-	-	-	-	-	-	Average

Note: Other harmonics are lower than background noise.



Test Mode :	1Mbps	Temperature :	24~25°C
Test Channel :	78	Relative Humidity :	50~52%
Test Engineer :	David Ke	Polarization :	Vertical
Remark :	2480 MHz is fundamental signal which can be ignored.		

Frequency (MHz)	Level (dBμV/m)	Over Limit (dB)	Limit Line (dBμV/m)	Read Level (dBμV)	Antenna Factor (dB)	Cable Loss (dB)	Preamp Factor (dB)	Ant Pos (cm)	Table Pos (deg)	Remark
35.94	30.33	-9.67	40	46.38	15.04	0.7	31.79	100	333	Peak
62.4	21.75	-18.25	40	46.57	6.06	0.89	31.77	-	-	Peak
77.25	23.27	-16.73	40	47.3	6.75	0.98	31.76	-	-	Peak
469.4	19.82	-26.18	46	32.22	17.18	2.32	31.9	-	-	Peak
658.4	22.22	-23.78	46	32.24	19.2	2.82	32.04	-	-	Peak
825	22.14	-23.86	46	30.79	20.05	3.15	31.85	-	-	Peak
2480	98.52	-	-	93.75	32.48	6.59	34.3	200	306	Peak
2480	73.73	-	-	-	-	-	-	-	-	Average
4960	47.59	-26.41	74	58.41	34.81	10.21	55.84	100	0	Peak
4960	22.80	-31.20	54	-	-	-	-	-	-	Average
7440	48.9	-25.1	74	57.89	36.11	10.9	56	100	0	Peak
7440	24.11	-29.89	54	-	-	-	-	-	-	Average

Note: Other harmonics are lower than background noise.

3.9 AC Conducted Emission Measurement

3.9.1 Limit of AC Conducted Emission

For equipment that is designed to be connected to the public utility (AC) power line, the radio frequency voltage that is conducted back onto the AC power line on any frequency or frequencies within the band 150 kHz to 30 MHz shall not exceed the limits in the following table.

Frequency of emission (MHz)	Conducted limit (dB μ V)	
	Quasi-peak	Average
0.15-0.5	66 to 56*	56 to 46*
0.5-5	56	46
5-30	60	50

*Decreases with the logarithm of the frequency.

3.9.2 Measuring Instruments

See list of measuring instruments of this test report.

3.9.3 Test Procedures

1. The test follows the guidelines in ANSI C63.10-2009 test site requirement.
2. The EUT was placed 0.4 meter from the conducting wall of the shielding room was kept at least 80 centimeters from any other grounded conducting surface.
3. Connect EUT to the power mains through a line impedance stabilization network (LISN).
4. All the support units are connecting to the other LISN.
5. The LISN provides 50 ohm coupling impedance for the measuring instrument.
6. The FCC states that a 50 ohm, 50 microhenry LISN should be used.
7. Both sides of AC line were checked for maximum conducted interference.
8. The frequency range from 150 kHz to 30 MHz was searched.
9. Set the test-receiver system to Peak Detect Function and specified bandwidth with Maximum Hold Mode.

3.9.4 Test Setup



3.9.5 Test Result of AC Conducted Emission

Test Mode :	Mode 1	Temperature :	20~22°C
Test Engineer :	Slash Huang	Relative Humidity :	45~47%
Test Voltage :	120Vac / 60Hz	Phase :	Line
Function Type :	GSM850 Idle + Bluetooth Link + WLAN (2.4GHz) Link + USB Cable (Charging from Adapter) + Earphone + MP3		

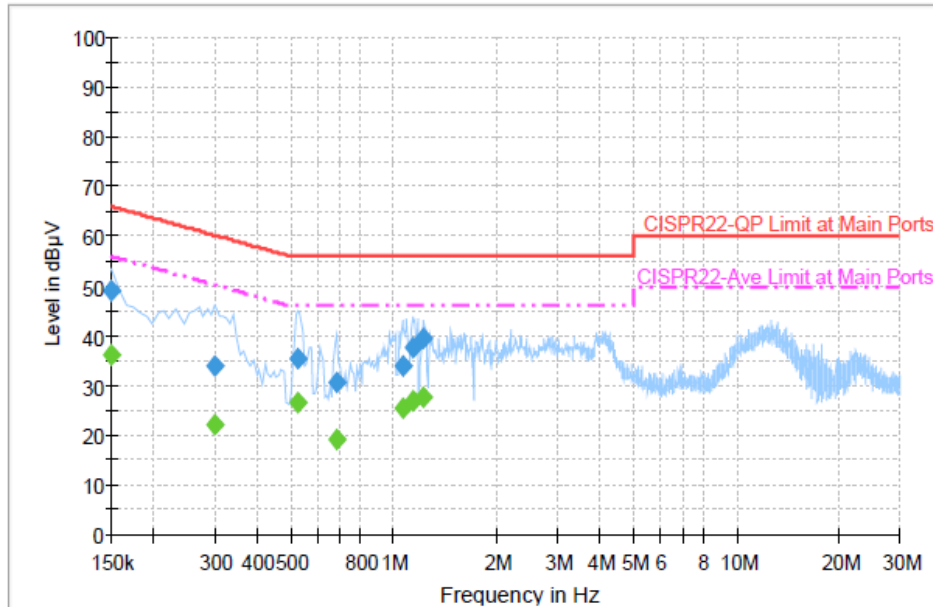

Final Result : Quasi-Peak

Frequency (MHz)	Quasi-Peak (dBµV)	Filter	Line	Corr. (dB)	Margin (dB)	Limit (dBµV)
0.150000	49.2	Off	L1	19.4	16.8	66.0
0.302000	33.8	Off	L1	19.3	26.4	60.2
0.526000	35.4	Off	L1	19.4	20.6	56.0
0.686000	30.4	Off	L1	19.5	25.6	56.0
1.062000	34.1	Off	L1	19.4	21.9	56.0
1.134000	37.7	Off	L1	19.4	18.3	56.0
1.222000	39.4	Off	L1	19.5	16.6	56.0

Final Result : Average

Frequency (MHz)	Average (dBµV)	Filter	Line	Corr. (dB)	Margin (dB)	Limit (dBµV)
0.150000	36.1	Off	L1	19.4	19.9	56.0
0.302000	22.3	Off	L1	19.3	27.9	50.2
0.526000	26.6	Off	L1	19.4	19.4	46.0
0.686000	19.0	Off	L1	19.5	27.0	46.0
1.062000	25.4	Off	L1	19.4	20.6	46.0
1.134000	27.1	Off	L1	19.4	18.9	46.0
1.222000	27.8	Off	L1	19.5	18.2	46.0

Test Mode :	Mode 1	Temperature :	20~22°C
Test Engineer :	Slash Huang	Relative Humidity :	45~47%
Test Voltage :	120Vac / 60Hz	Phase :	Neutral
Function Type :	GSM850 Idle + Bluetooth Link + WLAN (2.4GHz) Link + USB Cable (Charging from Adapter) + Earphone + MP3		

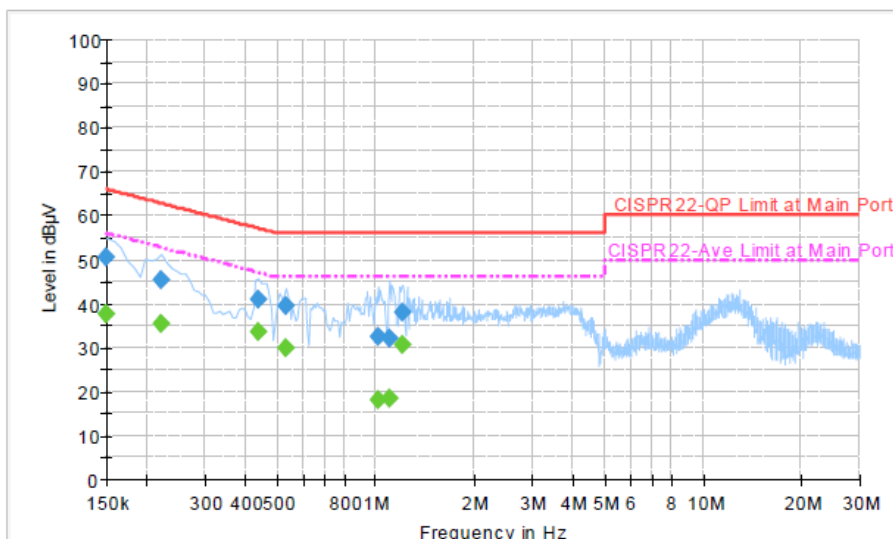

Final Result : Quasi-Peak

Frequency (MHz)	Quasi-Peak (dBµV)	Filter	Line	Corr. (dB)	Margin (dB)	Limit (dBµV)
0.150000	50.7	Off	N	19.4	15.3	66.0
0.222000	45.4	Off	N	19.4	17.3	62.7
0.440000	40.9	Off	N	19.4	16.2	57.1
0.534000	39.4	Off	N	19.4	16.6	56.0
1.014000	32.5	Off	N	19.5	23.5	56.0
1.102000	31.9	Off	N	19.5	24.1	56.0
1.206000	37.9	Off	N	19.5	18.1	56.0

Final Result : Average

Frequency (MHz)	Average (dBµV)	Filter	Line	Corr. (dB)	Margin (dB)	Limit (dBµV)
0.150000	37.7	Off	N	19.4	18.3	56.0
0.222000	35.4	Off	N	19.4	17.3	52.7
0.440000	33.5	Off	N	19.4	13.6	47.1
0.534000	29.9	Off	N	19.4	16.1	46.0
1.014000	18.0	Off	N	19.5	28.0	46.0
1.102000	18.3	Off	N	19.5	27.7	46.0
1.206000	30.6	Off	N	19.5	15.4	46.0



3.10 Antenna Requirements

3.10.1 Standard Applicable

If directional gain of transmitting antennas is greater than 6dBi, the power shall be reduced by the same level in dB comparing to gain minus 6dBi. The use of a permanently attached antenna or of an antenna that uses a unique coupling to the intentional radiator shall be considered sufficient to comply with the FCC rule.

3.10.2 Antenna Connected Construction

Non-standard connector used.

3.10.3 Antenna Gain

The antenna peak gain of EUT is less than 6 dBi. Therefore, it is not necessary to reduce maximum peak output power limit.

4 List of Measuring Equipment

Instrument	Manufacturer	Model No.	Serial No.	Characteristics	Calibration Date	Test Date	Due Date	Remark
Spectrum Analyzer	Rohde & Schwarz	FSP40	100055	9kHz~40GHz	Jun. 07, 2013	Jul.01, 2013~ Jul. 10, 2013	Jun. 06, 2014	Conducted (TH02-HY)
Power Meter	Agilent	E4416A	GB412923 44	300MHz~40GHz	Feb. 05, 2013	Jul.01, 2013~ Jul. 10, 2013	Feb. 04, 2014	Conducted (TH02-HY)
Power Sensor	Agilent	E9327A	US404415 48	300MHz~40GHz	Feb. 05, 2013	Jul.01, 2013~ Jul. 10, 2013	Feb. 04, 2014	Conducted (TH02-HY)
EMI Test Receiver	Rohde & Schwarz	ESCS 30	100356	9kHz ~ 2.75GHz	Nov. 13, 2012	Jul. 03, 2013	Nov. 12, 2013	Conduction (CO05-HY)
Two-LISN (for auxiliary equipment)	Rohde & Schwarz	ENV216	100081	9kHz ~ 30MHz	Dec. 12, 2012	Jul. 03, 2013	Dec. 11, 2013	Conduction (CO05-HY)
Two-LISN	Rohde & Schwarz	ENV216	100080	9kHz ~ 30MHz	Dec. 06, 2012	Jul. 03, 2013	Dec. 05, 2013	Conduction (CO05-HY)
AC Power Source	APC	APC-1000W	N/A	N/A	N/A	Jul. 03, 2013	N/A	Conduction (CO05-HY)
Spectrum Analyzer	R&S	FSP30	101352	9kHz~30GHz	Nov. 07, 2012	Jul. 05, 2013	Nov. 06, 2013	Radiation (03CH06-HY)
Spectrum Analyzer	Agilent	E4408B	MY442110 30	9kHz ~ 26.5GHz	Nov. 26, 2012	Jul. 05, 2013	Nov. 25, 2013	Radiation (03CH06-HY)
EMI Test Receiver	R&S	ESVS10	834468/00 03	20MHz ~ 1000MHz	May 06, 2013	Jul. 05, 2013	May 05, 2014	Radiation (03CH06-HY)
Loop Antenna	Rohde & Schwarz	HFH2-Z2	860004/00 01	9 kHz~30 MHz	Jul. 03, 2012	Jul. 05, 2013	Jul. 03, 2014	Radiation (03CH06-HY)
Bilog Antenna	SCHAFFNER	CBL6112B	2885	30MHz ~ 2GHz	Oct. 06, 2012	Jul. 05, 2013	Oct. 05, 2013	Radiation (03CH06-HY)
Double Ridge Horn Antenna	EMCO	3117	00066583	1GHz ~ 18GHz	Aug. 01, 2012	Jul. 05, 2013	Jul. 31, 2013	Radiation (03CH06-HY)
Amplifier	Agilent	310N	186713	9kHz ~ 1GHz	Apr. 12, 2013	Jul. 05, 2013	Apr. 11, 2014	Radiation (03CH06-HY)
Pre Amplifier	EMCI	EMC051845	SN980048	1GHz ~ 18GHz	Jul. 21, 2012	Jul. 05, 2013	Jul. 20, 2013	Radiation (03CH06-HY)
SHF-EHF Horn Antenna	SCHWARZBE CK	BBHA 9170	BBHA9170 251	15GHz ~ 40GHz	Sep. 28, 2012	Jul. 05, 2013	Sep. 27, 2013	Radiation (03CH06-HY)
Preamplifier	Agilent	8449B	3008A019 17	1GHz ~ 26.5GHz	Apr. 12, 2013	Jul. 05, 2013	Apr. 11, 2014	Radiation (03CH06-HY)
Turn Table	INN-CO	DS2000	420/650/00	0 - 360 degree	N/A	Jul. 05, 2013	N/A	Radiation (03CH06-HY)
Antenna Mast	MF	MF-7802	MF780208 212	1 m ~ 4 m	N/A	Jul. 05, 2013	N/A	Radiation (03CH06-HY)



5 Uncertainty of Evaluation

Uncertainty of Conducted Emission Measurement (150 kHz ~ 30 MHz)

Measuring Uncertainty for a Level of Confidence of 95% ($U = 2Uc(y)$)	2.26
---	------

Uncertainty of Radiated Emission Measurement (30 MHz ~ 1000 MHz)

Measuring Uncertainty for a Level of Confidence of 95% ($U = 2Uc(y)$)	2.54
---	------

Uncertainty of Radiated Emission Measurement (1 GHz ~ 40 GHz)

Measuring Uncertainty for a Level of Confidence of 95% ($U = 2Uc(y)$)	4.72
---	------