



PCTEST ENGINEERING LABORATORY, INC.

7185 Oakland Mills Road, Columbia, MD 21045 USA
Tel. 410.290.6652 / Fax 410.290.6654
http://www.pctestlab.com



MEASUREMENT REPORT FCC PART 15.407 / IC RSS-210 DFS

Company Name:
LG Electronics MobileComm U.S.A
1000 Sylvan Avenue
Englewood Cliffs, NJ 07632
United States

Date of Testing:
07/15/2013
Test Site/Location:
PCTEST Lab. Columbia, MD, USA
Test Report Serial No.:
0Y1306241076.ZNF

| | |
|-----------------|--|
| FCC ID: | ZNFD800 |
| COMPANY: | LG Electronics MobileComm U.S.A |

Model(s): LG-D800, D800, LGD800
EUT Type: Portable Handset
Type of Device: Client Only Device, No Radar Detection Capability
Frequency Range: 5260 – 5320 MHz (UNII-II Band)
5500 – 5700 MHz (UNII-III Band)
Output Power: 16.596 mW (12.20 dBm) Conducted (802.11n UNII Band II)
15.849 mW (12.00 dBm) Conducted (802.11n UNII Band III)
FCC Classification: Unlicensed National Information Infrastructure (UNII)
FCC Rule Part(s): Part 15.407(UNII)

This equipment has been shown to be capable of compliance with the applicable technical standards as indicated in the measurement report and was tested in accordance with the measurement procedures specified in FCC 06-96 Appendix B Compliance Measurement Procedures for Unlicensed-National Information Infrastructure Devices Operating in the 5.25 – 5.35 GHz and 5.47 – 5.725 GHz Bands Incorporating Dynamic Frequency Selection. Test results reported herein relate only to the item(s) tested.

I attest to the accuracy of data. All measurements reported herein were performed by me or were made under my supervision and are correct to the best of my knowledge and belief. I assume full responsibility for the completeness of these measurements and vouch for the qualifications of all persons taking them.

Randy Ortanez
President







| | | | | |
|---|---|---|---|--|
| FCC ID: ZNFD800 |  | FCC Pt. 15.407 DFS TEST REPORT (CERTIFICATION) |  | Reviewed by: Quality Manager |
| Test Report S/N: 0Y1306241076.ZNF | Test Dates: 07/15/2013 | EUT Type: Portable Handset | Page 1 of 21 | |

TABLE OF CONTENTS

| | | |
|---|--|----|
| FCC PART 15.407 MEASUREMENT REPORT..... | | 3 |
| 1.0 INTRODUCTION..... | | 4 |
| 1.1 SCOPE..... | | 4 |
| 1.2 EVALUATION PROCEDURE..... | | 4 |
| 1.3 SUMMARY OF TEST RESULTS | | 4 |
| 2.0 PRODUCT INFORMATION | | 5 |
| 2.1 EQUIPMENT DESCRIPTION..... | | 5 |
| 2.2 EUT CAPABILITIES | | 5 |
| 2.3 MODIFICATIONS..... | | 5 |
| 3.0 DESCRIPTION OF DYNAMIC FREQUENCY SELECTION TEST | | 6 |
| 3.1 APPLICABILITY | | 6 |
| 3.2 REQUIREMENTS | | 6 |
| 3.3 DFS DETECTION THRESHOLD VALUES | | 8 |
| 3.4 PARAMETERS OF DFS TEST SIGNALS..... | | 8 |
| 3.5 PROCEDURE | | 9 |
| 4.0 TEST EQUIPMENT..... | | 11 |
| 4.1 ADDITIONAL EQUIPMENT | | 11 |
| 5.0 TEST PLOTS AND DATA - UNII BAND II | | 12 |
| 6.0 TEST PLOTS AND DATA - UNII BAND III | | 16 |
| 7.0 CONCLUSION | | 21 |

| | | | | |
|---|--|---|---|--|
| FCC ID: ZNFD800 |  <small>ENGINEERING LABORATORY, INC.</small> | FCC Pt. 15.407 DFS TEST REPORT (CERTIFICATION) |  | Reviewed by: Quality Manager |
| Test Report S/N: 0Y1306241076.ZNF | Test Dates: 07/15/2013 | EUT Type: Portable Handset | Page 2 of 21 | |



DFS MEASUREMENT REPORT

FCC Part 15.407



§ 2.1033 General Information



APPLICANT: LG Electronics MobileComm U.S.A
APPLICANT ADDRESS: 1000 Sylvan Avenue
 Englewood Cliffs, NJ 07632, United States
TEST SITE: PCTEST ENGINEERING LABORATORY, INC.
TEST SITE ADDRESS: 7185 Oakland Mills Road, Columbia, MD 21046 USA
FCC RULE PART(S): Part 15.407(h)
BASE MODEL: LG-D800
FCC ID: ZNFD800
Test Device Serial No.: WiFi Cond Production Pre-Production Engineering
DEVICE CLASSIFICATION: Client Only, No Radar Detection
DATE(S) OF TEST: 07/15/2013
TEST REPORT S/N: 0Y1306241076.ZNF

Test Facility / Accreditations

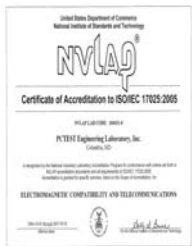
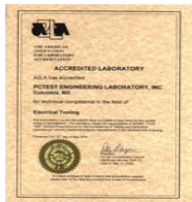
Measurements were performed at PCTEST Engineering Lab located in Columbia, MD 21045, U.S.A.



- PCTEST facility is an FCC registered (PCTEST Reg. No. 159966) test facility with the site description report on file and has met all the requirements specified in Section 2.948 of the FCC Rules and Industry Canada (2451B-1).
- PCTEST Lab is accredited to ISO 17025 by U.S. National Institute of Standards and Technology (NIST) under the National Voluntary Laboratory Accreditation Program (NVLAP Lab code: 100431-0) in EMC, FCC and Telecommunications.
- PCTEST Lab is accredited to ISO 17025-2005 by the American Association for Laboratory Accreditation (A2LA) in Specific Absorption Rate (SAR) testing, Hearing Aid Compatibility (HAC) testing, CTIA Test Plans, and wireless testing for FCC and Industry Canada Rules.
- PCTEST Lab is a recognized U.S. Conformity Assessment Body (CAB) in EMC and R&TTE (n.b. 0982) under the U.S.-EU Mutual Recognition Agreement (MRA).
- PCTEST TCB is a Telecommunication Certification Body (TCB) accredited to ISO/IEC Guide 65 by the American National Standards Institute (ANSI) in all scopes of FCC Rules and Industry Canada Standards (RSS).
- PCTEST facility is an IC registered (2451B-1) test laboratory with the site description on file at Industry Canada.
- PCTEST is a CTIA Authorized Test Laboratory (CATL) for AMPS, CDMA, and EvDO wireless devices and for Over-the-Air (OTA) Antenna Performance testing for AMPS, CDMA, GSM, GPRS, EGPRS, UMTS (W-CDMA), CDMA 1xEVDO, and CDMA 1xRTT.

| | | | |
|---|---|---|--|
| FCC ID: ZNFD800 |  FCC Pt. 15.407 DFS TEST REPORT (CERTIFICATION) |  | Reviewed by: Quality Manager |
| Test Report S/N: 0Y1306241076.ZNF | Test Dates: 07/15/2013 | EUT Type: Portable Handset | Page 3 of 21 |

1.0 INTRODUCTION

1.1 Scope

This report has been prepared to demonstrate compliance with the requirements for Dynamic Frequency Selection (DFS) as stated in FCC 06-96. Testing was performed on the **LG Portable Handset FCC ID: ZNFD800** in accordance with the measurement procedure described in Appendix B of FCC 06-96. As of July 20, 2007 all devices operating in the 5250 – 5350 MHz and/or the 5470 – 5725 MHz bands must comply with the DFS requirements. As the EUT does not have radar detection capability it was evaluated as a Client Only Device. All test results reported herein are applicable to the sample selected for testing. The unit used for testing was supplied by LG Electronics MobileComm U.S.A.

1.2 Evaluation Procedure



Conducted test methodology was used for the DFS evaluation procedure of the **LG Portable Handset FCC ID: ZNFD800**. No deviations to the test procedure and test methods occurred during the evaluation of the EUT.

1.3 Summary of Test Results

The **LG Portable Handset FCC ID: ZNFD800** was found to be compliant with the requirements for DFS as required for a Client Device per Part 15.407(h) and FCC 06-96. The following table lists the measured parameters. The actual data and plots can be found in Section 5 and 6 of this report.

| | Parameter | Measured | Limit | Result |
|------------------------------------|-----------------------------------|--|---|--------|
| 5260 – 5320 MHz UNII – II Band | Channel Move Time | 119.400 ms | 10 seconds | Pass |
| | Channel Closing Transmission Time | < 200ms + 0.00 ms (aggregate) | 200ms + aggregate of 60ms over remaining 10 second period | Pass |
| | Non-occupancy Period | Monitored > 30 minutes (No transmission occurred) | 30 minutes | Pass |
| 5470 – 5725 MHz UNII – III Band | Channel Move Time | 602.520 ms | 10 seconds | Pass |
| | Channel Closing Transmission Time | < 200ms + 0.26 ms (aggregate) | 200ms + aggregate of 60ms over remaining 10 second period | Pass |
| | Non-occupancy Period | Monitored > 30 minutes (No transmission occurred) | 30 minutes | Pass |

Table 1-1. DFS Test Results Summary

| | | | | |
|--------------------------------------|---|---|---|---------------------------------|
| FCC ID: ZNFD800 |  | FCC Pt. 15.407 DFS TEST REPORT (CERTIFICATION) |  | Reviewed by: Quality Manager |
| Test Report S/N: 0Y1306241076.ZNF | Test Dates: 07/15/2013 | EUT Type: Portable Handset | Page 4 of 21 | |

2.0 PRODUCT INFORMATION

2.1 Equipment Description

The Equipment Under Test (EUT) is the **LG Portable Handset FCC ID: ZNFD800**.

Mode of Operation:

| | |
|---|-------------------------------------|
| Master Device | <input type="checkbox"/> |
| Client Device (No radar detection) | <input checked="" type="checkbox"/> |
| Client Device with Radar Detection | <input type="checkbox"/> |

| Parameters of EUT: | |
|--------------------|---|
| Frequency | 5260 – 5320 MHz 5500 – 5700 MHz |
| Output Power: | 16.596 mW (12.20 dBm) Conducted (802.11a UNII Band II) 15.849 mW (12.00 dBm) Conducted (802.11a UNII Band III) |
| Modulation: | OFDM |
| Channel Bandwidth: | 20 MHz |



2.2 EUT Capabilities

This device contains the following capabilities:

850/1900 GSM/GPRS/EDGE, 850/1900 WCDMA/HSPA, Band 2, 4, 5, 17 (5, 10MHz BW) LTE, 802.11a/b/g/n/ac WLAN (DTS/NII), Bluetooth (1x,EDR, LE), NFC

2.3 Modifications

No modifications to the EUT were required in order to comply with the DFS specifications.

| | | | | |
|---|---|---|---|--|
| FCC ID: ZNFD800 |  | FCC Pt. 15.407 DFS TEST REPORT (CERTIFICATION) |  | Reviewed by: Quality Manager |
| Test Report S/N: 0Y1306241076.ZNF | Test Dates: 07/15/2013 | EUT Type: Portable Handset | Page 5 of 21 | |

3.0 DESCRIPTION OF DYNAMIC FREQUENCY SELECTION TEST

3.1 Applicability

The following table from FCC 06-96 lists the applicable requirements for the DFS testing. The device evaluated in this report is considered a client device without radar detection capability.

| Requirement | Operational Mode | | |
|---------------------------------|------------------|--------------------------------|-----------------------------|
| | Master | Client Without Radar Detection | Client With Radar Detection |
| Non-Occupancy Period | Yes | Not required | Yes |
| DFS Detection Threshold | Yes | Not required | Yes |
| Channel Availability Check Time | Yes | Not required | Not required |
| Uniform Spreading | Yes | Not required | Not required |
| U-NII Detection Bandwidth | Yes | Not required | Yes |

Table 3-1. DFS Applicability



| Requirement | Operational Mode | | |
|-----------------------------------|------------------|--------------------------------|-----------------------------|
| | Master | Client Without Radar Detection | Client With Radar Detection |
| DFS Detection Threshold | Yes | Not required | Yes |
| Channel Closing Transmission Time | Yes | Yes | Yes |
| Channel Move Time | Yes | Yes | Yes |
| U-NII Detection Bandwidth | Yes | Not required | Yes |
| Client Beacon Test | N/A | Yes | Yes |

Table 3-2. DFS Applicability During Normal Operation

3.2 Requirements

Per FCC 06-96 the following are the requirements for Client Devices:

- a) A Client Device will not transmit before having received appropriate control signals from a Master Device.
- b) A Client Device will stop all its transmissions whenever instructed by a Master Device to which it is associated and will meet the Channel Move Time and Channel Closing Transmission Time requirements.

| | | | | |
|--------------------------------------|---|---|---|---------------------------------|
| FCC ID: ZNFD800 |  | FCC Pt. 15.407 DFS TEST REPORT (CERTIFICATION) |  | Reviewed by: Quality Manager |
| Test Report S/N: 0Y1306241076.ZNF | Test Dates: 07/15/2013 | EUT Type: Portable Handset | Page 6 of 21 | |



The Client Device will not resume any transmissions until it has again received control signals from a Master Device.

- c) If a Client Device is performing In-Service Monitoring and detects a Radar Waveform above the DFS Detection Threshold, it will inform the Master Device. This is equivalent to the Master Device detecting the Radar Waveform and d) through f) of section 5.1.1 apply.
- d) Irrespective of Client Device or Master Device detection the Channel Move Time and Channel Closing Transmission Time requirements remain the same.

Channel Move Time and Channel Closing Transmission Time requirements are listed in the following table.

| Parameter | Value |
|---|--|
| Non-occupancy period | Minimum 30 minutes |
| Channel Availability Check Time | 60 seconds |
| Channel Move Time | 10 seconds See Note 1. |
| Channel Closing Transmission Time | 200 milliseconds + an aggregate of 60 milliseconds over remaining 10 second period. See Notes 1 and 2. |
| U-NII Detection Bandwidth | Minimum 80% of the U-NII 99% transmission power bandwidth. See Note 3. |
| <p>Note 1: The instant that the Channel Move Time and the Channel Closing Transmission Time begins is as follows:</p> <ul style="list-style-type: none"> • For the Short Pulse Radar Test Signals this instant is the end of the Burst. • For the Frequency Hopping radar Test Signal, this instant is the end of the last radar Burst generated. • For the Long Pulse Radar Test Signal this instant is the end of the 12 second period defining the Radar Waveform. <p>Note 2: The Channel Closing Transmission Time is comprised of 200 milliseconds starting at the beginning of the Channel Move Time plus any additional intermittent control signals required to facilitate a Channel move (an aggregate of 60 milliseconds) during the remainder of the 10 second period. The aggregate duration of control signals will not count quiet periods in between transmissions.</p> <p>Note 3: During the U-NII Detection Bandwidth detection test, radar type 1 is used and for each frequency step the minimum percentage of detection is 90 percent. Measurements are performed with no data traffic.</p> | |

Table 3-3: DFS Response Requirements

| | | | | | |
|--------------------------------------|---|-------------------------------|---|---|---------------------------------|
| FCC ID: ZNFD800 |  | | FCC Pt. 15.407 DFS TEST REPORT (CERTIFICATION) |  | Reviewed by: Quality Manager |
| Test Report S/N: 0Y1306241076.ZNF | Test Dates: 07/15/2013 | EUT Type: Portable Handset | Page 7 of 21 | | |

3.3 DFS Detection Threshold Values

The DFS detection thresholds are defined for Master devices and Client Devices with In-service monitoring. These detection thresholds are listed in the following table.

| Maximum Transmit Power | Value (See Notes 1 and 2) |
|--|------------------------------|
| ≥ 200 milliwatt | -64 dBm |
| < 200 milliwatt | -62 dBm |
| Note 1: This is the level at the input of the receiver assuming a 0 dBi receive antenna. Note 2: Throughout these test procedures an additional 1 dB has been added to the amplitude of the test transmission waveforms to account for variations in measurement equipment. This will ensure that the test signal is at or above the detection threshold level to trigger a DFS response. | |

Table 3-4: Detection Thresholds for Master Devices and Client Devices with Radar Detection

3.4 Parameters of DFS Test Signals



As the EUT is a Client Device with no Radar Detection only one type radar pulse is required for the testing. Radar Pulse type 1 was used in the evaluation of the Client device for the purpose of measuring the Channel Move Time and the Channel Closing Transmission Time. Table 3-5 lists the parameters for the Short Pulse Radar Waveforms. A plot of the Radar Pulse Type 1 used for testing is included in Section 5.0 of this report.

| Radar Type | Pulse Width (μsec) | PRI (μsec) | Number of Pulses | Minimum Percentage of Successful Detection | Minimum Number of Trials |
|-----------------------------|-----------------------|---------------|------------------------|---|--------------------------------|
| 1 | 1 | 1428 | 18 | 60% | 30 |
| 2 | 1-5 | 150-230 | 23-29 | 60% | 30 |
| 3 | 6-10 | 200-500 | 16-18 | 60% | 30 |
| 4 | 11-20 | 200-500 | 12-16 | 60% | 30 |
| Aggregate (Radar Types 1-4) | | | | 80% | 120 |

Table 3-5: Parameters for Short Pulse Radar Waveforms

| Radar Type | Pulse Width (μsec) | Chirp Width (MHz) | PRI (μsec) | Number of Pulses per Burst | Number of Bursts | Minimum Percentage of Successful Detection | Minimum Number of Trials |
|------------|-----------------------|----------------------|---------------|----------------------------------|---------------------|---|--------------------------------|
| 5 | 50 - 100 | 5 - 20 | 5 - 20 | 1 - 3 | 8 - 20 | 60% | 30 |

Table 3-6. Parameters for Long Pulse Radar Waveforms

| | | | | | |
|--------------------------------------|---|-------------------------------|---|---|---------------------------------|
| FCC ID: ZNFD800 |  | | FCC Pt. 15.407 DFS TEST REPORT (CERTIFICATION) |  | Reviewed by: Quality Manager |
| Test Report S/N: 0Y1306241076.ZNF | Test Dates: 07/15/2013 | EUT Type: Portable Handset | | Page 8 of 21 | |

| Radar Type | Pulse Width (μsec) | PRI (μsec) | Pulses per Hop | Hopping Rate (kHz) | Hopping Sequence Length (msec) | Minimum Percentage of Successful Detection | Minimum Number of Trials |
|------------|--------------------|------------|----------------|--------------------|--------------------------------|--|--------------------------|
| 6 | 1 | 333 | 9 | 0.333 | 300 | 70% | 30 |

Table 3-7. Parameters for Frequency Hopping Radar Waveforms

3.5 Procedure

The FCC 06-96 describes a radiated test setup and a conducted test setup. The conducted test setup was used for this testing. Figure 3-1 shows the typical test setup. In Band 2, one channel selected between 5260 and 5350 MHz is chosen for the testing. In Band 3, one channel selected between 5500 and 5700 MHz was chosen for testing.

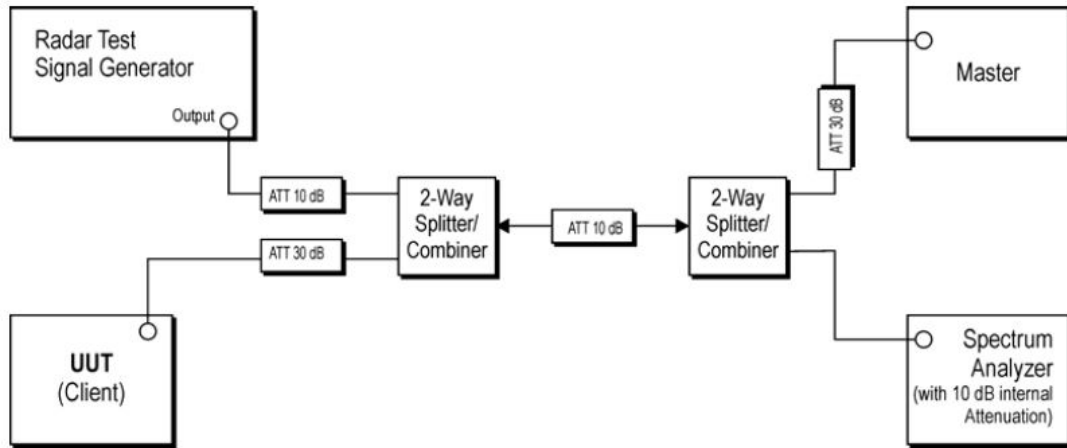

Figure 3-1. Conducted Test Setup for DFS

1. The radar pulse generator is setup to provide a pulse at the frequency that the Master and Client are operating. A Type 1 radar pulse with a 1μs pulse width and a 1428μs PRI is used for the testing.
2. The vector signal generator is adjusted to provide the radar burst (18 pulses) at a level of approximately -62dBm at the antenna of the Master device.
3. A trigger is provided from the pulse generator to the DFS monitoring system in order to capture the traffic and the occurrence of the radar pulse.
4. The Client Device (EUT) is set up per the diagram in Figure 3-1 and communications between the Master device and the Client is established.

| | | | | |
|--------------------------------------|--|---|----|---------------------------------|
| FCC ID: ZNFD800 | PCTEST ENGINEERING LABORATORY, INC. | FCC Pt. 15.407 DFS TEST REPORT (CERTIFICATION) | LG | Reviewed by: Quality Manager |
| Test Report S/N: 0Y1306241076.ZNF | Test Dates: 07/15/2013 | EUT Type: Portable Handset | | Page 9 of 21 |



5. The MPEG file specified by the FCC (“6 ½ Magic Hours”) is streamed from the “file computer” through the Master to the Slave Device and played in full motion video using Media Player Classic Ver. 6.4.8.6 in order to properly load the network.

6. The real time spectrum analyzer is set to record a 12sec window to any transmissions occurring up to and after 10sec.

7. The system is again setup and the monitoring time is shortened in order to capture the Channel Closing Transmission Time. This time is measured to insure that the Client ceases transmission within 200ms and the aggregate of emissions occurring after 200ms up to 10 sec do not exceed 60ms.

(Note: the channel may be different since the Master and Client have changed channels due to the detection of the initial radar pulse.)

8. After the initial radar burst the channel is monitored for 30 minutes to insure no transmissions or beacons occur. A second monitoring setup is used to verify that the Master and Client have both moved to different channels.

| | | | | |
|---|---|--------------------------------------|---|--|
| FCC ID: ZNFD800 |  FCC Pt. 15.407 DFS TEST REPORT (CERTIFICATION) | |  | Reviewed by: Quality Manager |
| Test Report S/N: 0Y1306241076.ZNF | Test Dates: 07/15/2013 | EUT Type: Portable Handset | | Page 10 of 21 |

4.0 TEST EQUIPMENT

Test Equipment Calibration is traceable to the National Institute of Standards and Technology (NIST).

| Manufacturer | Model | Description | Cal Date | Cal Interval | Cal Due | Serial Number |
|--------------|-----------|-----------------------------------|------------|--------------|------------|---------------|
| Agilent | E4448A | PSA (3Hz-50GHz) Spectrum Analyzer | 4/18/2013 | Annual | 4/18/2014 | US42510244 |
| Agilent | E8267C | Vector Signal Generator | 10/10/2011 | Biennial | 10/10/2013 | US42340152 |
| Tektronix | RSA-6114A | Real Time Spectrum Analyzer | 4/17/2013 | Annual | 4/17/2014 | B010177 |



Table 4-1. Annual Test Equipment Calibration Schedule

4.1 Additional Equipment

The following equipment was used in support of the DFS testing.

| Device | Manufacturer | Model/Description | Description | S/N: | FCC ID: |
|--------|---------------|---------------------------|--------------|-------------|-----------|
| Master | Cisco Systems | Aironet AIR-AP1242AG-A-K9 | Access Point | FTX1114B151 | LDK102056 |

Table 4-2. Support Equipment

| | | | | |
|--------------------------------------|---|-------------------------------|---|---------------------------------|
| FCC ID: ZNFD800 |  FCC Pt. 15.407 DFS TEST REPORT (CERTIFICATION) | |  | Reviewed by: Quality Manager |
| Test Report S/N: 0Y1306241076.ZNF | Test Dates: 07/15/2013 | EUT Type: Portable Handset | Page 11 of 21 | |

5.0 TEST PLOTS AND DATA - UNII BAND II

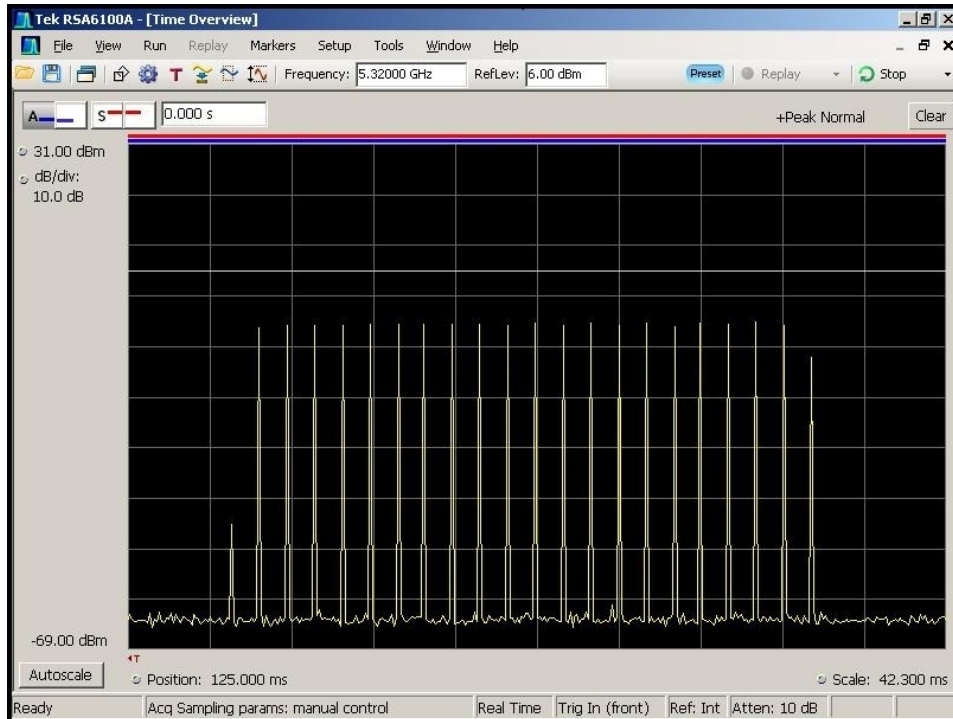

Figure 5-1. Type 1 Radar Pulse

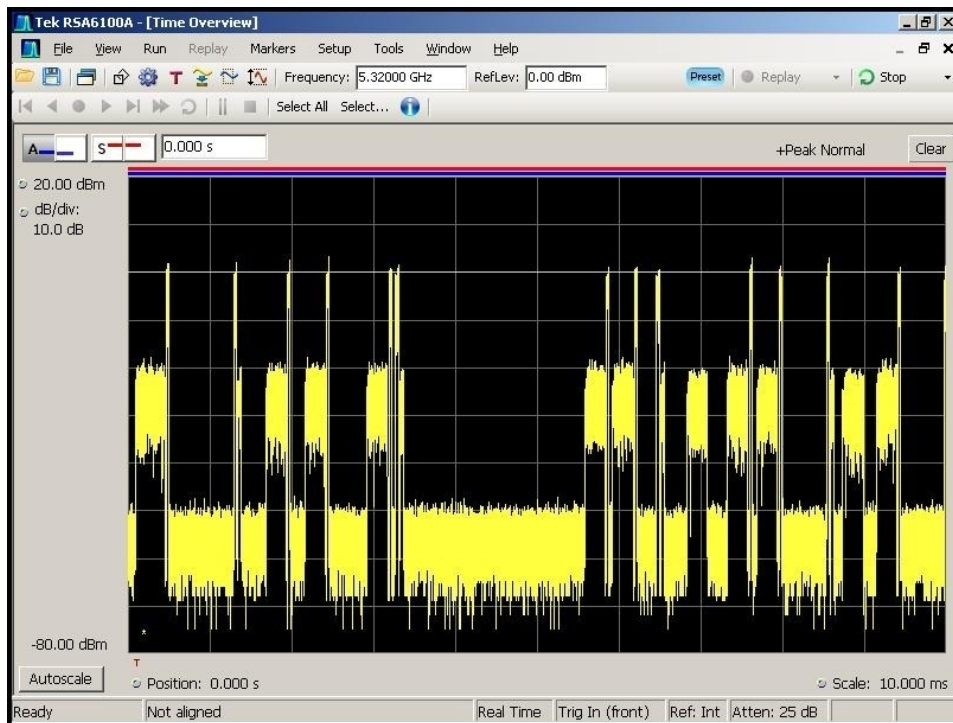



Figure 5-2. Time Display WLAN Channel Traffic (Streaming Video)

| | | | | |
|--------------------------------------|---|---|---|---------------------------------|
| FCC ID: ZNFD800 |  | FCC Pt. 15.407 DFS TEST REPORT (CERTIFICATION) |  | Reviewed by: Quality Manager |
| Test Report S/N: 0Y1306241076.ZNF | Test Dates: 07/15/2013 | EUT Type: Portable Handset | | Page 12 of 21 |

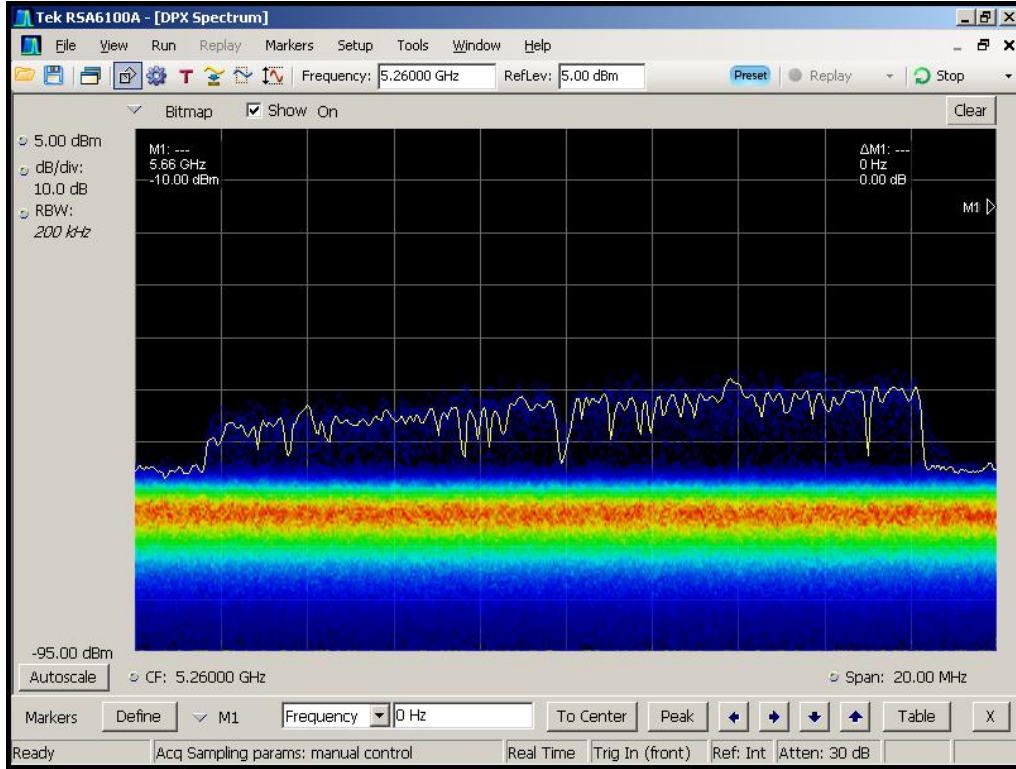

Figure 5-3. Real-Time Spectrum Display, No WLAN Traffic

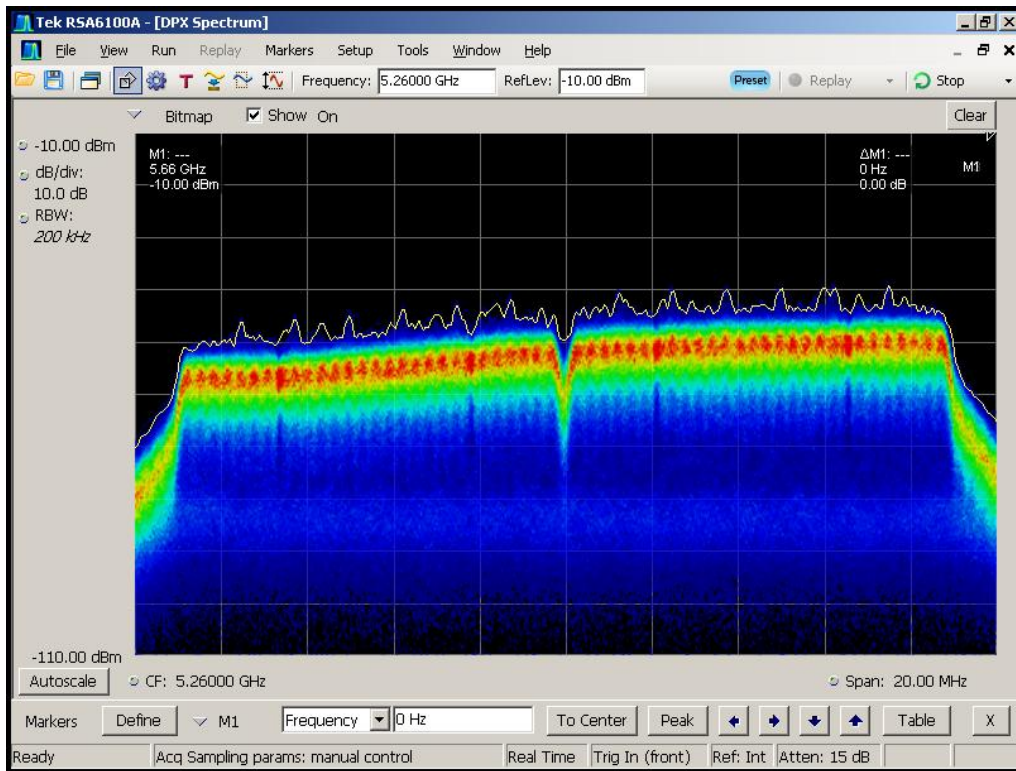

Figure 5-4. Real-Time Spectrum Display, WLAN Traffic (Streaming Video)

| | | | | |
|--------------------------------------|---------------------------|---|--|---------------------------------|
| FCC ID: ZNFD800 | | FCC Pt. 15.407 DFS TEST REPORT (CERTIFICATION) | | Reviewed by: Quality Manager |
| Test Report S/N: 0Y1306241076.ZNF | Test Dates: 07/15/2013 | EUT Type: Portable Handset | | Page 13 of 21 |

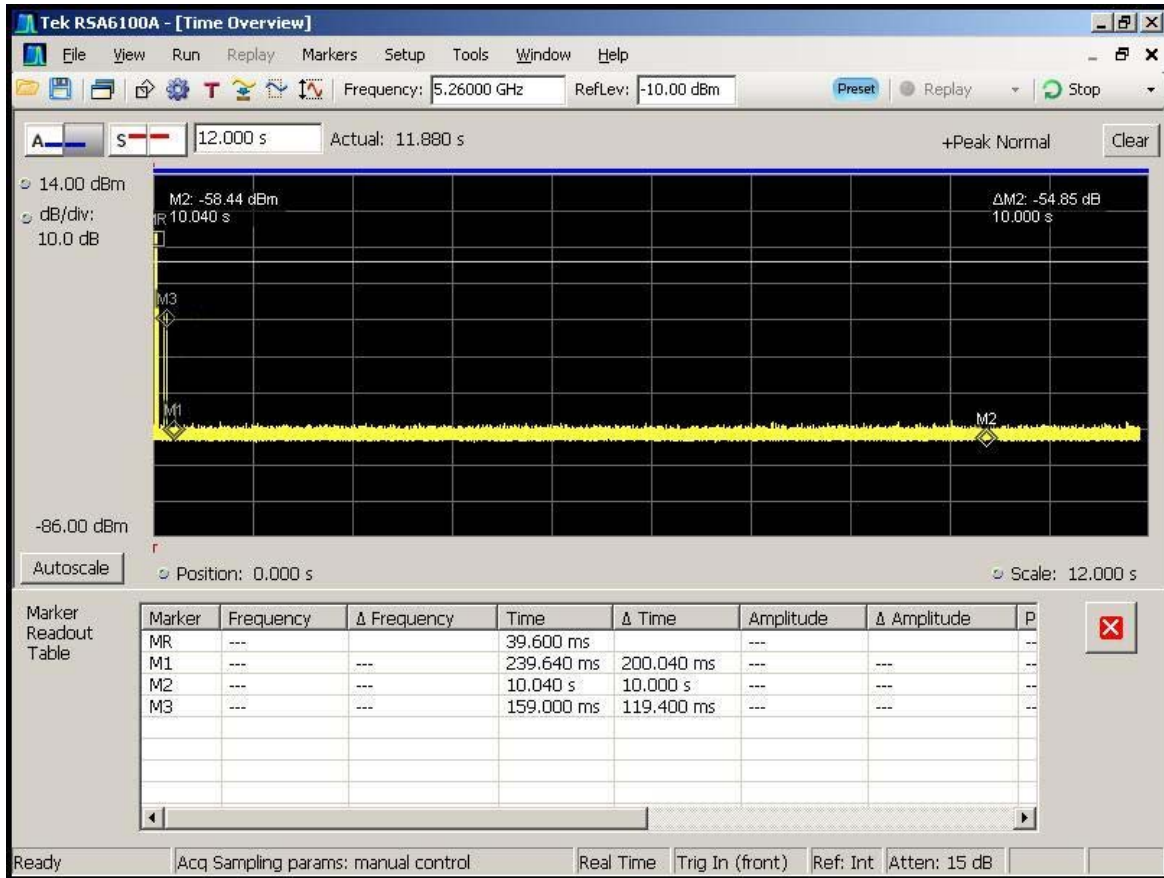

Figure 5-5. Channel Move Time (< 10sec)

Move Time Marker Descriptions:

MR = End of Radar Burst

M1 = 200ms from end of Radar Burst

M2 = 10sec from end of Burst

M3 = Last traffic burst from Client (Channel Move Time)

| | | | | |
|--------------------------------------|---------------------------|---|--|---------------------------------|
| FCC ID: ZNFD800 | | FCC Pt. 15.407 DFS TEST REPORT (CERTIFICATION) | | Reviewed by: Quality Manager |
| Test Report S/N: 0Y1306241076.ZNF | Test Dates: 07/15/2013 | EUT Type: Portable Handset | | Page 14 of 21 |

Calculation of Aggregate Time:

Only client (EUT) transmission pulses after M1 (marker1 @ 200ms) were analyzed.

The aggregate time is calculated as the sum of all pulse widths. In this instance there were no client pulses after the radar burst.

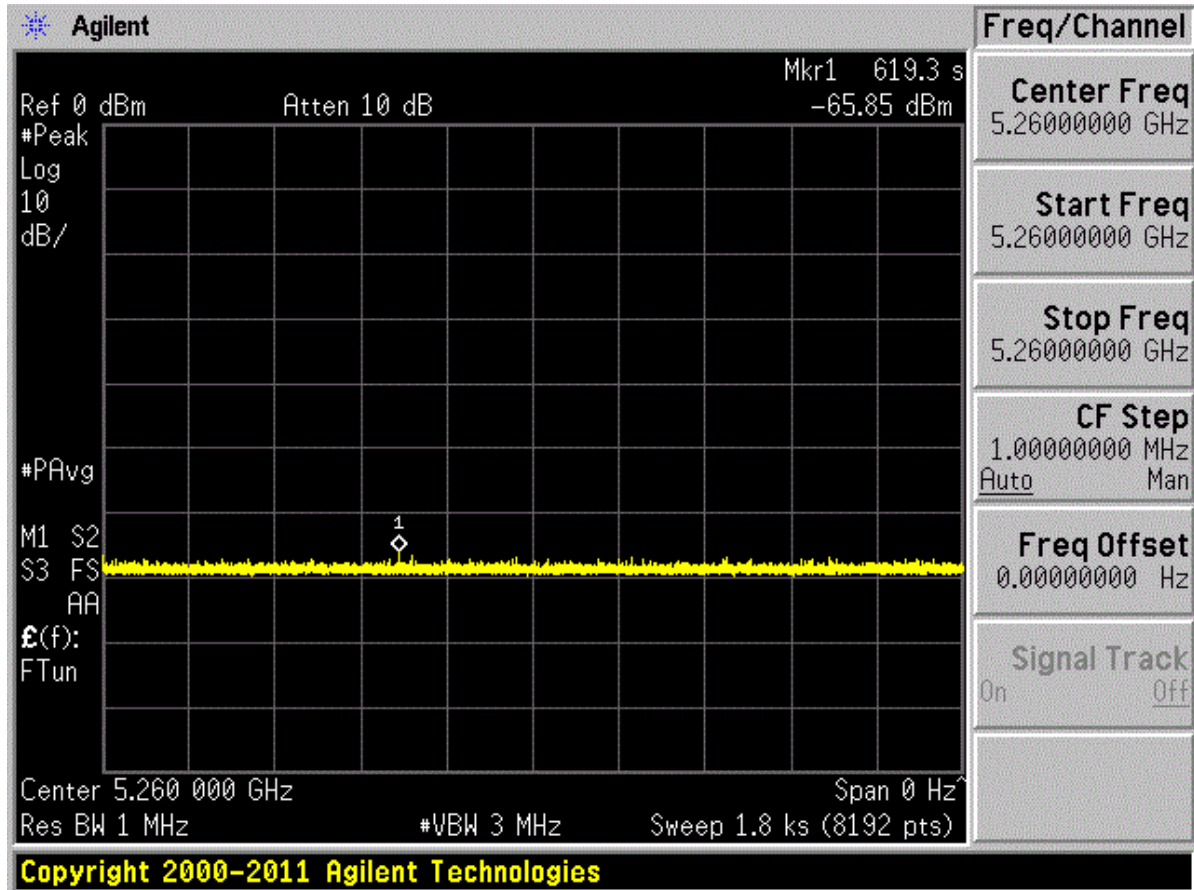

Figure 5-6 Non-occupancy Period - Monitoring live spectrum - Elapse time 30 minutes

| | | | | |
|--------------------------------------|--|---|---------------|---------------------------------|
| FCC ID: ZNFD800 | PCTEST ENGINEERING LABORATORY, INC. | FCC Pt. 15.407 DFS TEST REPORT (CERTIFICATION) | LG | Reviewed by: Quality Manager |
| Test Report S/N: 0Y1306241076.ZNF | Test Dates: 07/15/2013 | EUT Type: Portable Handset | Page 15 of 21 | |

6.0 TEST PLOTS AND DATA - UNII BAND III

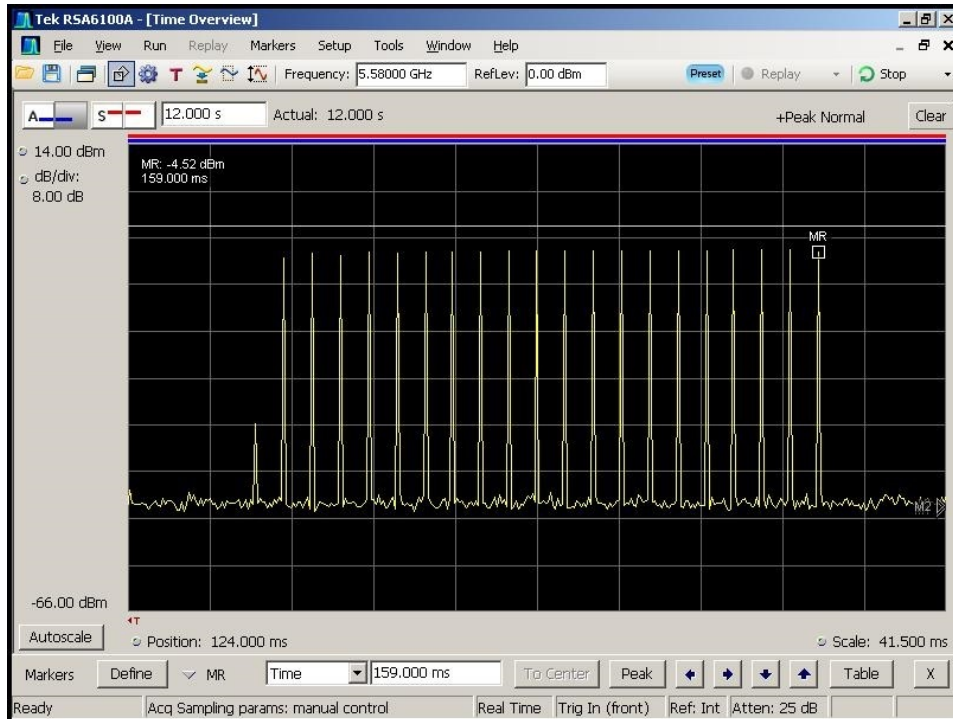

Figure 6-1. Type 1 Radar Pulse

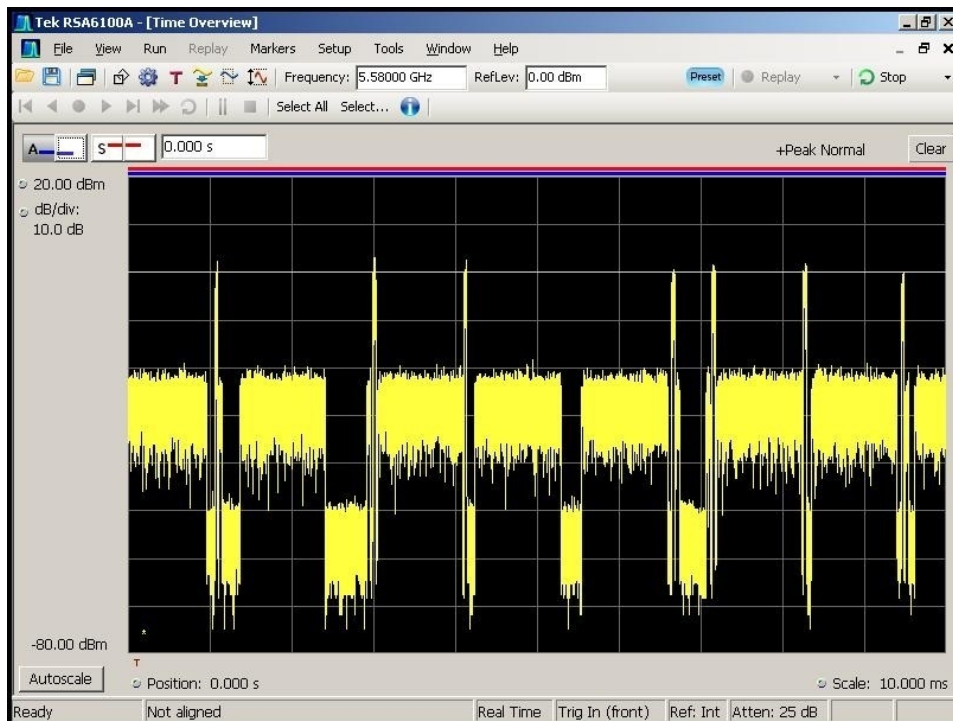

Figure 6-2. Time Display WLAN Channel Traffic (Streaming Video)

| | | | |
|--------------------------------------|---------------------------|---|---------------------------------|
| FCC ID: ZNFD800 | | FCC Pt. 15.407 DFS TEST REPORT (CERTIFICATION) | |
| Test Report S/N: 0Y1306241076.ZNF | Test Dates: 07/15/2013 | EUT Type: Portable Handset | Reviewed by: Quality Manager |

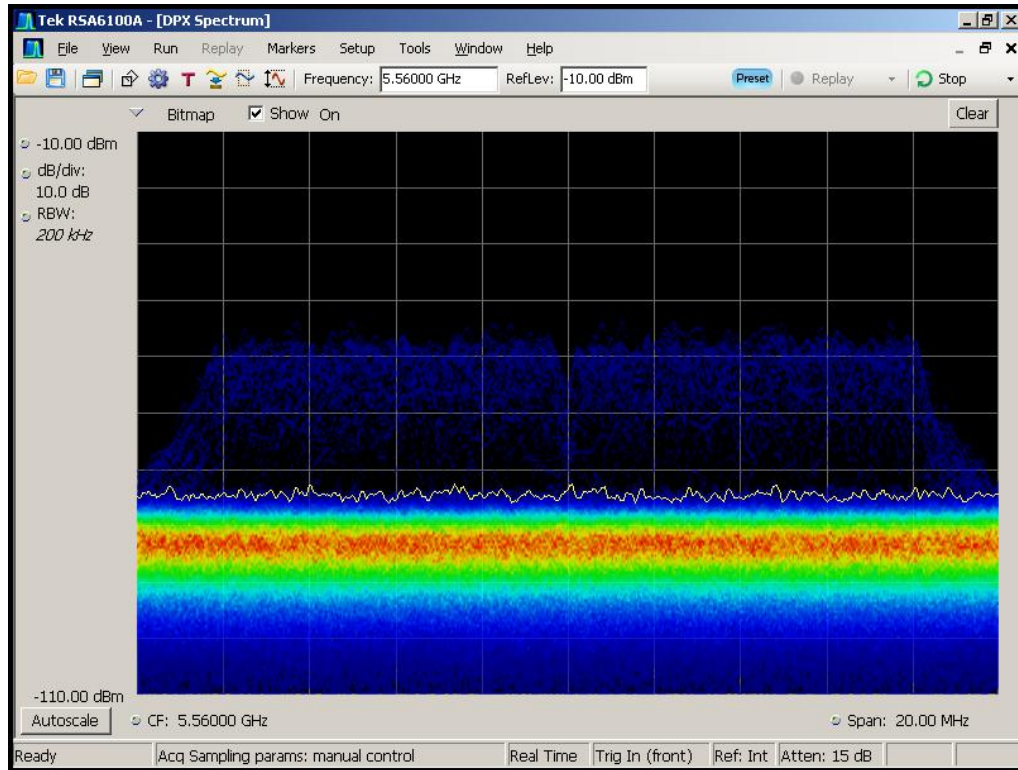

Figure 6-3. Real-Time Spectrum Display, No WLAN Traffic

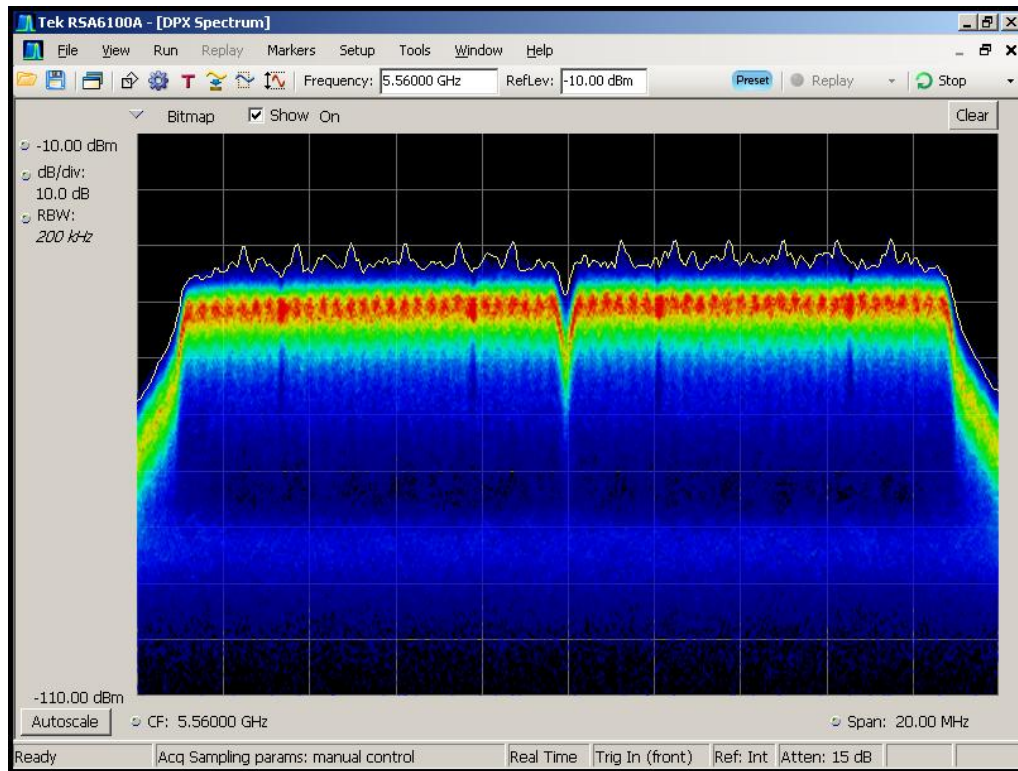



Figure 6-4. Real-Time Spectrum Display, WLAN Traffic (Streaming Video)

| | | | | |
|--------------------------------------|---|---|---|---------------------------------|
| FCC ID: ZNFD800 |  | FCC Pt. 15.407 DFS TEST REPORT (CERTIFICATION) |  | Reviewed by: Quality Manager |
| Test Report S/N: 0Y1306241076.ZNF | Test Dates: 07/15/2013 | EUT Type: Portable Handset | | Page 17 of 21 |

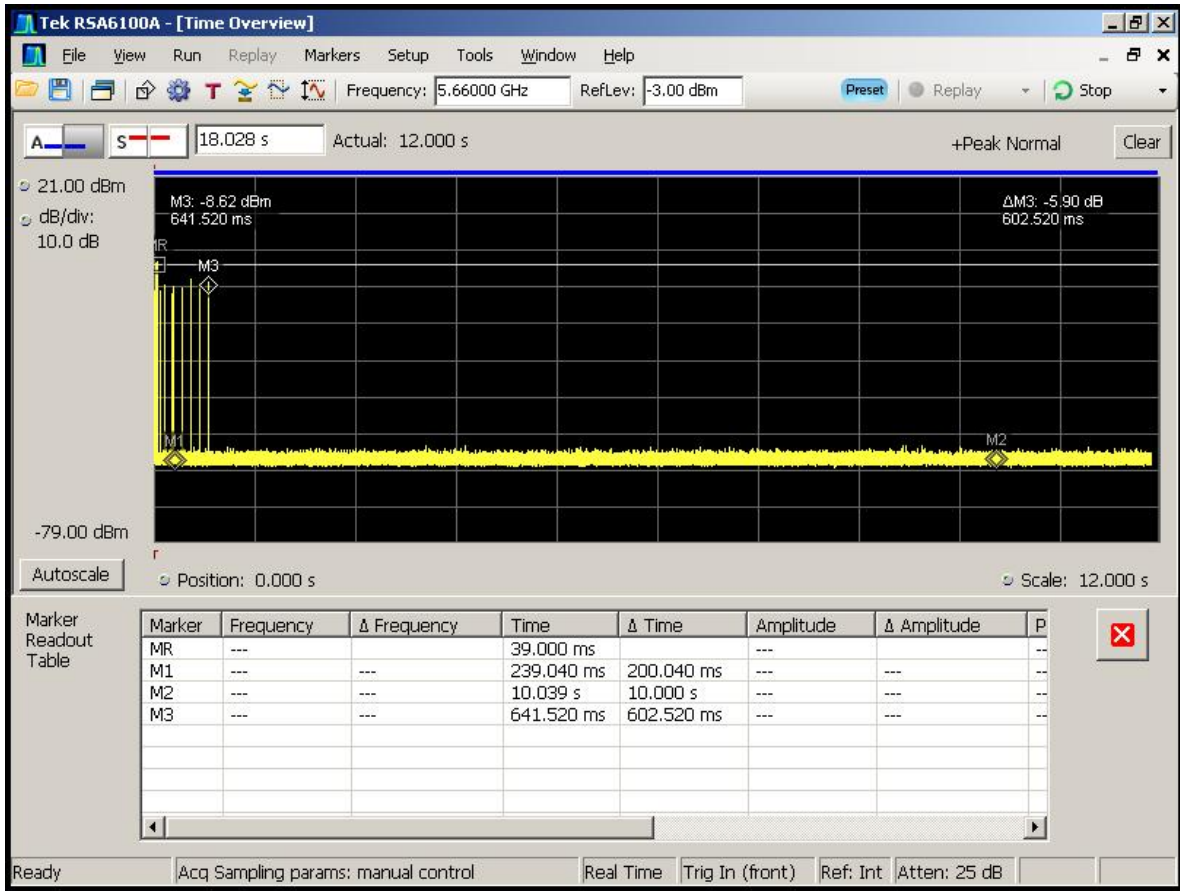

Figure 6-5. Channel Move Time (< 10sec)



Marker Descriptions:

MR = End of Radar Burst

M1 = 200ms from end of Radar Burst

M2 = 10sec from end of Burst

M3= Last traffic burst from Client (Channel Move Time)

| | | | | |
|--------------------------------------|---|-------------------------------|---|---------------------------------|
| FCC ID: ZNFD800 |  FCC Pt. 15.407 DFS TEST REPORT (CERTIFICATION) | |  | Reviewed by: Quality Manager |
| Test Report S/N: 0Y1306241076.ZNF | Test Dates: 07/15/2013 | EUT Type: Portable Handset | Page 18 of 21 | |

Calculation of Aggregate Time:

The aggregate time was calculated using the “Pulse Table” capability on the Tektronix RSA 6114A Real-Time Spectrum Analyzer. This capability generates a table(s) that includes all the pulses and their corresponding pulse widths. The pulses are detected using a specified power threshold set by the user which allows for detection of all client (EUT) pulses. Only client (EUT) transmission pulses after M1 (marker1 @ 200ms) were analyzed.

The aggregate time is calculated as the sum of all pulse widths.

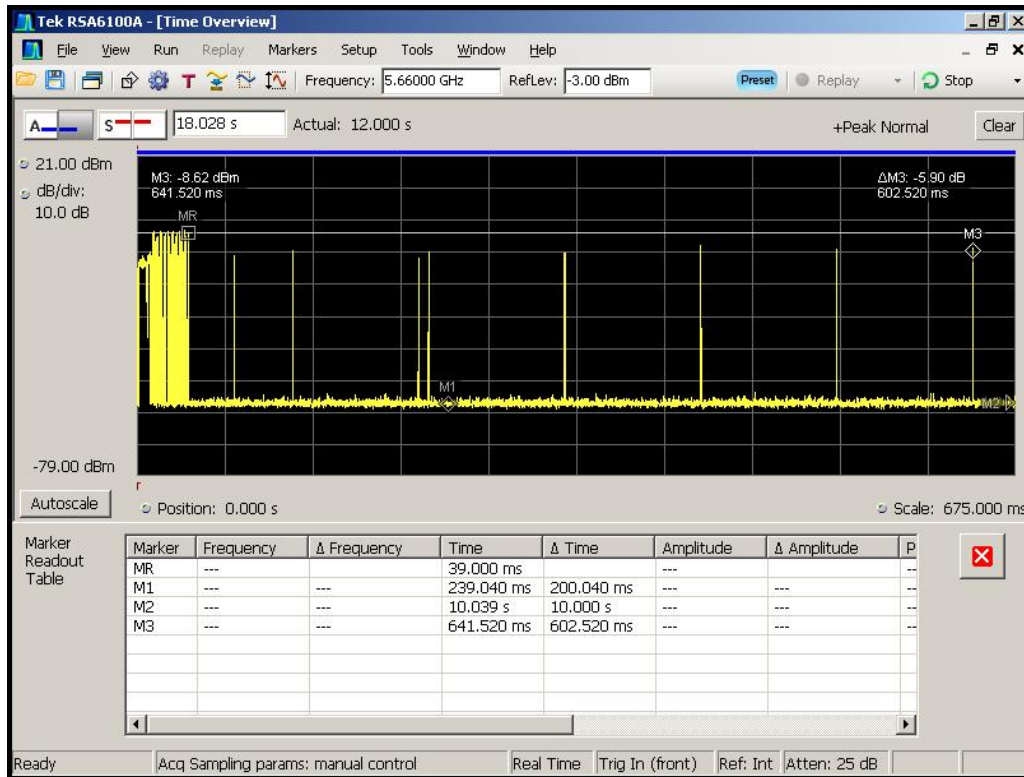

Figure 6-6. Aggregate Time Plot

| Band | Number of Pulses | Aggregate Time (ms) | Limit (ms) | Pass/Fail |
|------|------------------|---------------------|------------|-----------|
| 3 | 4 | 0.26 | 60 | Pass |

Table 6-1. Summary of Pulse Table Analysis

| | | | | |
|--------------------------------------|---------------------------|---|--|---------------------------------|
| FCC ID: ZNFD800 | | FCC Pt. 15.407 DFS TEST REPORT (CERTIFICATION) | | Reviewed by: Quality Manager |
| Test Report S/N: 0Y1306241076.ZNF | Test Dates: 07/15/2013 | EUT Type: Portable Handset | | Page 19 of 21 |

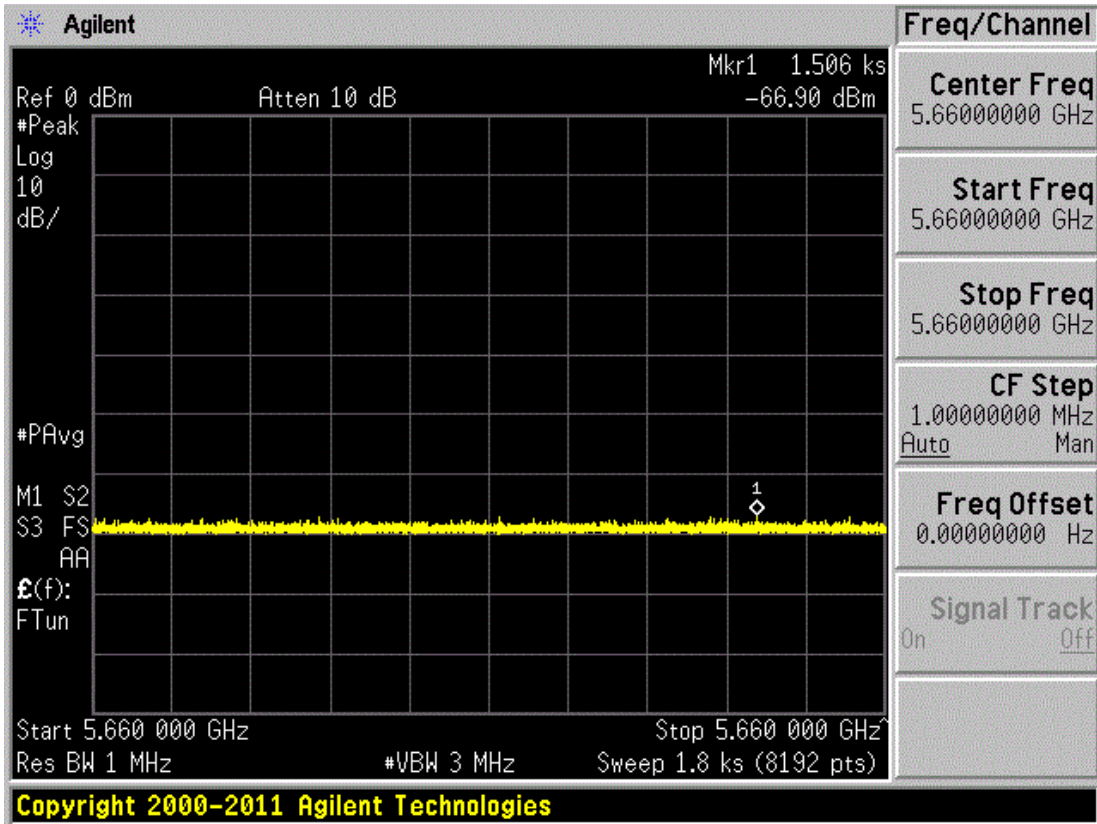



Figure 6-7. Non-occupancy Period - Monitoring live spectrum - Elapse time 30 minutes

| | | | | |
|--------------------------------------|--|---|----|---------------------------------|
| FCC ID: ZNFD800 | PCTEST ENGINEERING LABORATORY, INC. | FCC Pt. 15.407 DFS TEST REPORT (CERTIFICATION) | LG | Reviewed by: Quality Manager |
| Test Report S/N: 0Y1306241076.ZNF | Test Dates: 07/15/2013 | EUT Type: Portable Handset | | Page 20 of 21 |

7.0 CONCLUSION

The data collected relate only to the item(s) tested and show that the LG **Portable Handset FCC ID: ZNFD800** is in compliance with the DFS requirements for a Client Device without radar detection in accordance with Part 15.407 of the FCC Rules.

| | | | | |
|---|---|---|---|--|
| FCC ID: ZNFD800 |  | FCC Pt. 15.407 DFS TEST REPORT (CERTIFICATION) |  | Reviewed by: Quality Manager |
| Test Report S/N: 0Y1306241076.ZNF | Test Dates: 07/15/2013 | EUT Type: Portable Handset | Page 21 of 21 | |