

SAR TEST REPORT

HCT CO., LTD

EUT Type:	Cellular/PCS GSM/GPRS/EDGE/WCDMA/HSDPA/HSUPA Phone with Bluetooth WLAN and NFC(Felica)
FCC ID:	ZNFD605
Model:	LG-D605
Additional Model	D605, LGD605
Date of Issue:	Aug. 02, 2013
Test report No.:	HCTA1308FS01
Test Laboratory:	HCT CO., LTD. 74, Seoicheon-ro 578 beon-gil, Majang-myeon, Icheon-si, Gyeonggi-do, Korea TEL: +82 31 645 6300 FAX: +82 31 645 6401
Applicant :	LG Electronics, MobileComm U.S.A., Inc. 1000 Sylvan Avenue, Englewood Cliffs NJ 07632
Testing has been carried out in accordance with:	RSS-102 Issue 4; Health Canada Safety Code 6 47CFR §2.1093 FCC OET Bulletin 65(Edition 97-01), Supplement C (Edition 01-01) ANSI/ IEEE C95.1 – 1992 IEEE 1528-2003
Test result:	The tested device complies with the requirements in respect of all parameters subject to the test. The test results and statements relate only to the items tested. The test report shall not be reproduced except in full, without written approval of the laboratory.
Signature	<div style="display: flex; justify-content: space-around; align-items: flex-end;"> <div style="text-align: center;">  <hr style="width: 100%; border: 0.5px solid black;"/> <p>Report prepared by : Young-Soo Jang Test Engineer of SAR Part</p> </div> <div style="text-align: center;">  <hr style="width: 100%; border: 0.5px solid black;"/> <p>Approved by : Jae-Sang So Manager of SAR Part</p> </div> </div>

Table of Contents

1. INTRODUCTION	4
2. TEST METHODOLOGY	5
3. DESCRIPTION OF DEVICE.....	6
4. DESCRIPTION OF TEST EQUIPMENT	7
5. SAR MEASUREMENT PROCEDURE.....	1 5
6. DESCRIPTION OF TEST POSITION.....	1 7
7. MEASUREMENT UNCERTAINTY	1 9
8. ANSI/ IEEE C95.1 - 1992 RF EXPOSURE LIMITS	2 1
9. SAR SYSTEM VALIDATION.....	2 2
10. SYSTEM VERIFICATION.....	2 3
11. RF CONDUCTED POWER MEASUREMENT	2 5
12. SAR Test configuration & Antenna Information	4 8
13. SAR TEST DATA SUMMARY	4 9
13.1 Measurement Results (GSM850 Head SAR).....	4 9
13.2 Measurement Results (GSM1900 Head SAR).....	5 0
13.3 Measurement Results (WCDMA850 Head SAR).....	5 1
13.4 Measurement Results (WCDMA1900 Head SAR).....	5 2
13.5 Measurement Results (DTS Head SAR).....	5 3
13.6 Measurement Results (NII Head SAR).....	5 4
13.7 Measurement Results (GSM850 Hotspot SAR).....	5 5
13.8 Measurement Results (GSM1900 Hotspot SAR).....	5 6
13.9 Measurement Results (WCDMA850 Hotspot SAR).....	5 7
13.10 Measurement Results (WCDMA1900 Hotspot SAR).....	5 8
13.11 Measurement Results (WLAN Hotspot SAR).....	5 9
13.12 Measurement Results (DTS Body-worn)	6 0
13.13 Measurement Results (NII Body-worn SAR).....	6 1
13.14 Measurement Results (Body-worn SAR)	6 2
14. SAR Measurement Variability and Uncertainty.....	6 3
15. SAR Summation Scenario	6 4
17. REFERENCES	7 1
Attachment 1. – SAR Test Plots	7 2
Attachment 2. – Dipole Verification Plots.....	1 0 3
Attachment 3. – Probe Calibration Data	1 1 8
Attachment 4. – Dipole Calibration Data	1 5 2

Version

Rev	DATE	DESCRIPTION
	Aug. 02, 2013	First Approval Report

1. INTRODUCTION

The FCC has adopted the guidelines for evaluating the environmental effects of radio frequency radiation in ET Docket 93-62 on Aug. 6, 1996 to protect the public and workers from the potential hazards of RF emissions due to FCC-regulated portable devices.

The safety limits used for the environmental evaluation measurements are based on the criteria published by the American National Standards Institute (ANSI) for localized specific absorption rate (SAR) in IEEE/ANSI C95.1-1992 Standard for Safety Levels with Respect to Human Exposure to Radio Frequency Electromagnetic Fields, 3 kHz to 300 GHz. 1992 by the Institute of Electrical and Electronics Engineers, Inc., New York, New York 10017. The measurement procedure described in IEEE/ANSI C95.3-1992 Recommended Practice for the Measurement of Potentially Hazardous Electromagnetic Fields – RF and Microwave is used for guidance in measuring SAR due to the RF radiation exposure from the Equipment Under Test (EUT). These criteria for SAR evaluation are similar to those recommended by the National Council on Radiation Protection and Measurements (NCRP) in Biological Effects and Exposure Criteria for Radio frequency Electromagnetic Fields,” NCRP Report No. 86 NCRP, 1986, Bethesda, MD 20814. SAR is a measure of the rate of energy absorption due to exposure to an RF transmitting source. SAR values have been related to threshold levels for potential biological hazards.

SAR Definition

Specific Absorption Rate (SAR) is defined as the time derivative of the incremental electromagnetic energy (dW) absorbed by (dissipated in) an incremental mass (dm) contained in a volume element (dV) of a given density (ρ). It is also defined as the rate of RF energy absorption per unit mass at a point in an absorbing body.

$$SAR = \frac{d}{dt} \left(\frac{dU}{dm} \right) = \frac{d}{dt} \left(\frac{dU}{\rho dV} \right)$$

Figure 2. SAR Mathematical Equation

SAR is expressed in units of Watts per Kilogram (W/kg).

where:

SAR	=	$\sigma E^2 / \rho$
σ	=	conductivity of the tissue-simulant material (S/m)
ρ	=	mass density of the tissue-simulant material (kg/m ³)
E	=	Total RMS electric field strength (V/m)

NOTE: The primary factors that control rate of energy absorption were found to be the wavelength of the incident field in relations to the dimensions and geometry of the irradiated organism, the orientation of the organism in relation to the polarity of field vectors, the presence of reflecting surfaces, and whether conductive contact is made by the organism with a ground plane.

2. TEST METHODOLOGY

The tests documented in this report were performed in accordance with FCC OET Bulletin 65 Supplement C 01-01, IEEE Standard 1528-2003 & IEEE 1528a-2005 and the following published KDB procedures.

- FCC KDB Publication 941225 D01 SAR test for 3G devices v02
- FCC KDB Publication 941225 D02 HSPA and 1x Advanced v02r02
- FCC KDB Publication 941225 D03 SAR Test Reduction GSM GPRS EDGE v01
- FCC KDB Publication 941225 D04 SAR for GSM E GPRS Dual Xfer Mode v01
- FCC KDB Publication 941225 D06 Hot Spot SAR v01r01
- FCC KDB Publication 248227 D01v01r02(SAR Consideration for 802.11 Devices)
- FCC KDB Publication 447498 D01 General RF Exposure v05r01
- FCC KDB Publication 648474 D04 Handset SAR v01r01
- FCC KDB Publication 865664 D01 SAR Measurement 100 MHz to 6 GHz v01r01
- FCC KDB Publication 865664 D02 RF Exposure Reporting v01r01

3. DESCRIPTION OF DEVICE

Environmental evaluation measurements of specific absorption rate (SAR) distributions in emulated human head and body tissues exposed to radio frequency (RF) radiation from wireless portable devices for compliance with the rules and regulations of the U.S. Federal Communications Commission (FCC).

EUT Type	Cellular/PCS GSM/GPRS/EDGE/WCDMA/HSDPA/HSUPA Phone with Bluetooth WLAN and NFC(Felica)					
FCC ID:	ZNFD605					
Model:	LG-D605					
Additional Model	D605, LGD605					
Trade Name	LG Electronics, MobileComm U.S.A., Inc.					
Application Type	Certification					
Mode(s) of Operation	GSM850/ GSM1900/ WCDMA850/ WCDMA1900/ 802.11 a/b/g/n					
Tx Frequency	824.2 - 848.8 MHz (GSM850) / 1 850.2 – 1 909.8 MHz (GSM1900) 826.4 - 846.6 MHz (WCDMA850) / 1 852.4 – 1 907.6 MHz (WCDMA1900) 2 412- 2 462 MHz (802.11b/g/n) 5180-5240MHz/ 5260-5320 MHz/ 5500-5700 MHz/ 5745-5825 MHz (802.11a/n)					
Production Unit or Identical Prototype	Prototype					
Max SAR	Band	Tx Frequency (MHz)	Equipment Class	Reported 1 g SAR (W/kg)		
				Head	Body-worn	Hotspot
	GSM850	824.2 - 848.8	PCE	0.42	0.59	0.59
	GSM1900	1 850.2 - 1 909.8	PCE	0.25	0.82	0.82
	WCDMA850	826.4 - 846.6	PCE	0.34	0.52	0.52
	WCDMA1900	1 852.4 – 1 907.6	PCE	0.19	0.53	0.53
	Bluetooth	2 402 – 2 480	DSS	-		
	802.11b	2 412 – 2 462	DTS	0.44	0.26	0.26
	802.11a	5 180 – 5 240	UNII	0.04	0.35	-
	802.11a	5 260 – 5 320	UNII	0.07	0.38	-
	802.11a	5 500 – 5 700	UNII	0.06	0.36	-
802.11a	5 745 – 5 825	DTS	0.07	0.07	-	
Simultaneous SAR per KDB 690783 D01				0.76	1.205	1.08
Date(s) of Tests	Jul. 22, 2013 ~ Jul. 29, 2013					
Antenna Type	Integral Antenna					
GPRS	Multislot Class: 12 Mode Class: B					
Key Feature(s)	This device supports Mobile Hotspot.					

4. DESCRIPTION OF TEST EQUIPMENT

4.1 SAR MEASUREMENT SETUP

These measurements are performed using the DASY4 automated dosimetric assessment system. It is made by Schmid & Partner Engineering AG (SPEAG) in Zurich, Switzerland. It consists of high precision robotics system (Staubli), robot controller, Pentium III computer, near-field probe, probe alignment sensor, and the generic twin phantom containing the brain equivalent material. The robot is a six-axis industrial robot performing precise movements to position the probe to the location (points) of maximum electromagnetic field (EMF) (see Figure.4.1).

A cell controller system contains the power supply, robot controller, teach pendant (Joystick), and remote control, is used to drive the robot motors. The PC consists of the HP Pentium IV 3.0 GHz computer with Windows XP system and SAR Measurement Software DASY4, A/D interface card, monitor, mouse, and keyboard. The Staubli Robot is connected to the cell controller to allow software manipulation of the robot. A data acquisition electronic (DAE) circuit performs the signal amplification, signal multiplexing, AD-conversion, offset measurements, mechanical surface detection, collision detection, etc. is connected to the Electro-optical coupler (EOC). The EOC performs the conversion from the optical into digital electric signal of the DAE and transfers data to the PC plug-in card.

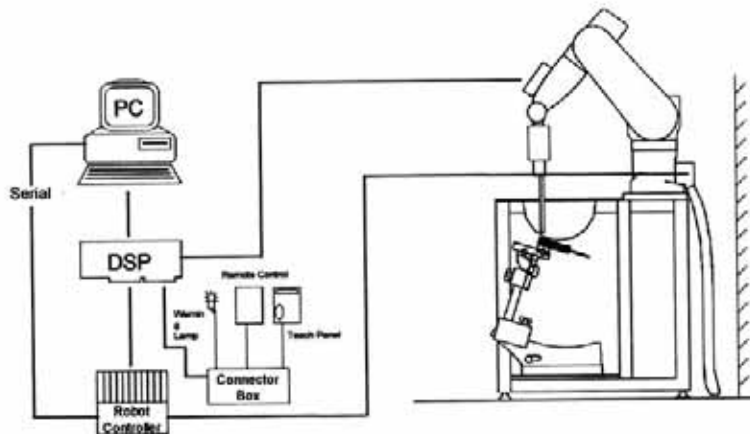

Figure 4.1 HCT SAR Lab. Test Measurement Set-up

The DAE4 consists of a highly sensitive electrometer-grade preamplifier with auto-zeroing, a channel and gain-switching multiplexer, a fast 16 bit AD-converter and a command decoder and control logic unit. Transmission to the PC-card is accomplished through an optical downlink for data and status information and an optical uplink for commands and clock lines. The mechanical probe mounting device includes two different sensor systems for frontal and sidewise probe contacts. They are also used for mechanical surface detection and probe collision detection. The robot uses its own controller with a built in VME-bus computer. The system is described in detail in.

4.2 DASYS E-FIELD PROBE SYSTEM

4.2.1 ET3DV6 Probe Specification

Construction	Symmetrical design with triangular core Built-in optical fiber for surface detection System Built-in shielding against static charges
Calibration	In air from 10 MHz to 2.5 GHz In brain and muscle simulating tissue at Frequencies of 450 MHz, 900 MHz and 1.8 GHz (accuracy: 8 %)
Frequency	10 MHz to > 3 GHz; Linearity: ± 0.2 dB (30 MHz to 3 GHz)
Directivity	± 0.2 dB in brain tissue (rotation around probe axis) ± 0.4 dB in brain tissue (rotation normal probe axis)
Dynamic	5 μ W/g to > 100 mW/g;
Range Linearity:	± 0.2 dB
Surface Detection	± 0.2 mm repeatability in air and clear liquids over diffuse reflecting surfaces.
Dimensions	Overall length: 330 mm Tip length: 16 mm Body diameter: 12 mm Tip diameter: 6.8 mm Distance from probe tip to dipole centers: 2.7 mm
Application	General dissymmetry up to 3 GHz Compliance tests of WCDMA/LTE Phones Fast automatic scanning in arbitrary phantoms



Figure 4.1 Photograph of the probe and the Phantom



Figure 3.3 ET3DV6 E-field Probe

The SAR measurements were conducted with the dosimetric probe ET3DV6, designed in the classical triangular configuration and optimized for dosimetric evaluation. The probe is constructed using the thick film technique; with printed resistive lines on ceramic substrates. The probe is equipped with an optical multifiber line ending at the front of the probe tip. It is connected to the EOC box on the robot arm and provides an automatic detection of the phantom surface. Half of the fibers are connected to a pulsed infrared transmitter, the other half to a synchronized receiver. As the probe approaches the surface, the reflection from the surface produces a coupling from the transmitting to the receiving fibers. This reflection increases first during the approach, reaches a maximum and then decreases. If the probe is flatly touching the surface, the coupling is zero. The distance of the coupling maximum to the surface is independent of the surface reflectivity and largely independent of the surface to probe angle. The DASYS4 software reads the reflection during a software approach and looks for the maximum using a 2nd order fitting. The approach is stopped at reaching the maximum.

4.2.2 EX3DV4 Probe Specification

Construction	Symmetrical design with triangular core Built-in optical fiber for surface detection System Built-in shielding against static charges
Calibration	In air from 10 MHz to 6 GHz In brain and muscle simulating tissue at Frequencies of 450 MHz, 900 MHz and 1.8 GHz (accuracy: 8 %)
Frequency	10 MHz to > 6 GHz; Linearity: ± 0.2 dB (30 MHz to 6 GHz)
Directivity	± 0.3 dB in HSL (rotation around probe axis) ± 0.5 dB in tissue material (rotation normal to probe axis)
Dynamic Range	10 μ W/g to > 100 mW/g;
Linearity	± 0.2 dB
Surface Detection	± 0.2 mm repeatability in air and clear liquids over diffuse reflecting surfaces.
Dimensions	Overall length: 337 mm Tip length: 20 mm Body diameter: 12 mm Tip diameter: 2.5 mm Distance from probe tip to dipole centers: 1 mm
Application	General dissymmetry up to 3 GHz Compliance tests of mobile GSM/WCDMA Phones Fast automatic scanning in arbitrary phantoms

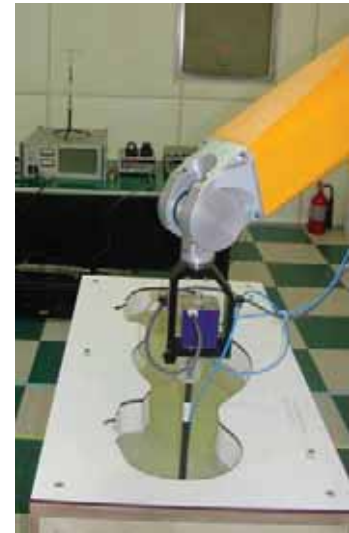

Figure 4.2 Photograph of the probe and the Phantom

The SAR measurements were conducted with the dosimetric probe EX3DV4, designed in the classical triangular configuration and optimized for dosimetric evaluation. The probe is constructed using the thick film technique; with printed resistive lines on ceramic substrates. The probe is equipped with an optical multifiber line ending at the front of the probe tip. It is connected to the EOC box on the robot arm and provides an automatic detection of the phantom surface. Half of the fibers are connected to a pulsed infrared transmitter, the other half to a synchronized receiver. As the probe approaches the surface, the reflection from the surface produces a coupling from the transmitting to the receiving fibers. This reflection increases first during the approach, reaches a maximum and then decreases. If the probe is flatly touching the surface, the coupling is zero. The distance of the coupling maximum to the surface is independent of the surface reflectivity and largely independent of the surface to probe angle. The DASY4 software reads the reflection during a software approach and looks for the maximum using a 2nd order fitting. The approach is stopped at reaching the maximum.



Figure 4.3 EX3DV4 E-field Probe

4.3 PROBE CALIBRATION PROCESS

4.3.1 E-Probe Calibration

Each probe is calibrated according to a dosimetric assessment procedure with an accuracy better than 10 %. The spherical isotropy was evaluated with the proper procedure and found to be better than 0.25 dB. The sensitivity parameters (NormX, NormY, NormZ), the diode compression parameter (DCP) and the conversion factor (ConvF) of the probe is tested.

The free space E-field from amplified probe outputs is determined in a test chamber. This is performed in a TEM cell for frequencies bellow 1 GHz, and in a waveguide above 1 GHz for free space. For the free space calibration, the probe is placed in the volumetric center of the cavity and at the proper orientation with the field. The probe is then rotated 360 degrees.

E-field temperature correlation calibration is performed in a flat phantom filled with the appropriate simulated brain tissue. The measured free space E-field in the medium correlates to temperature rise in a dielectric medium. For temperature correlation calibration a RF transparent thermistor-based temperature probe is used in conjunction with the E-field probe.

$$SAR = C \frac{\Delta T}{\Delta t}$$

where:

- Δt = exposure time (30 seconds),
- C = heat capacity of tissue (brain or muscle),
- ΔT = temperature increase due to RF exposure.

SAR is proportional to $\Delta T / \Delta t$, the initial rate of tissue heating, before thermal diffusion takes place. Now it's possible to quantify the electric field in the simulated tissue by equating the thermally derived SAR to the E- field;

$$SAR = \frac{|E|^2 \cdot \sigma}{\rho}$$

where:

- σ = simulated tissue conductivity,
- ρ = Tissue density (1.25 g/cm³ for brain tissue)

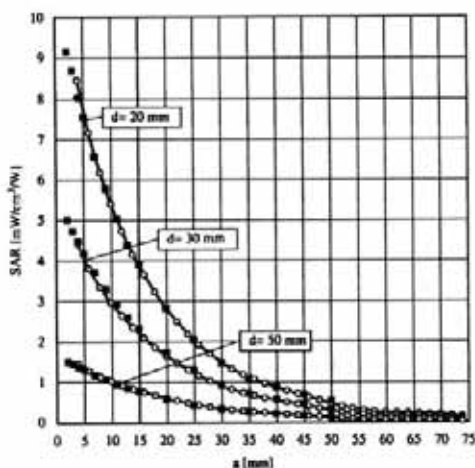

Figure 4.4 E-Field and Temperature measurements at 900 MHz

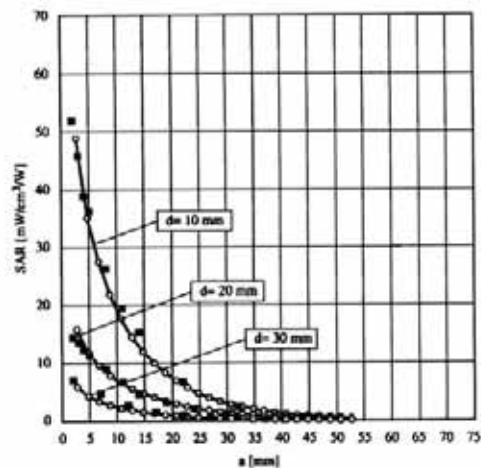

Figure 4.5 E-Field and temperature measurements at 1.8 GHz

4.3.2 Data Extrapolation

The DASY4 software automatically executes the following procedures to calculate the field units from the microvolt readings at the probe connector. The first step of the evaluation is a linearization of the filtered input signal to account for the compression characteristics of the detector diode. The compensation depends on the input signal, the diode type and the DC-transmission factor from the diode to the evaluation electronics. If the exciting field is pulsed, the crest factor of the signal must be known to correctly compensate for peak power. The formula for each channel can be given like below;

$$V_i = U_i + U_i^2 \cdot \frac{cf}{dcp_i}$$

with V_i = compensated signal of channel i (i=x,y,z)
 U_i = input signal of channel i (i=x,y,z)
 cf = crest factor of exciting field (DASY parameter)
 dcp_i = diode compression point (DASY parameter)

From the compensated input signals the primary field data for each channel can be evaluated:

E-field probes:

$$E_i = \sqrt{\frac{V_i}{Norm_i \cdot ConvF}}$$

with V_i = compensated signal of channel i (i = x,y,z)
 $Norm_i$ = sensor sensitivity of channel i (i = x,y,z)
 $\mu V/(V/m)^2$ for E-field probes
 $ConvF$ = sensitivity of enhancement in solution
 E_i = electric field strength of channel i in V/m

The RSS value of the field components gives the total field strength (Hermetian magnitude):

$$E_{tot} = \sqrt{E_x^2 + E_y^2 + E_z^2}$$

The primary field data are used to calculate the derived field units.

$$SAR = E_{tot}^2 \cdot \frac{\sigma}{\rho \cdot 1000}$$

with SAR = local specific absorption rate in W/g
 E_{tot} = total field strength in V/m
 σ = conductivity in [mho/m] or [Siemens/m]
 ρ = equivalent tissue density in g/cm³

The power flow density is calculated assuming the excitation field to be a free space field.

$$P_{pwr} = \frac{E_{tot}^2}{3770}$$

with P_{pwr} = equivalent power density of a plane wave in W/cm²
 E_{tot} = total electric field strength in V/m

4.4 SAM Phantom

The shell corresponds to the specifications of the Specific Anthropomorphic Mannequin (SAM) phantom defined in IEEE 1528 and IEC 62209-1. It enables the dosimetric evaluation of left and right hand phone usage as well as body mounted usage at the flat phantom region. A cover prevents evaporation of the liquid. Reference markings on the phantom allow the complete setup of all predefined phantom positions and measurement grids by teaching three points with the robot.



Shell Thickness	2.0 mm ± 0.2 mm (6 ± 0.2 mm at ear point)	
Filling Volume	about 25 L	
Dimensions	810 mm x 1 000 mm x 500 mm (H x L x W)	Figure 4.6 SAM Phantom

Triple Modular Phantom consists of three identical modules which can be installed and removed separately without emptying the liquid. It includes three reference points for phantom installation. Covers prevent evaporation of the liquid. Phantom material is resistant to DGBE based tissue simulating liquids. The MFP V5.1 will be delivered including wooden support only (**non-standard** SPEAG support).

Applicable for system performance check from 700 MHz to 6 GHz (MFP V5.1C) or 800 MHz - 6 GHz (MFP V5.1A) as well as dosimetric evaluations for body-worn operation.



Shell Thickness	2.0 mm ± 0.2 mm	
Filling Volume	approx. 9.2 L	
Dimensions	830 mm x 500 mm (L x W)	Figure 4.7 Triple Modular Phantom

4.5 Device Holder for Transmitters

In combination with the SAM Phantom V 4.0, the Mounting Device (POM) enables the rotation of the mounted transmitter in spherical coordinates whereby the rotation points is the ear opening. The devices can be easily, accurately, and repeatably positioned according to the FCC and CENELEC specifications. The device holder can be locked at different phantom locations (left head, right head, flat phantom).

Note: A simulating human hand is not used due to the complex anatomical and geometrical structure of the hand that may produce an infinite number of configurations. To produce the Worst-case condition (the hand absorbs antenna output power), the hand is omitted during the tests.



Figure 4.8 Device Holder

4.6 Brain & Muscle Simulating Mixture Characterization

The brain and muscle mixtures consist of a viscous gel using hydrox-ethyl cellulose (HEC) gelling agent and saline solution (see Table 3.1). Preservation with a bactericide is added and visual inspection is made to make sure air bubbles are not trapped during the mixing process. The mixture is calibrated to obtain proper dielectric constant (permittivity) and conductivity of the desired tissue. The mixture characterizations used for the brain and muscle tissue simulating liquids are according to the data by C. Gabriel and G. Hartsgrove.

Ingredients (% by weight)	Frequency (MHz)							
	835		1 900		2 450 - 2700		5200-5800	
Tissue Type	Head	Body	Head	Body	Head	Body	Head	Body
Water	40.45	53.06	54.9	70.17	71.88	73.2	65.52	78.66
Salt (NaCl)	1.45	0.94	0.18	0.39	0.16	0.1	0.0	0.0
Sugar	57.0	44.9	0.0	0	0.0	0.0	0.0	0.0
HEC	1.0	1.0	0.0	0	0.0	0.0	0.0	0.0
Bactericide	0.1	0.1	0.0	0	0.0	0.0	0.0	0.0
Triton X-100	0.0	0.0	0.0	0.0	19.97	0.0	17.24	10.67
DGBE	0.0	0.0	44.92	29.44	7.99	26.7	0.0	0.0
Diethylene glycol hexyl ether	-	-	-	-	-	-	17.24	10.67

Salt:	99 % Pure Sodium Chloride	Sugar:	98 % Pure Sucrose
Water:	De-ionized, 16M resistivity	HEC:	Hydroxyethyl Cellulose
DGBE:	99 % Di(ethylene glycol) butyl ether,[2-(2-butoxyethoxy) ethanol]		
Triton X-100(ultra pure):	Polyethylene glycol mono[4-(1,1,3,3-tetramethylbutyl)phenyl] ether		

Table 4.1 Composition of the Tissue Equivalent Matter

4.7 SAR TEST EQUIPMENT

Manufacturer	Type / Model	S/N	Calib. Date	Calib.Interval	Calib.Due
SPEAG	SAM Phantom	-	N/A	N/A	N/A
Staubli	Robot RX90L	F01/5K09A1/A/01	N/A	N/A	N/A
Staubli	Robot ControllerCS7MB	F99/5A82A1/C/01	N/A	N/A	N/A
HP	Pavilion t000_puffer	KRJ51201TV	N/A	N/A	N/A
SPEAG	Light Alignment Sensor	265	N/A	N/A	N/A
Staubli	Teach Pendant (Joystick)	D221340.01	N/A	N/A	N/A
SPEAG	DAE3	446	Jan. 16, 2013	Annual	Jan. 16, 2014
SPEAG	DAE4	648	Apr. 24, 2013	Annual	Apr. 24, 2014
SPEAG	DAE4	652	Mar. 21, 2013	Annual	Mar. 21, 2014
SPEAG	E-Field Probe ET3DV6	1798	Apr. 29, 2013	Annual	Apr. 29, 2014
SPEAG	E-Field Probe EX3DV4	3797	Nov. 22, 2012	Annual	Nov. 22, 2013
SPEAG	E-Field Probe EX3DV4	3903	Mar. 18, 2013	Annual	Mar. 18, 2014
SPEAG	Dipole D835V2	441	Apr. 25, 2013	Annual	Apr. 25, 2014
SPEAG	Dipole D1900V2	5d032	Jul. 20, 2012	Annual	Jul. 20, 2013
SPEAG	Dipole D2450V2	743	Aug. 23, 2012	Annual	Aug. 23, 2013
SPEAG	Dipole D5GHzV2	1107	Feb. 21, 2013	Annual	Feb. 21, 2014
Agilent	Power Meter(F) E4419B	MY41291386	Nov. 02, 2012	Annual	Nov. 02, 2013
Agilent	Power Sensor(G) 8481	MY41090870	Nov. 02, 2012	Annual	Nov. 02, 2013
HP	Dielectric Probe Kit 85070C	00721521	CBT		
HP	Dual Directional Coupler	16072	Nov. 02, 2012	Annual	Nov. 02, 2013
R&S	Base Station CMW500	1201.0002K50_116858	Jan. 17, 2013	Annual	Jan. 17, 2014
HP	Base Station E5515C	GB44400269	Feb. 14, 2013	Annual	Feb. 14, 2014
HP	Signal Generator 8664A	3744A02069	Nov. 02, 2012	Annual	Nov. 02, 2013
Hewlett Packard	11636B/Power Divider	11377	Nov. 11, 2012	Annual	Nov. 11, 2013
Agilent	N9020A/ SIGNAL	MY51110020	Jul. 31, 2012	Annual	Jul. 31, 2013
TESCOM	TC-3000C / BLUETOOTH	3000C000276	Jul. 11, 2012	Annual	Jul. 11, 2013
HP	Network Analyzer 8753ES	JP39240221	Mar. 26, 2013	Annual	Mar. 26, 2014

NOTE:

1. The E-field probe was calibrated by SPEAG, by the waveguide technique procedure. Dipole Verification measurement is performed by HCT Lab. before each test. The brain/body simulating material is calibrated by HCT using the dielectric probe system and network analyzer to determine the conductivity and permittivity (dielectric constant) of the brain/body-equivalent material.
2. CBT(Calibrating Before Testing). Prior to testing, the dielectric probe kit was calibrated via the network analyzer, with the specified procedure(calibrated in pure water) and calibration kit(standard) short circuit, before the dielectric measurement. The specific procedure and calibration kit are provided by Agilent

5. SAR MEASUREMENT PROCEDURE

The evaluation was performed with the following procedure:

1. The SAR value at a fixed location above the ear point was measured and was used as a reference value for assessing the power drop.
2. The SAR distribution at the exposed side of the head was measured at a distance of 3.9 mm from the inner surface of the shell. The area covered the entire dimension of the head and the horizontal grid spacing was 15 mm x 15 mm. Based on this data, the area of the maximum absorption was determined by spline interpolation.
3. Around this point, a volume of 32 mm x 32 mm x 30 mm was assessed by measuring 5 x 5 x 7 points. On this basis of this data set, the spatial peak SAR value was evaluated with the following procedure:
 - a. The data at the surface were extrapolated, since the center of the dipoles is 2.7 mm away from the tip of the probe and the distance between the surface and the lowest measuring point is 1.2 mm. The extrapolation was based on a least square algorithm. A polynomial of the fourth order was calculated through the points in z-axes. This polynomial was then used to evaluate the points between the surface and the probe tip.
 - b. The maximum interpolated value was searched with a straight-forward algorithm. Around this maximum the SAR values averaged over the spatial volumes (1 g or 10 g) were computed using the 3D-Spline interpolation algorithm. The 3D-spline is composed of three one-dimensional splines with the "Not a knot" condition (in x, y, and z directions). The volume was integrated with the trapezoidal algorithm. One thousand points (10 x 10 x 10) were interpolated to calculate the average.
 - c. All neighboring volumes were evaluated until no neighboring volume with a higher average value was found.
4. The SAR value, at the same location as procedure #1, was re-measured. If the value changed by more than 5 %, the evaluation is repeated.

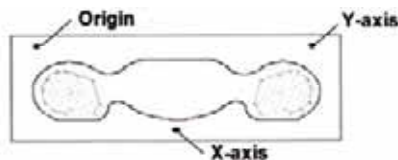

Figure 5.1 SAR Measurement Point in Area Scan

First Area Scan is used to locate the approximate location(s) of the local peak SAR value(s). The measurement grid within an Area Scan is defined by the grid extend, grid step size and grid offset. Next, in order to determine the EM field distribution in a three-dimensional spatial extension, Zoom Scan is required. The Zoom Scan is performed around the highest E-field value to determine the averaged SASR-distribution over 10g.

Area scan and zoom scan resolution setting follow KDB 865664 D01v01r01 quoted below

		≤ 3 GHz	> 3 GHz
Maximum distance from closest measurement point (geometric center of probe sensors) to phantom surface		5 ± 1 mm	$\frac{1}{2} \cdot \delta \cdot \ln(2) \pm 0.5$ mm
Maximum probe angle from probe axis to phantom surface normal at the measurement location		$30^\circ \pm 1^\circ$	$20^\circ \pm 1^\circ$
Maximum area scan spatial resolution: Δx_{Area} , Δy_{Area}		≤ 2 GHz: ≤ 15 mm 2 – 3 GHz: ≤ 12 mm	3 – 4 GHz: ≤ 12 mm 4 – 6 GHz: ≤ 10 mm
		When the x or y dimension of the test device, in the measurement plane orientation, is smaller than the above, the measurement resolution must be \leq the corresponding x or y dimension of the test device with at least one measurement point on the test device.	
Maximum zoom scan spatial resolution: Δx_{Zoom} , Δy_{Zoom}		≤ 2 GHz: ≤ 8 mm 2 – 3 GHz: ≤ 5 mm*	3 – 4 GHz: ≤ 5 mm* 4 – 6 GHz: ≤ 4 mm*
Maximum zoom scan spatial resolution, normal to phantom surface	uniform grid: $\Delta z_{Zoom}(n)$	≤ 5 mm	3 – 4 GHz: ≤ 4 mm 4 – 5 GHz: ≤ 3 mm 5 – 6 GHz: ≤ 2 mm
	graded grid	$\Delta z_{Zoom}(1)$: between 1 st two points closest to phantom surface	≤ 4 mm
		$\Delta z_{Zoom}(n>1)$: between subsequent points	$\leq 1.5 \cdot \Delta z_{Zoom}(n-1)$
Minimum zoom scan volume	x, y, z	≥ 30 mm	3 – 4 GHz: ≥ 28 mm 4 – 5 GHz: ≥ 25 mm 5 – 6 GHz: ≥ 22 mm
Note: δ is the penetration depth of a plane-wave at normal incidence to the tissue medium; see draft standard IEEE P1528-2011 for details. * When zoom scan is required and the <i>reported</i> SAR from the area scan based <i>I-g SAR estimation</i> procedures of KDB 447498 is ≤ 1.4 W/kg, ≤ 8 mm, ≤ 7 mm and ≤ 5 mm zoom scan resolution may be applied, respectively, for 2 GHz to 3 GHz, 3 GHz to 4 GHz and 4 GHz to 6 GHz.			

6. DESCRIPTION OF TEST POSITION

6.1 HEAD POSITION

The device was placed in a normal operating position with the Point A on the device, as illustrated in following drawing, aligned with the location of the RE(ERP) on the phantom. With the ear-piece pressed against the head, the vertical center line of the body of the handset was aligned with an imaginary plane consisting of the RE, LE and M. While maintaining these alignments, the body of the handset was gradually moved towards the cheek until any point on the mouth-piece or keypad contacted the cheek. This is a cheek/touch position. For ear/tilt position, while maintain the device aligned with the BM and FN lines, the device was pivot against ERP back for 15° or until the device antenna touch the phantom. Please refer to IEEE 1528-2003 illustration below.

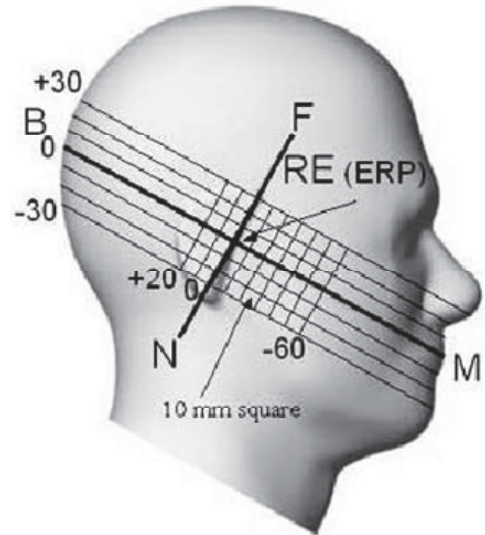

Figure 6.1 Side view of the phantom

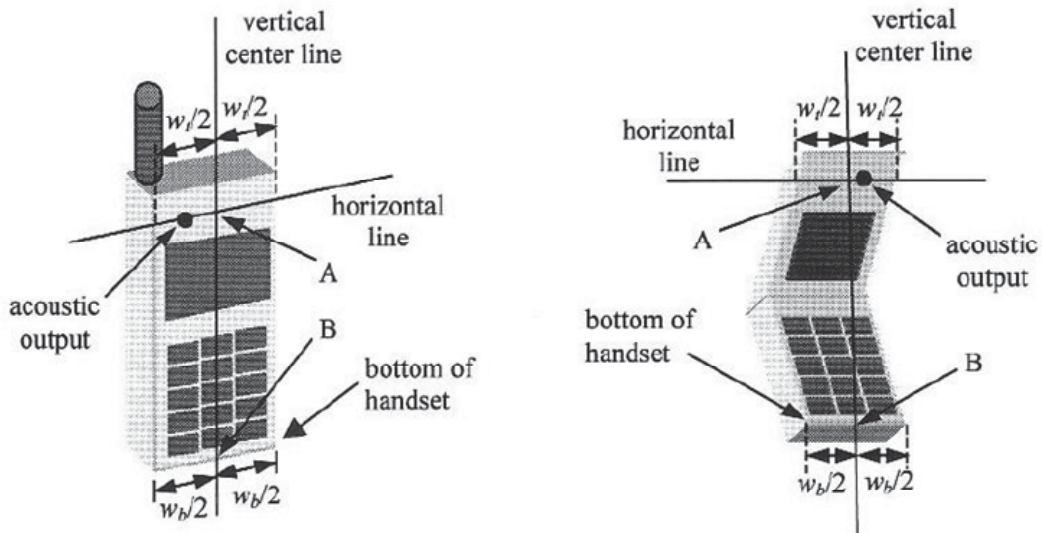

Figure 6.2 Handset vertical and horizontal reference lines

6.2 Body Holster/Belt Clip Configurations

Body-worn operating configurations are tested with the belt-clips and holsters attached to the device and positioned against a flat phantom in a normal use configuration. A device with a headset output is tested with a headset connected to the device. Body dielectric parameters are used.

Accessories for Body-worn operation configurations are divided into two categories: those that do not contain metallic components and those that contain metallic components. When multiple accessories that do not contain metallic components are supplied with the device, the device is tested with only the accessory that dictates the closest spacing to the body. Then multiple accessories that contain metallic components are tested with each accessory. If multiple accessory share an identical metallic component (i.e. the same metallic belt-clip used with different holsters with no other metallic components) only the accessory that dictates the closest spacing to the body is tested.

Body-worn accessories may not always be supplied or available as options for some Devices intended to be authorized for body-worn use. In this case, a test configuration with a separation distance between the back of the device and the flat phantom is used.

Since this EUT does not supply any body worn accessory to the end user a distance of 1.0 cm from the EUT back surface to the liquid interface is configured for the generic test.

"See the Test SET-UP Photo"

Transmitters that are designed to operate in front of a person's face, as in push-to-talk configurations, are tested for SAR compliance with the front of the device positioned to face the flat phantom. For devices that are carried next to the body such as a shoulder, waist or chest-worn transmitters, SAR compliance is tested with the accessory(ies), including headsets and microphones, attached to the device and positioned against a flat phantom in a normal use configuration.

In all cases SAR measurements are performed to investigate the worst-case positioning. Worstcase positioning is then documented and used to perform Body SAR testing.

7. MEASUREMENT UNCERTAINTY

Error Description	Tol (± %)	Prob. dist.	Div.	c_i	Standard Uncertainty (± %)	V_{eff}
1. Measurement System						
Probe Calibration	6.00	N	1	1	6.00	∞
Axial Isotropy	4.70	R	1.73	0.7	1.90	∞
Hemispherical Isotropy	9.60	R	1.73	0.7	3.88	∞
Boundary Effects	1.00	R	1.73	1	0.58	∞
Linearity	4.70	R	1.73	1	2.71	∞
System Detection Limits	1.00	R	1.73	1	0.58	∞
Readout Electronics	0.30	N	1.00	1	0.30	∞
Response Time	0.8	R	1.73	1	0.46	∞
Integration Time	2.6	R	1.73	1	1.50	∞
RF Ambient Conditions	3.00	R	1.73	1	1.73	∞
Probe Positioner	0.40	R	1.73	1	0.23	∞
Probe Positioning	2.90	R	1.73	1	1.67	∞
Max SAR Eval	1.00	R	1.73	1	0.58	∞
2. Test Sample Related						
Device Positioning	2.90	N	1.00	1	2.90	145
Device Holder	3.60	N	1.00	1	3.60	5
Power Drift	5.00	R	1.73	1	2.89	∞
3. Phantom and Setup						
Phantom Uncertainty	4.00	R	1.73	1	2.31	∞
Liquid Conductivity(target)	5.00	R	1.73	0.64	1.85	∞
Liquid Conductivity(meas.)	2.07	N	1	0.64	1.32	9
Liquid Permittivity(target)	5.00	R	1.73	0.6	1.73	∞
Liquid Permittivity(meas.)	5.02	N	1	0.6	3.01	9
Combine Standard Uncertainty					11.13	
Coverage Factor for 95 %					$k=2$	
Expanded STD Uncertainty					22.25	

Table 7.1 Uncertainty (800 MHz- 2450 MHz)

Error Description	Tol (± %)	Prob. dist.	Div.	c_i	Standard Uncertainty (± %)	V_{eff}	
1. Measurement System							
Probe Calibration	6.55	N	1	1	6.00	∞	
Axial Isotropy	4.70	R	1.73	0.7	1.90	∞	
Hemispherical Isotropy	9.60	R	1.73	0.7	3.88	∞	
Boundary Effects	1.00	R	1.73	1	0.58	∞	
Linearity	4.70	R	1.73	1	2.71	∞	
System Detection Limits	1.00	R	1.73	1	0.58	∞	
Readout Electronics	0.30	N	1.00	1	0.30	∞	
Response Time	0.8	R	1.73	1	0.46	∞	
Integration Time	2.6	R	1.73	1	1.50	∞	
RF Ambient Conditions	3.00	R	1.73	1	1.73	∞	
Probe Positioner	0.40	R	1.73	1	0.23	∞	
Probe Positioning	2.90	R	1.73	1	1.67	∞	
Max SAR Eval	1.00	R	1.73	1	0.58	∞	
2. Test Sample Related							
Device Positioning	2.90	N	1.00	1	2.90	145	
Device Holder	3.60	N	1.00	1	3.60	5	
Power Drift	5.00	R	1.73	1	2.89	∞	
3. Phantom and Setup							
Phantom Uncertainty	4.00	R	1.73	1	2.31	∞	
Liquid Conductivity(target)	5.00	R	1.73	0.64	1.85	∞	
Liquid Conductivity(meas.)	2.07	N	1	0.64	1.32	9	
Liquid Permittivity(target)	5.00	R	1.73	0.6	1.73	∞	
Liquid Permittivity(meas.)	5.02	N	1	0.6	3.01	9	
Combine Standard Uncertainty						11.43	
Coverage Factor for 95 %						$k=2$	
Expanded STD Uncertainty						22.86	

Table 7.2 Uncertainty (5000-5900 MHz)

8. ANSI/ IEEE C95.1 - 1992 RF EXPOSURE LIMITS

HUMAN EXPOSURE	UNCONTROLLED ENVIRONMENT General Population (W/kg) or (mW/g)	CONTROLLED ENVIRONMENT Occupational (W/kg) or (mW/g)
SPATIAL PEAK SAR * (Brain)	1.60	8.00
SPATIAL AVERAGE SAR ** (Whole Body)	0.08	0.40
SPATIAL PEAK SAR *** (Hands / Feet / Ankle / Wrist)	4.00	20.00

Table 8.1 Safety Limits for Partial Body Exposure

NOTES:

* The Spatial Peak value of the SAR averaged over any 1 g of tissue (defined as a tissue volume in the shape of a cube) and over the appropriate averaging time.

** The Spatial Average value of the SAR averaged over the whole-body.

*** The Spatial Peak value of the SAR averaged over any 10 g of tissue (defined as a tissue volume in the shape of a cube) and over the appropriate averaging time.

Uncontrolled Environments are defined as locations where there is the exposure of individuals who have no knowledge or control of their exposure.

Controlled Environments are defined as locations where there is exposure that may be incurred by persons who are aware of the potential for exposure, (i.e.as a result of employment or occupation).

9. SAR SYSTEM VALIDATION

Per FCC KCB 865664 D02v01, SAR system validation status should be document to confirm measurement accuracy. The SAR systems (including SAR probes, system components and software versions) used for this device were validated against its performance specifications prior to the SAR measurements. Reference dipoles were used with the required tissue- equivalent media for system validation, according to the procedures outlined in IEEE 1528-2003 and FCC KDB 865664 D01 v01r01. Since SAR probe calibrations are frequency dependent, each probe calibration point was validated at a frequency within the valid frequency range of the probe calibration point, using the system that normally operates with the probe for routine SAR measurements and according to the required tissue-equivalent media.

A tabulated summary of the system validation status including the validation date(s), measurement frequencies, SAR probes and tissue dielectric parameters has been included.

SAR System #	Probe	probe Type	Probe Calibration Point		Dipole	Date	Dielectric Parameters		CW Validation			Modulation Validation		
							Measured Permittivity	Measured Conductivity	Sensitivity	Probe Linearity	Probe Isortopy	MOD. Type	Duty Factor	PAR
3	3797	EX3DV4	Head	835	441	May.06,2013	42.01	0.92	PASS	PASS	PASS	GMSK	PASS	N/A
3	3797	EX3DV4	Body	835	441	May.06,2013	55.88	0.99	PASS	PASS	PASS	GMSK	PASS	N/A
3	3797	EX3DV4	Body	2450	743	Dec.21,2012	52.9	1.96	PASS	PASS	PASS	OFDM	N/A	PASS
5	3903	EX3DV4	Head	2450	743	Apr.3,2013	39.49	1.78	PASS	PASS	PASS	OFDM	N/A	PASS
5	3903	EX3DV4	Head	5200	1107	Apr.4,2013	36.68	4.71	PASS	PASS	PASS	OFDM	N/A	PASS
5	3903	EX3DV4	Head	5300	1107	Apr.4,2013	36.41	4.83	PASS	PASS	PASS	OFDM	N/A	PASS
5	3903	EX3DV4	Head	5500	1107	Apr.4,2013	35.81	5.09	PASS	PASS	PASS	OFDM	N/A	PASS
5	3903	EX3DV4	Head	5600	1107	Apr.4,2013	35.63	5.14	PASS	PASS	PASS	OFDM	N/A	PASS
5	3903	EX3DV4	Head	5800	1107	Apr.4,2013	35.17	5.31	PASS	PASS	PASS	OFDM	N/A	PASS
5	3903	EX3DV4	Body	5200	1107	Apr.5,2013	50.14	5.44	PASS	PASS	PASS	OFDM	N/A	PASS
5	3903	EX3DV4	Body	5300	1107	Apr.5,2013	49.52	5.51	PASS	PASS	PASS	OFDM	N/A	PASS
5	3903	EX3DV4	Body	5500	1107	Apr.5,2013	49.15	5.65	PASS	PASS	PASS	OFDM	N/A	PASS
5	3903	EX3DV4	Body	5600	1107	Apr.5,2013	48.84	5.93	PASS	PASS	PASS	OFDM	N/A	PASS
5	3903	EX3DV4	Body	5800	1107	Apr.5,2013	48.26	6.21	PASS	PASS	PASS	OFDM	N/A	PASS
6	1798	ET3DV6	Head	1900	5d038	July.01,2013	40.2	1.42	PASS	PASS	PASS	GMSK	PASS	N/A
6	1798	ET3DV6	Body	1900	5d038	July.01,2013	52.9	1.53	PASS	PASS	PASS	GMSK	PASS	N/A

Table 9.1 SAR System Validation Summary

Note;

All measurement were performed using probes calibrated for CW signal only. Modulations in the table above represent test configurations for which the measurement system has been validated per FCC KDB Publication 865664 D01v01r01. SAR system were validated for modulated signals with a periodic duty cycle, such as GMSK, or with a high peak to average ratio (>5 dB), such as OFDM according to KDB 865664.

10. SYSTEM VERIFICATION

10.1 Tissue Verification

Freq. [MHz]	Date	Probe	Dipole	Liquid	Liquid Temp.[°C]	Parameters	Target Value	Measured Value	Deviation [%]	Limit [%]
835	Jul. 22, 2013	3797	441	Head	20.2	ϵ_r	41.5	40.4	- 2.65	± 5
						σ	0.90	0.92	+ 2.22	± 5
835	Jul. 23, 2013	3797		Body	20.3	ϵ_r	55.2	56.8	+ 2.90	± 5
						σ	0.97	0.981	+ 1.13	± 5
1 900	Jul. 24, 2013	1798	5d038	Head	20.4	ϵ_r	40.0	39.7	- 0.75	± 5
						σ	1.40	1.41	+ 0.71	± 5
1 900	Jul. 25, 2013	1798		Body	20.1	ϵ_r	53.3	53.5	+ 0.38	± 5
						σ	1.52	1.49	- 1.97	± 5
2 450	Jul. 26, 2013	3903	743	Head	20.5	ϵ_r	39.2	37.7	- 3.83	± 5
						σ	1.80	1.83	+ 1.67	± 5
2 450	Jul. 27, 2013	3797		Body	20.6	ϵ_r	52.7	53.4	+ 1.33	± 5
						σ	1.95	1.99	+ 2.05	± 5
5 200	Jul. 29, 2013	3903	1107	Head	20.7	ϵ_r	36	36.3	+ 0.83	± 5
						σ	4.66	4.54	- 2.58	± 5
5 300	Jul. 29, 2013	3903		Head	20.7	ϵ_r	35.9	35.9	+ 0.00	± 5
						σ	4.76	4.68	- 1.68	± 5
5 600	Jul. 30, 2013	3903		Head	20.4	ϵ_r	35.5	35.2	- 0.85	± 5
						σ	5.07	5.01	- 1.18	± 5
5 800	Jul. 30, 2013	3903		Head	20.4	ϵ_r	35.3	34.6	- 1.98	± 5
						σ	5.27	5.29	+ 0.38	± 5
5 200	Jul. 29, 2013	3903		Body	20.7	ϵ_r	49.01	47.8	- 2.47	± 5
						σ	5.3	5.19	- 2.08	± 5
5 300	Jul. 29, 2013	3903		Body	20.7	ϵ_r	48.85	47.4	- 2.97	± 5
						σ	5.42	5.34	- 1.48	± 5
5 600	Jul. 30, 2013	3903		Body	20.4	ϵ_r	48.44	46.9	- 3.18	± 5
						σ	5.77	5.66	- 1.91	± 5
5 800	Jul. 30, 2013	3903		Body	20.4	ϵ_r	48.2	46.5	- 3.53	± 5
						σ	6.00	6.04	+ 0.67	± 5

The Tissue dielectric parameters were measured prior to the SAR evaluation using an Agilent 85070C Dielectric Probe Kit and Agilent Network Analyzer.

10.2 System Verification

Prior to assessment, the system is verified to the $\pm 10\%$ of the specifications at 835 MHz / 1 900 MHz / 2 450 MHz / 5 200 – 5 800 MHz by using the system Verification kit. (Graphic Plots Attached)

Freq. [MHz]	Date	Probe (SN)	Dipole (SN)	Liquid	Amb. Temp. [°C]	Liquid Temp. [°C]	1 W Target SAR _{1g} (SPEAG) (mW/g)	Measured SAR _{1g} (mW/g)	1 W Normalized SAR _{1g} (mW/g)	Deviation [%]	Limit [%]
835	Jul. 22, 2013	3797	441	Head	20.4	20.2	9.68	0.988	9.88	+ 2.07	± 10
835	Jul. 23, 2013	3797		Body	20.5	20.3	9.69	0.958	9.58	- 1.14	± 10
1 900	Jul. 24, 2013	1798	5d038	Head	20.6	20.4	39.0	3.83	38.3	- 1.79	± 10
1 900	Jul. 25, 2013	1798		Body	20.3	20.1	39.9	3.97	39.7	- 0.50	± 10
2 450	Jul. 26, 2013	3903	743	Head	20.7	20.5	52.7	5.3	53	+ 0.57	± 10
2 450	Jul. 27, 2013	3797		Body	20.8	20.6	51.2	5.34	53.4	+ 4.30	± 10
5 200	Jul. 29, 2013	3903	1107	Head	20.9	20.7	80.1	7.64	76.4	- 4.62	± 10
5 300	Jul. 29, 2013	3903		Head	20.9	20.7	81.0	8.35	83.5	+ 3.09	± 10
5 600	Jul. 30, 2013	3903		Head	20.6	20.4	84.4	8.54	85.4	+ 1.18	± 10
5 800	Jul. 30, 2013	3903		Head	20.6	20.4	78.3	7.92	79.2	+ 1.15	± 10
5 200	Jul. 29, 2013	3903	1107	Body	20.9	20.7	74.3	7.31	73.1	- 1.62	± 10
5 300	Jul. 29, 2013	3903		Body	20.9	20.7	76.0	7.69	76.9	+ 1.18	± 10
5 600	Jul. 30, 2013	3903		Body	20.6	20.4	81.0	7.69	76.9	- 5.06	± 10
5 800	Jul. 30, 2013	3903		Body	20.6	20.4	74.3	7.49	74.9	+ 0.81	± 10

10.3 System Verification Procedure

SAR measurement was prior to assessment, the system is verified to the $\pm 10\%$ of the specifications at each frequency band by using the system Verification kit. (Graphic Plots Attached)

- Cabling the system, using the Verification kit equipments.
- Generate about 100 mW Input Level from the Signal generator to the Dipole Antenna.
- Dipole Antenna was placed below the Flat phantom.
- The measured one-gram SAR at the surface of the phantom above the dipole feed-point should be within 10 % of the target reference value.
- The results are normalized to 1 W input power.

Note;

SAR Verification was performed according to the FCC KDB 865664.

11. RF CONDUCTED POWER MEASUREMENT

Power measurements were performed using a base station simulator under digital average power. The handset was placed into a simulated call using a base station simulator in a shielded chamber. Such test signals offer a consistent means for testing SAR and are recommended for evaluation SAR. SAR measurements were taken with a fully charged battery. In order to verify that the device was tested and maintained at full power, this was configured with the base station simulator. The SAR measurement software calculates a reference point at the start and end of the test to check for power drifts. If conducted power deviations of more than 5 % occurred, the tests were repeated.

11.1 Output Power Specifications.

This device operates using the following maximum output power specifications. SAR values were scaled to the maximum allowed power to determine compliance per KDB publication 447498 D01v05r01.

GSM

GSM850		GSM1900	
Target Power : 33.2 dBm		Target Power : 30.2 dBm	
GPRS850		PCS1900	
GPRS	EDGE	GPRS	EDGE
GPRS 1tx : 33.2 dBm	EDGE 1tx : 26.5 dBm	GPRS 1tx : 30.2 dBm	EDGE 1tx : 25.5 dBm
GPRS 2tx : 30.5 dBm	EDGE 2tx : 26.0 dBm	GPRS 2tx : 28.0 dBm	EDGE 2tx : 25.5 dBm
GPRS 3tx : 29.5 dBm	EDGE 3tx : 25.5 dBm	GPRS 3tx : 27.0 dBm	EDGE 3tx : 24.5 dBm
GPRS 4tx : 28.5 dBm	EDGE 4tx : 24.5 dBm	GPRS 4tx : 26.0 dBm	EDGE 4tx : 23.5 dBm
Tune-up Tolerance : -1.5 dB/ +0.5 dB			

WCDMA

WCDMA850	WCDMA 1900
Target Power : 23.6 dBm	Target Power : 23.0 dBm
Tune-up Tolerance : -1.5 dB/ +0.5 dB	

Wifi

- WLAN 11b : 14 dBm
- WLAN 11g : 11 dBm
- WLAN 11n : 9.8 dBm
- WLAN 11ac : 11 dBm
- WLAN 11a 5G : 10.8 dBm
- WLAN 11n 5G : 10.0 dBm

Tune-up Tolerance : + 1.5 dB

BT

BT
Target Power : 8 dBm
Tune-up Tolerance : + 1.5 dB

11.2 GSM

Conducted output power measurements were performed using a base station simulator under digital average power.



SAR Test for WWAN were performed with a base station simulator Agilent E5515C. Communication between the device and the emulator was established by air link. Set base station emulator to allow DUT to radiate maximum output power during all tests. Please refer to the below worst case SAR operation setup.

- GSM voice: Head SAR
- GPRS Multi-slots : Body SAR with GPRS Multi-slot Class12 with CS 1 (GMSK)

Note;

CS1/MCS7 coding scheme was used in GPRS/EDGE output power measurements and SAR Testing, as a condition where GMSK/8PSK modulation was ensured. Investigation has shown that CS1 - CS4/ MCS5 – MCS9 settings do not have any impact on the output levels in the GPRS/EDGE modes.

Band	Channel	Voice	GPRS(GMSK) Data				EDGE Data			
		GSM (dBm)	GPRS 1 TX Slot (dBm)	GPRS 2 TX Slot (dBm)	GPRS 3 TX Slot (dBm)	GPRS 4 TX Slot (dBm)	GPRS 1 TX Slot (dBm)	GPRS 2 TX Slot (dBm)	GPRS 3 TX Slot (dBm)	GPRS 4 TX Slot (dBm)
GSM 850	128	33.32	32.24	30.48	29.46	28.26	26.33	26.15	25.94	24.84
	190	33.36	33.3	30.51	29.45	28.3	26.21	26.07	25.86	24.77
	251	33.31	33.26	30.46	29.43	28.32	26.21	26.12	25.98	24.77
GSM 1900	512	30.24	30.23	27.92	26.68	25.77	25.86	25.71	24.94	23.85
	661	30.21	30.19	27.97	26.7	25.67	25.87	25.72	24.92	23.84
	810	30.29	30.28	28.04	26.84	25.67	25.81	25.65	25.04	23.84

GSM Conducted output powers (Burst-Average)

Band	Channel	Voice	GPRS(GMSK) Data				EDGE Data			
		GSM (dBm)	GPRS 1 TX Slot (dBm)	GPRS 2 TX Slot (dBm)	GPRS 3 TX Slot (dBm)	GPRS 4 TX Slot (dBm)	GPRS 1 TX Slot (dBm)	GPRS 2 TX Slot (dBm)	GPRS 3 TX Slot (dBm)	GPRS 4 TX Slot (dBm)
GSM 850	128	24.29	23.21	24.46	25.2	25.25	17.3	20.13	21.68	21.83
	190	24.33	24.27	24.49	25.19	25.29	17.18	20.05	21.6	21.76
	251	24.28	24.23	24.44	25.17	25.31	17.18	20.1	21.72	21.76
GSM 1900	512	21.21	21.2	21.9	22.42	22.76	16.83	19.69	20.68	20.84
	661	21.18	21.16	21.95	22.44	22.66	16.84	19.7	20.66	20.83
	810	21.26	21.25	22.02	22.58	22.66	16.78	19.63	20.78	20.83

GSM Conducted output powers (Frame-Average)

Note:

Time slot average factor is as follows:

1 Tx slot = 9.03 dB, Frame-Average output power = Burst-Average output power – 9.03 dB

2 Tx slot = 6.02 dB, Frame-Average output power = Burst-Average output power – 6.02 dB

3 Tx slot = 4.26 dB, Frame-Average output power = Burst-Average output power – 4.26 dB

4 Tx slot = 3.01 dB, Frame-Average output power = Burst-Average output power – 3.01 dB

11.3 WCDMA

Body SAR is not required for handsets with HSDPA capabilities when the maximum average output of each RF channel with HSDPA active is less than ¼ dB higher than that measured without HSDPA using 12.2 kbps RMC and the maximum SAR for 12.2 kbps RMC is ≤ 75 % of the SAR limit. Otherwise, SAR is Measured for HSDPA, using an FRC with H-Set 1 in Sub-test 1 and a 12.2 kbps RMC configured in Test Loop Mode 1, using the highest body SAR configuration in 12.2 kbps RMC without HSDPA, on the maximum output channel with the body exposure configuration that results in the highest SAR in 12.2 kbps RMC for that RF channel.

11.3.1 Output Power Verification

Maximum output power is verified on the High, Middle and Low channels according to the general descriptions in section 5.2 of 3 GPP TS 34.121, using the appropriate RMC or AMR with TPC(transmit power control) set to all “1s”.

11.3.2 Head SAR Measurements

SAR for head exposure configurations is measured using the 12.2 kbps RMC with TPC bits configured to all “1s”. SAR in AMR configurations is not required when the maximum average output of each RF channel for 12.2 kbps AMR is less than ¼ dB higher than that measured in 12.2 kbps RMC. Otherwise, SAR is measured on the maximum output channel in 12.2 AMR with a 3.4 kbps SRB (signaling radio bearer using the exposure configuration that results in the highest SAR for that RF channel in 12.2 RMC.

11.3.3 Body SAR Measurement

SAR for body exposure configurations is measured using the 12.2 kbps RMC with the TPC bits all “1s”.

11.3.4 Handsets with Release 5 HSDPA

Body SAR is not required for handsets with HSDPA capabilities when the maximum average output of each RF channel with HSDPA active is less than ¼ dB higher than that measured without HSDPA using 12.2 kbps RMC and the maximum SAR for 12.2 kbps RMC is ≤ 75 % of the SAR limit. Otherwise, SAR is Measured for HSDPA, using an FRC with H-Set 1 in Sub-test 1 and a 12.2 kbps RMC configured in Test Loop Mode 1, using the highest body SAR configuration in 12.2 kbps RMC without HSDPA, on the maximum output channel with the body exposure configuration that results in the highest SAR in 12.2 kbps RMC for that RF channel.

Sub-Test 1 Setup for Release 5 HSDPA

Sub-test	β_c	β_d	β_d (SF)	β_c/β_d	$\beta_{hs}^{(2)}$	CM (dB) ⁽²⁾
1	2/15	15/15	64	2/15	4/15	0.0
2	12/15 ⁽³⁾	15/15 ⁽³⁾	64	12/15 ⁽³⁾	24/15	1.0
3	15/15	8/15	64	15/8	30/15	1.5
4	15/15	4/15	64	15/4	30/15	1.5

Note 1: $\Delta_{ACK}, \Delta_{NACK}$ and $\Delta_{CQI} = 8 \Leftrightarrow A_{hs} = \beta_{hs}/\beta_c = 30/15 \Leftrightarrow \beta_{hs} = 30/15 * \beta_c$
 Note 2: CM = 1 for $\beta_c/\beta_d = 12/15, \beta_{hs}/\beta_c = 24/15$.
 Note 3: For subtest 2 the β_c/β_d ratio of 12/15 for the TFC during the measurement period (TF1, TF0) is achieved by setting the signaled gain factors for the reference TFC (TF1, TF1) to $\beta_c = 11/15$ and $\beta_d = 15/15$.

11.3.5 Handsets with Release 6 HSPA (HSDPA/HSUPA)

Body SAR is not required for handsets with HSPA capabilities when the maximum average output of each RF channel with HSUPA/HSDPA active is less than ¼ dB higher than that measured without HSUPA/HSDPA using 12.2 kbps RMC and the maximum SAR for 12.2 kbps RMC is ≤ 75 % of the SAR limit. Body SAR for HSPA is measured with E-DCH Sub-test 5, using H-Set 1 and QPSK for FRC and a 12.2 kbps RMC configured in Test Loop Mode 1 with power control algorithm 2, according to the highest body SAR configuration in 12.1 kbps RMC without HSPA. When VOIP is applicable for head exposure, SAR is not required when the maximum output of each RF channel with HSPA is less than ¼ dB higher than that measured using 12.2 kbps RMC; otherwise, the same HSPA configuration used for body measurement should be used to test for head exposure.

Sub-test	β_c	β_d	β_d (SF)	β_c/β_d	$\beta_{hs}^{(1)}$	β_{ec}	β_{ed}	β_{ed} (SF)	β_{ed} (codes)	CM ⁽²⁾ (dB)	MPR (dB)	AG ⁽⁴⁾ Index	E-TFCI
1	11/15 ⁽³⁾	15/15 ⁽³⁾	64	11/15 ⁽³⁾	22/15	209/225	1039/225	4	1	1.0	0.0	20	75
2	6/15	15/15	64	6/15	12/15	12/15	94/75	4	1	3.0	2.0	12	67
3	15/15	9/15	64	15/9	30/15	30/15	$\beta_{ed1}: 47/15$ $\beta_{ed2}: 47/15$	4	2	2.0	1.0	15	92
4	2/15	15/15	64	2/15	4/15	2/15	56/75	4	1	3.0	2.0	17	71
5	15/15 ⁽⁴⁾	15/15 ⁽⁴⁾	64	15/15 ⁽⁴⁾	30/15	24/15	134/15	4	1	1.0	0.0	21	81

Note 1: Δ_{ACK} , Δ_{NACK} and $\Delta_{CQI} = 8 \Leftrightarrow A_{hs} = \beta_{hs}/\beta_c = 30/15 \Leftrightarrow \beta_{hs} = 30/15 * \beta_c$.

Note 2: CM = 1 for $\beta_c/\beta_d = 12/15$, $\beta_{hs}/\beta_c = 24/15$. For all other combinations of DPDCH, DPCCCH, HS-DPCCH, E-DPDCH and E-DPCCH the MPR is based on the relative CM difference.

Note 3: For subtest 1 the β_c/β_d ratio of 11/15 for the TFC during the measurement period (TF1, TF0) is achieved by setting the signaled gain factors for the reference TFC (TF1, TF1) to $\beta_c = 10/15$ and $\beta_d = 15/15$.

Note 4: For subtest 5 the β_c/β_d ratio of 15/15 for the TFC during the measurement period (TF1, TF0) is achieved by setting the signaled gain factors for the reference TFC (TF1, TF1) to $\beta_c = 14/15$ and $\beta_d = 15/15$.

Note 5: Testing UE using E-DPDCH Physical Layer category 1 Sub-test 3 is not required according to TS 25.306 Table 5.1g.

Note 6: β_{ed} can not be set directly; it is set by Absolute Grant Value.

WCDMA 850

3GPP Release Version	Mode	3GPP 34.121 Subtest	Cellular Band [dBm]						MPR
			UL 4132 (826.4)	Power reduction (dB)	UL 4183 (836.6)	Power reduction (dB)	UL 4233 (846.6)	Power reduction (dB)	
			DL 4357		DL 4408		DL 4458		
99	WCDMA	12.2 kbps RMC	24.03		23.93		23.89		
99	WCDMA	12.2 kbps AMR	24.02		23.91		23.86		
5	HSDPA	Subtest 1	24.01		24.01		23.88		0
5		Subtest 2	23.65	0.36	23.71	0.3	23.6	0.28	0
5		Subtest 3	23.41	0.6	23.48	0.53	23.39	0.49	-0.5
5		Subtest 4	23.44	0.57	23.47	0.54	23.38	0.5	-0.5
6	HSUPA	Subtest 1	23.38		23.5		23.32		0
6		Subtest 2	22.22	1.16	22.35	1.15	22.14	1.18	-2
6		Subtest 3	22.89	0.49	22.95	0.55	22.78	0.54	-1
6		Subtest 4	22.2	1.18	22.4	1.1	22.24	1.08	-2
6		Subtest 5	23.14	0.24	23.28	0.22	23.11	0.21	0
8	DC-HSDPA	Subtest 1	23.86		23.78		23.74		0
8		Subtest 2	23.80	0.06	23.74	0.04	23.73	0.01	0
8		Subtest 3	23.36	0.50	23.32	0.46	23.30	0.44	-0.5
8		Subtest 4	23.35	0.50	23.31	0.47	23.28	0.46	-0.5

WCDMA 1900

3GPP Release Version	Mode	3GPP 34.121 Subtest	Cellular Band [dBm]						MPR
			UL 9262 (1852.4)	Power reduction (dB)	UL 9400 (1880.0)	Power reduction (dB)	UL 9538 (1907.6)	Power reduction (dB)	
			DL 9662		DL 9800		DL 9938		
99	WCDMA	12.2 kbps RMC	23.23		23.38		23.11		
99	WCDMA	12.2 kbps AMR	23.18		23.28		22.95		
5	HSDPA	Subtest 1	22.21		22.44		22.66		0
5		Subtest 2	22.15	0.06	22.35	0.09	22.56	0.1	0
5		Subtest 3	21.73	0.48	21.96	0.48	22.2	0.46	-0.5
5		Subtest 4	21.73	0.48	21.94	0.5	22.21	0.45	-0.5
6	HSUPA	Subtest 1	22.07		22.32		22.14		0
6		Subtest 2	20.16	1.91	20.48	1.84	20.19	1.95	-2
6		Subtest 3	21.17	0.9	21.32	1	21.21	0.93	-1
6		Subtest 4	20.21	1.86	20.52	1.8	20.25	1.89	-2
6		Subtest 5	22.15	-0.08	22.4	-0.08	22.13	0.01	0
8	DC-HSDPA	Subtest 1	22.96		23.15		22.90		0
8		Subtest 2	22.95	0.01	23.14	0.01	22.86	0.04	0
8		Subtest 3	22.48	0.48	22.67	0.48	22.40	0.50	-0.5
8		Subtest 4	22.41	0.55	22.63	0.52	22.38	0.52	-0.5

11.4 WiFi

11.4.1 SAR Testing for 802.11b/g/n/ac modes

General Device Setup

Normal Network operating configurations are not suitable for measuring the SAR of 802.11 a/b/g transmitters. Unpredictable fluctuations in network traffic and antenna diversity conditions can introduce undesirable variations in SAR results. The SAR for these devices should be measured using chipset based test mode software to ensure the results are consistent and reliable.

Chipset based test mode software is hardware dependent and generally varies among manufacturers. The device operating parameters established in test mode for SAR measurements must be identical to those programmed in production units, including output power levels, amplifier gain settings and other RF performance tuning parameters. The test frequencies should correspond to actual channel frequencies defined for domestic use. SAR for devices with switched diversity should be measured with only one antenna transmitting at a time during each SAR measurement, according to a fixed modulation and data rate. The same data pattern should be used for all measurements.

Frequency Channel Configurations

802.11 a/b/g and 4.9 GHz operating modes are tested independently according to the service requirements in each frequency band. 802.11 b/g modes are tested on channels 1, 6 and 11. 802.11a is tested for UNII operations on channels 36 and 48 in the 5.15-5.25 GHz band; channels 52 and 64 in the 5.25-5.35 GHz band; Channels 104, 116, 124 and 136 in the 5.470-5.725 GHz band; and channels 149 and 161 in the 5.8 GHz band. When 5.8 GHz § 15.247 is also available, channels 149, 157 and 165 should be tested instead of the UNII channels. 4.9 GHz is tested on channels 1, 10 and 5 or 6, whichever has the higher output power, for 5 MHz channels; channels 11, 15 and 19 for 10 MHz channels; and channels 21 and 25 for 20 MHz channels.

These are referred to as the "default test channels". 802.11g mode was evaluated only if the output power was 0.25 dB higher than the 802.11b mode.

Mode	GHz	Channel	Turbo Channel	"Default Test Channels"		UNII
				§15.247 802.11b	802.11g	
802.11 b/g	2.412	1		√	∇	
	2.437	6	6	√	∇	
	2.462	11		√	∇	
802.11a	5.18	36				√
	5.20	40	42 (5.21 GHz)			*
	5.22	44				
	5.24	48	50 (5.25 GHz)			√
	5.26	52				√
	5.28	56	58 (5.29 GHz)			*
	5.30	60				*
	5.32	64				√
	5.500	100	Unknown			*
	5.520	104				√
	5.540	108				*
	5.560	112				*
	5.580	116				√
	5.600	120				*
	5.620	124				√
	5.640	128				*
	5.660	132				*
	5.680	136			√	
	5.700	140			*	
UNII or §15.247	5.745	149		√		√
	5.765	153	152 (5.76 GHz)		*	*
	5.785	157		√		*
	5.805	161	160 (5.80 GHz)		*	√
§15.247	5.825	165		√		*

802.11 Test Channels per FCC Requirements

TEST RESULTS-Average
Conducted Output Power Measurements (802.11b Mode)

802.11b Mode		Rate (Mbps)	Measured Power(dBm) + Duty Cycle Factor	Limit (dBm)
Frequency [MHz]	Channel No.			
2412	1	1 Mbps	12.74	30
		2 Mbps	12.84	30
		5.5 Mbps	12.86	30
		11 Mbps	12.81	30
2437	6	1 Mbps	13.02	30
		2 Mbps	13.09	30
		5.5 Mbps	13.10	30
		11 Mbps	13.14	30
2462	11	1 Mbps	13.38	30
		2 Mbps	13.43	30
		5.5 Mbps	13.41	30
		11 Mbps	13.43	30

Conducted Output Power Measurements (802.11g Mode)

802.11g Mode		Rate (Mbps)	Measured Power(dBm) + Duty Cycle Factor	Limit (dBm)
Frequency [MHz]	Channel No.			
2412	1	6 Mbps	9.95	30
		9 Mbps	9.98	30
		12 Mbps	10.03	30
		18 Mbps	9.99	30
		24 Mbps	9.97	30
		36 Mbps	9.94	30
		48 Mbps	9.94	30
		54 Mbps	9.94	30
2437	6	6 Mbps	10.34	30
		9 Mbps	10.22	30
		12 Mbps	10.22	30
		18 Mbps	10.20	30
		24 Mbps	10.21	30
		36 Mbps	10.21	30
		48 Mbps	10.21	30
		54 Mbps	10.18	30
2462	11	6 Mbps	10.39	30
		9 Mbps	10.43	30
		12 Mbps	10.39	30
		18 Mbps	10.42	30
		24 Mbps	10.45	30
		36 Mbps	10.39	30
		48 Mbps	10.41	30
		54 Mbps	10.43	30

Conducted Output Power Measurements (802.11n Mode)

802.11n Mode		Rate (Mbps)	Measured Power(dBm) + Duty Cycle Factor	Limit (dBm)
Frequency [MHz]	Channel No.			
2412	1	6.5 Mbps	8.66	30
		13 Mbps	8.49	30
		19.5 Mbps	8.74	30
		26 Mbps	8.68	30
		39 Mbps	8.66	30
		52 Mbps	8.68	30
		58.5 Mbps	8.68	30
		65 Mbps	8.64	30
2437	6	6.5 Mbps	8.81	30
		13 Mbps	8.78	30
		19.5 Mbps	8.84	30
		26 Mbps	8.77	30
		39 Mbps	8.83	30
		52 Mbps	8.80	30
		58.5 Mbps	8.93	30
		65 Mbps	8.82	30
2462	11	6.5 Mbps	9.00	30
		13 Mbps	9.01	30
		19.5 Mbps	9.08	30
		26 Mbps	9.07	30
		39 Mbps	9.02	30
		52 Mbps	9.08	30
		58.5 Mbps	9.04	30
		65 Mbps	9.01	30

Conducted Output Power Measurements (802.11a Mode: 5180~5240)

802.11a Mode		Rate (Mbps)	Measured Power(dBm) + Duty Cycle Factor	Limit (dBm)
Frequency [MHz]	Channel No.			
5180	36	6 Mbps	11.10	16.86
		9 Mbps	11.04	16.86
		12 Mbps	11.01	16.86
		18 Mbps	11.11	16.86
		24 Mbps	10.96	16.86
		36 Mbps	10.94	16.86
		48 Mbps	10.96	16.86
		54 Mbps	10.91	16.86
5200	40	6 Mbps	11.12	16.86
		9 Mbps	11.07	16.86
		12 Mbps	11.05	16.86
		18 Mbps	11.08	16.86
		24 Mbps	11.03	16.86
		36 Mbps	10.97	16.86
		48 Mbps	10.93	16.86
		54 Mbps	10.93	16.86
5220	44	6 Mbps	10.53	16.86
		9 Mbps	10.44	16.86
		12 Mbps	10.41	16.86
		18 Mbps	10.46	16.86
		24 Mbps	10.50	16.86
		36 Mbps	10.47	16.86
		48 Mbps	10.46	16.86
		54 Mbps	10.52	16.86
5240	48	6 Mbps	11.34	16.86
		9 Mbps	11.41	16.86
		12 Mbps	11.32	16.86
		18 Mbps	11.38	16.86
		24 Mbps	11.32	16.86
		36 Mbps	11.23	16.86
		48 Mbps	11.23	16.86
		54 Mbps	11.21	16.86

Conducted Output Power Measurements (802.11a Mode: 5260~5320)

802.11a Mode		Rate (Mbps)	Measured Power(dBm) + Duty Cycle Factor	Limit (dBm)
Frequency [MHz]	Channel No.			
5260	52	6 Mbps	11.54	23.84
		9 Mbps	11.53	23.84
		12 Mbps	11.48	23.84
		18 Mbps	11.47	23.84
		24 Mbps	11.45	23.84
		36 Mbps	11.42	23.84
		48 Mbps	11.42	23.84
		54 Mbps	11.40	23.84
5280	56	6 Mbps	11.12	23.84
		9 Mbps	11.17	23.84
		12 Mbps	11.21	23.84
		18 Mbps	11.10	23.84
		24 Mbps	11.15	23.84
		36 Mbps	11.13	23.84
		48 Mbps	11.18	23.84
		54 Mbps	11.13	23.84
5300	60	6 Mbps	11.77	23.84
		9 Mbps	11.70	23.84
		12 Mbps	11.69	23.84
		18 Mbps	11.63	23.84
		24 Mbps	11.65	23.84
		36 Mbps	11.56	23.84
		48 Mbps	11.61	23.84
		54 Mbps	11.54	23.84
5320	64	6 Mbps	11.73	23.84
		9 Mbps	11.71	23.84
		12 Mbps	11.72	23.84
		18 Mbps	11.59	23.84
		24 Mbps	11.71	23.84
		36 Mbps	11.60	23.84
		48 Mbps	11.53	23.84
		54 Mbps	11.60	23.84

Conducted Output Power Measurements (802.11a Mode: 5500~5720)

802.11a Mode		Rate (Mbps)	Measured Power(dBm) + Duty Cycle Factor	Limit (dBm)
Frequency [MHz]	Channel No.			
5500	100	6 Mbps	10.21	23.84
		9 Mbps	10.20	23.84
		12 Mbps	10.19	23.84
		18 Mbps	10.08	23.84
		24 Mbps	10.14	23.84
		36 Mbps	10.05	23.84
		48 Mbps	10.07	23.84
		54 Mbps	10.02	23.84
5520	104	6 Mbps	9.89	23.84
		9 Mbps	9.81	23.84
		12 Mbps	9.84	23.84
		18 Mbps	9.89	23.84
		24 Mbps	9.85	23.84
		36 Mbps	9.89	23.84
		48 Mbps	9.85	23.84
		54 Mbps	9.90	23.84
5540	108	6 Mbps	9.40	23.84
		9 Mbps	9.48	23.84
		12 Mbps	9.43	23.84
		18 Mbps	9.42	23.84
		24 Mbps	9.37	23.84
		36 Mbps	9.53	23.84
		48 Mbps	9.31	23.84
		54 Mbps	9.37	23.84
5560	112	6 Mbps	10.06	23.84
		9 Mbps	10.00	23.84
		12 Mbps	9.92	23.84
		18 Mbps	9.87	23.84
		24 Mbps	9.97	23.84
		36 Mbps	10.04	23.84
		48 Mbps	10.21	23.84
		54 Mbps	10.29	23.84
5580	116	6 Mbps	10.70	23.84
		9 Mbps	10.63	23.84
		12 Mbps	10.63	23.84
		18 Mbps	10.68	23.84
		24 Mbps	10.56	23.84
		36 Mbps	10.51	23.84
		48 Mbps	10.56	23.84
		54 Mbps	10.47	23.84

5660	132	6 Mbps	10.04	23.84
		9 Mbps	9.98	23.84
		12 Mbps	9.98	23.84
		18 Mbps	10.06	23.84
		24 Mbps	10.01	23.84
		36 Mbps	9.94	23.84
		48 Mbps	10.05	23.84
		54 Mbps	9.81	23.84
5680	136	6 Mbps	10.19	23.84
		9 Mbps	10.21	23.84
		12 Mbps	10.21	23.84
		18 Mbps	10.16	23.84
		24 Mbps	9.80	23.84
		36 Mbps	9.90	23.84
		48 Mbps	9.58	23.84
		54 Mbps	9.52	23.84
5700	140	6 Mbps	10.63	23.84
		9 Mbps	10.63	23.84
		12 Mbps	10.61	23.84
		18 Mbps	10.57	23.84
		24 Mbps	10.64	23.84
		36 Mbps	10.63	23.84
		48 Mbps	10.56	23.84
		54 Mbps	10.59	23.84

Conducted Output Power Measurements (802.11a Mode: 5745~5825)

802.11a Mode		Rate (Mbps)	Measured Power(dBm) + Duty Cycle Factor	Limit (dBm)
Frequency [MHz]	Channel No.			
5745	149	6 Mbps	9.84	30
		9 Mbps	9.82	30
		12 Mbps	9.89	30
		18 Mbps	9.91	30
		24 Mbps	9.85	30
		36 Mbps	9.80	30
		48 Mbps	9.79	30
		54 Mbps	9.73	30
5765	153	6 Mbps	9.21	30
		9 Mbps	9.21	30
		12 Mbps	9.28	30
		18 Mbps	9.45	30
		24 Mbps	9.25	30
		36 Mbps	9.41	30
		48 Mbps	9.28	30
		54 Mbps	9.17	30
5785	157	6 Mbps	9.80	30
		9 Mbps	9.67	30
		12 Mbps	9.71	30
		18 Mbps	9.65	30
		24 Mbps	9.73	30
		36 Mbps	9.63	30
		48 Mbps	9.54	30
		54 Mbps	9.55	30
5805	161	6 Mbps	9.56	30
		9 Mbps	9.43	30
		12 Mbps	9.45	30
		18 Mbps	9.49	30
		24 Mbps	9.48	30
		36 Mbps	9.66	30
		48 Mbps	9.68	30
		54 Mbps	9.50	30
5825	165	6 Mbps	9.61	30
		9 Mbps	9.57	30
		12 Mbps	9.62	30
		18 Mbps	9.59	30
		24 Mbps	9.51	30
		36 Mbps	9.58	30
		48 Mbps	9.46	30
		54 Mbps	9.50	30

20 MHz BW

Conducted Output Power Measurements (802.11n Mode: 5180~5240)

802.11n Mode		Rate (Mbps)	Measured Power(dBm) + Duty Cycle Factor	Limit (dBm)
Frequency [MHz]	Channel No.			
5180	36	6.5 Mbps	10.17	16.92
		13 Mbps	10.07	16.92
		19.5 Mbps	10.03	16.92
		26 Mbps	9.99	16.92
		39 Mbps	9.95	16.92
		52 Mbps	9.97	16.92
		58.5 Mbps	9.90	16.92
		65 Mbps	9.90	16.92
5200	40	6.5 Mbps	10.22	16.92
		13 Mbps	10.14	16.92
		19.5 Mbps	10.14	16.92
		26 Mbps	10.07	16.92
		39 Mbps	10.05	16.92
		52 Mbps	10.04	16.92
		58.5 Mbps	10.01	16.92
		65 Mbps	9.85	16.92
5220	44	6.5 Mbps	9.52	16.92
		13 Mbps	9.51	16.92
		19.5 Mbps	9.48	16.92
		26 Mbps	9.27	16.92
		39 Mbps	9.41	16.92
		52 Mbps	9.47	16.92
		58.5 Mbps	9.42	16.92
		65 Mbps	9.34	16.92
5240	48	6.5 Mbps	10.49	16.92
		13 Mbps	10.44	16.92
		19.5 Mbps	10.41	16.92
		26 Mbps	10.39	16.92
		39 Mbps	10.37	16.92
		52 Mbps	10.29	16.92
		58.5 Mbps	10.22	16.92
		65 Mbps	10.21	16.92

Conducted Output Power Measurements (802.11n Mode: 5260~5320)

802.11n Mode		Rate (Mbps)	Measured Power(dBm) + Duty Cycle Factor	Limit (dBm)
Frequency [MHz]	Channel No.			
5260	52	6.5 Mbps	10.65	23.90
		13 Mbps	10.63	23.90
		19.5 Mbps	10.63	23.90
		26 Mbps	10.56	23.90
		39 Mbps	10.50	23.90
		52 Mbps	10.55	23.90
		58.5 Mbps	10.62	23.90
		65 Mbps	10.45	23.90
5280	56	6.5 Mbps	9.38	23.90
		13 Mbps	9.24	23.90
		19.5 Mbps	9.05	23.90
		26 Mbps	9.09	23.90
		39 Mbps	9.18	23.90
		52 Mbps	9.34	23.90
		58.5 Mbps	9.20	23.90
		65 Mbps	9.13	23.90
5300	60	6.5 Mbps	10.82	23.90
		13 Mbps	10.83	23.90
		19.5 Mbps	10.83	23.90
		26 Mbps	10.75	23.90
		39 Mbps	10.75	23.90
		52 Mbps	10.72	23.90
		58.5 Mbps	10.60	23.90
		65 Mbps	10.71	23.90
5320	64	6.5 Mbps	10.89	23.90
		13 Mbps	10.87	23.90
		19.5 Mbps	10.89	23.90
		26 Mbps	10.86	23.90
		39 Mbps	10.78	23.90
		52 Mbps	10.79	23.90
		58.5 Mbps	10.83	23.90
		65 Mbps	10.85	23.90

Conducted Output Power Measurements (802.11n Mode: 5500~5700)

802.11a Mode		Rate (Mbps)	Measured Power(dBm) + Duty Cycle Factor	Limit (dBm)
Frequency [MHz]	Channel No.			
5500	100	6.5 Mbps	9.33	23.91
		13 Mbps	9.22	23.91
		19.5 Mbps	9.21	23.91
		26 Mbps	9.17	23.91
		39 Mbps	9.13	23.91
		52 Mbps	9.13	23.91
		58.5 Mbps	9.02	23.91
		65 Mbps	9.15	23.91
5520	104	6.5 Mbps	8.90	23.91
		13 Mbps	8.86	23.91
		19.5 Mbps	8.88	23.91
		26 Mbps	8.81	23.91
		39 Mbps	8.80	23.91
		52 Mbps	8.75	23.91
		58.5 Mbps	8.72	23.91
		65 Mbps	8.78	23.91
5540	108	6.5 Mbps	9.10	23.91
		13 Mbps	8.95	23.91
		19.5 Mbps	9.11	23.91
		26 Mbps	9.00	23.91
		39 Mbps	8.86	23.91
		52 Mbps	8.92	23.91
		58.5 Mbps	8.89	23.91
		65 Mbps	8.94	23.91
5560	112	6.5 Mbps	9.22	23.91
		13 Mbps	9.24	23.91
		19.5 Mbps	9.20	23.91
		26 Mbps	9.18	23.91
		39 Mbps	9.29	23.91
		52 Mbps	9.11	23.91
		58.5 Mbps	9.14	23.91
		65 Mbps	9.12	23.91
5580	116	6.5 Mbps	9.71	23.91
		13 Mbps	9.70	23.91
		19.5 Mbps	9.67	23.91
		26 Mbps	9.65	23.91
		39 Mbps	9.64	23.91
		52 Mbps	9.60	23.91
		58.5 Mbps	9.61	23.91
		65 Mbps	9.46	23.91

5660	132	6.5 Mbps	8.43	23.91
		13 Mbps	8.49	23.91
		19.5 Mbps	8.43	23.91
		26 Mbps	8.44	23.91
		39 Mbps	8.37	23.91
		52 Mbps	8.42	23.91
		58.5 Mbps	8.42	23.91
		65 Mbps	8.47	23.91
5680	136	6.5 Mbps	8.60	23.91
		13 Mbps	8.56	23.91
		19.5 Mbps	8.60	23.91
		26 Mbps	8.65	23.91
		39 Mbps	8.54	23.91
		52 Mbps	8.57	23.91
		58.5 Mbps	8.59	23.91
		65 Mbps	8.58	23.91
5700	140	6.5 Mbps	9.59	23.91
		13 Mbps	9.57	23.91
		19.5 Mbps	9.61	23.91
		26 Mbps	9.56	23.91
		39 Mbps	9.54	23.91
		52 Mbps	9.46	23.91
		58.5 Mbps	9.46	23.91
		65 Mbps	9.42	23.91

Conducted Output Power Measurements (802.11n_20 MHz BW Mode: 5745~5825)

802.11n Mode		Rate (Mbps)	Measured Power(dBm) + Duty Cycle Factor	Limit (dBm)
Frequency [MHz]	Channel No.			
5745	149	6.5 Mbps	8.89	30
		13 Mbps	8.91	30
		19.5 Mbps	8.92	30
		26 Mbps	8.91	30
		39 Mbps	8.89	30
		52 Mbps	8.84	30
		58.5 Mbps	8.78	30
		65 Mbps	8.82	30
5765	153	6.5 Mbps	7.90	30
		13 Mbps	7.87	30
		19.5 Mbps	7.89	30
		26 Mbps	7.88	30
		39 Mbps	7.80	30
		52 Mbps	7.83	30
		58.5 Mbps	7.82	30
		65 Mbps	7.88	30
5785	157	6.5 Mbps	8.75	30
		13 Mbps	8.81	30
		19.5 Mbps	8.77	30
		26 Mbps	8.74	30
		39 Mbps	8.60	30
		52 Mbps	8.52	30
		58.5 Mbps	8.64	30
		65 Mbps	8.59	30
5805	161	6.5 Mbps	7.91	30
		13 Mbps	7.91	30
		19.5 Mbps	7.87	30
		26 Mbps	7.93	30
		39 Mbps	7.87	30
		52 Mbps	7.81	30
		58.5 Mbps	7.85	30
		65 Mbps	7.78	30
5825	165	6.5 Mbps	8.68	30
		13 Mbps	8.61	30
		19.5 Mbps	8.54	30
		26 Mbps	8.58	30
		39 Mbps	8.58	30
		52 Mbps	8.56	30
		58.5 Mbps	8.51	30
		65 Mbps	8.64	30

40 MHz BW
Conducted Output Power Measurements (802.11n Mode: 5190~5230)

802.11a Mode		Rate (Mbps)	Measured Power(dBm) + Duty Cycle Factor	Limit (dBm)
Frequency [MHz]	Channel No.			
5190	38	13.5 Mbps	11.03	16.99
		27 Mbps	10.90	16.99
		40.5 Mbps	10.88	16.99
		54 Mbps	10.83	16.99
		81 Mbps	10.74	16.99
		108 Mbps	10.70	16.99
		121.5 Mbps	10.64	16.99
		135 Mbps	10.69	16.99
5230	46	13.5 Mbps	11.15	16.99
		27 Mbps	11.12	16.99
		40.5 Mbps	11.04	16.99
		54 Mbps	10.99	16.99
		81 Mbps	10.96	16.99
		108 Mbps	10.84	16.99
		121.5 Mbps	10.88	16.99
		135 Mbps	10.82	16.99
5270	54	13.5 Mbps	11.39	23.98
		27 Mbps	11.33	23.98
		40.5 Mbps	11.26	23.98
		54 Mbps	11.16	23.98
		81 Mbps	11.08	23.98
		108 Mbps	11.07	23.98
		121.5 Mbps	11.13	23.98
		135 Mbps	11.08	23.98
5310	62	13.5 Mbps	11.47	23.98
		27 Mbps	11.49	23.98
		40.5 Mbps	11.37	23.98
		54 Mbps	11.36	23.98
		81 Mbps	11.29	23.98
		108 Mbps	11.16	23.98
		121.5 Mbps	11.25	23.98
		135 Mbps	11.15	23.98
5510	102	13.5 Mbps	9.79	23.98
		27 Mbps	9.77	23.98
		40.5 Mbps	9.65	23.98
		54 Mbps	9.63	23.98
		81 Mbps	9.61	23.98
		108 Mbps	9.51	23.98
		121.5 Mbps	9.46	23.98
		135 Mbps	9.45	23.98

5550	110	13.5 Mbps	10.14	23.98
		27 Mbps	9.99	23.98
		40.5 Mbps	9.99	23.98
		54 Mbps	9.99	23.98
		81 Mbps	9.84	23.98
		108 Mbps	9.78	23.98
		121.5 Mbps	9.82	23.98
		135 Mbps	9.79	23.98
5670	134	13.5 Mbps	10.10	23.98
		27 Mbps	10.06	23.98
		40.5 Mbps	9.91	23.98
		54 Mbps	9.96	23.98
		81 Mbps	9.95	23.98
		108 Mbps	9.76	23.98
		121.5 Mbps	9.79	23.98
		135 Mbps	9.71	23.98

Conducted Output Power Measurements (802.11n_40 MHz BW Mode: 5755~5795)

5755	151	13.5 Mbps	9.52	30
		27 Mbps	9.31	30
		40.5 Mbps	9.33	30
		54 Mbps	9.30	30
		81 Mbps	9.23	30
		108 Mbps	9.18	30
		121.5 Mbps	9.17	30
		135 Mbps	9.21	30
5795	159	13.5 Mbps	9.25	30
		27 Mbps	9.08	30
		40.5 Mbps	9.17	30
		54 Mbps	9.10	30
		81 Mbps	9.13	30
		108 Mbps	8.88	30
		121.5 Mbps	8.93	30
		135 Mbps	8.79	30

11.5 SAR Test Exclusions Applied

11.5.1 BT

Since Wireless Router operations are not allowed by the chipset firmware using 5 GHz Wi-Fi, only 2.4 GHz Wi-Fi Hotspot SAR Tests and combinations are considered for SAR with respect to Wireless Router configurations according to FCC KDB 941225 D06v01r01.

Per FCC KDB 447498 D01v05r01, The SAR exclusion threshold for distance < 50mm is defined by the following equation:

$$\frac{\text{Max Power of Channel (mW)}}{\text{Test Separation Distance (mm)}} * \sqrt{\text{Frequency (GHz)}} \leq 3.0$$

Mode	Frequency	Maximum Allowed Power	Separatuin Distance	≤ 3.0
	[MHz]	[mW]	[mm]	
Bluetooth	2444	9	10	1.39

Based on the maximum conducted power of Bluetooth and antenna to use separation distance, Bluetooth SAR was not required $[(9/10)*\sqrt{2.444}] = 1.39 < 3.0$.

This device contains transmitters that may operate simultaneously. Therefore simultaneous transmission analysis is required. Per FCC KDB 447498 D01v05r01 IV.C.1iii, simultaneous transmission SAR test exclusion may be applied when the sum of the 1-g SAR for all the simultaneous transmitting antennas in a specific a physical test configuration is ≤ 1.6W/kg. When standalone SAR is not required to be measured per FCC KDB 447498 D01v05r01 4.3.22, the following equation must be used to estimate the standalone 1-g SAR for simultaneous transmission assessment involving that transmitter

$$\text{Estimated SAR} = \frac{\sqrt{f(\text{GHz})}}{7.5} * \frac{(\text{Max Power of channel mW})}{\text{Min Seperation Distance}}$$

Mode	Frequency	Maximum Allowed Power	Separatuin Distance (Body)	Estimated SAR (Body)
	[MHz]	[mW]	[mm]	[W/kg]
Bluetooth	2441	9	10	0.19

Note : Held-to ear configurations are not applicable to Bluetooth operations and therefore were not considered for simultaneous transmission. The Estimated SAR results were determined according to FCC KDB447498 D01v05r01

12. SAR Test configuration & Antenna Information

12.1 SAR Test configurations

Mode	Rear	Front	Left	Right	Bottom	Top
GSM 850	Yes	Yes	Yes	Yes	Yes	No
GSM 1 900	Yes	Yes	Yes	Yes	Yes	No
WCDMA 850	Yes	Yes	Yes	Yes	Yes	No
WCDMA 1900	Yes	Yes	Yes	Yes	Yes	No
2.4 GHz WLAN	Yes	Yes	No	Yes	No	Yes
5 GHz WLAN	Yes	Yes	No	Yes	No	Yes

* [Loking from the Front View]

12.2 Antenna and Device Information

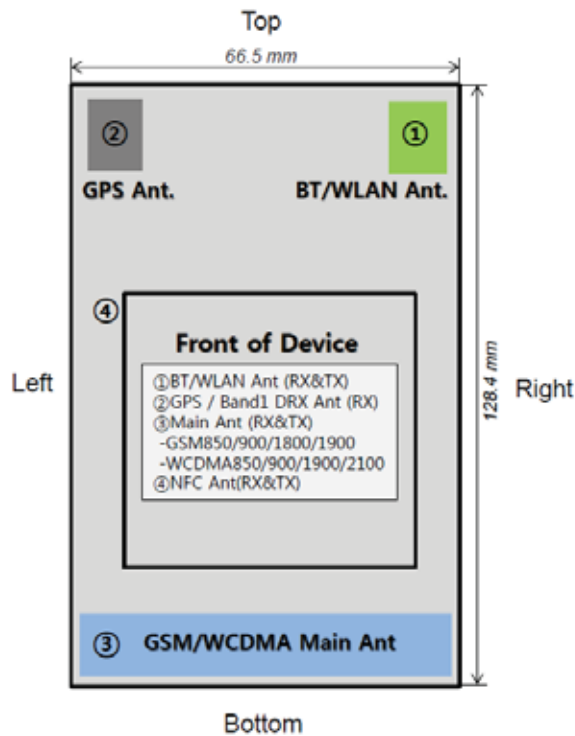

[Front View]

Note;

Per FCC KDB Publication 941225 D06v01r01, we performed the SAR testing at 1 cm from the top & bottom surfaces and also from side edges with a transmitting antenna ≤ 2.5 cm from an edge.

※ Please see LG-D605_Antenna_distance file for futher information.

13. SAR TEST DATA SUMMARY

13.1 Measurement Results (GSM850 Head SAR)

Frequency		Modulation	Conducted Power (dBm)	Power Drift (dB)	Battery	Phantom Position	Measured SAR(mW/g)	Scaling Factor	Scaled SAR(mW/g)	Plot No.
MHz	Ch.									
836.6	190	GSM850	33.36	-0.135	Standard	Left Ear	0.216	1.081	0.234	-
836.6	190		33.36	-0.068	Standard	Left Tilt	0.129	1.081	0.140	-
836.6	190		33.36	-0.189	Standard	Right Ear	0.266	1.081	0.288	-
836.6	190		33.36	0.046	Standard	Right Tilt	0.140	1.081	0.151	-
836.6	190	GPRS 4Tx	28.30	0.036	Standard	Left Ear	0.268	1.175	0.315	-
836.6	190		28.30	-0.051	Standard	Left Tilt	0.159	1.175	0.187	-
836.6	190		28.30	0.063	Standard	Right Ear	0.354	1.175	0.416	1
836.6	190		28.30	0.079	Standard	Right Tilt	0.174	1.175	0.204	-
ANSI/IEEE C95.1 - 1992- Safety Limit Spatial Peak Uncontrolled Exposure/ General Population						Head 1.6 W/kg (mW/g) Averaged over 1 gram				

NOTES:

- The test data reported are the worst-case SAR value with the antenna-head position set in a typical configuration. Test procedures used are according to FCC/OET Bulletin 65, Supplement C [July 2001].
- All modes of operation were investigated and the worst-case are reported.
- Measured Depth of Simulating Tissue is 15.0 cm ± 0.2 cm.
- Tissue parameters and temperatures are listed on the SAR plot.
- Battery Type Standard Extended Slim
Batteries are fully charged for all readings.
- Test Signal Call Mode Manual Test cord Base Station Simulator
- According to KDB 447498, Testing of other required channels within the operating mode of a frequency band is not required when the reported 1-g or 10-g SAR for the mid-band or highest output power channel is ≤ 0.8 W/kg or 2.0 W/kg, for 1-g or 10-g respectively, when the transmission band is ≤ 100 MHz.
- For Head SAR testing, the EUT was set in GPRS multi-slot class12 with 4uplink slots for GSM850 due to maximum source-based time-averaged output power.
According to the KDB 941225 D03 SAR test reduction GSM/GPRS/EDGE, the maximum output power configuration were chosen for SAR testing.
- GSM GPRS VoIP is 3rd Party applications possibly installed and used by the end-user

13.2 Measurement Results (GSM1900 Head SAR)

Frequency		Modulation	Conducted Power (dBm)	Power Drift (dB)	Battery	Phantom Position	Measured SAR(mW/g)	Scaling Factor	Scaled SAR(mW/g)	Plot No.
MHz	Ch.									
1 880.0	661	GSM 1900	30.21	-0.009	Standard	Left Ear	0.132	1.119	0.148	-
1 880.0	661		30.21	0.087	Standard	Left Tilt	0.059	1.119	0.066	-
1 880.0	661		30.21	0.054	Standard	Right Ear	0.116	1.119	0.130	-
1 880.0	661		30.21	0.106	Standard	Right Tilt	0.061	1.119	0.068	-
1 880.0	661	GPRS 4Tx	25.67	0.153	Standard	Left Ear	0.209	1.211	0.253	2
1 880.0	661		25.67	0.035	Standard	Left Tilt	0.096	1.211	0.116	-
1 880.0	661		25.67	-0.021	Standard	Right Ear	0.174	1.211	0.211	-
1 880.0	661		25.67	-0.061	Standard	Right Tilt	0.095	1.211	0.115	-
ANSI/ IEEE C95.1 - 1992- Safety Limit Spatial Peak Uncontrolled Exposure/ General Population						Head 1.6 W/kg (mW/g) Averaged over 1 gram				

NOTES:

- The test data reported are the worst-case SAR value with the antenna-head position set in a typical configuration. Test procedures used are according to FCC/OET Bulletin 65, Supplement C [July 2001].
- All modes of operation were investigated and the worst-case are reported.
- Measured Depth of Simulating Tissue is 15.0 cm ± 0.2 cm.
- Tissue parameters and temperatures are listed on the SAR plot.
- Battery Type Standard Extended Slim
Batteries are fully charged for all readings.
- Test Signal Call Mode Manual Test cord Base Station Simulator
- According to KDB 447498, Testing of other required channels within the operating mode of a frequency band is not required when the reported 1-g or 10-g SAR for the mid-band or highest output power channel is ≤ 0.8 W/kg or 2.0 W/kg, for 1-g or 10-g respectively, when the transmission band is ≤ 100 MHz.
- For Head SAR testing, the EUT was set in GPRS multi-slot class12 with 4uplink slots for GSM1900 due to maximum source-based time-averaged output power.
According to the KDB 941225 D03 SAR test reduction GSM/GPRS/EDGE, the maximum output power configuration were chosen for SAR testing.
- GSM GPRS VoIP is 3rd Party applications possibly installed and used by the end-user

13.3 Measurement Results (WCDMA850 Head SAR)

Frequency		Modulation	Conducted Power (dBm)	Power Drift (dB)	Battery	Phantom Position	Measured SAR(mW/g)	Scaling Factor	Scaled SAR(mW/g)	Plot No.
MHz	Ch.									
836.6	4183	WCDMA850	23.93	-0.181	Standard	Left Ear	0.251	1.040	0.261	-
836.6	4183		23.93	-0.110	Standard	Left Tilt	0.141	1.040	0.147	-
836.6	4183		23.93	-0.087	Standard	Right Ear	0.325	1.040	0.338	3
836.6	4183		23.93	-0.054	Standard	Right Tilt	0.159	1.040	0.165	-
ANSI/ IEEE C95.1 - 1992- Safety Limit Spatial Peak Uncontrolled Exposure/ General Population						Head 1.6 W/kg (mW/g) Averaged over 1 gram				

NOTES:

- The test data reported are the worst-case SAR value with the antenna-head position set in a typical configuration. Test procedures used are according to FCC/OET Bulletin 65, Supplement C [July 2001].
- All modes of operation were investigated and the worst-case are reported.
- Measured Depth of Simulating Tissue is 15.0 cm ± 0.2 cm.
- Tissue parameters and temperatures are listed on the SAR plot.
- Battery Type Standard Extended Slim
Batteries are fully charged for all readings.
- Test Signal Call Mode Manual Test cord Base Station Simulator
- According to KDB 447498, Testing of other required channels within the operating mode of a frequency band is not required when the reported 1-g or 10-g SAR for the mid-band or highest output power channel is ≤ 0.8 W/kg or 2.0 W/kg, for 1-g or 10-g respectively, when the transmission band is ≤ 100 MHz.
- WCDMA Mode was tested under RMC 12.2 kbps and HSPA Inactive.

13.4 Measurement Results (WCDMA1900 Head SAR)

Frequency		Modulation	Conducted Power (dBm)	Power Drift (dB)	Battery	Phantom Position	Measured SAR (mW/g)	Scaling Factor	Scaled SAR (mW/g)	Plot No.
MHz	Channel									
1 880.0	9400 (Mid)	WCDMA1900	23.38	0.098	Standard	Left Ear	0.180	1.028	0.185	4
			23.38	0.119	Standard	Left Tilt	0.072	1.028	0.074	-
			23.38	-0.143	Standard	Right Ear	0.124	1.028	0.127	-
			23.38	0.055	Standard	Right Tilt	0.066	1.028	0.068	-
ANSI/ IEEE C95.1 - 2005– Safety Limit Spatial Peak Uncontrolled Exposure/ General Population						Head 1.6 W/kg (mW/g) Averaged over 1 gram				

NOTES:

- 1 The test data reported are the worst-case SAR value with the antenna-head position set in a typical configuration. Test procedures used are according to FCC/OET Bulletin 65, Supplement C [July 2001].
- 2 All modes of operation were investigated and the worst-case are reported.
- 3 Measured Depth of Simulating Tissue is 15.0 cm ± 0.2 cm.
- 4 Tissue parameters and temperatures are listed on the SAR plot.
- 5 Battery Type Standard Extended Slim
Batteries are fully charged for all readings.
- 6 Test Signal Call Mode Manual Test cord Base Station Simulator
- 7 According to KDB 447498, Testing of other required channels within the operating mode of a frequency band is not required when the reported 1-g or 10-g SAR for the mid-band or highest output power channel is ≤ 0.8 W/kg or 2.0 W/kg, for 1-g or 10-g respectively, when the transmission band is ≤ 100 MHz.

13.5 Measurement Results (DTS Head SAR)

Frequency		Modulation	Conducted Power (dBm)	Power Drift (dB)	Battery	Phantom Position	Data Rate	Measured SAR(mW/g)	Scaling Factor	Scaled SAR(mW/g)	Plot No.
MHz	Ch										
2 462	11	802.11b	11.38	0.135	Standard	Left Ear	1Mbps	0.272	1.629	0.443	5
2 462	11	802.11b	11.38	0.135	Standard	Left Tilt	1Mbps	0.191	1.629	0.311	-
2 462	11	802.11b	11.38	0.110	Standard	Right Ear	1Mbps	0.135	1.629	0.220	-
2 462	11	802.11b	11.38	0.053	Standard	Right Tilt	1Mbps	0.148	1.629	0.241	-
5 745	149	802.11a	9.84	-0.181	Standard	Left Ear	6Mbps	0.039	1.762	0.069	6
5 745	149	802.11a	9.84	0.150	Standard	Left Tilt	6Mbps	0.013	1.762	0.023	-
5 745	149	802.11a	9.84	0.100	Standard	Right Ear	6Mbps	0.008	1.762	0.014	-
5 745	149	802.11a	9.84	0.130	Standard	Right Tilt	6Mbps	0.016	1.762	0.028	-
ANSI/ IEEE C95.1 - 1992- Safety Limit						Head					
Spatial Peak						1.6 W/kg (mW/g)					
Uncontrolled Exposure/ General Population						Averaged over 1 gram					

NOTES:

- 1 The test data reported are the worst-case SAR value with the antenna-head position set in a typical configuration. Test procedures used are according to FCC/OET Bulletin 65, Supplement C [July 2001].
- 2 All modes of operation were investigated and the worst-case are reported.
- 3 Measured Depth of Simulating Tissue is 15.0 cm ± 0.2 cm.
- 4 Tissue parameters and temperatures are listed on the SAR plot.
- 5 Battery Type Standard Extended Slim
Batteries are fully charged for all readings.
- 6 Test Signal Call Mode Manual Test cord Base Station Simulator
- 7 IEEE 802.11g(including 802.11n) SAR testing is required when the conducted powers are equal to or greater than 0.25 dB Than the conducted powers in IEEE 802.11b.
- 8 For 2.4GHz/5 GHz WLAN, Highest average power channel for the lowest data rate was selected for SAR evaluation based on KDB 248227. Other channels are not necessary because 1g-average SAR < 0.8 W/Kg and peak SAR < 1.6W/Kg per KDB 248227.
- 9 Per April 2013 TCB Workshop notes, full SAR tests for all IEEE 802.11ac configurations were not required because the average output power was not more than 0.25 dB higher than IEEE 802.11a mode. IEEE 802.11ac was evaluated for the highest IEEE 802.11a position in each 5 GHz Band and exposure condition

13.6 Measurement Results (NIH Head SAR)

Frequency		Modulation	Conducted Power (dBm)	Power Drift (dB)	Battery	Phantom Position	Data Rate	Measured SAR (mW/g)	Scaling Factor	Scaled SAR (mW/g)	Plot No.
MHz	Channel										
5 240	48	802.11a	11.34	-0.113	Standard	Left Ear	6Mbps	0.033	1.247	0.041	-
5 240	48	802.11a	11.34	0.051	Standard	Left Tilt	6Mbps	0.015	1.247	0.019	-
5 240	48	802.11a	11.34	0.172	Standard	Right Ear	6Mbps	0.011	1.247	0.014	-
5 240	48	802.11a	11.34	0.170	Standard	Right Tilt	6Mbps	0.015	1.247	0.019	-
5 300	60	802.11a	11.77	-0.108	Standard	Left Ear	6Mbps	0.062	1.130	0.070	7
5 300	60	802.11a	11.77	0.183	Standard	Left Tilt	6Mbps	0.017	1.130	0.019	-
5 300	60	802.11a	11.77	0.005	Standard	Right Ear	6Mbps	0.032	1.130	0.036	-
5 300	60	802.11a	11.77	0.041	Standard	Right Tilt	6Mbps	0.018	1.130	0.020	-
5 580	116	802.11a	10.70	0.168	Standard	Left Ear	6Mbps	0.040	1.445	0.058	-
5 580	116	802.11a	10.70	0.140	Standard	Left Tilt	6Mbps	0.016	1.445	0.023	-
5 580	116	802.11a	10.70	0.100	Standard	Right Ear	6Mbps	0.024	1.445	0.035	-
5 580	116	802.11a	10.70	0.120	Standard	Right Tilt	6Mbps	0.016	1.445	0.023	-
ANSI/ IEEE C95.1 - 1992- Safety Limit Spatial Peak Uncontrolled Exposure/ General Population							Head 1.6 W/kg (mW/g) Averaged over 1 gram				

NOTES:

- The test data reported are the worst-case SAR value with the antenna-head position set in a typical configuration. Test procedures used are according to FCC/OET Bulletin 65, Supplement C [July 2001].
- All modes of operation were investigated and the worst-case are reported.
- Measured Depth of Simulating Tissue is 15.0 cm ± 0.2 cm.
- Tissue parameters and temperatures are listed on the SAR plot.
- Battery Type Standard Extended Slim
Batteries are fully charged for all readings.
- Test Signal Call Mode Manual Test cord Base Station Simulator
- Highest average RF output power channel for the lowest data rate were selected for SAR testing. IEEE 802.11(including 802.11n) SAR testing is required when the conducted powers are equal to or greater than 0.25 dB than the conducted powers in IEEE 802.11a.
- For 5 GHz WLAN, Highest average power channel for the lowest data rate was selected for SAR evaluation based on KDB 248227. Other channels are not necessary because 1g-average SAR < 0.8 W/Kg and peak SAR < 1.6W/Kg per KDB 248227.
- Per April 2013 TCB Workshop notes, full SAR tests for all IEEE 802.11ac configurations were not required because the average output power was not more than 0.25 dB higher than IEEE 802.11a mode. IEEE 802.11ac was evaluated for the highest IEEE 802.11a position in each 5 GHz Band and exposure condition

13.7 Measurement Results (GSM850 Hotspot SAR)

Frequency		Modulation	Conducted Power (dBm)	Power Drift (dB)	Configuration	Separation Distance	Measured SAR(mW/g)	Scaling Factor	Scaled SAR(mW/g)	Plot No.
MHz	Ch.									
836.6	190	GPRS 4Tx	28.3	-0.174	Rear	1 cm	0.506	1.175	0.594	8
836.6	190		28.3	-0.085	Front	1 cm	0.370	1.175	0.435	-
836.6	190		28.3	0.144	Left	1 cm	0.251	1.175	0.295	-
836.6	190		28.3	-0.053	Right	1 cm	0.385	1.175	0.452	-
836.6	190		28.3	0.169	Bottom	1 cm	0.137	1.175	0.161	-
ANSI/ IEEE C95.1 - 1992- Safety Limit Spatial Peak Uncontrolled Exposure/ General Population						Body 1.6 W/kg (mW/g) Averaged over 1 gram				

NOTES:

- The test data reported are the worst-case SAR value with the antenna-body position set in a typical configuration. Test procedures used are according to FCC/OET Bulletin 65, Supplement C [July 2001].
- All modes of operation were investigated and the worst-case are reported.
- Measured Depth of Simulating Tissue is 15.0 cm \pm 0.2 cm.
- Tissue parameters and temperatures are listed on the SAR plot.
- Battery Type Standard Extended Slim
Batteries are fully charged for all readings.
- Test Signal Call Mode Manual Test cord Base Station Simulator
- Test Configuration With Holster Without Holster
- According to KDB 447498, Testing of other required channels within the operating mode of a frequency band is not required when the reported 1-g or 10-g SAR for the mid-band or highest output power channel is \leq 0.8 W/kg or 2.0 W/kg, for 1-g or 10-g respectively, when the transmission band is \leq 100 MHz.
- For body SAR testing, the EUT was set in GPRS multi-slot class12 with 4uplink slots for GSM850 due to maximum source-based time-averaged output power.
According to the KDB 941225 D03 SAR test reduction GSM/GPRS/EDGE, the maximum output power configuration were chosen for Body SAR testing.

13.8 Measurement Results (GSM1900 Hotspot SAR)

Frequency		Modulation	Conducted Power (dBm)	Power Drift (dB)	Configuration	Separation Distance	Measured SAR(mW/g)	Scaling Factor	Scaled SAR(mW/g)	Plot No.
MHz	Ch.									
1850.2	512	GPRS 4Tx	25.77	-0.154	Rear	1 cm	0.580	1.183	0.686	-
1 880.0	661		25.67	-0.130	Rear	1 cm	0.678	1.211	0.821	9
1909.8	810		25.67	0.030	Rear	1 cm	0.610	1.211	0.738	-
1 880.0	661		25.67	0.043	Front	1 cm	0.329	1.211	0.398	-
1 880.0	661		25.67	0.013	Left	1 cm	0.131	1.211	0.159	-
1 880.0	661		25.67	-0.120	Right	1 cm	0.134	1.211	0.162	-
1850.2	512		25.77	0.167	Bottom	1 cm	0.481	1.183	0.569	-
1 880.0	661		25.67	-0.030	Bottom	1 cm	0.671	1.211	0.812	-
1909.8	810		25.67	-0.197	Bottom	1 cm	0.509	1.211	0.616	-
ANSI/ IEEE C95.1 - 1992- Safety Limit Spatial Peak Uncontrolled Exposure/ General Population						Body 1.6 W/kg (mW/g) Averaged over 1 gram				

NOTES:

- The test data reported are the worst-case SAR value with the antenna-body position set in a typical configuration. Test procedures used are according to FCC/OET Bulletin 65, Supplement C [July 2001].
- All modes of operation were investigated and the worst-case are reported.
- Measured Depth of Simulating Tissue is 15.0 cm ± 0.2 cm.
- Tissue parameters and temperatures are listed on the SAR plot.
- Battery Type Standard Extended Slim
Batteries are fully charged for all readings.
- Test Signal Call Mode Manual Test cord Base Station Simulator
- Test Configuration With Holster Without Holster
- According to KDB 447498, Testing of other required channels within the operating mode of a frequency band is not required when the reported 1-g or 10-g SAR for the mid-band or highest output power channel is ≤ 0.8 W/kg or 2.0 W/kg, for 1-g or 10-g respectively, when the transmission band is ≤ 100 MHz.
- For body SAR testing, the EUT was set in GPRS multi-slot class12 with 4uplink slots for GSM1900 due to maximum source-based time-averaged output power.
According to the KDB 941225 D03 SAR test reduction GSM/GPRS/EDGE, the maximum output power configuration were chosen for Body SAR testing.

13.9 Measurement Results (WCDMA850 Hotspot SAR)

Frequency		Modulation	Conducted Power (dBm)	Power Drift (dB)	Configuration	Separation Distance	Measured SAR(mW/g)	Scaling Factor	Scaled SAR(mW/g)	Plot No.
MHz	Ch.									
836.6	4183	WCDMA850	23.93	0.005	Rear	1 cm	0.501	1.040	0.521	10
836.6	4183		23.93	-0.086	Front	1 cm	0.365	1.040	0.380	-
836.6	4183		23.93	0.023	Left	1 cm	0.231	1.040	0.240	-
836.6	4183		23.93	-0.114	Right	1 cm	0.389	1.040	0.405	-
836.6	4183		23.93	-0.146	Bottom	1 cm	0.136	1.040	0.141	-
ANSI/ IEEE C95.1 - 1992- Safety Limit Spatial Peak Uncontrolled Exposure/ General Population						Body 1.6 W/kg (mW/g) Averaged over 1 gram				

NOTES:

- The test data reported are the worst-case SAR value with the antenna-Body position set in a typical configuration. Test procedures used are according to FCC/OET Bulletin 65, Supplement C [July 2001].
- All modes of operation were investigated and the worst-case are reported.
- Measured Depth of Simulating Tissue is 15.0 cm ± 0.2 cm.
- Tissue parameters and temperatures are listed on the SAR plot.
- Battery Type Standard Extended Slim
Batteries are fully charged for all readings.
- Test Signal Call Mode Manual Test cord Base Station Simulator
- Test Configuration With Holster Without Holster
- According to KDB 447498, Testing of other required channels within the operating mode of a frequency band is not required when the reported 1-g or 10-g SAR for the mid-band or highest output power channel is ≤ 0.8 W/kg or 2.0 W/kg, for 1-g or 10-g respectively, when the transmission band is ≤ 100 MHz.
- WCDMA Mode was tested under RMC 12.2 kbps and HSPA Inactive.

13.10 Measurement Results (WCDMA1900 Hotspot SAR)

Frequency		Modulation	Conducted Power (dBm)	Power Drift (dB)	Configuration	Separation Distance	Measured SAR (mW/g)	Scaling Factor	Scaled SAR (mW/g)	Plot No.
MHz	Channel									
1 880	9400 (Mid)	WCDMA1900	23.38	0.035	Rear	1.0 cm	0.479	1.028	0.492	-
			23.38	0.067	Front	1.0 cm	0.233	1.028	0.240	-
			23.38	-0.051	Left	1.0 cm	0.084	1.028	0.086	-
			23.38	-0.189	Right	1.0 cm	0.092	1.028	0.095	-
			23.38	-0.082	Bottom	1.0 cm	0.519	1.028	0.534	11
ANSI/ IEEE C95.1 - 1992– Safety Limit Spatial Peak Uncontrolled Exposure/ General Population						Body 1.6 W/kg (mW/g) Averaged over 1 gram				

NOTES:

- The test data reported are the worst-case SAR value with the antenna-body position set in a typical configuration. Test procedures used are according to FCC/OET Bulletin 65, Supplement C [July 2001].
- All modes of operation were investigated and the worst-case are reported.
- Measured Depth of Simulating Tissue is 15.0 cm ± 0.2 cm.
- Tissue parameters and temperatures are listed on the SAR plot.
- Battery Type Standard Extended Slim
Batteries are fully charged for all readings.
- Test Signal Call Mode Manual Test cord Base Station Simulator
- Test Configuration With Holster Without Holster
- According to KDB 447498, Testing of other required channels within the operating mode of a frequency band is not required when the reported 1-g or 10-g SAR for the mid-band or highest output power channel is ≤ 0.8 W/kg or 2.0 W/kg, for 1-g or 10-g respectively, when the transmission band is ≤ 100 MHz.

13.11 Measurement Results (WLAN Hotspot SAR)

Frequency		Modulation	Conducted Power (dBm)	Power Drift (dB)	Configuration	Data Rate	Separation Distance	Measured SAR (mW/g)	Scaling Factor	Scaled SAR (mW/g)	Plot No.
MHz	Ch.										
2462	11	802.11b	13.38	0.004	Rear	1Mbps	1 cm	0.161	1.629	0.262	12
			13.38	0.117	Front	1Mbps	1 cm	0.062	1.629	0.101	-
			13.38	-0.003	Right	1Mbps	1 cm	0.106	1.629	0.173	-
			13.38	0.020	Top	1Mbps	1 cm	0.067	1.629	0.109	-
ANSI/ IEEE C95.1 - 1992- Safety Limit Spatial Peak Uncontrolled Exposure/ General Population							Body 1.6 W/kg (mW/g) Averaged over 1 gram				

NOTES:

- The test data reported are the worst-case SAR value with the antenna-body position set in a typical configuration. Test procedures used are according to FCC/OET Bulletin 65, Supplement C [July 2001].
- All modes of operation were investigated and the worst-case are reported.
- Measured Depth of Simulating Tissue is 15.0 cm \pm 0.2 cm.
- Tissue parameters and temperatures are listed on the SAR plot.
- Battery Type Standard Extended Slim
Batteries are fully charged for all readings.
- Test Signal Call Mode Manual Test code Base Station Simulator
- IEEE 802.11g(including 802.11n) SAR testing is required when the conducted powers are equal to or greater than 0.25 dB Than the conducted powers in IEEE 802.11b.
- For 2.4GHz WLAN, Highest average power channel for the lowest data rate was selected for SAR evaluation based on KDB 248227. Other channels are not necessary because 1g-average SAR < 0.8 W/Kg and peak SAR < 1.6W/Kg per KDB 248227.
- Per April 2013 TCB Workshop notes, full SAR tests for all IEEE 802.11ac configurations were not required because the average output power was not more than 0.25 dB higher than IEEE 802.11a mode. IEEE 802.11ac was evaluated for the highest IEEE 802.11a position in each 5 GHz Band and exposure condition
- 5 GHz WiFi Direct GO is supported in the 5.8 GHz Band only. The manufacturer expects 5.8 GHz WiFi Direct GO may be used similar to wireless router usage. Therefore, 5.8 GHz WiFi Direct GO was evaluated for SAR similar to wireless router SAR procedures in KDB 941225.

13.12 Measurement Results (DTS Body-worn)

Frequency		Modulation	Conducted Power (dBm)	Power Drift (dB)	Configuration	Data Rate	Separation Distance	Measured SAR (mW/g)	Scaling Factor	Scaled SAR (mW/g)	Plot No.
MHz	Ch.										
2 412	11	802.11b	13.38	0.004	Rear	1Mbps	1 cm	0.161	1.629	0.262	12
2 412	11	802.11b	13.38	0.117	Front	1Mbps	1 cm	0.062	1.629	0.101	-
5 745	149	802.11a	9.84	0.162	Rear	6Mbps	1 cm	0.184	1.762	0.069	13
5 745	149	802.11a	9.84	0.100	Front	6Mbps	1 cm	0.017	1.762	0.023	-
ANSI/ IEEE C95.1 - 1992- Safety Limit Spatial Peak Uncontrolled Exposure/ General Population							Body 1.6 W/kg (mW/g) Averaged over 1 gram				

NOTES:

- The test data reported are the worst-case SAR value with the antenna-body position set in a typical configuration. Test procedures used are according to FCC/OET Bulletin 65, Supplement C [July 2001].
- All modes of operation were investigated and the worst-case are reported.
- Measured Depth of Simulating Tissue is 15.0 cm ± 0.2 cm.
- Tissue parameters and temperatures are listed on the SAR plot.
- Battery Type Standard Extended Slim
Batteries are fully charged for all readings.
- Test Signal Call Mode Manual Test code Base Station Simulator
- Highest average RF output power channel for the lowest data rate were selected for SAR testing. IEEE 802.11(including 802.11n) SAR testing is required when the conducted powers are equal to or greater than 0.25 dB than the conducted powers in IEEE 802.11a.
- For 5 GHz WLAN, Highest average power channel for the lowest data rate was selected for SAR evaluation based on KDB 248227. Other channels are not necessary because 1g-average SAR < 0.8 W/Kg and peak SAR < 1.6W/Kg per KDB 248227.
- Per April 2013 TCB Workshop notes, full SAR tests for all IEEE 802.11ac configurations were not required because the average output power was not more than 0.25 dB higher than IEEE 802.11a mode. IEEE 802.11ac was evaluated for the highest IEEE 802.11a position in each 5 GHz Band and exposure condition

13.13 Measurement Results (NII Body-worn SAR)

Frequency		Modulation	Conducted Power (dBm)	Power Drift (dB)	Configuration	Data Rate	Separation Distance	Measured SAR(mW/g)	Scaling Factor	Scaled SAR(mW/g)	Plot No.
MHz	Ch.										
5 240	48	802.11a	11.34	-0.101	Rear	6Mbps	1 cm	0.284	1.247	0.354	-
5 240	48	802.11a	11.34	0.174	Front	6Mbps	1 cm	0.008	1.247	0.010	-
5 300	60	802.11a	11.77	-0.135	Rear	6Mbps	1 cm	0.340	1.130	0.384	14
5 300	60	802.11a	11.77	-0.197	Front	6Mbps	1 cm	0.006	1.130	0.007	-
5 580	116	802.11a	10.70	0.102	Rear	6Mbps	1 cm	0.251	1.445	0.363	-
5 580	116	802.11a	10.70	-0.178	Front	6Mbps	1 cm	0.009	1.445	0.013	-
ANSI/ IEEE C95.1 - 1992- Safety Limit Spatial Peak Uncontrolled Exposure/ General Population							Body 1.6 W/kg (mW/g) Averaged over 1 gram				

NOTES:

- The test data reported are the worst-case SAR value with the antenna-body position set in a typical configuration. Test procedures used are according to FCC/OET Bulletin 65, Supplement C [July 2001].
- All modes of operation were investigated and the worst-case are reported.
- Measured Depth of Simulating Tissue is 15.0 cm ± 0.2 cm.
- Tissue parameters and temperatures are listed on the SAR plot.
- Battery Type Standard Extended Slim
Batteries are fully charged for all readings.
- Test Signal Call Mode Manual Test code Base Station Simulator
- Highest average RF output power channel for the lowest data rate were selected for SAR testing. IEEE 802.11(including 802.11n) SAR testing is required when the conducted powers are equal to or greater than 0.25 dB than the conducted powers in IEEE 802.11a.
- For 5 GHz WLAN, Highest average power channel for the lowest data rate was selected for SAR evaluation based on KDB 248227. Other channels are not necessary because 1g-average SAR < 0.8 W/Kg and peak SAR < 1.6W/Kg per KDB 248227.
- Per April 2013 TCB Workshop notes, full SAR tests for all IEEE 802.11ac configurations were not required because the average output power was not more than 0.25 dB higher than IEEE 802.11a mode. IEEE 802.11ac was evaluated for the highest IEEE 802.11a position in each 5 GHz Band and exposure condition

13.14 Measurement Results (Body-worn SAR)

Frequency		Modulation	Conducted Power (dBm)	Power Drift (dB)	Configuration	Separation Distance	Measured SAR(mW/g)	Scaling Factor	Scaled SAR(mW/g)	Plot No.
MHz	Ch.									
836.6	190	GSM 850	33.36	0.173	Rear	1 cm	0.369	1.081	0.399	15
836.6	190	GSM 850	33.36	0.033	Front	1 cm	0.262	1.081	0.283	
836.6	190	GPRS 4Tx	28.3	-0.174	Rear	1 cm	0.506	1.175	0.594	8
836.6	190	GPRS 4Tx	28.3	-0.085	Front	1 cm	0.370	1.175	0.435	
1 880.0	661	GSM1900	30.21	-0.093	Rear	1 cm	0.428	1.119	0.479	16
1 880.0	661	GSM1900	30.21	0.131	Front	1 cm	0.179	1.119	0.200	
1 880.0	661	GPRS 4Tx	25.67	-0.130	Rear	1 cm	0.678	1.211	0.821	9
1 880.0	661	GPRS 4Tx	25.67	0.043	Front	1 cm	0.329	1.211	0.398	
836.6	4183	WCDMA 850	23.93	0.005	Rear	1 cm	0.501	1.040	0.521	10
836.6	4183	WCDMA 850	23.93	-0.086	Front	1 cm	0.365	1.040	0.380	
1 880	9400	WCDMA 1900	23.38	0.035	Rear	1.0 cm	0.479	1.028	0.492	11
1 880	9400	WCDMA 1900	23.38	0.067	Front	1.0 cm	0.233	1.028	0.240	
ANSI/ IEEE C95.1 - 1992- Safety Limit Spatial Peak Uncontrolled Exposure/ General Population							Body 1.6 W/kg (mW/g) Averaged over 1 gram			

NOTES:

- 1 The test data reported are the worst-case SAR value with the antenna-body position set in a typical configuration. Test procedures used are according to FCC/OET Bulletin 65, Supplement C [July 2001].
- 2 All modes of operation were investigated and the worst-case are reported.
- 3 Measured Depth of Simulating Tissue is 15.0 cm ± 0.2 cm.
- 4 Tissue parameters and temperatures are listed on the SAR plot.
- 5 According to KDB 447498, Testing of other required channels within the operating mode of a frequency band is not required when the reported 1-g or 10-g SAR for the mid-band or highest output power channel is ≤ 0.8 W/kg or 2.0 W/kg, for 1-g or 10-g respectively, when the transmission band is ≤ 100 MHz.
- 6 Body-Worn accessory testing is typically associated with voice operation. Therefore, GSM voice was evaluated for body-worn SAR.

14. SAR Measurement Variability and Uncertainty

In accordance with published RF Exposure KDB procedure 865664 D01 SAR measurement 100 MHz to 6 GHz v01r01. These additional measurements are repeated after the completion of all measurements requiring the same head or body tissue-equivalent medium in a frequency band. The test device should be returned to ambient conditions (normal room temperature) with the battery fully charged before it is re-mounted on the device holder for the repeated measurement(s) to minimize any unexpected variations in the repeated results.

- 1) Repeated measurement is not required when the original highest measured SAR is < 0.80 W/kg; steps 2) through 4) do not apply.
- 2) When the original highest measured SAR is ≥ 0.80 W/kg, repeat that measurement once.
- 3) Perform a second repeated measurement only if the ratio of largest to smallest SAR for the original and first repeated measurements is > 1.20 or when the original or repeated measurement is ≥ 1.45 W/kg (~ 10% from the 1-g SAR limit).
- 4) Perform a third repeated measurement only if the original, first or second repeated measurement is ≥ 1.5 W/kg and the ratio of largest to smallest SAR for the original, first and second repeated measurements is > 1.20 .

Note(s):

1. Second Repeated Measurement is not required since the ratio of the largest to smallest SAR for the original and first repeated measurement is not > 1.20 .
2. Repeated measurement is not required when the original highest measured SAR is < 0.80 W/kg.

*In this model, not applicable

15. SAR Summation Scenario

	Position	Applicable Combination		Note
Simultaneous Transmission	Head	GSM850 Voice	+ 2.4 GHz WiFi	
		GSM1900 Voice	+ 2.4 GHz WiFi	
		WCDMA850 Voice	+ 2.4 GHz WiFi	
		WCDMA1900 Voice	+ 2.4 GHz WiFi	
		GPRS 850 Data	+ 2.4 GHz WiFi	
		GPRS 1900 Data	+ 2.4 GHz WiFi	
		GSM850 Voice	+ 5 GHz WiFi	
		GSM1900 Voice	+ 5 GHz WiFi	
		WCDMA850 Voice	+ 5 GHz WiFi	
		WCDMA1900 Voice	+ 5 GHz WiFi	
	Hotspot	GPRS850 Data	+ 2.4 GHz WiFi	
		GPRS1900 Data	+ 2.4 GHz WiFi	
		WCDMA850 Data	+ 2.4 GHz WiFi	
		WCDMA1900 Data	+ 2.4 GHz WiFi	
	Body-worn	GSM850 Voice	+ 2.4 GHz WiFi	
		GSM1900 Voice	+ 2.4 GHz WiFi	
		WCDMA850 Voice	+ 2.4 GHz WiFi	
		WCDMA1900 Voice	+ 2.4 GHz WiFi	
		GPRS850 Data	+ 2.4 GHz WiFi	
		GPRS1900 Data	+ 2.4 GHz WiFi	
		GSM850 Voice	+ 2.4 GHz Bluetooth	
		GSM1900 Voice	+ 2.4 GHz Bluetooth	
		WCDMA850 Voice	+ 2.4 GHz Bluetooth	
		WCDMA1900 Voice	+ 2.4 GHz Bluetooth	
		GPRS850 Data	+ 2.4 GHz Bluetooth	
		GPRS1900 Data	+ 2.4 GHz Bluetooth	
		GSM850 Voice	+ 5 GHz WiFi	
		GSM1900 Voice	+ 5 GHz WiFi	
	WCDMA850 Voice	+ 5 GHz WiFi		
	WCDMA1900 Voice	+ 5 GHz WiFi		

* BT and WLAN are not simultaneous transmission.

15.1 Simultaneous Transmission Summation for Head

Simultaneous Transmission Summation for Held to Ear

Band	configuration	Scaled SAR(W/kg)	2.4 GHz WIFI Scaled SAR (W/kg)	Σ 1-g SAR (W/kg)
GSM 850	Left Cheek	0.234	0.443	0.677
	Left Tilt	0.140	0.311	0.451
	Right Cheek	0.288	0.220	0.508
	Right Tilt	0.151	0.241	0.392
GSM 1 900	Left Cheek	0.148	0.443	0.591
	Left Tilt	0.066	0.311	0.377
	Right Cheek	0.130	0.220	0.350
	Right Tilt	0.068	0.241	0.309
WCDMA 850	Left Cheek	0.261	0.443	0.704
	Left Tilt	0.147	0.311	0.458
	Right Cheek	0.338	0.220	0.558
	Right Tilt	0.165	0.241	0.406
WCDMA 1900	Left Cheek	0.185	0.443	0.628
	Left Tilt	0.074	0.311	0.385
	Right Cheek	0.127	0.220	0.347
	Right Tilt	0.068	0.241	0.309
GPRS 850	Left Cheek	0.315	0.443	0.758
	Left Tilt	0.187	0.311	0.498
	Right Cheek	0.416	0.220	0.636
	Right Tilt	0.204	0.241	0.445
GPRS 1 900	Left Cheek	0.253	0.443	0.696
	Left Tilt	0.116	0.311	0.427
	Right Cheek	0.211	0.220	0.431
	Right Tilt	0.115	0.241	0.356

Band	configuration	Scaled SAR(W/kg)	5 GHz WIFI Scaled SAR (W/kg)	Σ 1-g SAR (W/kg)
GSM 850	Left Cheek	0.234	0.070	0.304
	Left Tilt	0.140	0.023	0.163
	Right Cheek	0.288	0.036	0.324
	Right Tilt	0.151	0.028	0.179
GSM 1 900	Left Cheek	0.148	0.070	0.218
	Left Tilt	0.066	0.023	0.089
	Right Cheek	0.130	0.036	0.166
	Right Tilt	0.068	0.028	0.096
WCDMA 850	Left Cheek	0.261	0.070	0.331
	Left Tilt	0.147	0.023	0.170
	Right Cheek	0.338	0.036	0.374
	Right Tilt	0.165	0.028	0.193
WCDMA 1900	Left Cheek	0.185	0.070	0.255
	Left Tilt	0.074	0.023	0.097
	Right Cheek	0.127	0.036	0.163
	Right Tilt	0.068	0.028	0.096
GPRS 850	Left Cheek	0.315	0.070	0.385
	Left Tilt	0.187	0.023	0.210
	Right Cheek	0.416	0.036	0.452
	Right Tilt	0.204	0.028	0.232
GPRS 1 900	Left Cheek	0.253	0.070	0.323
	Left Tilt	0.116	0.023	0.139
	Right Cheek	0.211	0.036	0.247
	Right Tilt	0.115	0.028	0.143

15.2 Simultaneous Transmission Summation for Body-Worn

Simultaneous Transmission Summation with 2.4 GHz WLAN (1.0 cm)

Band	configuration	Scaled SAR(W/kg)	2.4 GHz WIFI Scaled SAR (W/kg)	Σ 1-g SAR (W/kg)
GSM 850	Rear	0.399	0.262	0.661
GSM 850	Front	0.283	0.101	0.384
GSM 1900	Rear	0.479	0.262	0.741
GSM 1900	Front	0.200	0.101	0.301
WCDMA 850	Rear	0.521	0.262	0.783
WCDMA 850	Front	0.380	0.101	0.481
WCDMA 1900	Rear	0.492	0.262	0.754
WCDMA 1900	Front	0.240	0.101	0.341
GPRS 850	Rear	0.594	0.262	0.856
GPRS 850	Front	0.435	0.101	0.536
GPRS 1900	Rear	0.821	0.262	1.083
GPRS 1900	Front	0.398	0.101	0.499

Simultaneous Transmission Summation with 5 GHz WLAN (1.0 cm)

Band	configuration	Scaled SAR(W/kg)	5 GHz WIFI Scaled SAR (W/kg)	Σ 1-g SAR (W/kg)
GSM 850	Rear	0.399	0.384	0.783
GSM 850	Front	0.283	0.023	0.306
GSM 1900	Rear	0.479	0.384	0.863
GSM 1900	Front	0.200	0.023	0.223
WCDMA 850	Rear	0.521	0.384	0.905
WCDMA 850	Front	0.380	0.023	0.403
WCDMA 1900	Rear	0.492	0.384	0.876
WCDMA 1900	Front	0.240	0.023	0.263
GPRS 850	Rear	0.594	0.384	0.978
GPRS 850	Front	0.435	0.023	0.458
GPRS 1900	Rear	0.821	0.384	1.205
GPRS 1900	Front	0.398	0.023	0.421

Simultaneous Transmission Summation with Bluetooth (1.0 cm)

Band	configuration	Scaled SAR(W/kg)	BT SAR (W/kg)	Σ 1-g SAR (W/kg)
GSM 850	Rear	0.399	0.190	0.589
GSM 850	Front	0.283	0.190	0.473
GSM 1900	Rear	0.479	0.190	0.669
GSM 1900	Front	0.200	0.190	0.390
WCDMA 850	Rear	0.521	0.190	0.711
WCDMA 850	Front	0.380	0.190	0.570
WCDMA 1900	Rear	0.492	0.190	0.682
WCDMA 1900	Front	0.240	0.190	0.430
GPRS 850	Rear	0.594	0.190	0.784
GPRS 850	Front	0.435	0.190	0.625
GPRS 1900	Rear	0.821	0.190	1.011
GPRS 1900	Front	0.398	0.190	0.588

Note;

- **Body-Worn SAR** : Although body-worn accessory conditions are typically for voice configurations, the GPRS slot frame averaged output power was more conservative and was included for the body-worn accessory SAR assessment.

15.3 Simultaneous Transmission Summation for Hotspot

Simultaneous Transmission Summation for Hotspot (1 cm)

Band	configuration	Scaled SAR(W/kg)	2.4 GHz WIFI Scaled SAR (W/kg)	Σ 1-g SAR (W/kg)
GPRS 850	Rear	0.594	0.262	0.856
	Front	0.435	0.101	0.536
	Left	0.295		0.295
	Right	0.452	0.173	0.561
	Bottom	0.161		0.161
	Top		0.109	0.109
GPRS 1 900	Rear	0.821	0.262	1.083
	Front	0.398	0.101	0.499
	Left	0.159		0.159
	Right	0.162	0.173	0.335
	Bottom	0.812		0.812
	Top		0.109	0.109
WCDMA 850	Rear	0.521	0.262	0.783
	Front	0.380	0.101	0.481
	Left	0.240		0.240
	Right	0.405	0.173	0.578
	Bottom	0.141		0.141
	Top		0.109	0.109
WCDMA 1900	Rear	0.492	0.262	0.754
	Front	0.240	0.101	0.341
	Left	0.086		0.086
	Right	0.095	0.173	0.268
	Bottom	0.534		0.534
	Top		0.109	0.109

16. CONCLUSION

The SAR measurement indicates that the EUT complies with the RF radiation exposure limits of the ANSI/IEEE C95.1 1992.

These measurements are taken to simulate the RF effects exposure under worst-case conditions. Precise laboratory measures were taken to assure repeatability of the tests.

17. REFERENCES

- [1] Federal Communications Commission, OET Bulletin 65 (Edition 97-01), Supplement C (Edition 01-01), Evaluating Compliance with FCC Guidelines for Human Exposure to Radio frequency Electromagnetic Fields, July 2001.
- [2] IEEE Standards Coordinating Committee 34 – IEEE Std. 1528-2003, IEEE Recommended Practice for Determining the Peak Spatial-Average Specific Absorption Rate (SAR) in the Human Body from Wireless Communications Devices.
- [3] Federal Communications Commission, ET Docket 93-62, Guidelines for Evaluating the Environmental Effects of Radio frequency Radiation, Aug. 1996.
- [4] ANSI/IEEE C95.1 - 1991, American National Standard safety levels with respect to human exposure to radio frequency electromagnetic fields, 300 kHz to 100 GHz, New York: IEEE, Aug. 1992
- [5] ANSI/IEEE C95.3 - 1991, IEEE Recommended Practice for the Measurement of Potentially Hazardous Electromagnetic Fields - RF and Microwave, New York: IEEE, 1992.
- [6] NCRP, National Council on Radiation Protection and Measurements, Biological Effects and Exposure Criteria for Radio Frequency Electromagnetic Fields, NCRP Report No. 86, 1986. Reprinted Feb. 1995.
- [7] T. Schmid, O. Egger, N. Kuster, Automated E-field scanning system for dosimetric assessments, IEEE Transaction on Microwave Theory and Techniques, vol. 44, Jan. 1996, pp. 105-113.
- [8] K. Pokovic, T. Schmid, N. Kuster, Robust setup for precise calibration of E-field probes in tissue simulating liquids at mobile communications frequencies, ICECOM97, Oct. 1997, pp. 120-124.
- [9] K. Pokovic, T. Schmid, and N. Kuster, E-field Probe with improved isotropy in brain simulating liquids, Proceedings of the ELMAR, Zadar, Croatia, June 23-25, 1996, pp. 172-175.
- [10] Schmid & Partner Engineering AG, Application Note: Data Storage and Evaluation, June 1998, p2.
- [11] V. Hombach, K. Meier, M. Burkhardt, E. Kuhn, N. Kuster, The Dependence of EM Energy Absorption upon Human Head Modeling at 900 MHz, IEEE Transaction on Microwave Theory and Techniques, vol. 44 no. 10, Oct. 1996, pp. 1865-1873.
- [12] N. Kuster and Q. Balzano, Energy absorption mechanism by biological bodies in the near field of dipole antennas above 300 MHz, IEEE Transaction on Vehicular Technology, vol. 41, no. 1, Feb. 1992, pp. 17-23.
- [13] G. Hartsgrrove, A. Kraszewski, A. Surowiec, Simulated Biological Materials for Electromagnetic Radiation Absorption Studies, University of Ottawa, Bioelectro magnetics, Canada: 1987, pp. 29-36.
- [14] Q. Balzano, O. Garay, T. Manning Jr., Electromagnetic Energy Exposure of Simulated Users of Portable Cellular Telephones, IEEE Transactions on Vehicular Technology, vol. 44, no.3, Aug. 1995.
- [15] W. Gander, Computer mathematick, Birkhaeuser, Basel, 1992.
- [16] W.H. Press, S.A. Teukolsky, W.T. Vetterling, and B.P. Flannery, Numerical Recipes in C, The Art of Scientific Computing, Second edition, Cambridge University Press, 1992.
- [17] Federal Communications Commission, OET Bulletin 65, Evaluating Compliance with FCC Guidelines for Human Exposure to Radiofrequency Electromagnetic Fields. Supplement C, Dec. 1997.
- [18] N. Kuster, R. Kastle, T. Schmid, Dosimetric evaluation of mobile communications equipment with known precision, IEEE Transaction on Communications, vol. E80-B, no. 5, May 1997, pp. 645-652.
- [19] CENELEC CLC/SC111B, European Prestandard (prENV 50166-2), Human Exposure to Electromagnetic Fields High-frequency: 10 kHz-300 GHz, Jan. 1995.
- [20] Prof. Dr. Niels Kuster, ETH, Eidgenössische Technische Hochschule Zürich, Dosimetric Evaluation of the Cellular Phone.
- [21] SAR Evaluation of Handsets with Multiple Transmitters and Antennas #648474.
- [22] SAR Measurement Procedure for 802.11 a/b/g Transmitters #KDB 248227.

Attachment 1. – SAR Test Plots

Test Laboratory: HCT CO., LTD
EUT Type: Cellular/PCS GSM/GPRS/EDGE/WCDMA/HSDPA/HSUPA Phone with Bluetooth
WLAN and NFC(Felica)
Liquid Temperature: 20.2 °C
Ambient Temperature: 20.4 °C
Test Date: Jul. 22, 2013
Plot No. 1

DUT: LG-D605; Type: bar; Serial: #1

Communication System: GSM 850; Frequency: 836.6 MHz; Duty Cycle: 1:2.075
Medium parameters used (interpolated): $f = 836.6$ MHz; $\sigma = 0.921$ mho/m; $\epsilon_r = 40.4$; $\rho = 1000$ kg/m³
Phantom section: Right Section
Measurement Standard: DAS4 (High Precision Assessment)

DASY4 Configuration:

- Probe: EX3DV4 – SN3797; ConvF(8.94, 8.94, 8.94); Calibrated: 2012-11-22
- Sensor-Surface: 4mm (Mechanical Surface Detection)
- Electronics: DAE4 Sn648; Calibrated: 2013-04-24
- Phantom: 800/900 Phantom; Type: SAM;
- Measurement SW: DASY4, V4.7 Build 80;

GSM850 Right Touch GPRS 4Tx 190/Area Scan (61x101x1): Measurement grid:
dx=15mm, dy=15mm

Maximum value of SAR (interpolated) = 0.372 mW/g

GSM850 Right Touch GPRS 4Tx 190/Zoom Scan (5x5x7)/Cube 0: Measurement
grid: dx=8mm, dy=8mm, dz=5mm

Reference Value = 6.57 V/m; Power Drift = 0.063 dB

Peak SAR (extrapolated) = 0.461 W/kg

SAR(1 g) = 0.354 mW/g; SAR(10 g) = 0.258 mW/g

Maximum value of SAR (measured) = 0.373 mW/g

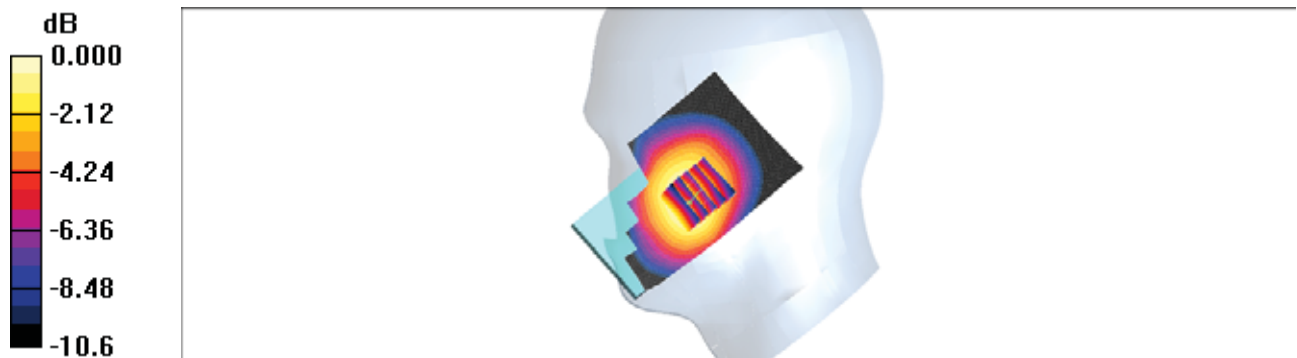

0 dB = 0.373mW/g

Test Laboratory: HCT CO., LTD
EUT Type: Cellular/PCS GSM/GPRS/EDGE/WCDMA/HSDPA/HSUPA Phone with Bluetooth
WLAN and NFC(Felica)
Liquid Temperature: 20.4 °C
Ambient Temperature: 20.6 °C
Test Date: Jul. 24, 2013
Plot No. 2

DUT: LG-D605; Type: bar; Serial: #1

Communication System: GSM 1900; Frequency: 1880 MHz; Duty Cycle: 1:2.075
Medium parameters used: $f = 1880$ MHz; $\sigma = 1.39$ mho/m; $\epsilon_r = 39.8$; $\rho = 1000$ kg/m³
Phantom section: Left Section
Measurement Standard: DAS4 (High Precision Assessment)

DASY4 Configuration:

- Probe: ET3DV6 – SN1798; ConvF(5.29, 5.29, 5.29); Calibrated: 2013-04-29
- Sensor-Surface: 4mm (Mechanical Surface Detection)
- Electronics: DAE3 Sn446; Calibrated: 2013-01-16
- Phantom: 800/900 Phantom; Type: SAM;
- Measurement SW: DASY4, V4.7 Build 80;

GSM1900 Left Touch GPRS 4Tx 661/Area Scan (61x101x1): Measurement grid:
dx=15mm, dy=15mm

Maximum value of SAR (interpolated) = 0.249 mW/g

GSM1900 Left Touch GPRS 4Tx 661/Zoom Scan (5x5x7)/Cube 0: Measurement grid: dx=8mm, dy=8mm, dz=5mm

Reference Value = 6.66 V/m; Power Drift = 0.153 dB

Peak SAR (extrapolated) = 0.287 W/kg

SAR(1 g) = 0.209 mW/g; SAR(10 g) = 0.132 mW/g

Maximum value of SAR (measured) = 0.230 mW/g

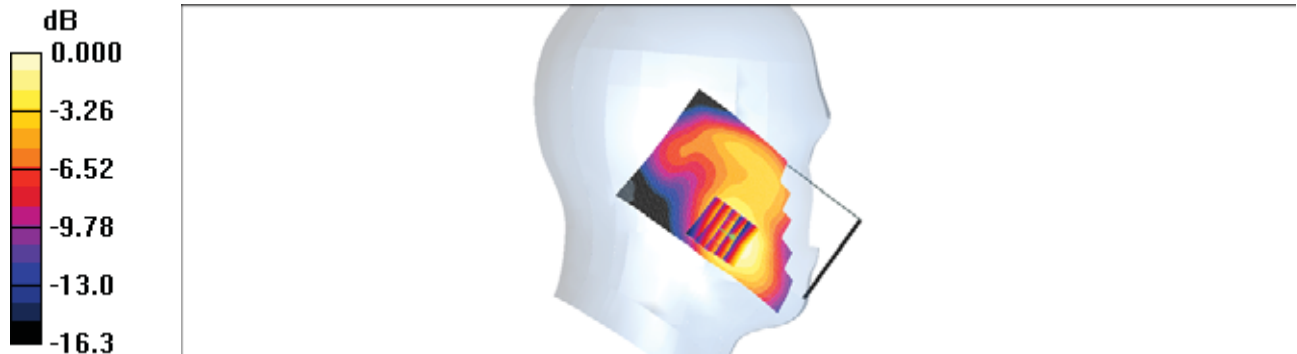

0 dB = 0.230mW/g

Test Laboratory: HCT CO., LTD
EUT Type: Cellular/PCS GSM/GPRS/EDGE/WCDMA/HSDPA/HSUPA Phone with Bluetooth
WLAN and NFC(Felica)
Liquid Temperature: 20.2 °C
Ambient Temperature: 20.4 °C
Test Date: Jul. 22, 2013
Plot No. 3

DUT: LG-D605; Type: bar; Serial: #1

Communication System: WCDMA850; Frequency: 836.6 MHz; Duty Cycle: 1:1
Medium parameters used (interpolated): $f = 836.6$ MHz; $\sigma = 0.921$ mho/m; $\epsilon_r = 40.4$; $\rho = 1000$ kg/m³
Phantom section: Right Section
Measurement Standard: DAS4 (High Precision Assessment)

DASY4 Configuration:

- Probe: EX3DV4 – SN3797; ConvF(8.94, 8.94, 8.94); Calibrated: 2012-11-22
- Sensor-Surface: 4mm (Mechanical Surface Detection)
- Electronics: DAE4 Sn648; Calibrated: 2013-04-24
- Phantom: 800/900 Phantom; Type: SAM;
- Measurement SW: DAS4, V4.7 Build 80;

WCDMA850 Right Touch 4183/Area Scan (61x101x1): Measurement grid: dx=15mm, dy=15mm

Maximum value of SAR (interpolated) = 0.343 mW/g

WCDMA850 Right Touch 4183/Zoom Scan (5x5x7)/Cube 0: Measurement grid: dx=8mm, dy=8mm, dz=5mm

Reference Value = 6.40 V/m; Power Drift = -0.087 dB

Peak SAR (extrapolated) = 0.418 W/kg

SAR(1 g) = 0.325 mW/g; SAR(10 g) = 0.239 mW/g

Maximum value of SAR (measured) = 0.341 mW/g

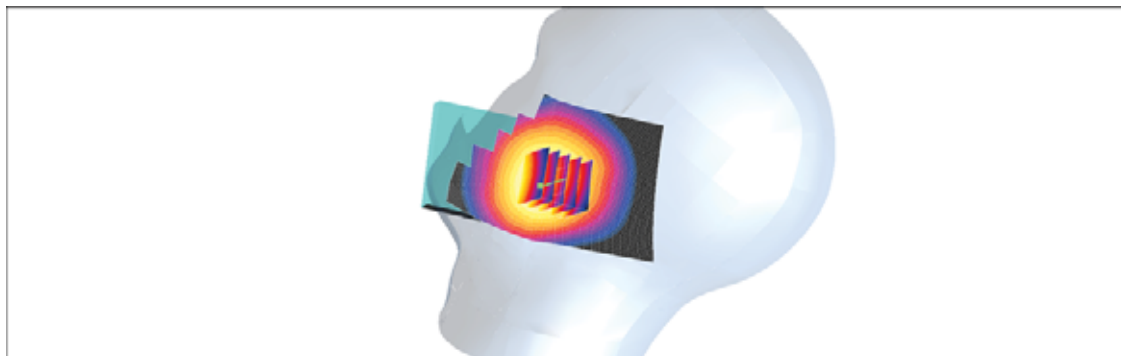
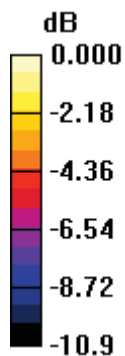

0 dB = 0.341mW/g

Test Laboratory: HCT CO., LTD
EUT Type: Cellular/PCS GSM/GPRS/EDGE/WCDMA/HSDPA/HSUPA Phone with Bluetooth
WLAN and NFC(Felica)
Liquid Temperature: 20.4 °C
Ambient Temperature: 20.6 °C
Test Date: Jul. 24, 2013
Plot No. 4

DUT: LG-D605; Type: bar; Serial: #1

Communication System: WCDMA1900; Frequency: 1880 MHz;Duty Cycle: 1:1
Medium parameters used: $f = 1880$ MHz; $\sigma = 1.39$ mho/m; $\epsilon_r = 39.8$; $\rho = 1000$ kg/m³
Phantom section: Left Section
Measurement Standard: DASYS4 (High Precision Assessment)

DASY4 Configuration:

- Probe: ET3DV6 – SN1798; ConvF(5.29, 5.29, 5.29); Calibrated: 2013-04-29
- Sensor-Surface: 4mm (Mechanical Surface Detection)
- Electronics: DAE3 Sn446; Calibrated: 2013-01-16
- Phantom: SAM 1800/1900 MHz; Type: SAM;
- Measurement SW: DASY4, V4.7 Build 80;

WCDMA1900 Left Touch 9400/Area Scan (61x101x1): Measurement grid: dx=15mm,
dy=15mm

Maximum value of SAR (interpolated) = 0.208 mW/g

WCDMA1900 Left Touch 9400/Zoom Scan (5x5x7)/Cube 0: Measurement grid:
dx=8mm, dy=8mm, dz=5mm

Reference Value = 5.24 V/m; Power Drift = 0.098 dB

Peak SAR (extrapolated) = 0.245 W/kg

SAR(1 g) = 0.180 mW/g; SAR(10 g) = 0.118 mW/g

Maximum value of SAR (measured) = 0.189 mW/g

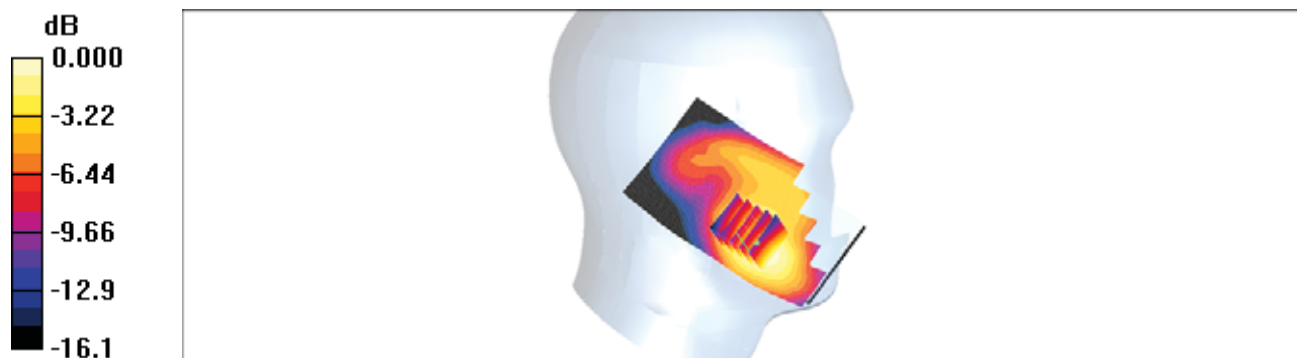

0 dB = 0.189mW/g

Test Laboratory: HCT CO., LTD
EUT Type: Cellular/PCS GSM/GPRS/EDGE/WCDMA/HSDPA/HSUPA Phone with Bluetooth
WLAN and NFC(Felica)
Liquid Temperature: 20.5 °C
Ambient Temperature: 20.7 °C
Test Date: Jul. 26, 2013
Plot No. 5

DUT: LG-D605; Type: bar; Serial: #1

Communication System: 2450MHz FCC; Frequency: 2462 MHz;Duty Cycle: 1:1
Medium parameters used (interpolated): $f = 2462$ MHz; $\sigma = 1.85$ mho/m; $\epsilon_r = 37.7$; $\rho = 1000$ kg/m³
Phantom section: Left Section
Measurement Standard: DASy4 (High Precision Assessment)

DASy4 Configuration:

- Probe: EX3DV4 – SN3903; ConvF(7.43, 7.43, 7.43); Calibrated: 2013-03-18
- Sensor-Surface: 4mm (Mechanical Surface Detection)
- Electronics: DAE4 Sn652; Calibrated: 2013-03-21
- Phantom: 835/900 Phantom ; Type: SAM;
- Measurement SW: DASy4, V4.7 Build 80;

802.11b Left Touch 1Mbps 11/Area Scan (81x131x1): Measurement grid: dx=12mm, dy=12mm

Maximum value of SAR (interpolated) = 0.306 mW/g

802.11b Left Touch 1Mbps 11/Zoom Scan (7x7x7)/Cube 0: Measurement grid: dx=5mm, dy=5mm, dz=5mm

Reference Value = 7.69 V/m; Power Drift = 0.135 dB

Peak SAR (extrapolated) = 0.584 W/kg

SAR(1 g) = 0.272 mW/g; SAR(10 g) = 0.132 mW/g

Maximum value of SAR (measured) = 0.307 mW/g

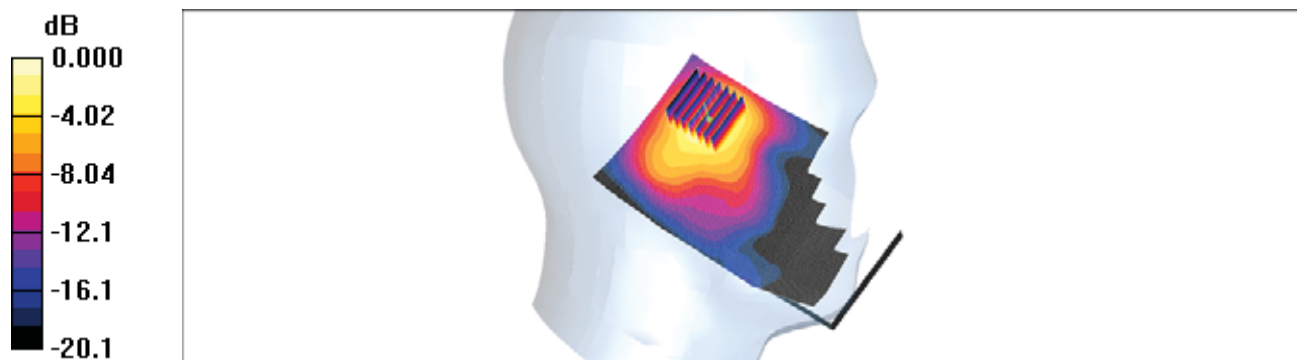

0 dB = 0.307mW/g

Test Laboratory: HCT CO., LTD
EUT Type: Cellular/PCS GSM/GPRS/EDGE/WCDMA/HSDPA/HSUPA Phone with Bluetooth
WLAN and NFC(Felica)
Liquid Temperature: 20.4 °C
Ambient Temperature: 20.6 °C
Test Date: Jul. 30, 2013
Plot No. 6

DUT: LG-D605; Type: bar; Serial: #1

Communication System: WIFI 5GHz; Frequency: 5745 MHz; Duty Cycle: 1:1
Medium parameters used (interpolated): $f = 5745$ MHz; $\sigma = 5.26$ mho/m; $\epsilon_r = 34.7$; $\rho = 1000$ kg/m³
Phantom section: Left Section
Measurement Standard: DAS4 (High Precision Assessment)

DASY4 Configuration:

- Probe: EX3DV4 – SN3903; ConvF(4.14, 4.14, 4.14); Calibrated: 2013-03-18
- Sensor-Surface: 2.5mm (Mechanical Surface Detection) Sensor-Surface: 2mm (Mechanical Surface Detection)
- Electronics: DAE4 Sn652; Calibrated: 2013-03-21
- Phantom: 1800/1900 Phantom; Type: SAM;
- Measurement SW: DAS4, V4.7 Build 80;

802.11a Left touch 149ch 6Mbps/Area Scan (91x161x1): Measurement grid:
dx=10mm, dy=10mm

Maximum value of SAR (interpolated) = 0.084 mW/g

802.11a Left touch 149ch 6Mbps/Zoom Scan (7x7x11)/Cube 0: Measurement grid:
dx=4mm, dy=4mm, dz=2mm

Reference Value = 2.52 V/m; Power Drift = -0.181 dB

Peak SAR (extrapolated) = 0.125 W/kg

SAR(1 g) = 0.039 mW/g; SAR(10 g) = 0.022 mW/g

Maximum value of SAR (measured) = 0.066 mW/g

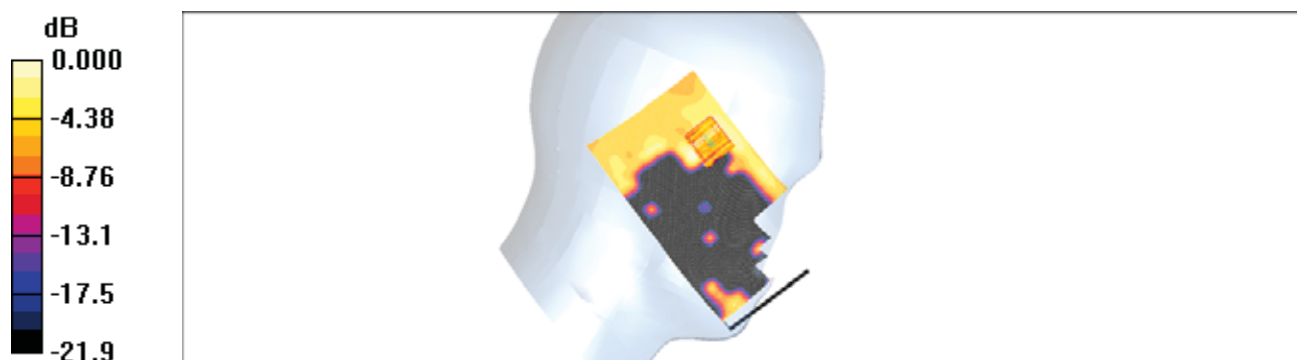

0 dB = 0.066mW/g

Test Laboratory: HCT CO., LTD
EUT Type: Cellular/PCS GSM/GPRS/EDGE/WCDMA/HSDPA/HSUPA Phone with Bluetooth
WLAN and NFC(Felica)
Liquid Temperature: 20.7 °C
Ambient Temperature: 20.9 °C
Test Date: Jul. 29, 2013
Plot No. 7

DUT: LG-D605; Type: bar; Serial: #1

Communication System: WIFI 5GHz; Frequency: 5300 MHz; Duty Cycle: 1:1
Medium parameters used: $f = 5300$ MHz; $\sigma = 4.68$ mho/m; $\epsilon_r = 35.9$; $\rho = 1000$ kg/m³
Phantom section: Left Section
Measurement Standard: DAS4 (High Precision Assessment)

DASY4 Configuration:

- Probe: EX3DV4 – SN3903; ConvF(4.6, 4.6, 4.6); Calibrated: 2013-03-18
- Sensor-Surface: 2.5mm (Mechanical Surface Detection) Sensor-Surface: 2mm (Mechanical Surface Detection)
- Electronics: DAE4 Sn652; Calibrated: 2013-03-21
- Phantom: 1800/1900 Phantom; Type: SAM;
- Measurement SW: DAS4, V4.7 Build 80;

802.11a Left touch 60ch 6Mbps/Area Scan (91x151x1): Measurement grid: dx=10mm, dy=10mm

Maximum value of SAR (interpolated) = 0.099 mW/g

802.11a Left touch 60ch 6Mbps/Zoom Scan (7x7x11)/Cube 0: Measurement grid: dx=4mm, dy=4mm, dz=2mm

Reference Value = 2.15 V/m; Power Drift = -0.108 dB

Peak SAR (extrapolated) = 0.297 W/kg

SAR(1 g) = 0.062 mW/g; SAR(10 g) = 0.031 mW/g

Maximum value of SAR (measured) = 0.111 mW/g



0 dB = 0.111mW/g

Test Laboratory: HCT CO., LTD
EUT Type: Cellular/PCS GSM/GPRS/EDGE/WCDMA/HSDPA/HSUPA Phone with Bluetooth
WLAN and NFC(Felica)
Liquid Temperature: 20.3 °C
Ambient Temperature: 20.5 °C
Test Date: Jul. 23, 2013
Plot No. 8

DUT: LG-D605; Type: bar; Serial: #1

Communication System: GSM 850; Frequency: 836.6 MHz; Duty Cycle: 1:2.075
Medium parameters used (interpolated): $f = 836.6$ MHz; $\sigma = 0.981$ mho/m; $\epsilon_r = 56.8$; $\rho = 1000$ kg/m³
Phantom section: Center Section
Measurement Standard: DAS4 (High Precision Assessment)

DASY4 Configuration:

- Probe: EX3DV4 – SN3797; ConvF(8.98, 8.98, 8.98); Calibrated: 2012-11-22
- Sensor-Surface: 4mm (Mechanical Surface Detection)
- Electronics: DAE4 Sn648; Calibrated: 2013-04-24
- Phantom: Triple Flat Phantom 5.1C_20120905; Type: QD 000 P51 CA;
- Measurement SW: DAS4, V4.7 Build 80;

GSM850 Body Rear GPRS 4Tx 190/Area Scan (61x101x1): Measurement grid:
dx=15mm, dy=15mm

Maximum value of SAR (interpolated) = 0.542 mW/g

GSM850 Body Rear GPRS 4Tx 190/Zoom Scan (5x5x7)/Cube 0: Measurement grid:
dx=8mm, dy=8mm, dz=5mm

Reference Value = 17.3 V/m; Power Drift = -0.174 dB

Peak SAR (extrapolated) = 0.637 W/kg

SAR(1 g) = 0.506 mW/g; SAR(10 g) = 0.382 mW/g

Maximum value of SAR (measured) = 0.526 mW/g

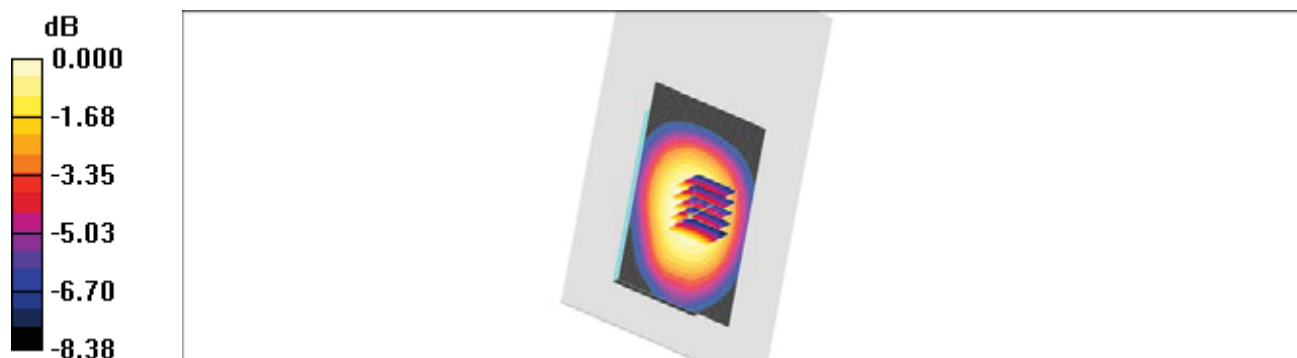

0 dB = 0.526mW/g

Test Laboratory: HCT CO., LTD
EUT Type: Cellular/PCS GSM/GPRS/EDGE/WCDMA/HSDPA/HSUPA Phone with Bluetooth
WLAN and NFC(Felica)
Liquid Temperature: 20.1 °C
Ambient Temperature: 20.3 °C
Test Date: Jul. 25, 2013
Plot No. 9

DUT: LG-D605; Type: bar; Serial: #1

Communication System: GSM 1900; Frequency: 1880 MHz; Duty Cycle: 1:2.075
Medium parameters used: $f = 1880$ MHz; $\sigma = 1.47$ mho/m; $\epsilon_r = 53.6$; $\rho = 1000$ kg/m³
Phantom section: Center Section
Measurement Standard: DAS4 (High Precision Assessment)

DASY4 Configuration:

- Probe: ET3DV6 – SN1798; ConvF(4.7, 4.7, 4.7); Calibrated: 2013-04-29
- Sensor-Surface: 4mm (Mechanical Surface Detection)
- Electronics: DAE3 Sn446; Calibrated: 2013-01-16
- Phantom: Triple Flat Phantom 5.1C_20120905; Type: QD 000 P51 CA;
- Measurement SW: DAS4, V4.7 Build 80;

GSM1900 Body Rear GPRS 4Tx 661/Area Scan (61x111x1): Measurement grid:
dx=15mm, dy=15mm

Maximum value of SAR (interpolated) = 0.750 mW/g

GSM1900 Body Rear GPRS 4Tx 661/Zoom Scan (5x5x7)/Cube 0: Measurement grid: dx=8mm, dy=8mm, dz=5mm

Reference Value = 9.54 V/m; Power Drift = -0.130 dB

Peak SAR (extrapolated) = 1.01 W/kg

SAR(1 g) = 0.678 mW/g; SAR(10 g) = 0.396 mW/g

Maximum value of SAR (measured) = 0.751 mW/g

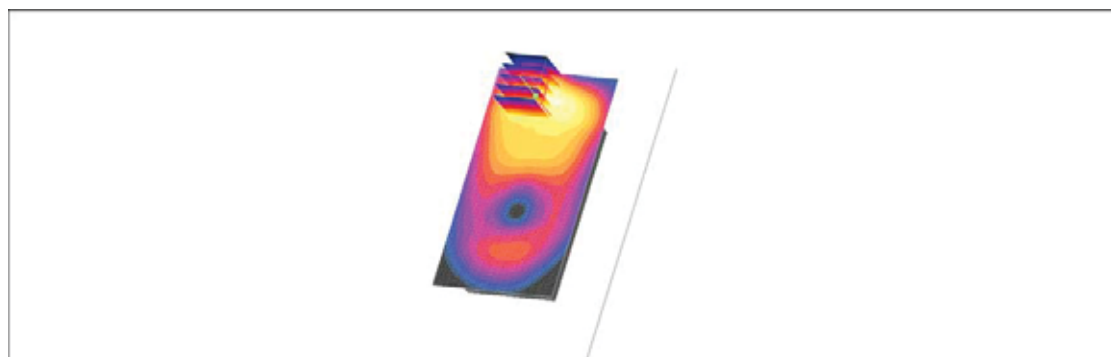
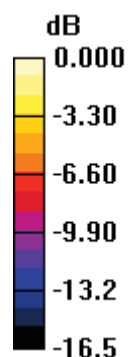

0 dB = 0.751 mW/g

Test Laboratory: HCT CO., LTD
EUT Type: Cellular/PCS GSM/GPRS/EDGE/WCDMA/HSDPA/HSUPA Phone with Bluetooth
WLAN and NFC(Felica)
Liquid Temperature: 20.3 °C
Ambient Temperature: 20.5 °C
Test Date: Jul. 23, 2013
Plot No. 10

DUT: LG-D605; Type: bar; Serial: #1

Communication System: WCDMA850; Frequency: 836.6 MHz; Duty Cycle: 1:1
Medium parameters used (interpolated): $f = 836.6$ MHz; $\sigma = 0.981$ mho/m; $\epsilon_r = 56.8$; $\rho = 1000$ kg/m³
Phantom section: Center Section
Measurement Standard: DAS4 (High Precision Assessment)

DASY4 Configuration:

- Probe: EX3DV4 – SN3797; ConvF(8.98, 8.98, 8.98); Calibrated: 2012-11-22
- Sensor-Surface: 4mm (Mechanical Surface Detection)
- Electronics: DAE4 Sn648; Calibrated: 2013-04-24
- Phantom: Triple Flat Phantom 5.1C_20120905; Type: QD 000 P51 CA;
- Measurement SW: DAS4, V4.7 Build 80;

WCDMA850 Body Rear 4183/Area Scan (61x101x1): Measurement grid: dx=15mm, dy=15mm

Maximum value of SAR (interpolated) = 0.524 mW/g

WCDMA850 Body Rear 4183/Zoom Scan (5x5x7)/Cube 0: Measurement grid: dx=8mm, dy=8mm, dz=5mm

Reference Value = 17.7 V/m; Power Drift = 0.005 dB

Peak SAR (extrapolated) = 0.635 W/kg

SAR(1 g) = 0.501 mW/g; SAR(10 g) = 0.379 mW/g

Maximum value of SAR (measured) = 0.523 mW/g

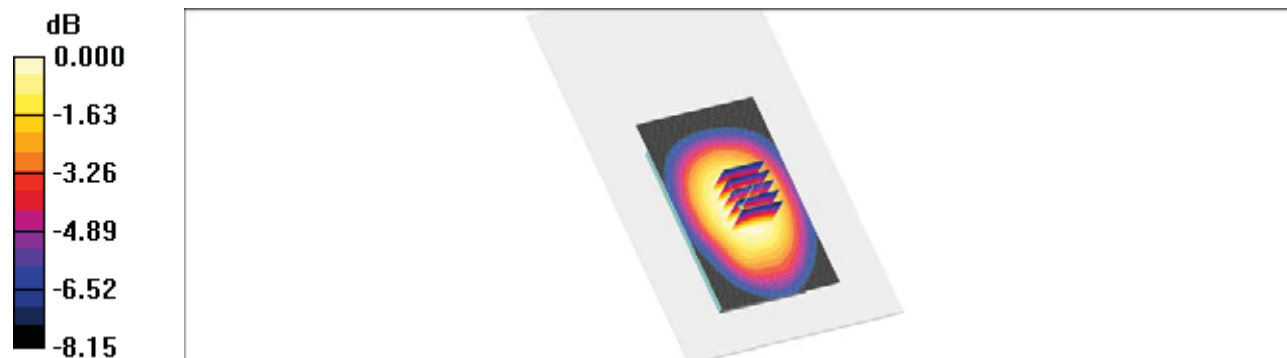

0 dB = 0.523mW/g

Test Laboratory: HCT CO., LTD
EUT Type: Cellular/PCS GSM/GPRS/EDGE/WCDMA/HSDPA/HSUPA Phone with Bluetooth
WLAN and NFC(Felica)
Liquid Temperature: 20.1 °C
Ambient Temperature: 20.3 °C
Test Date: Jul. 25, 2013
Plot No. 11

DUT: LG-D605; Type: bar; Serial: #1

Communication System: WCDMA1900; Frequency: 1880 MHz; Duty Cycle: 1:1
Medium parameters used: $f = 1880$ MHz; $\sigma = 1.47$ mho/m; $\epsilon_r = 53.6$; $\rho = 1000$ kg/m³
Phantom section: Center Section
Measurement Standard: DAS4 (High Precision Assessment)

DASY4 Configuration:

- Probe: ET3DV6 – SN1798; ConvF(4.7, 4.7, 4.7); Calibrated: 2013-04-29
- Sensor-Surface: 4mm (Mechanical Surface Detection)
- Electronics: DAE3 Sn446; Calibrated: 2013-01-16
- Phantom: Triple Flat Phantom 5.1C_20120905; Type: QD 000 P51 CA;
- Measurement SW: DAS4, V4.7 Build 80;

WCDMA1900 Body Bottom 9400/Area Scan (61x41x1): Measurement grid: dx=15mm, dy=15mm

Maximum value of SAR (interpolated) = 0.597 mW/g

WCDMA1900 Body Bottom 9400/Zoom Scan (5x5x7)/Cube 0: Measurement grid: dx=8mm, dy=8mm, dz=5mm

Reference Value = 17.7 V/m; Power Drift = -0.082 dB

Peak SAR (extrapolated) = 0.773 W/kg

SAR(1 g) = 0.519 mW/g; SAR(10 g) = 0.301 mW/g

Maximum value of SAR (measured) = 0.583 mW/g

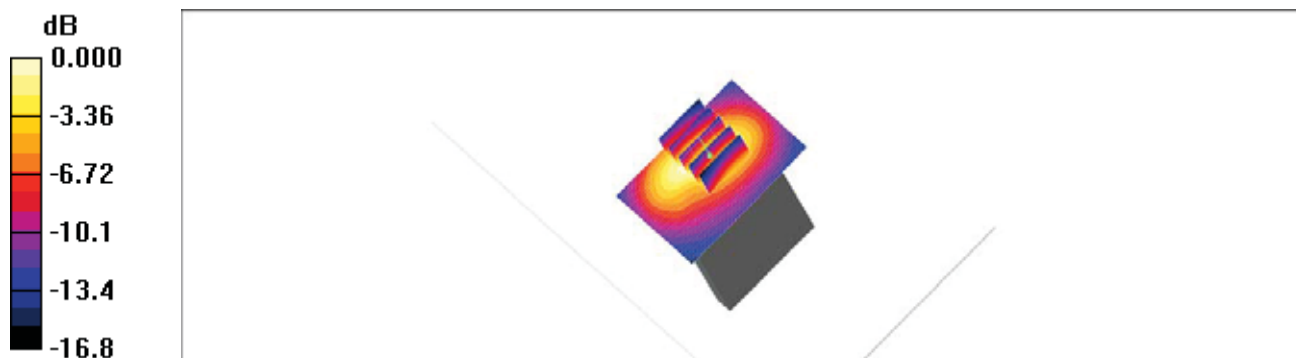

0 dB = 0.583mW/g

Test Laboratory: HCT CO., LTD
EUT Type: Cellular/PCS GSM/GPRS/EDGE/WCDMA/HSDPA/HSUPA Phone with Bluetooth
WLAN and NFC(Felica)
Liquid Temperature: 20.6 °C
Ambient Temperature: 20.8 °C
Test Date: Jul. 27, 2013
Plot No. 12

DUT: LG-D605; Type: bar; Serial: #1

Communication System: 2450MHz FCC; Frequency: 2462 MHz;Duty Cycle: 1:1
Medium parameters used (interpolated): $f = 2462$ MHz; $\sigma = 2$ mho/m; $\epsilon_r = 53.4$; $\rho = 1000$ kg/m³
Phantom section: Center Section
Measurement Standard: DASy4 (High Precision Assessment)

DASy4 Configuration:

- Probe: EX3DV4 – SN3797; ConvF(6.98, 6.98, 6.98); Calibrated: 2012-11-22
- Sensor-Surface: 4mm (Mechanical Surface Detection)
- Electronics: DAE4 Sn648; Calibrated: 2013-04-24
- Phantom: Triple Flat Phantom 5.1C_20120905; Type: QD 000 P51 CA;
- Measurement SW: DASy4, V4.7 Build 80;

802.11b Body Rear 1Mbps 11ch/Area Scan (81x131x1): Measurement grid: dx=12mm, dy=12mm

Maximum value of SAR (interpolated) = 0.190 mW/g

802.11b Body Rear 1Mbps 11ch/Zoom Scan (7x7x7)/Cube 0: Measurement grid: dx=5mm, dy=5mm, dz=5mm

Reference Value = 5.47 V/m; Power Drift = 0.004 dB

Peak SAR (extrapolated) = 0.309 W/kg

SAR(1 g) = 0.161 mW/g; SAR(10 g) = 0.082 mW/g

Maximum value of SAR (measured) = 0.185 mW/g

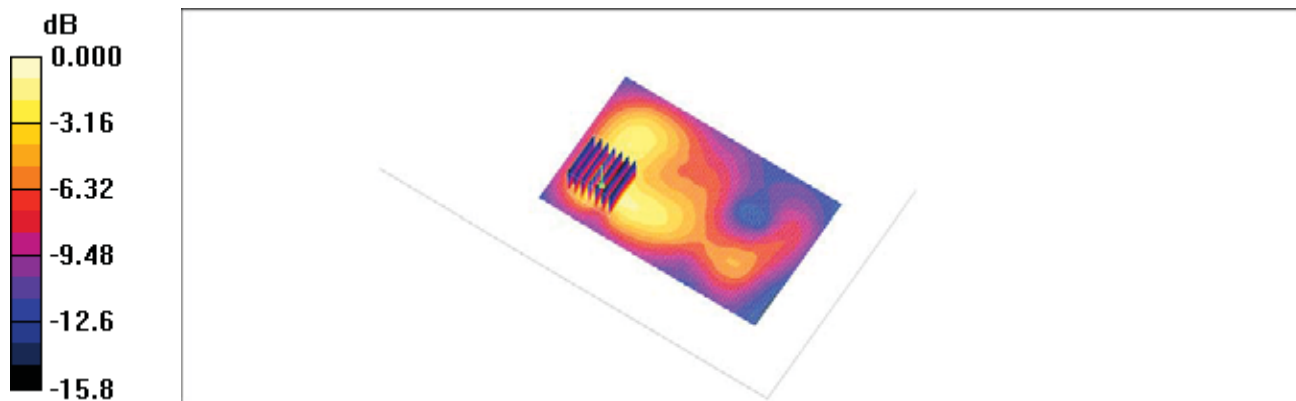

0 dB = 0.185mW/g

Test Laboratory: HCT CO., LTD
EUT Type: Cellular/PCS GSM/GPRS/EDGE/WCDMA/HSDPA/HSUPA Phone with Bluetooth
WLAN and NFC(Felica)
Liquid Temperature: 20.4 °C
Ambient Temperature: 20.6 °C
Test Date: Jul. 30, 2013
Plot No. 13

DUT: LG-D605; Type: bar; Serial: #1

Communication System: WIFI 5GHz; Frequency: 5745 MHz; Duty Cycle: 1:1
Medium parameters used (interpolated): $f = 5745$ MHz; $\sigma = 6.06$ mho/m; $\epsilon_r = 46.5$; $\rho = 1000$ kg/m³
Phantom section: Center Section
Measurement Standard: DASy4 (High Precision Assessment)

DASy4 Configuration:

- Probe: EX3DV4 – SN3903; ConvF(4.01, 4.01, 4.01); Calibrated: 2013-03-18
- Sensor-Surface: 2.5mm (Mechanical Surface Detection) Sensor-Surface: 2mm (Mechanical Surface Detection)
- Electronics: DAE4 Sn652; Calibrated: 2013-03-21
- Phantom: Triple Flat Phantom 5.1C; Type: QD 000 P51 CA;
- Measurement SW: DASy4, V4.7 Build 80;

802.11a Body rear 149ch 6Mbps/Area Scan (101x151x1): Measurement grid:
dx=10mm, dy=10mm

Maximum value of SAR (interpolated) = 0.304 mW/g

802.11a Body rear 149ch 6Mbps/Zoom Scan (7x7x11)/Cube 0: Measurement grid:
dx=4mm, dy=4mm, dz=2mm
Reference Value = 1.78 V/m; Power Drift = 0.162 dB
Peak SAR (extrapolated) = 0.775 W/kg
SAR(1 g) = 0.184 mW/g; SAR(10 g) = 0.069 mW/g

Maximum value of SAR (measured) = 0.346 mW/g

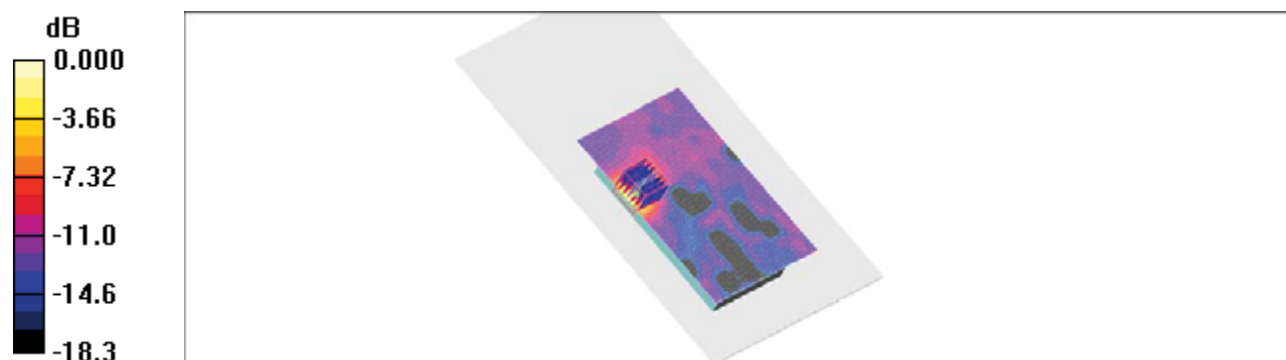

0 dB = 0.346mW/g

Test Laboratory: HCT CO., LTD
EUT Type: Cellular/PCS GSM/GPRS/EDGE/WCDMA/HSDPA/HSUPA Phone with Bluetooth
WLAN and NFC(Felica)
Liquid Temperature: 20.7 °C
Ambient Temperature: 20.9 °C
Test Date: Jul. 29, 2013
Plot No. 14

DUT: LG-D605; Type: bar; Serial: #1

Communication System: WIFI 5GHz; Frequency: 5300 MHz; Duty Cycle: 1:1
Medium parameters used: $f = 5300$ MHz; $\sigma = 5.34$ mho/m; $\epsilon_r = 47.4$; $\rho = 1000$ kg/m³
Phantom section: Center Section
Measurement Standard: DAS4 (High Precision Assessment)

DASY4 Configuration:

- Probe: EX3DV4 – SN3903; ConvF(4.24, 4.24, 4.24); Calibrated: 2013-03-18
- Sensor-Surface: 2.5mm (Mechanical Surface Detection) Sensor-Surface: 2mm (Mechanical Surface Detection)
- Electronics: DAE4 Sn652; Calibrated: 2013-03-21
- Phantom: Triple Flat Phantom 5.1C; Type: QD 000 P51 CA;
- Measurement SW: DASY4, V4.7 Build 80;

802.11a Body rear 60ch 6Mbps/Area Scan (101x151x1): Measurement grid: dx=10mm, dy=10mm
Maximum value of SAR (interpolated) = 0.558 mW/g

802.11a Body rear 60ch 6Mbps/Zoom Scan (7x7x11)/Cube 0: Measurement grid: dx=4mm, dy=4mm, dz=2mm
Reference Value = 1.50 V/m; Power Drift = -0.135 dB
Peak SAR (extrapolated) = 1.36 W/kg
SAR(1 g) = 0.340 mW/g; SAR(10 g) = 0.113 mW/g

Maximum value of SAR (measured) = 0.652 mW/g

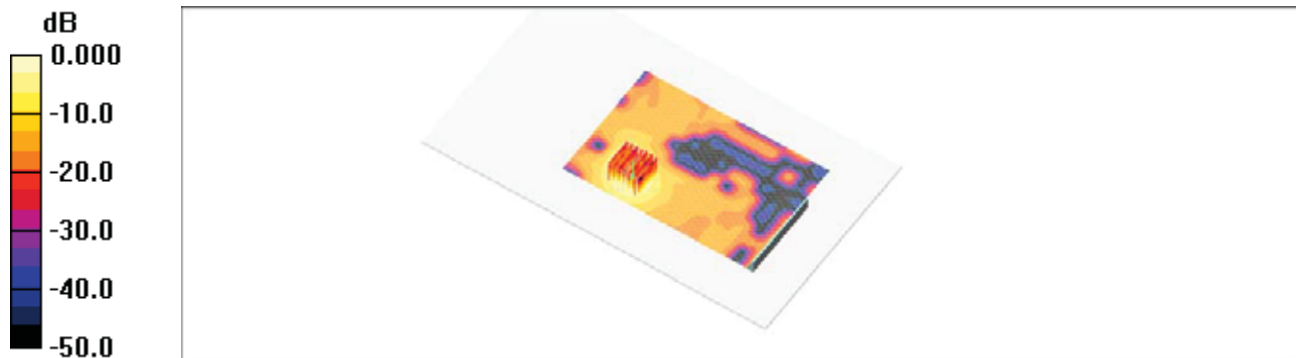

0 dB = 0.652mW/g

Test Laboratory: HCT CO., LTD
EUT Type: Cellular/PCS GSM/GPRS/EDGE/WCDMA/HSDPA/HSUPA Phone with Bluetooth
WLAN and NFC(Felica)
Liquid Temperature: 20.3 °C
Ambient Temperature: 20.5 °C
Test Date: Jul. 23, 2013
Plot No. 15

DUT: LG-D605; Type: bar; Serial: #1

Communication System: GSM 850; Frequency: 836.6 MHz; Duty Cycle: 1:8.3
Medium parameters used (interpolated): $f = 836.6$ MHz; $\sigma = 0.981$ mho/m; $\epsilon_r = 56.8$; $\rho = 1000$ kg/m³
Phantom section: Center Section
Measurement Standard: DAS4 (High Precision Assessment)

DASY4 Configuration:

- Probe: EX3DV4 – SN3797; ConvF(8.98, 8.98, 8.98); Calibrated: 2012-11-22
- Sensor-Surface: 4mm (Mechanical Surface Detection)
- Electronics: DAE4 Sn648; Calibrated: 2013-04-24
- Phantom: Triple Flat Phantom 5.1C_20120905; Type: QD 000 P51 CA;
- Measurement SW: DAS4, V4.7 Build 80;

GSM850 Body-worn Rear 190/Area Scan (61x101x1): Measurement grid: dx=15mm, dy=15mm

Maximum value of SAR (interpolated) = 0.384 mW/g

GSM850 Body-worn Rear 190/Zoom Scan (5x5x7)/Cube 0: Measurement grid: dx=8mm, dy=8mm, dz=5mm

Reference Value = 15.3 V/m; Power Drift = 0.173 dB

Peak SAR (extrapolated) = 0.464 W/kg

SAR(1 g) = 0.369 mW/g; SAR(10 g) = 0.279 mW/g

Maximum value of SAR (measured) = 0.387 mW/g

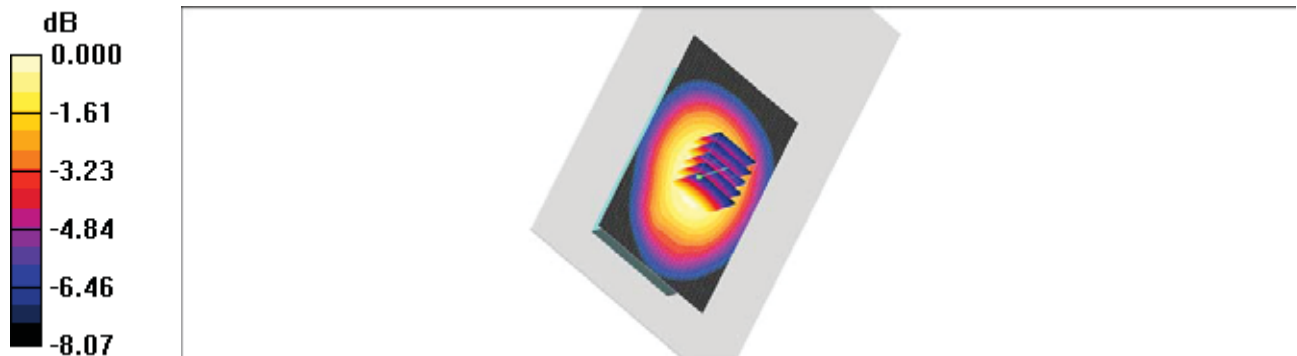

0 dB = 0.387mW/g

Test Laboratory: HCT CO., LTD
EUT Type: Cellular/PCS GSM/GPRS/EDGE/WCDMA/HSDPA/HSUPA Phone with Bluetooth
WLAN and NFC(Felica)
Liquid Temperature: 20.1 °C
Ambient Temperature: 20.3 °C
Test Date: Jul. 25, 2013
Plot No. 16

DUT: LG-D605; Type: bar; Serial: #1

Communication System: GSM 1900; Frequency: 1880 MHz; Duty Cycle: 1:8.3
Medium parameters used: $f = 1880$ MHz; $\sigma = 1.47$ mho/m; $\epsilon_r = 53.6$; $\rho = 1000$ kg/m³
Phantom section: Center Section
Measurement Standard: DASy4 (High Precision Assessment)

DASy4 Configuration:

- Probe: ET3DV6 – SN1798; ConvF(4.7, 4.7, 4.7); Calibrated: 2013-04-29
- Sensor-Surface: 4mm (Mechanical Surface Detection)
- Electronics: DAE3 Sn446; Calibrated: 2013-01-16
- Phantom: Triple Flat Phantom 5.1C_20120905; Type: QD 000 P51 CA;
- Measurement SW: DASy4, V4.7 Build 80;

GSM1900 Body-worn Rear 661/Area Scan (61x111x1): Measurement grid: dx=15mm, dy=15mm
Maximum value of SAR (interpolated) = 0.485 mW/g

GSM1900 Body-worn Rear 661/Zoom Scan (5x5x7)/Cube 0: Measurement grid:
dx=8mm, dy=8mm, dz=5mm
Reference Value = 8.19 V/m; Power Drift = -0.093 dB
Peak SAR (extrapolated) = 0.648 W/kg
SAR(1 g) = 0.428 mW/g; SAR(10 g) = 0.248 mW/g

Maximum value of SAR (measured) = 0.487 mW/g

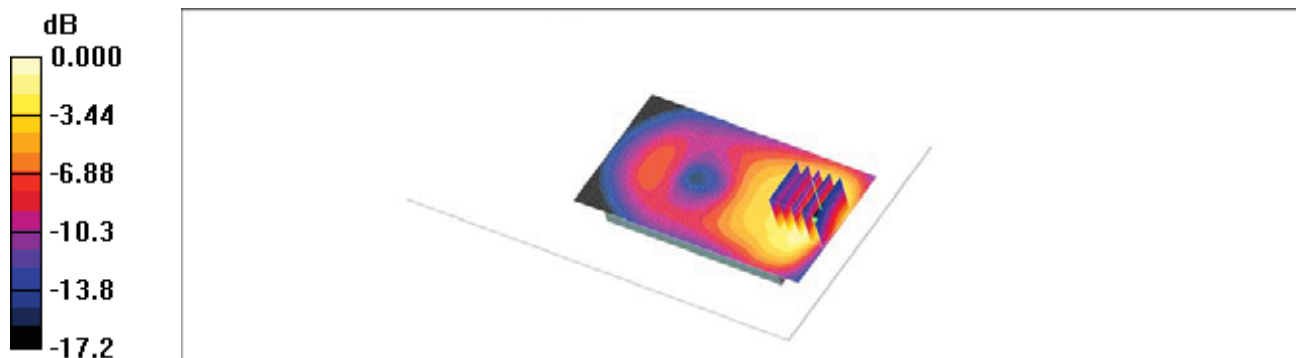

0 dB = 0.487mW/g

Test Laboratory: HCT CO., LTD
 EUT Type: Cellular/PCS GSM/GPRS/EDGE/WCDMA/HSDPA/HSUPA Phone with Bluetooth
 WLAN and NFC(Felica)
 Liquid Temperature: 20.2 °C
 Ambient Temperature: 20.4 °C
 Test Date: Jul. 22, 2013
 Plot No. 1

DUT: LG-D605; Type: bar; Serial: #1

Communication System: GSM 850; Frequency: 836.6 MHz; Duty Cycle: 1:2.075
 Medium parameters used (interpolated): $f = 836.6$ MHz; $\sigma = 0.921$ mho/m; $\epsilon_r = 40.4$; $\rho = 1000$ kg/m³
 Phantom section: Right Section
 Measurement Standard: DAS4 (High Precision Assessment)

DASY4 Configuration:

- Probe: EX3DV4 – SN3797; ConvF(8.94, 8.94, 8.94); Calibrated: 2012-11-22
- Sensor-Surface: 4mm (Mechanical Surface Detection)
- Electronics: DAE4 Sn648; Calibrated: 2013-04-24
- Phantom: 800/900 Phantom; Type: SAM;
- Measurement SW: DASY4, V4.7 Build 80;

GSM850 Right Touch GPRS 4Tx 190/Area Scan (61x101x1): Measurement grid:
 dx=15mm, dy=15mm
 Maximum value of SAR (interpolated) = 0.372 mW/g

GSM850 Right Touch GPRS 4Tx 190/Zoom Scan (5x5x7)/Cube 0: Measurement
 grid: dx=8mm, dy=8mm, dz=5mm
 Reference Value = 6.57 V/m; Power Drift = 0.063 dB
 Peak SAR (extrapolated) = 0.461 W/kg
SAR(1 g) = 0.354 mW/g; SAR(10 g) = 0.258 mW/g
 Maximum value of SAR (measured) = 0.373 mW/g

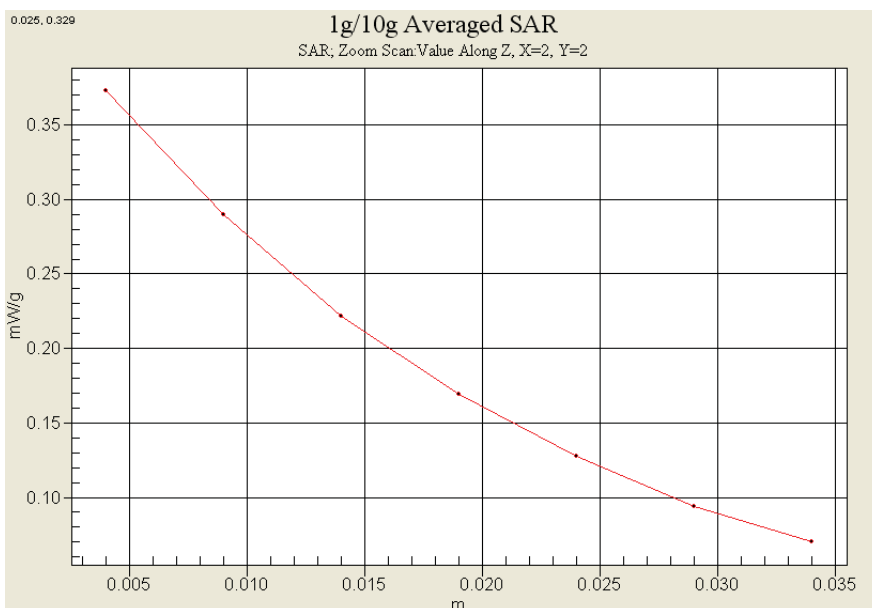

HCT CO., LTD.

Test Laboratory: HCT CO., LTD
 EUT Type: Cellular/PCS GSM/GPRS/EDGE/WCDMA/HSDPA/HSUPA Phone with Bluetooth
 WLAN and NFC(Felica)
 Liquid Temperature: 20.4 °C
 Ambient Temperature: 20.6 °C
 Test Date: Jul. 24, 2013
 Plot No. 2

DUT: LG-D605; Type: bar; Serial: #1

Communication System: GSM 1900; Frequency: 1880 MHz; Duty Cycle: 1:2.075
 Medium parameters used: $f = 1880 \text{ MHz}$; $\sigma = 1.39 \text{ mho/m}$; $\epsilon_r = 39.8$; $\rho = 1000 \text{ kg/m}^3$
 Phantom section: Left Section
 Measurement Standard: DAS4 (High Precision Assessment)

DASY4 Configuration:

- Probe: ET3DV6 – SN1798; ConvF(5.29, 5.29, 5.29); Calibrated: 2013-04-29
- Sensor-Surface: 4mm (Mechanical Surface Detection)
- Electronics: DAE3 Sn446; Calibrated: 2013-01-16
- Phantom: 800/900 Phantom; Type: SAM;
- Measurement SW: DASY4, V4.7 Build 80;

GSM1900 Left Touch GPRS 4Tx 661/Area Scan (61x101x1): Measurement grid:
 $dx=15\text{mm}$, $dy=15\text{mm}$
 Maximum value of SAR (interpolated) = 0.249 mW/g

GSM1900 Left Touch GPRS 4Tx 661/Zoom Scan (5x5x7)/Cube 0: Measurement
 grid: $dx=8\text{mm}$, $dy=8\text{mm}$, $dz=5\text{mm}$
 Reference Value = 6.66 V/m; Power Drift = 0.153 dB
 Peak SAR (extrapolated) = 0.287 W/kg
SAR(1 g) = 0.209 mW/g; SAR(10 g) = 0.132 mW/g
 Maximum value of SAR (measured) = 0.230 mW/g

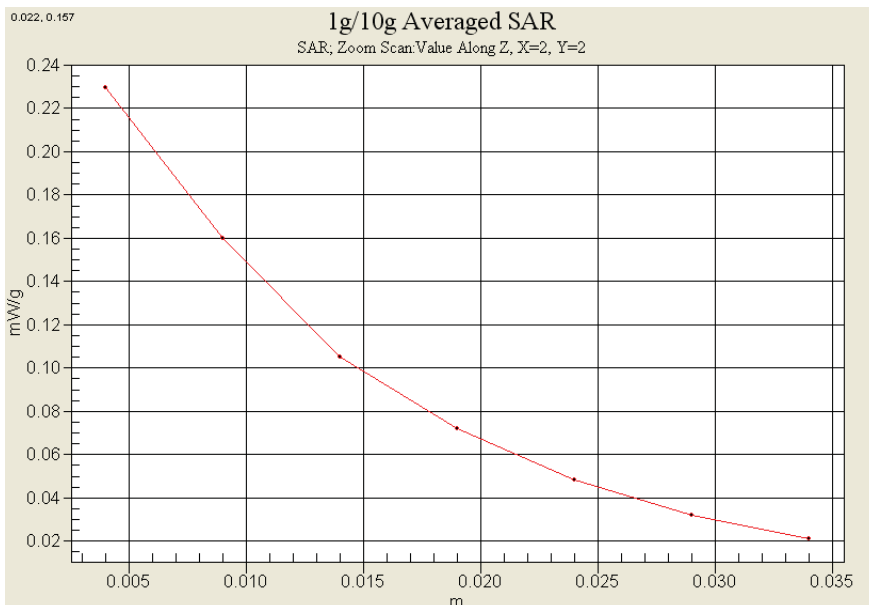

HCT CO., LTD.

Test Laboratory: HCT CO., LTD
 EUT Type: Cellular/PCS GSM/GPRS/EDGE/WCDMA/HSDPA/HSUPA Phone with Bluetooth
 WLAN and NFC(Felica)
 Liquid Temperature: 20.2 °C
 Ambient Temperature: 20.4 °C
 Test Date: Jul. 22, 2013
 Plot No. 3

DUT: LG-D605; Type: bar; Serial: #1

Communication System: WCDMA850; Frequency: 836.6 MHz; Duty Cycle: 1:1
 Medium parameters used (interpolated): $f = 836.6$ MHz; $\sigma = 0.921$ mho/m; $\epsilon_r = 40.4$; $\rho = 1000$ kg/m³
 Phantom section: Right Section
 Measurement Standard: DAS4 (High Precision Assessment)

DASY4 Configuration:

- Probe: EX3DV4 – SN3797; ConvF(8.94, 8.94, 8.94); Calibrated: 2012-11-22
- Sensor-Surface: 4mm (Mechanical Surface Detection)
- Electronics: DAE4 Sn648; Calibrated: 2013-04-24
- Phantom: 800/900 Phantom; Type: SAM;
- Measurement SW: DASY4, V4.7 Build 80;

WCDMA850 Right Touch 4183/Area Scan (61x101x1): Measurement grid: dx=15mm, dy=15mm
 Maximum value of SAR (interpolated) = 0.343 mW/g

WCDMA850 Right Touch 4183/Zoom Scan (5x5x7)/Cube 0: Measurement grid: dx=8mm, dy=8mm, dz=5mm
 Reference Value = 6.40 V/m; Power Drift = -0.087 dB
 Peak SAR (extrapolated) = 0.418 W/kg
SAR(1 g) = 0.325 mW/g; SAR(10 g) = 0.239 mW/g
 Maximum value of SAR (measured) = 0.341 mW/g

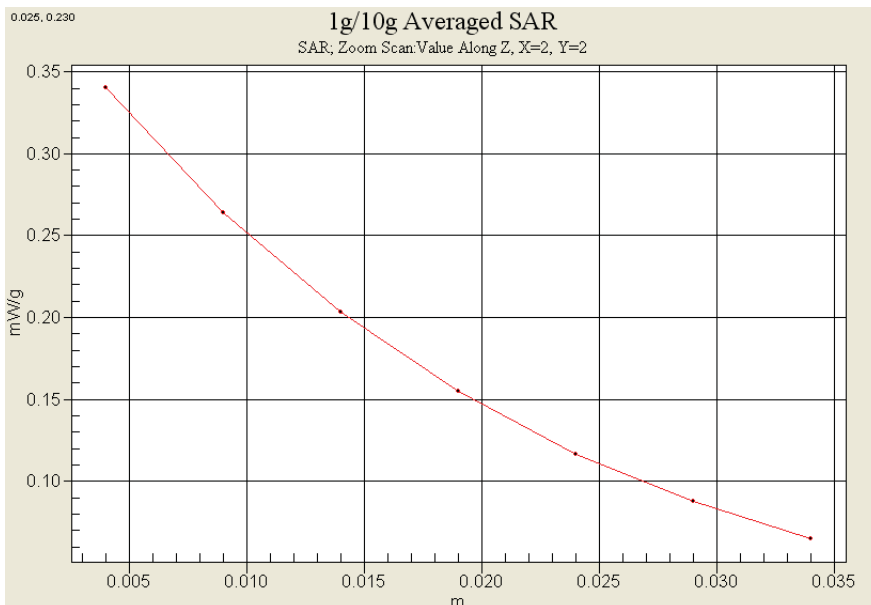

HCT CO., LTD.

Test Laboratory: HCT CO., LTD
EUT Type: Cellular/PCS GSM/GPRS/EDGE/WCDMA/HSDPA/HSUPA Phone with Bluetooth
WLAN and NFC(Felica)
Liquid Temperature: 20.4 °C
Ambient Temperature: 20.6 °C
Test Date: Jul. 24, 2013
Plot No. 4

DUT: LG-D605; Type: bar; Serial: #1

Communication System: WCDMA1900; Frequency: 1880 MHz; Duty Cycle: 1:1
Medium parameters used: $f = 1880$ MHz; $\sigma = 1.39$ mho/m; $\epsilon_r = 39.8$; $\rho = 1000$ kg/m³
Phantom section: Left Section
Measurement Standard: DAS4 (High Precision Assessment)

DASY4 Configuration:

- Probe: ET3DV6 – SN1798; ConvF(5.29, 5.29, 5.29); Calibrated: 2013-04-29
- Sensor-Surface: 4mm (Mechanical Surface Detection)
- Electronics: DAE3 Sn446; Calibrated: 2013-01-16
- Phantom: SAM 1800/1900 MHz; Type: SAM;
- Measurement SW: DASY4, V4.7 Build 80;

WCDMA1900 Left Touch 9400/Area Scan (61x101x1): Measurement grid: dx=15mm, dy=15mm
Maximum value of SAR (interpolated) = 0.208 mW/g

WCDMA1900 Left Touch 9400/Zoom Scan (5x5x7)/Cube 0: Measurement grid:
dx=8mm, dy=8mm, dz=5mm
Reference Value = 5.24 V/m; Power Drift = 0.098 dB
Peak SAR (extrapolated) = 0.245 W/kg
SAR(1 g) = 0.180 mW/g; SAR(10 g) = 0.118 mW/g
Maximum value of SAR (measured) = 0.189 mW/g

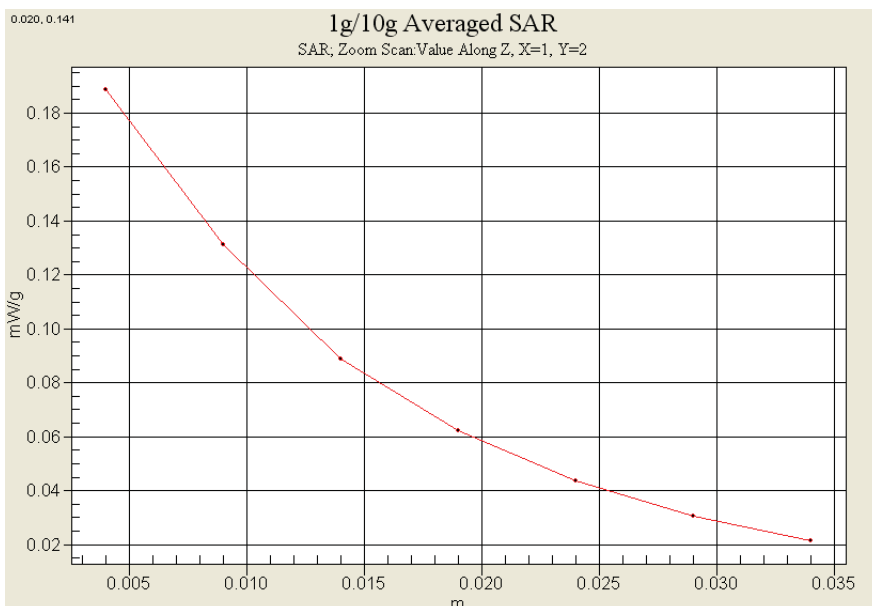

Test Laboratory: HCT CO., LTD
 EUT Type: Cellular/PCS GSM/GPRS/EDGE/WCDMA/HSDPA/HSUPA Phone with Bluetooth
 WLAN and NFC(Felica)
 Liquid Temperature: 20.5 °C
 Ambient Temperature: 20.7 °C
 Test Date: Jul. 26, 2013
 Plot No. 5

DUT: LG-D605; Type: bar; Serial: #1

Communication System: 2450MHz FCC; Frequency: 2462 MHz;Duty Cycle: 1:1
 Medium parameters used (interpolated): $f = 2462$ MHz; $\sigma = 1.85$ mho/m; $\epsilon_r = 37.7$; $\rho = 1000$ kg/m³
 Phantom section: Left Section
 Measurement Standard: DASy4 (High Precision Assessment)

DASy4 Configuration:

- Probe: EX3DV4 – SN3903; ConvF(7.43, 7.43, 7.43); Calibrated: 2013-03-18
- Sensor-Surface: 4mm (Mechanical Surface Detection)
- Electronics: DAE4 Sn652; Calibrated: 2013-03-21
- Phantom: 835/900 Phantom ; Type: SAM;
- Measurement SW: DASy4, V4.7 Build 80;

802.11b Left Touch 1Mbps 11/Area Scan (81x131x1): Measurement grid: dx=12mm, dy=12mm

Maximum value of SAR (interpolated) = 0.306 mW/g

802.11b Left Touch 1Mbps 11/Zoom Scan (7x7x7)/Cube 0: Measurement grid: dx=5mm, dy=5mm, dz=5mm

Reference Value = 7.69 V/m; Power Drift = 0.135 dB

Peak SAR (extrapolated) = 0.584 W/kg

SAR(1 g) = 0.272 mW/g; SAR(10 g) = 0.132 mW/g

Maximum value of SAR (measured) = 0.307 mW/g

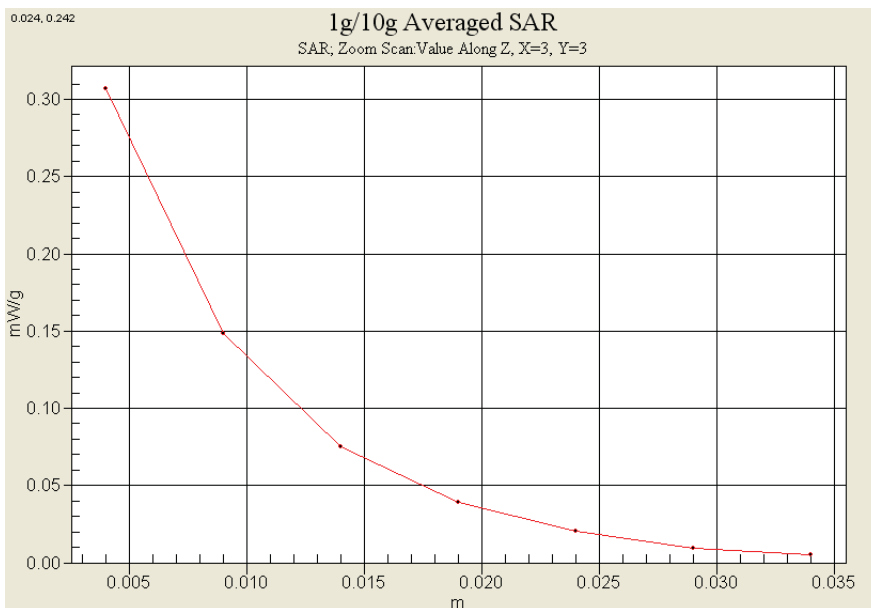

Test Laboratory: HCT CO., LTD
 EUT Type: Cellular/PCS GSM/GPRS/EDGE/WCDMA/HSDPA/HSUPA Phone with Bluetooth
 WLAN and NFC(Felica)
 Liquid Temperature: 20.4 °C
 Ambient Temperature: 20.6 °C
 Test Date: Jul. 30, 2013
 Plot No. 6

DUT: LG-D605; Type: bar; Serial: #1

Communication System: WIFI 5GHz; Frequency: 5745 MHz; Duty Cycle: 1:1
 Medium parameters used (interpolated): $f = 5745$ MHz; $\sigma = 5.26$ mho/m; $\epsilon_r = 34.7$; $\rho = 1000$ kg/m³
 Phantom section: Left Section
 Measurement Standard: DAS4 (High Precision Assessment)

DASY4 Configuration:

- Probe: EX3DV4 – SN3903; ConvF(4.14, 4.14, 4.14); Calibrated: 2013-03-18
- Sensor-Surface: 2.5mm (Mechanical Surface Detection) Sensor-Surface: 2mm (Mechanical Surface Detection)
- Electronics: DAE4 Sn652; Calibrated: 2013-03-21
- Phantom: 1800/1900 Phantom; Type: SAM;
- Measurement SW: DAS4, V4.7 Build 80;

802.11a Left touch 149ch 6Mbps/Area Scan (91x161x1): Measurement grid:
 dx=10mm, dy=10mm

Maximum value of SAR (interpolated) = 0.084 mW/g

802.11a Left touch 149ch 6Mbps/Zoom Scan (7x7x11)/Cube 0: Measurement grid:
 dx=4mm, dy=4mm, dz=2mm

Reference Value = 2.52 V/m; Power Drift = -0.181 dB

Peak SAR (extrapolated) = 0.125 W/kg

SAR(1 g) = 0.039 mW/g; SAR(10 g) = 0.022 mW/g

Maximum value of SAR (measured) = 0.066 mW/g

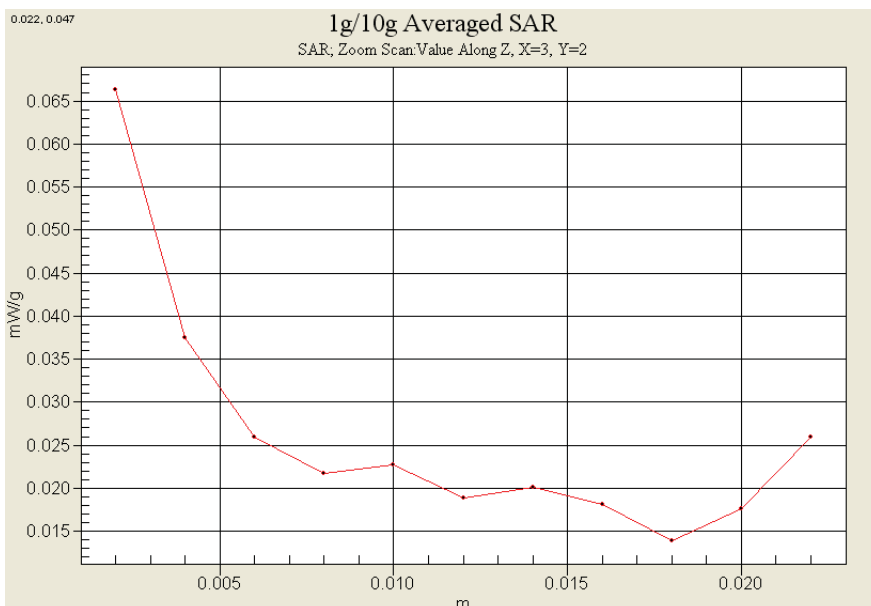

Test Laboratory: HCT CO., LTD
 EUT Type: Cellular/PCS GSM/GPRS/EDGE/WCDMA/HSDPA/HSUPA Phone with Bluetooth
 WLAN and NFC(Felica)
 Liquid Temperature: 20.7 °C
 Ambient Temperature: 20.9 °C
 Test Date: Jul. 29, 2013
 Plot No. 7

DUT: LG-D605; Type: bar; Serial: #1

Communication System: WIFI 5GHz; Frequency: 5300 MHz; Duty Cycle: 1:1
 Medium parameters used: $f = 5300 \text{ MHz}$; $\sigma = 4.68 \text{ mho/m}$; $\epsilon_r = 35.9$; $\rho = 1000 \text{ kg/m}^3$
 Phantom section: Left Section
 Measurement Standard: DAS4 (High Precision Assessment)

DASY4 Configuration:

- Probe: EX3DV4 – SN3903; ConvF(4.6, 4.6, 4.6); Calibrated: 2013-03-18
- Sensor-Surface: 2.5mm (Mechanical Surface Detection) Sensor-Surface: 2mm (Mechanical Surface Detection)
- Electronics: DAE4 Sn652; Calibrated: 2013-03-21
- Phantom: 1800/1900 Phantom; Type: SAM;
- Measurement SW: DAS4, V4.7 Build 80;

802.11a Left touch 60ch 6Mbps/Area Scan (91x151x1): Measurement grid: $dx=10\text{mm}$, $dy=10\text{mm}$

Maximum value of SAR (interpolated) = 0.099 mW/g

802.11a Left touch 60ch 6Mbps/Zoom Scan (7x7x11)/Cube 0: Measurement grid: $dx=4\text{mm}$, $dy=4\text{mm}$, $dz=2\text{mm}$

Reference Value = 2.15 V/m; Power Drift = -0.108 dB

Peak SAR (extrapolated) = 0.297 W/kg

SAR(1 g) = 0.062 mW/g; SAR(10 g) = 0.031 mW/g

Maximum value of SAR (measured) = 0.111 mW/g

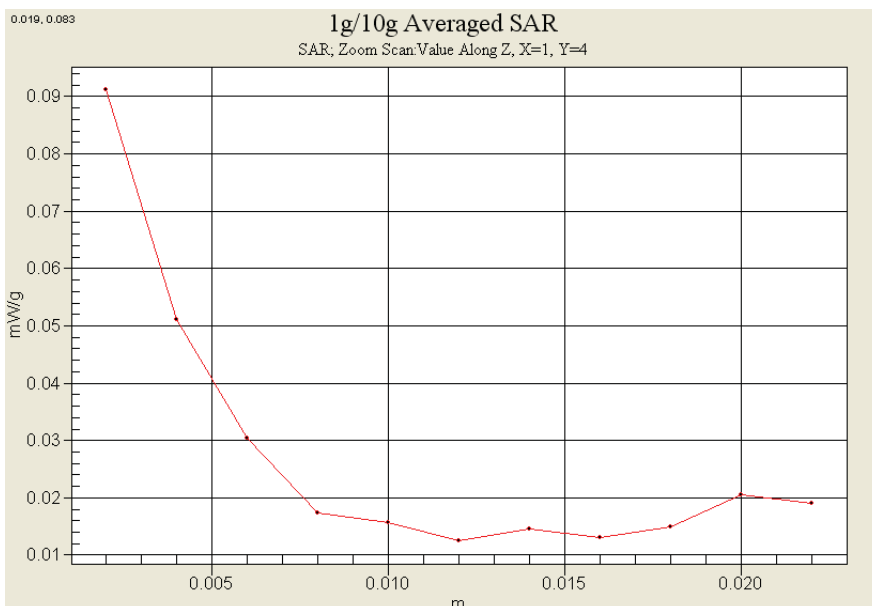

Test Laboratory: HCT CO., LTD
 EUT Type: Cellular/PCS GSM/GPRS/EDGE/WCDMA/HSDPA/HSUPA Phone with Bluetooth
 WLAN and NFC(Felica)
 Liquid Temperature: 20.3 °C
 Ambient Temperature: 20.5 °C
 Test Date: Jul. 23, 2013
 Plot No. 8

DUT: LG-D605; Type: bar; Serial: #1

Communication System: GSM 850; Frequency: 836.6 MHz; Duty Cycle: 1:2.075
 Medium parameters used (interpolated): $f = 836.6$ MHz; $\sigma = 0.981$ mho/m; $\epsilon_r = 56.8$; $\rho = 1000$ kg/m³
 Phantom section: Center Section
 Measurement Standard: DASy4 (High Precision Assessment)

DASy4 Configuration:

- Probe: EX3DV4 – SN3797; ConvF(8.98, 8.98, 8.98); Calibrated: 2012-11-22
- Sensor-Surface: 4mm (Mechanical Surface Detection)
- Electronics: DAE4 Sn648; Calibrated: 2013-04-24
- Phantom: Triple Flat Phantom 5.1C_20120905; Type: QD 000 P51 CA;
- Measurement SW: DASy4, V4.7 Build 80;

GSM850 Body Rear GPRS 4Tx 190/Area Scan (61x101x1): Measurement grid:
 dx=15mm, dy=15mm

Maximum value of SAR (interpolated) = 0.542 mW/g

GSM850 Body Rear GPRS 4Tx 190/Zoom Scan (5x5x7)/Cube 0: Measurement grid:
 dx=8mm, dy=8mm, dz=5mm

Reference Value = 17.3 V/m; Power Drift = -0.174 dB

Peak SAR (extrapolated) = 0.637 W/kg

SAR(1 g) = 0.506 mW/g; SAR(10 g) = 0.382 mW/g

Maximum value of SAR (measured) = 0.526 mW/g

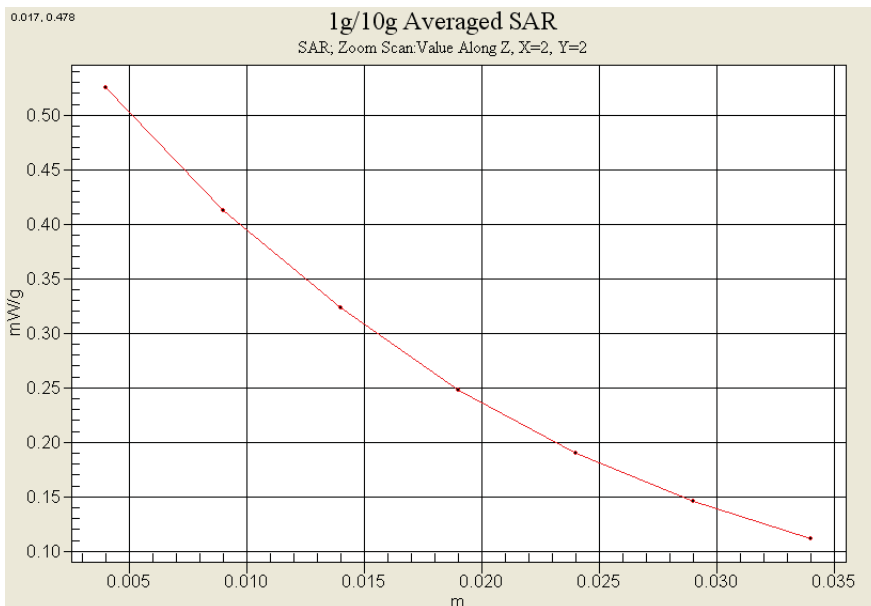

Test Laboratory: HCT CO., LTD
EUT Type: Cellular/PCS GSM/GPRS/EDGE/WCDMA/HSDPA/HSUPA Phone with Bluetooth
WLAN and NFC(Felica)
Liquid Temperature: 20.1 °C
Ambient Temperature: 20.3 °C
Test Date: Jul. 25, 2013
Plot No. 9

DUT: LG-D605; Type: bar; Serial: #1

Communication System: GSM 1900; Frequency: 1880 MHz; Duty Cycle: 1:2.075
Medium parameters used: $f = 1880$ MHz; $\sigma = 1.47$ mho/m; $\epsilon_r = 53.6$; $\rho = 1000$ kg/m³
Phantom section: Center Section
Measurement Standard: DAS4 (High Precision Assessment)

DASY4 Configuration:

- Probe: ET3DV6 – SN1798; ConvF(4.7, 4.7, 4.7); Calibrated: 2013-04-29
- Sensor-Surface: 4mm (Mechanical Surface Detection)
- Electronics: DAE3 Sn446; Calibrated: 2013-01-16
- Phantom: Triple Flat Phantom 5.1C_20120905; Type: QD 000 P51 CA;
- Measurement SW: DAS4, V4.7 Build 80;

GSM1900 Body Rear GPRS 4Tx 661/Area Scan (61x111x1): Measurement grid:
dx=15mm, dy=15mm

Maximum value of SAR (interpolated) = 0.750 mW/g

GSM1900 Body Rear GPRS 4Tx 661/Zoom Scan (5x5x7)/Cube 0: Measurement
grid: dx=8mm, dy=8mm, dz=5mm

Reference Value = 9.54 V/m; Power Drift = -0.130 dB

Peak SAR (extrapolated) = 1.01 W/kg

SAR(1 g) = 0.678 mW/g; SAR(10 g) = 0.396 mW/g

Maximum value of SAR (measured) = 0.751 mW/g

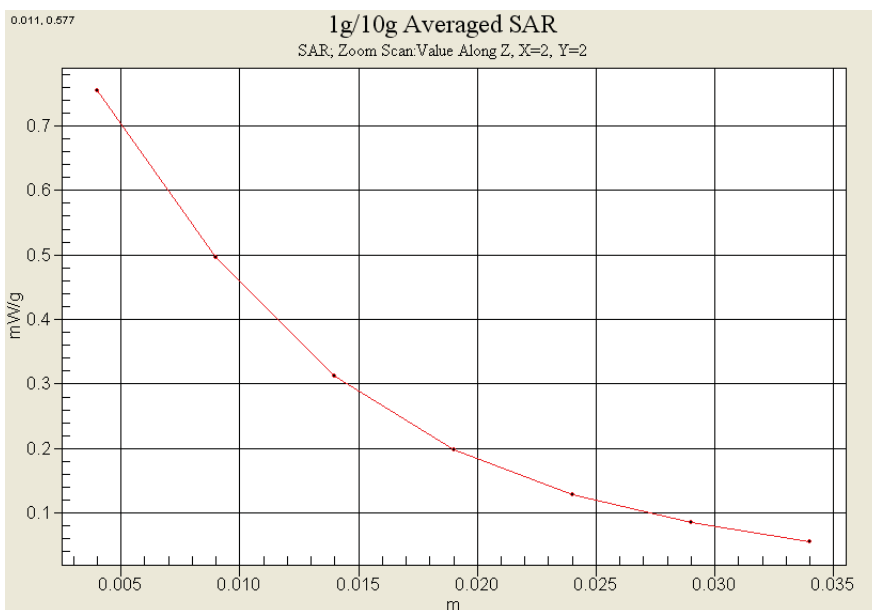

Test Laboratory: HCT CO., LTD
 EUT Type: Cellular/PCS GSM/GPRS/EDGE/WCDMA/HSDPA/HSUPA Phone with Bluetooth
 WLAN and NFC(Felica)
 Liquid Temperature: 20.3 °C
 Ambient Temperature: 20.5 °C
 Test Date: Jul. 23, 2013
 Plot No. 10

DUT: LG-D605; Type: bar; Serial: #1

Communication System: WCDMA850; Frequency: 836.6 MHz; Duty Cycle: 1:1
 Medium parameters used (interpolated): $f = 836.6 \text{ MHz}$; $\sigma = 0.981 \text{ mho/m}$; $\epsilon_r = 56.8$; $\rho = 1000 \text{ kg/m}^3$
 Phantom section: Center Section
 Measurement Standard: DAS4 (High Precision Assessment)

DASY4 Configuration:

- Probe: EX3DV4 – SN3797; ConvF(8.98, 8.98, 8.98); Calibrated: 2012-11-22
- Sensor-Surface: 4mm (Mechanical Surface Detection)
- Electronics: DAE4 Sn648; Calibrated: 2013-04-24
- Phantom: Triple Flat Phantom 5.1C_20120905; Type: QD 000 P51 CA;
- Measurement SW: DASY4, V4.7 Build 80;

WCDMA850 Body Rear 4183/Area Scan (61x101x1): Measurement grid: $dx=15\text{mm}$, $dy=15\text{mm}$

Maximum value of SAR (interpolated) = 0.524 mW/g

WCDMA850 Body Rear 4183/Zoom Scan (5x5x7)/Cube 0: Measurement grid: $dx=8\text{mm}$, $dy=8\text{mm}$, $dz=5\text{mm}$

Reference Value = 17.7 V/m; Power Drift = 0.005 dB

Peak SAR (extrapolated) = 0.635 W/kg

SAR(1 g) = 0.501 mW/g; SAR(10 g) = 0.379 mW/g

Maximum value of SAR (measured) = 0.523 mW/g

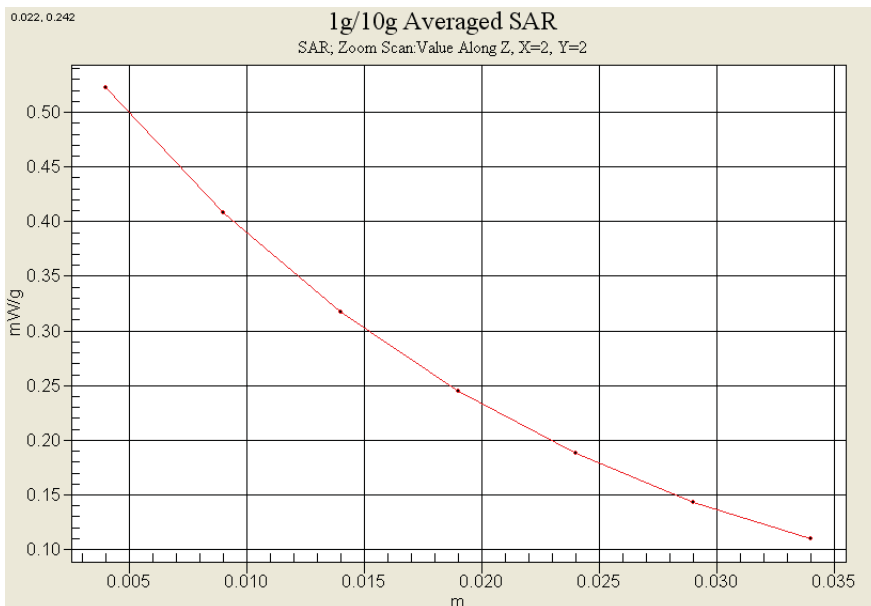

Test Laboratory: HCT CO., LTD
EUT Type: Cellular/PCS GSM/GPRS/EDGE/WCDMA/HSDPA/HSUPA Phone with Bluetooth
WLAN and NFC(Felica)
Liquid Temperature: 20.1 °C
Ambient Temperature: 20.3 °C
Test Date: Jul. 25, 2013
Plot No. 11

DUT: LG-D605; Type: bar; Serial: #1

Communication System: WCDMA1900; Frequency: 1880 MHz; Duty Cycle: 1:1
Medium parameters used: $f = 1880$ MHz; $\sigma = 1.47$ mho/m; $\epsilon_r = 53.6$; $\rho = 1000$ kg/m³
Phantom section: Center Section
Measurement Standard: DAS4 (High Precision Assessment)

DASY4 Configuration:

- Probe: ET3DV6 – SN1798; ConvF(4.7, 4.7, 4.7); Calibrated: 2013-04-29
- Sensor-Surface: 4mm (Mechanical Surface Detection)
- Electronics: DAE3 Sn446; Calibrated: 2013-01-16
- Phantom: Triple Flat Phantom 5.1C_20120905; Type: QD 000 P51 CA;
- Measurement SW: DAS4, V4.7 Build 80;

WCDMA1900 Body Bottom 9400/Area Scan (61x41x1): Measurement grid: dx=15mm, dy=15mm

Maximum value of SAR (interpolated) = 0.597 mW/g

WCDMA1900 Body Bottom 9400/Zoom Scan (5x5x7)/Cube 0: Measurement grid: dx=8mm, dy=8mm, dz=5mm

Reference Value = 17.7 V/m; Power Drift = -0.082 dB

Peak SAR (extrapolated) = 0.773 W/kg

SAR(1 g) = 0.519 mW/g; SAR(10 g) = 0.301 mW/g

Maximum value of SAR (measured) = 0.583 mW/g

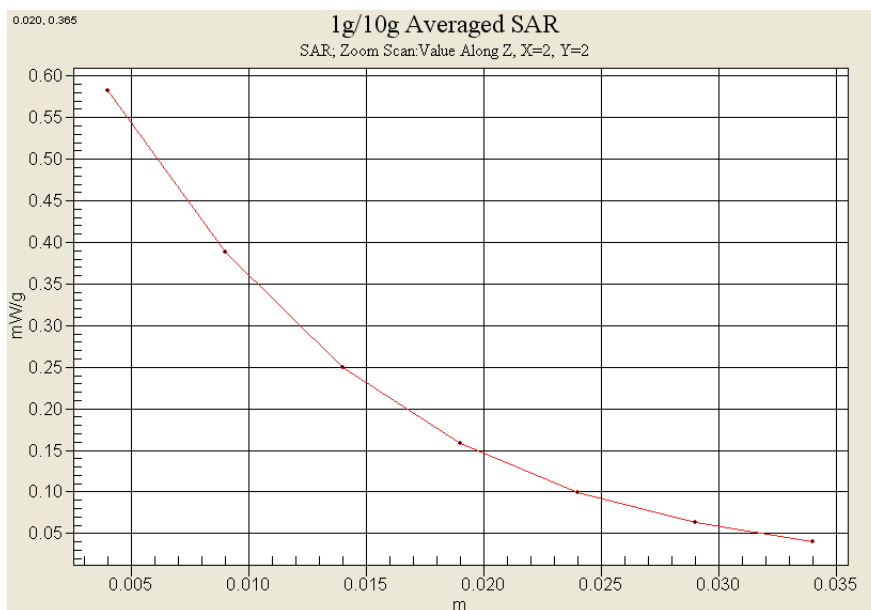

Test Laboratory: HCT CO., LTD
EUT Type: Cellular/PCS GSM/GPRS/EDGE/WCDMA/HSDPA/HSUPA Phone with Bluetooth
WLAN and NFC(Felica)
Liquid Temperature: 20.6 °C
Ambient Temperature: 20.8 °C
Test Date: Jul. 27, 2013
Plot No. 12

DUT: LG-D605; Type: bar; Serial: #1

Communication System: 2450MHz FCC; Frequency: 2462 MHz;Duty Cycle: 1:1
Medium parameters used (interpolated): $f = 2462$ MHz; $\sigma = 2$ mho/m; $\epsilon_r = 53.4$; $\rho = 1000$ kg/m³
Phantom section: Center Section
Measurement Standard: DAS4 (High Precision Assessment)

DASY4 Configuration:

- Probe: EX3DV4 – SN3797; ConvF(6.98, 6.98, 6.98); Calibrated: 2012-11-22
- Sensor-Surface: 4mm (Mechanical Surface Detection)
- Electronics: DAE4 Sn648; Calibrated: 2013-04-24
- Phantom: Triple Flat Phantom 5.1C_20120905; Type: QD 000 P51 CA;
- Measurement SW: DAS4, V4.7 Build 80;

802.11b Body Rear 1Mbps 11ch/Area Scan (81x131x1): Measurement grid: dx=12mm, dy=12mm

Maximum value of SAR (interpolated) = 0.190 mW/g

802.11b Body Rear 1Mbps 11ch/Zoom Scan (7x7x7)/Cube 0: Measurement grid: dx=5mm, dy=5mm, dz=5mm

Reference Value = 5.47 V/m; Power Drift = 0.004 dB

Peak SAR (extrapolated) = 0.309 W/kg

SAR(1 g) = 0.161 mW/g; SAR(10 g) = 0.082 mW/g

Maximum value of SAR (measured) = 0.185 mW/g

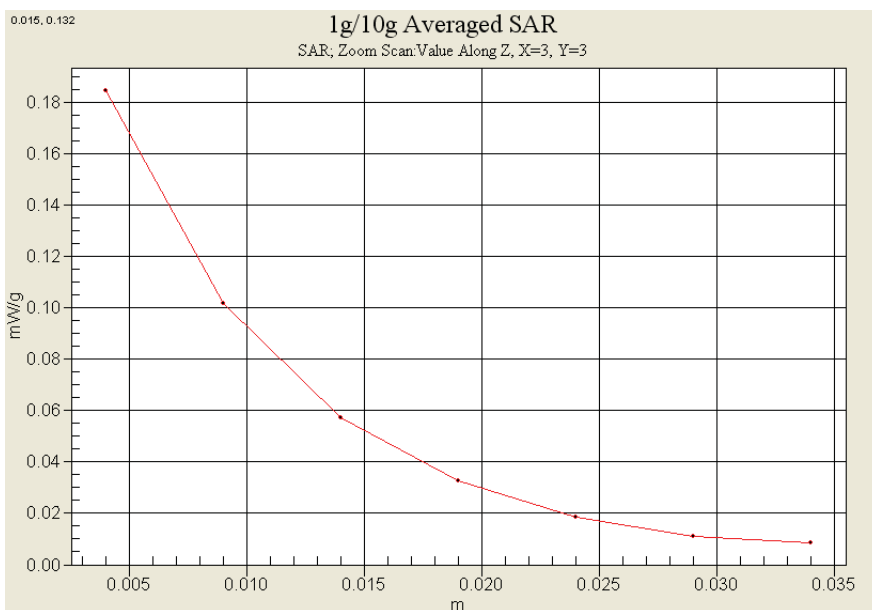

Test Laboratory: HCT CO., LTD
 EUT Type: Cellular/PCS GSM/GPRS/EDGE/WCDMA/HSDPA/HSUPA Phone with Bluetooth
 WLAN and NFC(Felica)
 Liquid Temperature: 20.4 °C
 Ambient Temperature: 20.6 °C
 Test Date: Jul. 30, 2013
 Plot No. 13

DUT: LG-D605; Type: bar; Serial: #1

Communication System: WIFI 5GHz; Frequency: 5745 MHz;Duty Cycle: 1:1
 Medium parameters used (interpolated): $f = 5745 \text{ MHz}$; $\sigma = 6.06 \text{ mho/m}$; $\epsilon_r = 46.5$; $\rho = 1000 \text{ kg/m}^3$
 Phantom section: Center Section
 Measurement Standard: DASYS4 (High Precision Assessment)

DASY4 Configuration:

- Probe: EX3DV4 – SN3903; ConvF(4.01, 4.01, 4.01); Calibrated: 2013-03-18
- Sensor-Surface: 2.5mm (Mechanical Surface Detection)Sensor-Surface: 2mm (Mechanical Surface Detection)
- Electronics: DAE4 Sn652; Calibrated: 2013-03-21
- Phantom: Triple Flat Phantom 5.1C; Type: QD 000 P51 CA;
- Measurement SW: DASYS4, V4.7 Build 80;

802.11a Body rear 149ch 6Mbps/Area Scan (101x151x1): Measurement grid:
 $dx=10\text{mm}$, $dy=10\text{mm}$

Maximum value of SAR (interpolated) = 0.304 mW/g

802.11a Body rear 149ch 6Mbps/Zoom Scan (7x7x11)/Cube 0: Measurement grid:
 $dx=4\text{mm}$, $dy=4\text{mm}$, $dz=2\text{mm}$

Reference Value = 1.78 V/m; Power Drift = 0.162 dB

Peak SAR (extrapolated) = 0.775 W/kg

SAR(1 g) = 0.184 mW/g; SAR(10 g) = 0.069 mW/g

Maximum value of SAR (measured) = 0.346 mW/g

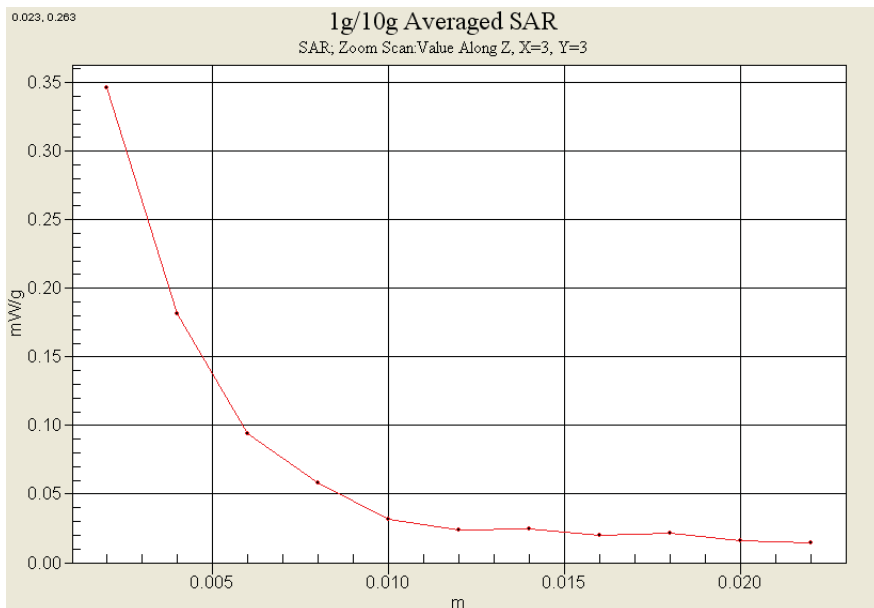

Test Laboratory: HCT CO., LTD
 EUT Type: Cellular/PCS GSM/GPRS/EDGE/WCDMA/HSDPA/HSUPA Phone with Bluetooth
 WLAN and NFC(Felica)
 Liquid Temperature: 20.7 °C
 Ambient Temperature: 20.9 °C
 Test Date: Jul. 29, 2013
 Plot No. 14

DUT: LG-D605; Type: bar; Serial: #1

Communication System: WIFI 5GHz; Frequency: 5300 MHz; Duty Cycle: 1:1
 Medium parameters used: $f = 5300 \text{ MHz}$; $\sigma = 5.34 \text{ mho/m}$; $\epsilon_r = 47.4$; $\rho = 1000 \text{ kg/m}^3$
 Phantom section: Center Section
 Measurement Standard: DAS4 (High Precision Assessment)

DASY4 Configuration:

- Probe: EX3DV4 – SN3903; ConvF(4.24, 4.24, 4.24); Calibrated: 2013-03-18
- Sensor-Surface: 2.5mm (Mechanical Surface Detection) Sensor-Surface: 2mm (Mechanical Surface Detection)
- Electronics: DAE4 Sn652; Calibrated: 2013-03-21
- Phantom: Triple Flat Phantom 5.1C; Type: QD 000 P51 CA;
- Measurement SW: DAS4, V4.7 Build 80;

802.11a Body rear 60ch 6Mbps/Area Scan (101x151x1): Measurement grid: $dx=10\text{mm}$, $dy=10\text{mm}$

Maximum value of SAR (interpolated) = 0.558 mW/g

802.11a Body rear 60ch 6Mbps/Zoom Scan (7x7x11)/Cube 0: Measurement grid: $dx=4\text{mm}$, $dy=4\text{mm}$, $dz=2\text{mm}$

Reference Value = 1.50 V/m; Power Drift = -0.135 dB

Peak SAR (extrapolated) = 1.36 W/kg

SAR(1 g) = 0.340 mW/g; SAR(10 g) = 0.113 mW/g

Maximum value of SAR (measured) = 0.652 mW/g

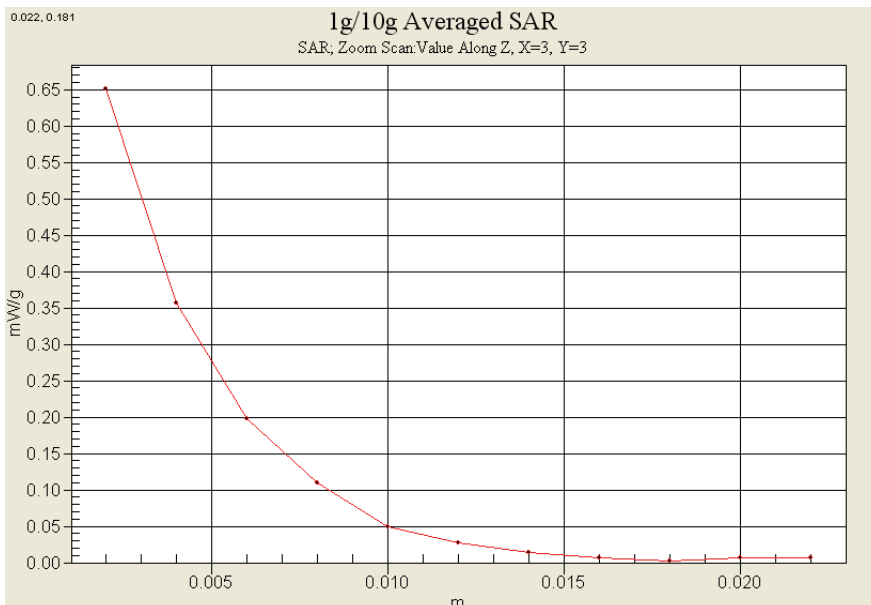

Attachment 2. – Dipole Verification Plots

■ Verification Data (835 MHz Head)

Test Laboratory: HCT CO., LTD
Input Power: 100 mW (20 dBm)
Liquid Temp: 20.3 °C
Test Date: Jul. 23, 2013

DUT: Dipole 835 MHz; Type: D835V2; Serial: D835V2 – SN:441

Communication System: CW; Frequency: 835 MHz; Duty Cycle: 1:1
Medium parameters used: $f = 835$ MHz; $\sigma = 0.92$ mho/m; $\epsilon_r = 40.4$; $\rho = 1000$ kg/m³
Phantom section: Flat Section
Measurement Standard: DAS4 (High Precision Assessment)

DASY4 Configuration:

- Probe: EX3DV4 – SN3797; ConvF(8.94, 8.94, 8.94); Calibrated: 2012-11-22
- Sensor-Surface: 4mm (Mechanical Surface Detection)
- Electronics: DAE4 Sn648; Calibrated: 2013-04-24
- Phantom: 1800/1900 Phantom; Type: SAM;
- Measurement SW: DAS4, V4.7 Build 80;

Verification 835MHz/Area Scan (61x61x1): Measurement grid: dx=15mm, dy=15mm
Maximum value of SAR (interpolated) = 1.08 mW/g

Verification 835MHz/Zoom Scan (5x5x7)/Cube 0: Measurement grid: dx=8mm, dy=8mm, dz=5mm

Reference Value = 34.3 V/m; Power Drift = -0.008 dB

Peak SAR (extrapolated) = 1.61 W/kg

SAR(1 g) = 0.988 mW/g; SAR(10 g) = 0.603 mW/g

Maximum value of SAR (measured) = 1.09 mW/g

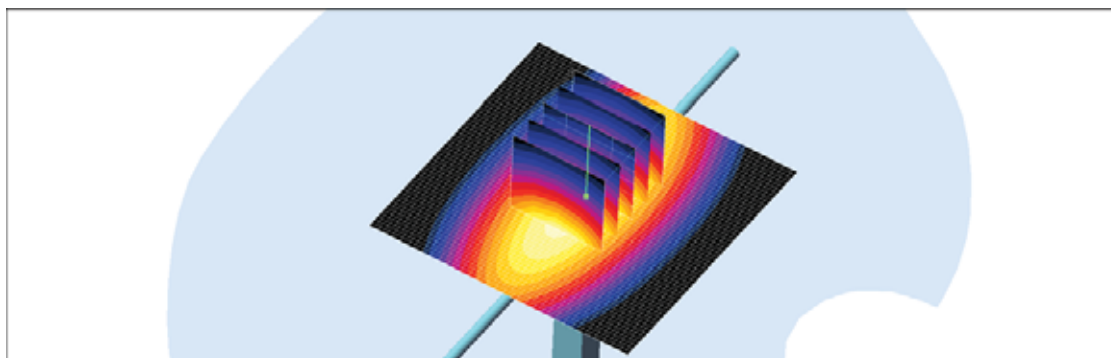
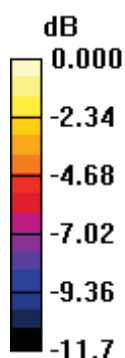

0 dB = 1.09mW/g

■ Verification Data (835 MHz Body)

Test Laboratory: HCT CO., LTD
Input Power 100 mW (20 dBm)
Liquid Temp: 20.3 °C
Test Date: Jul. 23, 2013

DUT: Dipole 835 MHz; Type: D835V2; Serial: D835V2 – SN:441

Communication System: CW; Frequency: 835 MHz; Duty Cycle: 1:1
Medium parameters used: $f = 835$ MHz; $\sigma = 0.981$ mho/m; $\epsilon_r = 56.8$; $\rho = 1000$ kg/m³
Phantom section: Flat Section
Measurement Standard: DAS4 (High Precision Assessment)

DASY4 Configuration:

- Probe: ET3DV6 – SN1798; ConvF(6.46, 6.46, 6.46); Calibrated: 2013-04-29
- Sensor-Surface: 4mm (Mechanical Surface Detection)
- Electronics: DAE3 Sn446; Calibrated: 2013-01-16
- Phantom: 1800/1900 Phantom; Type: SAM;
- Measurement SW: DAS4, V4.7 Build 80;

Verification 835 MHz/Area Scan (61x81x1): Measurement grid: dx=15mm, dy=15mm
Maximum value of SAR (interpolated) = 1.04 mW/g

Verification 835 MHz/Zoom Scan (5x5x7)/Cube 0: Measurement grid: dx=8mm, dy=8mm, dz=5mm
Reference Value = 33.6 V/m; Power Drift = -0.013 dB
Peak SAR (extrapolated) = 1.39 W/kg
SAR(1 g) = 0.958 mW/g; SAR(10 g) = 0.627 mW/g
Maximum value of SAR (measured) = 1.04 mW/g

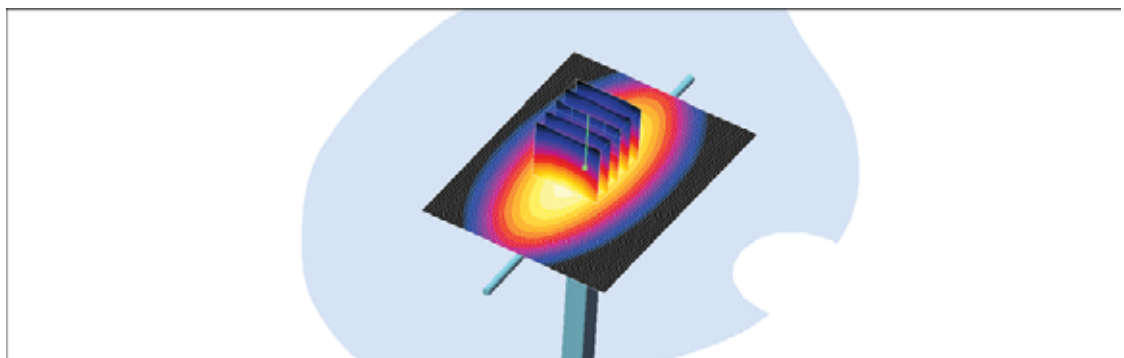
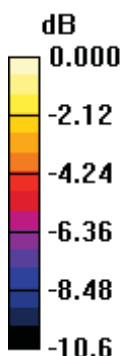

0 dB = 1.04mW/g

■ Verification Data (1 900 MHz Head)

Test Laboratory: HCT CO., LTD
Input Power 100 mW (20 dBm)
Liquid Temp: 20.4 °C
Test Date: Jul. 24, 2013

DUT: Dipole 1900 MHz; Type: D1900V2; Serial: D1900V2 – SN:5d038

Communication System: CW; Frequency: 1900 MHz; Duty Cycle: 1:1
Medium parameters used: $f = 1900$ MHz; $\sigma = 1.41$ mho/m; $\epsilon_r = 39.7$; $\rho = 1000$ kg/m³
Phantom section: Flat Section
Measurement Standard: DAS4 (High Precision Assessment)

DASY4 Configuration:

- Probe: ET3DV6 – SN1798; ConvF(5.29, 5.29, 5.29); Calibrated: 2013-04-29
- Sensor-Surface: 4mm (Mechanical Surface Detection)
- Electronics: DAE3 Sn446; Calibrated: 2013-01-16
- Phantom: SAM 1800/1900 MHz; Type: SAM;
- Measurement SW: DAS4, V4.7 Build 80;

Verification 1900MHz/Area Scan (61x61x1): Measurement grid: dx=15mm, dy=15mm
Maximum value of SAR (interpolated) = 4.54 mW/g

Verification 1900MHz/Zoom Scan (5x5x7)/Cube 0: Measurement grid: dx=8mm, dy=8mm, dz=5mm

Reference Value = 57.6 V/m; Power Drift = -0.011 dB

Peak SAR (extrapolated) = 6.72 W/kg

SAR(1 g) = 3.83 mW/g; SAR(10 g) = 1.97 mW/g

Maximum value of SAR (measured) = 4.28 mW/g

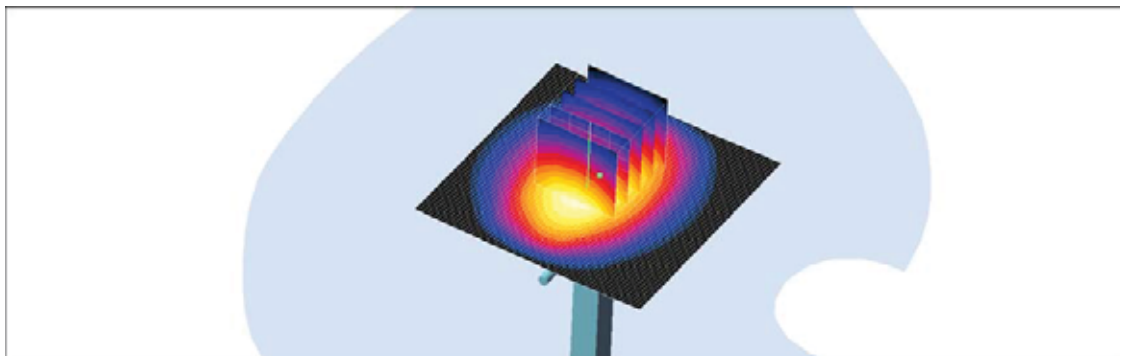
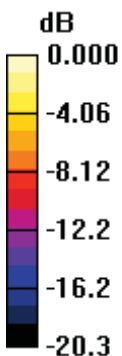

0 dB = 4.28mW/g

■ Verification Data (1 900 MHz Body)

Test Laboratory: HCT CO., LTD
Input Power 100 mW (20 dBm)
Liquid Temp: 20.1 °C
Test Date: Jul. 21, 2013

DUT: Dipole 1900 MHz; Type: D1900V2; Serial: D1900V2 – SN:5d038

Communication System: CW; Frequency: 1900 MHz; Duty Cycle: 1:1
Medium parameters used: $f = 1900$ MHz; $\sigma = 1.49$ mho/m; $\epsilon_r = 53.5$; $\rho = 1000$ kg/m³
Phantom section: Center Section
Measurement Standard: DAS4 (High Precision Assessment)

DASY4 Configuration:

- Probe: ET3DV6 – SN1798; ConvF(4.7, 4.7, 4.7); Calibrated: 2013-04-29
- Sensor-Surface: 4mm (Mechanical Surface Detection)
- Electronics: DAE3 Sn446; Calibrated: 2013-01-16
- Phantom: Triple Flat Phantom 5.1C_20120905; Type: QD 000 P51 CA;
- Measurement SW: DAS4, V4.7 Build 80;

Verification 1900 MHz/Area Scan (61x61x1): Measurement grid: dx=15mm, dy=15mm
Maximum value of SAR (interpolated) = 4.63 mW/g

Verification 1900 MHz/Zoom Scan (5x5x7)/Cube 0: Measurement grid: dx=8mm, dy=8mm, dz=5mm

Reference Value = 58.0 V/m; Power Drift = -0.027 dB

Peak SAR (extrapolated) = 6.51 W/kg

SAR(1 g) = 3.97 mW/g; SAR(10 g) = 2.15 mW/g

Maximum value of SAR (measured) = 4.43 mW/g

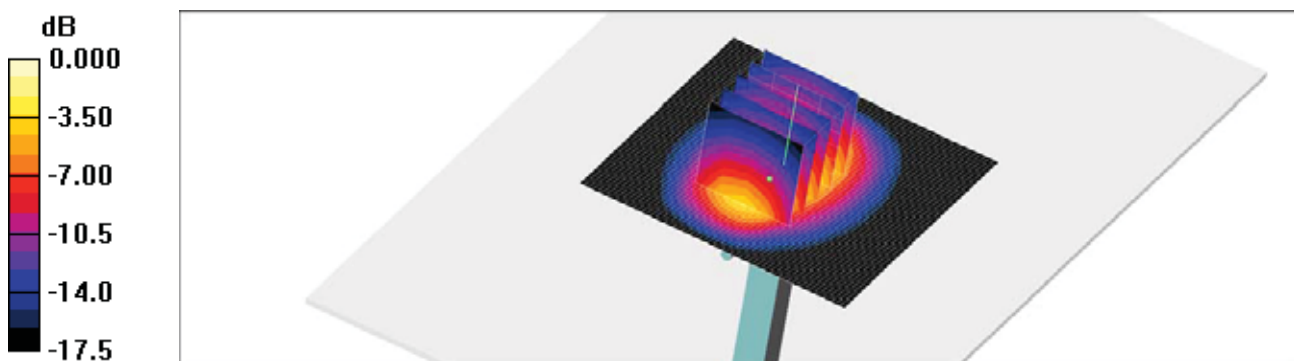

0 dB = 4.43mW/g

■ Verification Data (2 450 MHz Head)

Test Laboratory: HCT CO., LTD
 Input Power 100 mW (20 dBm)
 Liquid Temp: 20.5 °C
 Test Date: Jul. 26, 2013

DUT: Dipole 2450 MHz; Type: D2450V2; Serial: D2450V2 – SN:743

Communication System: CW; Frequency: 2450 MHz; Duty Cycle: 1:1
 Medium parameters used: $f = 2450$ MHz; $\sigma = 1.83$ mho/m; $\epsilon_r = 37.7$; $\rho = 1000$ kg/m³
 Phantom section: Flat Section
 Measurement Standard: DAS4 (High Precision Assessment)

DASY4 Configuration:

- Probe: EX3DV4 – SN3903; ConvF(7.43, 7.43, 7.43); Calibrated: 2013-03-18
- Sensor-Surface: 2mm (Mechanical Surface Detection)
- Electronics: DAE4 Sn652; Calibrated: 2013-03-21
- Phantom: 835/900 Phantom ; Type: SAM;
- Measurement SW: DAS4, V4.7 Build 80;

Verification 2450MHz/Area Scan (81x81x1): Measurement grid: dx=12mm, dy=12mm
 Maximum value of SAR (interpolated) = 8.62 mW/g

Verification 2450MHz/Zoom Scan (7x7x7)/Cube 0: Measurement grid: dx=5mm, dy=5mm, dz=5mm
 Reference Value = 57.8 V/m; Power Drift = -0.055 dB
 Peak SAR (extrapolated) = 12.3 W/kg
SAR(1 g) = 5.3 mW/g; SAR(10 g) = 2.32 mW/g
 Maximum value of SAR (measured) = 8.57 mW/g

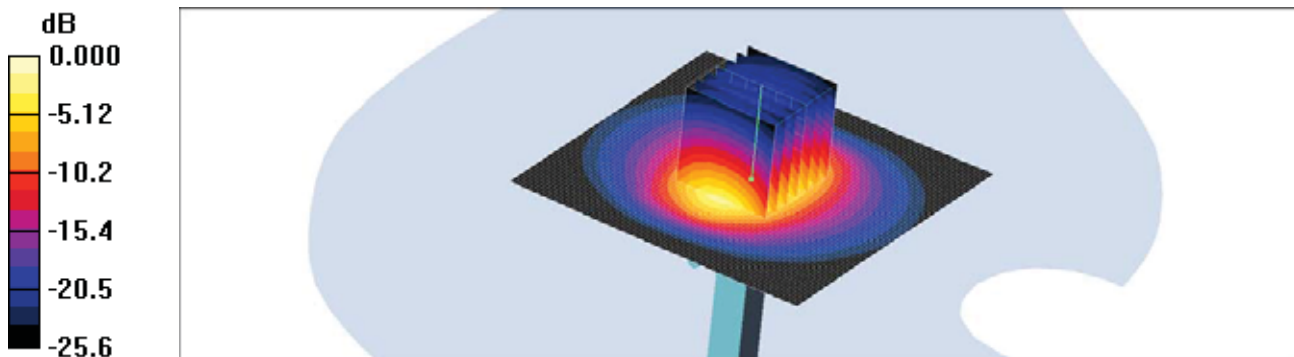

0 dB = 8.57mW/g

■ Verification Data (2 450 MHz Body)

Test Laboratory: HCT CO., LTD

Input Power 100 mW (20 dBm)

Liquid Temp: 20.6 °C

Test Date: Jul. 27, 2013

DUT: Dipole 2450 MHz; Type: D2450V2; Serial: D2450V2 – SN:743

Communication System: CW; Frequency: 2450 MHz; Duty Cycle: 1:1

Medium parameters used: $f = 2450$ MHz; $\sigma = 1.99$ mho/m; $\epsilon_r = 53.4$; $\rho = 1000$ kg/m³

Phantom section: Center Section

Measurement Standard: DASYS4 (High Precision Assessment)

DASY4 Configuration:

- Probe: EX3DV4 – SN3797; ConvF(6.98, 6.98, 6.98); Calibrated: 2012-11-22
- Sensor-Surface: 2mm (Mechanical Surface Detection)
- Electronics: DAE4 Sn648; Calibrated: 2013-04-24
- Phantom: Triple Flat Phantom 5.1C; Type: QD 000 P51 CA;
- Measurement SW: DASYS4, V4.7 Build 80;

Verification 2450MHz/Area Scan (81x81x1): Measurement grid: dx=12mm, dy=12mm
Maximum value of SAR (interpolated) = 8.44 mW/g

Verification 2450MHz/Zoom Scan (7x7x7)/Cube 0: Measurement grid: dx=5mm, dy=5mm, dz=5mm

Reference Value = 48.5 V/m; Power Drift = 0.096 dB

Peak SAR (extrapolated) = 12.0 W/kg

SAR(1 g) = 5.34 mW/g; SAR(10 g) = 2.35 mW/g

Maximum value of SAR (measured) = 8.50 mW/g

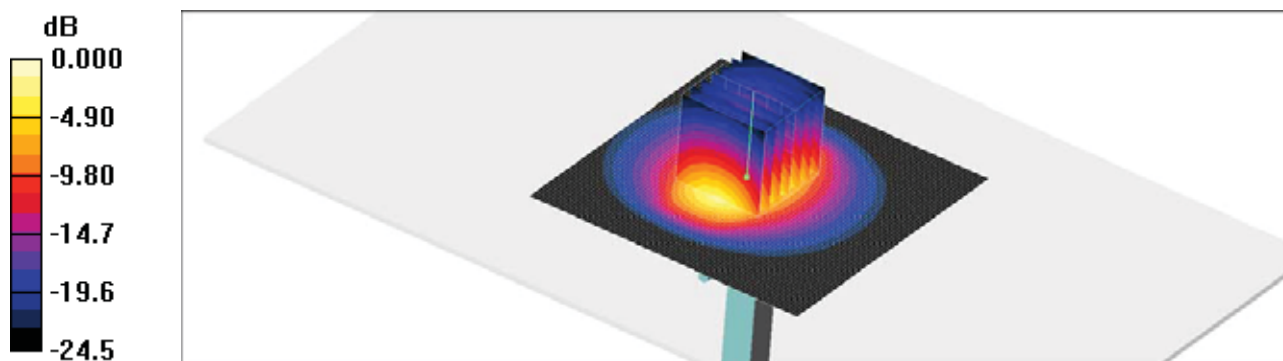

0 dB = 8.50mW/g

■ Verification Data (5 200 MHz Head)

Test Laboratory: HCT CO., LTD

Input Power 100 mW (20 dBm)

Liquid Temp: 20.7 °C

Test Date: Jul. 29, 2013

DUT: Dipole 5GHz; Type: D5000V2; Serial: D5000V2 – SN:1107

Communication System: CW; Frequency: 5200 MHz; Duty Cycle: 1:1

Medium parameters used: $f = 5200$ MHz; $\sigma = 4.54$ mho/m; $\epsilon_r = 36.3$; $\rho = 1000$ kg/m³

Phantom section: Flat Section

Measurement Standard: DAS4 (High Precision Assessment)

DASY4 Configuration:

- Probe: EX3DV4 – SN3903; ConvF(4.79, 4.79, 4.79); Calibrated: 2013-03-18
- Sensor-Surface: 4mm (Mechanical Surface Detection) Sensor-Surface: 2mm (Mechanical Surface Detection)
- Electronics: DAE4 Sn652; Calibrated: 2013-03-21
- Phantom: 1800/1900 Phantom; Type: SAM;
- Measurement SW: DAS4, V4.7 Build 80;

Validation 5200MHz/Area Scan (61x71x1): Measurement grid: dx=10mm, dy=10mm
Maximum value of SAR (interpolated) = 8.84 mW/g

Validation 5200MHz/Zoom Scan (7x7x11)/Cube 0: Measurement grid: dx=4mm, dy=4mm, dz=2mm

Reference Value = 43.7 V/m; Power Drift = -0.014 dB

Peak SAR (extrapolated) = 30.9 W/kg

SAR(1 g) = 7.64 mW/g; SAR(10 g) = 2.18 mW/g

Maximum value of SAR (measured) = 15.6 mW/g

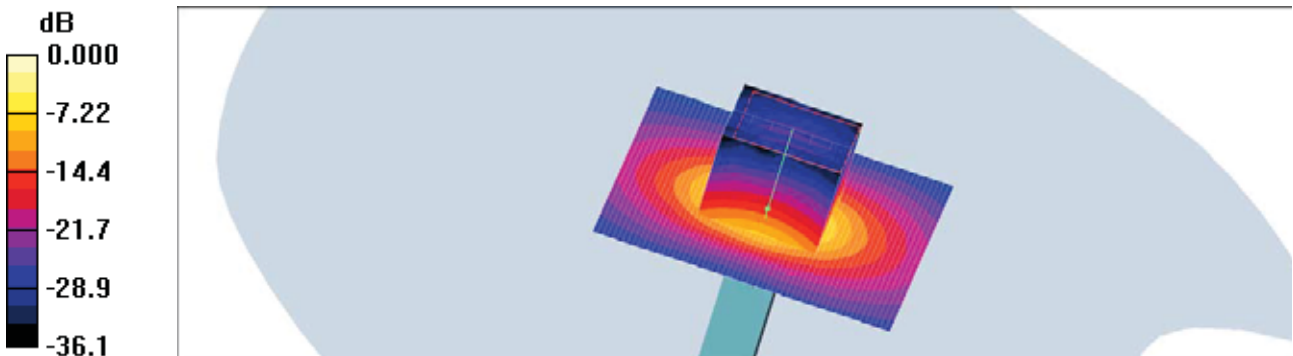

0 dB = 15.6mW/g

■ Verification Data (5 300 MHz Head)

Test Laboratory: HCT CO., LTD
Input Power 100 mW (20 dBm)
Liquid Temp: 20.7 °C
Test Date: Jul. 29, 2013

DUT: Dipole 5GHz; Type: D5000V2; Serial: D5000V2 – SN:1107

Communication System: CW; Frequency: 5300 MHz; Duty Cycle: 1:1
Medium parameters used: $f = 5300$ MHz; $\sigma = 4.68$ mho/m; $\epsilon_r = 35.9$; $\rho = 1000$ kg/m³
Phantom section: Flat Section
Measurement Standard: DAS4 (High Precision Assessment)

DASY4 Configuration:

- Probe: EX3DV4 – SN3903; ConvF(4.6, 4.6, 4.6); Calibrated: 2013-03-18
- Sensor–Surface: 4mm (Mechanical Surface Detection) Sensor–Surface: 2mm (Mechanical Surface Detection)
- Electronics: DAE4 Sn652; Calibrated: 2013-03-21
- Phantom: 800/900 Phantom; Type: SAM;
- Measurement SW: DAS4, V4.7 Build 80;

Validation 5300MHz/Area Scan (61x71x1): Measurement grid: dx=10mm, dy=10mm
Maximum value of SAR (interpolated) = 8.81 mW/g

Validation 5300MHz/Zoom Scan (7x7x1)/Cube 0: Measurement grid: dx=4mm, dy=4mm, dz=2mm

Reference Value = 42.6 V/m; Power Drift = 0.068 dB

Peak SAR (extrapolated) = 43.5 W/kg

SAR(1 g) = 8.35 mW/g; SAR(10 g) = 2.24 mW/g

Maximum value of SAR (measured) = 18.3 mW/g

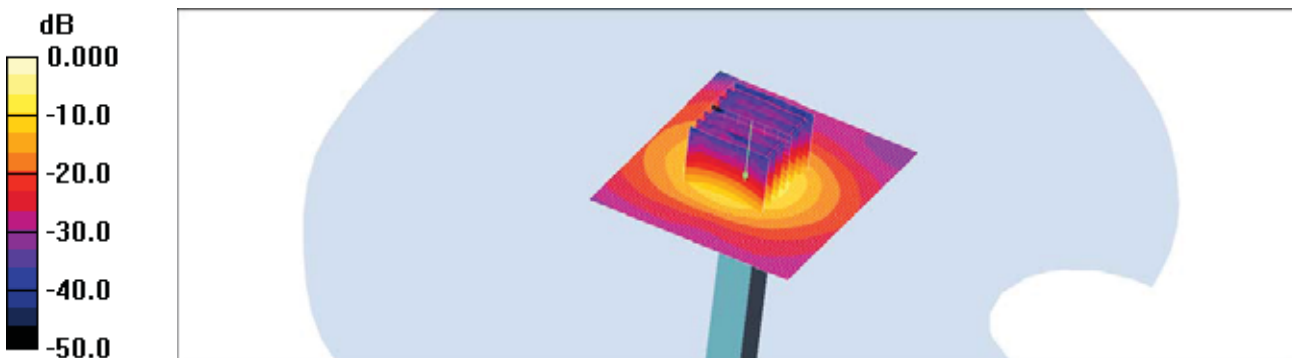

0 dB = 18.3mW/g

Verification Data (5 600 MHz Head)

Test Laboratory: HCT CO., LTD

Input Power 100 mW (20 dBm)

Liquid Temp: 20.4 °C

Test Date: Jul. 30, 2013

DUT: Dipole 5GHz; Type: D5000V2; Serial: D5000V2 – SN:1107

Communication System: CW; Frequency: 5600 MHz; Duty Cycle: 1:1

Medium parameters used: $f = 5600$ MHz; $\sigma = 5.01$ mho/m; $\epsilon_r = 35.2$; $\rho = 1000$ kg/m³

Phantom section: Flat Section

Measurement Standard: DAS4 (High Precision Assessment)

DASY4 Configuration:

- Probe: EX3DV4 – SN3903; ConvF(4.46, 4.46, 4.46); Calibrated: 2013-03-18
- Sensor-Surface: 4mm (Mechanical Surface Detection) Sensor-Surface: 2mm (Mechanical Surface Detection)
- Electronics: DAE4 Sn652; Calibrated: 2013-03-21
- Phantom: 1800/1900 Phantom; Type: SAM;
- Measurement SW: DAS4, V4.7 Build 80;

Validation 5600MHz/Area Scan (61x71x1): Measurement grid: dx=10mm, dy=10mm
Maximum value of SAR (interpolated) = 9.51 mW/g

Validation 5600MHz/Zoom Scan (7x7x1)/Cube 0: Measurement grid: dx=4mm, dy=4mm, dz=2mm

Reference Value = 42.2 V/m; Power Drift = -0.013 dB

Peak SAR (extrapolated) = 39.6 W/kg

SAR(1 g) = 8.54 mW/g; SAR(10 g) = 2.38 mW/g

Maximum value of SAR (measured) = 17.8 mW/g

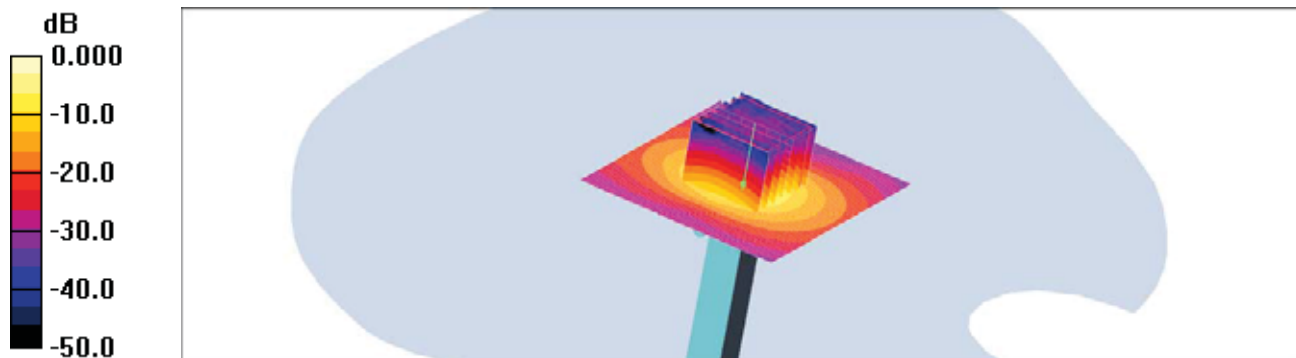

0 dB = 17.8mW/g

■ Verification Data (5 800 MHz Head)

Test Laboratory: HCT CO., LTD
Input Power 100 mW (20 dBm)
Liquid Temp: 20.4 °C
Test Date: Jul. 30, 2013

DUT: Dipole 5GHz; Type: D5000V2; Serial: D5000V2 – SN:1107

Communication System: CW; Frequency: 5800 MHz; Duty Cycle: 1:1
Medium parameters used: $f = 5800$ MHz; $\sigma = 5.29$ mho/m; $\epsilon_r = 34.6$; $\rho = 1000$ kg/m³
Phantom section: Flat Section
Measurement Standard: DAS4 (High Precision Assessment)

DASY4 Configuration:

- Probe: EX3DV4 – SN3903; ConvF(4.14, 4.14, 4.14); Calibrated: 2013-03-18
- Sensor-Surface: 4mm (Mechanical Surface Detection) Sensor-Surface: 2mm (Mechanical Surface Detection)
- Electronics: DAE4 Sn652; Calibrated: 2013-03-21
- Phantom: SAM 1800/1900 MHz; Type: SAM;
- Measurement SW: DAS4, V4.7 Build 80;

Validation 5800MHz/Area Scan (61x71x1): Measurement grid: dx=10mm, dy=10mm
Maximum value of SAR (interpolated) = 9.28 mW/g

Validation 5800MHz/Zoom Scan (7x7x1)/Cube 0: Measurement grid: dx=4mm, dy=4mm, dz=2mm

Reference Value = 36.4 V/m; Power Drift = 0.080 dB

Peak SAR (extrapolated) = 34.5 W/kg

SAR(1 g) = 7.92 mW/g; SAR(10 g) = 2.18 mW/g

Maximum value of SAR (measured) = 16.6 mW/g

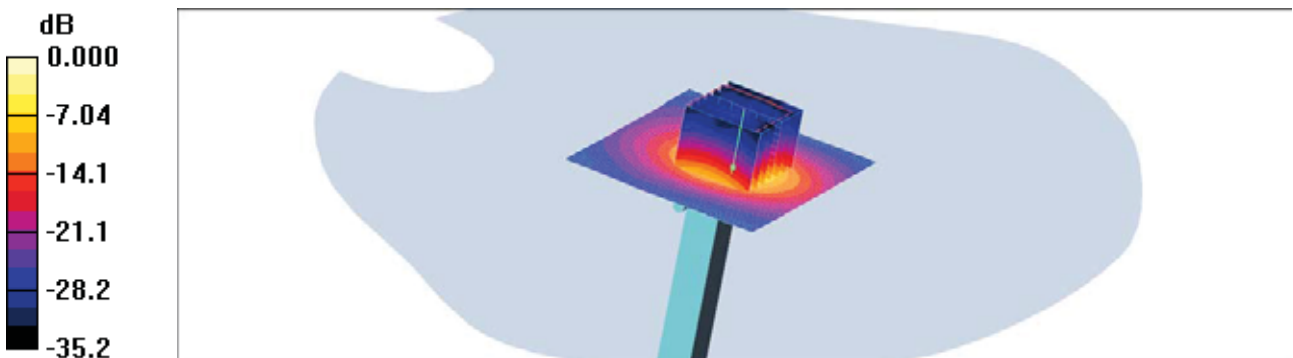

0 dB = 16.6mW/g

■ Verification Data (5 200 MHz Body)

Test Laboratory: HCT CO., LTD
Input Power 100 mW (20 dBm)
Liquid Temp: 20.7 °C
Test Date: Jul. 29, 2013

DUT: Dipole 5GHz; Type: D5000V2; Serial: D5000V2 – SN:1107

Communication System: CW; Frequency: 5200 MHz; Duty Cycle: 1:1
Medium parameters used: $f = 5200$ MHz; $\sigma = 5.19$ mho/m; $\epsilon_r = 47.8$; $\rho = 1000$ kg/m³
Phantom section: Center Section
Measurement Standard: DAS4 (High Precision Assessment)

DASY4 Configuration:

- Probe: EX3DV4 – SN3903; ConvF(4.32, 4.32, 4.32); Calibrated: 2013-03-18
- Sensor-Surface: 4mm (Mechanical Surface Detection) Sensor-Surface: 2mm (Mechanical Surface Detection)
- Electronics: DAE4 Sn652; Calibrated: 2013-03-21
- Phantom: Triple Flat Phantom 5.1C; Type: QD 000 P51 CA;
- Measurement SW: DAS4, V4.7 Build 80;

Validation 5200MHz/Area Scan (61x71x1): Measurement grid: dx=10mm, dy=10mm
Maximum value of SAR (interpolated) = 8.72 mW/g

Validation 5200MHz/Zoom Scan (7x7x11)/Cube 0: Measurement grid: dx=4mm, dy=4mm, dz=2mm

Reference Value = 39.6 V/m; Power Drift = -0.062 dB

Peak SAR (extrapolated) = 30.0 W/kg

SAR(1 g) = 7.31 mW/g; SAR(10 g) = 2.07 mW/g

Maximum value of SAR (measured) = 15.2 mW/g

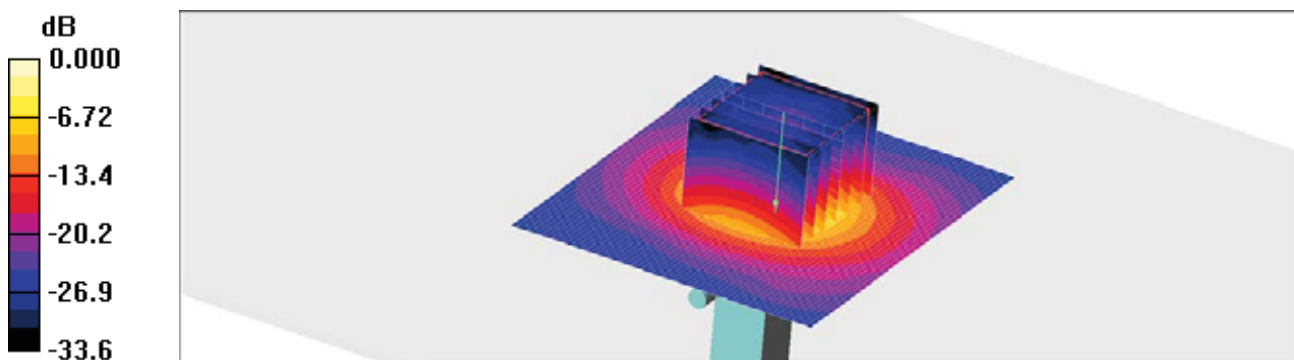

0 dB = 15.2mW/g

■ Verification Data (5 300 MHz Body)

Test Laboratory: HCT CO., LTD

Input Power 100 mW (20 dBm)

Liquid Temp: 20.7 °C

Test Date: Jul. 29, 2013

DUT: Dipole 5GHz; Type: D5000V2; Serial: D5000V2 – SN:1107

Communication System: CW; Frequency: 5300 MHz; Duty Cycle: 1:1

Medium parameters used: $f = 5300$ MHz; $\sigma = 5.34$ mho/m; $\epsilon_r = 47.4$; $\rho = 1000$ kg/m³

Phantom section: Center Section

Measurement Standard: DAS4 (High Precision Assessment)

DASY4 Configuration:

- Probe: EX3DV4 – SN3903; ConvF(4.24, 4.24, 4.24); Calibrated: 2013-03-18
- Sensor-Surface: 4mm (Mechanical Surface Detection) Sensor-Surface: 2mm (Mechanical Surface Detection)
- Electronics: DAE4 Sn652; Calibrated: 2013-03-21
- Phantom: Triple Flat Phantom 5.1C; Type: QD 000 P51 CA;
- Measurement SW: DAS4, V4.7 Build 80;

Validation 5300MHz/Area Scan (61x71x1): Measurement grid: dx=10mm, dy=10mm
Maximum value of SAR (interpolated) = 9.15 mW/g

Validation 5300MHz/Zoom Scan (7x7x11)/Cube 0: Measurement grid: dx=4mm, dy=4mm, dz=2mm

Reference Value = 39.9 V/m; Power Drift = -0.094 dB

Peak SAR (extrapolated) = 32.1 W/kg

SAR(1 g) = 7.69 mW/g; SAR(10 g) = 2.17 mW/g

Maximum value of SAR (measured) = 16.0 mW/g

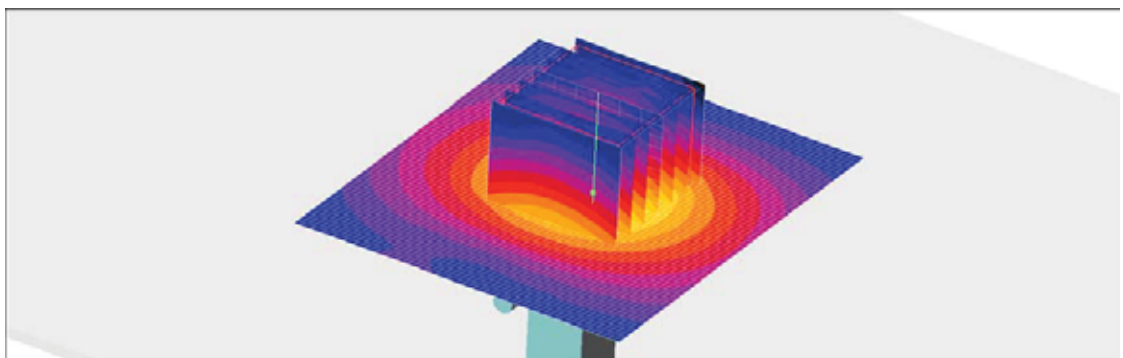
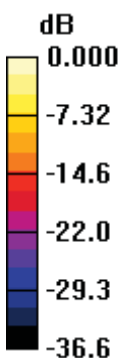

0 dB = 16.0mW/g

■ Verification Data (5 600 MHz Body)

Test Laboratory: HCT CO., LTD

Input Power 100 mW (20 dBm)

Liquid Temp: 20.4 °C

Test Date: Jul. 30, 2013

DUT: Dipole 5GHz; Type: D5000V2; Serial: D5000V2 – SN:1107

Communication System: CW; Frequency: 5600 MHz; Duty Cycle: 1:1

Medium parameters used: $f = 5600$ MHz; $\sigma = 5.66$ mho/m; $\epsilon_r = 46.9$; $\rho = 1000$ kg/m³

Phantom section: Center Section

Measurement Standard: DAS4 (High Precision Assessment)

DASY4 Configuration:

- Probe: EX3DV4 – SN3903; ConvF(3.73, 3.73, 3.73); Calibrated: 2013-03-18
- Sensor-Surface: 4mm (Mechanical Surface Detection) Sensor-Surface: 2mm (Mechanical Surface Detection)
- Electronics: DAE4 Sn652; Calibrated: 2013-03-21
- Phantom: Triple Flat Phantom 5.1C_20120905; Type: QD 000 P51 CA;
- Measurement SW: DAS4, V4.7 Build 80;

Validation 5600MHz/Area Scan (61x71x1): Measurement grid: dx=10mm, dy=10mm
Maximum value of SAR (interpolated) = 8.38 mW/g

Validation 5600MHz/Zoom Scan (7x7x11)/Cube 0: Measurement grid: dx=4mm, dy=4mm, dz=2mm

Reference Value = 36.3 V/m; Power Drift = 0.017 dB

Peak SAR (extrapolated) = 35.0 W/kg

SAR(1 g) = 7.69 mW/g; SAR(10 g) = 2.16 mW/g

Maximum value of SAR (measured) = 15.9 mW/g

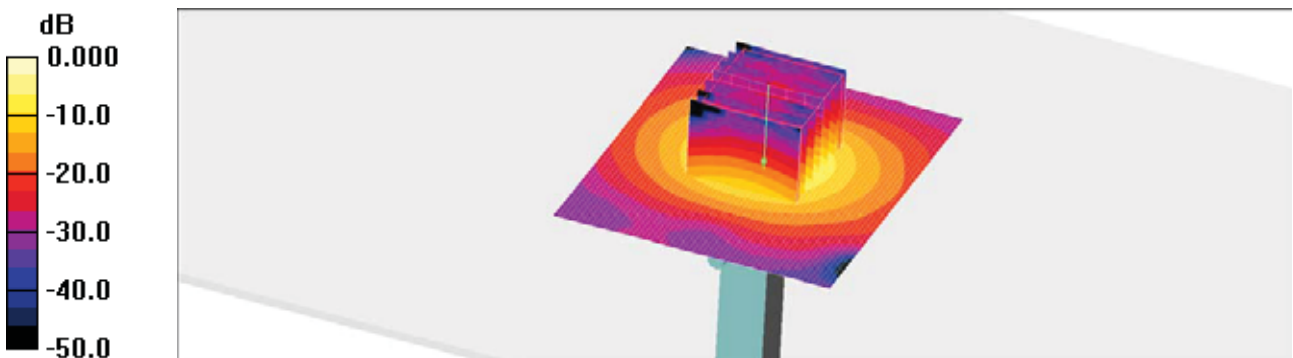

0 dB = 15.9mW/g

■ Verification Data (5 800 MHz Body)

Test Laboratory: HCT CO., LTD

Input Power 100 mW (20 dBm)

Liquid Temp: 20.4 °C

Test Date: Jul. 30, 2013

DUT: Dipole 5GHz; Type: D5000V2; Serial: D5000V2 – SN:1107

Communication System: CW; Frequency: 5800 MHz; Duty Cycle: 1:1

Medium parameters used: $f = 5800$ MHz; $\sigma = 6.04$ mho/m; $\epsilon_r = 46.5$; $\rho = 1000$ kg/m³

Phantom section: Center Section

Measurement Standard: DAS4 (High Precision Assessment)

DASY4 Configuration:

- Probe: EX3DV4 – SN3903; ConvF(4.01, 4.01, 4.01); Calibrated: 2013-03-18
- Sensor-Surface: 4mm (Mechanical Surface Detection) Sensor-Surface: 2mm (Mechanical Surface Detection)
- Electronics: DAE4 Sn652; Calibrated: 2013-03-21
- Phantom: Triple Flat Phantom 5.1C; Type: QD 000 P51 CA;
- Measurement SW: DAS4, V4.7 Build 80;

Validation 5800MHz/Area Scan (61x71x1): Measurement grid: dx=10mm, dy=10mm
Maximum value of SAR (interpolated) = 8.26 mW/g

Validation 5800MHz/Zoom Scan (7x7x1)/Cube 0: Measurement grid: dx=4mm, dy=4mm, dz=2mm

Reference Value = 36.8 V/m; Power Drift = 0.033 dB

Peak SAR (extrapolated) = 33.0 W/kg

SAR(1 g) = 7.49 mW/g; SAR(10 g) = 2.1 mW/g

Maximum value of SAR (measured) = 15.8 mW/g

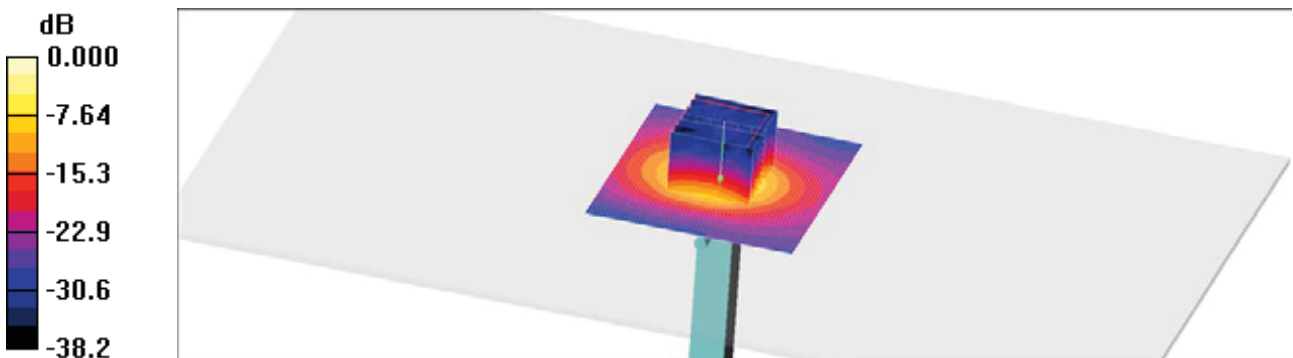

0 dB = 15.8mW/g