



LG

Life's Good

ENGLISH

User Guide

LG-D520

MFLO0000000 (1.0)



www.lg.com



LG-D520 User Guide

- Screen displays and illustrations may differ from those you see on actual phone.
- Some of the contents of this guide may not apply to your phone, depending on the software and your service provider. All information in this document is subject to change without notice.
- This handset is not suitable for people who have a visual impairment due to the touch screen keyboard.
- Copyright ©2013 LG Electronics, Inc. All rights reserved. LG and the LG logo are registered trademarks of LG Group and its related entities. All other trademarks are the property of their respective owners.
- Google™, Google Maps™, Gmail™, YouTube™, Google Talk™ and Google Play™ are trademarks of Google, Inc.

SERVICE ACTIVATION

If you are a new T-Mobile® customer and your service has not been activated, simply call Customer Care at **1-800-937-8997** from your landline phone and a T-Mobile Activations representative will assist you. You will need the following information when activating service:

- Service Agreement and agent code on your Agreement.
- Your name, home address, home phone, and billing address.

NOTE: For business and government accounts, please provide the name of your company or government agency, address, and tax ID.

- Your Social Security number, current driver's license number, and date of birth for credit check purposes.
- Your choice of T-Mobile rate plan and services (see www.t-mobile.com for the latest plan information).
- SIM serial number and IMEI number (located on the box bar code label).

By activating service, you acknowledge that you have read, understand, and agree to be bound by each of T-Mobile's Terms and Conditions and your Service Agreement.

About this user guide

Please read this user guide carefully before you use your phone and keep it handy for future reference.

Should your phone fails to operate correctly, refer to the FAQ section.

- Some features and service may vary by area, phone, carrier, plan and version of phone software.
- Screen displays and illustrations on this user manual may differ from those you see on the actual phone.
- Designs and specifications of the phone and other accessories are subject to change without any notice.

Table of contents

SERVICE ACTIVATION	2	Bluetooth.....	28
Important notice	6	USB Tethering.....	30
Getting to know your phone	12	Smartphone Mobile Hotspots	31
Phone overview.....	12	Enabling Wi-Fi Direct to share through SmartShare	31
Installing the Micro SIM card and battery	14	SmartShare.....	32
Charging your phone	16	Calls	35
Inserting a microSD card.....	17	Making a call	35
Removing the microSD card.....	18	Calling your contacts.....	35
Formatting the microSD card	19	Answering and rejecting a call	35
Locking and unlocking the screen ...	19	Adjusting the in-call volume.....	36
Your Home screen	20	Making a second call	36
Touch Screen tips	20	Ending a Call.....	36
Home screen.....	21	Ending a Call from the Status Bar...	37
Customizing the Home screen.....	21	Viewing your call logs.....	37
Returning to recently-used applications.....	22	Call settings.....	38
Notifications.....	22	Contacts	39
Swipe down for notifications & settings.....	23	Searching for a contact	39
Quick Settings.....	23	Adding a new contact.....	39
Indicator icons on the Status Bar.	24	Favorite Contacts.....	39
On-screen keyboard.....	26	Creating a group	40
Entering accented letters.....	26	Messaging	41
Google account setup	27	Conversation view	41
Connecting to Networks and Devices	28	Sending a message	41
Wi-Fi.....	28	Using smilies.....	42
Connecting to Wi-Fi networks.....	28	Changing your message settings....	42
Turning Wi-Fi on and connecting to a Wi-Fi network	28	Email	43
		Managing an email account.....	43
		Working with account folders.....	43
		Composing and sending email.....	44

Table of contents

Camera	45	Setting as wallpaper.....	62
Getting to know the viewfinder.....	45	Videos	62
Using the advanced settings.....	46	Playing a video	62
Taking a quick photo	47	Music.....	63
Once you've taken a photo.....	47	Add music files to your phone.....	63
Viewing your saved photos.....	49	Transfer music using Media sync (MTP)	64
Camcorder	50	Playing a song.....	64
Getting to know the viewfinder.....	50	Utilities	66
Using the advanced settings.....	51	Setting your alarm	66
Recording a quick video.....	51	Using your calculator.....	66
After recording a video.....	52	Adding an event to your calendar... ..	66
Watching your saved videos.....	52	Lookout Security	67
Adjusting the volume when viewing a video.....	52	T-Mobile TV	68
T-Mobile Name ID	68	File Manager.....	68
LG Unique Functions	53	Application Manager.....	69
QuickMemo	53	Visual Voicemail.....	70
Using the QuickMemo options.....	54	Voice Recorder.....	70
Viewing the saved QuickMemo	54	Recording a sound or voice.....	70
Live Zooming	55	Sending the voice recording.....	70
QSlide	56	Task Manager.....	71
QuickTranslator.....	57	Polaris Viewer 4	71
VuTalk	58	FileShare.....	71
Registering VuTalk.....	58	LG Backup	72
Using VuTalk	59	About backing up and restoring smartphone data	72
LG Tag+.....	60	LG Backup your smart phone data	73
Multimedia	61	Scheduling automatic backups	73
Gallery	61	Restoring smartphone data.....	73
Viewing pictures.....	61	Google+	74
Zooming in and out.....	61	Voice Search.....	74
Playing videos.....	61	Downloads.....	75
Viewing photo and video options.....	62		
Deleting images and videos	62		

NFC.....	75	Trademarks	94
To turn on NFC:.....	75	DivX Mobile	94
Direct/Android Beam.....	75	Dolby Digital Plus	95
To activate Direct/Android Beam:.....	75	Accessories	96
File networking.....	76	Technical data.....	97
To share my folder:.....	76	Troubleshooting.....	98
To access other device's folder:	76	For Your Safety	102
The Web	77		
Browser	77		
Using the Web toolbar	77		
Viewing webpages	77		
Opening a page	77		
Searching the web by voice	78		
Bookmarks.....	78		
History.....	78		
Using QSlide.....	78		
Chrome.....	78		
Viewing webpages	79		
Opening a page	79		
Searching the web by voice	79		
Syncing with other devices.....	79		
Settings	80		
Access the Settings menu	80		
WIRELESS & NETWORKS.....	80		
DEVICE	83		
PERSONAL	86		
SYSTEM.....	87		
Phone software update	92		
Phone software update	92		
LG Mobile Phone Software update via Over-the-Air (OTA).....	92		
Trademarks	94		

Important notice



Before you start using the phone, please read this!

Please check to see if any problems you have encountered with your phone are described in this section before taking the phone in for service or calling a service representative.



1. Phone Memory

In order to make more memory available, you will have to manage your applications and delete some data, such as applications or messages.

Managing applications



- 1 From the Home screen, tap **Apps**  > **Settings**  > **Apps**.
- 2 When the list of applications appears, scroll and tap the application you want to disable.
- 3 Tap **Uninstall** and then tap **OK** to confirm that you want to uninstall the desired application.

To stop applications

- 1 From the Home screen, tap **Apps**  > **Settings**  > **Apps** and select the **RUNNING** tab.
- 2 Scroll to the desired application and tap **Stop** to stop it.

Moving applications

To manage the internal storage efficiently, you can move applications from phone to the microSD card.

- 1 Touch  >  > **Apps**.
- 2 Tap the downloaded application and then tap **Move to SD card**.



2. Optimizing Battery Life

You can extend your battery's life between charges by turning off features that you don't need to run constantly in the background. You can also monitor how applications and system resources consume battery power.



To extend the life of your battery

- Turn off radio communications that you aren't using, such as Wi-Fi, Bluetooth, or GPS.
- Lower screen brightness and set a shorter screen timeout.
- Turn off automatic syncing for Gmail™, Calendar, Contacts, and other applications.
- Some applications you have downloaded may cause your battery power to be reduced.
- While using downloaded applications, check the battery charged level.

To view the battery charge level

- 1 From the Home screen, tap **Apps**  > **Settings**  > **About phone** > **Battery**.
- 2 The battery status (charging or discharging) and level are displayed on the top menu of the screen.

To monitor and control what uses the battery

- 1 From the Home screen, tap **Apps**  > **Settings**  > **About phone** > **Battery** > **Battery use**.
- 2 The bottom of the screen displays battery usage time and also lists applications or services using battery power from greatest amount to least.

3. Installing an Open Source Operating System

Installing an open source operating system on your phone and not using the operating system provided by the manufacturer can cause your phone to malfunction.

Important notice

Warning!

- If you install and use an OS other than the one provided by the manufacturer, your phone is no longer covered by the warranty.
- To protect your phone and personal data, download applications only from trusted sources, such as Play Store. If some applications are not properly installed on your phone, your phone may not work properly- or serious errors may occur. You will need to uninstall those applications and all of its data and settings from the phone.

4. Using an unlock pattern

Set a screen lock to secure your phone from unauthorized use. To set the screen lock, follow the process below.

From the Home screen, tap **Apps**  > **Settings** > **Lock screen** > **Select screen lock** and select from **None**, **Swipe**, **Face Unlock**, **Pattern**, **PIN** or **Password**.

NOTE: In case that you have trouble with Face Unlock, you can unlock the screen with a pattern and/or PIN as a backup.

Warning! Take precautions when using an Unlock Pattern, PIN, or Password. It is very important that you remember the screen unlock information you set. You are allowed 5 attempts to enter your screen unlock information. If you used up all 5 opportunities, you will have to wait 30 seconds to attempt unlocking the phone again.

When you can't recall your Unlock Pattern, PIN, or Password:

If you logged into a Google account on the phone and failed to use the correct pattern 5 times, tap **Forgot pattern?** You will be required to sign in with your Google account and prompted to create a new unlock pattern.

If you have set a backup PIN, you can unlock the screen by entering the backup PIN.

If you haven't created a Google account on the phone or you forgot your PIN or Password, you need to perform a hard reset.

5. Using Hard Reset (Factory Reset)

If your phone needs to be restored to its original condition, use a Hard Reset to initialize your phone.

Warning! If you perform a Hard Reset, all user applications and user data will be deleted. Please remember to back up any important data before performing a **Hard Reset**.

- 1 Turn the phone off.
- 2 Press and hold the **Power/Lock Key** + **Volume Down Key**.
- 3 LG Logo appears on the screen. And after a few seconds, **FACTORY HARD RESET** screen will appear, now release all keys.
- 4 The phone will allow you to select the factory reset function in the Android system recovery utility by pressing **Power/Lock Key**.
- 5 Press the **Power/Lock Key** again to confirm factory reset and your phone will be restored to its factory settings. To cancel, press any other key.

6. Using Safe Mode

To recover your phone when malfunctioning.

- 1 Turn off your phone and reboot. When you see the T-Mobile animation press and hold the **Volume Down Key**. Your main screen will then be displayed with the words "Safe mode" in the lower left corner.
- 2 From the Home screen, tap the **Menu Key** and tap **System settings** > **Apps**.
- 3 Tap one of the available tabs at the top of the screen and select the application you wish to uninstall.
- 4 Tap **Uninstall** and **OK** to confirm.
- 5 After uninstalling the application, turn off and reboot your phone.

Important notice

7. Using a microSD Card

Pictures, Music and Video files, can be saved to external memory. Before saving these files to external memory, you need to insert a microSD card. If you have not inserted a microSD card, your items will be saved to internal memory.

Warning! Do not remove the microSD card without unmounting it first. Otherwise, it may damage the microSD card as well as your phone, and the data stored on the microSD card may be corrupted. To unmount the microSD card, from the Home screen, tap the **Menu Key**  and tap **System settings > Storage > Unmount SD card > OK**.

8. Connecting Your Phone to a Computer via USB

- 1 Use the USB cable that was provided with your phone to connect the phone to a USB port on your computer. You'll receive a notification that the USB is connected and can see USB connection type pop-up.
- 2 Tap **Media sync (MTP)** to confirm that you want to transfer files between your phone's microSD card and the computer.

When the phone is connected as USB storage, you receive a notification. Your phone's microSD card is installed as a drive on your computer. You can now copy files to and from the microSD card.

9. Opening and Switching Applications

Multi-tasking is easy with Android because you can keep more than one application running at the same time. There's no need to quit an application before opening another. Use and switch between several open applications. Android manages each application, stopping and starting them as needed to ensure that idle applications don't consume resources unnecessarily.

TIP! To return to a recent application, press and hold the **Home Key** . The screen then displays a list of applications you have recently used.

10. Unlock Screen When Using Data Connection

Your screen will go dark if untouched for a period of time when using a data connection. To turn on your LCD screen, press the **Power/Lock Key** .

11. Hold the Phone Straight Up

Please hold the mobile phone straight up as a regular phone.

While making/receiving calls or sending/receiving data, try to avoid holding the lower part of the phone where the antenna is located. It may affect call quality.

12. When the Screen Freezes

If the phone does not respond to user input or the screen freezes:

Remove the battery, reinsert it, then turn the phone on.

OR

Press and hold the **Power/Lock Key**  for 10 seconds to turn it off. If it still does not work, please contact the service center.

13. Do Not Connect Your Phone When You Power On/Off Your PC

Make sure to disconnect your phone from the PC when powering your PC on or off as it might result in PC errors.

Getting to know your phone

Phone overview

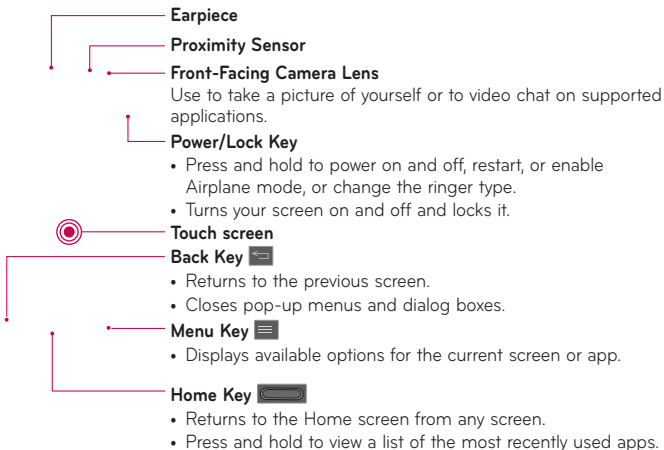

NOTE: Proximity sensor

When receiving and making calls, the proximity sensor automatically turns the backlight off and locks the touch screen by sensing when the phone is near your ear. This extends battery life and prevents you from unintentionally activating the touch screen during calls.

Warning! Placing a heavy object on the phone or sitting on it can damage the LCD and touch screen functions. Do not cover the LCD proximity sensor with protective film. This could cause the sensor to malfunction.

TIP!

- Tap the **Menu Key**  whenever you open an application to check what options are available.
- If your phone has errors when you use it or you cannot turn it on, remove the battery, install it again and turn it on after 5 seconds.

QuickButton key

Volume Keys

- **On the Home screen:** Controls ringer volume
- **During a call:** Controls your earpiece volume
- **When playing a track:** Controls volume continuously

Power/Lock Key

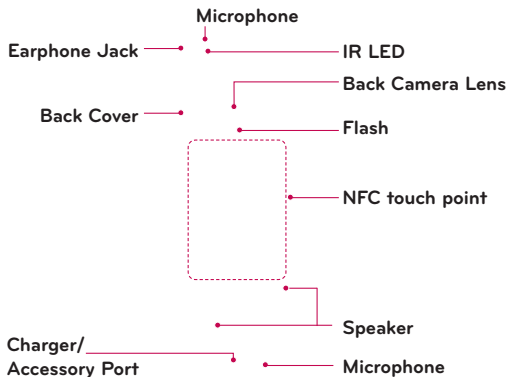

Notice: The NFC antenna for this model is on the back cover.

Installing the Micro SIM card and battery

Before you can start exploring your new phone, you'll need to set it up. To insert the Micro SIM card and battery:

- 1 Hold the phone on your hand firmly. With the other hand, lift the battery cover using the fingertip cutout located on the bottom of the cover and pull it up to remove it.



- 2 Slide the Micro SIM card into the Micro SIM card slot. Make sure the gold contact area on the card is facing downwards and the notched side is inserted first (see image below).

3 Insert the battery into place by aligning the gold contacts on the phone and the battery ❶ and press the battery down until it clicks into place ❷.

4 Align the battery cover over the battery compartment ❶ and press it down until it clicks into place ❷.

❶

❷

Getting to know your phone

Charging your phone

A rechargeable Li-ion battery is used to power your phone. A USB adapter, which is included with your phone, is used to charge the battery. Ask your local T-Mobile sales representative for further details regarding approved batteries and chargers. Before using your phone for the first time, make sure the battery is fully charged. An uncharged battery will fully recharge after 3 hours.

—• USB Adapter

USB Cable —•

NOTE: Make sure the battery is installed before connecting the USB adapter. If the battery is not installed and the USB adapter is connected, the phone will not operate properly due to prolonged power cycling. Also, removing the battery with the USB adapter connected may damage the device. Please unplug USB adapter before removing battery.

Warning! If the touch screen does not function while the phone's in the process of charging, this may be due to an unstable power supply. As a result, disconnect the USB cable from the device or unplug the USB adapter from the power outlet.

- 1 Connect the USB adapter and USB cable.

- 2 Plug the USB cable (as shown below) into the phone's Charger/Accessory Port.

NOTE: The battery must be fully charged initially to improve battery lifetime.

Inserting a microSD card

Insert a microSD™ card to use the camera and other multimedia features. Multimedia contents can be saved in the microSD card.

NOTE: This device supports up to a 32GB microSD card.



- 1 Turn the phone off before inserting or removing the microSD card. Remove the battery cover.



- 2 Then insert the microSD card into the slot. Make sure the gold contact area is facing upwards.

Removing the microSD card



To safely remove the microSD card from your phone, first you need to unmount it.

- 1 From the Home screen, tap **Apps**  > **Settings**  > **Storage** > **Unmount SD card** > **OK**.
- 2 Remove the battery cover and battery, then gently pull the microSD card from the slot.

Warning! Do not remove the microSD card without unmounting it first. Otherwise, it may damage the microSD card as well as your phone, and the data stored on the microSD card may be corrupted.

Formatting the microSD card

Warning! All files stored on your microSD card are deleted when you format the card.

- 1 From the Home screen, tap **Apps**  > **Settings**  > **Storage**.
- 2 Tap **Erase SD card** (twice).
- 3 If you set an unlock pattern, enter it and tap **Erase everything**. The card will then be formatted and ready to use.

NOTE: If there is content on your microSD card, the folder structure may be different after formatting since all the files will have been deleted.

Locking and unlocking the screen

If you do not use the phone for a while, the screen will be automatically turned off and locked. This helps to prevent accidental touches and saves battery power. When you are not using the your phone, press the **Power/Lock Key**  to lock your phone.

If there are any programs running when you lock your screen, they may be still running in Lock mode. It is recommended that you exit all programs before entering Lock mode to avoid unnecessary charges (e.g. phone calls, web access and data communications).

To wake up your phone, press the **Power/Lock Key** . The Lock screen will appear. Touch and slide the Lock screen in any direction to unlock your Home screen. The last screen you viewed will open.

Your Home screen

Touch Screen tips

Here are some tips on how to navigate on your phone.

Tap or touch – A single finger tap selects items, links, shortcuts and letters on the on-screen keyboard.

Touch and hold – Touch and hold an item on the screen by touching it and not lifting your finger until an action occurs. For example, to open a contact's available options, touch and hold the contact in the Contacts list until the context menu opens.

Drag – Touch and hold an item for a moment and then, without lifting your finger, move your finger on the screen until you reach the target position. You can drag items on the Home screen to reposition them.

Swipe or slide – To swipe or slide, quickly move your finger across the surface of the screen, without pausing when you first touch it (so you don't drag an item instead). For example, you can slide the screen up or down to scroll through a list, or browse through the different Home screens by swiping from left to right (and vice versa).

Double-tap – Double-tap to zoom on a webpage or a map. For example, quickly double-tap a section of a webpage to adjust that section to fit the width of the screen. You can also double-tap to zoom in and out after taking a picture (using the Camera), and when using Maps.

Pinch-to-Zoom – Use your index finger and thumb in a pinching or spreading motion to zoom in or out when using the browser or Maps, or when browsing pictures.

Rotate the screen – From many applications and menus, the orientation of the screen adjusts to the device's physical orientation.

NOTE:

- To select an item, touch the center of the icon.
- Do not press too hard; the touch screen is sensitive enough to pick up a light, yet firm touch.
- Use the tip of your finger to touch the option you want. Be careful not to touch any other keys.

Home screen

Simply swipe your finger to the left or right to view the panels. You can customize each panel with apps, downloads, widgets and wallpapers.

NOTE: Some screen images may be different depending on your phone provider.

On your Home screen, you can view menu icons at the bottom of the screen. Menu icons provide easy, one-touch access to the functions you use the most.



Touch the **Phone** icon to bring up the touch screen dialpad to make a call.



Touch the **Contacts** icon to open your contacts.



Touch the **Messaging** icon to access the messaging menu and create a new message.



Touch the **Browser** icon to access to the internet.



Touch the **Apps** icon to display all of your installed applications. To open any application, simply touch the icon in the applications list.

Customizing the Home screen

You can customize your Home screen by adding apps, downloads, widgets or wallpapers. For more convenience using your phone, add your favorite apps and widgets to the Home screen.

To add items on your Home screen:

- 1 Touch and hold the empty part of the Home screen.
- 2 Tap the **Apps, Downloads, Widgets** or **Wallpapers** tab.
- 3 Drag the desired item to the desired location and lift your finger.

To remove an item from the Home screen:

Touch and hold the icon you want to remove, drag it to , and lift your finger.



Your Home screen

TIP! To add an application icon to the Home screen from the Apps screen, touch and hold the application you want to add and drag it to the desired location.

TIP! Using folders

You can add several app icons in a folder. Drop one app icon over another one on a Home screen, and a folder will be created.

Returning to recently-used applications

- 1 Touch and hold the **Home Key** . The screen displays a pop-up containing the icons of applications you used recently.
- 2 Touch an icon to open the application. Or touch the **Back Key**  to return to your previous screen.

Notifications

Notifications alert you to the arrival of new messages, calendar events, and alarms, as well as to ongoing events, such as video downloads.

From the Notifications Panel, you can view your phone's current status and pending notifications.

When a notification arrives, its icon appears at the top of the screen. Icons for pending notifications appear on the left, and system icons showing things like Wi-Fi or battery strength on the right.

NOTE: The available options may vary depending on the region or service provider.

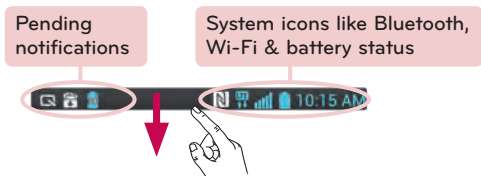

Swipe down for notifications & settings



Swipe the Status Bar down to open the Notifications Panel. To close the Notifications Panel, swipe the bar that is at the bottom of the screen upwards.

NOTE: Touch and hold an icon from the Quick Settings to view the function's settings menu.

Quick Settings

Use Quick Settings to easily toggle function settings like Wi-Fi, manage display brightness and more. The Quick Settings are located at the top of the Notifications Panel.

To rearrange Quick Setting items on the Notification Panel

Open the Notifications Panel and touch . You can then view and rearrange the desired items on the Quick Settings menu. To set more items to be displayed on the Notifications panel, touch .

Your Home screen













Indicator icons on the Status Bar

Indicator icons appear on the Status Bar at the top of the screen to report missed calls, new messages, calendar events, device status and more.



The icons displayed at the top of the screen provide information about the status of the device. The icons listed in the table below are some of the most common ones.

Icon	Description	Icon	Description
	No Micro SIM card		Vibrate mode
	No signal		Battery fully charged
	Airplane mode		Battery is charging
	Connected to a Wi-Fi network		Downloading data
	Wired headset		Uploading data

	Call in progress		GPS is acquiring
	Call hold		Receiving location data from GPS
	Missed call		Data is syncing
	Bluetooth is on		New Gmail
	NFC is on		New Google Talk message
	System warning		New message
	Alarm is set		Song is playing
	New voicemail		Phone is connected to PC via USB cable or USB tethering is active
	Ringer is silenced		Wi-Fi Direct activated
	Portable Wi-Fi hotspot is active		SmartShare on
	SmartShare music playing		

NOTE: The icons location in the Status Bar may differ according to the function or service.

On-screen keyboard

You can enter text using the on-screen keyboard. The on-screen keyboard appears automatically on the screen when you need to enter text. To manually display the keyboard, simply touch a text field where you want to enter text.

Using the keypad & entering text

 Tap once to capitalize the next letter you type. Double-tap for all caps.

 Tap to switch to the numbers and symbols keyboard.

 Tap to use the voice input function. You can also touch and hold this icon to select the handwriting and settings menu.

 Tap to enter a space.

 Tap to create a new line in the message field.

 Tap to delete the previous character.

Entering accented letters



The on-screen keyboard allows you to enter special characters (e.g. "á").

For example, touch and hold the desired key (for example, the "a" key). After the desired character appears, slide your finger over it and lift it off to enter it.

Google account setup

When you first turn on your phone, you have the opportunity to activate the network, to sign into your Google Account and select how you want to use certain Google services.

To set up your Google account:

- Sign into a Google Account from the prompted set-up screen.
OR
- From the Home screen, tap **Apps**  > **Apps** tab > **Settings**  > **Accounts & sync** > **ADD ACCOUNT** > **Google**.

If you have a Google account, touch **Existing**, enter your email address and password, then touch . Otherwise, touch **New** and enter the necessary information to create a new Google Account.

Once you have set up your Google account on your phone, your phone automatically synchronizes with your Google account on the Web.

Your contacts, Gmail messages, Calendar events and other information from these applications and services on the Web are synchronized with your phone. (This will depend on your synchronization settings.)

After signing in, you can use Gmail™ and take advantage of Google services on your phone.

Connecting to Networks and Devices

Wi-Fi



With Wi-Fi, you can use high-speed Internet access within the coverage of the wireless access point (AP). Enjoy wireless Internet using Wi-Fi, without extra charges.

Connecting to Wi-Fi networks

To use Wi-Fi on your phone, you need to access a wireless access point or 'hotspot'. Some access points are open and you can simply connect to them. Others are hidden or use security features; you must configure your phone to be able to connect to them. Turn off Wi-Fi when you're not using it to extend the life of your battery.

NOTE: If you are out of the Wi-Fi zone or have set Wi-Fi to **OFF**, additional charges may be applied by your mobile operator for mobile data use.

Turning Wi-Fi on and connecting to a Wi-Fi network

- 1 From the Home screen, tap **Apps**  > **Apps** tab > **Settings**  > **Wi-Fi** from the WIRELESS & NETWORKS.
- 2 Tap  to turn it on and start scanning for available Wi-Fi networks.
- 3 Tap **SEARCH** to see a list of active and in-range Wi-Fi networks.
 - Secured networks are indicated by a lock icon.
- 4 Touch a network to connect to it.
 - If the network is secured, you are prompted to enter a password or other credentials. (Ask your network administrator for details)
- 5 The Status Bar displays icons that indicate Wi-Fi status.

Bluetooth



You can use Bluetooth to send data by running a corresponding application, but not from the Bluetooth menu as on most other mobile phones.

NOTE:

- LG is not responsible for the loss, interception or misuse of data sent or received via the Bluetooth wireless feature.
- Always ensure that you share and receive data with devices that are trusted and properly secured. If there are obstacles between the devices, the operating distance may be reduced.
- Some devices, especially those that are not tested or approved by Bluetooth SIG, may be incompatible with your device.

Turning on Bluetooth and pairing up your phone with a Bluetooth device



You must pair your device with another device before you connect to it.

- 1 From the Home screen, tap **Apps**  > **Apps** tab > **Settings**  > **Bluetooth** from the WIRELESS & NETWORKS.
- 2 Tap  to turn Bluetooth on. You will see the option to make your phone visible and option to search devices. Then tap **Search for devices** to view the devices in range.
- 3 Choose the device you want to pair with from the list.

Once the pairing is successful, your device will connect to the device.

NOTE: Some devices, especially headsets or hands-free car kits, may have a fixed Bluetooth PIN, such as 0000. If the other device has a PIN, you will be asked to enter it.

Send data using the Bluetooth wireless feature



- 1 Open the item and tap .
OR
Touch and hold the item and select **Share**.
OR
Open the item and tap the **Menu Key**  > **Share**.
- 2 Tap **Bluetooth** to share via Bluetooth.

Connecting to Networks and Devices

NOTE: The method for selecting an option may vary by data type.

- 3 Search for and pair with a Bluetooth-enabled device.

Receive data using the Bluetooth wireless feature

- 1 From the Home screen, tap **Apps**  > **Apps** tab > **Settings**  > **Bluetooth**.
- 2 Tap  to turn Bluetooth on and mark the checkbox at the top of the screen to visible on other devices.



NOTE: To select the length of time that your device will be visible, tap the **Menu**  > **Visibility timeout**.

- 3 Pair the devices and tap **Pair** when you receive a Bluetooth Authorization Request to accept the file(s).

USB Tethering

You can use your phone to provide a data connection to a computer by activating data tethering and connecting the phone and computer with a USB cable.

To tether your phone with your computer using the USB



- 1 Connect your phone to your computer with a USB cable.
- 2 Tap **Apps**  > **Settings**  > **Tethering & Networks** > **USB tethering**. Tap  to turn it on.

NOTE:

- To use your phone's tethering capability, you must have the Smartphone Mobile Hotspot service added to your rate plan. Performance may vary depending on the number of devices connected and other factors.
- You cannot access your phone's microSD card on your computer when using USB tethering.

Smartphone Mobile Hotspots





You can also use your phone to provide a mobile broadband connection for up to 8 other devices. Create a hotspot and share your connection.

To create a portable hotspot, tap **Apps**  > **Settings**  > **Tethering & Networks** > **Mobile HotSpot**. A checkmark indicates that the function is active. Then tap **Configure Mobile HotSpot** and set a password upon first use.

NOTE: To use your phone's Hotspot capability, you must have the Smartphone Mobile Hotspot service added to your rate plan. In addition, your Smartphone Mobile Hotspot service cannot be used at the same time as Wi-Fi. Please close your WiFi connection prior to launching this service. Performance may vary depending on the number of devices connected and other factors. If you do not use a password, other unauthorized devices be able to use your Mobile Hotspot connection.

Enabling Wi-Fi Direct to share through SmartShare

Wi-Fi Direct automatically scans nearby Wi-Fi Direct devices and the searched devices are listed as they are found. This allows you to select a specific device to share multimedia data with through SmartShare.

- 1 From the Home screen, tap **Apps**  > **Apps** tab > **Settings**  > **Wi-Fi** from the WIRELESS & NETWORKS.
- 2 Tap  to turn it on and touch the **Menu Key**  > **Wi-Fi Direct**.
- 3 Select a device to connect with from the scanned device list.

CREATE GROUP – Touch to activate group owner mode, which enables the legacy Wi-Fi devices to connect by scanning your phone.



NOTE: When your phone becomes a group owner it will consume more battery power than when it is a client. The Wi-Fi Direct connection does not provide Internet service. As a result, additional costs may be incurred when connecting and using online services. Check data charges with your network provider.

Connecting to Networks and Devices

SmartShare

SmartShare uses DLNA (Digital Living Network Alliance) technology to share digital content through a wireless network. Both devices must be DLNA certified to support this feature.

To turn SmartShare on and allow sharing contents

- 1 From the Home screen, tap **Apps**  > **Apps** tab > **SmartShare** .
- 2 Touch the **Menu Key**  > **Settings**.
- 3 Touch **Contents share** to allow your device to be detected by other devices.
 - Select **Sharing requests** if you would like to select how to accept sharing requests from other devices. Choose from **Always accept**, **Always ask**, and **Always deny**.
 - Touch **Receive files** if you would like to allow the other devices to upload media files to my phone.

NOTE: Make sure that the microSD card is correctly mounted and the **Receive files** option in the Settings menu is checked.

- 4 Touch **Shared contents** to checkmark the types of content you would like to share.
Choose from **Photos**, **Videos**, and **Music**.
- 5 **SmartShare** is now activated and ready to share contents.

To control your renderer devices

Let your renderer device (e.g., TV) play multimedia contents from your remote content library (e.g., PC).







NOTE: Make sure that the DLNA functionality of your devices is properly configured (e.g., for TV and PC).

- 1 From the Home screen, tap **Apps**  > **Apps** tab > **SmartShare** .
- 2 Touch the **Player**  and select the device from the renderer device list.
- 3 Touch the **Library**  and select the device for the remote content library.

- 4 You can browse the content library.
- 5 Touch and hold a content thumbnail and touch Play or touch the **Menu Key**  > **Play**.

To share contents from your phone to your renderer device (e.g. TV)

NOTE: Make sure that your renderer device is properly configured.

- 1 While watching your pictures or videos using the Gallery application, touch  /  /  at the top of the screen.
 : Need to be connected to a network
 : Select the device in the network
 : Currently, the content is being shared through SmartShare.

NOTE: Follow the same steps to use the Music, Videos and Polaris Office 4 apps to share contents.





- 2 Select the device from renderer device lists to play the files.

NOTICE: Check that your device is connected with your home network using Wi-Fi connection to use this application.

Some DLNA enabled devices (e.g. TV) support only the DMP feature of DLNA and will not appear in the renderer device list.

Your device might not be able to play some contents.





To download contents from the remote content library

- 1 From the Home screen, tap **Apps**  > **Apps** tab > **SmartShare** .
- 2 Touch the **Library**  and select the device of the remote content library.
- 3 You can browse the content library.
- 4 Touch and hold a content thumbnail and then touch Download or touch the **Menu Key**  > **Download**.

Connecting to Networks and Devices

NOTICE: Some contents are not supported.





To upload contents to the remote content library

- 1 From the Home screen, tap **Apps**  > **Apps** tab > **SmartShare** .
- 2 Touch the **Library**  and select **My phone**.
- 3 You can browse the local content library to find the content(s) you want.
- 4 Touch and hold a content thumbnail and then touch Upload or touch the **Menu Key**  > **Upload**.
- 5 Select the device of the remote content library to be uploaded.

NOTICE: Some DLNA enabled devices do not support the DMS upload functionality and will not upload files. Some contents are not supported.

Calls

Making a call

- 1 From the Home screen, tap **Phone**  to open the keypad.
- 2 Enter the number on the keypad. To delete a digit, tap **Clear** .
- 3 Tap **Call**  to make a call.
- 4 To end a call, tap **End** .



TIP! To enter "+" to make international calls, touch and hold **0+**.

Calling your contacts



- 1 From the Home screen, tap **Contacts**  to open your contacts.
- 2 Scroll through the contact list or tap the **Search contacts** box and enter the first letter(s) of the contact you want to call. You can also tap a letter along the right side of the screen to access names starting with the chosen letter.
- 3 In the list that is displayed, tap the contact you want to call.
- 4 In the Contact Info screen, tap the phone number you wish to call.

Answering and rejecting a call

Locked screen

To answer an incoming call when the screen is locked, swipe **Answer**  in any direction. Swipe **Decline**  in any direction to decline an incoming call.

Unlocked screen

To answer an incoming call when the screen is unlocked, tap **Answer** . To decline the call, tap **Decline** .

Calls





TIP! Decline with message

You can send a message quickly using this function. This is useful if you need to reject a call with message during a meeting.

Adjusting the in-call volume



To adjust the in-call volume during a call, use the Volume Keys on the left side of the phone.

Making a second call

- 1 During your initial call, tap the **Menu Key**  and select **Add call**.
- 2 Dial the number or search your contacts.
- 3 Tap **Call**  to connect the call.
- 4 Both calls will be displayed on the call screen. Your initial call will be put on hold.
- 5 Tap the call entry on the screen to toggle between active calls or tap **Merge calls**  to merge the calls.
- 6 To end active calls, tap **End** . If there is no active call, it will end the call on Hold.

Ending a Call

Tap **End**  to end a call.

NOTE: To redial recent numbers, touch **Redial**  at the end of the call or find the number within the **Call logs** and tap **Call**  to the right of the entry.

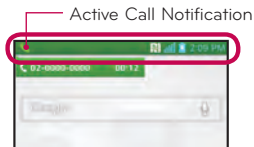

If you exit the current call screen and return to the Home screen, you will be notified that you are still on an active call by the green phone icon within the Status Bar.



Ending a Call from the Status Bar

- 1 Touch and drag the Status Bar down to open the Notifications Panel.
- 2 Tap **End call**  to end the currently active call.

Viewing your call logs



From the Home screen, tap **Phone** , then tap the **Call logs**  tab. View a complete list of all dialed, received, and missed voice calls.

TIP! Tap any single call log entry to view the date, time, and duration of the call.

TIP! Tap the **Menu Key** , then tap **Clear** to delete entries individually or **Clear all** to delete all.

Call settings

You can configure phone call settings, such as call forwarding, and other special features offered by T-Mobile.

- 1 From the Home screen, tap **Apps**  > **Settings** .
- 2 Tap **Call** and set any desired options.





Contacts

You can add contacts on your phone and synchronize them with the contacts in your Google Account or other accounts that support syncing contacts.

Searching for a contact

- 1 From the Home screen, tap **Contacts**  to open your contacts.
- 2 Tap the **Search contacts** box and enter the contact name using the keypad. You can also tap a letter along the right side of the screen to access names starting with the chosen letter.

Adding a new contact

- 1 From the Home screen, tap **Phone**  and enter the new contact's number.
- 2 Tap the **Menu Key**  > **Add to Contacts** > **Create new contact**. Select the desired account (if applicable).
- 3 If you want to add a picture to the new contact, tap . Choose from **Take photo** to take a picture using the camera or **Select from Gallery**. Then browse for an image and select it.
- 4 Tap  to enter more specific name information.
- 5 Enter the details about your contact.
- 6 Tap **Save** to save the contact entry.

Favorite Contacts

You can classify frequently called contacts as favorites.

To add a contact to your favorites



- 1 From the Home screen, tap **Contacts**  to open your contacts.
- 2 Tap a contact to view its details.
- 3 Tap the star to the right of the contact's name. The star turns gold and the contact is added to your favorites.

Contacts

To remove a contact from your favorites list

- 1 From the Home screen, tap **Contacts**  to open your contacts.
- 2 Tap the **Favorites** tab to view your favorite contacts.
- 3 Tap a contact to view its details.
- 4 Tap the gold star to the right of the contact's name. The star turns grey and the contact is removed from your favorites.

Creating a group

- 1 From the Home screen, tap **Contacts**  to open your contacts.
- 2 Touch the **Groups** tab, then touch the **Menu Key**  and select **New group**.
- 3 Enter a name for the new group. You can also set a ringtone for the group.
- 4 Touch **Save** to save the group.

NOTE: If you delete a group, the contacts assigned to that group will not be lost. They will remain in your contacts.



Messaging

Your phone combines text and multimedia messages into one intuitive, easy-to-use menu.

Conversation view

Messages exchanged with another party are displayed in chronological order so that you can conveniently see an overview of your conversations.

Sending a message

- 1 From the Home screen, tap **Messaging** , then tap **Compose**  to create a new message.
- 2 Enter a contact name or phone number in the **To** field. As you enter the contact name, matching contacts appear. You can tap a suggested recipient. You can also add multiple contacts.
- 3 Tap the text field to start entering your message.
- 4 Tap the **Menu Key**  to open the options menu. Choose from any of the available options.
- 5 Tap **Send** to send your message.

Warning! The 160-character limit may vary from country to country depending on how the text message is coded and the language used in the message.

Warning! If an image, video, or audio file is added to a text message, it will be automatically converted into a multimedia message and your service plan will be decremented accordingly.

NOTE: When you get a text message during a call, there will be an audible notification.

Messaging

Using smilies

Liven up your messages using smilies.

When writing a new message, tap the **Menu Key** , then tap **Insert smiley**.

Changing your message settings

Your phone's message settings are predefined, so you can send messages immediately. You can change the settings based on your preferences.

- From the Home screen, tap **Messaging**  > **Menu Key**  > **Settings**.

Email

You can use the Email application to read emails from services like Gmail. The Email application supports the following account types: POP3, IMAP and Exchange.

Your service provider or system administrator can provide you with the account settings you need.

Managing an email account

The first time you open the Email application, a set-up wizard opens to help you to set up an email account.

After the initial setup, Email displays the contents of your inbox. If you have added more than one account, you can switch among accounts.

To add another email account:

- Open the **Email** application and tap the **Menu Key**  > **Settings** > .

To change an email account's settings:

- Open the **Email** application and tap the **Menu Key**  > **Settings** > **General settings**.

To delete an email account:





- Open the **Email** application and tap the **Menu Key**  > **Settings** > touch 
> touch an account you want to delete > **Remove** > select **Yes**.

Working with account folders

Open the **Email** application and tap the **Menu Key**  and select **Folders**. Each account has an Inbox, Outbox, Sent and Drafts folder. Depending on the features supported by your account's service provider, you may have additional folders.

Composing and sending email

To compose and send a message

- 1 While in the Email application, tap **Write** .
- 2 Enter an address for the message's intended recipient. As you enter text, matching addresses will be proposed from your Contacts. Separate multiple addresses using semicolons.
- 3 Tap **Menu Key**  to add a Cc/Bcc and tap **Attach**  to attach files, if required.
- 4 Enter the subject and your message
- 5 Tap the **Send**  to send the message.

If you aren't connected to a network, for example, if you're working in airplane mode, the messages that you send will be stored in your Outbox folder until you connect to a network again. If it contains any pending messages, the Outbox will be displayed on the Accounts screen.

TIP! When a new email arrives in your Inbox, you will be notified by a sound or vibration. Tap the email notification to stop receiving notifications.

Camera

To open the Camera application, tap **Camera**  on the Home screen.

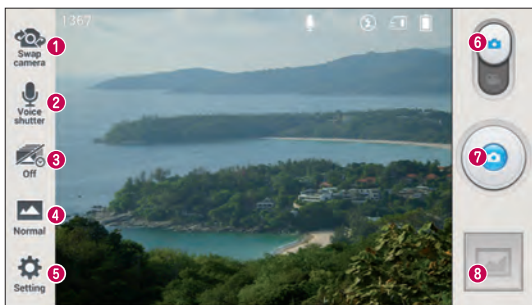

Getting to know the viewfinder













- 1 Swap camera** – Switch between the rear-facing camera lens and the front-facing camera lens.
- 2 Voice shutter** – To take a photo, say one of the following words: Cheese, Smile, Whisky, Kimchi or LG.
- 3 Time catch shot** – Touch this icon to capture the missing moment before pressing the shutter.
- 4 Shot mode** – Choose from **Normal**, **HDR**, **Panorama**, **Continuous shot** or **Portrait** +.
- 5 Settings** – Touch this icon to open the settings menu. See **Using the advanced settings** on the following page.
- 6 Mode switch** – Touch and slide down this icon to switch to video mode.
- 7 Capture** – Touch to capture a picture.
- 8 Gallery** – Touch to view the last photo you captured. This enables you to access your Gallery and view saved photos while in camera mode.

NOTE: Please ensure the camera lens is clean before taking pictures.

Using the advanced settings

In the viewfinder, tap  to open the advanced options. You can change the camera settings by scrolling through the list. After selecting the option, tap the **Back Key** .

	Touch if you want to change the viewfinder menu.
	Allows you to turn on the flash when taking a photo in dark conditions.
	Defines and controls the amount of sunlight entering the photo.
	Focuses on a specific spot.
	Selects photo resolution. If you choose high resolution, file size will increase, which means you will be able to store fewer photos in the memory.
	Finds the appropriate color and light settings for the current environment.
	The ISO rating determines the sensitivity of the camera's light sensor. The higher the ISO, the more sensitive the camera. This is useful in darker conditions when you cannot use the flash.
	Improves color quality in various lighting conditions.
	Applies artistic effects to your pictures.
	Sets a delay after the capture button is pressed. This is ideal if you want to be in the photo.
	Activate this to use your phone's location-based services. Take pictures wherever you are and tag them with the location. If you upload tagged pictures to a blog that supports geo tagging, you can see the pictures displayed on a map.

NOTE: This function is only available when the GPS function is active.



Selects a shutter sound.



Set the storage location for your pictures. Choose from Internal memory and SD card.

TIP!

- When you exit the camera, some settings return to their defaults, such as white balance, color effect, timer and scene mode. Check these before you take your next photo.
- The setting menu is superimposed over the viewfinder, so when you change photo color or quality elements, you will see a preview of the changed image behind the Settings menu.

Taking a quick photo

- 1 Open the **Camera** application.
- 2 Holding the phone horizontally, point the lens towards the subject you want to photograph.
- 3 A focus box will appear in the center of the viewfinder screen. You can also tap anywhere on the screen to focus on that spot.
- 4 When the focus box turns green, the camera has focused on your subject.
- 5 Touch  to capture the photo.

Once you've taken a photo

Touch  to view the last photo you took.



Touch to share your photo using the **SmartShare** function.



Touch to take another photo immediately.

Camera



Touch to send your photo to others or share it via social network services.



Touch to delete the photo.

TIP! If you have a social networking account and set it up on your phone, you can share your photo with your social networking community.

Touch the Menu Key  **to open all advanced options.**

Set image as – Touch to use the photo as a **Contact photo, Home screen wallpaper** or **Lock screen wallpaper**.

Move – Touch to move the photo to another place.

Copy – Touch to copy the selected photo and save it to another album.

Rename – Touch to edit the name of the selected photo.

Rotate left/right – To rotate left or right.

Crop – Crop your photo. Move your finger across the screen to select the area to be cropped.

Edit – View and edit the photo.



Applies a brightness effect to your photo.



Applies artistic effects to your photos.



Applies color effects to your photos.



Applies additional options to your photos.

Slideshow – Automatically shows you the images in the current folder one after the other.

Details – Find out more information about the contents.

Viewing your saved photos

You can access your saved photos when in camera mode. Just tap the image preview in the bottom of the screen and your Gallery will be displayed.

- To view more photos, scroll left or right.
- To zoom in or out, double-tap the screen or place two fingers and spread them apart (move your fingers closer together to zoom out).

Getting to know the viewfinder

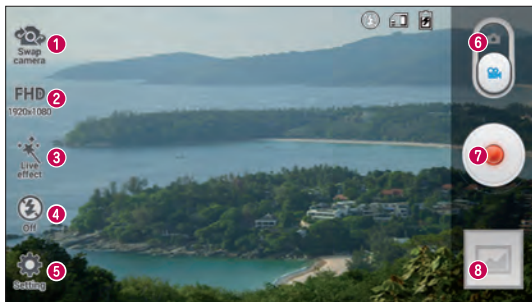







- 1 Swap camera** – Switch between the rear-facing camera lens and the front-facing camera lens.
- 2 Video size** – Touch to set the size (in pixels) of the video you are recording.
- 3 Live effect** – Live effect provides various visual effects when recording a video.
- 4 Flash** – Allows you to turn on the flash when taking a video in dark conditions.
- 5 Settings** – Touch this icon to open the settings menu. See **Using the advanced settings** on the following page.
- 6 Camera mode** – Touch and slide up this icon to switch to camera mode.
- 7 Record** – Touch to start recording a video.
- 8 Gallery** – Touch to view the last video you recorded. This enables you to access your Gallery and view your saved videos while in video mode.



TIP! When recording a video, place two fingers on the screen and pinch to use the Zoom function.

Using the advanced settings

Using the viewfinder, touch  to open all the advanced options.

	Touch if you want to change the viewfinder menu.
	Defines and controls the amount of sunlight entering the video.
	Improves color quality in various lighting conditions.
	Choose a color tone to use for your new view.
	Activate this to use your phone's location-based services.
	Set the storage location for your pictures. Choose from Internal memory and SD card.

Recording a quick video

- 1 Open the **Camera** application and touch the **Video mode** icon.
- 2 The video camera viewfinder appears on the screen.
- 3 Holding the phone, point the lens towards the subject you wish to capture in your video.
- 4 Touch  once to start recording.
- 5 A timer showing the length of the video will appear.
- 6 Touch  on the screen to stop recording.

NOTE: Touch  on the screen to take a picture while you're recording.

After recording a video

Touch  to view the last video you took.



Touch to share your video using the **SmartShare** function.



Touch to record another video immediately.



Touch to send your video to others or share it via social network services.



Touch to delete the video.

Watching your saved videos

- 1 In the viewfinder, touch the image preview in the bottom of the screen.
- 2 Your Gallery will appear on the screen.
- 3 Tap a video to play it automatically.

Adjusting the volume when viewing a video

To adjust the volume of a video while it is playing, use the Volume Keys on the left side of the phone.

LG Unique Functions

QuickMemo

The **QuickMemo** feature allows you to create memos and capture screen shots. Capture screens, draw on them, and share them with family and friends with QuickMemo.



- 1 Enter the QuickMemo screen by pressing both the Volume Keys for one second on the screen you want to capture. Or open the Notifications Panel and tap .

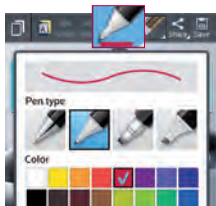
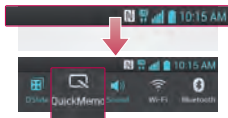

OR



- 2 Select the desired menu option from **Pen type**, **Color**, and **Eraser**. Then create a memo.

LG Unique Functions









- 3 Tap  in the Edit menu and select  to save the memo. To exit QuickMemo at any time, tap the **Back Key** .

NOTE: Please use a fingertip while using the QuickMemo. Do not use your fingernail.

Using the QuickMemo options

You can easily use the QuickMenu options when using the QuickMemo.

	Touch to keep the current memo on the screen and use the phone simultaneously.
	Selects whether to use the background screen or not.
	Allows you to undo and redo previous actions.
	Selects the pen type and the color.
	Erases the memo that you created.
	Touch to send your memo to others or share it via social network services.
	Saves the memo in the Gallery .

Viewing the saved QuickMemo

From the Home screen, tap **Apps**  > **Gallery**  and select the **QuickMemo** album.

Live Zooming

Live Zooming allows you to zoom in or zoom out on a portion of a video that is being played to make the desired scan appear larger or smaller.

When viewing the video, use your index finger and thumb in a pinching or spreading motion to zoom in or out.



NOTE:

- When in video playback mode, slide the screen up or down to adjust the screen brightness.
- When in video playback mode, slide the screen left or right to rewind or fast-forward.

NOTE: Do not to press too hard; the touch screen is sensitive enough to pick up a light, but firm touch.

LG Unique Functions

QSlide

The **QSlide** function enables an overlay on your phone's display for easy multi-tasking.



1		Tap to exit the QSlide function and return to full window.
2		Slide to adjust transparency.
3		Tap to exit the QSlide function.

NOTE: The QSlide function can support up to two windows at the same time.

- 1 Open the Notifications Panel and tap the desired app from the **QSlide apps** section.

OR

While using an application that supports QSlide, tap . The function will be displayed continuously as a small window on your screen.

- 2 Slide to adjust the transparency level.

QuickTranslator

Simply aim the camera of your smart phone at the foreign sentence you want to understand. You can get the real-time translation anywhere and anytime.

You can buy additional dictionaries for offline translation from the Google Play Store.



- 1 Home language
- 2 Destination language
- 3 Translation of word
- 4 Translation of sentence
- 5 Translation of block
- 6 Flash

- 1 Touch  > **Apps** tab > **QuickTranslator**.
- 2 Touch **Word**, **Line** or **Block**.
- 3 Touch and select the desired language.
- 4 Hold the phone toward the subject you want to translate for a few seconds.

NOTE: Only one dictionary is provided free of charge. Additional dictionaries must be purchased. Please select from the list below the dictionary you would like to install as your complimentary dictionary.

NOTE: There may be a difference in the rate of recognition depending on the size, font, color, brightness and angle of the letters that need to be translated.

LG Unique Functions





VuTalk

Use the VuTalk to create notebook contents using real-time interactive handwriting and shared emotional conversations.

NOTE:

- Additional charges may be applied for data services when using VuTalk.
- Connect a device preloaded available VuTalk feature to use VuTalk.
- You can use only VuTalk when connecting data network, furthermore during a call.
- Please be careful that the screen may be looked, if you input nothing for a period of time.

Registering VuTalk

- 1 From the Home screen, tap .
 - 2 Tap  to agree terms and conditions.
- Once you register the VuTalk service, you can set up tapping .
 - You can also register the VuTalk service tapping  during a call screen.

Contacts screen

Registering the VuTalk service

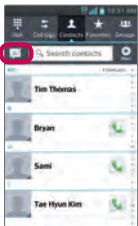

Call screen



- **Befor registering the VuTalk service:** Register the VuTalk service.
- **After registering the VuTalk service:** Run the VuTalk feature.

Using VuTalk

1 Select VuTalk user from the contacts.

- If you tap,  you can display only VuTalk user.

2 Tap  from the detail contacts screen.

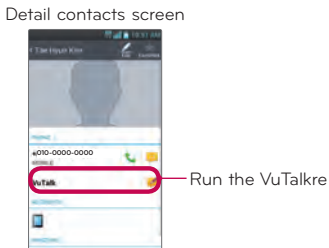
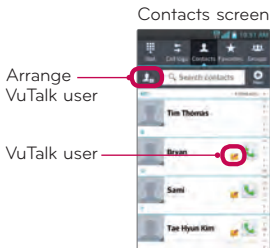

VuTalk agreement screen

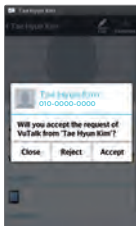

VuTalk request screen

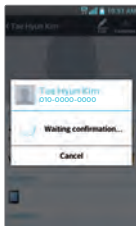

- Tap  to attach image, photographic, place, sticker.

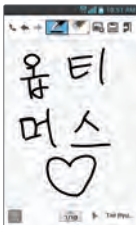

LG Unique Functions

A example of use 1



A example of use 2







3 Tap  or  to end VuTalk feature.

- VuTalk saved Notebook contents when ending VuTalk feature.
- Tap  to end VuTalk feature because Vutalk is still running when the screen is changed the Home screen tapping Home key.

LG Tag+

LG Tag+ lets you customize NFC tags with the settings you prefer.

- 1 From the Home screen, tap **Apps**  > **LG Tag+** .
- 2 Tap .
- 3 Enter a name for the tag and tap **OK**.
- 4 Tap an action to add it to the tag and configure the setting.
- 5 Then tap  to add more actions.
- 6 When you're finished, tap **Write on NFC tag**.
- 7 Hold your phone to a blank tag and the tag will be written.

Gallery

You can store multimedia files in internal memory for easy access to all your multimedia files. Use this application to view multimedia files like pictures and videos.

- 1 From the Home screen, tap **Apps**  > **Apps** tab > **Gallery** .

You can manage and share all your image and video files with Gallery.

NOTE:

- Some file formats are not supported, depending on the software installed on the device.
- Some files may not play properly, depending on how they are encoded.

Viewing pictures

Launching Gallery displays your available folders. When another application, such as Email, saves a picture, the download folder is automatically created to contain the picture. Likewise, capturing a screenshot automatically creates the Screenshots folder. Tap a folder to open it.

Pictures are displayed by creation date in a folder. Select a picture to view it full screen. Scroll left or right to view the next or previous image.

Zooming in and out

Use one of the following methods to zoom in on an image:

- Double-tap anywhere to zoom in. Double-tap again to return to fullscreen view.
- Spread two fingers apart on any place to zoom in. Pinch in to zoom out.

Playing videos

Video files show the  icon in the preview. Select a video and tap  to play it.



Multimedia

Viewing photo and video options

When viewing a photo or video, tap the **Menu Key**  and use the advanced editing options.

Deleting images and videos

Use one of the following methods:

- In a folder, tap  and select the photos and videos you want to delete, then tap **Delete**.
- When viewing a photo or video, tap .



Setting as wallpaper

When viewing a photo, touch the **Menu Key**  > **Set image as** and select **Contact photo**, **Home screen wallpaper** or **Lock screen wallpaper**.



NOTE:









- Some file formats are not supported, depending on the device software.
- If the file size exceeds the available memory, an error can occur when you open files.

Videos

Your phone has a video player that lets you play all of your favorite videos. To access the video player, from the Home screen tap **Apps**  > **Apps** tab > **Videos** .

Playing a video



- 1 From the Home screen, tap **Apps**  > **Apps** tab > **Videos** .
- 2 Select the video you want to play.

	Touch to pause video playback.
	Touch to resume video playback.
	Touch to go 10 seconds forward.
	Touch to go 10 seconds backward.
	Touch to manage the video volume.
	Touch to change the ratio of the video screen.
	Touch access QSlide and display the video in small window.
	Touch to share your video via the SmartShare function.
	Touch to lock the window.

To change the volume while watching a video, press the Volume Keys on the left side of the phone.

Touch and hold a video in the list to access the following options: **Share**, **Trim**, **Delete** and **Details**.

Music

Your phone has a music player that lets you play all your favorite tracks. To access the music player, from the Home screen, tap **Apps**  > **Apps** tab > **Music** .

Add music files to your phone

Start by transferring music files to your phone:

- Transfer music using Media sync (MTP).



Multimedia

- Download from the wireless Web.
- Synchronize your phone to a computer.
- Receive files via Bluetooth.

Transfer music using Media sync (MTP)

- 1 Connect the phone to your PC using the USB cable.
- 2 Select the **Media sync (MTP)** option. Your phone will appear as another hard drive on your computer. Click on the drive to view it. Copy the files from your PC to the drive folder.
- 3 When you're finished transferring files, swipe the Status Bar down and touch **USB connected > Charge only**. You may now safely unplug your device.

Playing a song

- 1 From the Home screen, tap **Apps**  > **Apps** tab > **Music** .
- 2 Touch the **Songs** tab.
- 3 Select the song you want to play.



Touch to find the files with YouTube



Touch to share your music via SmartShare function.



Touch to set shuffle mode



Touch to set repeat mode



Touch to manage the music volume







Touch to pause playback



Touch to resume playback



Touch to skip to the next track on the album or in the playlist

	Touch to go back to the beginning of the song. Touch twice to return to the previous song
	Touch to set the current song as a favorite
	Touch to see the current playlist
	Touch to set the audio effect.

To change the volume while listening to music, press the Volume Keys on the left side of the phone.

Touch and hold any song in the list to access the following options: **Play**, **Add to playlist**, **Share**, **Set as ringtone**, **Delete**, **Details** and **Search**.

NOTE:



- Some file formats are not supported, depending on the device software.
- If the file size exceeds the available memory, an error can occur when you open files.

NOTE: Music file copyrights may be protected by international treaties and national copyright laws.

Therefore, it may be necessary to obtain permission or a licence to reproduce or copy music.









In some countries, national laws prohibit private copying of copyrighted material. Before downloading or copying the file, check the national laws of the relevant country concerning the use of such material.

Setting your alarm





- 1 From the Home screen, tap **Apps**  > **Apps** tab > **Alarm/Clock**  > .
- 2 Set the desired alarm time.
- 3 Set **Repeat**, **Snooze duration**, **Vibration**, **Alarm sound**, **Alarm volume**, **Auto app starter**, **Puzzle lock** and **Memo**.
- 4 Touch **Save**.

NOTE: To change alarm settings in the alarm list screen, touch the **Menu Key**  and select **Settings**.

Using your calculator

- 1 From the Home screen, tap **Apps**  > **Apps** tab > **Calculator** .
- 2 Touch the number keys to enter numbers.
- 3 For simple calculations, touch the function you want to perform (, ,  or ) followed by .
- 4 For more complex calculations, touch the **Menu Key** , select the **Advanced panel**, then choose the desired function.
- 5 To view the calculation history, tap .



Adding an event to your calendar

- 1 From the Home screen, tap **Apps**  > **Apps** tab > **Calendar** .
- 2 Tap  to change the calendar view (Day, Week, Month, Agenda).
- 3 Tap on the date for which you wish to add an event and tap .
- 4 Touch the **Event name** field and enter the event name.
- 5 Touch the **Location** field and enter the location. Check the date and enter the time you wish your event to start and finish.

- 6 If you wish to add a note to your event, touch the **Description** field and enter the details.
- 7 If you wish to repeat the alarm, set **REPEAT** and set **REMINDERS**, if necessary.
- 8 Touch **Save** to save the event in the calendar.

Lookout Security



Lookout™ offers you mobile device security features that have little effect on your phone's overall performance. Lookout Mobile Security gives you key security options that are special to the mobile market. In addition to antivirus and anti-malware technology, there is also a lost and stolen phone locator service, an application privacy adviser, and a backup service.

- 1 From the Home screen, tap **Apps**  > **Lookout Security** .
- 2 Read the on-screen descriptions and tap **Activate Lookout** to begin the configuration process.
- 3 Read the on-screen Security information and if needed, tap the **Enable Security** box to activate this feature.
- 4 Tap **Next**.
- 5 Read the on-screen information about Backup and if desired, tap the **Enable Backup** box to activate the feature.
- 6 Tap **Next**.
- 7 Read the Mobile Threat Network information and if desired, tap the **Enable the Mobile Threat Network** box to enable this feature.
- 8 Tap **Next**.
- 9 Read the on-screen information about the feature that can aid in locating your missing phone and if needed, tap **New user** (to setup a new account) or **Existing user** (to log into your account field to activate the feature).
- 10 Tap **Start Lookout**.

From the main application, the features are shown as buttons. Touch one to show a button that will run the feature.

T-Mobile TV



This application lets you watch live TV and Video on Demand on your phone.

- 1 From the Home screen, tap **Apps**  > **T-Mobile TV** . The T-Mobile Terms and Conditions page will be shown.
- 2 Tap **Accept** if you accept the Terms and Conditions.
OR
Tap **Exit** to close the application.
- 3 Set your location settings.
- 4 Tap any of the available categories to begin viewing.

NOTE: T-Mobile TV must be configured over network before first use. 30-days free offer is available for a limited time and subject to change. Unsubscribe during the first 30 days to avoid any charges; access to free content will remain available. See T-Mobile TV app for details. Qualifying data plan and/or Wi-Fi connection required.

T-Mobile Name ID

Lets you modify the on-screen Caller ID information. Name ID identifies unknown callers by Name, City, and State.

- 1 From the Home screen, tap **Apps**  > **T-Mobile Name ID** .
- 2 Choose an on-screen option.





File Manager

The **File Manager** application allows you to manage files in your internal/ external storage.

To open the File Manager application

- From the Home screen, tap **Apps**  > **File Manager** .

File Manager Options



- : Allows you to create a new folder.
- : Allows you to move files and folders to another folder.
- : Allows you to delete files and folders.
- : Allows you to search for files.

Tap the **Menu Key**  to access the following options.

- **Sort by:** Allows you to sort files and folders by Name, Size, Date, and Type.
- **View by:** Allows you to change the view mode to List or Grid.
- **Copy:** Allows you to copy files and folders and paste them in another location.
- **Share:** Allows you to share files and folders with others.
- **Upload:** Allows you to upload files to online storage.
- **Zip:** Allows you to compress files and folders into a .zip file.
- **Exit:** Allows you to exit the application.

Application Manager

You can manage your programs with Application Manager.

- 1 From the Home screen, tap **Apps**  > **Application Manager** .
- 2 The **Application Manager** lists your installed apps along with their size and version.
- 3 Tap **Uninstall** to uninstall the app, then tap **OK** to confirm.



Application Manager Settings

To adjust the Application Manager settings, tap the **Menu Key**  and select **Settings**. The following settings are available.

- **Update notification cycle:** Allows you to set the notification cycle for app updates.
- **Auto app update:** Automatically updates apps if available.
- **Update over Wi-Fi only:** Updates apps only via Wi-Fi.

Visual Voicemail

The **Visual Voicemail** application allows users to view a list of people who left voicemail messages on your phone. You can listen to your message without being limited by the date.

- 1 From the Home screen, tap **Apps**  > **Visual Voicemail** .
- 2 A list of the voicemail messages will be displayed.

Important! If this is the first time accessing Visual Voicemail, you may be prompted to enter a new PIN code and touch **Next** to activate Visual Voicemail.





NOTE: To use your phone's Visual Voicemail capability, you must have the Visual Voicemail service added to your rate plan.

- 3 Tap an on-screen voicemail message to play it back.

Voice Recorder

Use the voice recorder to record voice memos or other audio files.

Recording a sound or voice

- 1 From the Home screen, tap **Apps**  > **Apps** tab > **Voice Recorder** .
- 2 Touch  to begin recording.
- 3 Touch  to end the recording.
- 4 Touch  to listen to the recording.

NOTE: Touch  to access your list of recordings. You can listen to the saved recordings. The available recording time may differ from actual recording time.

Sending the voice recording

- 1 Once you have finished recording, you can send the audio clip by touching .
- 2 Choose from any of the available methods for sharing.

Task Manager

You can manage your applications using Task Manager. You can easily check the number of applications that are currently running and shut down certain applications.

Task Manager Options

- Touch **Stop** to stop individual apps.
- Tap **Stop all** to stop all currently running apps.
- Tap the **Menu Key**  to access help information, sorting options, and advanced settings.

Polaris Viewer 4

Polaris Viewer 4 is a professional mobile office solution that lets users conveniently view various types of office documents, including Word, Excel and PowerPoint files, anywhere or anytime, using their mobile devices.



From the Home screen, tap **Apps**  > **Apps** tab > **Polaris Viewer 4** .

Viewing files

Mobile users can now easily view a wide variety of file types, including Microsoft Office documents and Adobe PDF, right on their mobile devices. When viewing documents using Polaris Viewer 4, the objects and layout remain the same as in the original documents.

FileShare

This feature allows you to share files from your phone.

- 1 From the Home screen, tap **Apps**  > **Apps** tab > **FileShare** .
- 2 Choose the types of content you would like to share. Choose from **Images**, **Videos**, **Music** and **Documents**.
- 3 Tap **Send file**  in the upper right corner of the screen, then checkmark the file(s) you want to share.

Utilities

- 4 Tap **Send** at the bottom of the screen to begin scanning for available devices, then select the device you want from the list.
- 5 Tap **Send** at the bottom of the screen to use the selected device to send your file(s).

LG Backup

About backing up and restoring smartphone data

It is recommended that you regularly create and save a backup file on the internal storage, especially before updating any software. Maintaining a current backup file in storage memory may allow you to recover smartphone data if your smartphone is lost, stolen, or corrupted by an unforeseen issue.

This LG Backup application is supported between LG smartphones, other S/W or OS versions. As a result, when you buy the new LG smartphone, you can backup the current phone data to your new phone.



If you have the Backup application preloaded on your smartphone, you can backup and restore most of your smart phone data, including downloaded and pre-installed applications, bookmarks, calendar entries, call logs, contacts, home screen settings, messages, and system settings. You may also:

- Perform a manual LG Backup of your smartphone data.
- Schedule automatic backups of your smartphone data.
- Restore your smartphone data.

NOTE: Please note that the Backup function does not support the backup of User data & Media data (Picture/Video/Music). Please backup those files using the Media sync (MTP). Connect your phone to your computer using a USB cable and touch Media sync (MTP).



Warning! To protect against unexpected shutoff during backup or restore operations, due to insufficient battery power, you should always keep your battery fully charged.

LG Backup your smart phone data

- 1 From the Home screen, tap **Apps**  > **Apps** tab > **LG Backup**  > **Manual backup** > **Internal storage** or **SD card**.
- 2 Touch **New backup** to enter a name for your backup file and select **Next**.
- 3 Select the check box next to the item you want to backup and select **LG Backup** to backup.
- 4 When all selected files have been backed up, you will see the message **Backup complete**.



Scheduling automatic backups

You can also program automatic backups for the data on your smartphone according to your schedule setting. To do this, complete the following steps:

- 1 From the Home screen, tap **Apps**  > **Apps** tab > **LG Backup**  > **Auto backup**.
- 2 On the Backup Location screen, touch **Internal storage** or **SD card**.
- 3 Enter a name for your backup file and select **Next**.
- 4 Select the check box next to the data you want to backup, and select **Next**.

Restoring smartphone data

NOTE: All files that are stored on your smart phone are deleted before the backup file is restored.

- 1 From the Home screen, tap **Apps**  > **Apps** tab > **LG Backup**  > **Restore**.
- 2 On the **Restore** screen, select a backup file that contains the data you wish to restore.
- 3 Select the check box next to the item you wish to restore and select **Restore** to restore it to your phone.

Utilities

NOTE: Please note that your phone data will be overwritten with the content of your backup.

- 4 If the backup file is encrypted, type the password that you created to encrypt it.
- 5 When all selected files have been restored, the phone will automatically be restart.

NOTE: You can set Enable encryption to encrypt your backup files for extra protection.

Touch  from the **LG Backup** screen, and enter a password and hint in case you forgot your password. Once you have set up a password, you need to enter it every time you want to do backup/restore.

Google+



Use this application to stay connected with people via Google's social network service.

From the Home screen, tap **Apps**  > **Apps** tab > **Google+** .

NOTE: This application may not be available depending on the region or service provider.

Voice Search

Use this application to search webpages using voice.

- 1 From the Home screen, tap **Apps**  > **Apps** tab > **Voice Search** .
- 2 Say a keyword or phrase when **Speak now** appears on the screen. Select one of the suggested keywords that appear.

NOTE: This application may not be available depending on the region or service provider.

Downloads



Use this application to see what files have been downloaded.

From the Home screen, tap **Apps**  > **Apps** tab > **Downloads** .

NFC

NFC (Near Field Communication) is a wireless technology that enables data transmission between two objects when they are brought within a few inches of each others. When you enable NFC on your phone, your phone can exchange data with other NFC-enabled devices or read information from smart tags embedded in posters, stickers, and other products.

To turn on NFC:

- 1 From the Home screen, tap the **Menu Key**  > **All settings**.
- 2 Tap **Share & Connect** and tap the **NFC switch** .

Direct/Android Beam

When this feature is turned on, you can beam app content to another NFC-capable device by holding the devices close together. For example, you can beam Browser pages, YouTube videos, contacts, Polaris Office 4 files, and more. Just bring the devices together (typically back to back) and then touch your screen. The app determines what gets beamed.

To activate Direct/Android Beam:

From the Home screen, tap the **Menu Key**  > **All settings** > **Share & Connect** > **Direct/Android Beam** .

NOTE: You must enable NFC to activate Direct/Android Beam.

File networking

File Networking requires wireless connection. Make sure that devices are using same AP(Access Point). Network folder sharing may use more battery.

To share my folder:

- 1 From the Home screen, tap the **Menu Key**  > **All settings**.
- 2 Select the **Networks** tab.
- 3 Tap **Share & Connect** > **File networking**.
- 4 Tap **Share my folder** to share your phone's folder with other devices.
- 5 Tap **Shared folder** to configure the folder to share.
- 6 Tap **Set password** to configure password for security.
- 7 Access phone's folder with typing "\\ \ Device name" or "\\ \IP address" at URL address field on PC window.

To access other device's folder:

- 1 From the Home screen, tap the **Menu Key**  > **All settings**.
- 2 Select the **Networks** tab.
- 3 Tap **Share & Connect** > **File networking** > **Access other device folder**.
- 4 Tap a device to connect with in the **AVAILABLE DEVICES**. If the device is secured with password, you should enter User name and password. You can access folder without User name or password if computer's shared folder is set as 'Everyone'.
- 5 Select the folders to access. This may take a few seconds depending on the size of shared folders.
- 6 After connecting devices, you can read or write shared file from other devices in phone's applications (such as Gallery, Music, File manager). Check the following mount path: /sdcard/Network_folder_"Device Name".

TIP: To view help information about using this feature, tap the **Menu Key**  > **Help**.

The Web

Browser







Use this application to browse the Internet. Browser gives you a fast, full-color world of games, music, news, sports, entertainment and much more, right on your mobile phone wherever you are and whatever you enjoy.

NOTE: Additional charges apply when connecting to these services and downloading content. Check data charges with your network provider.

From the Home screen, tap **Apps**  > **Apps** tab > **Browser** .

Using the Web toolbar



Touch and hold the Web toolbar and slide it upwards with your finger to open.

	Touch to go back one page.
	Touch to go forward one page, to the page you connected to after the current one. This is the opposite of what happens when you touch the Back Key  , which takes you to the previous page.
	Touch to go to the Home page.
	Touch to add a new window.
	Touch to access bookmarks.

Viewing webpages

Tap the web address field, enter the web address and tap **Go**.

Opening a page

- To open a new page, tap  on the Browser toolbar.
- To go to another webpage, tap , scroll up or down, and tap the page to view it.



The Web

Searching the web by voice



Tap the web address field, tap , speak a keyword, and then select one of the suggested keywords that appear.

NOTE: This feature may not be available depending on the region or service provider.



Bookmarks

- To bookmark the current webpage, tap the **Menu Key**  > **Save to bookmarks**. Enter the desired information and tap **OK**.
- To open a bookmarked webpage, tap  on the Browser toolbar and select one.

History

Tap  on the Browser toolbar and select the **History** tab to open a webpage from the list of recently-visited webpages. To clear the history, tap the **Menu Key**  > **Clear all history**.

Using QSlide

Use this feature to access the Internet without closing the current application. While viewing content on the Browser, tap . You can then browse other information on your phone. To view the browser in full screen, tap . To close the browser, tap .

Chrome



Use Chrome to search for information and browse webpages. From the Home screen, tap **Apps**  > **Apps** tab > **Chrome** .

NOTE: This application may not be available, depending on your region and service provider.

Viewing webpages

Tap the web address field, and then enter a web address or search criteria.

Opening a page

- To go to a new page, tap  > **New tab**.
- To go to another webpage, tap , scroll up or down and tap the page to select it.

Searching the web by voice



Tap the address field, tap , speak a keyword and select one of the suggested keywords that appear.

Syncing with other devices

Sync open tabs and bookmarks to use with Chrome on another device when you are logged in with the same Google account.

To view open tabs on other devices, tap the **Menu Key**  > **Other devices**. You must be signed in to the same Google account on all devices. Select a webpage to open.

Viewing bookmarks

To add bookmarks, tap the **Menu Key**  > .

Settings

Access the Settings menu

From the Home screen, tap **Apps**  > **Apps** tab > **Settings** .

OR

From the Home screen, tap the **Menu Key**  > **System settings**.

1 Select a setting category and select an option.

WIRELESS & NETWORKS

< Airplane mode >

Tap the **Airplane mode** switch  to toggle between On and Off. Activating Airplane mode disables all wireless connections.

< Wi-Fi >

Wi-Fi – Turns on Wi-Fi to connect to available Wi-Fi networks.

TIP! How to obtain the MAC address

To set up a connection in some wireless networks with MAC filters, you may need to enter the MAC address of your phone in the router.

You can find the MAC address in the following user interface: From the Home screen, tap **Apps**  > **Settings**  > **Wi-Fi** > **Menu Key**  > **Advanced** > **MAC address**.

< Bluetooth >

Turn the Bluetooth wireless feature on or off to use Bluetooth.

< Mobile data >

Displays the data usage and set mobile data usage limit.

< Call >

Configure phone call settings such as call forwarding and other special features offered by your carrier.

Fixed dialing numbers – Turn on and compile a list of numbers that can be called from your phone. You'll need your PIN2, which is available from your operator. Only numbers within the fixed dial list can be called from your phone.

Voicemail – Allows you to select your carrier's voicemail service.

Incoming call popup – Display incoming call popup when using camera and videos.

Call reject – Allows you to set the call reject function. Choose from **Call reject mode** or **Rejection list**.

Decline with message – When you want to reject a call, you can send a quick message using this function. This is useful if you need to reject a call during a meeting.

Connection vibration – Vibrates your phone when the other party answers the call.

Privacy keeper – Hides the caller name and number for an incoming call.

Power button ends call – Allows you to end calls by pressing the Power/Lock Key instead of the End button on your screen.

TTY mode – Opens a dialog box to set TTY mode to communicate with other TTY devices.

Hearing aids – Checkmark enables hearing aid compatibility.

Call forwarding – Choose whether to divert all calls when the line is busy, when there is no answer or when you have no signal.

Wi-Fi Calling

Important!

Wi-Fi Calling requires that you use the SIM card that is shipped with your phone. Also, you must register your address for 9-1-1. Wi-Fi Calling will not work until you have registered for 9-1-1 by logging into your account at www.T-Mobile.com. Go to your profile and click **Customer Info** and continue on to enter your address.

About Wi-Fi Calling

Wi-Fi Calling can improve your coverage and allows you to make phone calls and send messages over a Wi-Fi network (when a Wi-Fi network is available). Unless your rate plan provides otherwise, Wi-Fi Calling minutes count the same as T-Mobile cellular calling minutes on your phone bill.

- To use Wi-Fi Calling, you must first turn on Wi-Fi, connect to a Wi-Fi network, and then turn on Wi-Fi Calling.

Settings

- When the Wi-Fi Calling feature is on, your phone displays the **Wi-Fi Calling** icon on the Status Bar.
- To stay on a Wi-Fi call, you must remain within range of the Wi-Fi network. Your call will drop as you leave the Wi-Fi range. When your Wi-Fi signal weakens, your phone will beep and display a warning message alerting you that your call will drop if the signal gets weaker.

Wi-Fi Calling offers three connection options:

- **Wi-Fi Preferred:** All calls are made over an available Wi-Fi network. If there are no available Wi-Fi networks calls are made over the cellular network.
- **Cellular Network Preferred:** All calls are made over the cellular network unless the cellular network is not available, then calls are made over an available Wi-Fi network.
- **Never use Cellular Network:** All calls are made over an available Wi-Fi network. If there are no available Wi-Fi networks, your calls will not connect.

Call barring – Lock incoming, outgoing or international calls.

Call duration – View the duration of calls including Last call, All calls, Dialed calls and Received calls.

Voice clarity – Enhance voice sound quality in noisy environment.

Additional settings – Allows you to change the following settings:

Caller ID: Choose whether to display your number in an outgoing call.

Call waiting: If call waiting is activated, the handset will notify you of an incoming call while you are on a call (depending on your network provider).

< Share & Connect >

Allows you to share folders with other devices via wireless connection.

< Tethering & Networks >

USB tethering - Allows you to set up the ability to share your phone's mobile data connection using a USB connection.

Mobile HotSpot - Allows you to share mobile network via Wi-Fi and you can configure portable Wi-Fi hotspot settings.

Help - Help for USB tethering and Mobile Hotspot.

Wi-Fi Calling - Refer to previous page for Wi-Fi calling.

VPN – Displays the list of Virtual Private Networks (VPNs) that you've previously configured. Allows you to add different types of VPNs.

NOTE: You must set a lock screen PIN or password before you can use credential storage.

Mobile networks – Set options for data roaming, network mode & operators, access point names (APNs) etc.

DEVICE

< Sound >

Quiet mode – Tap the **Quiet mode switch**  to enable this function. Tap **Quiet time** to open a screen to set the days and times to automatically turn off all sounds except for alarms and media.

Sound profile – Choose the Sound, either Vibrate only or Silent.

Volumes – Manage the volume of Phone ringtone, Notification sound, Touch feedback & system, Music, video, games and other media.

Ringtone with vibration – Vibration feedback for calls and notifications.

Phone ringtone – Allows you to set your default incoming call ringtone.

Notification sound – Allows you to set your default notification ringtone.

Gentle vibration – Gradually increasing vibration up to current strength set.

Vibrate strength – Set vibrate strength for calls and notifications.

Incoming call vibration – Allows you to choose the type of vibration for incoming calls.

Dial pad touch tones – Allows you to set the phone to play tones when using the dialpad to dial numbers.

Touch sounds – Allows you to set your phone to play a sound when you touch buttons, icons and other onscreen items that react to your touch.

Screen lock sound – Allows you to set your phone to play a sound when locking and unlocking the screen.

Vibrate on touch – Allows you to set the vibration feedback when the phone screen is touched.

Settings

< Display >

Brightness – Adjust the screen brightness.

Screen timeout – Set the time for screen timeout.

Auto-rotate screen – Set to switch orientation automatically when you rotate the phone.

Font type – Change the type of display font.

Font size – Change the size of the display font.

Smart screen – Keep screen on when device detects your eyes looking at the screen.

Front touch key light – Set the front key light duration.

Home button LED – LED light around the Home button is controlled by your selections.

< Home screen >

Theme – Sets the screen theme for your device.

Screen swipe effect – Sets the effect when you swipe to change screens.

Wallpaper – Sets the wallpaper to use on your Home screen.

Scroll screens circularly – Checkmark to set the Home screens to scroll continuously, eliminating the need to scroll back in the opposite direction when you reach one end.

Portrait view only – Checkmark to always display the Home screen in portrait view.

Home backup & restore – Allows you to backup and restore app and widget configurations and themes.

< Lock screen >

Select screen lock – Set a screen lock type to secure your phone. Choose from **None, Swipe, Face Unlock, Pattern, PIN** or **Password**.

Wallpaper – Select the wallpaper for your lock screen from Gallery or Wallpaper gallery.

Clocks & shortcuts – Customize clocks and shortcuts on the lock screen.

Screen effect – Select the screen effect.

Owner info – Show owner info on the lock screen.

Lock timer – Set the lock time after screen timeout.

Power button instantly locks – Set the screen lock when the power button is pressed.

Vibrate on touch – Allows you to set the vibration feedback for phone screen touch.

< **Storage** >

INTERNAL STORAGE - Displays the total amount of space in the phone's memory and lists what type of data is using up space.

SD CARD - Displays the total amount of memory space on the microSD card.

Mount/Unmount SD card - Mounts and unmounts the microSD card from your phone so that you can access the data stored in it, format the card, or safely remove it. This setting is dimmed if there's no microSD card installed, if you've already unmounted it, or if you've mounted the microSD card on your computer.

Erase SD card - Permanently erases everything on the microSD card and prepares it for use with your phone.

< **Battery** >

BATTERY INFORMATION

See how much battery power is used for device activities. The battery level displays in a percentage. The remaining time of use is also displayed.

Battery percentage: Displays the battery percentage on the Status Bar.

POWER SAVER

Power saver Manage the battery for the power saving items. Tap the switch  to turn this feature on. Tap **Power saver** for the following options.

TURN POWER SAVER ON

Turn Power saver on - Select the level you want to turn on the Power saver.

POWER SAVING ITEMS

Checkmark each feature to turn off or adjust when battery is low.

- **Auto-sync:** Turns off Auto-sync.
- **Wi-Fi:** Turns off Wi-Fi if data is not in use.
- **Bluetooth:** Turns off Bluetooth if not connected.
- **Vibrate on touch:** Turns off touch feedback.

Settings

- **Brightness:** Adjust the brightness.
- **Screen timeout:** Adjust the screen timeout.
- **Front touch key light:** Adjust the front key light timeout.
- **Home button LED:** Turns off Home button LED if not connected.

Power saver tips – Touch to access some tips for Power saver.

< Apps >

Use the Apps menu to view details about the applications installed on your phone, manage their data, and force them to stop.

PERSONAL

< Accounts & sync >

Permits applications to synchronize data in the background, whether or not you are actively working in them. Deselecting this setting can save battery power and lower (but not eliminate) data usage.

< Location access >

Access to my location – Lets apps that have asked your permission use your location information.

GPS satellites – Lets apps use GPS satellites to determine your location to street-level accuracy.

Wi-Fi & mobile network location – Let apps use Google's location service to estimate your location faster. Anonymous location data will be collected and sent to Google.

< Security >

Encrypt phone – Allows you to encrypt the phone to keep it secure. After encryption, a PIN or password needs to be entered each time you power the phone on.

Set up SIM card lock – Set up Micro SIM card lock or change the Micro SIM PIN.

Password typing visible – Show the last character of the hidden password as you type.

Phone administrators – View or deactivate phone administrators.

Unknown sources – Allows you to install non-Play Store applications.

Trusted credentials – Display trusted CA certificates.

Install from storage – Choose to install encrypted certificates.

Clear credentials – Remove all certificates.

< Language & input >

Use the Language & input settings to select the language for the text on your phone and to configure the on-screen keyboard, including words you've added to its dictionary.

< Backup & reset >

Backup my data – Set to backup your settings and application data to the Google server.

Backup account – Set the account to which you want to backup data to.

Automatic restore – Set to restore your settings and application data when the applications are reinstalled on your device.

Collect diagnostics – Allows you to select if you want to allow diagnostic data to be sent to T-Mobile.

Factory data reset – Reset your settings to the factory default values and delete all your data. If you reset the phone this way, you are prompted to re-enter the same information as when you first started Android.

SYSTEM

< QuickButton >

QuickButton – Select apps you wish to get quick access to using QuickButton. Tap **Shortcut** and the desired app to change as the QuickButton.

< Date & time >

Use **Date & time** settings to set how dates will be displayed. You can also use these settings to set your own time and time zone rather than obtaining the current time from the mobile network.

Settings

< Accessibility >

Use the **Accessibility** settings to configure accessibility plug-ins you have installed on your phone.

NOTE: Requires additional plug-ins to become selectable.

SERVICES

- **TalkBack:** Allows you to set up the Talkback function which assists people with impaired vision by providing verbal feedback. Tap the **TalkBack** switch  at the top right corner of the screen to turn it on. Tap **SETTINGS** at the bottom of the screen to adjust the TalkBack settings.

VISION

- **Install web scripts:** Allows you to enable (or disable) installation of web scripts.
- **Large text:** Checkmark to increase the size of the text.
- **Invert color:** Checkmark to invert color.
- **Shades:** Set the screen to be shade of black.

HEARING

- **Mono audio:** Checkmark to allow headset sound routed both right and left channel.

PHYSICAL AND MOTOR

- **Touch & hold delay:** Sets the touch and hold delay (short, medium, or long).
- **Universal touch:** Switch  to toggle between on and off. Universal touch can replace all hardware buttons.

SYSTEM

- **Auto-rotate screen:** Checkmark to allow the device to rotate the screen depending on the device orientation (portrait or landscape).
- **Speak passwords:** Checkmark so that you can say your log in passwords (instead of typing your passwords).
- **Power button ends call:** Checkmark so that you can end voice calls by pressing the **Power/Lock Key** . When this option is enabled, pressing the **Power/Lock Key** during a call does not lock the screen.
- **Easy access:** Allows you to select easy access.

- **Text-to-speech output:** Text-to-speech output provides audible readout of text, for example, the contents of text messages, and the Caller ID for incoming calls.

< PC connection >

USB connection type – Set the desired mode you want to use by default when connecting to a PC. Choose from **Charge only**, **Media sync (MTP)**, **LG software** or **Camera (PTP)**.

Ask on connection – Ask in USB connection mode when connecting to a computer.

Help – Displays connection settings information.

On-Screen Phone – Checkmark to receive Wi-Fi connection request from On-Screen Phone.

Help – Help for LG software.

< Developer options >

Keep in mind that turning on these developer settings may result in irregular device behavior. The developer options are recommended only for advanced users.

Take bug report – This will collect information about your current device state, to send as an email message.

Desktop backup password – Sets a password to back up the desktop.

Stay awake – Checkmark to set the screen to never timeout while charging.

Protect SD card – Checkmark to protect the microSD card. When the microSD card is protected, applications must request permission to read data from external storage.

DEBUGGING

USB debugging – Checkmark to turn on debug mode when USB is connected.

Allow mock locations – Checkmark to set the device to a mock location.

Select debug app – Allows you to select the debugging application.

Wait for debugger – Checkmark to wait for debugger. Debugged application waits for debugger to attach before executing.

INPUT

Show touches – Checkmark to show visual feedback when the screen is tapped.

Settings

Show touch data - Checkmark to make tap data visible on the screen.

DRAWING

Show layout bounds - Checkmark to show clip bounds, margins, etc.

Show GPU view updates - Checkmark to flash views inside windows when drawn with the GPU.

Show screen updates - Checkmark to flash areas of the screen when they are updated.

Window animation scale - Allows you to set the window animation scale.

Transition animation scale - Allows you to set the transition animation scale.

Animator duration scale - Allows you to set the animator duration scale.

Disable HW overlays - Checkmark to use the GPU for screen compositing.

Force GPU rendering - Checkmark to use the 2D hardware acceleration in applications.

MONITORING

Enable strict mode - Checkmark to flash the screen when applications operate for a long period of time on the main thread.

Show CPU usage - Checkmark to overlay the current CPU usage on the screen.

Profile GPU rendering - Checkmark to measure rendering time in adb shell `dumpsys gfxinfo`.

Enable traces - Allows you to select enabled traces.

APPS

Don't keep activities - Checkmark to force stop every activity as soon as the user leaves it.

Background process limit - Allows you to set the background process limit.

Show all ANRs - Checkmark to show a dialog box when applications running in the background are not responding.

< About phone >

View legal information and check your phone status and software version.

System updates - Allows you to check for Android system software updates and other current information.

Network - Allows you to view your network, network type and strength, service state, roaming status, mobile network state, and IP address.

Phone identity - Allows you to view the model number, phone number, IMEI, IMEI SV, and Up time.

Battery - Allows you to view battery status, battery level, and battery use information.

Hardware information - Allows you to view Wi-Fi MAC address and Bluetooth address.

Software information - Allows you to view Android version, baseband version, kernel version, build number, and software version.

Legal information - Allows you to view open source licenses and Google legal information.

Patent information - Displays LG patent information.

Phone software update

Phone software update

This feature allows you to update the firmware of your phone to the latest version conveniently from the internet without the need to visit a service center. For more information on how to use this function, please visit: <http://www.lg.com>

As the mobile phone firmware update requires the user's full attention for the duration of the update process, please make sure to check all instructions and notes that appear at each step before proceeding. Please note that removing the USB cable or battery during the upgrade may seriously damage your mobile phone.

LG Mobile Phone Software update via Over-the-Air (OTA)

This feature allows you to update the firmware of your phone to the newer version conveniently via OTA without connecting the USB data cable. This feature is only available if and when LG makes the newer version of the firmware available for your device. First, you can check the software version on your mobile phone:

From the Home screen, tap the **Menu Key**  > **System settings** > **About phone** > **Software information**.

To perform the phone software update, from the Home screen, tap the **Menu Key**  > **System settings** > **About phone** > **System updates** > **Check now**.

NOTE: LG reserves the right to make firmware updates available only for selected models at its own discretion and does not guarantee the availability of the newer version of the firmware for all handset models.

NOTE: Your personal data—including information about your Google account and any other accounts, your system/application data and settings, any downloaded applications and your DRM licence —might be lost in the process of updating your phone's software. Therefore, LG recommends that you back up your personal data before updating your phone's software. LG does not take responsibility for any loss of personal data.

NOTICE: Open Source Software

To obtain the corresponding source code under GPL, LGPL, MPL and other open source licences, please visit <http://opensource.lge.com/>

All referred licence terms, disclaimers and notices are available for download with the source code.

Trademarks

- Copyright 2013 LG Electronics, Inc. All rights reserved. LG and the LG logo are registered trademarks of LG Group and its related entities.
- Bluetooth® is a registered trademark of the Bluetooth SIG, Inc. worldwide.
- Wi-Fi®, the Wi-Fi CERTIFIED logo, and the Wi-Fi logo are registered trademarks of the Wi-Fi Alliance.
- All other trademarks and copyrights are the property of their respective owners.



ABOUT DIVX VIDEO: DivX® is a digital video format created by DivX, LLC, a subsidiary of Rovi Corporation. This is an official DivX Certified® device that has passed rigorous testing to verify that it plays DivX video. Visit www.divx.com for more information and software tools to convert your files into DivX videos.

ABOUT DIVX VIDEO-ON-DEMAND: This DivX Certified® device must be registered in order to play purchased DivX Video-on-Demand (VOD) movies. To obtain your registration code, locate the DivX VOD section in your device setup menu. Go to vod.divx.com for more information on how to complete your registration.

DivX Certified® to play DivX® video up to HD 720p, including premium content. DivX®, DivX Certified® and associated logos are trademarks of Rovi Corporation or its subsidiaries and are used under license.

NOTICE: Open Source Software

To obtain the corresponding source code under GPL, LGPL, MPL and other open source licences, please visit <http://opensource.lge.com>. All referred licence terms, disclaimers and notices are available for download with the source code.

- Wi-Fi® and Wi-Fi Protected Access® are registered trademarks of the Wi-Fi Alliance.

Dolby Digital Plus



Manufactured under license from Dolby Laboratories. Dolby and the double-D symbol are trademarks of Dolby Laboratories.

Accessories

These accessories are available for use with your phone. (Items described below may be optional and sold separately.)

Travel adapter



Data cable

Connect your phone and PC.



User Guide

Learn more about your phone.



Battery



NOTE:

- Always use genuine LG accessories. Failure to do this may void your warranty.
- Accessories may vary in different regions.

Technical data

Ambient Temperatures

Max: +50°C (discharging), +45°C (charging)

Min: -10°C

Battery Standby and Talk Time

Standby and talk times will vary depending on phone usage patterns and conditions. Battery power consumption depends on factors such as network configuration, signal strength, operating temperature, features selected, frequency of calls, and voice, data, and other application usage patterns.

Troubleshooting

This chapter lists some problems you might encounter when using your phone. Some problems require you to call your service provider, but most are easy to fix yourself.

Message	Possible causes	Possible corrective measures
Micro SIM error	There is no Micro SIM card in the phone or it is inserted incorrectly.	Make sure that the Micro SIM card is correctly inserted.
No network connection/ Dropped network	Signal is weak or you are outside the carrier network.	Move toward a window or into an open area. Check the network operator coverage map.
	Operator applied new services.	Check whether the Micro SIM card is more than 6-12 months old. If so, change your Micro SIM at your network provider's nearest branch. Contact your service provider.
Codes do not match	To change a security code, you will need to confirm the new code by re-entering it.	If you forget the code, contact your service provider.
	The two codes you have entered do not match.	

Message	Possible causes	Possible corrective measures
No applications can be set	Not supported by service provider or registration required.	Contact your service provider.
Calls not available	Dialling error	New network not authorized.
	New Micro SIM card inserted.	Check for new restrictions.
	Pre-paid charge limit reached.	Contact service provider or reset limit with PIN2.
Phone cannot be switched on	Power/Lock Key pressed too briefly.	Press the Power/Lock Key for at least two seconds.
	Battery is not charged.	Charge battery. Check the charging indicator on the display.

Troubleshooting

Message	Possible causes	Possible corrective measures
Charging error	Battery is not charged.	Charge battery.
	Outside temperature is too hot or cold.	Make sure phone is charging at a normal temperature.
	Contact problem	Check the charger and its connection to the phone.
	No voltage	Plug the charger into a different socket.
	Charger defective	Replace the charger.
	Wrong charger	Use only original LG accessories.
Number not allowed	The Fixed dialling number function is on.	Check the Settings menu and turn the function off.
Impossible to receive / send SMS & photos	Memory full	Delete some messages from your phone.
Files do not open	Unsupported file format	Check the supported file formats.

Message	Possible causes	Possible corrective measures
The screen does not turn on when I receive a call.	Proximity sensor problem	If you use a protection tape or case, make sure it has not covered the area around the proximity sensor. Make sure that the area around the proximity sensor is clean.
No sound	Vibration mode	Check the settings status in the sound menu to make sure you are not in vibration or silent mode.
Hangs up or freezes	Intermittent software problem	Try to perform a software update via the website.

Wi-Fi Caution

This device is capable of operating in 802.11a/n mode. For 802.11a/n devices operating in the frequency range of 5.15 - 5.25 GHz, they are restricted for indoor operations to reduce any potential harmful interference for Mobile Satellite Services (MSS) in the US. WIFI Access Points that are capable of allowing your device to operate in 802.11a/n mode(5.15 - 5.25 GHz band) are optimized for indoor use only. If your WIFI network is capable of operating in this mode, please restrict your WIFI use indoors to not violate federal regulations to protect Mobile Satellite Services.

Safety Information

Please read and observe the following information for safe and proper use of your phone and to prevent damage.

WARNING! This product contains chemicals known to the State of California to cause cancer and birth defects or reproductive harm. ***Wash hands after handling.***

Caution Violation of the instructions may cause minor or serious damage to the product.

- Do not disassemble or open crush, bend or deform, puncture or shred.
- Repairs under warranty, at LG's option, may include replacement parts or boards that are either new or reconditioned, provided that they have functionality equal to that of the parts being replaced.
- Do not modify or remanufacture, attempt to insert foreign objects into the battery, immerse or expose to water or other liquids, expose to fire, explosion or other hazard.
- Only use the battery for the system for which it is specified.
- Only use the battery with a charging system that has been qualified with the system per this standard. Use of an unqualified battery or charger may present a risk of fire, explosion, leakage, or other hazard.
- Do not short circuit a battery or allow metallic conductive objects to contact battery terminals.
- Replace the battery only with another battery that has been qualified with the system per this standard, IEEE-Std-1725-200x. Use of an unqualified battery may present a risk of fire, explosion, leakage or other hazard.
- Promptly dispose of used batteries in accordance with local regulations.
- Battery usage by children should be supervised.
- Avoid dropping the phone or battery. If the phone or battery is dropped, especially on a hard surface, and the user suspects damage, take it to a service center for inspection.
- Improper battery use may result in a fire, explosion or other hazard.

- For those host devices that utilize a USB port as a charging source, the host device's user manual shall include a statement that the phone shall only be connected to products that bear the USB-IF logo or have completed the USB-IF compliance program.

Charger and Adapter Safety

- The charger and adapter are intended for indoor use only.
- Insert the battery pack charger vertically into the wall power socket.
- Unplug the power cord and charger during lightning storms to avoid electric shock or fire.
- Use the correct adapter for your phone when using the battery pack charger abroad.

Battery Information and Care

- Please read the manual of proper installation and removal of the battery.
- Please read the manual of specified charger about charging method.
- Do not damage the power cord by bending, twisting, or heating. Do not use the plug if it is loose as it may cause electric shock or fire.
Do not place any heavy items on the power cord. Do not allow the power cord to be crimped as it may cause electric shock or fire.
- Unplug the power cord prior to cleaning your phone, and clean the power plug pin when it's dirty. When using the power plug, ensure that it's firmly connected. If not, it may cause excessive heat or fire. If you put your phone in a pocket or bag without covering the receptacle of the phone (power plug pin), metallic articles (such as a coin, paperclip or pen) may short-circuit the phone. Short-circuit of the terminal may damage the battery and cause an explosion. Always cover the receptacle when not in use.
- Recharge the battery after long periods of non-use to maximize battery life. Battery life will vary due to usage pattern and environmental conditions.
- Never store your phone in temperature less than -4°F or greater than 122°F .
- Charging temperature range is between 32°F and 113°F . Do not charge the battery out of recommended temperature range. Charging out of recommended range might cause the generating heat or serious damage of

For Your Safety

battery. And also, it might cause the deterioration of battery's characteristics and cycle life.

- Do not use or leave the battery under the blazing sun or in heated car by sunshine. The battery may generate heat, smoke or flame. And also, it might cause the deterioration of battery's characteristics or cycle life.
- The battery pack has protection circuit to avoid the danger. Do not use near places that can generate static electricity more than 100V which could damage the protection circuit. Damaged protection circuits may generate smoke, rupture or ignite.
- When using the battery for the first time, if it emits a bad smell, you see rust on it, or anything else abnormal, do not use the equipment and bring the battery to the shop which it was bought.
- Keep batteries away from babies and small children. If children use the battery, their parents or legal guardians are responsible for supervising and teaching them about the safe handling of batteries and how to use batteries according to the manual with care.
- If liquid from the battery rubs against skin or clothing, wash with fresh water. It may cause the skin inflammation. Remove and do not use the battery. Be careful that children do not swallow any parts (such as earphone, connection parts of the phone, etc.). This could cause asphyxiation or suffocation resulting in serious injury or death.
- Do not handle the phone with wet hands while it is being charged. It may cause an electric shock or seriously damage your phone.
- Do not place or answer calls while charging the phone as it may short-circuit the phone and/or cause electric shock or fire.
- Do not use harsh chemicals (such as alcohol, benzene, thinners, etc.) or detergents to clean your phone. This could cause a fire.
- Always unplug the charger from the wall socket after the phone is fully charged to save unnecessary power consumption of the charger.

Care and Maintenance

Your mobile device is a product of superior design and craftsmanship and should be treated with care. The suggestions below will help you fulfill any warranty obligations and allow you to enjoy this product for many years:

Keep your Mobile Device away from:

Liquids of any kind

Keep the mobile device dry. Precipitation, humidity, and liquids contain minerals that will corrode electronic circuits. If the mobile device does get wet, do not accelerate drying with the use of an oven, microwave, or dryer, because this may damage the mobile device and could cause a fire or explosion.

Do not use the mobile device with a wet hand.

Doing so may cause an electric shock to you or damage to the mobile device.

Extreme heat or cold

Avoid temperatures below 0°C / 32°F or above 45°C / 113°F.

Microwaves

Do not try to dry your mobile device in a microwave oven. Doing so may cause a fire or explosion.

Dust and dirt

Do not expose your mobile device to dust, dirt, or sand.

Sunscreen lotion

Do not expose or wear your device to any liquid like sunscreen lotion.

Doing so may cause your device to or damage to the mobile device.

Cleaning solutions

Do not use harsh chemicals, cleaning solvents, or strong detergents to clean the mobile device.

Wipe it with a soft cloths lightly dampened in a mild soap-and-water solution.

Shock or vibration

Do not drop, knock, or shake the mobile device.

Rough handling can break internal circuit boards.

Paint

Do not paint the mobile device. Paint can clog the device's moving parts or ventilation openings and prevent proper operation.

General Notice

- An emergency call can be made only within a service area. For an emergency call, make sure that you are within a service area and that the phone is turned on.
- Do not place items containing magnetic components such as a credit card, phone card, bank book, or subway ticket near your phone. The magnetism of the phone may damage the data stored in the magnetic strip.
- Talking on your phone for a long period of time may reduce call quality due to heat generated during use.
- When the phone is not used for a long period time, store it in a safe place with the power cord unplugged.
- Using the phone in proximity to receiving equipment (i.e., TV or radio) may cause interference to the phone.
- Do not use the phone if the antenna is damaged. If a damaged antenna contacts skin, it may cause a slight burn. Please contact an LG Authorized Service Center to replace the damaged antenna.
- The data saved in your phone might be deleted due to careless use, repair of the phone, or upgrade of the software. Please backup your important phone numbers. (Ringtones, text messages, voice messages, pictures, and videos could also be deleted.) The manufacturer is not liable for damage due to the loss of data.
- When you use the phone in public places, set the ringtone to vibration so you don't disturb others.
- Do not turn your phone on or off when putting it to your ear.

- Your phone is an electronic device that generates heat during normal operation. Extremely prolonged, direct skin contact in the absence of adequate ventilation may result in discomfort or minor burns. Therefore, use care when handling your phone during or immediately after operation.
- Use accessories, such as earphones and headsets, with caution. Ensure that cables are tucked away safely and do not touch the antenna unnecessarily.

Part 15.19 statement

This device complies with part 15 of FCC rules. Operation is subject to the following two conditions: (1) This device may not cause harmful interference, and (2) this device must accept any interference received, including interference that causes undesired operation.

Part 15.21 statement

Any changes or modifications not expressly approved by the manufacturer could void the user's authority to operate the equipment.

Part 15.105 statement

This equipment has been tested and found to comply with the limits for a class B digital device, pursuant to Part 15 of the FCC Rules. These limits are designed to provide reasonable protection against harmful interference in a residential installation. This equipment generates uses and can radiate radio frequency energy and, if not installed and used in accordance with the instructions, may cause harmful interference to radio communications. However, there is no guarantee that interference will not occur in a particular installation. if this equipment does cause harmful interference or television reception, which can be determined by turning the equipment off and on, the user is encouraged to try to correct the interference by one or more of the following measures:

- Reorient or relocate the receiving antenna.
- Increase the separation between the equipment and receiver.
- Connect the equipment into an outlet on a circuit different from that to which the receiver is connected.
- Consult the dealer or an experienced radio/TV technician for help.

FCC RF Exposure Information

WARNING! Read this information before operating the phone.

In August 1996, the Federal Communications Commission (FCC) of the United States, with its action in Report and Order FCC 96-326, adopted an updated safety standard for human exposure to Radio Frequency (RF) electromagnetic energy emitted by FCC regulated transmitters. Those guidelines are consistent with the safety standard previously set by both U.S. and international standards bodies. The design of this phone complies with the FCC guidelines and these international standards.

Bodily Contact During Operation

This device was tested for typical use with the back of the phone kept 0.39 inches (1 cm) from the body. To comply with FCC RF exposure requirements, a minimum separation distance of 0.39 inches (1 cm) must be maintained between the user's body and the back of the phone. Third-party belt-clips, holsters, and similar accessories containing metallic components may not be used. Avoid the use of accessories that cannot maintain 0.39 inches (1 cm) distance between the user's body and the back of the phone and have not been tested for compliance with FCC RF exposure limits.

Caution

Use only the supplied antenna. Use of unauthorized antennas (or modifications to the antenna) could impair call quality, damage the phone, void your warranty and/or violate FCC regulations.

Don't use the phone with a damaged antenna. A damaged antenna could cause a minor skin burn. Contact your local dealer for a replacement antenna.

Consumer Information About Radio Frequency Emissions

Your wireless phone, which contains a radio transmitter and receiver, emits radio frequency energy during use. The following consumer information addresses commonly asked questions about the health effects of wireless phones.

Are wireless phones safe?

Scientific research on the subject of wireless phones and radio frequency ("RF") energy has been conducted worldwide for many years, and continues. In the United States, the Food and Drug Administration ("FDA") and the Federal Communications Commission ("FCC") set policies and procedures for wireless phones. The FDA issued a website publication on health issues related to cell phone usage where it states, "The scientific community at large ... believes that the weight of scientific evidence does not show an association between exposure to radiofrequency (RF) from cell phones and adverse health outcomes. Still the scientific community does recommend conducting additional research to address gaps in knowledge. That research is being conducted around the world and FDA continues to monitor developments in this field. You can access the joint FDA/FCC website at <http://www.fda.gov> (under "C" in the subject index, select Cell Phones > Research). You can also contact the FDA toll-free at (888) 463-6332 or (888) INFO-FDA. In June 2000, the FDA entered into a cooperative research and development agreement through which additional scientific research is being conducted. The FCC issued its own website publication stating that "there is no scientific evidence that proves that wireless phone usage can lead to cancer or a variety of other problems, including headaches, dizziness or memory loss."

This publication is available at <http://www.fcc.gov/oet/rfsafety> or through the FCC at (888) 225-5322 or (888) CALL-FCC.

What does "SAR" mean?

In 1996, the FCC, working with the FDA, the U.S. Environmental Protection Agency, and other agencies, established RF exposure safety guidelines for wireless phones in the United States. Before a wireless phone model is available for sale to the public, it must be tested by the manufacturer and

For Your Safety

certified to the FCC that it does not exceed limits established by the FCC. One of these limits is expressed as a Specific Absorption Rate, or "SAR." SAR is a measure of the rate of absorption of RF energy in the body. Tests for SAR are conducted with the phone transmitting at its highest power level in all tested frequency bands. Since 1996, the FCC has required that the SAR of handheld wireless phones not exceed 1.6 watts per kilogram, averaged over one gram of tissue.

Although the SAR is determined at the highest power level, the actual SAR value of a wireless phone while operating can be less than the reported SAR value. This is because the SAR value may vary from call to call, depending on factors such as proximity to a cell site, the proximity of the phone to the body while in use, and the use of hands-free devices. Before a phone model is available for sale to the public, it must be tested and certified to the FCC that it does not exceed the limit established by the government-adopted requirement for safe exposure. The tests are performed in positions and locations (e.g., at the ear and worn on the body) as required by the FCC for each model.

While there may be differences between SAR levels of various phones and at various positions, they all meet the government requirement for safe exposure. The FCC has granted an Equipment Authorization for this model phone with all reported SAR levels evaluated as in compliance with the FCC RF emission guidelines. SAR information on this model phone is on file with the FCC and can be found under the Display Grant section of <http://www.fcc.gov/oet/ea/fccid/> after searching on FCC ID ZNFD520.

For more information about SARs, see the FCC's OET Bulletins 56 and 65 at http://www.fcc.gov/Bureaus/Engineering_Technology/Documents/bulletins or visit the Cellular Telecommunications Industry Association website at http://www.ctia.org/consumer_info/index.cfm/AID/10371. You may also wish to contact the manufacturer of your phone.

Can I minimize my RF exposure?

If you are concerned about RF, there are several simple steps you can take to minimize your RF exposure. You can, of course, reduce your talk time. You can place more distance between your body and the source of the RF, as the exposure level drops off dramatically with distance. The FDA/FCC website states that "hands-free kits can be used with wireless phones for convenience and comfort. These systems reduce the absorption of RF energy in the head because the phone, which is the source of the RF emissions, will not be placed against the head. On the other hand, if the phone is mounted against the waist or other part of the body during use, then that part of the body will absorb more RF energy. Wireless phones marketed in the U.S. are required to meet safety requirements regardless of whether they are used against the head or against the body. Either configuration should result in compliance with the safety limit." Also, if you use your wireless phone while in a car, you can use a phone with an antenna on the outside of the vehicle. You should also read and follow your wireless phone manufacturer's instructions for the safe operation of your phone.

Do wireless phones pose any special risks to children?

The FDA/FCC website states that "the scientific evidence does not show a danger to users of wireless communication devices, including children." The FDA/FCC website further states that "some groups sponsored by other national governments have advised that children be discouraged from using wireless phones at all". For example, the Stewart Report from the United Kingdom ["UK"] made such a recommendation in December 2000. In this report a group of independent experts noted that no evidence exists that using a cell phone causes brain tumors or other ill effects. [The UK's] recommendation to limit cell phone use by children was strictly precautionary; it was not based on scientific evidence that any health hazard exists. A copy of the UK's leaflet is available at <http://www.dh.gov.uk> (search "mobile"), or you can write to: NRPB, Chilton, Didcot, Oxon OX11 0RQ, United Kingdom. Copies of the UK's annual reports on mobile phones and RF are available online at www.iegmp.org.uk and <http://www.hpa.org.uk/radiation/> (search "mobile"). Parents who wish to reduce their children's RF exposure may choose to restrict their children's wireless phone use.

Where can I get further information about RF emissions?

For further information, see the following additional resources (websites current as of April 2005):

U.S. Food and Drug Administration

FDA Consumer magazine

November-December 2000

Telephone: (888) INFO-FDA

<http://www.fda.gov> (Under "C" in the subject index, select Cell Phones > Research.)

U.S. Federal Communications Commission

445 12th Street, S.W.

Washington, D.C. 20554

Telephone: (888) 225-5322

<http://www.fcc.gov/oet/rfsafety>

Independent Expert Group on Mobile Phones

<http://www.iegmp.org.uk>

Royal Society of Canada Expert Panels on Potential Health Risks of Radio Frequency Fields from Wireless Telecommunication Devices

283 Sparks Street

Ottawa, Ontario K1R 7X9

Canada

Telephone: (613) 991-6990

World Health Organization

Avenue Appia 20

1211 Geneva 27

Switzerland

Telephone: 011 41 22 791 21 11

<http://www.who.int/mediacentre/factsheets/fs193/en/>

International Commission on Non-Ionizing Radiation Protection

c/o Bundesamt für Strahlenschutz
Ingolstaedter Landstr. 1
85764 Oberschleissheim
Germany
Telephone: 011 49 1888 333 2156
<http://www.icnirp.de>

American National Standards Institute

1819 L Street, N.W., 6th Floor
Washington, D.C. 20036
Telephone: (202) 293-8020
<http://www.ansi.org>

National Council on Radiation Protection and Measurements

7910 Woodmont Avenue, Suite 800
Bethesda, MD 20814-3095
Telephone: (301) 657-2652
<http://www.ncrponline.org>

Engineering in Medicine and Biology Society, Committee on Man and Radiation (COMAR) of the Institute of Electrical and Electronics Engineers

<http://ewh.ieee.org/soc/embs/comar/>

TIA Safety Information

The following is the complete TIA Safety Information for wireless handheld phones.

Exposure to Radio Frequency Signal

Your wireless handheld portable phone is a low power radio transmitter and receiver. When ON, it receives and sends out Radio Frequency (RF) signals.

For Your Safety

In August, 1996, the Federal Communications Commissions (FCC) adopted RF exposure guidelines with safety levels for handheld wireless phones. Those guidelines are consistent with the safety standards previously set by both U.S. and international standards bodies:

ANSI C95.1 (1992) *

NCRP Report 86 (1986)

ICNIRP (1996)

* American National Standards Institute; National Council on Radiation Protection and Measurements; International Commission on Non-Ionizing Radiation Protection

Those standards were based on comprehensive and periodic evaluations of the relevant scientific literature. For example, over 120 scientists, engineers, and physicians from universities, government health agencies, and industry reviewed the available body of research to develop the ANSI Standard (C95.1).

The design of your phone complies with the FCC guidelines (and those standards).

Antenna Care

Use only the supplied or an approved replacement antenna. Unauthorized antennas, modifications, or attachments could damage the phone and may violate FCC regulations.

Phone Operation

NORMAL POSITION: Hold the phone as you would any other telephone with the antenna pointed up and over your shoulder.

Tips on Efficient Operation

For your phone to operate most efficiently:

Don't touch the antenna unnecessarily when the phone is in use. Contact with the antenna affects call quality and may cause the phone to operate at a higher power level than otherwise needed.

Electronic Devices

Most modern electronic equipment is shielded from RF signals. However, certain electronic equipment may not be shielded against the RF signals from your wireless phone.

Pacemakers

The Health Industry Manufacturers Association recommends that a minimum separation of six (6) inches be maintained between a handheld wireless phone and a pacemaker to avoid potential interference with the pacemaker. These recommendations are consistent with the independent research by and recommendations of Wireless Technology Research.

Persons with pacemakers:

- Should ALWAYS keep the phone more than six (6) inches from their pacemaker when the phone is turned ON;
- Should not carry the phone in a breast pocket;
- Should use the ear opposite the pacemaker to minimize the potential for interference;
- Should turn the phone OFF immediately if there is any reason to suspect that interference is taking place.

Hearing Aids

Some digital wireless phones may interfere with some hearing aids. In the event of such interference, you may want to consult your service provider (or call the customer service line to discuss alternatives).

Other Medical Devices

If you use any other personal medical device, consult the manufacturer of your device to determine if it is adequately shielded from external RF energy. Your physician may be able to assist you in obtaining this information.

Health Care Facilities

Turn your phone OFF in health care facilities when any regulations posted in these areas instruct you to do so. Hospitals or health care facilities may use equipment that could be sensitive to external RF energy.

Vehicles

RF signals may affect improperly installed or inadequately shielded electronic systems in motor vehicles. Check with the manufacturer or its representative regarding your vehicle. You should also consult the manufacturer of any equipment that has been added to your vehicle.

Posted Facilities

Turn your phone OFF in any facility where posted notices so require.

Aircraft

FCC regulations prohibit using your phone while in the air. Switch OFF your phone before boarding an aircraft.

Blasting Areas

To avoid interfering with blasting operations, turn your phone OFF when in a "blasting area" or in areas posted: "Turn off two-way radio". Obey all signs and instructions.

Potentially Explosive Atmosphere

Turn your phone OFF when in any area with a potentially explosive atmosphere and obey all signs and instructions. Sparks in such areas could cause an explosion or fire resulting in bodily injury or even death.

Areas with a potentially explosive atmosphere are often, but not always marked clearly. Potential areas may include: fueling areas (such as gasoline stations); below deck on boats; fuel or chemical transfer or storage facilities; vehicles using liquefied petroleum gas (such as propane or butane); areas where the air contains chemicals or particles (such as grain, dust, or metal powders); and any other area where you would normally be advised to turn off your vehicle engine.

For Vehicles Equipped with an Air Bag

An air bag inflates with great force. DO NOT place objects, including either installed or portable wireless equipment, in the area over the air bag or in the air bag deployment area. If in-vehicle wireless equipment is improperly installed and the air bag inflates, serious injury could result.

FDA Consumer Update



The U.S. Food and Drug Administration's Center for Devices and Radiological Health Consumer Update on Mobile Phones:

1. Do wireless phones pose a health hazard?

The available scientific evidence does not show that any health problems are associated with using wireless phones.

There is no proof, however, that wireless phones are absolutely safe. Wireless phones emit low levels of Radio Frequency (RF) energy in the microwave range while being used. They also emit very low levels of RF when in idle mode. Whereas high levels of RF can produce health effects (by heating tissue), exposure to low level RF that does not produce heating effects causes no known adverse health effects. Many studies of low level RF exposures have not found any biological effects. Some studies have suggested that some biological effects may occur, but such findings have not been confirmed by additional research. In some cases, other researchers have had difficulty in reproducing those studies, or in determining the reasons for inconsistent results.

2. What is the FDA's role concerning the safety of wireless phones?

Under the law, the FDA does not review the safety of radiation-emitting consumer products such as wireless phones before they can be sold, as it does with new drugs or medical devices. However, the agency has authority to take action if wireless phones are shown to emit Radio Frequency (RF) energy at a level that is hazardous to the user. In such a case, the FDA could require the manufacturers of wireless phones to notify users of the health hazard and to repair, replace, or recall the phones so that the hazard no longer exists.

Although the existing scientific data does not justify FDA regulatory actions, the FDA has urged the wireless phone industry to take a number of steps, including the following:

- Support needed research into possible biological effects of RF of the type emitted by wireless phones;

For Your Safety

- Design wireless phones in a way that minimizes any RF exposure to the user that is not necessary for device function; and
- Cooperate in providing users of wireless phones with the best possible information on possible effects of wireless phone use on human health.

The FDA belongs to an interagency working group of the federal agencies that have responsibility for different aspects of RF safety to ensure coordinated efforts at the federal level. The following agencies belong to this working group:

- National Institute for Occupational Safety and Health
- Environmental Protection Agency
- Occupational Safety and Health Administration
- National Telecommunications and Information Administration

The National Institutes of Health participates in some interagency working group activities, as well.

The FDA shares regulatory responsibilities for wireless phones with the Federal Communications Commission (FCC). All phones that are sold in the United States must comply with FCC safety guidelines that limit RF exposure. The FCC relies on the FDA and other health agencies for safety questions about wireless phones.

The FCC also regulates the base stations that the wireless phone networks rely upon. While these base stations operate at higher power than do the wireless phones themselves, the RF exposures that people get from these base stations are typically thousands of times lower than those they can get from wireless phones. Base stations are thus not the subject of the safety questions discussed in this document.

3. What kinds of phones are the subject of this update?

The term "wireless phone" refers here to handheld wireless phones with built-in antennas, often called "cell", "mobile", or "PCS" phones. These types of wireless phones can expose the user to measurable Radio Frequency (RF) energy because of the short distance between the phone and the user's head.

These RF exposures are limited by FCC safety guidelines that were developed with the advice of the FDA and other federal health and safety agencies.

When the phone is located at greater distances from the user, the exposure

to RF is drastically lower because a person's RF exposure decreases rapidly with increasing distance from the source. The so-called "cordless phones," which have a base unit connected to the telephone wiring in a house, typically operate at far lower power levels, and thus produce RF exposures far below the FCC safety limits.

4. What are the results of the research done already?

The research done thus far has produced conflicting results, and many studies have suffered from flaws in their research methods. Animal experiments investigating the effects of Radio Frequency (RF) energy exposures characteristic of wireless phones have yielded conflicting results that often cannot be repeated in other laboratories. A few animal studies, however, have suggested that low levels of RF could accelerate the development of cancer in laboratory animals. However, many of the studies that showed increased tumor development used animals that had been genetically engineered or treated with cancer-causing chemicals so as to be pre-disposed to develop cancer in the absence of RF exposure. Other studies exposed the animals to RF for up to 22 hours per day. These conditions are not similar to the conditions under which people use wireless phones, so we do not know with certainty what the results of such studies mean for human health. Three large epidemiology studies have been published since December 2000. Between them, the studies investigated any possible association between the use of wireless phones and primary brain cancer, glioma, meningioma, or acoustic neuroma, tumors of the brain or salivary gland, leukemia, or other cancers. None of the studies demonstrated the existence of any harmful health effects from wireless phone RF exposures. However, none of the studies can answer questions about long-term exposures, since the average period of phone use in these studies was around three years.

5. What research is needed to decide whether RF exposure from wireless phones poses a health risk?

A combination of laboratory studies and epidemiological studies of people actually using wireless phones would provide some of the data that are needed. Lifetime animal exposure studies could be completed in a few years. However,

very large numbers of animals would be needed to provide reliable proof of a cancer promoting effect if one exists. Epidemiological studies can provide data that is directly applicable to human populations, but ten or more years follow-up may be needed to provide answers about some health effects, such as cancer. This is because the interval between the time of exposure to a cancer-causing agent and the time tumors develop – if they do – may be many, many years. The interpretation of epidemiological studies is hampered by difficulties in measuring actual RF exposure during day-to-day use of wireless phones. Many factors affect this measurement, such as the angle at which the phone is held, or which model of phone is used.

6. What is the FDA doing to find out more about the possible health effects of wireless phone RF?

The FDA is working with the U.S. National Toxicology Program and with groups of investigators around the world to ensure that high priority animal studies are conducted to address important questions about the effects of exposure to Radio Frequency (RF) energy.

The FDA has been a leading participant in the World Health Organization International Electro Magnetic Fields (EMF) Project since its inception in 1996. An influential result of this work has been the development of a detailed agenda of research needs that has driven the establishment of new research programs around the world. The project has also helped develop a series of public information documents on EMF issues.

The FDA and the Cellular Telecommunications & Internet Association (CTIA) have a formal Cooperative Research And Development Agreement (CRADA) to do research on wireless phone safety. The FDA provides the scientific oversight, obtaining input from experts in government, industry, and academic organizations. CTIA-funded research is conducted through contracts with independent investigators. The initial research will include both laboratory studies and studies of wireless phone users. The CRADA will also include a broad assessment of additional research needs in the context of the latest research developments around the world.

7. How can I find out how much Radio Frequency energy exposure I can get by using my wireless phone?

All phones sold in the United States must comply with Federal Communications Commission (FCC) guidelines that limit Radio Frequency (RF) energy exposures. The FCC established these guidelines in consultation with the FDA and the other federal health and safety agencies. The FCC limit for RF exposure from wireless phones is set at a Specific Absorption Rate (SAR) of 1.6 watts per kilogram (1.6 W/kg). The FCC limit is consistent with the safety standards developed by the Institute of Electrical and Electronic Engineering (IEEE) and the National Council on Radiation Protection and Measurement. The exposure limit takes into consideration the body's ability to remove heat from the tissues that absorb energy from the wireless phone and is set well below levels known to have effects. Manufacturers of wireless phones must report the RF exposure level for each model of phone to the FCC. The FCC website (<http://www.fcc.gov/oet/rfsafety>) gives directions for locating the FCC identification number on your phone so you can find your phone's RF exposure level in the online listing.

8. What has the FDA done to measure the Radio Frequency energy coming from wireless phones?

The Institute of Electrical and Electronic Engineers (IEEE) is developing a technical standard for measuring the Radio Frequency (RF) energy exposure from wireless phones and other wireless handsets with the participation and leadership of FDA scientists and engineers. The standard, "Recommended Practice for Determining the Spatial-Peak Specific Absorption Rate (SAR) in the Human Body Due to Wireless Communications Devices: Experimental Techniques", sets forth the first consistent test methodology for measuring the rate at which RF is deposited in the heads of wireless phone users. The test method uses a tissue-simulating model of the human head. Standardized SAR test methodology is expected to greatly improve the consistency of measurements made at different laboratories on the same phone. SAR is the measurement of the amount of energy absorbed in tissue, either by the whole body or a small part of the body. It is measured in watts/kg (or milliwatts/g)

of matter. This measurement is used to determine whether a wireless phone complies with safety guidelines.

9. What steps can I take to reduce my exposure to Radio Frequency energy from my wireless phone?

If there is a risk from these products — and at this point we do not know that there is — it is probably very small. But if you are concerned about avoiding even potential risks, you can take a few simple steps to minimize your exposure to Radio Frequency (RF) energy. Since time is a key factor in how much exposure a person receives, reducing the amount of time spent using a wireless phone will reduce RF exposure. If you must conduct extended conversations by wireless phone every day, you could place more distance between your body and the source of the RF, since the exposure level drops off dramatically with distance. For example, you could use a headset and carry the wireless phone away from your body or use a wireless phone connected to a remote antenna. Again, the scientific data does not demonstrate that wireless phones are harmful. But if you are concerned about the RF exposure from these products, you can use measures like those described above to reduce your RF exposure from wireless phone use.

10. What about children using wireless phones?

The scientific evidence does not show a danger to users of wireless phones, including children and teenagers. If you want to take steps to lower exposure to Radio Frequency (RF) energy, the measures described above would apply to children and teenagers using wireless phones. Reducing the time of wireless phone use and increasing the distance between the user and the RF source will reduce RF exposure.

Some groups sponsored by other national governments have advised that children be discouraged from using wireless phones at all. For example, the government in the United Kingdom distributed leaflets containing such a recommendation in December 2000. They noted that no evidence exists that using a wireless phone causes brain tumors or other ill effects. Their recommendation to limit wireless phone use by children was strictly precautionary; it was not based on scientific evidence that any health hazard exists.

11. What about wireless phone interference with medical equipment?

Radio Frequency (RF) energy from wireless phones can interact with some electronic devices. For this reason, the FDA helped develop a detailed test method to measure Electro Magnetic Interference (EMI) of implanted cardiac pacemakers and defibrillators from wireless telephones. This test method is now part of a standard sponsored by the Association for the Advancement of Medical Instrumentation (AAMI). The final draft, a joint effort by the FDA, medical device manufacturers, and many other groups, was completed in late 2000. This standard will allow manufacturers to ensure that cardiac pacemakers and defibrillators are safe from wireless phone EMI.

The FDA has tested hearing aids for interference from handheld wireless phones and helped develop a voluntary standard sponsored by the Institute of Electrical and Electronic Engineers (IEEE). This standard specifies test methods and performance requirements for hearing aids and wireless phones so that no interference occurs when a person uses a "compatible" phone and a "compatible" hearing aid at the same time. This standard was approved by the IEEE in 2000.

The FDA continues to monitor the use of wireless phones for possible interactions with other medical devices. Should harmful interference be found to occur, the FDA will conduct testing to assess the interference and work to resolve the problem.

12. Where can I find additional information?

For additional information, please refer to the following resources:

Federal Communications Commission (FCC) RF Safety Program
(<http://www.fcc.gov/oet/rfsafety>)

International Commission on Non-Ionizing Radiation Protection
(<http://www.icnirp.de>)

World Health Organization (WHO) International EMF Project
(<http://www.who.int/emf>)

National Radiological Protection Board (UK)
(<http://www.hpa.org.uk/radiation/>)

Driving

Check the laws and regulations on the use of wireless phones in the areas where you drive and always obey them. Also, if using your phone while driving, please observe the following:

- Give full attention to driving -- driving safely is your first responsibility;
- Use hands-free operation, if available;
- Pull off the road and park before making or answering a call if driving conditions or the law require it.

HAC statement

This phone has been tested and rated for use with hearing aids for some of the wireless technologies that it uses.

However, there may be some newer wireless technologies used in this phone that have not been tested yet for use with hearing aids.

It is important to try the different features of this phone thoroughly and in different locations, using your hearing aid or cochlear implant, to determine if you hear any interfering noise.

Consult your service provider or the manufacturer of this phone for information on hearing aid compatibility.

If you have questions about return or exchange policies, consult your service provider or phone retailer.

FCC Hearing-Aid Compatibility (HAC) Regulations for Wireless Devices

While some wireless phones are used near some hearing devices (hearing aids and cochlear implants), users may detect a buzzing, humming, or whining noise. Some hearing devices are more immune than others to this interference noise, and phones also vary in the amount of interference they generate.

The wireless telephone industry has developed a rating system for wireless phones, to assist hearing device users to find phones that may be compatible with their hearing devices. Not all phones have been rated. Phones that are

rated have the rating on their box or a label located on the box.

The ratings are not guarantees.

Results will vary depending on the user's hearing device and hearing loss. If your hearing device happens to be vulnerable to interference, you may not be able to use a rated phone successfully.

Trying out the phone with your hearing device is the best way to evaluate it for your personal needs.

M-Ratings: Phones rated M3 or M4 meet FCC requirements and are likely to generate less interference to hearing devices than phones that are not labeled. M4 is the better/higher of the two ratings.

T-Ratings: Phones rated T3 or T4 meet FCC requirements and are likely to generate less interference to hearing devices than phones that are not labeled. T4 is the better/higher of the two ratings.

Hearing devices may also be rated. Your hearing device manufacturer or hearing health professional may help you find this rating. Higher ratings mean that the hearing device is relatively immune to interference noise. The hearing aid and wireless phone rating values are then added together. A sum of 5 is considered acceptable for normal use.

A sum of 6 is considered for best use.



In the above example, if a hearing aid meets the M2 level rating and the wireless phone meets the M3 level rating, the sum of the two values equal M5. This should provide the hearing aid user with "normal usage" while using their hearing aid with the particular wireless phone. "Normal usage" in this context is defined as a signal quality that's acceptable for normal operation.

The M mark is intended to be synonymous with the U mark. The T mark is intended to be synonymous with the UT mark.

The M and T marks are recommended by the Alliance for Telecommunications

For Your Safety

Industries Solutions (ATIS). The U and UT marks are referenced in Section 20.19 of the FCC Rules.

The HAC rating and measurement procedure are described in the American National Standards Institute (ANSI) C63.19 standard.

To **ensure** that the Hearing Aid Compatibility rating for your phone is maintained, secondary transmitters such as Bluetooth and WLAN components must be disabled during a call.

For information about hearing aids and digital wireless phones

Wireless Phones and Hearing Aid Accessibility <http://www.accesswireless.org/>

FCC Hearing Aid Compatibility and Volume Control http://www.fcc.gov/cgb/consumerfacts/hac_wireless.html

Limited Warranty Statement

1. WHAT THIS WARRANTY COVERS:

LG offers you a limited warranty that the enclosed subscriber unit and its enclosed accessories will be free from defects in material and workmanship, according to the following terms and conditions:

- (1) The limited warranty for the product extends for TWELVE (12) MONTHS beginning on the date of purchase of the product with valid proof of purchase, or absent valid proof of purchase, FIFTEEN (15) MONTHS from date of manufacture as determined by the unit's manufacture date code.
- (2) The limited warranty extends only to the original purchaser of the product and is not assignable or transferable to any subsequent purchaser/end user.
- (3) This warranty is good only to the original purchaser of the product during the warranty period as long as it is in the U.S., including Alaska, Hawaii, U.S. Territories and Canada.
- (4) The external housing and cosmetic parts shall be free of defects at the time of shipment and, therefore, shall not be covered under these limited warranty terms.
- (5) Upon request from LG, the consumer must provide information to reasonably prove the date of purchase.
- (6) The customer shall bear the cost of shipping the product to the Customer Service Department of LG. LG shall bear the cost of shipping the product back to the consumer after the completion of service under this limited warranty.

2. WHAT THIS WARRANTY DOES NOT COVER:

- (1) Defects or damages resulting from use of the product in other than its normal and customary manner.
- (2) Defects or damages from abnormal use, abnormal conditions, improper storage, exposure to moisture or dampness, unauthorized modifications, unauthorized connections, unauthorized repair, misuse, neglect, abuse, accident, alteration, improper installation, or other acts which are not the fault of LG, including damage caused by shipping, blown fuses, spills of food or liquid.
- (3) Breakage or damage to antennas unless caused directly by defects in material or workmanship.
- (4) That the Customer Service Department at LG was not notified by consumer of the alleged defect or malfunction of the product during the applicable limited warranty period.
- (5) Products which have had the serial number removed or made illegible.
- (6) This limited warranty is in lieu of all other warranties, express or implied either in fact or by operations of law, statutory or otherwise, including, but not limited to any implied warranty of marketability or fitness for a particular use.
- (7) Damage resulting from use of non LG approved accessories.
- (8) All plastic surfaces and all other externally exposed parts that are scratched or damaged due to normal customer use.
- (9) Products operated outside published maximum ratings.
- (10) Products used or obtained in a rental program.
- (11) Consumables (such as fuses).

3. WHAT LG WILL DO:

LG will, at its sole option, either repair, replace or refund the purchase price of any unit that is covered under this limited warranty. LG may choose at its option to use functionally equivalent re-conditioned, refurbished or new units or parts or any units. In addition, LG will not re-install or back-up any data, applications or software that you have added to your phone. It is therefore recommended that you back-up any such data or information prior to sending the unit to LG to avoid the permanent loss of such information.

4. STATE LAW RIGHTS:

No other express warranty is applicable to this product. THE DURATION OF ANY IMPLIED WARRANTIES, INCLUDING THE IMPLIED WARRANTY OF MARKETABILITY OR MERCHANTABILITY OR FITNESS FOR A PARTICULAR PURPOSE, IS LIMITED TO THE DURATION OF THE EXPRESS WARRANTY HEREIN. LG SHALL NOT BE LIABLE FOR THE LOSS OF THE USE OF THE PRODUCT, INCONVENIENCE, LOSS OR ANY OTHER DAMAGES, DIRECT OR CONSEQUENTIAL, ARISING OUT OF THE USE OF, OR INABILITY TO USE, THIS PRODUCT OR FOR ANY BREACH OF ANY EXPRESS OR IMPLIED WARRANTY, INCLUDING THE IMPLIED WARRANTY OF MARKETABILITY OR MERCHANTABILITY OR FITNESS FOR A PARTICULAR PURPOSE APPLICABLE TO THIS PRODUCT.

Some states do not allow the exclusive limitation of incidental or consequential damages or limitations on how long an implied warranty lasts; so these limitations or exclusions may not apply to you. This warranty gives you specific legal rights and you may also have other rights which vary from state to state.

5. HOW TO GET WARRANTY SERVICE:

To obtain warranty service, please call or fax to the following telephone numbers from anywhere in the continental United States:

Tel. 1-800-793-8896

Or visit <http://us.lgservice.com>. Correspondence may also be mailed to:

LG Electronics Service- Mobile Handsets, P.O. Box 240007, Huntsville, AL 35824

DO NOT RETURN YOUR PRODUCT TO THE ABOVE ADDRESS. Please call or write for the location of the LG authorized service center nearest you and for the procedures for obtaining warranty claims.