

SAR TEST REPORT

Test item : Cellular/PCS GSM/GPRS/EDGE/WCDMA/HSDPA/HSUPA Phone with Bluetooth and WLAN
Model No. : LG-D150g, LG-D150G, D150g, D150G, LGD150g, LGD150G
Order No. : DEMC1404-01246
Date of receipt : 2014-04-07
Test duration : 2014-04-21 ~ 2014-04-28
Date of issue : 2014-05-07
Use of report : FCC Original Grant

Applicant : LG Electronics MobileComm U.S.A., Inc.
1000 Sylvan Avenue, Englewood Cliffs NJ 07632

Test laboratory : Digital EMC Co., Ltd.
42, Yurim-ro, 154beon-gil, Cheoin-gu, Yongin-si, Gyeonggi-do, Korea 449-935

Test rule part : CFR §2.1093
Test environment : See appended test report
Test result : Pass Fail

The test results presented in this test report are limited only to the sample supplied by applicant and the use of this test report is inhibited other than its purpose. This test report shall not be reproduced except in full, without the written approval of DIGITAL EMC CO., LTD.

Tested by:

Witnessed by:

Reviewed by:



Engineer
BumJun, Park

Engineer
N/A



Technical Director
Harvey Sung

Table of Contents

1. DESCRIPTION OF DEVICE	5
1.1 Guidance Applied	6
1.2 Device Overview	6
1.3 Nominal and Maximum Output Power Specifications.....	6
1.4 DUT Antenna Locations	7
1.5 SAR Test Exclusions Applied	8
1.6 Power Reduction for SAR	8
1.7 Device Serial Numbers	8
2. INTROCUCTION	9
3. DESCRIPTION OF TEST EQUIPMENT	10
3.1 SAR MEASUREMENT SETUP.....	10
3.2 EX3DV4 Probe Specification	11
3.3 Probe Calibration Process	12
3.3.1 E-Probe Calibration	12
3.4 Data Extrapolation.....	13
3.5 SAM Twin PHANTOM	14
3.6 Device Holder for Transmitters.....	14
3.7 Brain & Muscle Simulation Mixture Characterization.....	15
3.8 SAR TEST EQUIPMENT	16
4. TEST SYSTEM SPECIFICATIONS	17
5. SAR MEASUREMENT PROCEDURE	18
5.1 Measurement Procedure.....	18
6. DEFINITION OF REFERENCE POINTS	19
6.1 Ear Reference Point.....	19
6.2 Handset Reference Points	19
7. TEST CONFIGURATION POSITIONS FOR HANDSETS	20
7.1 Device Holder.....	20
7.2 Positioning for Cheek/Touch	20
7.3 Positioning for Ear / 15 ° Tilt.....	20
7.4 Body-Worn Accessory Configurations.....	21
7.5 Extremity Exposure Configurations.....	21
7.6 Wireless Router Configurations	22
8. RF EXPOSURE LIMITS	23
9. FCC MEASUREMENT PROCEDURES	24
9.1 Measured and Reported SAR.....	24
9.2 Procedures Used to Establish RF Signal for SAR	24
9.3 SAR Measurement Conditions for WCDMA (UMTS).....	24
9.3.1 Output Power Verification.....	24
9.3.2 Head SAR Measurements for Handsets	24
9.3.3 Body SAR Measurements	25
9.3.4 SAR Measurements for Handsets with Rel 5 HSDPA.....	25
9.3.5 SAR Measurements for Handsets with Rel 6 HSUPA.....	25
9.4 SAR Testing with 802.11 Transmitters	26
9.4.1 General Device Setup	26
9.4.2 Frequency Channel Configurations.....	26
10. RF CONDUCTED POWERS	27
10.1 GSM Conducted Powers.....	27

Table of Contents

10.2 WCDMA Conducted Powers	28
10.3 WLAN Conducted Powers	29
10.4 Bluetooth Conducted Powers.....	30
11. SYSTEM VERIFICATION	31
11.1 Tissue Verification.....	31
11.2 Test System Verification	32
12. SAR TEST RESULTS	33
12.1 Head SAR Results	33
12.2 Standalone Body-Worn SAR Results	35
12.3 Standalone Wireless router SAR Results	36
12.4 SAR Test Notes.....	38
13. FCC MULTI-TX AND ANTENNA SAR CONSIDERATIONS	40
13.1 Introduction.....	40
13.2 Simultaneous Transmission Procedures.....	40
13.3 Simultaneous Transmission Capabilities	40
13.4 Head SAR Simultaneous Transmission Analysis.....	42
13.5 Body-Worn Simultaneous Transmission Analysis.....	42
13.6 Hotspot SAR Simultaneous Transmission Analysis.....	43
13.7 Simultaneous Transmission Conclusion	43
14. SAR MEASUREMENT VARIABILITY	44
14.1 Measurement Variability	44
14.2 Measurement Uncertainty	44
15. IEEE P1528 –MEASUREMENT UNCERTAINTIES.....	45
16.CONCLUSION.....	51
17. REFERENCES	52
Attachment 1. – Probe Calibration Data	54
Attachment 2. – Dipole Calibration Data	66
Attachment 3. – SAR SYSTEM VALIDATION.....	91

Test Report Version

Test Report No.	Date	Description
DRTFCC1405-0570	May. 07, 2014	Final version for approval

1. DESCRIPTION OF DEVICE

Environmental evaluation measurements of specific absorption rate (SAR) distributions in emulated human head and body tissues exposed to radio frequency (RF) radiation from wireless portable devices for compliance with the rules and regulations of the U.S. Federal Communications Commission (FCC).

General Information:

EUT type	Cellular/PCS GSM/GPRS/EDGE / WCDMA/HSDPA/HSUPA Phone with Bluetooth and WLAN				
FCC ID	ZNFD150G				
Equipment model name	LG-D150g				
Equipment add model name	LG-D150G, D150g, D150G, LGD150g, LGD150G ● Six models are same mechanical, electrical and functional. ● The only difference is the model name, which are changed for marketing purpose.				
Equipment serial no.	Identical prototype				
Mode(s) of Operation	GSM 850, PCS 1900, WCDMA 850, WCDMA 1900, 2.4 G W-LAN (802.11b/g/n HT20)				
TX Frequency Range	824.2 ~ 848.8 MHz (Cellular Band) / 1850.2 ~ 1909.8 MHz (PCS Band) 826.4 ~ 846.6 MHz (WCDMA FDD V) / 1852.4 ~ 1907.6 MHz (WCDMA FDD II) 2412 ~ 2462 MHz (802.11b)				
RX Frequency Range	869.2 ~ 893.8 MHz (Cellular Band) / 1930.2 ~ 1989.8 MHz (PCS Band) 871.4 ~ 891.6 MHz (WCDMA FDD V) / 1932.4 ~ 1987.6 MHz (WCDMA FDD II) 2412 ~ 2462 MHz (802.11b)				
Equipment Class	Band	Measured Conducted Power [dBm]	Reported SAR		
			1g SAR (W/kg)		
			Head	Body-worn	Hotspot
PCE	GSM 850	33.0	0.49	0.98	-
PCE	GPRS 850	31.4	0.72	1.15	1.15
PCE	PCS 1900	29.9	0.74	0.60	-
PCE	GPRS 1900	25.8	1.14	0.76	0.76
PCE	WCDMA 850	23.08	0.55	0.95	0.95
PCE	WCDMA 1900	23.00	1.16	1.18	1.18
DTS	2.4 GHz W-LAN	14.08	0.19	0.15	0.15
DSS/DTS	Bluetooth	6.60	N/A		
Simultaneous SAR per KDB 690783 D01v01r03			1.21	1.33	1.33
FCC Equipment Class	Licensed Portable Transmitter Held to Ear (PCE)				
Date(s) of Tests	2014-04-21 ~ 2014-04-28				
Antenna Type	Internal Type Antenna				
Functions	<ul style="list-style-type: none"> ● GSM/GPRS(GPRS Class: 12) / EDGE(EDGE Class: 12) supported * DTM not supported ● BT(2.4GHz) / W-LAN(2.4GHz 802.11b/g/n(HT20)) supported * No simultaneous transmission between BT & WLAN ● Simultaneous transmission between GSM, WCDMA voice & WLAN / GPRS, WCDMA & WLAN ● VoIP supported. ● Mobile Hotspot supported. 				

1.1 Guidance Applied

- IEEE 1528-2003
- FCC KDB Publication 941225 D01 SAR test for 3G devices v02
- FCC KDB Publication 941225 D02 HSPA and 1x Advanced v02r02
- FCC KDB Publication 941225 D03 SAR Test Reduction GSM GPRS EDGE v01
- FCC KDB Publication 941225 D06 Hot Spot v01r01
- FCC KDB Publication 248227 D01v01r02 (SAR Considerations for 802.11 Devices)
- FCC KDB Publication 447498 D01v05r02 (General SAR Guidance)
- FCC KDB Publication 648474 D04 Handset SAR v01r02
- FCC KDB Publication 865664 D01 SAR Measurement 100 MHz to 6 GHz v01r03
- FCC KDB Publication 865664 D02 RF Exposure Reporting v01r01
- October 2013 TCB Workshop Notes (GPRS testing criteria)

1.2 Device Overview

Band & Mode	Operating Modes	Tx Frequency
GSM/GPRS/EDGE 850	Voice/Data	824.2 ~ 848.8 MHz
GSM/GPRS/EDGE 1900	Voice/Data	1850.2 ~ 1909.8 MHz
WCDMA 850	Voice/Data	826.4 ~ 846.6 MHz
WCDMA 1900	Voice/Data	1852.4 ~ 1907.6 MHz
2.4 GHz WLAN	Data	2412 ~ 2462 MHz
Bluetooth	Data	2402 ~ 2480 MHz

1.3 Nominal and Maximum Output Power Specifications

This device operates using the following maximum and nominal output power specifications. SAR values were scaled to the maximum allowed power to determine compliance per KDB Publication 447498 D01v05r02.

Band & Mode		Voice [dBm]	Burst Average GMSK [dBm]				Burst Average 8-PSK [dBm]			
			1 TX Slot	2 TX Slot	3 TX Slot	4 TX Slot	1 TX Slot	2 TX Slot	3 TX Slot	4 TX Slot
GSM/GPRS/EDGE 850	Maximum	33.2	33.2	31.4	29.4	28.3	27.7	26.7	25.7	24.7
	Nominal	32.7	32.7	30.9	28.9	27.8	27.2	26.2	25.2	24.2
GSM/GPRS/EDGE 1900	Maximum	30.2	30.2	28.7	26.7	25.8	26.7	26.3	25.3	24.3
	Nominal	29.7	29.7	28.2	26.2	25.3	26.2	25.8	24.8	23.8

Band & Mode		3GPP WCDMA	Modulated Average [dBm]			
			3GPP HSDPA			
			Rel. 5			
		Rel. 99	Subtest 1	Subtest 2	Subtest 3	Subtest 4
WCDMA 850	Maximum	23.2	22.2	22.2	22.2	22.2
	Nominal	22.7	21.7	21.7	21.7	21.7
WCDMA 1900	Maximum	23.2	22.1	22.1	22.1	22.1
	Nominal	22.7	21.6	21.6	21.6	21.6

Note : This device supports HSUPA but the manufacturer only declares on the tune-up procedure that the HSUPA transmitter's power will not exceed the R99 maximum transmit power in devices based on Qualcomm's HSPA chipset solution.

Band & Mode		Modulated Average [dBm]
IEEE 802.11b (2.4 GHz)	Maximum	15.0
	Nominal	14.0
IEEE 802.11g (2.4 GHz)	Maximum	12.0
	Nominal	11.0
IEEE 802.11n (2.4 GHz)	Maximum	11.0
	Nominal	10.0
Bluetooth 1 Mbps	Maximum	8.0
	Nominal	6.0
Bluetooth 2 Mbps	Maximum	5.5
	Nominal	3.5
Bluetooth 3 Mbps	Maximum	5.5
	Nominal	3.5
Bluetooth LE	Maximum	-0.5
	Nominal	-2.5

1.4 DUT Antenna Locations

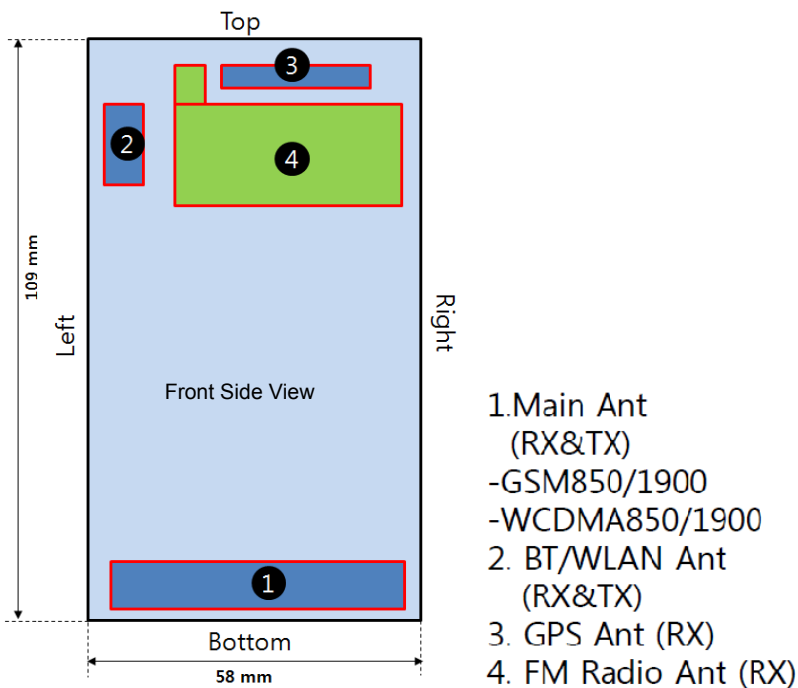

Note 1: Exact antenna dimensions and separation distances are shown in the “Antenna Location_ZNFD150G” in the FCC Filing.

Mode	Mobile Hotspot Sides for SAR Testing					
	Top	Bottom	Front	Rear	Right	Left
GPRS 850	X	O	O	O	O	O
GPRS 1900	X	O	O	O	O	O
WCDMA 850	X	O	O	O	O	O
WCDMA 1900	X	O	O	O	O	O
2.4G W-LAN(802.11b/g/n)	O	X	O	O	X	O

Table 1.1 Mobile Hotspot Sides for SAR Testing

Note:

- Particular DUT edges were not required to be evaluated for Wireless Router SAR if the edges were greater than 2.5 cm from the transmitting antenna according to FCC KDB Publication 941225 D06v01r01 guidance, page 2. The antenna document shows the distances between the transmit antennas and the edges of the device.

1.5 SAR Test Exclusions Applied

(A) WIFI & BT

Per FCC KDB 447498 D01v05r02, the SAR exclusion threshold for distances < 50 mm is defined by the following equation:

$$\frac{\text{Max Power of Channel (mW)}}{\text{Test Separation Dist (mm)}} * \sqrt{\text{Frequency(GHz)}} \leq 3.0$$

Based on the maximum conducted power of **Bluetooth** (rounded to the nearest mW) and the antenna to user separation distance, **Bluetooth SAR was not required**; $[(6/10) * \sqrt{2.480}] = \underline{1.0} < 3.0$.

Based on the maximum conducted power of **Bluetooth LE** (rounded to the nearest mW) and the antenna to user separation distance, **Bluetooth LE SAR was not required**; $[(1/10) * \sqrt{2.480}] = \underline{0.1} < 3.0$.

Based on the maximum conducted power of **2.4 GHz WIFI** (rounded to the nearest mW) and the antenna to user separation distance, **2.4 GHz WIFI SAR was required**; $[(30/10) * \sqrt{2.462}] = \underline{5.0} > 3.0$.

Per KDB Publication 447498 D01v05r02, the maximum power of the channel was rounded to the nearest mW before calculation.

(B) Licensed Transmitter(s)

GSM/GPRS/EDGE DTM is not supported for US bands. Therefore, the GSM Voice modes in this report do not transmit simultaneously with GPRS/EDGE Data.

1.6 Power Reduction for SAR

There is no power reduction used for any band/mode implemented in this device for SAR purposes.

1.7 Device Serial Numbers

Band & Mode	Head Serial Number	Body-Worn Serial Number	Hotspot Serial Number
GSM/GPRS/EDGE 850	FCC #1	FCC #1	FCC #1
GSM/GPRS/EDGE 1900	FCC #1	FCC #1	FCC #1
WCDMA 850	FCC #1	FCC #1	FCC #1
WCDMA 1900	FCC #1	FCC #1	FCC #1
2.4 GHz WLAN	FCC #1	FCC #1	FCC #1

2. INTROCUCTION

The FCC and Industry Canada have adopted the guidelines for evaluating the environmental effects of radio frequency (RF) radiation in ET Docket 93-62 on Aug. 6, 1996 and Health Canada Safety Code 6 to protect the public and workers from the potential hazards of RF emissions due to FCC-regulated portable devices.

The FCC has adopted the guidelines for evaluating the environmental effects of radio frequency radiation in ET Docket 93-62 on Aug. 6, 1996 to protect the public and workers from the potential hazards of RF emissions due to FCC-regulated portable devices. The safety limits used for the environmental evaluation measurements are based on the criteria published by the American National Standards Institute (ANSI) for localized specific absorption rate (SAR) in IEEE/ANSI C95*.1-2005 Standard for Safety Levels with Respect to Human Exposure to Radio Frequency Electromagnetic Fields, 3 kHz to 300 GHz. 1992 by the Institute of Electrical and Electronics Engineers, Inc., New York, New York 10017. The measurement procedure described in IEEE/ANSI C95.3-1992 Recommended Practice for the Measurement of Potentially Hazardous Electromagnetic Fields - RF and Microwave is used for guidance in measuring SAR due to the RF radiation exposure from the Equipment Under Test (EUT). These criteria for SAR evaluation are similar to those recommended by the National Council on Radiation Protection and Measurements (NCRP) in Biological Effects and Exposure Criteria for Radio frequency Electromagnetic Fields," NCRP Report No. 86 NCRP, 1986, Bethesda, MD 20814. SAR is a measure of the rate of energy absorption due to exposure to an RF transmitting source. SAR values have been related to threshold levels for potential biological hazards.

SAR Definition

Specific Absorption Rate (SAR) is defined as the time derivative (rate) of the incremental energy (dU) absorbed by (dissipated in) an incremental mass (dm) contained in a volume element (dV) of a given density (ρ) It is also defined as the rate of RF energy absorption per unit mass at a point in an absorbing body (see Fig. 2.1)

$$SAR = \frac{d}{dt} \left(\frac{dU}{dm} \right) = \frac{d}{dt} \left(\frac{dU}{\rho dv} \right)$$

Fig. 2.1 SAR Mathematical Equation

SAR is expressed in units of Watts per Kilogram (W/kg).

$$SAR = \frac{\sigma \cdot E^2}{\rho}$$

where:

- σ = conductivity of the tissue-simulating material (S/m)
- ρ = mass density of the tissue-simulating material (kg/m³)
- E = Total RMS electric field strength (V/m)

NOTE: The primary factors that control rate of energy absorption were found to be the wavelength of the incident field in relations to the dimensions and geometry of the irradiated organism, the orientation of the organism in relation to the polarity of field vectors, the presence of reflecting surfaces, and whether conductive contact is made by the organism with a ground plane.

3.2 EX3DV4 Probe Specification

Calibration	In air from 10 MHz to 6 GHz In brain and muscle simulating tissue at Frequencies of 450 MHz, 600 MHz, 750 MHz, 835 MHz, 900 MHz, 1750 MHz, 1900 MHz, 2300 MHz, 2450 MHz, 2600 MHz, 3500 MHz, 5200 MHz, 5300 MHz, 5500 MHz, 5600 MHz, 5800 MHz
Frequency	10 MHz to 6 GHz
Linearity	± 0.2 dB (30 MHz to 6 GHz)
Dynamic	10 μ W/g to > 100 mW/g
Range	Linearity : ± 0.2 dB
Dimensions	Overall length : 337 mm
Tip length	20 mm
Body diameter	12 mm
Tip diameter	2.5 mm
Distance from probe tip to sensor center	1.0 mm
Application	SAR Dosimetry Testing Compliance tests of mobile phones

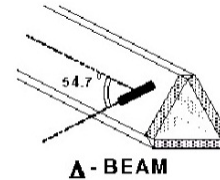
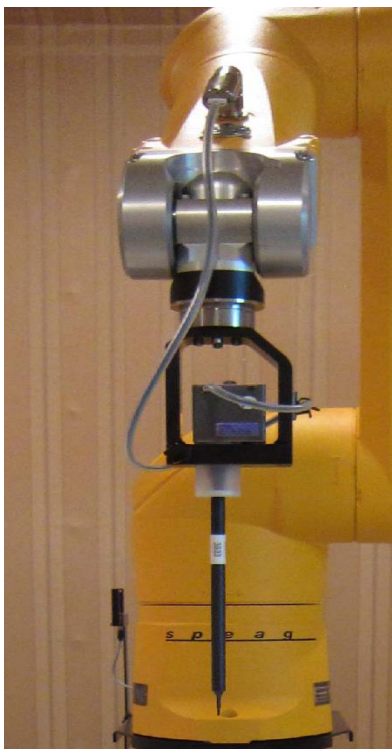

Figure 3.2 Triangular Probe Configurations



Figure 3.3 Probe Thick-Film Technique



DAE System

The SAR measurements were conducted with the dosimetric probe EX3DV4, designed in the classical triangular configuration (see Fig. 3.2) and optimized for dosimetric evaluation. The probe is constructed using the thick film technique; with printed resistive lines on ceramic substrates. The probe is equipped with an optical multitier line ending at the front of the probe tip. It is connected to the EOC box on the robot arm and provides an automatic detection of the phantom surface. Half of the fibers are connected to a pulsed infrared transmitter, the other half to a synchronized receiver. As the probe approaches the surface, the reflection from the surface produces a coupling from the transmitting to the receiving fibers. This reflection increases first during the approach, reaches maximum and then decreases. If the probe is flatly touching the surface, the coupling is zero. The distance of the coupling maximum to the surface is independent of the surface reflectivity and largely independent of the surface to probe angle. The DASY5 software reads the reflection during a software approach and looks for the maximum using a 2nd order fitting. The approach is stopped at reaching the maximum.

3.3 Probe Calibration Process

3.3.1 E-Probe Calibration

Dosimetric Assessment Procedure

Each probe is calibrated according to a dosimetric assessment procedure with accuracy better than +/- 10%. The spherical isotropy was evaluated with the procedure and found to be better than +/-0.25dB. The sensitivity parameters (NormX, NormY, NormZ), the diode compression parameter (DCP) and the conversion factor (ConvF) of the probe is tested.

Free Space Assessment

The free space E-field from amplified probe outputs is determined in a test chamber. This is performed in a TEM cell for frequencies below 1 GHz, and in a waveguide above 1GHz for free space. For the free space calibration, the probe is placed in the volumetric center of the cavity at the proper orientation with the field. The probe is then rotated 360 degrees.

Temperature Assessment *

E-field temperature correlation calibration is performed in a flat phantom filled with the appropriate simulated brain tissue. The measured free space E-field in the medium, correlates to temperature rise in a dielectric medium. For temperature correlation calibration a RF transparent the remits or based temperature probe is used in conjunction with the E-field probe.

$$SAR = C \frac{\Delta T}{\Delta t}$$

where:

Δt = exposure time (30 seconds),

C = heat capacity of tissue (brain or muscle),

ΔT = temperature increase due to RF exposure.

$$SAR = \frac{|E|^2 \cdot \sigma}{\rho}$$

where:

σ = simulated tissue conductivity,

ρ = Tissue density (1.25 g/cm³ for brain tissue)

SAR is proportional to $\Delta T / \Delta t$, the initial rate of tissue heating, before thermal diffusion takes place. Now it's possible to quantify the electric field in the simulated tissue by equating the thermally derived SAR to the E- field;

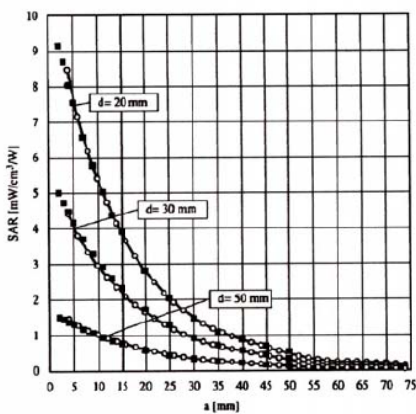

Figure 3.4 E-Field and Temperature Measurements at 900MHz

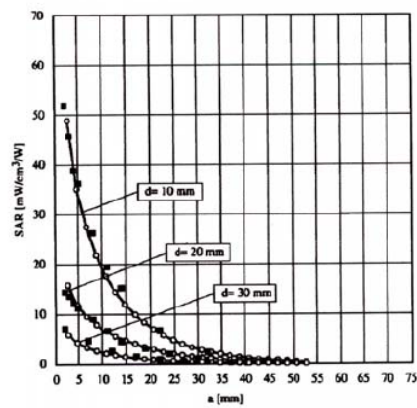

Figure 3.5 E-Field and Temperature Measurements at 1800MHz

3.4 Data Extrapolation

The DASYS5 software automatically executes the following procedures to calculate the field units from the microvolt readings at the probe connector. The first step of the evaluation is a linearization of the filtered input signal to account for the compression characteristics of the detector diode. The compensation depends on the input signal, the diode type and the DC-transmission factor from the diode to the evaluation electronics. If the exciting field is pulsed, the crest factor of the signal must be known to correctly compensate for peak power. The formula for each channel can be given like below;

$$V_i = U_i + U_i^2 \cdot \frac{cf}{dcp_i}$$

with V_i = compensated signal of channel i (i=x,y,z)
 U_i = input signal of channel i (i=x,y,z)
 cf = crest factor of exciting field (DASY parameter)
 dcp_i = diode compression point (DASY parameter)

From the compensated input signals the primary field data for each channel can be evaluated:

E-field probes: with V_i = compensated signal of channel i (i = x,y,z)
 $Norm_i$ = sensor sensitivity of channel i (i = x,y,z)
 $\mu V/(V/m)^2$ for E-field probes
 $ConvF$ = sensitivity of enhancement in solution
 E_i = electric field strength of channel i in V/m

$$E_i = \sqrt{\frac{V_i}{Norm_i \cdot ConvF}}$$

The RSS value of the field components gives the total field strength (Hermetian magnitude):

$$E_{tot} = \sqrt{E_x^2 + E_y^2 + E_z^2}$$

The primary field data are used to calculate the derived field units.

$$SAR = E_{tot}^2 \cdot \frac{\sigma}{\rho \cdot 1000}$$

with SAR = local specific absorption rate in W/g
 E_{tot} = total field strength in V/m
 σ = conductivity in [mho/m] or [Siemens/m]
 ρ = equivalent tissue density in g/cm³

The power flow density is calculated assuming the excitation field to be a free space field.

$$P_{free} = \frac{E_{tot}^2}{3770}$$

with P_{pwe} = equivalent power density of a plane wave in W/cm²
 E_{tot} = total electric field strength in V/m

3.5 SAM Twin PHANTOM

The SAM Twin Phantom V5.0 is constructed of a fiberglass shell integrated in a wooden table. The shape of the shell is based on data from an anatomical study designed to determine the maximum exposure in at least 90% of all users. It enables the dosimetric evaluation of left and right hand phone usage as well as body mounted usage at the flat phantom region. A cover prevents the evaporation of the liquid.

Reference markings on the Phantom allow the complete setup of all predefined phantom positions and measurement grids by manually teaching three points in the robot. (see Fig. 3.6)



Figure 3.6 SAM Twin Phantom

SAM Twin Phantom Specification:

Construction	The shell corresponds to the specifications of the Specific Anthropomorphic Mannequin (SAM) phantom defined in IEEE 1528 and IEC 62209-1. It enables the dosimetric evaluation of left and right hand phone usage as well as body mounted usage at the flat phantom region. A cover prevents evaporation of the liquid. Reference markings on the phantom allow the complete setup of all predefined phantom positions and measurement grids by teaching three points with the robot. Twin SAM V5.0 has the same shell geometry and is manufactured from the same material as Twin SAM V4.0, but has reinforced top structure.
Shell Thickness	2 ± 0.2 mm
Filling Volume	Approx. 25 liters
Dimensions	Length: 1000 mm Width: 500 mm Height: adjustable feet

Specific Anthropomorphic Mannequin (SAM) Specifications:

The phantom for handset SAR assessment testing is a low-loss dielectric shell, with shape and dimensions derived from the anthropometric data of the 90th percentile adult male head dimensions as tabulated by the US Army. The SAM Twin Phantom shell is bisected along the mid-sagittal plane into right and left halves (see Fig. 3.7). The perimeter sidewalls of each phantom halves are extended to allow filling with liquid to a depth that is sufficient to minimize reflections from the upper surface. The liquid depth is maintained at a minimum depth of 15cm to minimize reflections from the upper surface.



Figure 3.7 Sam Twin Phantom shell

3.6 Device Holder for Transmitters

In combination with the Twin SAM Phantom V4.0/V4.0c, V5.0 or ELI4, the Mounting Device enables the rotation of the mounted transmitter device in spherical coordinates. Rotation point is the ear opening point. Transmitter devices can be easily and accurately positioned according to IEC, IEEE, FCC or other specifications. The device holder can be locked for positioning at different phantom sections (left head, right head, flat).

Note: A simulating human hand is not used due to the complex anatomical and geometrical structure of the hand that may produce infinite number of configurations. To produce the worst-case condition (the hand absorbs antenna output power), the hand is omitted during the tests.



Figure 3.8 Mounting Device

3.7 Brain & Muscle Simulation Mixture Characterization

The brain and muscle mixtures consist of a viscous gel using hydrox-ethylcellulose (HEC) gelling agent and saline solution (see Table 3.1). Preservation with a bactericide is added and visual inspection is made to make sure air bubbles are not trapped during the mixing process. The mixture is calibrated to obtain proper dielectric constant (permittivity) and conductivity of the desired tissue. The mixture characterizations used for the brain and muscle tissue simulating liquids are according to the data by C. Gabriel and G. Harts grove.

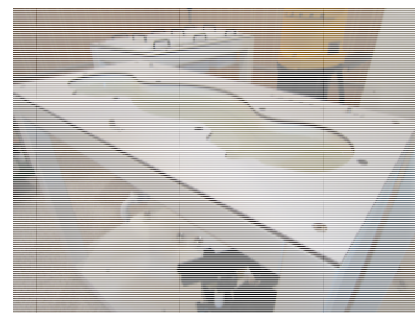

Figure 3.9 Simulated Tissue

Table 3.1 Composition of the Tissue Equivalent Matter

Ingredients (% by weight)	Frequency (MHz)							
	835		1900		2450		5200 ~ 5800	
Tissue Type	Head	Body	Head	Body	Head	Body	Head	Body
Water	40.19	50.75	55.24	70.23	71.88	73.40	65.52	80.00
Salt (NaCl)	1.480	0.940	0.310	0.290	0.160	0.060	-	-
Sugar	57.90	48.21	-	-	-	-	-	-
HEC	0.250	-	-	-	-	-	-	-
Bactericide	0.180	0.100	-	-	-	-	-	-
Triton X-100	-	-	-	-	19.97	-	17.24	-
DGBE	-	-	44.45	29.48	7.990	26.54	-	-
Diethylene glycol hexyl ether	-	-	-	-	-	-	17.24	-
Polysorbate (Tween) 80	-	-	-	-	-	-	-	20.00
Target for Dielectric Constant	41.5	55.2	40.0	53.3	39.2	52.7	-	-
Target for Conductivity (S/m)	0.90	0.97	1.40	1.52	1.80	1.95	-	-

Salt: 99 % Pure Sodium Chloride Sugar: 98 % Pure Sucrose
 Water: De-ionized, 16M resistivity HEC: Hydroxyethyl Cellulose
 DGBE: 99 % Di(ethylene glycol) butyl ether,[2-(2-butoxyethoxy) ethanol]
 Triton X-100(ultra pure): Polyethylene glycol mono[4-(1,1,3,3-tetramethylbutyl)phenyl] ether

3.8 SAR TEST EQUIPMENT

Table 3.2 Test Equipment Calibration

	Type	Manufacturer	Model	Cal.Date	Next.Cal.Date	S/N
<input checked="" type="checkbox"/>	SEMITEC Engineering	SEMITEC	N/A	N/A	N/A	Shield Room
<input checked="" type="checkbox"/>	Robot	SCHMID	TX90XL	N/A	N/A	F13/5P9GA1/A/01
<input checked="" type="checkbox"/>	Robot Controller	SCHMID	C58C	N/A	N/A	F13/5P9GA1/C/01
<input checked="" type="checkbox"/>	Joystick	SCHMID	N/A	N/A	N/A	S-12450905
<input checked="" type="checkbox"/>	Intel Core i7-3770 3,40 GHz Windows 7 Professional	N/A	N/A	N/A	N/A	N/A
<input checked="" type="checkbox"/>	Probe Alignment Unit LB	N/A	N/A	N/A	N/A	SE UKS 030 AA
<input checked="" type="checkbox"/>	Mounting Device	SCHMID	Holder	N/A	N/A	SD000H01HA
<input checked="" type="checkbox"/>	Twin SAM Phantom	SCHMID	QD000P40CD	N/A	N/A	1782
<input type="checkbox"/>	Twin SAM Phantom	SCHMID	QD000P40CD	N/A	N/A	1783
<input type="checkbox"/>	2mm Oval Phantom ELI5	SCHMID	QDOVA002AA	N/A	N/A	1237
<input checked="" type="checkbox"/>	Head/Body Equivalent Matter(835 MHz)	N/A	N/A	2014-01-01	2015-01-01	N/A
<input checked="" type="checkbox"/>	Head/Body Equivalent Matter(1900 MHz)	N/A	N/A	2014-01-01	2015-01-01	N/A
<input checked="" type="checkbox"/>	Head/Body Equivalent Matter(2450 MHz)	N/A	N/A	2014-01-01	2015-01-01	N/A
<input type="checkbox"/>	Head/Body Equivalent Matter(5 GHz)	N/A	N/A	2014-01-01	2015-01-01	N/A
<input checked="" type="checkbox"/>	Data Acquisition Electronics	SCHMID	DAE4	2013-09-09	2014-09-09	1394
<input checked="" type="checkbox"/>	Dosimetric E-Field Probe	SCHMID	EX3DV4	2013-09-10	2014-09-10	3930
<input type="checkbox"/>	Dummy Probe	N/A	N/A	N/A	N/A	N/A
<input checked="" type="checkbox"/>	835MHz SAR Dipole	SCHMID	D835V2	2013-09-05	2015-09-05	4d159
<input checked="" type="checkbox"/>	1900MHz SAR Dipole	SCHMID	D1900V2	2013-09-05	2015-09-05	5d176
<input checked="" type="checkbox"/>	2450MHz SAR Dipole	SCHMID	D2450V2	2013-09-10	2015-09-10	920
<input type="checkbox"/>	5000MHz SAR Dipole	SCHMID	D5GHzV2	2014-03-26	2016-03-26	1103
<input checked="" type="checkbox"/>	Network Analyzer	Agilent	E5071C	2013-10-21	2014-10-21	MY46106970
<input checked="" type="checkbox"/>	Signal Generator	Agilent	ESG-3000A	2013-06-27	2014-06-27	US37230529
<input checked="" type="checkbox"/>	Amplifier	EMPOWER	BBS3Q7ELU	2013-09-12	2014-09-12	1020
<input type="checkbox"/>	High Power RF Amplifier	EMPOWER	BBS3Q8CCJ	2013-10-22	2014-10-22	1005
<input checked="" type="checkbox"/>	Power Meter	HP	EPM-442A	2014-02-28	2015-02-28	GB37170267
<input checked="" type="checkbox"/>	Power Meter	Anritsu	ML2496A	2013-10-29	2014-10-29	1338004
<input checked="" type="checkbox"/>	Wide Bandwidth Power Sensor	Anritsu	MA2411B	2013-10-29	2014-10-29	1306053
<input checked="" type="checkbox"/>	Power Sensor	HP	8481A	2014-02-28	2015-02-28	3318A96566
<input checked="" type="checkbox"/>	Power Sensor	HP	8481A	2014-01-07	2015-01-07	3318A96030
<input checked="" type="checkbox"/>	Dual Directional Coupler	Agilent	778D-012	2014-01-07	2015-01-07	50228
<input checked="" type="checkbox"/>	Directional Coupler	HP	773D	2013-06-27	2014-06-27	2389A00640
<input checked="" type="checkbox"/>	Low Pass Filter 1,5GHz	Micro LAB	LA-15N	2014-01-07	2015-01-07	N/A
<input checked="" type="checkbox"/>	Low Pass Filter 3,0GHz	Micro LAB	LA-30N	2013-09-12	2014-09-12	N/A
<input type="checkbox"/>	Low Pass Filter 6,0GHz	Micro LAB	LA-60N	2013-03-12	2014-03-12	03942
<input checked="" type="checkbox"/>	Attenuators(3 dB)	Agilent	8491B	2013-06-27	2014-06-27	MY39260700
<input checked="" type="checkbox"/>	Attenuators(10 dB)	WEINSCHTEL	23-10-34	2014-01-07	2015-01-07	BP4387
<input type="checkbox"/>	Step Attenuator	HP	8494A	2013-09-12	2014-09-12	3308A33341
<input checked="" type="checkbox"/>	Dielectric Probe kit	SCHMID	DAK-3.5	2014-01-07	2015-01-07	1092
<input checked="" type="checkbox"/>	8960 Series 10 Wireless Comms. Test Set	Agilent	E5515C	2014-02-28	2015-02-28	GB43461134
<input checked="" type="checkbox"/>	Power Splitter	Anritsu	K241B	2013-10-22	2014-10-22	1701102
<input checked="" type="checkbox"/>	Bluetooth Tester	TESCOM	TC-3000B	2013-06-27	2014-06-27	3000B640046

NOTE: The E-field probe was calibrated by SPEAG, by temperature measurement procedure. Dipole Verification measurement is performed by Digital EMC before each test. The brain and muscle simulating material are calibrated by Digital EMC using the dielectric probe system and network analyzer to determine the conductivity and permittivity (dielectric constant) of the brain-equivalent material. Each equipment item was used solely within its respective calibration period.

4. TEST SYSTEM SPECIFICATIONS

Automated TEST SYSTEM SPECIFICATIONS:

Positioner

Robot	Stäubli Unimation Corp. Robot Model: TX90XL
Repeatability	0.02 mm
No. of axis	6

Data Acquisition Electronic (DAE) System

Cell Controller

Processor	Intel Core i7-3770
Clock Speed	3,40 GHz
Operating System	Windows 7 Professional
Data Card	DASY5 PC-Board

Data Converter

Features	Signal, multiplexer, A/D converter. & control logic
Software	DASY5
Connecting Lines	Optical downlink for data and status info Optical uplink for commands and clock

PC Interface Card

Function	24 bit (64 MHz) DSP for real time processing Link to DAE 4 16 bit A/D converter for surface detection system serial link to robot direct emergency stop output for robot
-----------------	--

E-Field Probes

Model	EX3DV4 S/N: 3930
Construction	Triangular core fiber optic detection system
Frequency	10 MHz to 6 GHz
Linearity	± 0.2 dB (30 MHz to 6 GHz)

Phantom

Phantom	SAM Twin Phantom (V5.0)
Shell Material	Composite
Thickness	2.0 ± 0.2 mm



Figure 2.2 DASY5 Test System

5. SAR MEASUREMENT PROCEDURE

5.1 Measurement Procedure

The evaluation was performed using the following procedure compliant to FCC KDB Publication 865664 D01v01r03 and IEEE 1528-2013:

1. The SAR distribution at the exposed side of the head or body was measured at a distance no greater than 5.0 mm from the inner surface of the shell. The area covered the entire dimension of the device-head and body interface and the horizontal grid resolution was determined per FCC KDB Publication 865664 D01v01r03 (See Table 5-1) and IEEE 1528-2013.
2. The point SAR measurement was taken at the maximum SAR region determined from Step 1 to enable the monitoring of SAR fluctuations/drifts during the 1g/10g cube evaluation. SAR at this fixed point was measured and used as a reference value.
3. Based on the area scan data, the peak of the region with maximum SAR was determined by spline interpolation. Around this point, a volume was assessed according to the measurement resolution and volume size requirements of FCC KDB Publication 865664 D01v01r03 (See Table 5-1) and IEEE 1528-2013. On the basis of this data set, the spatial peak SAR value was evaluated with the following procedure (see references or the DASY manual online for more details):
 - a. SAR values at the inner surface of the phantom are extrapolated from the measured values along the line away from the surface with spacing no greater than that in Table 3-1. The extrapolation was based on a least-squares algorithm. A polynomial of the fourth order was calculated through the points in the z-axis (normal to the phantom shell).
 - b. After the maximum interpolated values were calculated between the points in the cube, the SAR was averaged over the spatial volume (1g or 10g) using a 3D-Spline interpolation algorithm. The 3D-spline is composed of three one-dimensional splines with the "Not a knot" condition (in x, y, and z directions). The volume was then integrated with the trapezoidal algorithm. One thousand points (10 x 10 x 10) were obtained through interpolation, in order to calculate the averaged SAR.
 - c. All neighboring volumes were evaluated until no neighboring volume with a higher average value was found.
4. The SAR reference value, at the same location as step 2, was re-measured after the zoom scan was complete to calculate the SAR drift. If the drift deviated by more than 5%, the SAR test and drift measurements were repeated.

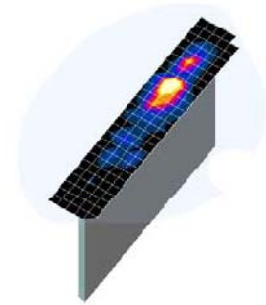

Figure 5.1
Sample SAR Area Scan

Frequency	Maximum Area Scan Resolution (mm) ($\Delta x_{area}, \Delta y_{area}$)	Maximum Zoom Scan Resolution (mm) ($\Delta x_{zoom}, \Delta y_{zoom}$)	Maximum Zoom Scan Spatial Resolution (mm)			Minimum Zoom Scan Volume (mm) (x,y,z)
			Uniform Grid	Graded Grid		
				$\Delta z_{zoom}(n)$	$\Delta z_{zoom}(1)^*$	
≤ 2 GHz	≤ 15	≤ 8	≤ 5	≤ 4	$\leq 1.5 * \Delta z_{zoom}(n-1)$	≥ 30
2-3 GHz	≤ 12	≤ 5	≤ 5	≤ 4	$\leq 1.5 * \Delta z_{zoom}(n-1)$	≥ 30
3-4 GHz	≤ 12	≤ 5	≤ 4	≤ 3	$\leq 1.5 * \Delta z_{zoom}(n-1)$	≥ 28
4-5 GHz	≤ 10	≤ 4	≤ 3	≤ 2.5	$\leq 1.5 * \Delta z_{zoom}(n-1)$	≥ 25
5-6 GHz	≤ 10	≤ 4	≤ 2	≤ 2	$\leq 1.5 * \Delta z_{zoom}(n-1)$	≥ 22

Table 5.1 Area and Zoom Scan Resolutions per FCC KDB Publication 865664 D01v01r03*

*Also compliant to IEEE 1528-2013 Table 6

6. DEFINITION OF REFERENCE POINTS

6.1 Ear Reference Point

Figure 6.1 shows the front, back and side views of the SAM Twin Phantom. The point “M” is the reference point for the center of the mouth, “LE” is the left ear reference point(ERP), and “RE” is the right ERP. The ERPs are 15mm posterior to the entrance to the Ear canal (EEC) along the B-M line (Back-Mouth), as shown in Figure 6.5. The plane Passing, through the two ear canals and M is defined as the Reference Plane. The line N-F (Neck- Front) is perpendicular to the reference plane and passing through the RE (or LE) is called the Reference Pivoting Line (see Figure 6.1). Line B-M is perpendicular to the N-F line. Both N-F and B-M lines are marked on the external phantom shell to facilitate handset positioning.

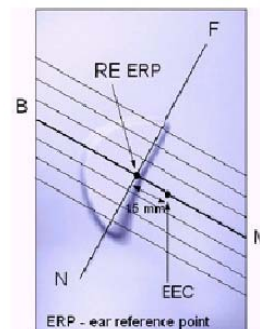

Figure 6.1
Close-up side view of ERP

6.2 Handset Reference Points

Two imaginary lines on the handset were established: the vertical centerline and the horizontal line. The test device was placed in a normal operating position with the “test device reference point” located along the “vertical centerline” on the front of the device aligned to the “ear reference point” (See Fig. 6.3). The “test device reference point” was then located at the same level as the center of the ear reference point. The test device was positioned so that the “vertical centerline” was bisecting the front surface of the handset at it’s top and bottom edges, positioning the “ear reference point” on the outer surface of the both the left and right head phantoms on the ear reference point.



Figure 6.2 Front, back and side view SAM Twin Phantom

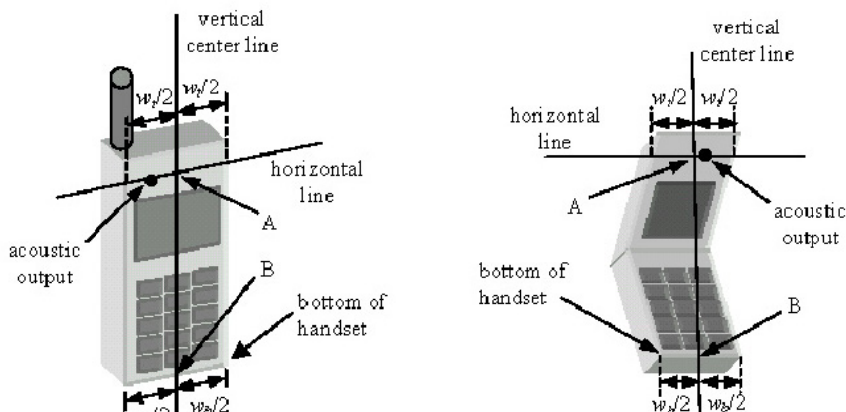

Figure 6.3 Handset Vertical Center & Horizontal Line Reference Points

7. TEST CONFIGURATION POSITIONS FOR HANDSETS

7.1 Device Holder

The device holder is made out of low-loss POM material having the following dielectric parameters: relative permittivity $\epsilon = 3$ and loss tangent $\delta = 0.02$.

7.2 Positioning for Cheek/Touch

1. The test device was positioned with the handset close to the surface of the phantom such that point A is on the (virtual) extension of the line passing through points RE and LE on the phantom (see Figure 7.1), such that the plane defined by the vertical center line and the horizontal line of the phone is approximately parallel to the sagittal plane of the phantom.

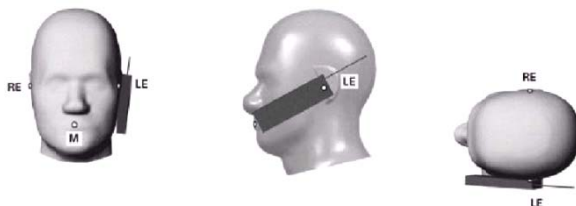

Figure 7.1 Front, Side and Top View of Cheek/Touch Position

2. The handset was translated towards the phantom along the line passing through RE & LE until the handset touches the ear.
3. While maintaining the handset in this plane, the handset was rotated around the LE-RE line until the vertical centerline was in the plane normal to MB-NF including the line MB (reference plane).
4. The phone was then rotated around the vertical centerline until the phone (horizontal line) was symmetrical with respect to the line NF.
5. While maintaining the vertical centerline in the reference plane, keeping point A on the line passing through RE and LE, and maintaining the phone contact with the ear, the handset was rotated about the line NF until any point on the handset made contact with a phantom point below the ear (cheek). (See Figure 7.2)

7.3 Positioning for Ear / 15 ° Tilt

With the test device aligned in the “Cheek/Touch Position”:

1. While maintaining the orientation of the phone, the phone was retracted parallel to the reference plane far enough to enable a rotation of the phone by 15 degrees.
2. The phone was then rotated around the horizontal line by 15 degree.
3. While maintaining the orientation of the phone, the phone was moved parallel to the reference plane until any part of the phone touches the head. (In this position, point A was located on the line RE-LE). The tilted position is obtained when the contact is on the pinna. If the contact was at any location other than the pinna, the angle of the phone would then be reduced. The tilted position was obtained when any part of the phone was in contact of the ear as well as a second part of the phone was in contact with the head (see Figure 7.3).

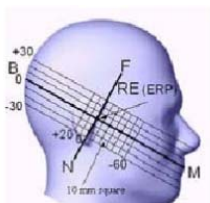

Figure 7.2 Side view w/relevant markings

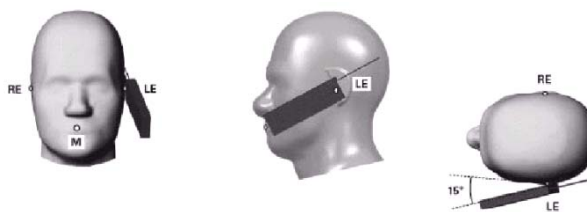

Figure 7.3 Front, Side and Top View of Ear/15° Position

7.4 Body-Worn Accessory Configurations

Body-worn operating configurations are tested with the belt-clips and holsters attached to the device and positioned against a flat phantom in a normal use configuration (see Figure 6.7). Per FCC KDB Publication 648474 D04v01r02, Body-worn accessory exposure is typically related to voice mode operations when handsets are carried in body-worn accessories. The body-worn accessory procedures in FCC KDB Publication 447498 D01v05r02 should be used to test for body-worn accessory SAR compliance, without a headset connected to it. This enables the test results for such configuration to be compatible with that required for hotspot mode when the body-worn accessory test separation distance is greater than or equal to that required for hotspot mode, when applicable. When the reported SAR for a body-worn accessory, measured without a headset connected to the handset, is > 1.2 W/kg, the highest reported SAR configuration for that wireless mode and frequency band should be repeated for that body-worn accessory with a headset attached to the handset.

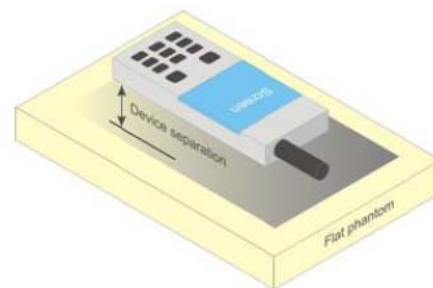

Figure 6.7 Sample Body-Worn Diagram

Accessories for Body-worn operation configurations are divided into two categories: those that do not contain metallic components and those that do contain metallic components. When multiple accessories that do not contain metallic components are supplied with the device, the device is tested with only the accessory that dictates the closest spacing to the body. Then multiple accessories that contain metallic components are tested with the device with each accessory. If multiple accessories share an identical metallic component (i.e. the same metallic belt-clip used with different holsters with no other metallic components) only the accessory that dictates the closest spacing to the body is tested.

Body-worn accessories may not always be supplied or available as options for some devices intended to be authorized for body-worn use. In this case, a test configuration with a separation distance between the back of the device and the flat phantom is used. Test position spacing was documented.

Transmitters that are designed to operate in front of a person's face, as in push-to-talk configurations, are tested for SAR compliance with the front of the device positioned to face the flat phantom in head fluid. For devices that are carried next to the body such as a shoulder, waist or chest-worn transmitters, SAR compliance is tested with the accessories, including headsets and microphones, attached to the device and positioned against a flat phantom in a normal use configuration.

7.5 Extremity Exposure Configurations

Devices that are designed or intended for use on extremities or mainly operated in extremity only exposure conditions; i.e., hands, wrists, feet and ankles, may require extremity SAR evaluation. When the device also operates in close proximity to the user's body, SAR compliance for the body is also required. The 1-g body and 10-g extremity SAR Exclusion Thresholds found in KDB Publication 447498 D01v05r02 should be applied to determine SAR test requirements.

Per KDB Publication 447498 D01v05r02, Cell phones (handsets) are not normally designed to be used on extremities or operated in extremity only exposure conditions. The maximum output power levels of handsets generally do not require extremity SAR testing to show compliance. Therefore, extremity SAR was not evaluated for this device.

7.6 Wireless Router Configurations

Some battery-operated handsets have the capability to transmit and receive user data through simultaneous transmission of WIFI simultaneously with a separate licensed transmitter. The FCC has provided guidance in FCC KDB Publication 941225 D06v01r01 where SAR test considerations for handsets ($L \times W \geq 9 \text{ cm} \times 5 \text{ cm}$) are based on a composite test separation distance of 10 mm from the front, back and edges of the device containing transmitting antennas within 2.5 cm of their edges, determined from general mixed use conditions for this type of devices. Since the hotspot SAR results may overlap with the body-worn accessory SAR requirements, the more conservative configurations can be considered, thus excluding some body-worn accessory SAR tests.

When the user enables the personal wireless router functions for the handset, actual operations include simultaneous transmission of both the WIFI transmitter and another licensed transmitter. Both transmitters often do not transmit at the same transmitting frequency and thus cannot be evaluated for SAR under actual use conditions due to the limitations of the SAR assessment probes.

Therefore, SAR must be evaluated for each frequency transmission and mode separately and spatially summed with the WIFI transmitter according to FCC KDB Publication 447498 D01v05r02 publication procedures. The "Portable Hotspot" feature on the handset was NOT activated during SAR assessments, to ensure the SAR measurements were evaluated for a single transmission frequency RF signal at a time.

8. RF EXPOSURE LIMITS

Uncontrolled Environment:

UNCONTROLLED ENVIRONMENTS are defined as locations where there is the exposure of individuals who have no knowledge or control of their exposure. The general population/uncontrolled exposure limits are applicable to situations in which the general public may be exposed or in which persons who are exposed as a consequence of their employment may not be made fully aware of the potential for exposure or cannot exercise control over their exposure. Members of the general public would come under this category when exposure is not employment-related; for example, in the case of a wireless transmitter that exposes persons in its vicinity.

Controlled Environment:

CONTROLLED ENVIRONMENTS are defined as locations where there is exposure that may be incurred by persons who are aware of the potential for exposure, (i.e. as a result of employment or occupation). In general, occupational/controlled exposure limits are employment, who have been made fully aware of the potential for exposure and can exercise control over their exposure. This exposure category is also applicable when the exposure is of a transient nature due to incidental passage through a location where the exposure levels may be higher than the general population/uncontrolled limits, but the exposed person is fully aware of the potential for exposure and can exercise control over his or her exposure by leaving the area or by some other appropriate means.

Table 8.1.SAR Human Exposure Specified in ANSI/IEEE C95.1-2005

	HUMAN EXPOSURE LIMITS	
	General Public Exposure (W/kg) or (mW/g)	Occupational Exposure (W/kg) or (mW/g)
SPATIAL PEAK SAR * (Brain)	1.60	8.00
SPATIAL AVERAGE SAR ** (Whole Body)	0.08	0.40
SPATIAL PEAK SAR *** (Hands / Feet / Ankle / Wrist)	4.00	20.0

1. The Spatial Peak value of the SAR averaged over any 1 gram of tissue (defined as a tissue volume in the shape of a cube) and over the appropriate averaging time.
2. The Spatial Average value of the SAR averaged over the whole body.
3. The Spatial Peak value of the SAR averaged over any 10 grams of tissue (defined as a tissue volume in the shape of a cube) and over the appropriate averaging time.

Uncontrolled Environments are defined as locations where there is the exposure of individuals who have no knowledge or control of their exposure.

Controlled Environments are defined as locations where there is exposure that may be incurred by persons who are aware of the potential for exposure, (i.e.as a result of employment or occupation).

9. FCC MEASUREMENT PROCEDURES

Power measurements were performed using a base station simulator under digital average power.

9.1 Measured and Reported SAR

Per FCC KDB Publication 447498 D01v05r02, When SAR is not measured at the maximum power level allowed for production units, the results must be scaled to the maximum tune-up tolerance limit according to the power applied to the individual channels tested to determine compliance. For simultaneous transmission, the measured aggregate SAR must be scaled according to the sum of the differences between the maximum tune-up tolerance and actual power used to test each transmitter. When SAR is measured at or scaled to the maximum tune-up tolerance limit, the results are referred to as reported SAR. The highest reported SAR results are identified on the grant of equipment authorization according to procedures in KDB 690783 D01v01r03.

9.2 Procedures Used to Establish RF Signal for SAR

The following procedures are according to FCC KDB Publication 941225 D01 "SAR Measurement Procedures for 3G Devices" v02, October 2007.

The device was placed into a simulated call using a base station simulator in a RF shielded chamber. Establishing connections in this manner ensure a consistent means for testing SAR and are recommended for evaluating SAR [4]. Devices under test were evaluated prior to testing, with a fully charged battery and were configured to operate at maximum output power. In order to verify that the device was tested throughout the SAR test at maximum output power, the SAR measurement system measures a "point SAR" at an arbitrary reference point at the start and end of the 1 gram SAR evaluation, to assess for any power drifts during the evaluation. If the power drift deviated by more than 5%, the SAR test and drift measurements were repeated.

9.3 SAR Measurement Conditions for WCDMA (UMTS)

9.3.1 Output Power Verification

Maximum output power is measured on the High, Middle and Low channels for each applicable transmission band according to the general descriptions in section 5.2 of 3GPP TS 34.121, using the appropriate RMC or AMR with TPC (transmit power control) set to all "1s".

Maximum output power is verified on the High, Middle and Low channels according to the general, descriptions in section 5.2 of 3GPP TS 34.121 (release 5), using the appropriate RMC with TPC,(transmit power control) set to all "1s" or applying the required inner loop power control procedures to maintain maximum output power while HSUPA is active. Results for all applicable physical channel configurations (DPCCH, DPDCHn and spreading codes, HS-DPCCH etc) are tabulated in this test report. All configurations that are not supported by the DUT or cannot be measured due to technical or equipment limitations are identified.

9.3.2 Head SAR Measurements for Handsets

SAR for head exposure configurations is measured using the 12.2 kbps RMC with TPC bits configured to all "1s". SAR in AMR configurations is not required when the maximum average output of each RF channel for 12.2 kbps AMR is less than 0.25 dB higher than that measured in 12.2 kbps RMC. Otherwise, SAR is measured on the maximum output channel in 12.2 AMR with a 3.4 kbps SRB (signaling radio bearer) using the exposure configuration that resulted in the highest SAR for that RF channel in the 12.2 kbps RMC mode.

9.3.3 Body SAR Measurements

SAR for body exposure configurations is measured using the 12.2 kbps RMC with the TPC bits all "1s".

9.3.4 SAR Measurements for Handsets with Rel 5 HSDPA

Body SAR for HSDPA is not required for handsets with HSDPA capabilities when the maximum average output power of each RF channel with HSDPA active is less than 0.25 dB higher than that measured without HSDPA using 12.2 kbps RMC and the maximum SAR for 12.2 kbps RMC is $\leq 75\%$ of the SAR limit. Otherwise, SAR is measured for HSDPA, using an FRC with H-Set 1 in Sub-test 1 and a 12.2 kbps RMC configured in Test Loop Mode 1, using the highest body SAR configuration measured in 12.2 kbps RMC without HSDPA, on the maximum output channel with the body exposure configuration that resulted in the highest SAR in 12.2 kbps RMC mode for that RF channel.

The H-set used in FRC for HSDPA should be configured according to the UE category of a test device. The number of HS-DSCH/HSPDSCHs, HARQ processes, minimum inter-TTI interval, transport block sizes and RV coding sequence are defined by the applicable H-set. To maintain a consistent test configuration and stable transmission conditions, QPSK is used in the FRC for SAR testing. HS-DPCCH should be configured with a CQI feedback cycle of 2 ms to maintain a constant rate of active CQI slots. DPCCH and DPDCH gain factors of $\beta_c=9$ and $\beta_d=15$, and power offset parameters of $\Delta_{ACK} = \Delta_{NACK} = 5$ and $\Delta_{CQI}=2$ is used. The CQI value is determined by the UE category, transport block size, number of HS-PDSCHs and modulation used in the FRC.

Sub-Test	β_c	β_d	β_d (SF)	β_c/β_d	β_{HS} (Note 1, Note 2)	CM (dB) (Note 3)	MPR (dB) (Note 3)
1	2/15	15/15	64	2/15	4/15	0.0	0.0
2	12/15 (Note 4)	15/15 (Note 4)	64	12/15 (Note 4)	24/15	1.0	0.0
3	15/15	8/15	64	15/8	30/15	1.5	0.5
4	15/15	4/15	64	15/4	30/15	1.5	0.5

Note 1: Δ_{ACK} , Δ_{NACK} and $\Delta_{CQI} = 8 \Leftrightarrow A_{HS} = \beta_{HS}/\beta_c = 30/15 \Leftrightarrow \beta_{HS} = 30/15 * \beta_c$.

Note 2: For the HS-DPCCH power mask requirement test in clause 5.2C, 5.7A, and the Error Vector Magnitude (EVM) with HS-DPCCH test in clause 5.13.1A, and HSDPA EVM with phase discontinuity in clause 5.13.1AA, Δ_{ACK} and $\Delta_{NACK} = 8$ ($A_{HS} = 30/15$) with $\beta_{HS} = 30/15 * \beta_c$, and $\Delta_{CQI} = 7$ ($A_{HS} = 24/15$) with $\beta_{HS} = 24/15 * \beta_c$.

Note 3: CM = 1 for $\beta_c/\beta_d = 12/15$, $\beta_{HS}/\beta_c = 24/15$. For all other combinations of DPDCH, DPCCH and HS-DPCCH the MPR is based on the relative CM difference. This is applicable for only UEs that support HSDPA in release 6 and later releases.

Figure 9.1 Table C.10.1.4 of TS 234.121-1

9.3.5 SAR Measurements for Handsets with Rel 6 HSUPA

Body SAR for HSUPA is not required when the maximum average output of each RF channel with HSUPA/HSDPA active is less than 0.25 dB higher than as measured without HSUPA/HSDPA using 12.2 kbps RMC and maximum SAR for 12.2 kbps RMC is $\leq 75\%$ of the SAR limit. Otherwise SAR is measured on the maximum output channel for the body exposure configuration produced highest SAR in 12.2 kbps RMC for that RF channel, using the additional procedures under "Release 6 HSPA data devices"

Head SAR for VOIP operations under HSPA is not required when maximum average output of each RF channel with HSPA is less than 0.25 dB higher than as measured using 12.2 kbps RMC. Otherwise SAR is measured using same HSPA configuration as used for body SAR.

Sub-test	β_c	β_d	β_d (SF)	β_c/β_d	$\beta_{hs}^{(1)}$	β_{ec}	β_{ed}	β_{ed} (SF)	β_{ed} (codes)	CM ⁽²⁾ (dB)	MPR (dB)	AG ⁽⁴⁾ Index	E-TFCI
1	11/15 ⁽³⁾	15/15 ⁽³⁾	64	11/15 ⁽³⁾	22/15	209/225	1039/225	4	1	1.0	0.0	20	75
2	6/15	15/15	64	6/15	12/15	12/15	94/75	4	1	3.0	2.0	12	67
3	15/15	9/15	64	15/9	30/15	30/15	$\beta_{ed1}: 47/15$ $\beta_{ed2}: 47/5$	4	2	2.0	1.0	15	92
4	2/15	15/15	64	2/15	4/15	2/15	56/75	4	1	3.0	2.0	17	71
5	15/15 ⁽⁴⁾	15/15 ⁽⁴⁾	64	15/15 ⁽⁴⁾	30/15	24/15	134/15	4	1	1.0	0.0	21	81

Note 1: Δ_{ACK} , Δ_{NACK} and $\Delta_{CQI} = 8 \Leftrightarrow A_{hs} = \beta_{hs}/\beta_c = 30/15 \Leftrightarrow \beta_{hs} = 30/15 * \beta_c$.

Note 2: CM = 1 for $\beta_c/\beta_d = 12/15$, $\beta_{hs}/\beta_c = 24/15$. For all other combinations of DPDCH, DPCCCH, HS-DPCCCH, E-DPDCH and E-DPCCCH the MPR is based on the relative CM difference.

Note 3: For subtest 1 the β_c/β_d ratio of 11/15 for the TFC during the measurement period (TF1, TF0) is achieved by setting the signaled gain factors for the reference TFC (TF1, TF1) to $\beta_c = 10/15$ and $\beta_d = 15/15$.

Note 4: For subtest 5 the β_c/β_d ratio of 15/15 for the TFC during the measurement period (TF1, TF0) is achieved by setting the signaled gain factors for the reference TFC (TF1, TF1) to $\beta_c = 14/15$ and $\beta_d = 15/15$.

Note 5: Testing UE using E-DPDCH Physical Layer category 1 Sub-test 3 is not required according to TS 25.306 Table 5.1g.

Note 6: β_{ed} can not be set directly; it is set by Absolute Grant Value.

9.4 SAR Testing with 802.11 Transmitters

Normal network operating configurations are not suitable for measuring the SAR of 802.11 b/g/n transmitters. Unpredictable fluctuations in network traffic and antenna diversity conditions can introduce undesirable variations in SAR results. The SAR for these devices should be measured using chipset based test mode software to ensure the results are consistent and reliable. See KDB Publication 248227 D01v01r02 for more details.

9.4.1 General Device Setup

Chipset based test mode software is hardware dependent and generally varies among manufacturers. The device operating parameters established in test mode for SAR measurements must be identical to those programmed in production units, including output power levels, amplifier gain settings and other RF performance tuning parameters. The test frequencies should correspond to actual channel frequencies defined for domestic use. SAR for devices with switched diversity should be measured with only one antenna transmitting at a time during each SAR measurement, according to a fixed modulation and data rate. The same data pattern should be used for all measurements.

9.4.2 Frequency Channel Configurations

For 2.4 GHz, the highest average RF output power channel between the low, mid and high channel at the lowest data rate was selected for SAR evaluation in 802.11b mode. 802.11g/n modes and higher data rates for 802.11b were additionally evaluated for SAR if the output power of the respective mode was 0.25 dB or higher than the powers of the SAR configurations tested in the 802.11b mode.

If the maximum extrapolated peak SAR of the zoom scan for the highest output channel was less than 1.6 W/kg and if the 1g averaged SAR was less than 0.8 W/kg, SAR testing was not required for the other test channels in the band.

10. RF CONDUCTED POWERS

10.1 GSM Conducted Powers

Table 10.1 The power was measured by E5515C

Band	Channel	Maximum Burst-Averaged Output Power (dBm)								
		Voice	GPRS/EDGE Data (GMSK)				EDGE Data (8-PSK)			
		GSM CS 1 Slot	GPRS 1 TX Slot	GPRS 2 TX Slot	GPRS 3 TX Slot	GPRS 4 TX Slot	EDGE 1 TX Slot	EDGE 2 TX Slot	EDGE 3 TX Slot	EDGE 4 TX Slot
GSM 850	128	32.8	32.8	31.3	29.3	28.2	26.9	26.4	25.4	24.3
	190	32.8	32.9	31.3	29.3	28.3	27.0	26.4	25.5	24.3
	251	33.0	33.0	31.4	29.4	28.3	27.1	26.5	25.5	24.4
PCS 1900	512	29.8	29.9	28.5	26.4	25.5	26.2	26.0	25.0	23.9
	661	29.9	29.9	28.6	26.5	25.6	26.2	26.0	25.1	23.9
	810	30.1	30.1	28.7	26.6	25.8	26.3	26.1	25.2	24.0
Band	Channel	Calculated Maximum Frame-Averaged Output Power (dBm)								
		Voice	GPRS/EDGE Data (GMSK)				EDGE Data (8-PSK)			
		GSM CS 1 Slot	GPRS 1 TX Slot	GPRS 2 TX Slot	GPRS 3 TX Slot	GPRS 4 TX Slot	EDGE 1 TX Slot	EDGE 2 TX Slot	EDGE 3 TX Slot	EDGE 4 TX Slot
GSM 850	128	23.77	23.77	25.28	25.04	25.19	17.87	20.38	21.14	21.29
	190	23.77	23.87	25.28	25.04	25.29	17.97	20.38	21.24	21.29
	251	23.97	23.97	25.38	25.14	25.29	18.07	20.48	21.24	21.39
PCS 1900	512	20.77	20.87	22.48	22.14	22.49	17.17	19.98	20.74	20.89
	661	20.87	20.87	22.58	22.24	22.59	17.17	19.98	20.84	20.89
	810	21.07	21.07	22.68	22.34	22.79	17.27	20.08	20.94	20.99
GSM 850	Frame Avg. Targets:	23.67	23.67	24.88	24.64	24.79	18.17	20.18	20.94	21.19
PCS 1900		20.67	20.67	22.18	21.94	22.29	17.17	19.78	20.54	20.79

Note:

- Both burst-averaged and calculated frame-averaged powers are included. Frame-averaged power was calculated from the measured burst-averaged power by converting the slot powers into linear units and calculating the energy over 8 timeslots.
- The source-based frame-averaged output power was evaluated for all GPRS/EDGE slot configurations. The configuration with the highest target frame averaged output power was evaluated for hotspot SAR. When the maximum frame-averaged powers are equivalent across two or more slots (within 0.25 dB), the configuration with the most number of time slots was tested.
- GPRS/EDGE (GMSK) output powers were measured with coding scheme setting of 1 (CS1) on the base station simulator. CS1 was configured to measure GPRS output power measurements and SAR to ensure GMSK modulation in the signal. Our investigation has shown that CS1 - CS4 settings do not have any impact on the output levels or modulation in the GPRS modes.
- EDGE (8-PSK) output powers were measured with MCS7 on the base station simulator. MCS7 coding scheme was used to measure the output powers for EDGE since investigation has shown that choosing MCS7 coding scheme will ensure 8-PSK modulation. It has been shown that MCS levels that produce 8PSK modulation do not have an impact on output power.

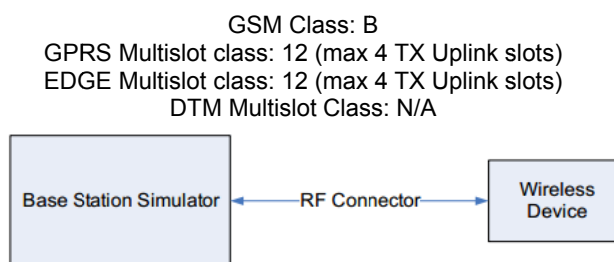

Figure 10.1 Power Measurement Setup

10.2 WCDMA Conducted Powers

3GPP Release Version	Mode	3GPP 34.121 Subtest	Cellular Band (dBm)			PCS Band (dBm)			3GPP MPR (dB)
			4132	4183	4233	9262	9400	9538	
99	WCDMA	12.2 kbps RMC	23.12	23.08	23.01	23.04	22.94	23.00	-
99		12.2 kbps AMR	23.11	23.00	22.95	22.98	22.93	22.93	-
5	HSDPA	Subtest 1	22.09	21.95	22.08	22.07	22.02	21.95	0
5		Subtest 2	22.16	22.17	22.03	22.02	21.99	21.99	0
5		Subtest 3	21.70	21.68	21.52	21.51	21.50	21.50	0.5
5		Subtest 4	21.68	21.65	21.52	21.49	21.50	21.53	0.5
6	HSUPA	Subtest 1	21.83	22.02	21.37	21.32	21.87	21.40	0
6		Subtest 2	20.51	20.78	20.99	20.66	21.05	20.97	2
6		Subtest 3	21.11	21.04	20.61	20.41	20.19	20.60	1
6		Subtest 4	21.67	21.15	21.19	20.99	21.63	21.17	2
6		Subtest 5	21.62	21.18	21.16	21.82	21.65	21.16	0

Table 10.2 The power was measured by E5515C

WCDMA SAR was tested under RMC 12.2 kbps with HSPA Inactive per KDB Publication 941225 D01v02r02. HSPA SAR was not required since the average output power of the HSPA subtests was not more than 0.25 dB higher than the RMC level and SAR was less than 1.2 W/kg.

This device does not support DC-HSDPA.

The manufacturer declares that the HSUPA transmitter's power will not exceed the R99 maximum transmit power in devices based on Qualcomm's HSPA chipset solutions.

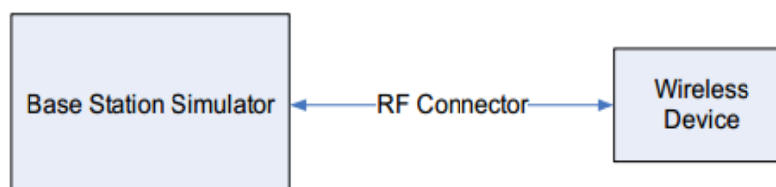

Figure 10.2 Power Measurement Setup

10.3 WLAN Conducted Powers

Mode	Freq. (MHz)	Channel	802.11b (2.4 GHz) Conducted Power (dBm)			
			Data Rate (Mbps)			
			1	2	5.5	11
802.11b	2412	1	13.47	13.44	13.47	13.46
	2437	6	13.77	13.67	13.69	13.76
	2462	11	<u>14.08</u>	13.99	14.05	14.07

Table 10.3 IEEE 802.11b Average RF Power

Mode	Freq. (MHz)	Channel	802.11g (2.4 GHz) Conducted Power (dBm)							
			Data Rate (Mbps)							
			6	9	12	18	24	36	48	54
802.11g	2412	1	10.18	10.05	10.14	10.05	10.05	10.13	10.05	10.10
	2437	6	10.89	10.84	10.85	10.86	10.48	10.83	10.76	10.83
	2462	11	11.11	10.99	10.98	10.99	10.79	10.98	11.07	11.05

Table 10.4 IEEE 802.11g Average RF Power

Mode	Freq. (MHz)	Channel	802.11n HT20 (2.4 GHz) Conducted Power (dBm)							
			Data Rate (Mbps)							
			6.5	13	19.5	26	39	52	58.5	65
802.11n (HT-20)	2412	1	9.48	9.35	9.44	9.35	9.36	9.44	9.36	9.40
	2437	6	10.04	9.99	10.00	10.01	9.63	9.98	9.91	9.98
	2462	11	10.31	10.19	10.18	10.19	9.99	10.18	10.27	10.25

Table 10.5 IEEE 802.11n Average RF Power

Justification for reduced test configurations for WIFI channels per KDB Publication 248227 D01v01r02 and October 2012 / April 2013 FCC/TCB Meeting Notes:

- For 2.4 GHz, highest average RF output power channel for the lowest data rate for IEEE 802.11b were selected for SAR evaluation. Other IEEE 802.11 modes (including 802.11g/n) were not investigated since the average output powers over all channels and data rates were not more than 0.25 dB higher than the tested channel in the lowest data rate of IEEE 802.11b mode.
- When the maximum extrapolated peak SAR of the zoom scan for the maximum output channel is <1.6 W/kg and the reported 1g averaged SAR is <0.8 W/kg, SAR testing on other channels is not required. Otherwise, the other default (or corresponding required) test channels were additionally tested using the lowest data rate.
- The underlined data rate and channel above were tested for SAR.

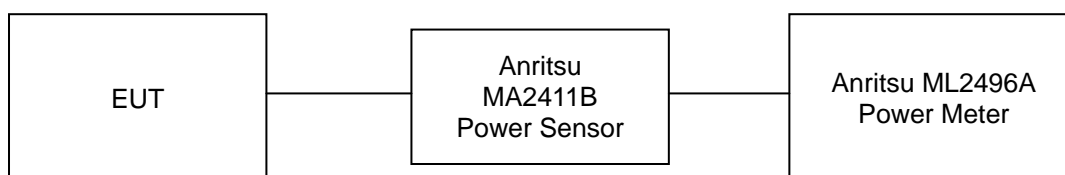

Figure 10.3 Power Measurement Setup for Bandwidths < 50 MHz

10.4 Bluetooth Conducted Powers

Channel	Frequency	Frame AVG Output Power (1Mbps)		Frame AVG Output Power (2Mbps)		Frame AVG Output Power (3Mbps)	
	(MHz)	(dBm)	(mW)	(dBm)	(mW)	(dBm)	(mW)
Low	2402	4.74	2.979	2.26	1.683	2.29	1.694
Mid	2441	5.92	3.908	3.42	2.198	3.44	2.208
High	2480	6.60	4.571	4.11	2.576	4.12	2.582

Table 10.6 Bluetooth Frame Average RF Power

Channel	Frequency	Burst AVG Output Power (LE)	
	(MHz)	(dBm)	(mW)
Low	2402	-3.36	0.461
Mid	2441	-2.44	0.570
High	2480	-1.67	0.681

Table 10.7 Bluetooth LE Average RF Power

Note:

The average conducted output powers of Bluetooth were measured using following test setup and a wideband gated RF power meter when the EUT is transmitting at its maximum power level.

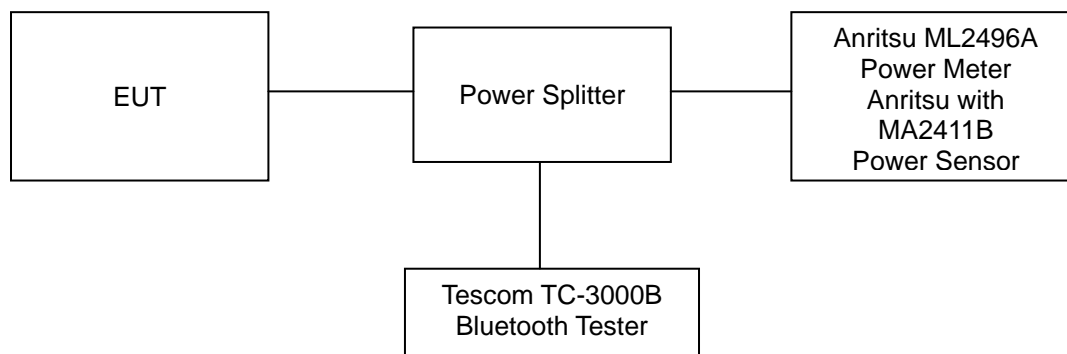

Figure 10.4 Power Measurement Setup

11. SYSTEM VERIFICATION

11.1 Tissue Verification

MEASURED TISSUE PARAMETERS										
Date(s)	Tissue Type	Ambient Temp.[°C]	Liquid Temp.[°C]	Measured Frequency [MHz]	Target Dielectric Constant, ϵ_r	Target Conductivity, σ (S/m)	Measured Dielectric Constant, ϵ_r	Measured Conductivity, σ (S/m)	Er Deviation [%]	σ Deviation [%]
Apr. 24. 2014	835 Head	21.4	21.8	824.2	41.551	0.899	41.034	0.918	-1.24	2.11
				835.0	41.500	0.900	40.968	0.925	-1.28	2.78
				836.6	41.500	0.902	40.960	0.925	-1.30	2.55
				848.8	41.500	0.915	40.878	0.933	-1.50	1.97
Apr. 25. 2014	835 Body	20.9	21.3	824.2	55.240	0.969	54.245	0.957	-1.80	-1.24
				835.0	55.200	0.970	54.240	0.969	-1.74	-0.10
				836.6	55.195	0.972	54.234	0.970	-1.74	-0.21
				848.8	55.158	0.987	54.187	0.981	-1.76	-0.61
Apr. 26. 2014	835 Head	21.2	21.5	826.4	41.540	0.899	40.152	0.905	-3.34	0.67
				835.0	41.500	0.900	40.091	0.910	-3.40	1.11
				836.6	41.500	0.902	40.080	0.911	-3.42	1.00
				846.6	41.500	0.912	40.016	0.917	-3.58	0.55
Apr. 26. 2014	835 Body	21.2	21.7	826.4	55.230	0.969	54.747	0.961	-0.87	-0.83
				835.0	55.200	0.970	54.745	0.970	-0.82	0.00
				836.6	55.195	0.972	54.742	0.972	-0.82	0.00
				846.6	55.160	0.984	54.710	0.980	-0.82	-0.41
Apr. 22. 2014	1900 Head	21.3	21.6	1850.2	40.000	1.400	39.642	1.373	-0.89	-1.93
				1880.0	40.000	1.400	39.625	1.391	-0.94	-0.64
				1900.0	40.000	1.400	39.599	1.404	-1.00	0.29
				1909.8	40.000	1.400	39.587	1.411	-1.03	0.79
Apr. 23. 2014	1900 Body	21.0	21.4	1850.2	53.300	1.520	52.479	1.518	-1.54	-0.13
				1880.0	53.300	1.520	52.438	1.544	-1.62	1.58
				1900.0	53.300	1.520	52.390	1.560	-1.71	2.63
				1909.8	53.300	1.520	52.364	1.567	-1.76	3.09
Apr. 28. 2014	1900 Head	21.6	21.9	1852.4	40.000	1.400	40.336	1.415	0.84	1.07
				1880.0	40.000	1.400	40.299	1.431	0.75	2.21
				1900.0	40.000	1.400	40.261	1.443	0.65	3.07
				1907.6	40.000	1.400	40.247	1.447	0.62	3.36
Apr. 28. 2014	1900 Body	21.6	22.0	1852.4	53.300	1.520	53.075	1.484	-0.42	-2.37
				1880.0	53.300	1.520	53.027	1.510	-0.51	-0.66
				1900.0	53.300	1.520	52.986	1.528	-0.59	0.53
				1907.6	53.300	1.520	52.972	1.534	-0.62	0.92
Apr. 21. 2014	2450 Head	21.5	21.9	2412	39.268	1.766	38.928	1.745	-0.87	-1.19
				2437	39.223	1.788	38.867	1.774	-0.91	-0.78
				2450	39.200	1.800	38.842	1.789	-0.91	-0.61
				2462	39.184	1.813	38.828	1.801	-0.91	-0.66
Apr. 21. 2014	2450 Body	21.5	21.7	2412	52.751	1.914	51.768	1.883	-1.86	-1.62
				2437	52.717	1.938	51.690	1.915	-1.95	-1.19
				2450	52.700	1.950	51.652	1.931	-1.99	-0.97
				2462	52.685	1.967	51.619	1.946	-2.02	-1.07

The above measured tissue parameters were used in the DASY software. The DASY software was used to perform interpolation to determine the dielectric parameters at the SAR test device frequencies (per KDB 865664 and IEEE 1528-2013 6.6.1.2). The tissue parameters listed in the SAR test plots may slightly differ from the table above due to significant digit rounding in the software.

Measurement Procedure for Tissue verification:

- 1) The network analyzer and probe system was configured and calibrated.
- 2) The probe was immersed in the sample which was placed in a nonmetallic container. Trapped air bubbles beneath the flange were minimized by placing the probe at a slight angle.
- 3) The complex admittance with respect to the probe aperture was measured
- 4) The complex relative permittivity, for example from the below equation (Pournaropoulos and Misra):

$$Y = \frac{j2\omega\epsilon_r\epsilon_0}{[\ln(b/a)]^2} \int_a^b \int_a^b \int_0^\pi \cos\phi' \frac{\exp[-j\omega r(\mu_0\epsilon_r\epsilon_0)^{1/2}]}{r} d\phi' d\rho' d\rho$$

where Y is the admittance of the probe in contact with the sample, the primed and unprimed coordinates refer to source and observation points, respectively, $r^2 = \rho^2 + \rho'^2 - 2\rho\rho'\cos\phi'$, ω is the angular frequency, and $j = \sqrt{-1}$.

11.2 Test System Verification

Prior to assessment, the system is verified to the $\pm 10\%$ of the specifications at 835 MHz, 1900 MHz and 2450 MHz by using the SAR Dipole kit(s). (Graphic Plots Attached)

SYSTEM DIPOLE VERIFICATION TARGET & MEASURED												
SAR System #	Freq. [MHz]	SAR Dipole kits	Date(s)	Tissue Type	Ambient Temp.[°C]	Liquid Temp.[°C]	Probe S/N	Input Power (mW)	1 W Target SAR _{1g} (W/kg)	Measured SAR _{1g} (W/kg)	1 W Normalized SAR _{1g} (W/kg)	Deviation [%]
C	835	D835V2, SN:4d159	Apr. 24. 2014	Head	21.4	21.8	3930	250	9.44	2.38	9.52	0.85
C	835	D835V2, SN: 4d159	Apr. 25. 2014	Body	20.9	21.3	3930	250	9.28	2.42	9.68	4.31
C	835	D835V2, SN:4d159	Apr. 26. 2014	Head	21.2	21.5	3930	250	9.44	2.42	9.68	2.54
C	835	D835V2, SN: 4d159	Apr. 26. 2014	Body	21.2	21.7	3930	250	9.28	2.47	9.88	6.47
C	1900	D1900V2, SN:5d176	Apr. 22. 2014	Head	21.3	21.6	3930	250	40.4	9.92	39.68	-1.78
C	1900	D1900V2, SN: 5d176	Apr. 23. 2014	Body	21.0	21.4	3930	250	40.7	10.6	42.40	4.18
C	1900	D1900V2, SN:5d176	Apr. 28. 2014	Head	21.6	21.9	3930	250	40.4	9.88	39.52	-2.18
C	1900	D1900V2, SN: 5d176	Apr. 28. 2014	Body	21.6	22.0	3930	250	40.7	10.7	42.80	5.16
C	2450	D2450V2, SN:920	Apr. 21. 2014	Head	21.5	21.9	3930	250	52.8	13.0	52.00	-1.52
C	2450	D2450V2, SN: 920	Apr. 21. 2014	Body	21.5	21.7	3930	250	48.9	12.8	51.20	4.70

Note1 : System Verification was measured with input 250 mW and normalized to 1W.

Note2 : To confirm the proper SAR liquid depth, the z-axis plots from the system verifications were included since the system verifications were performed using the same liquid, probe and DAE as the SAR tests in the same time period.

Note3: Full system validation status and results can be found in Attachment 3.

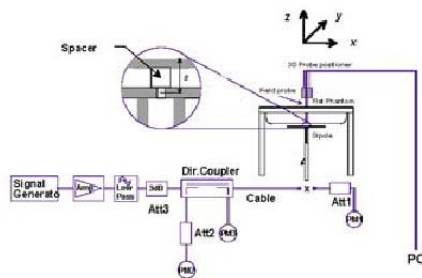

Figure 11.1 Dipole Verification Test Setup Diagram & Photo

12. SAR TEST RESULTS

12.1 Head SAR Results

Table 12.1 GSM/GPRS 850 Head SAR

MEASUREMENT RESULTS														
FREQUENCY		Mode/ Band	Service	Maximum Allowed Power [dBm]	Conducted Power [dBm]	Drift Power [dB]	Phantom Position	Device Serial Number	# of Time Slots	Duty Cycle	1g SAR (W/kg)	Scaling Factor	1g Scaled SAR (W/kg)	Plots #
MHz	Ch													
836.6	190	GSM850	GSM	33.2	32.8	-0.100	Left Touch	FCC #1	1	1:8.3	0.447	1.096	0.490	
836.6	190	GSM850	GSM	33.2	32.8	-0.130	Right Touch	FCC #1	1	1:8.3	0.432	1.096	0.473	
836.6	190	GSM850	GSM	33.2	32.8	0.120	Left Tilt	FCC #1	1	1:8.3	0.291	1.096	0.319	
836.6	190	GSM850	GSM	33.2	32.8	-0.120	Right Tilt	FCC #1	1	1:8.3	0.287	1.096	0.315	
836.6	190	GSM850	GPRS	33.2	32.9	-0.060	Left Touch	FCC #1	1	1:8.3	0.470	1.072	0.504	
836.6	190	GSM850	GPRS	31.4	31.3	-0.140	Left Touch	FCC #1	2	1:4.15	0.704	1.023	0.720	A1
836.6	190	GSM850	GPRS	29.4	29.3	0.080	Left Touch	FCC #1	3	1:2.77	0.582	1.023	0.595	
836.6	190	GSM850	GPRS	28.4	28.3	-0.000	Left Touch	FCC #1	4	1:2.075	0.571	1.023	0.584	
836.6	190	GSM850	GPRS	31.4	31.3	-0.130	Right Touch	FCC #1	2	1:2.075	0.614	1.023	0.628	
836.6	190	GSM850	GPRS	31.4	31.3	-0.150	Left Tilt	FCC #1	2	1:2.075	0.420	1.023	0.430	
836.6	190	GSM850	GPRS	31.4	31.3	-0.140	Right Tilt	FCC #1	2	1:2.075	0.385	1.023	0.394	
ANSI / IEEE C95.1-2005- SAFETY LIMIT Spatial Peak Uncontrolled Exposure/General Population Exposure								Head 1.6 W/kg (mW/g) averaged over 1 gram						

Table 12.2 PCS/GPRS 1900 Head SAR

MEASUREMENT RESULTS														
FREQUENCY		Mode/ Band	Service	Maximum Allowed Power [dBm]	Conducted Power [dBm]	Drift Power [dB]	Phantom Position	Device Serial Number	# of Time Slots	Duty Cycle	1g SAR (W/kg)	Scaling Factor	1g Scaled SAR (W/kg)	Plots #
MHz	Ch													
1880.0	661	PCS1900	PCS	30.2	29.9	-0.010	Left Touch	FCC #1	1	1:8.3	0.689	1.072	0.739	
1880.0	661	PCS1900	PCS	30.2	29.9	0.160	Right Touch	FCC #1	1	1:8.3	0.337	1.072	0.361	
1880.0	661	PCS1900	PCS	30.2	29.9	0.050	Left Tilt	FCC #1	1	1:8.3	0.195	1.072	0.209	
1880.0	661	PCS1900	PCS	30.2	29.9	-0.010	Right Tilt	FCC #1	1	1:8.3	0.205	1.072	0.22	
1880.0	661	PCS1900	GPRS	30.2	29.9	0.160	Left Touch	FCC #1	1	1:8.3	0.718	1.072	0.77	
1850.2	512	PCS1900	GPRS	28.7	28.5	-0.070	Left Touch	FCC #1	2	1:4.15	0.706	1.047	0.739	
1880.0	661	PCS1900	GPRS	28.7	28.6	0.100	Left Touch	FCC #1	2	1:4.15	0.883	1.023	0.903	
1909.8	810	PCS1900	GPRS	28.7	28.7	0.160	Left Touch	FCC #1	2	1:4.15	0.968	1.000	0.968	
1850.2	512	PCS1900	GPRS	26.7	26.4	-0.070	Left Touch	FCC #1	3	1:2.77	0.673	1.072	0.721	
1880.0	661	PCS1900	GPRS	26.7	26.5	0.180	Left Touch	FCC #1	3	1:2.77	0.875	1.047	0.916	
1909.8	810	PCS1900	GPRS	26.7	26.6	0.080	Left Touch	FCC #1	3	1:2.77	0.950	1.023	0.972	
1850.2	512	PCS1900	GPRS	25.8	25.5	0.180	Left Touch	FCC #1	4	1:2.075	0.799	1.072	0.857	
1880.0	661	PCS1900	GPRS	25.8	25.6	0.010	Left Touch	FCC #1	4	1:2.075	1.020	1.047	1.068	
1909.8	810	PCS1900	GPRS	25.8	25.8	0.130	Left Touch	FCC #1	4	1:2.075	1.140	1.000	1.140	A2
1880.0	661	PCS1900	GPRS	25.8	25.6	-0.110	Right Touch	FCC #1	4	1:2.075	0.441	1.047	0.462	
1880.0	661	PCS1900	GPRS	25.8	25.6	-0.110	Left Tilt	FCC #1	4	1:2.075	0.264	1.047	0.276	
1880.0	661	PCS1900	GPRS	25.8	25.6	-0.110	Right Tilt	FCC #1	4	1:2.075	0.234	1.047	0.245	
1909.8	810	PCS1900	GPRS	25.8	25.8	0.140	Left Touch	FCC #1	4	1:2.075	1.060	1.000	1.060	
ANSI / IEEE C95.1-2005- SAFETY LIMIT Spatial Peak Uncontrolled Exposure/General Population Exposure								Head 1.6 W/kg (mW/g) averaged over 1 gram						

Note: Blue entries represent repeatability measurements.

Table 12.3 WCDMA 850 Head SAR

MEASUREMENT RESULTS													
FREQUENCY		Mode/ Band	Service	Maximum Allowed Power [dBm]	Conducted Power [dBm]	Drift Power [dB]	Phantom Position	Device Serial Number	Duty Cycle	1g SAR (W/kg)	Scaling Factor	1g Scaled SAR (W/kg)	Plots #
MHz	Ch												
836.6	4183	WCDMA 850	RMC	23.2	23.08	0.050	Left Touch	FCC #1	1:1	0.531	1.028	0.546	A3
836.6	4183	WCDMA 850	RMC	23.2	23.08	-0.110	Right Touch	FCC #1	1:1	0.482	1.028	0.495	
836.6	4183	WCDMA 850	RMC	23.2	23.08	-0.030	Left Tilt	FCC #1	1:1	0.430	1.028	0.442	
836.6	4183	WCDMA 850	RMC	23.2	23.08	-0.090	Right Tilt	FCC #1	1:1	0.314	1.028	0.323	
ANSI / IEEE C95.1-2005– SAFETY LIMIT Spatial Peak Uncontrolled Exposure/General Population Exposure									Head 1.6 W/kg (mW/g) averaged over 1 gram				

Table 12.4 WCDMA 1900 Head SAR

MEASUREMENT RESULTS													
FREQUENCY		Mode/ Band	Service	Maximum Allowed Power [dBm]	Conducted Power [dBm]	Drift Power [dB]	Phantom Position	Device Serial Number	Duty Cycle	1g SAR (W/kg)	Scaling Factor	1g Scaled SAR (W/kg)	Plots #
MHz	Ch												
1852.4	9262	WCDMA 1900	RMC	23.2	23.04	0.050	Left Touch	FCC #1	1:1	0.854	1.038	0.886	
1880.0	9400	WCDMA 1900	RMC	23.2	22.94	-0.000	Left Touch	FCC #1	1:1	1.070	1.062	1.136	
1907.6	9538	WCDMA 1900	RMC	23.2	23.00	0.130	Left Touch	FCC #1	1:1	1.110	1.047	1.162	A4
1880.0	9400	WCDMA 1900	RMC	23.2	22.94	0.080	Right Touch	FCC #1	1:1	0.746	1.062	0.792	
1880.0	9400	WCDMA 1900	RMC	23.2	22.94	-0.180	Left Tilt	FCC #1	1:1	0.333	1.062	0.354	
1880.0	9400	WCDMA 1900	RMC	23.2	22.94	-0.020	Right Tilt	FCC #1	1:1	0.418	1.062	0.444	
ANSI / IEEE C95.1-2005– SAFETY LIMIT Spatial Peak Uncontrolled Exposure/General Population Exposure									Head 1.6 W/kg (mW/g) averaged over 1 gram				

Table 12.5 DTS Head SAR

MEASUREMENT RESULTS														
FREQUENCY		Mode	Service	Maximum Allowed Power [dBm]	Conducted Power [dBm]	Drift Power [dB]	Phantom Position	Device Serial Number	Data Rate [Mbps]	Duty Cycle	1g SAR (W/kg)	Scaling Factor	1g Scaled SAR (W/kg)	Plots #
MHz	Ch													
2462	11	802.11b	DSSS	15.0	14.08	0.000	Left Touch	FCC #1	1	1:1	0.033	1.236	0.051	
2412	1	802.11b	DSSS	15.0	13.47	0.150	Right Touch	FCC #1	1	1:1	0.097	1.422	0.174	
2437	6	802.11b	DSSS	15.0	13.77	-0.020	Right Touch	FCC #1	1	1:1	0.110	1.327	0.184	
2462	11	802.11b	DSSS	15.0	14.08	0.160	Right Touch	FCC #1	1	1:1	0.120	1.236	0.187	A5
2462	11	802.11b	DSSS	15.0	14.08	-0.150	Left Tilt	FCC #1	1	1:1	0.024	1.236	0.037	
2462	11	802.11b	DSSS	15.0	14.08	0.130	Right Tilt	FCC #1	1	1:1	0.049	1.236	0.076	
ANSI / IEEE C95.1-2005– SAFETY LIMIT Spatial Peak Uncontrolled Exposure/General Population Exposure									Head 1.6 W/kg (mW/g) averaged over 1 gram					

12.2 Standalone Body-Worn SAR Worn SAR Results

Table 12.6 GSM/PCS/GPRS/WCDMA Body-Worn SAR

MEASUREMENT RESULTS														
FREQUENCY		Mode/ Band	Service	Maximum Allowed Power [dBm]	Conducted Power [dBm]	Drift Power [dB]	Spacing [Side]	Device Serial Number	# of Time Slot s	Duty Cycle	1g SAR (W/kg)	Scaling Factor	1g Scaled SAR (W/kg)	Plots #
MHz	Ch													
824.2	128	GSM 850	GSM	33.2	32.8	0.010	10 mm [Rear]	FCC #1	1	1:8.3	0.664	1.096	0.728	
836.6	190	GSM 850	GSM	33.2	32.8	-0.120	10 mm [Rear]	FCC #1	1	1:8.3	0.832	1.096	0.912	
848.8	251	GSM 850	GSM	33.2	33.0	0.170	10 mm [Rear]	FCC #1	1	1:8.3	0.935	1.047	0.979	A6
824.2	128	GSM 850	GPRS	31.4	31.3	-0.040	10 mm [Rear]	FCC #1	2	1:4.15	0.812	1.023	0.831	
836.6	190	GSM 850	GPRS	31.4	31.3	-0.000	10 mm [Rear]	FCC #1	2	1:4.15	1.100	1.023	1.125	
848.8	251	GSM 850	GPRS	31.4	31.4	-0.040	10 mm [Rear]	FCC #1	2	1:4.15	1.150	1.000	1.150	A7
1880.0	661	PCS1900	PCS	30.2	29.9	-0.060	10 mm [Rear]	FCC #1	1	1:8.3	0.555	1.072	0.595	A8
1880.0	661	PCS1900	GPRS	25.8	25.6	-0.030	10 mm [Rear]	FCC #1	4	1:2.075	0.730	1.047	0.764	A9
826.4	4132	WCDMA 850	RMC	23.2	23.12	-0.020	10 mm [Rear]	FCC #1	N/A	1:1	0.752	1.019	0.766	
836.6	4183	WCDMA 850	RMC	23.2	23.08	0.020	10 mm [Rear]	FCC #1	N/A	1:1	0.927	1.028	0.953	A10
846.6	4233	WCDMA 850	RMC	23.2	23.01	0.010	10 mm [Rear]	FCC #1	N/A	1:1	0.764	1.045	0.798	
1852.4	9262	WCDMA 1900	RMC	23.2	23.04	-0.040	10 mm [Rear]	FCC #1	N/A	1:1	0.968	1.038	1.005	
1880.0	9400	WCDMA 1900	RMC	23.2	22.94	-0.130	10 mm [Rear]	FCC #1	N/A	1:1	0.974	1.062	1.034	
1907.6	9538	WCDMA 1900	RMC	23.2	23.00	0.030	10 mm [Rear]	FCC #1	N/A	1:1	1.130	1.047	1.183	A11
ANSI / IEEE C95.1-2005- SAFETY LIMIT Spatial Peak Uncontrolled Exposure/General Population Exposure									Body 1.6 W/kg (mW/g) averaged over 1 gram					

Table 12.7 DTS Body-Worn SAR

MEASUREMENT RESULTS														
FREQUENCY		Mode/ Band	Service	Maximum Allowed Power [dBm]	Conducted Power [dBm]	Drift Power [dB]	Spacing [Side]	Device Serial Number	Data Rate [Mbps]	Duty Cycle	1g SAR (W/kg)	Scaling Factor	1g Scaled SAR (W/kg)	Plots #
MHz	Ch													
2462	11	802.11b	DSSS	15.0	14.08	0.170	10 mm [Rear]	SAR #1	1	1:1	0.119	1.236	0.147	A12
ANSI / IEEE C95.1-2005- SAFETY LIMIT Spatial Peak Uncontrolled Exposure/General Population Exposure									Body 1.6 W/kg (mW/g) averaged over 1 gram					

12.3 Standalone Wireless router SAR Results

Table 12.8 GPRS Hotspot SAR

MEASUREMENT RESULTS														
FREQUENCY		Mode/ Band	Service	Maximum Allowed Power [dBm]	Conducted Power [dBm]	Drift Power [dB]	Spacing [Side]	Device Serial Number	# of Time Slots	Duty Cycle	1g SAR (W/kg)	Scaling Factor	1g Scaled SAR (W/kg)	Plots #
MHz	Ch													
836.6	190	GSM 850	GPRS	31.4	31.3	0.140	10 mm [Bottom]	FCC #1	2	1:4.15	0.101	1.023	0.103	
836.6	190	GSM 850	GPRS	31.4	31.3	-0.010	10 mm [Front]	FCC #1	2	1:4.15	0.570	1.023	0.583	
824.2	128	GSM 850	GPRS	33.2	32.8	-0.100	10 mm [Rear]	FCC #1	1	1:8.3	0.670	1.096	0.734	
836.6	190	GSM 850	GPRS	33.2	32.9	-0.130	10 mm [Rear]	FCC #1	1	1:8.3	0.839	1.072	0.899	
848.8	251	GSM 850	GPRS	33.2	33.0	-0.040	10 mm [Rear]	FCC #1	1	1:8.3	0.938	1.047	0.982	
824.2	128	GSM 850	GPRS	31.4	31.3	-0.040	10 mm [Rear]	FCC #1	2	1:4.15	0.812	1.023	0.831	
836.6	190	GSM 850	GPRS	31.4	31.3	-0.000	10 mm [Rear]	FCC #1	2	1:4.15	1.100	1.023	1.125	
848.8	251	GSM 850	GPRS	31.4	31.4	-0.040	10 mm [Rear]	FCC #1	2	1:4.15	1.150	1.000	1.150	A7
824.2	128	GSM 850	GPRS	29.4	29.3	-0.120	10 mm [Rear]	FCC #1	3	1:2.77	0.778	1.023	0.796	
836.6	190	GSM 850	GPRS	29.4	29.3	0.040	10 mm [Rear]	FCC #1	3	1:2.77	0.999	1.023	1.022	
848.8	251	GSM 850	GPRS	29.4	29.4	-0.000	10 mm [Rear]	FCC #1	3	1:2.77	1.030	1.000	1.030	
824.2	128	GSM 850	GPRS	28.4	28.2	-0.050	10 mm [Rear]	FCC #1	4	1:2.075	0.721	1.047	0.755	
836.6	190	GSM 850	GPRS	28.4	28.3	0.040	10 mm [Rear]	FCC #1	4	1:2.075	0.994	1.023	1.017	
848.8	251	GSM 850	GPRS	28.4	28.3	0.020	10 mm [Rear]	FCC #1	4	1:2.075	1.030	1.023	1.054	
836.6	190	GSM 850	GPRS	31.4	31.3	0.020	10 mm [Right]	FCC #1	2	1:4.15	0.657	1.023	0.672	
836.6	190	GSM 850	GPRS	31.4	31.3	0.020	10 mm [Left]	FCC #1	2	1:4.15	0.580	1.023	0.593	
848.8	251	GSM 850	GPRS	31.4	31.4	-0.030	10 mm [Rear]	FCC #1	2	1:4.15	1.140	1.000	1.140	
1880.0	661	PCS1900	GPRS	25.8	25.6	0.110	10 mm [Bottom]	FCC #1	4	1:2.075	0.315	1.047	0.330	
1880.0	661	PCS1900	GPRS	25.8	25.6	0.030	10 mm [Front]	FCC #1	4	1:2.075	0.406	1.047	0.425	
1880.0	661	PCS1900	GPRS	30.2	29.9	-0.170	10 mm [Rear]	FCC #1	1	1:8.3	0.563	1.072	0.604	
1880.0	661	PCS1900	GPRS	28.7	28.6	-0.000	10 mm [Rear]	FCC #1	2	1:4.15	0.713	1.023	0.729	
1880.0	661	PCS1900	GPRS	26.7	26.5	-0.060	10 mm [Rear]	FCC #1	3	1:2.77	0.702	1.047	0.735	
1880.0	661	PCS1900	GPRS	25.8	25.6	-0.030	10 mm [Rear]	FCC #1	4	1:2.075	0.730	1.047	0.764	A9
1880.0	661	PCS1900	GPRS	25.8	25.6	-0.040	10 mm [Right]	FCC #1	4	1:2.075	0.144	1.047	0.151	
1880.0	661	PCS1900	GPRS	25.8	25.6	-0.110	10 mm [Left]	FCC #1	4	1:2.075	0.276	1.047	0.289	
ANSI / IEEE C95.1-2005- SAFETY LIMIT Spatial Peak Uncontrolled Exposure/General Population Exposure								Body 1.6 W/kg (mW/g) averaged over 1 gram						

Note: Blue entries represent repeatability measurements.

Table 12.9 WCDMA Hotspot SAR

MEASUREMENT RESULTS

FREQUENCY		Mode/ Band	Service	Maximum Allowed Power [dBm]	Conducted Power [dBm]	Drift Power [dB]	Spacing [Side]	Device Serial Number	# of Time Slots	Duty Cycle	1g SAR (W/kg)	Scaling Factor	1g Scaled SAR (W/kg)	Plots #
MHz	Ch													
836.6	4183	WCDMA 850	RMC	23.2	23.08	-0.000	10 mm [Bottom]	FCC #1	N/A	1:1	0.063	1.028	0.065	
836.6	4183	WCDMA 850	RMC	23.2	23.08	-0.000	10 mm [Front]	FCC #1	N/A	1:1	0.517	1.028	0.531	
826.4	4132	WCDMA 850	RMC	23.2	23.12	-0.020	10 mm [Rear]	FCC #1	N/A	1:1	0.752	1.019	0.766	
836.6	4183	WCDMA 850	RMC	23.2	23.08	0.020	10 mm [Rear]	FCC #1	N/A	1:1	0.927	1.028	0.953	A10
846.6	4233	WCDMA 850	RMC	23.2	23.01	0.010	10 mm [Rear]	FCC #1	N/A	1:1	0.764	1.045	0.798	
836.6	4183	WCDMA 850	RMC	23.2	23.08	-0.090	10 mm [Right]	FCC #1	N/A	1:1	0.498	1.028	0.512	
836.6	4183	WCDMA 850	RMC	23.2	23.08	0.010	10 mm [Left]	FCC #1	N/A	1:1	0.463	1.028	0.476	
1880.0	9400	WCDMA 1900	RMC	23.2	22.94	-0.140	10 mm [Bottom]	FCC #1	N/A	1:1	0.357	1.062	0.379	
1880.0	9400	WCDMA 1900	RMC	23.2	22.94	0.070	10 mm [Front]	FCC #1	N/A	1:1	0.435	1.062	0.462	
1852.4	9262	WCDMA 1900	RMC	23.2	23.04	-0.040	10 mm [Rear]	FCC #1	N/A	1:1	0.968	1.038	1.005	
1880.0	9400	WCDMA 1900	RMC	23.2	22.94	-0.130	10 mm [Rear]	FCC #1	N/A	1:1	0.974	1.062	1.034	
1907.6	9538	WCDMA 1900	RMC	23.2	23.00	0.030	10 mm [Rear]	FCC #1	N/A	1:1	1.130	1.047	1.183	A11
1880.0	9400	WCDMA 1900	RMC	23.2	22.94	-0.070	10 mm [Right]	FCC #1	N/A	1:1	0.145	1.062	0.154	
1880.0	9400	WCDMA 1900	RMC	23.2	22.94	-0.080	10 mm [Left]	FCC #1	N/A	1:1	0.313	1.062	0.332	
1907.6	9538	WCDMA 1900	RMC	23.2	23.00	-0.060	10 mm [Rear]	FCC #1	N/A	1:1	1.090	1.047	1.141	
ANSI / IEEE C95.1-2005- SAFETY LIMIT Spatial Peak Uncontrolled Exposure/General Population Exposure									Body 1.6 W/kg (mW/g) averaged over 1 gram					

Note: Blue entries represent repeatability measurements.

Table 12.10 W-LAN Hotspot SAR

MEASUREMENT RESULTS

FREQUENCY		Mode/ Band	Service	Maximum Allowed Power [dBm]	Conducted Power [dBm]	Drift Power [dB]	Spacing [Side]	Device Serial Number	Data Rate [Mbps]	Duty Cycle	1g SAR (W/kg)	Scaling Factor	1g Scaled SAR (W/kg)	Plots #
MHz	Ch													
2462	11	802.11b	DSSS	15.0	14.08	0.020	10 mm [Top]	SAR #1	1	1:1	0.014	1.236	0.017	
2462	11	802.11b	DSSS	15.0	14.08	-0.130	10 mm [Front]	SAR #1	1	1:1	0.031	1.236	0.038	
2412	1	802.11b	DSSS	15.0	13.47	0.110	10 mm [Rear]	SAR #1	1	1:1	0.091	1.422	0.129	
2437	6	802.11b	DSSS	15.0	13.77	-0.040	10 mm [Rear]	SAR #1	1	1:1	0.108	1.327	0.143	
2462	11	802.11b	DSSS	15.0	14.08	0.170	10 mm [Rear]	SAR #1	1	1:1	0.119	1.236	0.147	A12
2462	11	802.11b	DSSS	15.0	14.08	0.160	10 mm [Left]	SAR #1	1	1:1	0.044	1.236	0.054	
ANSI / IEEE C95.1-2005- SAFETY LIMIT Spatial Peak Uncontrolled Exposure/General Population Exposure									Body 1.6 W/kg (mW/g) averaged over 1 gram					

12.4 SAR Test Notes

General Notes:

1. The test data reported are the worst-case SAR values according to test procedures specified in IEEE 1528-2003, and FCC KDB Publication 447498 D01v05r02.
2. Batteries are fully charged at the beginning of the SAR measurements. A standard battery was used for all SAR measurements.
3. Liquid tissue depth was at least 15.0 cm for all frequencies.
4. The manufacturer has confirmed that the device(s) tested have the same physical, mechanical and thermal characteristics and are within operational tolerances expected for production units
5. SAR results were scaled to the maximum allowed power to demonstrate compliance per FCC KDB Publication 447498 D01v05r02.
6. Device was tested using a fixed spacing for body-worn accessory testing. A separation distance of 10 mm was considered because the manufacturer has determined that there will be body-worn accessories available in the marketplace for users to support this separation distance.
7. Per FCC KDB Publication 648474 D04v01r02, SAR was evaluated without a headset connected to the device. Since the standalone reported SAR was not > 1.2 W/kg, no additional SAR evaluations using a headset cable were performed.
8. During SAR Testing for the Wireless Router conditions per FCC KDB Publication 941225 D06v01r01, the actual Portable Hotspot operation (with actual simultaneous transmission of a transmitter with WIFI) was not activated (See Section 6.7 for more details).
9. Per FCC KDB 865664 D01v01r03, variability SAR tests were performed when the measured SAR results for a frequency band were greater than 0.8 W/kg. Repeated SAR measurements are highlighted in the tables above for clarity. Please see Section 14 for variability analysis.

GSM Notes:

1. Body-Worn accessory testing is typically associated with voice operations. Therefore, GSM voice was evaluated for body-worn SAR.
2. This device supports GSM VOIP in the head and body-worn configurations; therefore GPRS was additionally evaluated for head and body-worn compliance.
3. Justification for reduced test configurations per KDB Publication 941225 D03v01 and October 2013 TCB Workshop Notes: The source-based frame-averaged output power was evaluated for all GPRS/EDGE slot configurations. The configuration with the highest target frame averaged output power was evaluated for hotspot SAR. When the maximum frame-averaged powers are equivalent across two or more slots (within 0.25 dB), the configuration with the most number of time slots was tested.
4. Per FCC KDB Publication 447498 D01v05r02, if the reported (scaled) SAR measured at the middle channel or highest output power channel for each test configuration is ≤ 0.8 W/kg then testing at the other channels is not required for such test configuration(s). Since the maximum output power variation across the required test channels is not > $\frac{1}{2}$ dB, the middle channel was used for testing.

WCDMA (UMTS) Notes:

1. WCDMA (UMTS) mode in was tested under RMC 12.2 kbps with HSPA Inactive per KDB Publication 941225 D01v02. HSPA SAR was not required since the average output power of the HSPA subtests was not more than 0.25 dB higher than the RMC level and SAR was less than 1.2 W/kg.
2. Per FCC KDB Publication 447498 D01v05r02, if the reported (scaled) SAR measured at the middle channel or highest output power channel for each test configuration is ≤ 0.8 W/kg then testing at the other channels is not required for such test configuration(s). When the maximum output power variation across the required test channels is $> \frac{1}{2}$ dB, instead of the middle channel, the highest output power channel was used.

WLAN Notes:

1. Justification for reduced test configurations for WIFI channels per KDB Publication 248227 D01v01r02 and October 2012 FCC/TCB Meeting Notes for 2.4 GHz WIFI: Highest average RF output power channel for the lowest data rate was selected for SAR evaluation in 802.11b. Other IEEE 802.11 modes (including 802.11g/n) were not investigated since the average output powers over all channels and data rates were not more than 0.25 dB higher than the tested channel in the lowest data rate of IEEE 802.11b mode.
2. WIFI transmission was verified using a spectrum analyzer.
3. Since the maximum extrapolated peak SAR of the zoom scan for the maximum output channel is < 1.6 W/kg and the reported 1g averaged SAR is < 0.8 W/kg, SAR testing on other default channels was not required.

13. FCC MULTI-TX AND ANTENNA SAR CONSIDERATIONS

13.1 Introduction

The following procedures adopted from FCC KDB Publication 447498 D01v05r02 are applicable to handsets with built-in unlicensed transmitters such as 802.11b/g/n and Bluetooth devices which may simultaneously transmit with the licensed transmitter.

13.2 Simultaneous Transmission Procedures

This device contains transmitters that may operate simultaneously. Therefore simultaneous transmission analysis is required. Per FCC KDB 447498 D01v05r02 IV.C.1.iii and IEEE 1528-2013 Section 6.3.4.1.2, simultaneous transmission SAR test exclusion may be applied when the sum of the 1-g SAR for all the simultaneous transmitting antennas in a specific a physical test configuration is ≤ 1.6 W/kg. When standalone SAR is not required to be measured, per FCC KDB 447498 D01v05r02 4.3.2 2), the following equation must be used to estimate the standalone 1g SAR for simultaneous transmission assessment involving that transmitter.

$$\text{Estimated SAR} = \frac{\sqrt{f(\text{GHz})}}{7.5} * \frac{(\text{Max Power of channel, mW})}{\text{Min. Separation Distance, mm}}$$

Table 13.1 Estimated SAR

Mode	Frequency	Maximum Allowed Power		Separation Distance (Body)	Estimated SAR (Body)
	[MHz]	[dBm]	[mW]	[mm]	[W/kg]
Bluetooth	2480	8.0	6.310	10	0.132

Note : Held-to ear configurations are not applicable to Bluetooth operations and therefore were not considered for simultaneous transmission. Per KDB Publication 447498 D01v05, the maximum power of the channel was rounded to the nearest mW before calculation.

13.3 Simultaneous Transmission Capabilities

According to FCC KDB Publication 447498 D01v05r02, transmitters are considered to be transmitting simultaneously when there is overlapping transmission, with the exception of transmissions during network hand-offs with maximum hand-off duration less than 30 seconds. Possible transmission paths for the DUT are shown in Figure 13.1 and are color-coded to indicate communication modes which share the same path. Modes which share the same transmission path cannot transmit simultaneously with one another.

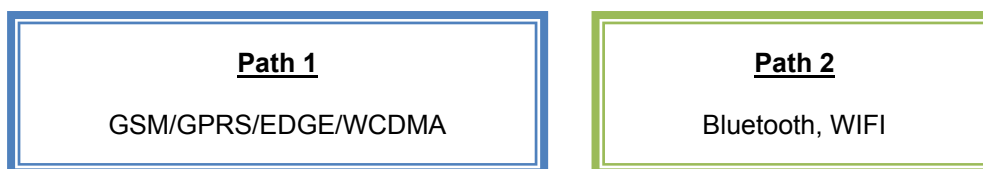

Figure 13.1 Simultaneous Transmission Paths

This device contains multiple transmitters that may operate simultaneously, and therefore requires a simultaneous transmission analysis according to FCC KDB Publication 447498 D01v05r02 3) procedures.

Table 13.2 Simultaneous Transmission Scenarios

No.	Capable Transmit Configuration	Head	Body-Worn Accessory	Wireless Router	Note
1	GSM850 Voice + 2.4 GHz WIFI	Yes	Yes	N/A	
2	PCS1900 Voice + 2.4 GHz WIFI	Yes	Yes	N/A	
3	WCDMA 850 + 2.4 GHz WIFI	Yes	Yes	Yes	
4	WCDMA 1900 + 2.4 GHz WIFI	Yes	Yes	Yes	
5	GSM850 GPRS + 2.4 GHz WIFI	Yes	Yes	Yes	
6	GPRS1900 GPRS + 2.4 GHz WIFI	Yes	Yes	Yes	
7	GSM850 Voice + Bluetooth	N/A	Yes	N/A	
8	PCS1900 Voice + Bluetooth	N/A	Yes	N/A	
9	WCDMA 850 + Bluetooth	N/A	Yes	N/A	
10	WCDMA 1900 + Bluetooth	N/A	Yes	N/A	

Notes:

1. 2.4 GHz WIFI is supported Hotspot.
2. GPRS, WCDMA is supported Hotspot.
3. Bluetooth and WIFI cannot transmit simultaneously since they share the same chip.
4. VOIP is supported.

Note:

- When the user utilizes multiple services in UMTS 3G mode it uses multi-Radio Access Bearer or multi-RAB. The power control is based on a physical control channel (Dedicated Physical Control Channel [DPCCH]) and power control will be adjusted to meet the needs of both services. Therefore, the UMTS+WLAN scenario also represents the UMTS Voice/DATA + WLAN Hotspot scenario.
- Per the manufacturer, WIFI Direct is not expected to be used in conjunction with a held-to-ear or body-worn accessory voice call. Therefore, there are no simultaneous transmission scenarios involving WIFI direct beyond that listed in the above table.

13.4 Head SAR Simultaneous Transmission Analysis

Table 13.3 Simultaneous Transmission Scenario with 2.4 GHz W-LAN (Held to Ear)

Simult TX	Configuration	GSM850 SAR (W/kg)	2.4G W-LAN (802.11b) SAR (W/kg)	Σ SAR (W/kg)	Simult TX	Configuration	PCS1900 SAR (W/kg)	2.4G W-LAN (802.11b) SAR (W/kg)	Σ SAR (W/kg)
Head SAR	Left Touch	0.490	0.051	0.541	Head SAR	Left Touch	0.739	0.051	0.790
	Right Touch	0.473	0.187	0.660		Right Touch	0.361	0.187	0.548
	Left Tilt	0.319	0.037	0.356		Left Tilt	0.209	0.037	0.246
	Right Tilt	0.315	0.076	0.391		Right Tilt	0.220	0.076	0.296

Table 13.4 Simultaneous Transmission Scenario with 2.4 GHz W-LAN (Held to Ear)

Simult TX	Configuration	GPRS 850 SAR (W/kg)	2.4G W-LAN (802.11b) SAR (W/kg)	Σ SAR (W/kg)	Simult TX	Configuration	GPRS 1900 SAR (W/kg)	2.4G W-LAN (802.11b) SAR (W/kg)	Σ SAR (W/kg)
Head SAR	Left Touch	0.720	0.051	0.771	Head SAR	Left Touch	1.140	0.051	1.191
	Right Touch	0.628	0.187	0.815		Right Touch	0.462	0.187	0.649
	Left Tilt	0.430	0.037	0.467		Left Tilt	0.276	0.037	0.313
	Right Tilt	0.394	0.076	0.470		Right Tilt	0.245	0.076	0.321

Table 13.5 Simultaneous Transmission Scenario with 2.4 GHz W-LAN (Held to Ear)

Simult TX	Configuration	WCDMA 850 SAR (W/kg)	2.4G W-LAN (802.11b) SAR (W/kg)	Σ SAR (W/kg)	Simult TX	Configuration	WCDMA 1900 SAR (W/kg)	2.4G W-LAN (802.11b) SAR (W/kg)	Σ SAR (W/kg)
Head SAR	Left Touch	0.546	0.051	0.597	Head SAR	Left Touch	1.162	0.051	1.213
	Right Touch	0.495	0.187	0.682		Right Touch	0.792	0.187	0.979
	Left Tilt	0.442	0.037	0.479		Left Tilt	0.354	0.037	0.391
	Right Tilt	0.323	0.076	0.399		Right Tilt	0.444	0.076	0.520

13.5 Body-Worn Simultaneous Transmission Analysis

Table 13.6 Simultaneous Transmission Scenario with 2.4 GHz W-LAN (Body-Worn at 10 mm)

Configuration	Mode	2G/3G SAR (W/kg)	2.4G W-LAN (802.11b) SAR (W/kg)	Σ SAR (W/kg)
Rear Side	GSM 850	0.979	0.147	1.126
Rear Side	GPRS 850	1.150	0.147	1.297
Rear Side	PCS 1900	0.595	0.147	0.742
Rear Side	GPRS 1900	0.764	0.147	0.911
Rear Side	WCDMA 850	0.953	0.147	1.100
Rear Side	WCDMA 1900	1.183	0.147	1.330

Table 13.7 Simultaneous Transmission Scenario with Bluetooth (Body-Worn at 10 mm)

Configuration	Mode	2G/3G SAR (W/kg)	Bluetooth SAR (W/kg)	Σ SAR (W/kg)
Rear Side	GSM 850	0.979	0.132	1.111
Rear Side	GPRS 850	1.150	0.132	1.282
Rear Side	PCS 1900	0.595	0.132	0.727
Rear Side	GPRS 1900	0.764	0.132	0.896
Rear Side	WCDMA 850	0.953	0.132	1.085
Rear Side	WCDMA 1900	1.183	0.132	1.315

Note: Bluetooth SAR was not required to be measured per FCC KDB 447498 D01v05r02. Estimated SAR results were used in the above table to determine simultaneous transmission SAR test exclusion.

13.6 Hotspot SAR Simultaneous Transmission Analysis

Per FCC KDB Publication 941225 D06v01r01, the device edges with antennas more than 2.5 cm from edge are not required to be evaluated for SAR ("-").

Table 13.8 Simultaneous Transmission Scenario (Hotspot at 10 mm)

Simult TX	Configuration	GPRS 850 SAR (W/kg)	2.4G W-LAN (802.11b) SAR (W/kg)	Σ SAR (W/kg)	Simult TX	Configuration	GPRS 1900 SAR (W/kg)	2.4G W-LAN (802.11b) SAR (W/kg)	Σ SAR (W/kg)
Body SAR	Top	-	0.017	0.017	Body SAR	Top	-	0.017	0.017
	Bottom	0.103	-	0.103		Bottom	0.330	-	0.330
	Front	0.583	0.038	0.621		Front	0.425	0.038	0.463
	Rear	1.150	0.147	1.297		Rear	0.764	0.147	0.911
	Right	0.672	-	0.672		Right	0.151	-	0.151
	Left	0.593	0.054	0.647		Left	0.289	0.054	0.343

Table 13.9 Simultaneous Transmission Scenario (Hotspot at 10 mm)

Simult TX	Configuration	WCDMA 850 SAR (W/kg)	2.4G W-LAN (802.11b) SAR (W/kg)	Σ SAR (W/kg)	Simult TX	Configuration	WCDMA 1900 SAR (W/kg)	2.4G W-LAN (802.11b) SAR (W/kg)	Σ SAR (W/kg)
Body SAR	Top	-	0.017	0.017	Body SAR	Top	-	0.017	0.017
	Bottom	0.065	-	0.065		Bottom	0.379	-	0.379
	Front	0.531	0.038	0.569		Front	0.462	0.038	0.500
	Rear	0.953	0.147	1.100		Rear	1.183	0.147	1.330
	Right	0.512	-	0.512		Right	0.154	-	0.154
	Left	0.476	0.054	0.530		Left	0.332	0.054	0.386

13.7 Simultaneous Transmission Conclusion

The above numerical summed SAR results for all the worst-case simultaneous transmission conditions were below the SAR limit. Therefore, the above analysis is sufficient to determine that simultaneous transmission cases will not exceed the SAR limit and therefore no measured volumetric simultaneous SAR summation is required per FCC KDB Publication 447498 D01v05r02 and IEEE 1528-2013 Section 6.3.4.1.2.

14. SAR MEASUREMENT VARIABILITY

14.1 Measurement Variability

Per FCC KDB Publication 865664 D01v01r03, SAR measurement variability was assessed for each frequency band, which was determined by the SAR probe calibration point and tissue-equivalent medium used for the device measurements. When both head and body tissue-equivalent media were required for SAR measurements in a frequency band, the variability measurement procedures were applied to the tissue medium with the highest measured SAR, using the highest measured SAR configuration for that tissue-equivalent medium. These additional measurements were repeated after the completion of all measurements requiring the same head or body tissue-equivalent medium in a frequency band. The test device was returned to ambient conditions (normal room temperature) with the battery fully charged before it was re-mounted on the device holder for the repeated measurement(s) to minimize any unexpected variations in the repeated results.

SAR Measurement Variability was assessed using the following procedures for each frequency band:

1. When the original highest measured SAR is ≥ 0.80 W/kg, the measurement was repeated once.
2. A second repeated measurement was performed only if the ratio of largest to smallest SAR for the original and first repeated measurements was > 1.20 or when the original or repeated measurement was ≥ 1.45 W/kg (~ 10% from the 1-g SAR limit).
3. A third repeated measurement was performed only if the original, first or second repeated measurement was ≥ 1.5 W/kg and the ratio of largest to smallest SAR for the original, first and second repeated measurements is > 1.20 .
4. Repeated measurements are not required when the original highest measured SAR is < 0.80 W/kg

Table 14.1 Head SAR Measurement Variability Results

Frequency		Mode	Service	# of Time Slots	Phantom Position	Measured SAR (1g)	1st Repeated SAR(1g)	Ratio	2nd Repeated SAR(1g)	Ratio	3rd Repeated SAR(1g)	Ratio
MHz	Ch.					(W/kg)	(W/kg)		(W/kg)		(W/kg)	
1909.8	810	PCS1900	GPRS	4	Left Touch	1.140	1.060	1.08	N/A	N/A	N/A	N/A
ANSI / IEEE C95.1-2005– SAFETY LIMIT Spatial Peak Uncontrolled Exposure/General Population Exposure						Body 1.6 W/kg (mW/g) averaged over 1 gram						

Table 14.2 Body SAR Measurement Variability Results

Frequency		Mode	Service	# of Time Slots	Spacing [Side]	Measured SAR (1g)	1st Repeated SAR(1g)	Ratio	2nd Repeated SAR(1g)	Ratio	3rd Repeated SAR(1g)	Ratio
MHz	Ch.					(W/kg)	(W/kg)		(W/kg)		(W/kg)	
848.8	251	GSM 850	GPRS	2	10 mm [Rear]	1.150	1.140	1.01	N/A	N/A	N/A	N/A
1907.6	9538	WCDMA 1900	RMC	N/A	10 mm [Rear]	1.130	1.090	1.04	N/A	N/A	N/A	N/A
ANSI / IEEE C95.1-2005– SAFETY LIMIT Spatial Peak Uncontrolled Exposure/General Population Exposure						Body 1.6 W/kg (mW/g) averaged over 1 gram						

14.2 Measurement Uncertainty

The measured SAR was < 1.5 W/kg for all frequency bands. Therefore, per KDB Publication 865664 D01v01r03, the standard measurement uncertainty analysis per IEEE 1528-2003 was not required.

15. IEEE P1528 –MEASUREMENT UNCERTAINTIES

835 MHz Head

Error Description	Uncertain value $\pm\%$	Probability Distribution	Divisor	(Ci) 1g	Standard (1g)	vi 2 or Veff
Measurement System						
Probe calibration	± 6.0	Normal	1	1	$\pm 6.0 \%$	∞
Axial isotropy	± 4.7	Rectangular	$\sqrt{3}$	1	$\pm 2.714 \%$	∞
Hemispherical isotropy	± 9.6	Rectangular	$\sqrt{3}$	1	$\pm 5.543 \%$	∞
Boundary Effects	± 0.8	Rectangular	$\sqrt{3}$	1	$\pm 0.462 \%$	∞
Probe Linearity	± 4.7	Rectangular	$\sqrt{3}$	1	$\pm 2.714 \%$	∞
Detection limits	± 0.25	Rectangular	$\sqrt{3}$	1	$\pm 0.144 \%$	∞
Readout Electronics	± 1.0	Normal	1	1	$\pm 1.0 \%$	∞
Response time	± 0.8	Rectangular	$\sqrt{3}$	1	$\pm 0.462 \%$	∞
Integration time	± 2.6	Rectangular	$\sqrt{3}$	1	$\pm 1.501 \%$	∞
RF Ambient Conditions	± 3.0	Rectangular	$\sqrt{3}$	1	$\pm 1.732 \%$	∞
Probe Positioner	± 0.4	Rectangular	$\sqrt{3}$	1	$\pm 0.231 \%$	∞
Probe Positioning	± 2.9	Rectangular	$\sqrt{3}$	1	$\pm 1.674 \%$	∞
Algorithms for Max. SAR Eval.	± 1.0	Rectangular	$\sqrt{3}$	1	$\pm 0.577 \%$	∞
Test Sample Related						
Device Positioning	± 2.9	Normal	1	1	$\pm 2.9 \%$	145
Device Holder	± 3.6	Normal	1	1	$\pm 3.6 \%$	5
Power Drift	± 5.0	Rectangular	$\sqrt{3}$	1	$\pm 2.887 \%$	∞
Physical Parameters						
Phantom Shell	± 4.0	Rectangular	$\sqrt{3}$	1	$\pm 2.309 \%$	∞
Liquid conductivity (Target)	± 5.0	Rectangular	$\sqrt{3}$	0.64	$\pm 2.887 \%$	∞
Liquid conductivity (Meas.)	± 4.3	Normal	1	0.64	$\pm 4.3 \%$	∞
Liquid permittivity (Target)	± 5.0	Rectangular	$\sqrt{3}$	0.6	$\pm 2.887 \%$	∞
Liquid permittivity (Meas.)	± 4.7	Normal	1	0.6	$\pm 4.7 \%$	∞
Combined Standard Uncertainty					$\pm 12.2 \%$	330
Expanded Uncertainty (k=2)					$\pm 24.4 \%$	

The above measurement uncertainties are according to IEEE P1528 (2003)

835 MHz Body

Error Description	Uncertainty value $\pm\%$	Probability Distribution	Divisor	(Ci) 1g	Standard (1g)	vi 2 or Veff
Measurement System						
Probe calibration	± 6.0	Normal	1	1	$\pm 6.0 \%$	∞
Axial isotropy	± 4.7	Rectangular	$\sqrt{3}$	1	$\pm 2.714 \%$	∞
Hemispherical isotropy	± 9.6	Rectangular	$\sqrt{3}$	1	$\pm 5.543 \%$	∞
Boundary Effects	± 0.8	Rectangular	$\sqrt{3}$	1	$\pm 0.462 \%$	∞
Probe Linearity	± 4.7	Rectangular	$\sqrt{3}$	1	$\pm 2.714 \%$	∞
Detection limits	± 0.25	Rectangular	$\sqrt{3}$	1	$\pm 0.144 \%$	∞
Readout Electronics	± 1.0	Normal	1	1	$\pm 1.0 \%$	∞
Response time	± 0.8	Rectangular	$\sqrt{3}$	1	$\pm 0.462 \%$	∞
Integration time	± 2.6	Rectangular	$\sqrt{3}$	1	$\pm 1.501 \%$	∞
RF Ambient Conditions	± 3.0	Rectangular	$\sqrt{3}$	1	$\pm 1.732 \%$	∞
Probe Positioner	± 0.4	Rectangular	$\sqrt{3}$	1	$\pm 0.231 \%$	∞
Probe Positioning	± 2.9	Rectangular	$\sqrt{3}$	1	$\pm 1.674 \%$	∞
Algorithms for Max. SAR Eval.	± 1.0	Rectangular	$\sqrt{3}$	1	$\pm 0.577 \%$	∞
Test Sample Related						
Device Positioning	± 2.9	Normal	1	1	$\pm 2.9 \%$	145
Device Holder	± 3.6	Normal	1	1	$\pm 3.6 \%$	5
Power Drift	± 5.0	Rectangular	$\sqrt{3}$	1	$\pm 2.887 \%$	∞
Physical Parameters						
Phantom Shell	± 4.0	Rectangular	$\sqrt{3}$	1	$\pm 2.309 \%$	∞
Liquid conductivity (Target)	± 5.0	Rectangular	$\sqrt{3}$	0.64	$\pm 2.887 \%$	∞
Liquid conductivity (Meas.)	± 4.1	Normal	1	0.64	$\pm 4.1 \%$	∞
Liquid permittivity (Target)	± 5.0	Rectangular	$\sqrt{3}$	0.6	$\pm 2.887 \%$	∞
Liquid permittivity (Meas.)	± 4.5	Normal	1	0.6	$\pm 4.5 \%$	∞
Combined Standard Uncertainty					$\pm 12.1 \%$	330
Expanded Uncertainty (k=2)					$\pm 24.2 \%$	

The above measurement uncertainties are according to IEEE P1528 (2003)

1900 MHz Head

Error Description	Uncertainty value $\pm\%$	Probability Distribution	Divisor	(Ci) 1g	Standard (1g)	vi 2 or Veff
Measurement System						
Probe calibration	± 6.0	Normal	1	1	$\pm 6.0 \%$	∞
Axial isotropy	± 4.7	Rectangular	$\sqrt{3}$	1	$\pm 2.714 \%$	∞
Hemispherical isotropy	± 9.6	Rectangular	$\sqrt{3}$	1	$\pm 5.543 \%$	∞
Boundary Effects	± 0.8	Rectangular	$\sqrt{3}$	1	$\pm 0.462 \%$	∞
Probe Linearity	± 4.7	Rectangular	$\sqrt{3}$	1	$\pm 2.714 \%$	∞
Detection limits	± 0.25	Rectangular	$\sqrt{3}$	1	$\pm 0.144 \%$	∞
Readout Electronics	± 1.0	Normal	1	1	$\pm 1.0 \%$	∞
Response time	± 0.8	Rectangular	$\sqrt{3}$	1	$\pm 0.462 \%$	∞
Integration time	± 2.6	Rectangular	$\sqrt{3}$	1	$\pm 1.501 \%$	∞
RF Ambient Conditions	± 3.0	Rectangular	$\sqrt{3}$	1	$\pm 1.732 \%$	∞
Probe Positioner	± 0.4	Rectangular	$\sqrt{3}$	1	$\pm 0.231 \%$	∞
Probe Positioning	± 2.9	Rectangular	$\sqrt{3}$	1	$\pm 1.674 \%$	∞
Algorithms for Max. SAR Eval.	± 1.0	Rectangular	$\sqrt{3}$	1	$\pm 0.577 \%$	∞
Test Sample Related						
Device Positioning	± 2.9	Normal	1	1	$\pm 2.9 \%$	145
Device Holder	± 3.6	Normal	1	1	$\pm 3.6 \%$	5
Power Drift	± 5.0	Rectangular	$\sqrt{3}$	1	$\pm 2.887 \%$	∞
Physical Parameters						
Phantom Shell	± 4.0	Rectangular	$\sqrt{3}$	1	$\pm 2.309 \%$	∞
Liquid conductivity (Target)	± 5.0	Rectangular	$\sqrt{3}$	0.64	$\pm 2.887 \%$	∞
Liquid conductivity (Meas.)	± 4.5	Normal	1	0.64	$\pm 4.5 \%$	∞
Liquid permittivity (Target)	± 5.0	Rectangular	$\sqrt{3}$	0.6	$\pm 2.887 \%$	∞
Liquid permittivity (Meas.)	± 4.4	Normal	1	0.6	$\pm 4.4 \%$	∞
Combined Standard Uncertainty					$\pm 12.2 \%$	330
Expanded Uncertainty (k=2)					$\pm 24.4 \%$	

The above measurement uncertainties are according to IEEE P1528 (2003)

1900 MHz Body

Error Description	Uncertainty value $\pm\%$	Probability Distribution	Divisor	(Ci) 1g	Standard (1g)	vi 2 or Veff
Measurement System						
Probe calibration	± 6.0	Normal	1	1	$\pm 6.0 \%$	∞
Axial isotropy	± 4.7	Rectangular	$\sqrt{3}$	1	$\pm 2.714 \%$	∞
Hemispherical isotropy	± 9.6	Rectangular	$\sqrt{3}$	1	$\pm 5.543 \%$	∞
Boundary Effects	± 0.8	Rectangular	$\sqrt{3}$	1	$\pm 0.462 \%$	∞
Probe Linearity	± 4.7	Rectangular	$\sqrt{3}$	1	$\pm 2.714 \%$	∞
Detection limits	± 0.25	Rectangular	$\sqrt{3}$	1	$\pm 0.144 \%$	∞
Readout Electronics	± 1.0	Normal	1	1	$\pm 1.0 \%$	∞
Response time	± 0.8	Rectangular	$\sqrt{3}$	1	$\pm 0.462 \%$	∞
Integration time	± 2.6	Rectangular	$\sqrt{3}$	1	$\pm 1.501 \%$	∞
RF Ambient Conditions	± 3.0	Rectangular	$\sqrt{3}$	1	$\pm 1.732 \%$	∞
Probe Positioner	± 0.4	Rectangular	$\sqrt{3}$	1	$\pm 0.231 \%$	∞
Probe Positioning	± 2.9	Rectangular	$\sqrt{3}$	1	$\pm 1.674 \%$	∞
Algorithms for Max. SAR Eval.	± 1.0	Rectangular	$\sqrt{3}$	1	$\pm 0.577 \%$	∞
Test Sample Related						
Device Positioning	± 2.9	Normal	1	1	$\pm 2.9 \%$	145
Device Holder	± 3.6	Normal	1	1	$\pm 3.6 \%$	5
Power Drift	± 5.0	Rectangular	$\sqrt{3}$	1	$\pm 2.887 \%$	∞
Physical Parameters						
Phantom Shell	± 4.0	Rectangular	$\sqrt{3}$	1	$\pm 2.309 \%$	∞
Liquid conductivity (Target)	± 5.0	Rectangular	$\sqrt{3}$	0.64	$\pm 2.887 \%$	∞
Liquid conductivity (Meas.)	± 4.3	Normal	1	0.64	$\pm 4.3 \%$	∞
Liquid permittivity (Target)	± 5.0	Rectangular	$\sqrt{3}$	0.6	$\pm 2.887 \%$	∞
Liquid permittivity (Meas.)	± 4.1	Normal	1	0.6	$\pm 4.1 \%$	∞
Combined Standard Uncertainty					$\pm 12.1 \%$	330
Expanded Uncertainty (k=2)					$\pm 24.2 \%$	

The above measurement uncertainties are according to IEEE P1528 (2003)

2450 MHz Head

Error Description	Uncertainty value $\pm\%$	Probability Distribution	Divisor	(Ci) 1g	Standard (1g)	vi 2 or Veff
Measurement System						
Probe calibration	± 6.0	Normal	1	1	$\pm 6.0 \%$	∞
Axial isotropy	± 4.7	Rectangular	$\sqrt{3}$	1	$\pm 2.714 \%$	∞
Hemispherical isotropy	± 9.6	Rectangular	$\sqrt{3}$	1	$\pm 5.543 \%$	∞
Boundary Effects	± 0.8	Rectangular	$\sqrt{3}$	1	$\pm 0.462 \%$	∞
Probe Linearity	± 4.7	Rectangular	$\sqrt{3}$	1	$\pm 2.714 \%$	∞
Detection limits	± 0.25	Rectangular	$\sqrt{3}$	1	$\pm 0.144 \%$	∞
Readout Electronics	± 1.0	Normal	1	1	$\pm 1.0 \%$	∞
Response time	± 0.8	Rectangular	$\sqrt{3}$	1	$\pm 0.462 \%$	∞
Integration time	± 2.6	Rectangular	$\sqrt{3}$	1	$\pm 1.501 \%$	∞
RF Ambient Conditions	± 3.0	Rectangular	$\sqrt{3}$	1	$\pm 1.732 \%$	∞
Probe Positioner	± 0.4	Rectangular	$\sqrt{3}$	1	$\pm 0.231 \%$	∞
Probe Positioning	± 2.9	Rectangular	$\sqrt{3}$	1	$\pm 1.674 \%$	∞
Algorithms for Max. SAR Eval.	± 1.0	Rectangular	$\sqrt{3}$	1	$\pm 0.577 \%$	∞
Test Sample Related						
Device Positioning	± 2.9	Normal	1	1	$\pm 2.9 \%$	145
Device Holder	± 3.6	Normal	1	1	$\pm 3.6 \%$	5
Power Drift	± 5.0	Rectangular	$\sqrt{3}$	1	$\pm 2.887 \%$	∞
Physical Parameters						
Phantom Shell	± 4.0	Rectangular	$\sqrt{3}$	1	$\pm 2.309 \%$	∞
Liquid conductivity (Target)	± 5.0	Rectangular	$\sqrt{3}$	0.64	$\pm 2.887 \%$	∞
Liquid conductivity (Meas.)	± 4.5	Normal	1	0.64	$\pm 4.5 \%$	∞
Liquid permittivity (Target)	± 5.0	Rectangular	$\sqrt{3}$	0.6	$\pm 2.887 \%$	∞
Liquid permittivity (Meas.)	± 4.6	Normal	1	0.6	$\pm 4.6 \%$	∞
Combined Standard Uncertainty					$\pm 12.2 \%$	330
Expanded Uncertainty (k=2)					$\pm 24.4 \%$	

The above measurement uncertainties are according to IEEE P1528 (2003)

2450 MHz Body

Error Description	Uncertainty value $\pm\%$	Probability Distribution	Divisor	(Ci) 1g	Standard (1g)	vi 2 or Veff
Measurement System						
Probe calibration	± 6.0	Normal	1	1	$\pm 6.0 \%$	∞
Axial isotropy	± 4.7	Rectangular	$\sqrt{3}$	1	$\pm 2.714 \%$	∞
Hemispherical isotropy	± 9.6	Rectangular	$\sqrt{3}$	1	$\pm 5.543 \%$	∞
Boundary Effects	± 0.8	Rectangular	$\sqrt{3}$	1	$\pm 0.462 \%$	∞
Probe Linearity	± 4.7	Rectangular	$\sqrt{3}$	1	$\pm 2.714 \%$	∞
Detection limits	± 0.25	Rectangular	$\sqrt{3}$	1	$\pm 0.144 \%$	∞
Readout Electronics	± 1.0	Normal	1	1	$\pm 1.0 \%$	∞
Response time	± 0.8	Rectangular	$\sqrt{3}$	1	$\pm 0.462 \%$	∞
Integration time	± 2.6	Rectangular	$\sqrt{3}$	1	$\pm 1.501 \%$	∞
RF Ambient Conditions	± 3.0	Rectangular	$\sqrt{3}$	1	$\pm 1.732 \%$	∞
Probe Positioner	± 0.4	Rectangular	$\sqrt{3}$	1	$\pm 0.231 \%$	∞
Probe Positioning	± 2.9	Rectangular	$\sqrt{3}$	1	$\pm 1.674 \%$	∞
Algorithms for Max. SAR Eval.	± 1.0	Rectangular	$\sqrt{3}$	1	$\pm 0.577 \%$	∞
Test Sample Related						
Device Positioning	± 2.9	Normal	1	1	$\pm 2.9 \%$	145
Device Holder	± 3.6	Normal	1	1	$\pm 3.6 \%$	5
Power Drift	± 5.0	Rectangular	$\sqrt{3}$	1	$\pm 2.887 \%$	∞
Physical Parameters						
Phantom Shell	± 4.0	Rectangular	$\sqrt{3}$	1	$\pm 2.309 \%$	∞
Liquid conductivity (Target)	± 5.0	Rectangular	$\sqrt{3}$	0.64	$\pm 2.887 \%$	∞
Liquid conductivity (Meas.)	± 4.7	Normal	1	0.64	$\pm 4.7 \%$	∞
Liquid permittivity (Target)	± 5.0	Rectangular	$\sqrt{3}$	0.6	$\pm 2.887 \%$	∞
Liquid permittivity (Meas.)	± 4.8	Normal	1	0.6	$\pm 4.8 \%$	∞
Combined Standard Uncertainty					$\pm 12.3 \%$	330
Expanded Uncertainty (k=2)					$\pm 24.6 \%$	

The above measurement uncertainties are according to IEEE P1528 (2003)

16.CONCLUSION

Measurement Conclusion

The SAR measurement indicates that the EUT complies with the RF radiation exposure limits of the FCC. These measurements are taken to simulate the RF effects exposure under the worst-case conditions. Precise laboratory measures were taken to assure repeatability of the tests. The tested device complies with the requirements in respect to all parameters subject to the test. The test results and statements relate only to the item(s) tested.

Please note that the absorption and distribution of electromagnetic energy in the body are very complex phenomena that depend on the mass, shape, and size of the body, the orientation of the body with respect to the field vectors, and the electrical properties of both the body and the environment. Other variables that may play a substantial role impossible biological effect are those that characterize the environment (e.g. ambient temperature, air velocity, relative humidity, and body insulation) and those that characterize the individual (e.g. age, gender, activity level, debilitation, or disease).

Because innumerable factors may interact to determine the specific biological outcome of an exposure to electromagnetic fields, any protection guide shall consider maximal amplification of biological effects as a result of field-body interactions, environmental conditions, and physiological variables.

17. REFERENCES

- [1] Federal Communications Commission, ET Docket 93-62, Guidelines for Evaluating the Environmental Effects of Radio frequency Radiation, Aug. 1996.
- [2] ANSI/IEEE C95.1-2005, American National Standard safety levels with respect to human exposure to radio frequency electromagnetic fields, 3kHz to 300GHz, New York: IEEE, 2006.
- [3] ANSI/IEEE C95.1-1992, American National Standard safety levels with respect to human exposure to radio frequency electromagnetic fields, 3kHz to 300GHz, New York: IEEE, Sept. 1992.
- [4] ANSI/IEEE C95.3-2002, IEEE Recommended Practice for the Measurement of Potentially Hazardous Electromagnetic Fields - RF and Microwave, New York: IEEE, December 2002.
- [5] IEEE Standards Coordinating Committee 39 –Standards Coordinating Committee 34 – IEEE Std. 1528-2003, Recommended Practice for Determining the Peak Spatial-Average Specific Absorption Rate (SAR) in the Human Body Due to Wireless Communications Devices.
- [6] NCRP, National Council on Radiation Protection and Measurements, Biological Effects and Exposure Criteria for Radio Frequency Electromagnetic Fields, NCRP Report No. 86, 1986. Reprinted Feb. 1995.
- [7] T. Schmid, O. Egger, N. Kuster, Automated E-field scanning system for dosimetric assessments, IEEE Transaction on Microwave Theory and Techniques, vol. 44, Jan. 1996, pp. 105-113.
- [8] K. Pokovic, T. Schmid, N. Kuster, Robust setup for precise calibration of E-field probes in tissue simulating liquids at mobile communications frequencies, ICECOM97, Oct. 1997, pp. -124.
- [9] K. Pokovic, T. Schmid, and N. Kuster, E-field Probe with improved isotropy in brain simulating liquids, Proceedings of the ELMAR, Zadar, Croatia, June 23-25, 1996, pp. 172-175.
- [10] Schmid & Partner Engineering AG, Application Note: Data Storage and Evaluation, June 1998, p2.
- [11] V. Hombach, K. Meier, M. Burkhardt, E. Kuhn, N. Kuster, The Dependence of EM Energy Absorption upon Human Modeling at 900 MHz, IEEE Transaction on Microwave Theory and Techniques, vol. 44 no. 10, Oct. 1996, pp. 1865-1873.
- [12] N. Kuster and Q. Balzano, Energy absorption mechanism by biological bodies in the near field of dipole antennas above 300MHz, IEEE Transaction on Vehicular Technology, vol. 41, no. 1, Feb. 1992, pp. 17-23.
- [13] G. Hartsgrrove, A. Kraszewski, A. Surowiec, Simulated Biological Materials for Electromagnetic Radiation Absorption Studies, University of Ottawa, Bioelectromagnetics, Canada: 1987, pp. 29-36.
- [14] Q. Balzano, O. Garay, T. Manning Jr., Electromagnetic Energy Exposure of Simulated Users of Portable Cellular Telephones, IEEE Transactions on Vehicular Technology, vol. 44, no.3, Aug. 1995.
- [15] W. Gander, Computer mathematick, Birkhaeuser, Basel, 1992.
- [16] W.H. Press, S.A. Teukolsky, W.T. Vetterling, and B.P. Flannery, Numerical Recipes in C, The Art of Scientific Computing, Second edition, Cambridge University Press, 1992.
- [17] N. Kuster, R. Kastle, T. Schmid, Dosimetric evaluation of mobile communications equipment with known precision, IEEE Transaction on Communications, vol. E80-B, no. 5, May 1997, pp. 645-652.
- [18] CENELEC CLC/SC111B, European Pre standard (prENV 50166-2), Human Exposure to Electromagnetic Fields High-frequency: 10 kHz-300GHz, Jan. 1995.
- [19] Prof. Dr. Niels Kuster, ETH, Eidgenössische Technische Hochschule Zürich, Dosimetric Evaluation of the Cellular Phone.
- [20] IEC 62209-1, Human exposure to radio frequency fields from hand-held and body-mounted wireless communication devices - Human models, instrumentation, and procedures - Part 1: Procedure to determine the specific absorption rate (SAR) for hand-held devices used in close proximity to the ear (frequency range of 300 MHz to 3 GHz), Feb. 2005.

- [21] Industry Canada RSS-102 Radio Frequency Exposure Compliance of Radio communication Apparatus (All Frequency Bands) Issue 4, March 2010.
- [22] Health Canada Safety Code 6 Limits of Human Exposure to Radio Frequency Electromagnetic Fields in the Frequency Range from 3 kHz – 300 GHz, 2009
- [23] FCC SAR Test Procedures for 2G-3G Devices, Mobile Hotspot and UMPC Devices KDB Publications 941225, D01-D07
- [24] SAR Measurement procedures for IEEE 802.11a/b/g KDB Publication 248227 D01v01r02
- [25] FCC SAR Considerations for Handsets with Multiple Transmitters and Antennas, KDB Publications 648474 D02-D04
- [26] FCC SAR Evaluation Considerations for Laptop, Notebook, Net book and Tablet Computers, FCC KDB Publication 616217 D04
- [27] FCC SAR Measurement and Reporting Requirements for 100MHz – 6 GHz, KDB Publications 865664 D01-D02
- [28] FCC General RF Exposure Guidance and SAR Procedures for Dongles, KDB Publication 447498, D01-D02
- [29] 615223 D01 802 16e WiMax SAR Guidance v01, Nov. 13, 2009
- [30] Anexo à Resolução No. 533, de 10 de Setembro de 2009.
- [31] IEC 62209-2, Human exposure to radio frequency fields from hand-held and body-mounted wireless communication devices - Human models, instrumentation, and procedures - Part 2: Procedure to determine the specific absorption rate (SAR) for wireless communication devices used in close proximity to the human body (frequency range of 30 MHz to 6 GHz), Mar. 2010.