

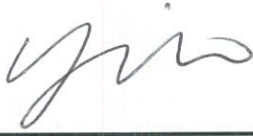



SAR TEST REPORT

HCT CO., LTD

EUT Type:	Cellular/PCS GSM/GPRS/EDGE Rx/WCDMA/HSDPA/HSUPA Phone with Bluetooth and WLAN	
FCC ID:	ZNFD105G	
Model:	LG-D105g	
Additional Model:	LG-D105g, LG-D105G, D105g, D105G, LGD105g, LGD105G, LG-D100g, LG-D100G, D100g, D100G, LGD100g, LGD100G, LG-D100AR, D100AR, LGD100AR	
Date of Issue:	Jun. 13, 2014	
Test report No.:	HCT-A-1406-F004	
Test Laboratory:	HCT CO., LTD. 74, Seoicheon-ro 578beon-gil, Majang-myeon, Icheon-si, Gyeonggi-do, Korea TEL: +82 31 645 6300 FAX: +82 31 645 6401	
Applicant :	LG Electronics, MobileComm U.S.A., Inc. 1000 Sylvan Avenue, Englewood Cliffs NJ 07632	
Testing has been carried out in accordance with:	RSS-102 Issue 4; Health Canada Safety Code 6 47CFR §2.1093 ANSI/ IEEE C95.1 – 1992 IEEE 1528-2003	
Test result:	The tested device complies with the requirements in respect of all parameters subject to the test. The test results and statements relate only to the items tested. The test report shall not be reproduced except in full, without written approval of the laboratory.	
Signature	 _____ Report prepared by : Yun-Jeang Hur Test Engineer of SAR Part	 _____ Approved by : Dong-Seob Kim Manager of SAR Part

Revision History

Rev.	Issue DATE	DESCRIPTION
HCT-A-1406-F004	Jun. 13, 2014	Initial Issue

Table of Contents

1. INTRODUCTION	4
2. TEST METHODOLOGY	5
3. DESCRIPTION OF DEVICE.....	6
4. DESCRIPTION OF TEST EQUIPMENT	6
6. DESCRIPTION OF TEST POSITION.....	1 7
7. MEASUREMENT UNCERTAINTY	1 9
8. ANSI/ IEEE C95.1 - 1992 RF EXPOSURE LIMITS	2 0
9. SAR SYSTEM VALIDATION.....	2 1
10. SYSTEM VERIFICATION.....	2 2
11. RF CONDUCTED POWER MEASUREMENT	2 4
11.5 Test Exclusions Applied.....	3 1
12. SAR Test configuration & Antenna Information	3 2
13. SAR TEST DATA SUMMARY	3 3
13.1-1 Measurement Results (GSM850 Head SAR)	3 3
13.1-2 Measurement Results (GSM1900 Head SAR)	3 3
13.1-3 Measurement Results (WCDMA850 Head SAR).....	3 4
13.1-3 Measurement Results (WCDMA1900 Head SAR).....	3 4
13.1-4 Measurement Results (DTS Head SAR)	3 4
13.2-1 Measurement Results (GSM850 Hotspot SAR).....	3 5
13. 2-2 Measurement Results (GSM1900 Hotspot SAR).....	3 5
13. 2-3 Measurement Results (WCDMA850 Hotspot SAR).....	3 5
13. 2-3 Measurement Results (WCDMA1900 Hotspot SAR).....	3 6
13. 2-4 Measurement Results (WLAN Hotspot SAR)	3 6
13.3-1 Measurement Results (DTS Body-worn SAR).....	3 7
13.3-2 Measurement Results (Body-worn SAR).....	3 7
13.5 SAR Test Notes	3 8
14. SAR Measurement Variability and Uncertainty	4 0
15. SAR Summation Scenario	4 1
16. CONCLUSION.....	4 5
17. REFERENCES	4 6
Attachment 1. – SAR Test Plots	4 7
Attachment 2. – Dipole Verification Plots.....	6 1
Attachment 3. – Probe Calibration Data	6 8
Attachment 4. – Dipole Calibration Data	9 2

1. INTRODUCTION

The FCC has adopted the guidelines for evaluating the environmental effects of radio frequency radiation in ET Docket 93-62 on Aug. 6, 1996 to protect the public and workers from the potential hazards of RF emissions due to FCC-regulated portable devices.

The safety limits used for the environmental evaluation measurements are based on the criteria published by the American National Standards Institute (ANSI) for localized specific absorption rate (SAR) in IEEE/ANSI C95.1-1992 Standard for Safety Levels with Respect to Human Exposure to Radio Frequency Electromagnetic Fields, 3 kHz to 300 GHz. 1992 by the Institute of Electrical and Electronics Engineers, Inc., New York, New York 10017. The measurement procedure described in IEEE/ANSI C95.3-1992 Recommended Practice for the Measurement of Potentially Hazardous Electromagnetic Fields - RF and Microwave is used for guidance in measuring SAR due to the RF radiation exposure from the Equipment Under Test (EUT). These criteria for SAR evaluation are similar to those recommended by the National Council on Radiation Protection and Measurements (NCRP) in Biological Effects and Exposure Criteria for Radio frequency Electromagnetic Fields," NCRP Report No. 86 NCRP, 1986, Bethesda, MD 20814. SAR is a measure of the rate of energy absorption due to exposure to an RF transmitting source. SAR values have been related to threshold levels for potential biological hazards.

SAR Definition

Specific Absorption Rate (SAR) is defined as the time derivative of the incremental electromagnetic energy (dW) absorbed by (dissipated in) an incremental mass (dm) contained in a volume element (dV) of a given density (ρ). It is also defined as the rate of RF energy absorption per unit mass at a point in an absorbing body.

$$SAR = \frac{d}{dt} \left(\frac{dU}{dm} \right) = \frac{d}{dt} \left(\frac{dU}{\rho dV} \right)$$

Figure 1. SAR Mathematical Equation

SAR is expressed in units of Watts per Kilogram (W/kg)

$$SAR = \sigma E^2 / \rho$$

Where:

- σ = conductivity of the tissue-simulant material (S/m)
- ρ = mass density of the tissue-simulant material (kg/m³)
- E = Total RMS electric field strength (V/m)

NOTE: The primary factors that control rate of energy absorption were found to be the wavelength of the incident field in relations to the dimensions and geometry of the irradiated organism, the orientation of the organism in relation to the polarity of field vectors, the presence of reflecting surfaces, and whether conductive contact is made by the organism with a ground plane.

2. TEST METHODOLOGY

The tests documented in this report were performed in accordance with FCC KDB Procedure, IEEE Standard 1528-2003 & IEEE 1528a-2005 and the following published KDB procedures.

- FCC KDB Publication 941225 D01 SAR test for 3G devices v02
- FCC KDB Publication 941225 D02 HSPA and 1x Advanced v02r02
- FCC KDB Publication 941225 D03 SAR Test Reduction GSM GPRS EDGE v01
- FCC KDB Publication 941225 D06 Hot Spot SAR v01r01
- FCC KDB Publication 248227 D01v01r02(SAR Considerationa for 802.11 Devices)
- FCC KDB Publication 447498 D01v05r02 (General SAR Guidance)
- FCC KDB Publication 648474 D04 Handset SAR v01r02
- FCC KDB Publication 865664 D01 SAR measurement 100 MHz to 6 GHz v01r03
- FCC KDB Publication 865664 D02 SAR Reporting v01r01
- October 2013 TCB Workshop Notes (GPRS testing criteria)

3. DESCRIPTION OF DEVICE

Environmental evaluation measurements of specific absorption rate (SAR) distributions in emulated human head and body tissues exposed to radio frequency (RF) radiation from wireless portable devices for compliance with the rules and regulations of the U.S. Federal Communications Commission (FCC).

EUT Type	Cellular/PCS GSM/GPRS/EDGE Rx/WCDMA/HSDPA/HSUPA Phone with Bluetooth and WLAN					
FCC ID:	ZNFD105G					
Model:	LG-D105g					
Additional Model:	LG-D105g, LG-D105G, D105g, D105G, LGD105g, LGD105G, LG-D100g, LG-D100G, D100g, D100G, LGD100g, LGD100G, LG-D100AR, D100AR, LGD100AR					
Trade Name	LG Electronics, MobileComm U.S.A., Inc.					
Application Type	Certification					
Production Unit or Identical Prototype	Prototype					
Max. SAR	Band	Tx Frequency (MHz)	Equipment Class	Reported 1g SAR (W/Kg)		
				Head	Body-Worn	Hotspot
	GSM/GPRS850	824.2 - 848.8	PCE	0.72	1.22	1.22
	GSM/GPRS1900	1 850.2 -1 909.8	PCE	0.80	0.56	0.56
	WCDMA 850	826.4 - 846.6	PCE	0.34	0.67	0.67
	WCDMA 1900	1 852.4 – 1 907.6	PCE	0.66	0.40	0.44
	802.11b	2 412.0 - 2 462.0	DTS	0.56	0.20	0.20
	Bluetooth	2 402 – 2 480	DSS/DTS	-	0.06*	-
Simultaneous SAR per KDB 690783 D01v01r03				1.36	1.42	1.42
Date(s) of Tests	Jun. 09, 2014 ~ Jun. 12, 2014					
Antenna Type	Integral Antenna					
GPRS	Multislot Class: 12, Mode Class B					
Key Feature(s)	This device supports Mobile Hotspot.					

* Note : BT Body-worn SAR value is estimate SAR value that should not be reported standalone SAR on grants of equipment approval.

4. DESCRIPTION OF TEST EQUIPMENT

4.1 SAR MEASUREMENT SETUP

These measurements are performed using the DASY4 automated dosimetric assessment system. It is made by Schmid & Partner Engineering AG (SPEAG) in Zurich, Switzerland. It consists of high precision robotics system (Staubli), robot controller, Pentium III computer, near-field probe, probe alignment sensor, and the generic twin phantom containing the brain equivalent material. The robot is a six-axis industrial robot performing precise movements to position the probe to the location (points) of maximum electromagnetic field (EMF) (see Figure.2).

A cell controller system contains the power supply, robot controller, teach pendant (Joystick), and remote control, is used to drive the robot motors. The PC consists of the HP Pentium IV 3.0 GHz computer with Windows XP system and SAR Measurement Software DASY4, A/D interface card, monitor, mouse, and keyboard. The Staubli Robot is connected to the cell controller to allow software manipulation of the robot. A data acquisition electronic (DAE) circuit performs the signal amplification, signal multiplexing, AD-conversion, offset measurements, mechanical surface detection, collision detection, etc. is connected to the Electro-optical coupler (EOC). The EOC performs the conversion from the optical into digital electric signal of the DAE and transfers data to the PC plug-in card.

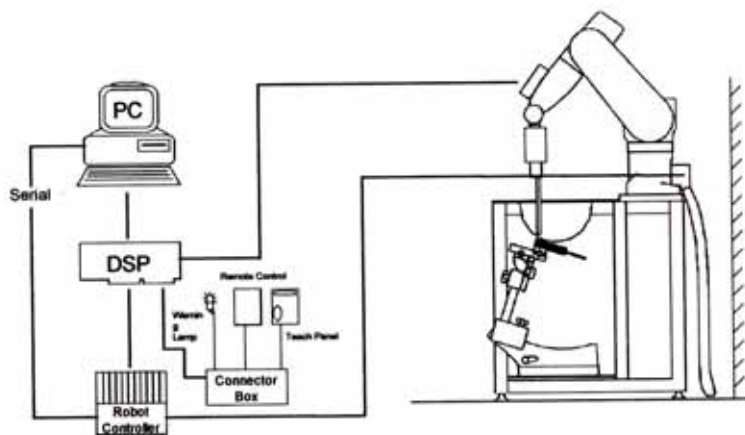

Figure 2. HCT SAR Lab. Test Measurement Set-up

The DAE4 consists of a highly sensitive electrometer-grade preamplifier with auto-zeroing, a channel and gain-switching multiplexer, a fast 16 bit AD-converter and a command decoder and control logic unit. Transmission to the PC-card is accomplished through an optical downlink for data and status information and an optical uplink for commands and clock lines. The mechanical probe mounting device includes two different sensor systems for frontal and sidewise probe contacts. They are also used for mechanical surface detection and probe collision detection. The robot uses its own controller with a built in VME-bus computer. The system is described in detail in.

4.2 DASY E-FIELD PROBE SYSTEM

4.1 ET3DV6 Probe Specification

Construction	Symmetrical design with triangular core Built-in optical fiber for surface detection System Built-in shielding against static charges
Calibration	In air from 10 MHz to 2.5 GHz In brain and muscle simulating tissue at Frequencies of 450 MHz, 900 MHz and 1.8 GHz (accuracy: 8 %)
Frequency	10 MHz to > 3 GHz; Linearity: ± 0.2 dB (30 MHz to 3 GHz)
Directivity	± 0.2 dB in brain tissue (rotation around probe axis) ± 0.4 dB in brain tissue (rotation normal probe axis)
Dynamic	5 μ W/g to > 100 mW/g;
Range Linearity:	± 0.2 dB
Surface Detection	± 0.2 mm repeatability in air and clear liquids over diffuse reflecting surfaces.
Dimensions	Overall length: 330 mm Tip length: 16 mm Body diameter: 12 mm Tip diameter: 6.8 mm Distance from probe tip to dipole centers: 2.7 mm
Application	General dissymmetry up to 3 GHz Compliance tests of WCDMA/LTE Phones Fast automatic scanning in arbitrary phantoms



Figure 3. Photograph of the probe and the Phantom



Figure 4. ET3DV6 E-field Probe

The SAR measurements were conducted with the dosimetric probe ET3DV6, designed in the classical triangular configuration and optimized for dosimetric evaluation. The probe is constructed using the thick film technique; with printed resistive lines on ceramic substrates. The probe is equipped with an optical multifiber line ending at the front of the probe tip. It is connected to the EOC box on the robot arm and provides an automatic detection of the phantom surface. Half of the fibers are connected to a pulsed infrared transmitter, the other half to a synchronized receiver. As the probe approaches the surface, the reflection from the surface produces a coupling from the transmitting to the receiving fibers. This reflection increases first during the approach, reaches a maximum and then decreases. If the probe is flatly touching the surface, the coupling is zero. The distance of the coupling maximum to the surface is independent of the surface reflectivity and largely independent of the surface to probe angle. The DASY4 software reads the reflection during a software approach and looks for the maximum using a 2nd order fitting. The approach is stopped at reaching the maximum.

4.2.1 EX3DV4 Probe Specification

Construction	Symmetrical design with triangular core Interleaved sensors Built-in shielding against static charges PEEK enclosure material (resistant to organic solvents, e.g., DGBE)
Calibration	Basic Broad Band Calibration in air Conversion Factors (CF) for HSL 900 and HSL 1810 Additional CF for other liquids and frequencies upon request
Frequency	10 MHz to 4 GHz; Linearity: ± 0.2 dB (30 MHz to 4 GHz)
Directivity	± 0.2 dB in HSL (rotation around probe axis) ± 0.3 dB in tissue material (rotation normal to probe axis)
Dynamic Range	5 μ W/g to > 100 mW/g; Linearity: ± 0.2 dB
Dimensions	Overall length: 330 mm (Tip: 20 mm) Tip diameter: 3.9 mm (Body: 12 mm) Distance from probe tip to dipole centers: 2.0 mm
Application	General dosimetry up to 4 GHz Dosimetry in strong gradient fields Compliance tests of mobile phones



Figure 5. Photograph of the probe and the Phantom



Figure 6. EX3DV4 E-field Probe

The SAR measurements were conducted with the dosimetric probe EX3DV4, designed in the classical triangular configuration and optimized for dosimetric evaluation. The probe is constructed using the thick film technique; with printed resistive lines on ceramic substrates. The probe is equipped with an optical multifiber line ending at the front of the probe tip. It is connected to the EOC box on the robot arm and provides an automatic detection of the phantom surface. Half of the fibers are connected to a pulsed infrared transmitter, the other half to a synchronized receiver. As the probe approaches the surface, the reflection from the surface produces a coupling from the transmitting to the receiving fibers. This reflection increases first during the approach, reaches a maximum and then decreases. If the probe is flatly touching the surface, the coupling is zero. The distance of the coupling maximum to the surface is independent of the surface reflectivity and largely independent of the surface to probe angle. The DASY4 software reads the reflection during a software approach and looks for the maximum using a 2nd order fitting. The approach is stopped at reaching the maximum.

4.3 PROBE CALIBRATION PROCESS

4.3.1 E-Probe Calibration

Each probe is calibrated according to a dosimetric assessment procedure with an accuracy better than ± 10 %. The spherical isotropy was evaluated with the proper procedure and found to be better than ± 0.25 dB. The sensitivity parameters (NormX, NormY, NormZ), the diode compression parameter (DCP) and the conversion factor (ConvF) of the probe is tested.

The free space E-field from amplified probe outputs is determined in a test chamber. This is performed in a TEM cell for frequencies below 1 GHz, and in a waveguide above 1 GHz for free space. For the free space calibration, the probe is placed in the volumetric center of the cavity and at the proper orientation with the field. The probe is then rotated 360 degrees.

E-field temperature correlation calibration is performed in a flat phantom filled with the appropriate simulated brain tissue. The measured free space E-field in the medium correlates to temperature rise in a dielectric medium. For temperature correlation calibration a RF transparent thermistor-based temperature probe is used in conjunction with the E-field probe.

$$SAR = C \frac{\Delta T}{\Delta t}$$

where:

Δt = exposure time (30 seconds),

C = heat capacity of tissue (brain or muscle),

ΔT = temperature increase due to RF exposure.

SAR is proportional to $\Delta T/\Delta t$, the initial rate of tissue heating, before thermal diffusion takes place.

Now it's possible to quantify the electric field in the simulated tissue by equating the thermally derived SAR to the E-field;

$$SAR = \frac{|E^2| \cdot \sigma}{\rho}$$

where:

σ = simulated tissue conductivity,

ρ = Tissue density (1.25 g/cm³ for brain tissue)

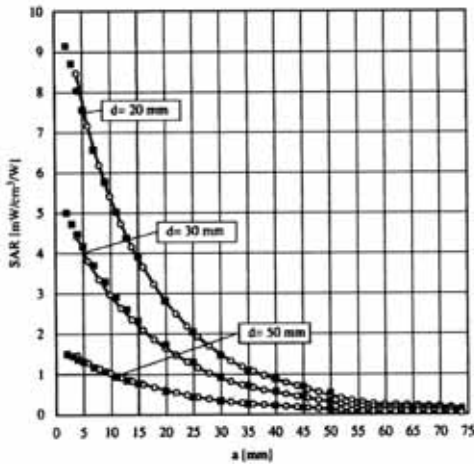

Figure 7. E-Field and Temperature measurements at 900 MHz

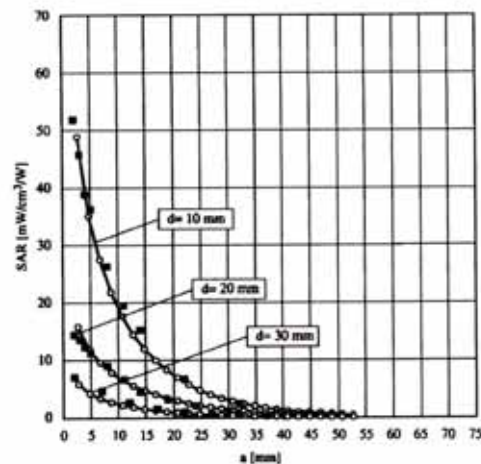

Figure 8. E-Field and temperature measurements at 1.8 GHz

4.3.2 Data Extrapolation

The DASY4 software automatically executes the following procedures to calculate the field units from the microvolt readings at the probe connector. The first step of the evaluation is a linearization of the filtered input signal to account for the compression characteristics of the detector diode. The compensation depends on the input signal, the diode type and the DC-transmission factor from the diode to the evaluation electronics. If the exciting field is pulsed, the crest factor of the signal must be known to correctly compensate for peak power. The formula for each channel can be given like below;

$$V_i = U_i + U_i^2 \cdot \frac{cf}{dcp_i} \quad \text{with} \quad \begin{array}{l} V_i = \text{compensated signal of channel } i \quad (i=x,y,z) \\ U_i = \text{input signal of channel } i \quad (i=x,y,z) \\ cf = \text{crest factor of exciting field} \quad (\text{DASY parameter}) \\ dcp_i = \text{diode compression poing} \quad (\text{DASY parameter}) \end{array}$$

From the compensated input signals the primary field data for each channel can be evaluated:

E-field probes: with

$$E_i = \sqrt{\frac{V_i}{Norm_i \cdot ConvF}}$$

V_i	= compensated signal of channel i	(i=x,y,z)
$Norm_i$	= sensor sensitivity of channel i	(i=x,y,z)
		$\mu\text{V}/(\text{V}/\text{m})^2$ for E-field probes
$ConvF$	= sensitivity of enhancement in solution	
E_i	= electric field strength of channel i in V/m	

The RSS value of the field components gives the total field strength (Hermetian magnitude):

$$E_{tot} = E_x^2 + E_y^2 + E_z^2$$

The primary field data are used to calculate the derived field units.

$$SAR = E_{tot}^2 \cdot \frac{\sigma}{\rho \cdot 1000} \quad \text{with} \quad \begin{array}{l} SAR = \text{local specific absorption rate in W/g} \\ E_{tot} = \text{total field strength in V/m} \\ \sigma = \text{conductivity in [mho/m] or [Siemens/m]} \\ \rho = \text{equivalent tissue density in g/cm}^3 \end{array}$$

The power flow density is calculated assuming the excitation field to be a free space field.

$$P_{pwe} = \frac{E_{tot}^2}{3770} \quad \text{with} \quad \begin{array}{l} P_{pwe} = \text{equivalent power density of a plane wave in w/cm}^2 \\ E_{tot} = \text{total electric field strength in V/m} \end{array}$$

4.4 SAM Phantom

The shell corresponds to the specifications of the Specific Anthropomorphic Mannequin (SAM) phantom defined in IEEE 1528 and IEC 62209-1. It enables the dosimetric evaluation of left and right hand phone usage as well as body mounted usage at the flat phantom region. A cover prevents evaporation of the liquid. Reference markings on the phantom allow the complete setup of all predefined phantom positions and measurement grids by teaching three points with the robot.



Figure 9. SAM Phantom

Shell Thickness	2.0 mm ± 0.2 mm (6 ± 0.2 mm at ear point)
Filling Volume	about 25 L
Dimensions	810 mm x 1 000 mm x 500 mm (H x L x W)

Triple Modular Phantom consists of three identical modules which can be installed and removed separately without emptying the liquid. It includes three reference points for phantom installation. Covers prevent evaporation of the liquid. Phantom material is resistant to DGBE based tissue simulating liquids. The MFP V5.1 will be delivered including wooden support only (**non-standard** SPEAG support).

Applicable for system performance check from 700 MHz to 6 GHz (MFP V5.1C) or 800 MHz - 6 GHz (MFP V5.1A) as well as dosimetric evaluations for body-worn operation.

Shell Thickness	2.0 mm ± 0.2 mm
Filling Volume	approx. 9.2 L
Dimensions	830 mm x 500 mm (L x W)



Figure 10. MFP V5.1 Triple Modular Phantom

4.5 Device Holder for Transmitters

In combination with the SAM Phantom V 4.0, the Mounting Device (POM) enables the rotation of the mounted transmitter in spherical coordinates whereby the rotation points is the ear opening. The devices can be easily, accurately, and repeatably positioned according to the FCC and CENELEC specifications. The device holder can be locked at different phantom locations (left head, right head, flat phantom).

Note: A simulating human hand is not used due to the complex anatomical and geometrical structure of the hand that may produce infinite number of configurations. To produce the Worst-case condition (the hand absorbs antenna output power), the hand is omitted during the tests.



Figure 11. Device Holder

4.6 Tissue Simulating Mixture Characterization

The mixture is characterized to obtain proper dielectric constant (permittivity) and conductivity of the tissue of interest. The tissue dielectric parameters recommended in IEEE 1528 and IEC 62209 have been used as targets for the compositions, and are to match within 5%, per the FCC recommendations.

Ingredients (% by weight)	Frequency (MHz)							
	835		1 900		2 450 ~ 2 700		5 200 - 5 800	
Tissue Type	Head	Body	Head	Body	Head	Body	Head	Body
Water	40.45	53.06	54.9	70.17	71.88	73.2	65.52	78.66
Salt (NaCl)	1.45	0.94	0.18	0.39	0.16	0.1	0.0	0.0
Sugar	57.0	44.9	0.0	0	0.0	0.0	0.0	0.0
HEC	1.0	1.0	0.0	0	0.0	0.0	0.0	0.0
Bactericide	0.1	0.1	0.0	0	0.0	0.0	0.0	0.0
Triton X-100	0.0	0.0	0.0	0.0	19.97	0.0	17.24	10.67
DGBE	0.0	0.0	44.92	29.44	7.99	26.7	0.0	0.0
Diethylene glycol hexyl ether	-	-	-	-	-	-	17.24	10.67

Salt: 99 % Pure Sodium Chloride Sugar: 98 % Pure Sucrose
 Water: De-ionized, 16M resistivity HEC: Hydroxyethyl Cellulose
 DGBE: 99 % Di(ethylene glycol) butyl ether,[2-(2-butoxyethoxy) ethanol]
 Triton X-100(ultra pure): Polyethylene glycol mono[4-(1,1,3,3-tetramethylbutyl)phenyl] ether

Table 4.1 Composition of the Tissue Equivalent Matter

4.7 SAR TEST EQUIPMENT

Manufacturer	Type / Model	S/N	Calib. Date	Calib.Interval	Calib.Due
SPEAG	SAM Phantom	-	N/A	N/A	N/A
SPEAG	Triple Modular Phantom	-	N/A	N/A	N/A
Staubli	Robot RX90B L	F01/5K09A1/A/01	N/A	N/A	N/A
Staubli	Robot ControllerCS7MB	3403-91935	N/A	N/A	N/A
HP	Pavilion t000_puffer	KRJ51201TV	N/A	N/A	N/A
SPEAG	Light Alignment Sensor	265	N/A	N/A	N/A
Staubli	Teach Pendant (Joystick)	D221340.01	N/A	N/A	N/A
SPEAG	DAE3	466	Feb. 27, 2014	Annual	Feb. 27, 2015
SPEAG	DAE4	652	Mar. 26, 2014	Annual	Mar. 26, 2015
SPEAG	E-Field Probe ET3DV6	1609	Sep. 23, 2013	Annual	Sep. 23, 2014
SPEAG	E-Field Probe EX3DV4	3903	Mar. 28, 2014	Annual	Mar. 28, 2015
SPEAG	Dipole D835V2	4d165	Jan. 07, 2014	Annual	Jan. 07, 2015
SPEAG	Dipole D1900V2	5d032	Jul. 29, 2013	Annual	Jul. 29, 2014
SPEAG	Dipole D2450V2	743	Aug. 23, 2013	Annual	Aug. 23, 2014
Agilent	Power Meter(F) E4419B	MY41291386	Nov. 01, 2013	Annual	Nov. 01, 2014
Agilent	Power Sensor(G) 8481	MY41090680	Oct. 30, 2013	Annual	Oct. 30, 2014
HP	Dielectric Probe Kit 85070C	00721521	CBT		
HP	Dual Directional Coupler 778D	16072	Oct. 31, 2013	Annual	Oct. 31, 2014
Agilent	Base Station E5515C	GB44400269	Feb. 10, 2014	Annual	Feb. 10, 2015
HP	Signal Generator 8664A	3744A02069	Nov. 04, 2013	Annual	Nov. 04, 2014
Hewlett Packard	11636B/Power Divider	11377	Nov. 10, 2013	Annual	Nov. 11, 2014
Agilent	N9020A/ SIGNAL ANALYZER	MY51110085	Mar. 25, 2014	Annual	Mar. 25, 2015
TESCOM	TC-3000C / BLUETOOTH	3000C000276	Apr. 11, 2014	Annual	Apr. 11, 2015
HP	Network Analyzer 8753ES	JP39240221	Mar. 21, 2014	Annual	Mar. 21, 2015

NOTE:

1. The E-field probe was calibrated by SPEAG, by the waveguide technique procedure. Dipole Verification measurement is performed by HCT Lab. before each test. The brain/body simulating material is calibrated by HCT using the dielectric probe system and network analyzer to determine the conductivity and permittivity (dielectric constant) of the brain/body-equivalent material.

2. CBT(Calibrating Before Testing). Prior to testing, the dielectric probe kit was calibrated via the network analyzer, with the specified procedure(calibrated in pure water) and calibration kit(standard) short circuit, before the dielectric measurement. The specific procedure and calibration kit are provided by Agilent

5. SAR MEASUREMENT PROCEDURE

The evaluation was performed with the following procedure:

1. The SAR value at a fixed location above the ear point was measured and was used as a reference value for assessing the power drop.
2. The SAR distribution at the exposed side of the head was measured at a distance of 3.9 mm from the inner surface of the shell. The area covered the entire dimension of the head and the horizontal grid spacing was 15 mm x 15 mm. Based on this data, the area of the maximum absorption was determined by spline interpolation.
3. Around this point, a volume of 32 mm x 32 mm x 30 mm was assessed by measuring 5 x 5 x 7 points. On this basis of this data set, the spatial peak SAR value was evaluated with the following procedure:
 - a. The data at the surface were extrapolated, since the center of the dipoles is 2.7 mm away from the tip of the probe and the distance between the surface and the lowest measuring point is 1.2 mm. The extrapolation was based on a least square algorithm. A polynomial of the fourth order was calculated through the points in z-axes. This polynomial was then used to evaluate the points between the surface and the probe tip.
 - b. The maximum interpolated value was searched with a straight-forward algorithm. Around this maximum the SAR values averaged over the spatial volumes (1 g or 10 g) were computed using the 3D-Spline interpolation algorithm. The 3D-spline is composed of three one-dimensional splines with the "Not a knot" condition (in x, y, and z directions. The volume was integrated with the trapezoidal algorithm. One thousand points (10 x 10 x 10) were interpolated to calculate the average.
 - c. All neighboring volumes were evaluated until no neighboring volume with a higher average value was found.
4. The SAR value, at the same location as procedure #1, was re-measured. If the value changed by more than 5 %, the evaluation is repeated.

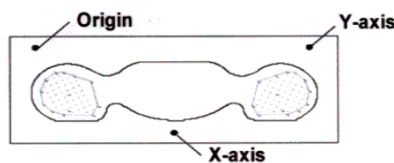

Figure 12. SAR Measurement Point in Area Scan

First Area Scan is used to locate the approximate location(s) of the local peak SAR value(s). The measurement grid within an Area Scan is defined by the grid extend, grid step size and grid offset. Next, in order to determine the EM field distribution in a three-dimensional spatial extension, Zoom Scan is required. The Zoom Scan is performed around the highest E-field value to determine the averaged SASR-distribution over 10g. Area scan and zoom scan resolution setting follow KDB 865664 D01v01r03 quoted below

		≤ 3 GHz	> 3 GHz
Maximum distance from closest measurement point (geometric center of probe sensors) to phantom surface		5 ± 1 mm	$\frac{1}{2} \cdot \delta \cdot \ln(2) \pm 0.5$ mm
Maximum probe angle from probe axis to phantom surface normal at the measurement location		$30^\circ \pm 1^\circ$	$20^\circ \pm 1^\circ$
Maximum area scan spatial resolution: Δx_{Area} , Δy_{Area}		≤ 2 GHz: ≤ 15 mm 2 – 3 GHz: ≤ 12 mm	3 – 4 GHz: ≤ 12 mm 4 – 6 GHz: ≤ 10 mm
		When the x or y dimension of the test device, in the measurement plane orientation, is smaller than the above, the measurement resolution must be \leq the corresponding x or y dimension of the test device with at least one measurement point on the test device.	
Maximum zoom scan spatial resolution: Δx_{Zoom} , Δy_{Zoom}		≤ 2 GHz: ≤ 8 mm 2 – 3 GHz: ≤ 5 mm*	3 – 4 GHz: ≤ 5 mm* 4 – 6 GHz: ≤ 4 mm*
Maximum zoom scan spatial resolution, normal to phantom surface	uniform grid: $\Delta z_{Zoom}(n)$	≤ 5 mm	3 – 4 GHz: ≤ 4 mm 4 – 5 GHz: ≤ 3 mm 5 – 6 GHz: ≤ 2 mm
	graded grid	$\Delta z_{Zoom}(1)$: between 1 st two points closest to phantom surface	≤ 4 mm
		$\Delta z_{Zoom}(n>1)$: between subsequent points	$\leq 1.5 \cdot \Delta z_{Zoom}(n-1)$
Minimum zoom scan volume	x, y, z	≥ 30 mm	3 – 4 GHz: ≥ 28 mm 4 – 5 GHz: ≥ 25 mm 5 – 6 GHz: ≥ 22 mm
<p>Note: δ is the penetration depth of a plane-wave at normal incidence to the tissue medium; see draft standard IEEE P1528-2011 for details.</p> <p>* When zoom scan is required and the <i>reported</i> SAR from the area scan based <i>1-g SAR estimation</i> procedures of KDB 447498 is ≤ 1.4 W/kg, ≤ 8 mm, ≤ 7 mm and ≤ 5 mm zoom scan resolution may be applied, respectively, for 2 GHz to 3 GHz, 3 GHz to 4 GHz and 4 GHz to 6 GHz.</p>			

6. DESCRIPTION OF TEST POSITION

6.1 HEAD POSITION

The device was placed in a normal operating position with the Point A on the device, as illustrated in following drawing, aligned with the location of the RE(ERP) on the phantom. With the ear-piece pressed against the head, the vertical center line of the body of the handset was aligned with an imaginary plane consisting of the RE, LE and M. While maintaining these alignments, the body of the handset was gradually moved towards the cheek until any point on the mouth-piece or keypad contacted the cheek. This is a cheek/touch position. For ear/tilt position, while maintain the device aligned with the BM and FN lines, the device was pivot against ERP back for 15° or until the device antenna touch the phantom. Please refer to IEEE 1528-2003 illustration below.

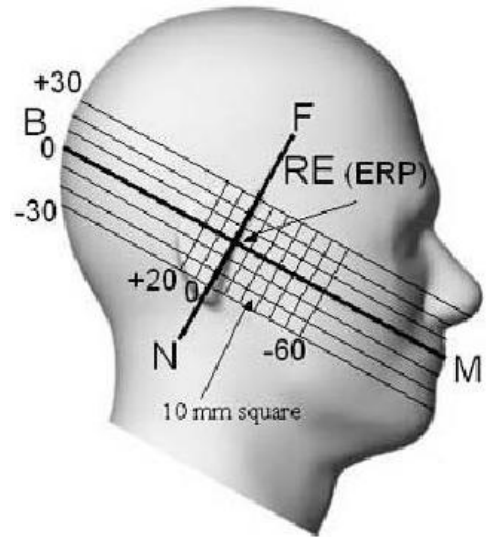

Figure 13. Side view of the phantom

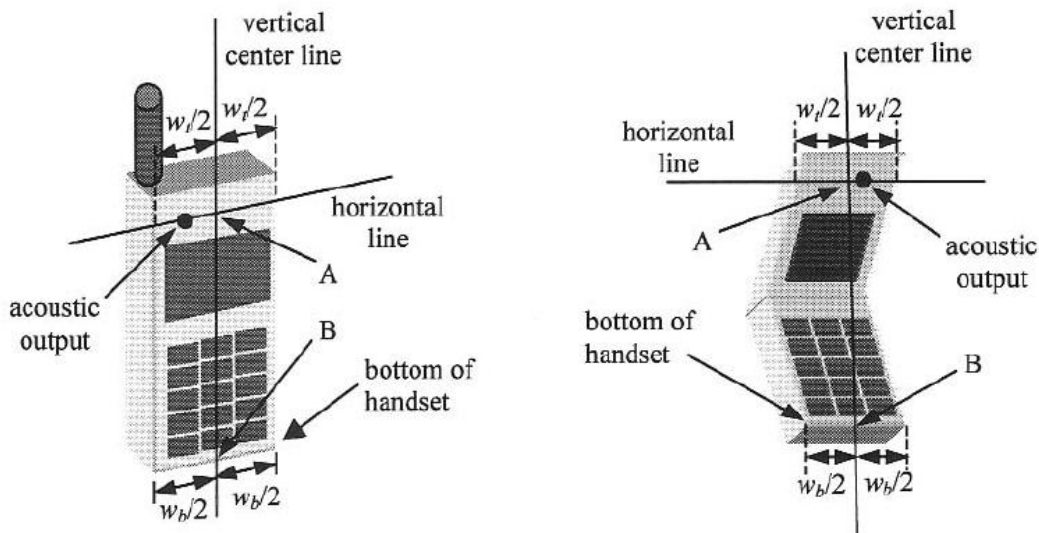

Figure 14. Handset vertical and horizontal reference lines

6.2 Body Holster/Belt Clip Configurations

Body-worn operating configurations are tested with the belt-clips and holsters attached to the device and positioned against a flat phantom in a normal use configuration. A device with a headset output is tested with a headset connected to the device. Body dielectric parameters are used.

Accessories for Body-worn operation configurations are divided into two categories: those that do not contain metallic components and those that contain metallic components. When multiple accessories that do not contain metallic components are supplied with the device, the device is tested with only the accessory that dictates the closest spacing to the body. Then multiple accessories that contain metallic components are tested with each accessory. If multiple accessory share an identical metallic component (i.e. the same metallic belt-clip used with different holsters with no other metallic components) only the accessory that dictates the closest spacing to the body is tested.

Body-worn accessories may not always be supplied or available as options for some Devices intended to be authorized for body-worn use. In this case, a test configuration with a separation distance between the back of the device and the flat phantom is used.

Since this EUT does not supply any body worn accessory to the end user a distance of 1.0 cm from the EUT back surface to the liquid interface is configured for the generic test.

"See the Test SET-UP Photo"

Transmitters that are designed to operate in front of a person's face, as in push-to-talk configurations, are tested for SAR compliance with the front of the device positioned to face the flat phantom. For devices that are carried next to the body such as a shoulder, waist or chest-worn transmitters, SAR compliance is tested with the accessory(ies), Including headsets and microphones, attached to the device and positioned against a flat phantom in a normal use configuration.

In all cases SAR measurements are performed to investigate the worst-case positioning. Worstcase positioning is then documented and used to perform Body SAR testing.

7. MEASUREMENT UNCERTAINTY

Error Description	Tol (± %)	Prob. dist.	Div.	c_i	Standard Uncertainty (± %)	v_{eff}
1. Measurement System						
Probe Calibration	6.00	N	1	1	6.00	
Axial Isotropy	4.70	R	1.73	0.7	1.90	
Hemispherical Isotropy	9.60	R	1.73	0.7	3.88	
Boundary Effects	1.00	R	1.73	1	0.58	
Linearity	4.70	R	1.73	1	2.71	
System Detection Limits	1.00	R	1.73	1	0.58	
Readout Electronics	0.30	N	1.00	1	0.30	
Response Time	0.8	R	1.73	1	0.46	
Integration Time	2.6	R	1.73	1	1.50	
RF Ambient Conditions	3.00	R	1.73	1	1.73	
Probe Positioner	0.40	R	1.73	1	0.23	
Probe Positioning	2.90	R	1.73	1	1.67	
Max SAR Eval	1.00	R	1.73	1	0.58	
2. Test Sample Related						
Device Positioning	2.90	N	1.00	1	2.90	145
Device Holder	3.60	N	1.00	1	3.60	5
Power Drift	5.00	R	1.73	1	2.89	
3. Phantom and Setup						
Phantom Uncertainty	4.00	R	1.73	1	2.31	
Liquid Conductivity(target)	5.00	R	1.73	0.64	1.85	
Liquid Conductivity(meas.)	2.07	N	1	0.64	1.32	9
Liquid Permittivity(target)	5.00	R	1.73	0.6	1.73	
Liquid Permittivity(meas.)	5.02	N	1	0.6	3.01	9
Combine Standard Uncertainty					11.13	
Coverage Factor for 95 %					$k=2$	
Expanded STD Uncertainty					22.25	

Table 7.1 Uncertainty (800 MHz- 2 450 MHz)

8. ANSI/ IEEE C95.1 - 1992 RF EXPOSURE LIMITS

HUMAN EXPOSURE	UNCONTROLLED ENVIRONMENT General Population (W/kg) or (mW/g)	CONTROLLED ENVIRONMENT Occupational (W/kg) or (mW/g)
SPATIAL PEAK SAR * (Brain)	1.60	8.00
SPATIAL AVERAGE SAR ** (Whole Body)	0.08	0.40
SPATIAL PEAK SAR *** (Hands / Feet / Ankle / Wrist)	4.00	20.00

Table 8.1 Safety Limits for Partial Body Exposure

NOTES:

- * The Spatial Peak value of the SAR averaged over any 1 g of tissue (defined as a tissue volume in the shape of a cube) and over the appropriate averaging time.
- ** The Spatial Average value of the SAR averaged over the whole-body.
- *** The Spatial Peak value of the SAR averaged over any 10 g of tissue (defined as a tissue volume in the shape of a cube) and over the appropriate averaging time.

Uncontrolled Environments are defined as locations where there is the exposure of individuals who have no knowledge or control of their exposure.

Controlled Environments are defined as locations where there is exposure that may be incurred by persons who are aware of the potential for exposure, (i.e.as a result of employment or occupation).

9. SAR SYSTEM VALIDATION

Per FCC KCB 865664 D02v01r01, SAR system validation status should be document to confirm measurement accuracy. The SAR systems (including SAR probes, system components and software versions) used for this device were validated against its performance specifications prior to the SAR measurements. Reference dipoles were used with the required tissue- equivalent media for system validation, according to the procedures outlined in IEEE 1528-2003 and FCC KDB 865664 D01v01r03. Since SAR probe calibrations are frequency dependent, each probe calibration point was validated at a frequency within the valid frequency range of the probe calibration point, using the system that normally operates with the probe for routine SAR measurements and according to the required tissue-equivalent media.

A tabulated summary of the system validation status including the validation date(s), measurement frequencies, SAR probes and tissue dielectric parameters has been included.

SAR System #	Probe	probe Type	Probe Calibration Point		Dipole	Date	Dielectric Parameters		CW Validation			Modulation Validation		
							Measured Permittivity	Measured Conductivity	Sensitivity	Probe Linearity	Probe Isortopy	MOD. Type	Duty Factor	PAR
5	3903	EX3DV4	Head	835	4d165	Apr.10,2014	41.3	0.89	PASS	PASS	PASS	GMSK	PASS	N/A
2	1609	ET3DV6	Head	1900	5d032	Oct.09,2013	39.2	1.42	PASS	PASS	PASS	GMSK	PASS	N/A
5	3903	EX3DV4	Head	2450	743	Apr.09,2014	39.5	1.78	PASS	PASS	PASS	OFDM	N/A	PASS
5	3903	EX3DV4	Body	835	4d165	Apr.10,2013	55.1	0.97	PASS	PASS	PASS	GMSK	PASS	N/A
2	1609	ET3DV6	Body	1900	5d032	Oct.09,2013	52.9	1.54	PASS	PASS	PASS	GMSK	PASS	N/A
5	3903	EX3DV4	Body	2450	743	Apr.09,2014	53.1	1.94	PASS	PASS	PASS	OFDM	N/A	PASS

SAR System Validation Summary

Note;

All measurement were performed using probes calibrated for CW signal only. Modulations in the table bove represent test configurations for which the measurement system has been validated per FCC KDB Publication 865664 D01v01r03. SAR system were validated for modulated signals with a periodic duty cycle, such as GMSK, or with a high peak to average ratio (>5 dB), such as OFDM according to KDB 865664 D01v01r03.

10. SYSTEM VERIFICATION

10.1 Tissue Verification

Freq.	Date	Probe	Dipole	Liquid	Liquid Temp.	Parameters	Target Value	Measured Value	Deviation	Limit
[MHz]					[°C]				[%]	[%]
835	Jun. 09, 2014	3903	4d165	Head	20.0	ϵr	41.5	42.2	+ 1.69	± 5
						σ	0.90	0.877	- 2.56	± 5
835	Jun. 10, 2014	3903		Body	19.6	ϵr	55.2	56.9	+ 3.08	± 5
						σ	0.97	0.98	+ 1.03	± 5
1 900	Jun. 11, 2014	1609	5d032	Head	19.8	ϵr	40.0	38.9	- 2.75	± 5
						σ	1.40	1.44	+ 2.86	± 5
1 900	Jun. 11, 2014	1609		Body	19.8	ϵr	53.3	52.3	- 1.88	± 5
						σ	1.52	1.5	- 1.32	± 5
2 450	Jun. 12, 2014	3903	743	Head	20.1	ϵr	39.2	40.2	+ 2.55	± 5
						σ	1.80	1.84	+ 2.22	± 5
2 450	Jun. 12, 2014	3903		Body	20.1	ϵr	52.7	52.3	- 0.76	± 5
						σ	1.95	1.96	+ 0.51	± 5

The Tissue dielectronic parameters were measured prior to the SAR evaluation using an Agilent 85070C Dielectronic Probe Kit and Agilent Network Analyzer.

10.2 System Verification

Prior to assessment, the system is verified to the $\pm 10\%$ of the specifications at 835 MHz / 1 900 MHz / 2 450 MHz by using the system Verification kit. (Graphic Plots Attached)

System Verification Results

Freq.	Date	Probe (S/N)	Dipole (S/N)	Liquid	Amb. Temp.	Liquid Temp.	1 W Target SAR _{1g} (SPEAG)	Measured SAR _{1g}	1 W Normalized SAR _{1g}	Deviation	Limit [%]
[MHz]					[°C]	[°C]	[mW/g]	[mW/g]	[mW/g]	[%]	[%]
835	Jun. 09, 2014	3903	4d165	Head	20.2	20.0	9.24	0.935	9.35	+ 1.19	± 10
835	Jun. 10, 2014	3903		Body	19.8	19.6	9.58	0.996	9.96	+ 3.97	± 10
1 900	Jun. 11, 2014	1609	5d032	Head	20.0	19.8	40.1	3.73	37.3	- 6.98	± 10
1 900	Jun. 11, 2014	1609		Body	20.0	19.8	40.5	3.87	38.7	- 4.44	± 10
2 450	Jun. 12, 2014	3903	743	Head	20.3	20.1	52.8	5.53	55.3	+ 4.73	± 10
2 450	Jun. 12, 2014	3903		Body	20.3	20.1	50.5	5.46	54.6	+ 8.12	± 10

10.3 System Verification Procedure

SAR measurement was prior to assessment, the system is verified to the $\pm 10\%$ of the specifications at each frequency band by using the system Verification kit. (Graphic Plots Attached)

- Cabling the system, using the Verification kit equipments.
- Generate about 100 mW Input Level from the Signal generator to the Dipole Antenna.
- Dipole Antenna was placed below the Flat phantom.
- The measured one-gram SAR at the surface of the phantom above the dipole feed-point should be within 10 % of the target reference value.
- The results are normalized to 1 W input power.

Note;

SAR Verification was performed according to the FCC KDB 865664 D01v01r03.

11. RF CONDUCTED POWER MEASUREMENT

Power measurements were performed using a base station simulator under digital average power. The handset was placed into a simulated call using a base station simulator in a shielded chamber. Such test signals offer a consistent means for testing SAR and are recommended for evaluation SAR. SAR measurements were taken with a fully charged battery. In order to verify that the device was tested and maintained at full power, this was configured with the base station simulator. The SAR measurement Software calculates a reference point at the start and end of the test to check for power drifts. If conducted Power deviations of more than 5 % occurred, the tests were repeated.

11.1 Output Power Specifications.

This device operates using the following maximum output power specifications. SAR values were scaled to the maximum allowed power to determine compliance per KDB publication 447498 D01v05r02.

GSM

GSM850	GSM1900
Target Power : 33.7 dBm	Target Power : 29.7 dBm
GPRS850	PCS1900
GPRS 1tx : 33.7 dBm	GPRS 1tx : 29.7 dBm
GPRS 2tx : 31.7 dBm	GPRS 2tx : 27.7 dBm
GPRS 3tx : 30.7 dBm	GPRS 3tx : 26.7 dBm
GPRS 4tx : 29.7 dBm	GPRS 4tx : 25.7 dBm
Tune-up Tolerance : -1.5 dB/ +0.5 dB	

WCDMA

WCDMA850	WCDMA1900
Target Power : 23.7 dBm	Target Power : 22.7 dBm
HSDPA Sub-test1 : 23.7dBm	HSDPA Sub-test1 : 22.7dBm
HSDPA Sub-test2 : 23.7dBm	HSDPA Sub-test2 : 22.7dBm
HSDPA Sub-test3 : 23.2dBm	HSDPA Sub-test3 : 22.2dBm
HSDPA Sub-test4 : 23.2dBm	HSDPA Sub-test4 : 22.2dBm
Tune-up Tolerance : -1.5 dB/ +0.5 dB	

* MPR Tolerance : +0.5dB/-0.5dB

* The HSUPA transmitter power will not exceed the R99 maximum transmit power in devices based on Qualcomm's HSPA chipset solutions

Wifi

Mode / Band		IEEE 802.11 (in dBm)				
		a	b	g	N (20MHz)	N (40MHz)
2.4 GHz WIFI	Maximum	N/A	15.5	11.3	11	10
	Nominal	N/A	14.5	10.3	10	9

BT.

Bluetooth (Average Power) (in dBm)		DH5	2-DH5	3-DH5	LE
	Maximum	4.5	2	2	-3
	Nominal	3.5	1.5	1.5	-4

11.2 GSM

Conducted output power measurements were performed using a base station simulator under digital average power.



SAR Test for WWAN were performed with a base station simulator Agilent E5515C. Communication between the device and the emulator was established by air link. Set base station emulator to allow DUT to radiate maximum output power during all tests. Please refer to the below worst case SAR operation setup.

- GSM voice: Head SAR, Body SAR
- GPRS Multi-slots : Body SAR with GPRS Multi-slot Class12 with CS 1 (GMSK)

Note;

CS1/MCS7 coding scheme was used in GPRS output power measurements and SAR Testing, as a condition where GMSK/8PSK modulation was ensured. Investigation has shown that CS1 - CS4 settings do not have any impact on the output levels in the GPRS modes.

GSM Conducted output powers (Burst-Average)

Band	Ch.	Voice	GPRS(GMSK) Data – CS1			
		GSM (dBm)	GPRS 1 TX Slot (dBm)	GPRS 2 TX Slot (dBm)	GPRS 3 TX Slot (dBm)	GPRS 4 TX Slot (dBm)
GSM 850	128	33.71	33.67	31.66	30.34	29.44
	190	33.71	33.74	31.62	30.34	29.44
	251	33.75	33.74	31.71	30.44	29.54
GSM 1900	512	29.72	29.72	27.39	26.53	25.31
	661	29.62	29.62	27.29	26.43	25.21
	810	29.54	29.54	27.22	26.36	25.13

GSM Conducted output powers (Frame-Average)

Band	Ch.	Voice	GPRS(GMSK) Data – CS1			
		GSM (dBm)	GPRS 1 TX Slot (dBm)	GPRS 2 TX Slot (dBm)	GPRS 3 TX Slot (dBm)	GPRS 4 TX Slot (dBm)
GSM 850	128	24.68	24.64	25.64	26.08	26.43
	190	24.68	24.71	25.60	26.08	26.43
	251	24.72	24.71	25.69	26.18	26.53
GSM 1900	512	20.69	20.69	21.37	22.27	22.30
	661	20.59	20.59	21.27	22.17	22.20
	810	20.51	20.51	21.20	22.10	22.12

Note:

Time slot average factor is as follows:

- 1 Tx slot = 9.03 dB, Frame-Average output power = Burst-Average output power – 9.03 dB
- 2 Tx slot = 6.02 dB, Frame-Average output power = Burst-Average output power – 6.02 dB
- 3 Tx slot = 4.26 dB, Frame-Average output power = Burst-Average output power – 4.26 dB
- 4 Tx slot = 3.01 dB, Frame-Average output power = Burst-Average output power – 3.01 dB

11.3 WCDMA

Body SAR is not required for handsets with HSDPA capabilities when the maximum average output of each RF channel with HSDPA active is less than ¼ dB higher than that measured without HSDPA using 12.2 kbps RMC and the maximum SAR for 12.2 kbps RMC is ≤ 75 % of the SAR limit. Otherwise, SAR is Measured for HSDPA, using an FRC with H-Set 1 in Sub-test 1 and a 12.2 kbps RMC configured in Test Loop Mode 1, using the highest body SAR configuration in 12.2 kbps RMC without HSDPA, on the maximum output channel with the body exposure configuration that results in the highest SAR in 12.2 kbps RMC for that RF channel.

11.3.1 Output Power Verification

Maximum output power is verified on the High, Middle and Low channels according to the general descriptions in section 5.2 of 3 GPP TS 34.121, using the appropriate RMC or AMR with TPC(transmit power control) set to all “1s”.

11.3.2 Head SAR Measurements

SAR for head exposure configurations is measured using the 12.2 kbps RMC with TPC bits configured to all “1s”. SAR in AMR configurations is not required when the maximum average output of each RF channel for 12.2 kbps AMR is less than ¼ dB higher than that measured in 12.2 kbps RMC. Otherwise, SAR is measured on the maximum output channel in 12.2 AMR with a 3.4 kbps SRB (signaling radio bearer) using the exposure configuration that results in the highest SAR for that RF channel in 12.2 RMC.

11.3.3 Body SAR Measurement

SAR for body exposure configurations is measured using the 12.2 kbps RMC with the TPC bits all “1s”.

11.3.4 Handsets with Release 5 HSDPA

Body SAR is not required for handsets with HSDPA capabilities when the maximum average output of each RF channel with HSDPA active is less than ¼ dB higher than that measured without HSDPA using 12.2 kbps RMC and the maximum SAR for 12.2 kbps RMC is ≤ 75 % of the SAR limit. Otherwise, SAR is Measured for HSDPA, using an FRC with H-Set 1 in Sub-test 1 and a 12.2 kbps RMC configured in Test Loop Mode 1, using the highest body SAR configuration in 12.2 kbps RMC without HSDPA, on the maximum output channel with the body exposure configuration that results in the highest SAR in 12.2 kbps RMC for that RF channel.

Sub-Test 1 Setup for Release 5 HSDPA

Sub-test	β_c	β_d	β_d (SF)	β_c/β_d	$\beta_{hs}^{(2)}$	CM (dB) ⁽²⁾
1	2/15	15/15	64	2/15	4/15	0.0
2	12/15 ⁽³⁾	15/15 ⁽³⁾	64	12/15 ⁽³⁾	24/15	1.0
3	15/15	8/15	64	15/8	30/15	1.5
4	15/15	4/15	64	15/4	30/15	1.5

Note 1: Δ_{ACK} , Δ_{NACK} and $\Delta_{CQI} = 8 \Leftrightarrow A_{hs} = \beta_{hs}/\beta_c = 30/15 \Leftrightarrow \beta_{hs} = 30/15 * \beta_c$
 Note 2: CM = 1 for $\beta_c/\beta_d = 12/15$, $\beta_{hs}/\beta_c = 24/15$.
 Note 3: For subtest 2 the β_c/β_d ratio of 12/15 for the TFC during the measurement period (TF1, TF0) is achieved by setting the signaled gain factors for the reference TFC (TF1, TF1) to $\beta_c = 11/15$ and $\beta_d = 15/15$.

11.3.5 Handsets with Release 6 HSPA (HSDPA/HSUPA)

Body SAR is not required for handsets with HSPA capabilities when the maximum average output of each RF channel with HSUPA/HSDPA active is less than ¼ dB higher than that measured without HSUPA/HSDPA using 12.2 kbps RMC and the maximum SAR for 12.2 kbps RMC is ≤ 75 % of the SAR limit. Body SAR for HSPA is measured with E-DCH Sub-test 5, using H-Set 1 and QPSK for FRC and a 12.2 kbps RMC configured in Test Loop Mode 1 with power control algorithm 2, according to the highest body SAR configuration in 12.1 kbps RMC without HSPA. When VOIP is applicable for head exposure, SAR is not required when the maximum output of each RF channel with HSPA is less than ¼ dB higher than that measured using 12.2 kbps RMC; otherwise, the same HSPA configuration used for body measurement should be used to test for head exposure.

Sub-test	β_c	β_d	β_d (SF)	β_c/β_d	$\beta_{hs}^{(1)}$	β_{ec}	β_{ed}	β_{ed} (SF)	β_{ed} (codes)	CM ⁽²⁾ (dB)	MPR (dB)	AG ⁽⁴⁾ Index	E-TFCI
1	11/15 ⁽³⁾	15/15 ⁽³⁾	64	11/15 ⁽³⁾	22/15	209/225	1039/225	4	1	1.0	0.0	20	75
2	6/15	15/15	64	6/15	12/15	12/15	94/75	4	1	3.0	2.0	12	67
3	15/15	9/15	64	15/9	30/15	30/15	$\beta_{ed1}: 47/15$ $\beta_{ed2}: 47/15$	4	2	2.0	1.0	15	92
4	2/15	15/15	64	2/15	4/15	2/15	56/75	4	1	3.0	2.0	17	71
5	15/15 ⁽⁴⁾	15/15 ⁽⁴⁾	64	15/15 ⁽⁴⁾	30/15	24/15	134/15	4	1	1.0	0.0	21	81

Note 1: Δ_{ACK} , Δ_{NACK} and $\Delta_{CQI} = 8 \Leftrightarrow A_{hs} = \beta_{hs}/\beta_c = 30/15 \Leftrightarrow \beta_{hs} = 30/15 * \beta_c$.
 Note 2: CM = 1 for $\beta_c/\beta_d = 12/15$, $\beta_{hs}/\beta_c = 24/15$. For all other combinations of DPDCH, DPCCH, HS-DPCCH, E-DPDCH and E-DPCCH the MPR is based on the relative CM difference.
 Note 3: For subtest 1 the β_c/β_d ratio of 11/15 for the TFC during the measurement period (TF1, TF0) is achieved by setting the signaled gain factors for the reference TFC (TF1, TF1) to $\beta_c = 10/15$ and $\beta_d = 15/15$.
 Note 4: For subtest 5 the β_c/β_d ratio of 15/15 for the TFC during the measurement period (TF1, TF0) is achieved by setting the signaled gain factors for the reference TFC (TF1, TF1) to $\beta_c = 14/15$ and $\beta_d = 15/15$.
 Note 5: Testing UE using E-DPDCH Physical Layer category 1 Sub-test 3 is not required according to TS 25.306 Table 5.1g.
 Note 6: β_d can not be set directly; it is set by Absolute Grant Value.

WCDMA 850

3GPP Release Version	Mode	3GPP 34.121	Cellular Band [dBm]		
		Subtest	UL 4132 DL 4357	UL 4183 DL 4408	UL 4233 DL 4458
99	WCDMA	12.2 kbps RMC	23.95	23.87	23.84
99	WCDMA	12.2 kbps AMR	23.94	23.86	23.81
5	HSDPA	Subtest 1	23.91	23.85	23.78
5		Subtest 2	23.92	23.83	23.77
5		Subtest 3	23.45	23.38	23.31
5		Subtest 4	23.43	23.35	23.29
6	HSUPA	Subtest 1	21.93	21.87	21.83
6		Subtest 2	21.46	21.39	21.33
6		Subtest 3	22.45	22.36	22.32
6		Subtest 4	20.95	20.89	20.81
6		Subtest 5	21.94	21.89	21.82

WCDMA Average Conducted output powers

WCDMA1900

3GPP Release Version	Mode	3GPP 34.121	PCS Band [dBm]		
		Subtest	UL 9262 DL 9662	UL 9400 DL 9800	UL 9538 DL 9938
99	WCDMA	12.2 kbps RMC	23.03	23.04	22.84
99	WCDMA	12.2 kbps AMR	23.01	22.95	22.74
5	HSDPA	Subtest 1	23.00	22.98	22.79
5		Subtest 2	23.01	22.96	22.77
5		Subtest 3	22.55	22.52	22.33
5		Subtest 4	22.51	22.48	22.30
6	HSUPA	Subtest 1	21.06	21.05	20.90
6		Subtest 2	20.58	20.55	20.41
6		Subtest 3	21.56	21.54	21.38
6		Subtest 4	20.06	20.08	19.92
6		Subtest 5	21.08	21.05	20.09

WCDMA Average Conducted output powers

11.4 WiFi

11.4.1 SAR Testing for 802.11b/g/n modes

General Device Setup

Normal Network operating configurations are not suitable for measuring the SAR of 802.11 a/b/g transmitters. Unpredictable fluctuations in network traffic and antenna diversity conditions can introduce undesirable variations in SAR results. The SAR for these devices should be measured using chipset based test mode software to ensure the results are consistent and reliable.

Chipset based test mode software is hardware dependent and generally varies among manufacturers. The device operating parameters established in test mode for SAR measurements must be identical to those programmed in production units, including output power levels, amplifier gain settings and other RF performance tuning parameters. The test frequencies should correspond to actual channel frequencies defined for domestic use. SAR for devices with switched diversity should be measured with only one antenna transmitting at a time during each SAR measurement, according to a fixed modulation and data rate. The same data pattern should be used for all measurements.

Frequency Channel Configurations

802.11 a/b/g and 4.9 GHz operating modes are tested independently according to the service requirements in each frequency band. 802.11 b/g modes are tested on channels 1, 6 and 11. 802.11a is tested for UNII operations on channels 36 and 48 in the 5.15-5.25 GHz band; channels 52 and 64 in the 5.25-5.35 GHz band; Channels 104, 116, 124 and 136 in the 5.470-5.725 GHz band; and channels 149 and 161 in the 5.8 GHz band. When 5.8 GHz § 15.247 is also available, channels 149, 157 and 165 should be tested instead of the UNII channels. 4.9 GHz is tested on channels 1, 10 and 5 or 6, whichever has the higher output power, for 5 MHz channels; channels 11, 15 and 19 for 10 MHz channels; and channels 21 and 25 for 20 MHz channels. These are referred to as the “default test channels”. 802.11g mode was evaluated only if the output power was 0.25 dB higher than the 802.11b mode.

Mode	GHz	Channel	Turbo Channel	“Default Test Channels”				
				§15.247		UNII		
				802.11b	802.11g			
802.11b/g	2.412	1#		√	▽			
	2.437	6	6	√	▽			
	2.462	11#		√	▽			
802.11a	5.18	36				√		
	5.20	40	42 (5.21 GHz)				*	
	5.22	44					*	
	5.24	48	50 (5.25 GHz)			√		
	5.26	52				√		
	5.28	56	58 (5.29 GHz)				*	
	5.30	60					*	
	5.32	64				√		
	5.500	100	Unknown					*
	5.520	104				√		*
	5.540	108						*
	5.560	112						*
	5.580	116				√		*
	5.600	120						*
	5.620	124				√		*
	5.640	128						*
	5.660	132						*
	5.680	136					√	*
	5.700	140					*	
	UNII or §15.247	5.745	149		√		√	*
5.765		153	152 (5.76 GHz)		*		*	
5.785		157		√			*	
5.805		161	160 (5.80 GHz)		*	√	*	
§15.247	5.825	165		√				

802.11 Test Channels per FCC Requirements

IEEE 802.11b Average RF Power

Mode	Freq. [MHz]	Channel	802.11b (2.4 GHz) Conducted Power [dBm]			
			Data Rate (Mbps)			
			1	2	5.5	11
802.11b	2412	1	13.96	13.94	14.00	13.98
	2437	6	14.24	14.22	14.30	14.27
	2462	11	14.50	14.60	14.66	14.53

IEEE 802.11g Average RF Power

Mode	Freq. [MHz]	Channel	802.11g (2.4 GHz) Conducted Power [dBm]							
			Data Rate (Mbps)							
			6	9	12	18	24	36	48	54
802.11g	2412	1	9.31	9.40	9.31	9.31	9.33	9.32	9.33	9.32
	2437	6	11.19	11.22	11.24	11.26	11.03	11.04	11.09	11.12
	2462	11	9.75	9.81	9.74	9.78	9.79	9.79	9.83	9.87

IEEE 802.11n Average RF Power

Mode	Freq. [MHz]	Channel	802.11n (2.4 GHz) Conducted Power [dBm]							
			Data Rate (Mbps)							
			6.5	13	19.5	26	39	52	58.5	65
802.11n (20MHz)	2412	1	9.17	9.18	9.21	9.25	9.28	9.34	9.21	9.11
	2437	6	10.27	10.28	10.30	10.34	10.17	9.96	9.98	9.96
	2462	11	9.96	9.77	9.78	9.81	9.85	9.88	9.89	9.87

IEEE 802.11n Average RF Power

Mode	Freq. [MHz]	Channel	802.11n (2.4 GHz) Conducted Power [dBm]							
			Data Rate (Mbps)							
			13.5	27	40.5	54	81	108	121.5	135
802.11n (40MHz)	2422	3	8.83	8.67	8.71	8.72	8.78	8.85	8.61	8.60
	2437	6	8.89	8.95	8.97	9.00	8.83	8.88	8.87	8.89
	2452	9	9.17	9.04	9.03	9.04	9.09	9.14	9.13	9.13

11.5 Test Exclusions Applied

11.5.1 BT

Per FCC KDB 447498 D01v05r02, The SAR exclusion threshold for distance < 50 mm is defined by the following equation:

$$\frac{\text{Max Power of Channel(mW)}}{\text{Test Separation Distance (mm)}} * \sqrt{\text{Frequency(GHz)}} \leq 3.0$$

Mode	Frequency	Maximum Allowed Power	Separatuin Distance	≤ 3.0
	[MHz]	[mW]	[mm]	
Bluetooth	2441	3	10	0.47

Based on the maximum conducted power of Bluetooth and antenna to use separation distance, Bluetooth SAR was not required $[(3/10)*\sqrt{2.441}] = 0.47 < 3.0$.

This device contains transmitters that may operate simultaneously. Therefore simultaneous transmission analysis is required. Per FCC KDB 447498 D01v05r02 IV.C.1iii, simultaneous transmission SAR test exclusion may be applied when the sum of the 1-g SAR for all the simultaneous transmitting antennas in a specific a physical test configuration is ≤ 1.6W/kg. When standalone SAR is not required to be measured per FCC KDB 447498 D01v05r02 4.3.22, the following equation must be used to estimate the standalone 1-g SAR for simultaneous transmission assessment involving that transmitter.

$$\text{Estimated SAR} = \frac{\sqrt{f(\text{GHZ})}}{7.5} * \frac{(\text{Max Power of channel mW})}{\text{Min Seperation Distance}}$$

Mode	Frequency	Maximum Allowed Power	Separatuin Distance (Body)	Estimated SAR (Body)
	[MHz]	[mW]	[mm]	[W/kg]
Bluetooth	2441	3	10	0.06

Note :

1) Held-to ear configurations are not applicable to Bluetooth operations and therefore were not considered for simultaneous transmission. The Estimated SAR results were determined according to FCC KDB447498 D01v05r02.

2) Bluetooth LE conducted Power is not calculated on the SAR test exclusions table. Because Bluetooth LE conducted power is lower than Bluetooth conducted Power.

12. SAR Test configuration & Antenna Information

12.1 Mobile Hotspot sides for SAR Testing configurations

Mode	Rear	Front	Left	Right	Bottom	Top
GSM/GPRS 850	Yes	Yes	Yes	Yes	Yes	No
GSM/GPRS 1900	Yes	Yes	Yes	Yes	Yes	No
WCDMA 850	Yes	Yes	Yes	Yes	Yes	No
WCDMA 1 900	Yes	Yes	Yes	Yes	Yes	No
2.4 GHz WLAN	Yes	Yes	No	Yes	No	Yes

Note; All test configurations are based on front view.

12.2 Antenna and Device Information

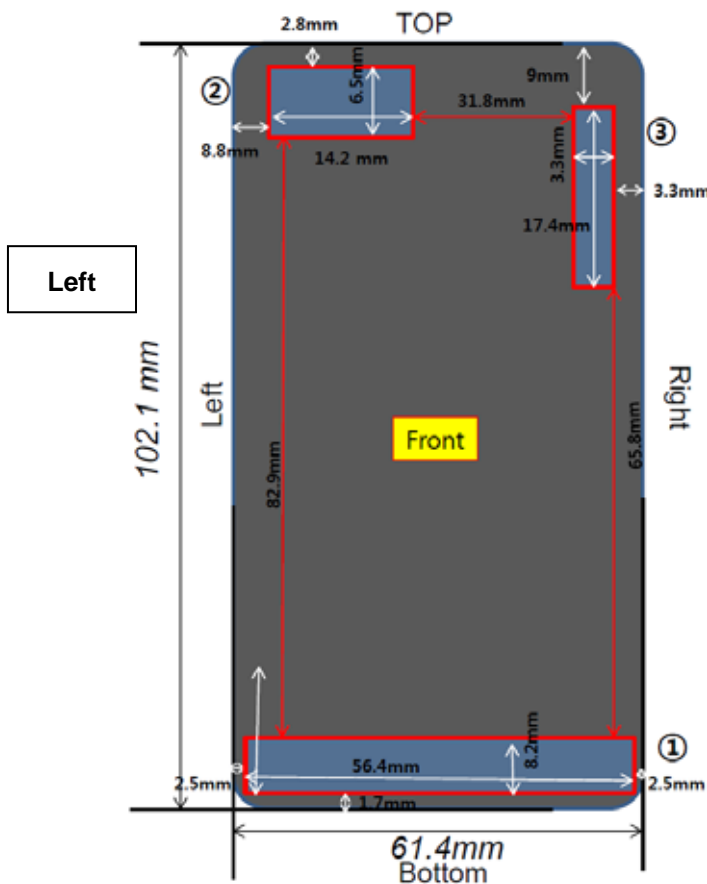

① GSM QUAD,W850,W1900

MODE	BAND	TX(MHz)	RX(MHz)
WCDMA	B2	1,850~1,910	1,930~1,990
	B5	824~849	869~894
GSM	GSM850	824~849	869~894
	PCS1900	1,850~1,910	1,930~1,990
	EGSM900	880~915	925~960
DCS	1,710~1,785	1,805~1,880	

② GPS

MODE	BAND	TX(MHz)	RX(MHz)
GPS	X	X	1575.42

③ BT/WIFI

MODE	TX(MHz)	RX(MHz)
BT & Wifi (802.11b/g/n)	BT : 2402 (1ch) - 2480 (79ch) Wifi : 2412(1ch) - 2462(11ch)	BT : 2402 (1ch) - 2480 (79ch) Wifi : 2412(1ch) - 2462(11ch)

Note;

1. Per FCC KDB Publication 941225 D06v01r01, we performed the SAR testing at 1.0 cm from the top & bottom surfaces and also from side edges with a transmitting antenna ≤ 2.5 cm from an edge.

*Please see the LG-D105g _ ZNFD105G _ Antenna distance for further information.

13. SAR TEST DATA SUMMARY

13.1-1 Measurement Results (GSM850 Head SAR)

Frequency		Mode	Power (dBm)		Power Drift (dB)	Battery	Phantom Position	Measured SAR (mW/g)	Scaling Factor	Scaled SAR (mW/g)	Plot No.
MHz	Ch.		Tune-Up Limit	Conducted Power							
836.6	190	GSM 850	34.2	33.71	-0.042	Standard	Left Ear	0.462	1.119	0.517	-
836.6	190		34.2	33.71	-0.129	Standard	Left Tilt	0.255	1.119	0.285	-
836.6	190		34.2	33.71	-0.085	Standard	Right Ear	0.471	1.119	0.527	-
836.6	190		34.2	33.71	0.035	Standard	Right Tilt	0.260	1.119	0.291	-
836.6	190	GPRS 4Tx	30.2	29.44	-0.124	Standard	Left Ear	0.601	1.191	0.716	1
836.6	190		30.2	29.44	-0.010	Standard	Left Tilt	0.360	1.191	0.429	-
836.6	190		30.2	29.44	-0.134	Standard	Right Ear	0.577	1.191	0.687	-
836.6	190		30.2	29.44	0.156	Standard	Right Tilt	0.320	1.191	0.381	-
ANSI/ IEEE C95.1 - 1992- Safety Limit Spatial Peak Uncontrolled Exposure/ General Population							Head 1.6 W/kg (mW/g) Averaged over 1 gram				

13.1-2 Measurement Results (GSM1900 Head SAR)

Frequency		Mode	Power (dBm)		Power Drift (dB)	Battery	Phantom Position	Measured SAR (mW/g)	Scaling Factor	Scaled SAR (mW/g)	Plot No.
MHz	Ch.		Tune-Up Limit	Conducted Power							
1 880.0	661	GSM 1900	30.2	29.62	-0.151	Standard	Left Ear	0.266	1.143	0.304	-
1 880.0	661		30.2	29.62	0.106	Standard	Left Tilt	0.123	1.143	0.141	-
1 880.0	661		30.2	29.62	0.067	Standard	Right Ear	0.355	1.143	0.406	-
1 880.0	661		30.2	29.62	0.079	Standard	Right Tilt	0.145	1.143	0.166	-
1 880.0	661	GPRS 4Tx	26.2	25.21	-0.115	Standard	Left Ear	0.429	1.256	0.539	-
1 880.0	661		26.2	25.21	-0.050	Standard	Left Tilt	0.203	1.256	0.255	-
1 880.0	661		26.2	25.21	-0.049	Standard	Right Ear	0.633	1.256	0.795	2
1 880.0	661		26.2	25.21	0.046	Standard	Right Tilt	0.211	1.256	0.265	-
ANSI/ IEEE C95.1 - 1992- Safety Limit Spatial Peak Uncontrolled Exposure/ General Population							Head 1.6 W/kg (mW/g) Averaged over 1 gram				

13.1-3 Measurement Results (WCDMA850 Head SAR)

Frequency		Mode	Power (dBm)		Power Drift (dB)	Battery	Phantom Position	Measured SAR (mW/g)	Scaling Factor	Scaled SAR (mW/g)	Plot No.
MHz	Ch.		Tune-Up Limit	Conducted Power							
836.6	4183	WCDMA 850	24.2	23.87	-0.103	Standard	Left Ear	0.317	1.079	0.342	3
836.6	4183		24.2	23.87	0.129	Standard	Left Tilt	0.171	1.079	0.184	-
836.6	4183		24.2	23.87	-0.094	Standard	Right Ear	0.306	1.079	0.330	-
836.6	4183		24.2	23.87	0.058	Standard	Right Tilt	0.164	1.079	0.177	-
ANSI/ IEEE C95.1 - 1992- Safety Limit Spatial Peak Uncontrolled Exposure/ General Population							Head 1.6 W/kg (mW/g) Averaged over 1 gram				

13.1-4 Measurement Results (WCDMA1900 Head SAR)

Frequency		Mode	Power (dBm)		Power Drift (dB)	Battery	Phantom Position	Measured SAR (mW/g)	Scaling Factor	Scaled SAR (mW/g)	Plot No.
MHz	Ch.		Tune-Up Limit	Conducted Power							
1 880.0	9400	WCDMA 1900	23.2	23.04	-0.046	Standard	Left Ear	0.468	1.038	0.486	-
1 880.0	9400		23.2	23.04	0.014	Standard	Left Tilt	0.220	1.038	0.228	-
1 880.0	9400		23.2	23.04	0.027	Standard	Right Ear	0.634	1.038	0.658	4
1 880.0	9400		23.2	23.04	0.036	Standard	Right Tilt	0.242	1.038	0.251	-
ANSI/ IEEE C95.1 - 1992- Safety Limit Spatial Peak Uncontrolled Exposure/ General Population							Head 1.6 W/kg (mW/g) Averaged over 1 gram				

13.1-5 Measurement Results (DTS Head SAR)

Frequency		Mode	Power (dBm)		Power Drift (dB)	Battery	Phantom Position	Data Rate	Measured SAR (mW/g)	Scaling Factor	Scaled SAR (mW/g)	Plot No.
MHz	Ch.		Tune-Up Limit	Conducted Power								
2 462	11	802.11 b	15.5	14.50	-0.131	Standard	Left Ear	1Mbps	0.198	1.259	0.249	-
			15.5	14.50	-0.023	Standard	Left Tilt	1Mbps	0.144	1.259	0.181	-
			15.5	14.50	-0.015	Standard	Right Ear	1Mbps	0.446	1.259	0.561	5
			15.5	14.50	0.191	Standard	Right Tilt	1Mbps	0.301	1.259	0.379	-
ANSI/ IEEE C95.1 - 1992- Safety Limit Spatial Peak Uncontrolled Exposure/ General Population							Head 1.6 W/kg (mW/g) Averaged over 1 gram					

13.2-1 Measurement Results (GSM850 Hotspot SAR)

Frequency		Mode	Power (dBm)		Power Drift (dB)	Configuration	Separation Distance	Measured SAR(mW/g)	Scaling Factor	Scaled SAR(mW/g)	Plot No.
MHz	Ch.		Tune-Up Limit	Conducted Power							
824.2	128	GPRS 4Tx	30.2	29.44	0.023	Rear	1.0 cm	0.981	1.191	1.169	-
836.6	190		30.2	29.44	0.148	Rear	1.0 cm	0.992	1.191	1.182	-
848.8	251		30.2	29.54	-0.100	Rear	1.0 cm	1.05	1.164	1.222	6
836.6	190		30.2	29.44	-0.080	Front	1.0 cm	0.540	1.191	0.643	-
836.6	190		30.2	29.44	-0.152	Left	1.0 cm	0.488	1.191	0.581	-
836.6	190		30.2	29.44	0.153	Right	1.0 cm	0.359	1.191	0.428	-
836.6	190		30.2	29.44	0.055	Bottom	1.0 cm	0.138	1.191	0.164	-
ANSI/ IEEE C95.1 - 1992- Safety Limit Spatial Peak Uncontrolled Exposure/ General Population							Body 1.6 W/kg (mW/g) Averaged over 1 gram				

13. 2-2 Measurement Results (GSM1900 Hotspot SAR)

Frequency		Mode	Power (dBm)		Power Drift (dB)	Configuration	Separation Distance	Measured SAR (mW/g)	Scaling Factor	Scaled SAR (mW/g)	Plot No.
MHz	Ch.		Tune-Up Limit	Conducted Power							
1 880.0	661	GPRS 4Tx	26.2	25.21	0.001	Rear	1.0 cm	0.442	1.256	0.555	7
1 880.0	661		26.2	25.21	-0.016	Front	1.0 cm	0.292	1.256	0.367	-
1 880.0	661		26.2	25.21	0.016	Left	1.0 cm	0.026	1.256	0.033	-
1 880.0	661		26.2	25.21	-0.009	Right	1.0 cm	0.082	1.256	0.103	-
1 880.0	661		26.2	25.21	-0.003	Bottom	1.0 cm	0.211	1.256	0.265	-
ANSI/ IEEE C95.1 - 1992- Safety Limit Spatial Peak Uncontrolled Exposure/ General Population							Body 1.6 W/kg (mW/g) Averaged over 1 gram				

13. 2-3 Measurement Results (WCDMA850 Hotspot SAR)

Frequency		Mode	Power (dBm)		Power Drift (dB)	Configuration	Separation Distance	Measured SAR (mW/g)	Scaling Factor	Scaled SAR (mW/g)	Plot No.
MHz	Ch.		Tune-Up Limit	Conducted Power							
836.6	4183	WCDMA 850	24.2	23.87	0.010	Rear	1.0 cm	0.622	1.079	0.671	8
836.6	4183		24.2	23.87	-0.046	Front	1.0 cm	0.331	1.079	0.357	-
836.6	4183		24.2	23.87	-0.115	Left	1.0 cm	0.312	1.079	0.337	-
836.6	4183		24.2	23.87	-0.022	Right	1.0 cm	0.274	1.079	0.296	-
836.6	4183		24.2	23.87	0.030	Bottom	1.0 cm	0.069	1.079	0.074	-
ANSI/ IEEE C95.1 - 1992- Safety Limit Spatial Peak Uncontrolled Exposure/ General Population							Body 1.6 W/kg (mW/g) Averaged over 1 gram				

13. 2-4 Measurement Results (WCDMA1900 Hotspot SAR)

Frequency		Mode	Power (dBm)		Power Drift (dB)	Configuration	Separation Distance	Measured SAR (mW/g)	Scaling Factor	Scaled SAR (mW/g)	Plot No.
MHz	Ch.		Tune-Up Limit	Conducted Power							
1 880.0	9400	WCDMA 1900	23.2	23.04	-0.048	Rear	1.0 cm	0.388	1.038	0.403	9
1 880.0	9400		23.2	23.04	-0.156	Front	1.0 cm	0.349	1.038	0.362	-
1 880.0	9400		23.2	23.04	-0.082	Left	1.0 cm	0.050	1.038	0.052	-
1 880.0	9400		23.2	23.04	0.038	Right	1.0 cm	0.166	1.038	0.172	-
1 880.0	9400		23.2	23.04	-0.053	Bottom	1.0 cm	0.427	1.038	0.443	10
ANSI/ IEEE C95.1 - 1992- Safety Limit Spatial Peak Uncontrolled Exposure/ General Population							Body 1.6 W/kg (mW/g) Averaged over 1 gram				

13. 2-5 Measurement Results (WLAN Hotspot SAR)

Frequency		Mode	Power (dBm)		Power Drift (dB)	Configuration	Data Rate	Separation Distance	Measured SAR (mW/g)	Scaling Factor	Scaled SAR (mW/g)	Plot No.
MHz	Ch.		Tune-Up Limit	Conducted Power								
2 462	11	802.11 b	15.5	14.50	-0.115	Rear	1Mbps	1.0 cm	0.160	1.259	0.201	11
			15.5	14.50	0.170	Front	1Mbps	1.0 cm	0.088	1.259	0.111	-
			15.5	14.50	-0.180	Right	1Mbps	1.0 cm	0.029	1.259	0.037	-
			15.5	14.50	-0.032	Top	1Mbps	1.0 cm	0.053	1.259	0.067	-
ANSI/ IEEE C95.1 - 1992- Safety Limit Spatial Peak Uncontrolled Exposure/ General Population							Body 1.6 W/kg (mW/g) Averaged over 1 gram					

13.3-1 Measurement Results (DTS Body-worn SAR)

Frequency		Mode	Power (dBm)		Power Drift (dB)	Configuration	Data Rate	Separation Distance	Measured SAR (mW/g)	Scaling Factor	Scaled SAR (mW/g)	Plot No.
MHz	Ch.		Tune-Up Limit	Conducted Power								
2 462	11	802.11b	15.5	14.50	-0.115	Rear	1Mbps	1.0 cm	0.160	1.259	0.201	11
ANSI/ IEEE C95.1 - 1992- Safety Limit Spatial Peak Uncontrolled Exposure/ General Population							Body 1.6 W/kg (mW/g) Averaged over 1 gram					

13.3-2 Measurement Results (Body-worn SAR)

Frequency		Mode	Power (dBm)		Power Drift (dB)	Configuration	Separation Distance	Measured SAR (mW/g)	Scaling Factor	Scaled SAR (mW/g)	Plot No.	
MHz	Ch.		Tune-Up Limit	Conducted Power								
824.2	128	GSM850	34.2	33.71	-0.058	Rear	1.0 cm	0.765	1.119	0.856	-	
836.6	190	GSM850	34.2	33.71	-0.023	Rear	1.0 cm	0.722	1.119	0.808	-	
848.8	251	GSM850	34.2	33.75	-0.047	Rear	1.0 cm	0.798	1.109	0.885	12	
824.2	128	GPRS 4Tx	30.2	29.44	0.023	Rear	1.0 cm	0.981	1.191	1.169	-	
836.6	190	GPRS 4Tx	30.2	29.44	0.148	Rear	1.0 cm	0.992	1.191	1.182	-	
848.8	251	GPRS 4Tx	30.2	29.54	-0.100	Rear	1.0 cm	1.05	1.164	1.222	6	
1 880.0	661	GSM1900	30.2	29.62	-0.075	Rear	1.0 cm	0.297	1.143	0.339	13	
1 880.0	661	GPRS 4Tx	26.2	25.21	0.001	Rear	1.0 cm	0.442	1.256	0.555	7	
836.6	4183	WCDMA850	24.2	23.87	0.010	Rear	1.0 cm	0.622	1.079	0.671	8	
1 880.0	9400	WCDMA1900	23.2	23.04	-0.048	Rear	1.0 cm	0.388	1.038	0.403	9	
ANSI/ IEEE C95.1 - 1992- Safety Limit Spatial Peak Uncontrolled Exposure/ General Population							Body 1.6 W/kg (mW/g) Averaged over 1 gram					

13.4 SAR Test Notes

General Notes:

1. The test data reported are the worst-case SAR values according to test procedures specified in IEEE 1528-2003, FCC KDB Procedure.
2. Batteries are fully charged at the beginning of the SAR measurements. A standard battery was used for all SAR measurements.
3. Liquid tissue depth was at least 15.0 cm for all frequencies.
4. The manufacturer has confirmed that the device(s) tested have the same physical, mechanical and thermal characteristics and are within operational tolerances expected for production units.
5. SAR results were scaled to the maximum allowed power to demonstrate compliance per FCC KDB 447498 D01v05r02.
6. Device was tested using a fixed spacing for body-worn accessory testing. A separation distance of 10 mm was considered because the manufacturer has determined that there will be body-worn accessories available in the marketplace for users to support this separation distance.
7. Per FCC KDB 648474 D04v01r02, SAR was evaluated without a headset connected to the device. Since the standalone reported SAR was ≤ 1.2 W/kg, no additional SAR evaluation using a headset cable were required.

GSM/GPRS Test Notes:

1. This device supports GSM VOIP in the head and the body-worn configurations therefore GPRS was additionally evaluated for head and body-worn compliance.
2. Body-Worn accessory testing is typically associated with voice operations. Therefore, GSM voice was evaluated for body-worn SAR.
3. Justification for reduced test configurations per KDB 941225 D03v01: The source-based time-averaged output power was evaluated for all multi-slot operations. The multi-slot configuration with the highest frame averaged output power was evaluated for SAR.
4. Per FCC KDB 447498 D01v05r02, if the reported (scaled) SAR measured at the middle channel or highest output power channel for each test configuration is ≤ 0.8 W/kg then testing at the other channels is not required for such test configuration(s). When the maximum output power variation across the required test channels is 1/2 dB, instead of the middle channel, the highest output power channel must be used.
5. Justification for reduced test configurations per KDB Publication 941225 D03v01 and October 2013 TCB Workshop Notes: The source-based frame-averaged output power was evaluated for all GPRS/EDGE slot configurations. The configuration with the highest target frame averaged output power was evaluated for hotspot SAR. When the maximum frame-averaged powers are equivalent across two or more slots (within 0.25 dB), the configuration with the most number of time slots was tested.

UMTS Notes:

1. UMTS mode in Body SAR was tested under RMC 12.2 kbps with HSPA inactive per KDB 941225 D01v02. HSPA SAR was not required since the average output power of the HSPA subtests was not more than 0.25 dB higher than the RMC level and SAR was less than 1.2 W/kg.
2. Per FCC KDB 447498 D01v05r02, if the reported (scaled) SAR measured at the middle channel or highest output power channel for each test configuration is ≤ 0.8 W/kg then testing at the other channels is not required for such test configuration(s). When the maximum output power variation across the channel highest output power channel was used.

WLAN Notes:

1. Justification for reduced test configurations for WIFI channels per KDB 248227 D01v01r02 and Oct. 2012 FCC/TCB Meeting Notes for 2.4 GHz WIFI: Highest average RF output power channel for the lowest data rate was selected for SAR evaluation in 802.11b. Other IEEE 802.11 modes (including 802.11 g/n) were not investigated since the average output powers over all channels and data rates were not more than 0.25 dB higher than the tested channel in the lowest data rate of IEEE 802.11b mode.
2. Since the maximum extrapolated peak SAR of the zoom scan for the maximum output channel was ≤ 1.6 W/kg and the reported 1g averaged SAR was < 0.8 W/kg, SAR testing on other default channels was not required.

14. SAR Measurement Variability and Uncertainty

In accordance with published RF Exposure KDB procedure 865664 D01v01r03 SAR measurement 100 MHz to 6 GHz. These additional measurements are repeated after the completion of all measurements requiring the same head or body tissue-equivalent medium in a frequency band. The test device should be returned to ambient conditions (normal room temperature) with the battery fully charged before it is re-mounted on the device holder for the repeated measurement(s) to minimize any unexpected variations in the repeated results.

- 1) Repeated measurement is not required when the original highest measured SAR is < 0.80 W/kg; steps 2) through 4) do not apply.
- 2) When the original highest measured SAR is ≥ 0.80 W/kg, repeat that measurement once.
- 3) Perform a second repeated measurement only if the ratio of largest to smallest SAR for the original and first repeated measurements is > 1.20 or when the original or repeated measurement is ≥ 1.45 W/kg ($\sim 10\%$ from the 1-g SAR limit).
- 4) Perform a third repeated measurement only if the original, first or second repeated measurement is ≥ 1.5 W/kg and the ratio of largest to smallest SAR for the original, first and second repeated measurements is > 1.20 .

Frequency		Modulation	Battery	Configuration	Conducted Power (dBm)	Original SAR (mW/g)	Repeated SAR (mW/g)	Largest to Smallest SAR Ratio	Plot No.
MHz	Ch.								
848.8	251	GSM850	Standard	Rear	29.54	1.05	1.01	1.04	14

15. SAR Summation Scenario

	Position	Applicable Combination	Note
Simultaneous Transmission	Head	GSM 850 Voice + 2.4 GHz WiFi	
		GSM 1900 Voice + 2.4 GHz WiFi	
		GPRS 850 Data + 2.4 GHz WiFi	
		GPRS 1900 Data + 2.4 GHz WiFi	
		WCDMA850 Voice + 2.4 GHz WiFi	
		WCDMA1900 Voice + 2.4 GHz WiFi	
	Hotspot	GPRS 850 Data + 2.4 GHz WiFi	
		GPRS 1900 Data + 2.4 GHz WiFi	
		WCDMA850 Data + 2.4 GHz WiFi	
		WCDMA1900 Data + 2.4 GHz WiFi	
	Body-worn	GSM 850 Voice + 2.4 GHz WiFi	
		GPRS 850 Data + 2.4 GHz WiFi	
		GSM 1900 Voice + 2.4 GHz WiFi	
		GPRS 1900 Data + 2.4 GHz WiFi	
		WCDMA850 Voice + 2.4 GHz WiFi	
		WCDMA1900 Voice + 2.4 GHz WiFi	
		GSM 850 Voice + 2.4 GHz Bluetooth	
		GPRS VoIP 850 + 2.4 GHz Bluetooth	
		GSM 1900 Voice + 2.4 GHz Bluetooth	
		GPRS VoIP 1900 + 2.4 GHz Bluetooth	
WCDMA850 Voice + 2.4 GHz Bluetooth			
WCDMA1900 Voice + 2.4 GHz Bluetooth			
* BT and WLAN are not simultaneous transmission.			

15.1 Simultaneous Transmission Summation for Head

Simultaneous Transmission Summation with 2.4 GHz WIFI

Band	configuration	Scaled SAR (W/kg)	2.4 GHz WIFI Scaled SAR (W/kg)	Σ 1-g SAR (W/kg)
GSM 850	Left Cheek	0.517	0.249	0.766
	Left Tilt	0.285	0.181	0.466
	Right Cheek	0.527	0.561	1.088
	Right Tilt	0.291	0.379	0.670
GPRS 850	Left Cheek	0.716	0.249	0.965
	Left Tilt	0.429	0.181	0.610
	Right Cheek	0.687	0.561	1.248
	Right Tilt	0.381	0.379	0.760
GSM 1900	Left Cheek	0.304	0.249	0.553
	Left Tilt	0.141	0.181	0.322
	Right Cheek	0.406	0.561	0.967
	Right Tilt	0.166	0.379	0.545
GPRS 1900	Left Cheek	0.539	0.249	0.788
	Left Tilt	0.255	0.181	0.436
	Right Cheek	0.795	0.561	1.356
	Right Tilt	0.265	0.379	0.644
WCDMA 850	Left Cheek	0.342	0.249	0.591
	Left Tilt	0.184	0.181	0.365
	Right Cheek	0.330	0.561	0.891
	Right Tilt	0.177	0.379	0.556
WCDMA 1900	Left Cheek	0.486	0.249	0.735
	Left Tilt	0.228	0.181	0.409
	Right Cheek	0.658	0.561	1.219
	Right Tilt	0.251	0.379	0.630

15.2 Simultaneous Transmission Summation for Body-Worn

Simultaneous Transmission Summation with Wifi (1 cm)

Band	configuration	Scaled SAR(W/kg)	2.4 GHz WIFI Scaled SAR (W/kg)	Σ 1-g SAR (W/kg)
GSM 850	Rear	0.885	0.201	1.086
GPRS 850	Rear	1.222	0.201	1.423
GSM 1900	Rear	0.339	0.201	0.540
GPRS 1900	Rear	0.555	0.201	0.756
WCDMA850	Rear	0.671	0.201	0.872
WCDMA1900	Rear	0.403	0.201	0.604

Simultaneous Transmission Summation with Bluetooth (1 cm)

Band	configuration	Scaled SAR(W/kg)	BT SAR (W/kg)	Σ 1-g SAR (W/kg)
GSM 850	Rear	0.885	0.06	0.945
GPRS 850	Rear	1.222	0.06	1.282
GSM 1900	Rear	0.339	0.06	0.399
GPRS 1900	Rear	0.555	0.06	0.615
WCDMA850	Rear	0.671	0.06	0.731
WCDMA1900	Rear	0.403	0.06	0.463

15.3 Simultaneous Transmission Summation for Hotspot

Simultaneous Transmission Summation with 2.4 GHz WIFI (1 cm)

Band	configuration	Scaled SAR (W/kg)	2.4 GHz WIFI Scaled SAR (W/kg)	Σ 1-g SAR (W/kg)
GSM 850	Rear	1.222	0.201	1.423
	Front	0.643	0.111	0.754
	Left	0.581		0.581
	Right	0.428	0.037	0.465
	Bottom	0.164		0.164
	Top		0.067	0.067
GSM 1900	Rear	0.555	0.201	0.756
	Front	0.367	0.111	0.478
	Left	0.033		0.033
	Right	0.103	0.037	0.140
	Bottom	0.265		0.265
	Top		0.067	0.067
WCDMA 850	Rear	0.671	0.201	0.872
	Front	0.357	0.111	0.468
	Left	0.337		0.337
	Right	0.296	0.037	0.333
	Bottom	0.074		0.074
	Top		0.067	0.067
WCDMA 1900	Rear	0.403	0.201	0.604
	Front	0.362	0.111	0.473
	Left	0.052		0.052
	Right	0.172	0.037	0.209
	Bottom	0.443		0.443
	Top		0.067	0.067

15.4 Simultaneous Transmission Conclusion

The above numerical summed SAR results for all the worst-case simultaneous transmission conditions were below the SAR limit. Therefore, the above analysis is sufficient to determine that simultaneous transmission cases will not exceed the SAR limit. And therefore no measured volumetric simultaneous SAR summation is required per FCC KDB Publication 447498 D01v05r02.

16. CONCLUSION

The SAR measurement indicates that the EUT complies with the RF radiation exposure limits of the ANSI/IEEE C95.1 1992.

These measurements are taken to simulate the RF effects exposure under worst-case conditions. Precise laboratory measures were taken to assure repeatability of the tests.

17. REFERENCES

- [1] Federal Communications Commission, OET Bulletin 65 (Edition 97-01), Supplement C (Edition 01-01), Evaluating Compliance with FCC Guidelines for Human Exposure to Radio frequency Electromagnetic Fields, July 2001.
- [2] IEEE Standards Coordinating Committee 34 – IEEE Std. 1528-2003, IEEE Recommended Practice for Determining the Peak Spatial-Average Specific Absorption Rate (SAR) in the Human Body from Wireless Communications Devices.
- [3] Federal Communications Commission, ET Docket 93-62, Guidelines for Evaluating the Environmental Effects of Radio frequency Radiation, Aug. 1996.
- [4] ANSI/IEEE C95.1 - 1991, American National Standard safety levels with respect to human exposure to radio frequency electromagnetic fields, 300 kHz to 100 GHz, New York: IEEE, Aug. 1992
- [5] ANSI/IEEE C95.3 - 1991, IEEE Recommended Practice for the Measurement of Potentially Hazardous Electromagnetic Fields - RF and Microwave, New York: IEEE, 1992.
- [6] NCRP, National Council on Radiation Protection and Measurements, Biological Effects and Exposure Criteria for Radio Frequency Electromagnetic Fields, NCRP Report No. 86, 1986. Reprinted Feb. 1995.
- [7] T. Schmid, O. Egger, N. Kuster, Automated E-field scanning system for dosimetric assessments, IEEE Transaction on Microwave Theory and Techniques, vol. 44, Jan. 1996, pp. 105-113.
- [8] K. Pokovic, T. Schmid, N. Kuster, Robust setup for precise calibration of E-field probes in tissue simulating liquids at mobile communications frequencies, ICECOM97, Oct. 1997, pp. 120-124.
- [9] K. Poković, T. Schmid, and N. Kuster, E-field Probe with improved isotropy in brain simulating liquids, Proceedings of the ELMAR, Zadar, Croatia, June 23-25, 1996, pp. 172-175.
- [10] Schmid & Partner Engineering AG, Application Note: Data Storage and Evaluation, June 1998, p2.
- [11] V. Hombach, K. Meier, M. Burkhardt, E. Kuhn, N. Kuster, The Dependence of EM Energy Absorption upon Human Head Modeling at 900 MHz, IEEE Transaction on Microwave Theory and Techniques, vol. 44 no. 10, Oct. 1996, pp. 1865-1873.
- [12] N. Kuster and Q. Balzano, Energy absorption mechanism by biological bodies in the near field of dipole antennas above 300 MHz, IEEE Transaction on Vehicular Technology, vol. 41, no. 1, Feb. 1992, pp. 17-23.
- [13] G. Hartsgrove, A. Kraszewski, A. Surowiec, Simulated Biological Materials for Electromagnetic Radiation Absorption Studies, University of Ottawa, Bioelectromagnetics, Canada: 1987, pp. 29-36.
- [14] Q. Balzano, O. Garay, T. Manning Jr., Electromagnetic Energy Exposure of Simulated Users of Portable Cellular Telephones, IEEE Transactions on Vehicular Technology, vol. 44, no.3, Aug. 1995.
- [15] W. Gander, Computer mathematic, Birkhaeuser, Basel, 1992.
- [16] W.H. Press, S.A. Teukolsky, W.T. Vetterling, and B.P. Flannery, Numerical Recipes in C, The Art of Scientific Computing, Second edition, Cambridge University Press, 1992.
- [17] Federal Communications Commission, OET Bulletin 65, Evaluating Compliance with FCC Guidelines for Human Exposure to Radiofrequency Electromagnetic Fields. Supplement C, Dec. 1997.
- [18] N. Kuster, R. Kastle, T. Schmid, Dosimetric evaluation of mobile communications equipment with known precision, IEEE Transaction on Communications, vol. E80-B, no. 5, May 1997, pp. 645-652.
- [19] CENELEC CLC/SC111B, European Prestandard (prENV 50166-2), Human Exposure to Electromagnetic Fields High-frequency: 10 kHz-300 GHz, Jan. 1995.
- [20] Prof. Dr. Niels Kuster, ETH, Eidgenössische Technische Hochschule Zürich, Dosimetric Evaluation of the Cellular Phone.
- [21] SAR Evaluation of Handsets with Multiple Transmitters and Antennas #648474.
- [22] SAR Measurement Procedure for 802.11 a/b/g Transmitters #KDB 248227.

Attachment 1. – SAR Test Plots

Test Laboratory: HCT CO., LTD
EUT Type: Cellular/PCS GSM/GPRS/EDGE Rx/WCDMA/HSDPA/HSUPA Phone with Bluetooth and WLAN
Liquid Temperature: 20.0 °C
Ambient Temperature: 20.2 °C
Test Date: Jun. 09, 2014
Plot No. 1

DUT: LG-D105G; Type: Bar; Serial: #1

Communication System: GSM 850; Frequency: 836.6 MHz; Duty Cycle: 1:2.075
Medium parameters used (interpolated): $f = 836.6$ MHz; $\sigma = 0.878$ mho/m; $\epsilon_r = 42.2$; $\rho = 1000$ kg/m³
Phantom section: Left Section ; Measurement SW: DASY4, V4.7 Build 80; Postprocessing SW: SEMCAD, V1.8 Build 186

DASY4 Configuration:

- Probe: EX3DV4 - SN3903; ConvF(9.85, 9.85, 9.85); Calibrated: 2014-03-28
- Sensor-Surface: 2mm (Mechanical Surface Detection)
- Electronics: DAE3 Sn466; Calibrated: 2014-02-27
- Phantom: SAM 1800/1900 MHz; Type: SAM

GSM850 left touch 190ch GPRS 4TX/Area Scan (61x91x1): Measurement grid: dx=15mm, dy=15mm
Maximum value of SAR (interpolated) = 0.636 mW/g

GSM850 left touch 190ch GPRS 4TX/Zoom Scan (5x5x7)/Cube 0: Measurement grid: dx=8mm, dy=8mm, dz=5mm

Reference Value = 7.81 V/m; Power Drift = -0.124 dB

Peak SAR (extrapolated) = 0.803 W/kg

SAR(1 g) = 0.601 mW/g; SAR(10 g) = 0.430 mW/g

Maximum value of SAR (measured) = 0.639 mW/g

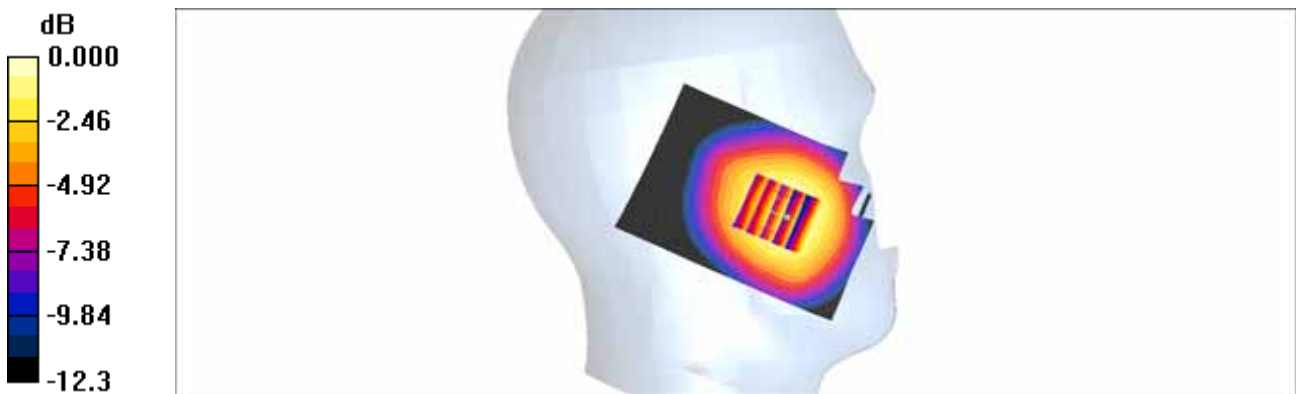

0 dB = 0.639mW/g

Test Laboratory: HCT CO., LTD
 EUT Type: Cellular/PCS GSM/GPRS/EDGE Rx/WCDMA/HSDPA/HSUPA Phone with Bluetooth and WLAN
 Liquid Temperature: 19.8 °C
 Ambient Temperature: 20.0 °C
 Test Date: Jun. 11, 2014
 Plot No. 2

DUT: LG-D105G; Type: Bar; Serial: #1

Communication System: GSM 1900; Frequency: 1880 MHz; Duty Cycle: 1:2.075
 Medium parameters used: $f = 1880 \text{ MHz}$; $\sigma = 1.42 \text{ mho/m}$; $\epsilon_r = 38.9$; $\rho = 1000 \text{ kg/m}^3$
 Phantom section: Right Section ; Measurement SW: DASY4, V4.7 Build 80; Postprocessing SW: SEMCAD, V1.8 Build 186

DASY4 Configuration:

- Probe: ET3DV6 - SN1609; ConvF(5.28, 5.28, 5.28); Calibrated: 2013-09-23
- Sensor-Surface: 4mm (Mechanical Surface Detection)
- Electronics: DAE4 Sn652; Calibrated: 2014-03-26
- Phantom: 1800/1900 Phantom; Type: SAM

GSM1900 right touch 661ch GPRS 4Tx/Area Scan (61x91x1): Measurement grid: $dx=15\text{mm}$, $dy=15\text{mm}$
 Maximum value of SAR (interpolated) = 0.743 mW/g

GSM1900 right touch 661ch GPRS 4Tx/Zoom Scan (5x5x7)/Cube 0: Measurement grid: $dx=8\text{mm}$, $dy=8\text{mm}$, $dz=5\text{mm}$

Reference Value = 8.49 V/m; Power Drift = -0.049 dB

Peak SAR (extrapolated) = 0.918 W/kg

SAR(1 g) = 0.633 mW/g; SAR(10 g) = 0.374 mW/g

Maximum value of SAR (measured) = 0.679 mW/g

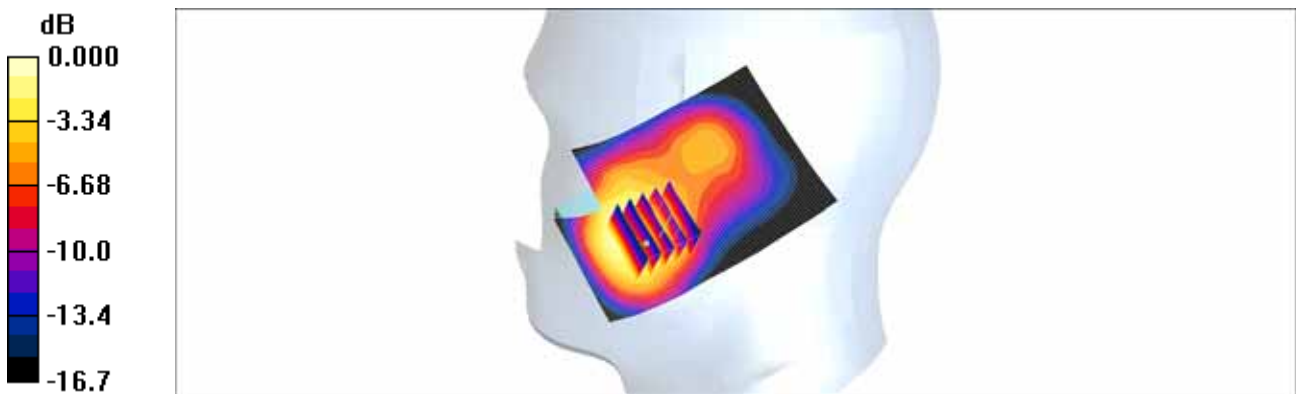

0 dB = 0.679mW/g

Test Laboratory: HCT CO., LTD
EUT Type: Cellular/PCS GSM/GPRS/EDGE Rx/WCDMA/HSDPA/HSUPA Phone with Bluetooth and WLAN
Liquid Temperature: 20.0 °C
Ambient Temperature: 20.2 °C
Test Date: Jun. 09, 2014
Plot No. 3

DUT: LG-D105G; Type: Bar; Serial: #1

Communication System: WCDMA850; Frequency: 836.6 MHz; Duty Cycle: 1:1
Medium parameters used (interpolated): $f = 836.6$ MHz; $\sigma = 0.878$ mho/m; $\epsilon_r = 42.2$; $\rho = 1000$ kg/m³
Phantom section: Left Section ; Measurement SW: DASY4, V4.7 Build 80; Postprocessing SW: SEMCAD, V1.8 Build 186

DASY4 Configuration:

- Probe: EX3DV4 - SN3903; ConvF(9.85, 9.85, 9.85); Calibrated: 2014-03-28
- Sensor-Surface: 2mm (Mechanical Surface Detection)
- Electronics: DAE3 Sn466; Calibrated: 2014-02-27
- Phantom: SAM 1800/1900 MHz; Type: SAM

WCDMA850 left touch 4183ch/Area Scan (61x91x1): Measurement grid: dx=15mm, dy=15mm
Maximum value of SAR (interpolated) = 0.337 mW/g

WCDMA850 left touch 4183ch/Zoom Scan (5x5x7)/Cube 0: Measurement grid: dx=8mm, dy=8mm, dz=5mm

Reference Value = 6.68 V/m; Power Drift = -0.103 dB

Peak SAR (extrapolated) = 0.419 W/kg

SAR(1 g) = 0.317 mW/g; SAR(10 g) = 0.226 mW/g

Maximum value of SAR (measured) = 0.337 mW/g

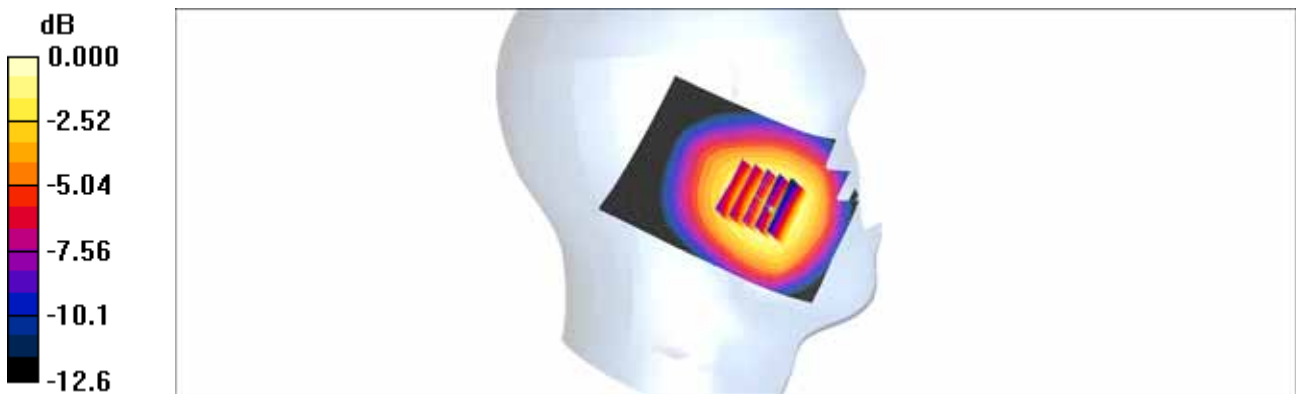

0 dB = 0.337mW/g

Test Laboratory: HCT CO., LTD
EUT Type: Cellular/PCS GSM/GPRS/EDGE Rx/WCDMA/HSDPA/HSUPA Phone with Bluetooth and WLAN
Liquid Temperature: 19.8 °C
Ambient Temperature: 20.0 °C
Test Date: Jun. 11, 2014
Plot No. 4

DUT: LG-D105G; Type: Bar; Serial: #1

Communication System: WCDMA1900; Frequency: 1880 MHz; Duty Cycle: 1:1
Medium parameters used: $f = 1880 \text{ MHz}$; $\sigma = 1.42 \text{ mho/m}$; $\epsilon_r = 38.9$; $\rho = 1000 \text{ kg/m}^3$
Phantom section: Right Section ; Measurement SW: DASY4, V4.7 Build 80; Postprocessing SW: SEMCAD, V1.8 Build 186

DASY4 Configuration:

- Probe: ET3DV6 - SN1609; ConvF(5.28, 5.28, 5.28); Calibrated: 2013-09-23
- Sensor-Surface: 4mm (Mechanical Surface Detection)
- Electronics: DAE4 Sn652; Calibrated: 2014-03-26
- Phantom: 1800/1900 Phantom; Type: SAM

WCDMA1900 right touch 9400ch/Area Scan (61x91x1): Measurement grid: dx=15mm, dy=15mm
Maximum value of SAR (interpolated) = 0.754 mW/g

WCDMA1900 right touch 9400ch/Zoom Scan (5x5x7)/Cube 0: Measurement grid: dx=8mm, dy=8mm, dz=5mm

Reference Value = 8.28 V/m; Power Drift = 0.027 dB

Peak SAR (extrapolated) = 0.895 W/kg

SAR(1 g) = 0.634 mW/g; SAR(10 g) = 0.375 mW/g

Maximum value of SAR (measured) = 0.717 mW/g

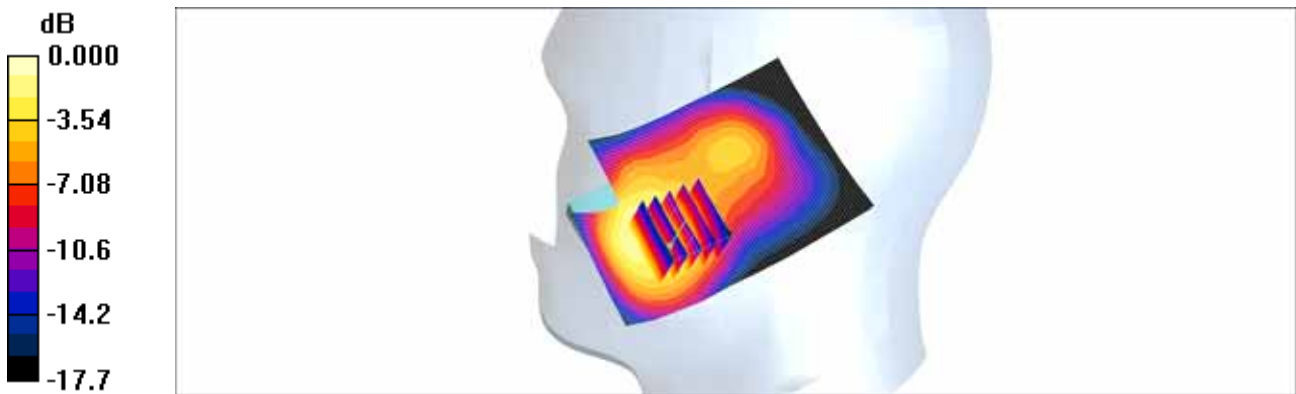

Test Laboratory: HCT CO., LTD
EUT Type: Cellular/PCS GSM/GPRS/EDGE Rx/WCDMA/HSDPA/HSUPA Phone with Bluetooth and WLAN
Liquid Temperature: 20.1 °C
Ambient Temperature: 20.3 °C
Test Date: Jun. 12, 2014
Plot No. 5

DUT: LG-D105G; Type: Bar; Serial: #1

Communication System: 2450MHz FCC; Frequency: 2462 MHz;Duty Cycle: 1:1
Medium parameters used (interpolated): $f = 2462$ MHz; $\sigma = 1.85$ mho/m; $\epsilon_r = 40.1$; $\rho = 1000$ kg/m³
Phantom section: Right Section ; Measurement SW: DASY4, V4.7 Build 80; Postprocessing SW: SEMCAD, V1.8 Build 186

DASY4 Configuration:

- Probe: EX3DV4 - SN3903; ConvF(7.36, 7.36, 7.36); Calibrated: 2014-03-28
- Sensor-Surface: 2mm (Mechanical Surface Detection)
- Electronics: DAE3 Sn466; Calibrated: 2014-02-27
- Phantom: SAM 835/900 MHz; Type: SAM

802.11b Right Touch 11ch 1Mbps/Area Scan (71x111x1): Measurement grid: dx=12mm, dy=12mm
Maximum value of SAR (interpolated) = 0.552 mW/g

802.11b Right Touch 11ch 1Mbps/Zoom Scan (7x7x7)/Cube 0: Measurement grid: dx=5mm, dy=5mm, dz=5mm

Reference Value = 9.07 V/m; Power Drift = -0.015 dB
Peak SAR (extrapolated) = 1.07 W/kg

SAR(1 g) = 0.446 mW/g; SAR(10 g) = 0.214 mW/g
Maximum value of SAR (measured) = 0.499 mW/g

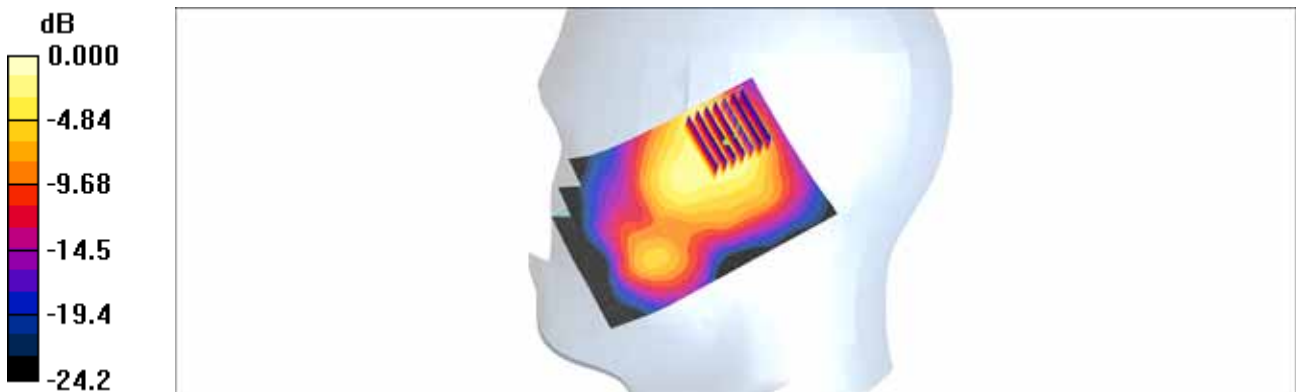

0 dB = 0.499mW/g

Test Laboratory: HCT CO., LTD
 EUT Type: Cellular/PCS GSM/GPRS/EDGE Rx/WCDMA/HSDPA/HSUPA Phone with Bluetooth and WLAN
 Liquid Temperature: 19.6 °C
 Ambient Temperature: 19.8 °C
 Test Date: Jun. 10, 2014
 Plot No. 6

DUT: LG-D105G; Type: Bar; Serial: #1

Communication System: GSM 850; Frequency: 848.8 MHz; Duty Cycle: 1:2.075
 Medium parameters used (interpolated): $f = 848.8 \text{ MHz}$; $\sigma = 0.992 \text{ mho/m}$; $\epsilon_r = 56.7$; $\rho = 1000 \text{ kg/m}^3$
 Phantom section: Center Section ; Measurement SW: DASY4, V4.7 Build 80; Postprocessing SW: SEMCAD, V1.8 Build 186

DASY4 Configuration:

- Probe: EX3DV4 - SN3903; ConvF(9.74, 9.74, 9.74); Calibrated: 2014-03-28
- Sensor-Surface: 2mm (Mechanical Surface Detection)
- Electronics: DAE3 Sn466; Calibrated: 2014-02-27
- Phantom: Triple Flat Phantom 5.1C_20120905; Type: QD 000 P51 CA

GSM850 Body Rear 251ch 4Tx/Area Scan (61x91x1): Measurement grid: dx=15mm, dy=15mm
 Maximum value of SAR (interpolated) = 1.15 mW/g

GSM850 Body Rear 251ch 4Tx/Zoom Scan (5x5x7)/Cube 0: Measurement grid: dx=8mm, dy=8mm, dz=5mm
 Reference Value = 15.6 V/m; Power Drift = -0.100 dB
 Peak SAR (extrapolated) = 1.40 W/kg
SAR(1 g) = 1.05 mW/g; SAR(10 g) = 0.736 mW/g
 Maximum value of SAR (measured) = 1.12 mW/g

GSM850 Body Rear 251ch 4Tx/Zoom Scan (5x5x7)/Cube 1: Measurement grid: dx=8mm, dy=8mm, dz=5mm
 Reference Value = 15.6 V/m; Power Drift = -0.100 dB
 Peak SAR (extrapolated) = 1.35 W/kg
SAR(1 g) = 0.904 mW/g; SAR(10 g) = 0.580 mW/g
 Maximum value of SAR (measured) = 1.03 mW/g

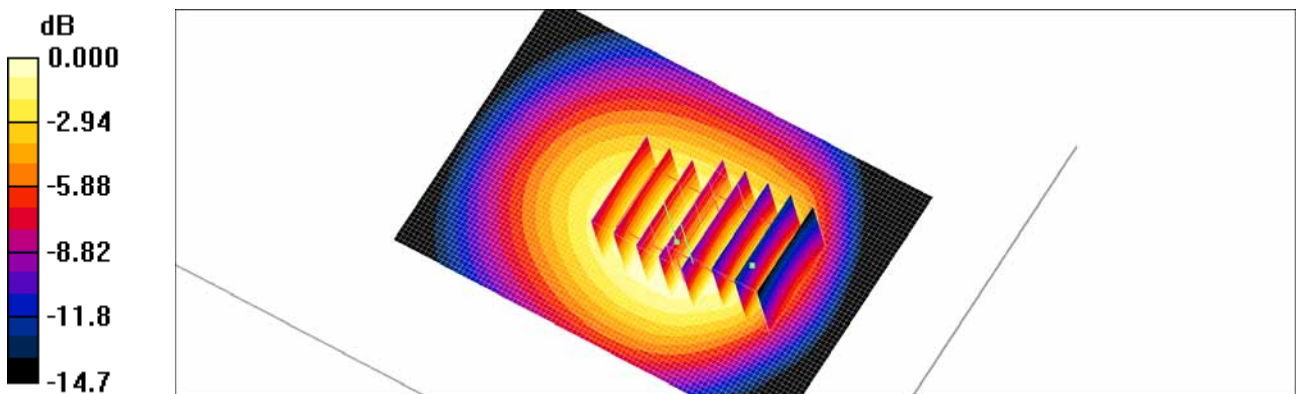

0 dB = 1.03mW/g

Test Laboratory: HCT CO., LTD
EUT Type: Cellular/PCS GSM/GPRS/EDGE Rx/WCDMA/HSDPA/HSUPA Phone with Bluetooth and WLAN
Liquid Temperature: 19.8 °C
Ambient Temperature: 20.0 °C
Test Date: Jun. 11, 2014
Plot No. 7

DUT: LG-D105G; Type: Bar; Serial: #1

Communication System: GSM 1900; Frequency: 1880 MHz; Duty Cycle: 1:2.075
Medium parameters used: $f = 1880 \text{ MHz}$; $\sigma = 1.48 \text{ mho/m}$; $\epsilon_r = 52.4$; $\rho = 1000 \text{ kg/m}^3$
Phantom section: Center Section ; Measurement SW: DASY4, V4.7 Build 80; Postprocessing SW: SEMCAD, V1.8 Build 186

DASY4 Configuration:

- Probe: ET3DV6 - SN1609; ConvF(4.69, 4.69, 4.69); Calibrated: 2013-09-23
- Sensor-Surface: 4mm (Mechanical Surface Detection)
- Electronics: DAE4 Sn652; Calibrated: 2014-03-26
- Phantom: Triple Flat Phantom 5.1C; Type: QD 000 P51 CA

GSM1900 Body Rear 661ch GPRS 4Tx/Area Scan (61x91x1): Measurement grid: $dx=15\text{mm}$, $dy=15\text{mm}$
Maximum value of SAR (interpolated) = 0.509 mW/g

GSM1900 Body Rear 661ch GPRS 4Tx/Zoom Scan (5x5x7)/Cube 0: Measurement grid: $dx=8\text{mm}$, $dy=8\text{mm}$, $dz=5\text{mm}$

Reference Value = 7.28 V/m; Power Drift = 0.001 dB

Peak SAR (extrapolated) = 0.734 W/kg

SAR(1 g) = 0.442 mW/g; SAR(10 g) = 0.245 mW/g

Maximum value of SAR (measured) = 0.497 mW/g

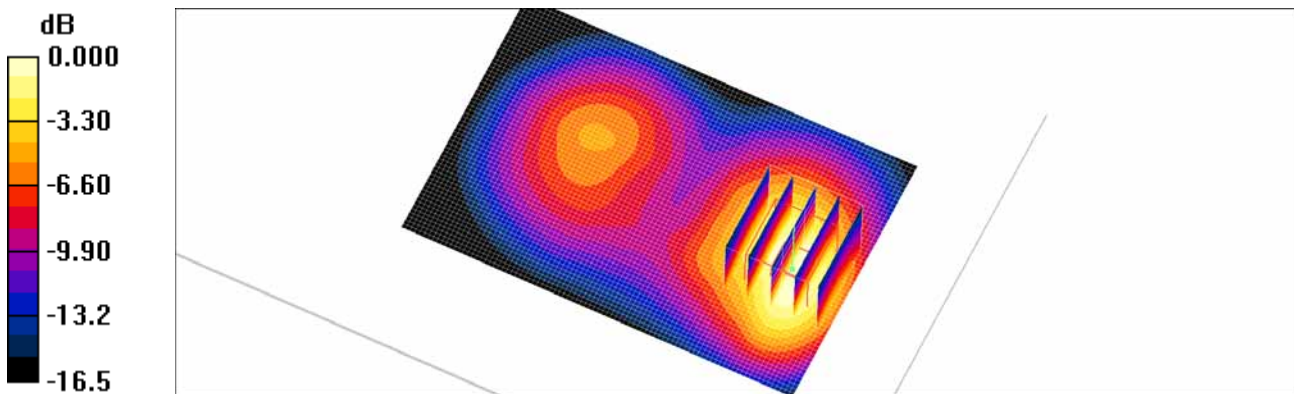

0 dB = 0.497mW/g

Test Laboratory: HCT CO., LTD
EUT Type: Cellular/PCS GSM/GPRS/EDGE Rx/WCDMA/HSDPA/HSUPA Phone with Bluetooth and WLAN
Liquid Temperature: 19.6 °C
Ambient Temperature: 19.8 °C
Test Date: Jun. 10, 2014
Plot No. 8

DUT: LG-D105G; Type: Bar; Serial: #1

Communication System: WCDMA850; Frequency: 836.6 MHz; Duty Cycle: 1:1
Medium parameters used (interpolated): $f = 836.6 \text{ MHz}$; $\sigma = 0.981 \text{ mho/m}$; $\epsilon_r = 56.9$; $\rho = 1000 \text{ kg/m}^3$
Phantom section: Center Section ; Measurement SW: DASY4, V4.7 Build 80; Postprocessing SW: SEMCAD, V1.8 Build 186

DASY4 Configuration:

- Probe: EX3DV4 - SN3903; ConvF(9.74, 9.74, 9.74); Calibrated: 2014-03-28
- Sensor-Surface: 2mm (Mechanical Surface Detection)
- Electronics: DAE3 Sn466; Calibrated: 2014-02-27
- Phantom: Triple Flat Phantom 5.1C_20120905; Type: QD 000 P51 CA

WCDMA850 Body Rear 4183ch/Area Scan (61x91x1): Measurement grid: dx=15mm, dy=15mm
Maximum value of SAR (interpolated) = 0.661 mW/g

WCDMA850 Body Rear 4183ch/Zoom Scan (5x5x7)/Cube 0: Measurement grid: dx=8mm, dy=8mm, dz=5mm

Reference Value = 5.76 V/m; Power Drift = 0.010 dB

Peak SAR (extrapolated) = 0.836 W/kg

SAR(1 g) = 0.622 mW/g; SAR(10 g) = 0.443 mW/g

Maximum value of SAR (measured) = 0.660 mW/g

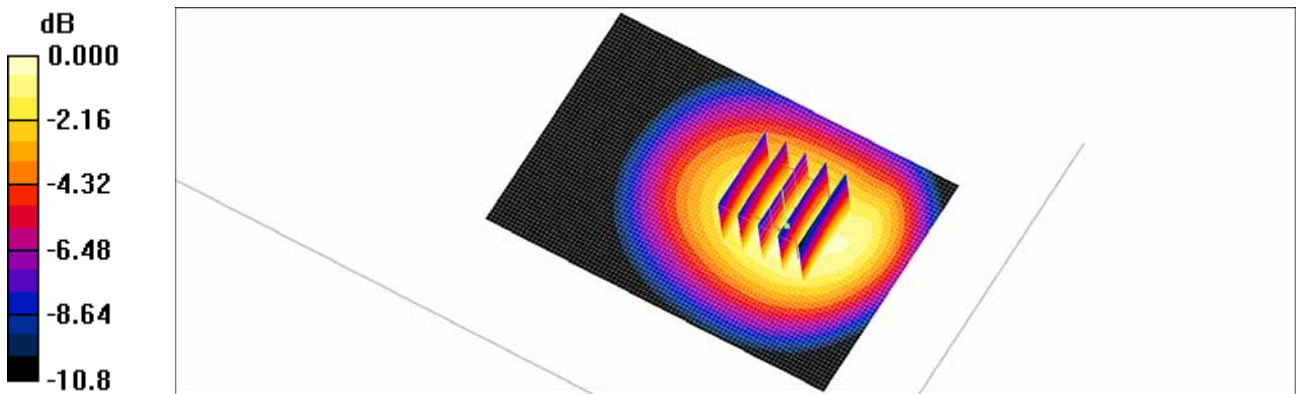

0 dB = 0.660mW/g

Test Laboratory: HCT CO., LTD
 EUT Type: Cellular/PCS GSM/GPRS/EDGE Rx/WCDMA/HSDPA/HSUPA Phone with Bluetooth and WLAN
 Liquid Temperature: 19.8 °C
 Ambient Temperature: 20.0 °C
 Test Date: Jun. 11, 2014
 Plot No. 9

DUT: LG-D105G; Type: Bar; Serial: #1

Communication System: WCDMA1900; Frequency: 1880 MHz; Duty Cycle: 1:1
 Medium parameters used: $f = 1880 \text{ MHz}$; $\sigma = 1.48 \text{ mho/m}$; $\epsilon_r = 52.4$; $\rho = 1000 \text{ kg/m}^3$
 Phantom section: Center Section ; Measurement SW: DASY4, V4.7 Build 80; Postprocessing SW: SEMCAD, V1.8 Build 186

DASY4 Configuration:

- Probe: ET3DV6 - SN1609; ConvF(4.69, 4.69, 4.69); Calibrated: 2013-09-23
- Sensor-Surface: 4mm (Mechanical Surface Detection)
- Electronics: DAE4 Sn652; Calibrated: 2014-03-26
- Phantom: Triple Flat Phantom 5.1C; Type: QD 000 P51 CA

WCDMA1900 Body Rear 9400ch/Area Scan (61x91x1): Measurement grid: dx=15mm, dy=15mm
 Maximum value of SAR (interpolated) = 0.443 mW/g

WCDMA1900 Body Rear 9400ch/Zoom Scan (5x5x7)/Cube 0: Measurement grid: dx=8mm, dy=8mm, dz=5mm

Reference Value = 10.9 V/m; Power Drift = -0.048 dB

Peak SAR (extrapolated) = 0.628 W/kg

SAR(1 g) = 0.388 mW/g; SAR(10 g) = 0.222 mW/g

Maximum value of SAR (measured) = 0.430 mW/g

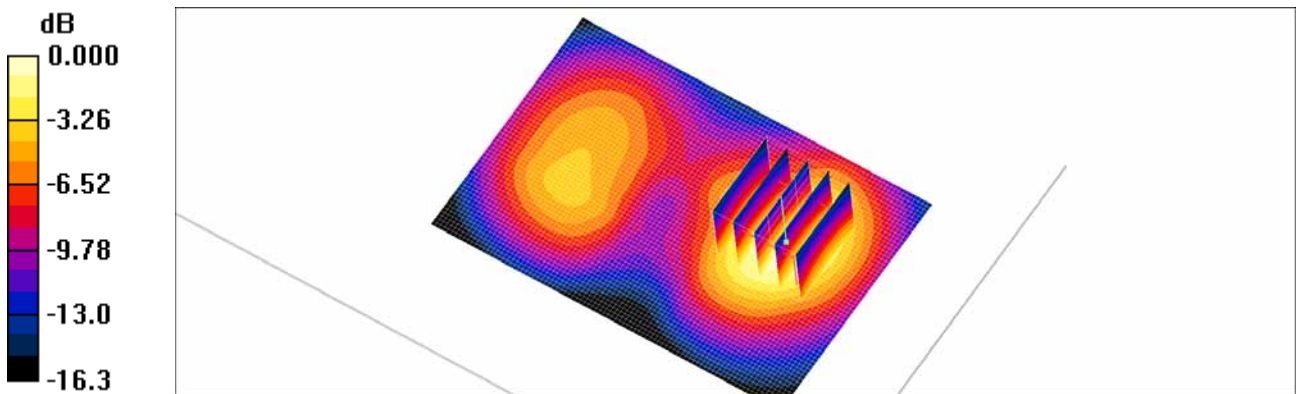

0 dB = 0.430mW/g

Test Laboratory: HCT CO., LTD
EUT Type: Cellular/PCS GSM/GPRS/EDGE Rx/WCDMA/HSDPA/HSUPA Phone with Bluetooth and WLAN
Liquid Temperature: 19.8 °C
Ambient Temperature: 20.0 °C
Test Date: Jun. 11, 2014
Plot No. 10

DUT: LG-D105G; Type: Bar; Serial: #1

Communication System: WCDMA1900; Frequency: 1880 MHz; Duty Cycle: 1:1
Medium parameters used: $f = 1880 \text{ MHz}$; $\sigma = 1.48 \text{ mho/m}$; $\epsilon_r = 52.4$; $\rho = 1000 \text{ kg/m}^3$
Phantom section: Center Section ; Measurement SW: DASY4, V4.7 Build 80; Postprocessing SW: SEMCAD, V1.8 Build 186

DASY4 Configuration:

- Probe: ET3DV6 - SN1609; ConvF(4.69, 4.69, 4.69); Calibrated: 2013-09-23
- Sensor-Surface: 4mm (Mechanical Surface Detection)
- Electronics: DAE4 Sn652; Calibrated: 2014-03-26
- Phantom: Triple Flat Phantom 5.1C; Type: QD 000 P51 CA

WCDMA1900 Body Bottom 9400ch/Area Scan (61x51x1): Measurement grid: dx=15mm, dy=15mm
Maximum value of SAR (interpolated) = 0.530 mW/g

WCDMA1900 Body Bottom 9400ch/Zoom Scan (5x5x7)/Cube 0: Measurement grid: dx=8mm, dy=8mm, dz=5mm

Reference Value = 16.9 V/m; Power Drift = -0.053 dB

Peak SAR (extrapolated) = 0.705 W/kg

SAR(1 g) = 0.427 mW/g; SAR(10 g) = 0.236 mW/g

Maximum value of SAR (measured) = 0.478 mW/g

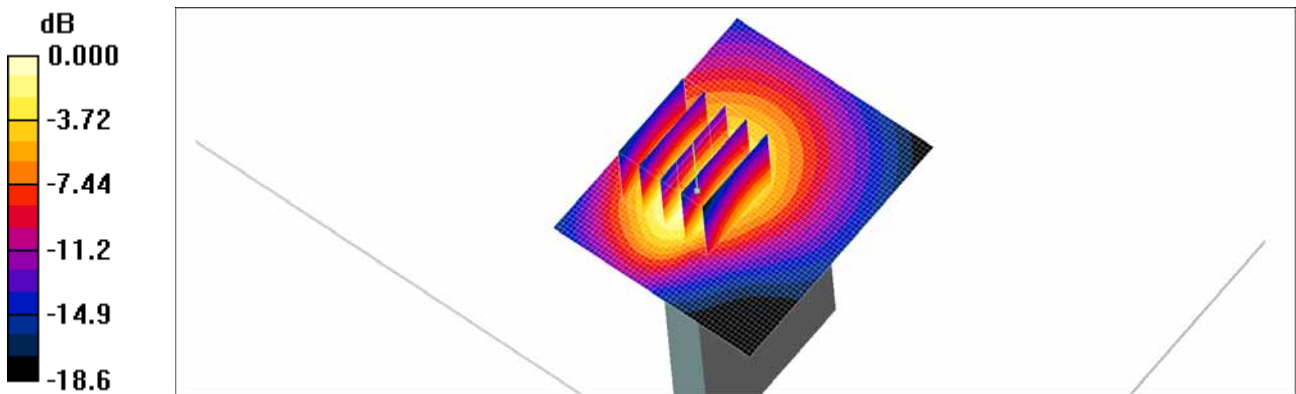

0 dB = 0.478mW/g

Test Laboratory: HCT CO., LTD
EUT Type: Cellular/PCS GSM/GPRS/EDGE Rx/WCDMA/HSDPA/HSUPA Phone with Bluetooth and WLAN
Liquid Temperature: 20.1 °C
Ambient Temperature: 20.3 °C
Test Date: Jun. 12, 2014
Plot No. 11

DUT: LG-D105G; Type: Bar; Serial: #1

Communication System: 2450MHz FCC; Frequency: 2462 MHz;Duty Cycle: 1:1
Medium parameters used (interpolated): $f = 2462$ MHz; $\sigma = 1.98$ mho/m; $\epsilon_r = 52.3$; $\rho = 1000$ kg/m³
Phantom section: Center Section ; Measurement SW: DASY4, V4.7 Build 80; Postprocessing SW: SEMCAD, V1.8 Build 186

DASY4 Configuration:

- Probe: EX3DV4 - SN3903; ConvF(7.2, 7.2, 7.2); Calibrated: 2014-03-28
- Sensor-Surface: 2mm (Mechanical Surface Detection)
- Electronics: DAE3 Sn466; Calibrated: 2014-02-27
- Phantom: Triple Flat Phantom 5.1C_20120905; Type: QD 000 P51 CA

802.11b Body Rear 11ch 1Mbps/Area Scan (71x111x1): Measurement grid: dx=12mm, dy=12mm
Maximum value of SAR (interpolated) = 0.177 mW/g

802.11b Body Rear 11ch 1Mbps/Zoom Scan (7x7x7)/Cube 0: Measurement grid: dx=5mm, dy=5mm, dz=5mm

Reference Value = 7.53 V/m; Power Drift = -0.115 dB

Peak SAR (extrapolated) = 0.272 W/kg

SAR(1 g) = 0.160 mW/g; SAR(10 g) = 0.096 mW/g

Maximum value of SAR (measured) = 0.172 mW/g

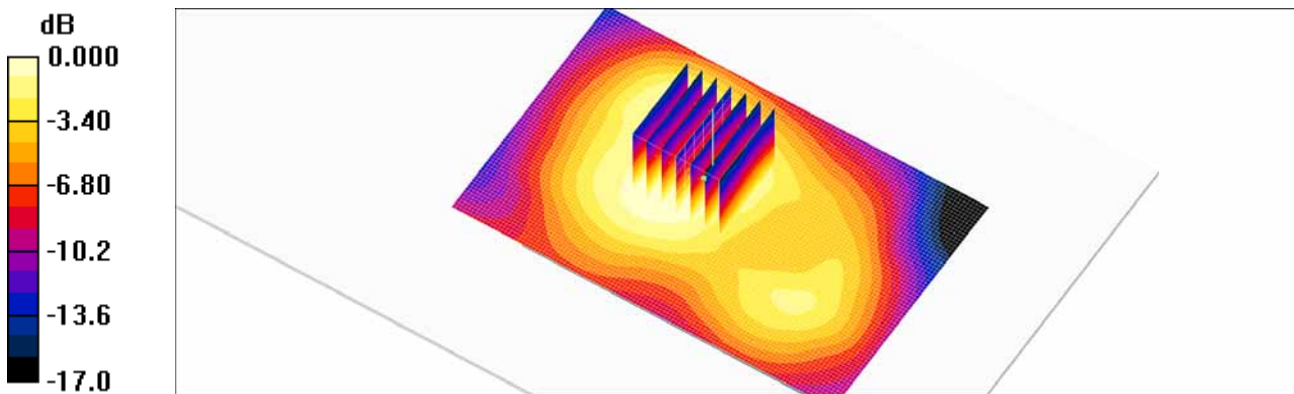

0 dB = 0.172mW/g

Test Laboratory: HCT CO., LTD
EUT Type: Cellular/PCS GSM/GPRS/EDGE Rx/WCDMA/HSDPA/HSUPA Phone with Bluetooth and WLAN
Liquid Temperature: 19.6 °C
Ambient Temperature: 19.8 °C
Test Date: Jun. 10, 2014
Plot No. 12

DUT: LG-D105G; Type: Bar; Serial: #1

Communication System: GSM 850; Frequency: 848.8 MHz; Duty Cycle: 1:8.3
Medium parameters used (interpolated): $f = 848.8 \text{ MHz}$; $\sigma = 0.992 \text{ mho/m}$; $\epsilon_r = 56.7$; $\rho = 1000 \text{ kg/m}^3$
Phantom section: Center Section ; Measurement SW: DASY4, V4.7 Build 80; Postprocessing SW: SEMCAD, V1.8 Build 186

DASY4 Configuration:

- Probe: EX3DV4 - SN3903; ConvF(9.74, 9.74, 9.74); Calibrated: 2014-03-28
- Sensor-Surface: 2mm (Mechanical Surface Detection)
- Electronics: DAE3 Sn466; Calibrated: 2014-02-27
- Phantom: Triple Flat Phantom 5.1C_20120905; Type: QD 000 P51 CA

GSM850 Body Rear 251ch Body worn/Area Scan (61x91x1): Measurement grid: $dx=15\text{mm}$, $dy=15\text{mm}$
Maximum value of SAR (interpolated) = 0.839 mW/g

GSM850 Body Rear 251ch Body worn/Zoom Scan (5x5x7)/Cube 0: Measurement grid: $dx=8\text{mm}$, $dy=8\text{mm}$, $dz=5\text{mm}$

Reference Value = 10.4 V/m; Power Drift = -0.047 dB

Peak SAR (extrapolated) = 1.07 W/kg

SAR(1 g) = 0.798 mW/g; SAR(10 g) = 0.566 mW/g

Maximum value of SAR (measured) = 0.846 mW/g

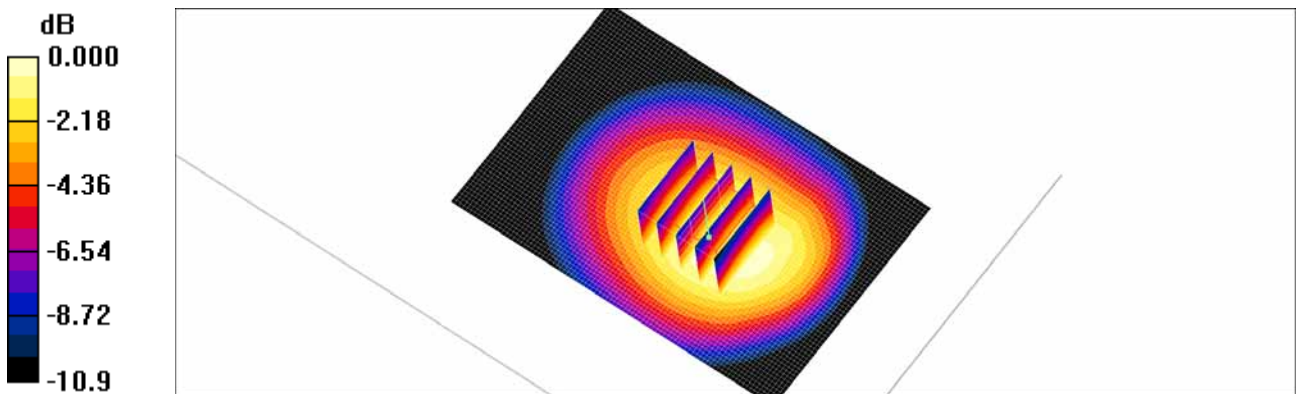

0 dB = 0.846mW/g

Test Laboratory: HCT CO., LTD
 EUT Type: Cellular/PCS GSM/GPRS/EDGE Rx/WCDMA/HSDPA/HSUPA Phone with Bluetooth and WLAN
 Liquid Temperature: 19.8 °C
 Ambient Temperature: 20.0 °C
 Test Date: Jun. 11, 2014
 Plot No. 13

DUT: LG-D105G; Type: Bar; Serial: #1

Communication System: GSM 1900; Frequency: 1880 MHz; Duty Cycle: 1:8.3
 Medium parameters used: $f = 1880 \text{ MHz}$; $\sigma = 1.48 \text{ mho/m}$; $\epsilon_r = 52.4$; $\rho = 1000 \text{ kg/m}^3$
 Phantom section: Center Section ; Measurement SW: DASY4, V4.7 Build 80; Postprocessing SW: SEMCAD, V1.8 Build 186

DASY4 Configuration:

- Probe: ET3DV6 - SN1609; ConvF(4.69, 4.69, 4.69); Calibrated: 2013-09-23
- Sensor-Surface: 4mm (Mechanical Surface Detection)
- Electronics: DAE4 Sn652; Calibrated: 2014-03-26
- Phantom: Triple Flat Phantom 5.1C; Type: QD 000 P51 CA

GSM1900 Body Rear 661ch Body worn/Area Scan (61x91x1): Measurement grid: dx=15mm, dy=15mm
 Maximum value of SAR (interpolated) = 0.321 mW/g

GSM1900 Body Rear 661ch Body worn/Zoom Scan (5x5x7)/Cube 0: Measurement grid: dx=8mm, dy=8mm, dz=5mm

Reference Value = 4.71 V/m; Power Drift = -0.075 dB
 Peak SAR (extrapolated) = 0.496 W/kg

SAR(1 g) = 0.297 mW/g; SAR(10 g) = 0.164 mW/g
 Maximum value of SAR (measured) = 0.319 mW/g

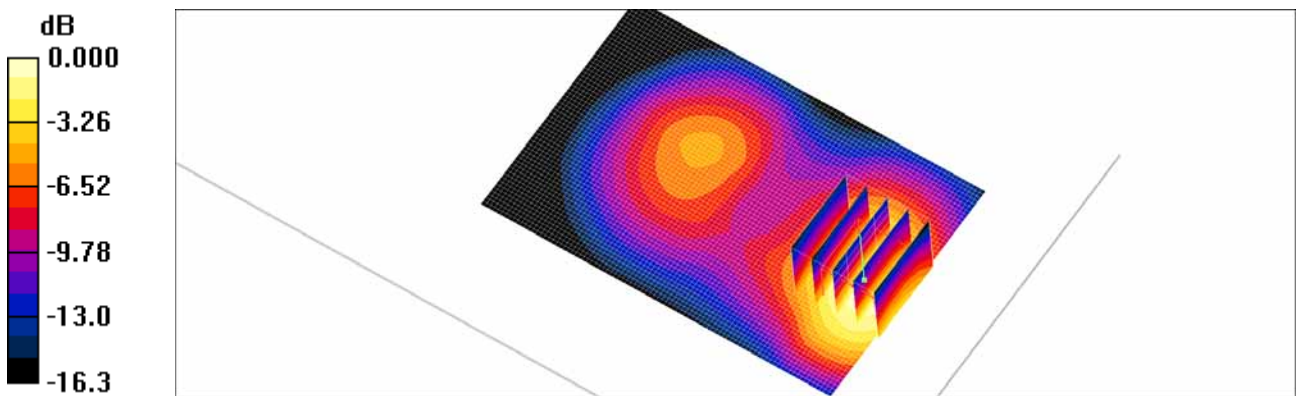

0 dB = 0.319mW/g

Test Laboratory: HCT CO., LTD
 EUT Type: Cellular/PCS GSM/GPRS/EDGE Rx/WCDMA/HSDPA/HSUPA Phone with Bluetooth and WLAN
 Liquid Temperature: 19.6 °C
 Ambient Temperature: 19.8 °C
 Test Date: Jun. 10, 2014
 Plot No. 14

DUT: LG-D105G; Type: Bar; Serial: #1

Communication System: GSM 850; Frequency: 848.8 MHz; Duty Cycle: 1:2.075
 Medium parameters used (interpolated): $f = 848.8 \text{ MHz}$; $\sigma = 0.992 \text{ mho/m}$; $\epsilon_r = 56.7$; $\rho = 1000 \text{ kg/m}^3$
 Phantom section: Center Section ; Measurement SW: DASY4, V4.7 Build 80; Postprocessing SW: SEMCAD, V1.8 Build 186

DASY4 Configuration:

- Probe: EX3DV4 - SN3903; ConvF(9.74, 9.74, 9.74); Calibrated: 2014-03-28
- Sensor-Surface: 2mm (Mechanical Surface Detection)
- Electronics: DAE3 Sn466; Calibrated: 2014-02-27
- Phantom: Triple Flat Phantom 5.1C; Type: QD 000 P51 CA

GSM850 Body Rear 251ch 4Tx/Area Scan (61x91x1): Measurement grid: dx=15mm, dy=15mm
 Maximum value of SAR (interpolated) = 1.07 mW/g

GSM850 Body Rear 251ch 4Tx/Zoom Scan (5x5x7)/Cube 0: Measurement grid: dx=8mm, dy=8mm, dz=5mm

Reference Value = 18.2 V/m; Power Drift = -0.156 dB

Peak SAR (extrapolated) = 1.31 W/kg

SAR(1 g) = 1.01 mW/g; SAR(10 g) = 0.725 mW/g

Maximum value of SAR (measured) = 1.07 mW/g

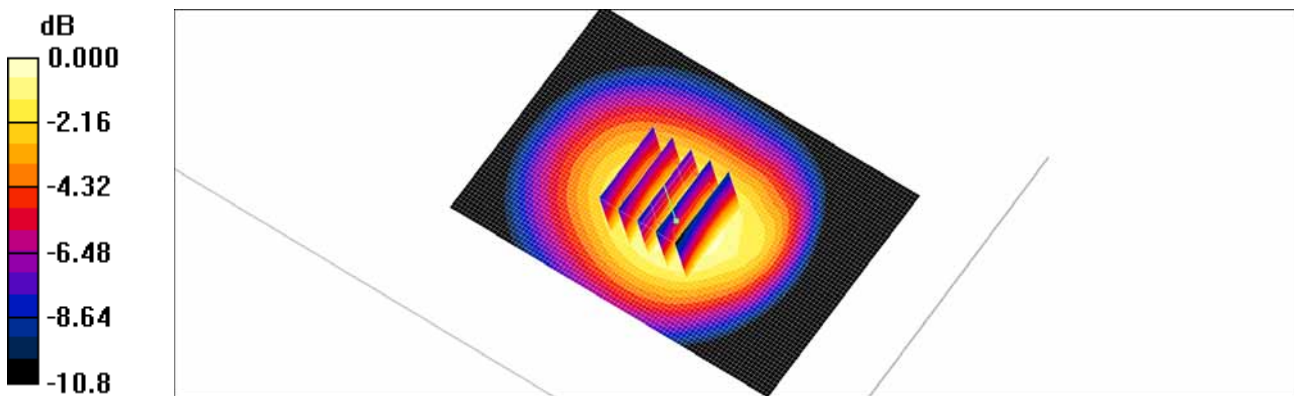

0 dB = 1.07mW/g

Attachment 2. – Dipole Verification Plots

Verification Data (835 MHz Head)

Test Laboratory: HCT CO., LTD
 Input Power: 100 mW (20 dBm)
 Liquid Temp: 20.0 °C
 Test Date: Jun. 09, 2014

DUT: Dipole 835 MHz; Type: D835V2; Serial: D835V2 - SN:4d165

Communication System: CW; Frequency: 835 MHz; Duty Cycle: 1:1
 Medium parameters used: $f = 835 \text{ MHz}$; $\sigma = 0.877 \text{ mho/m}$; $\epsilon_r = 42.2$; $\rho = 1000 \text{ kg/m}^3$
 Phantom section: Flat Section ; Measurement SW: DASY4, V4.7 Build 80; Postprocessing SW: SEMCAD, V1.8 Build 186

DASY4 Configuration:

- Probe: EX3DV4 - SN3903; ConvF(9.85, 9.85, 9.85); Calibrated: 2014-03-28
- Sensor-Surface: 2mm (Mechanical Surface Detection)
- Electronics: DAE3 Sn466; Calibrated: 2014-02-27
- Phantom: 1800/1900 Phantom; Type: SAM

Verification 835MHz/Area Scan (61x61x1): Measurement grid: $dx=15\text{mm}$, $dy=15\text{mm}$
 Maximum value of SAR (interpolated) = 1.02 mW/g

Verification 835MHz/Zoom Scan (5x5x7)/Cube 0: Measurement grid: $dx=8\text{mm}$, $dy=8\text{mm}$, $dz=5\text{mm}$
 Reference Value = 34.3 V/m; Power Drift = 0.003 dB
 Peak SAR (extrapolated) = 1.53 W/kg
SAR(1 g) = 0.935 mW/g; SAR(10 g) = 0.571 mW/g
 Maximum value of SAR (measured) = 1.03 mW/g

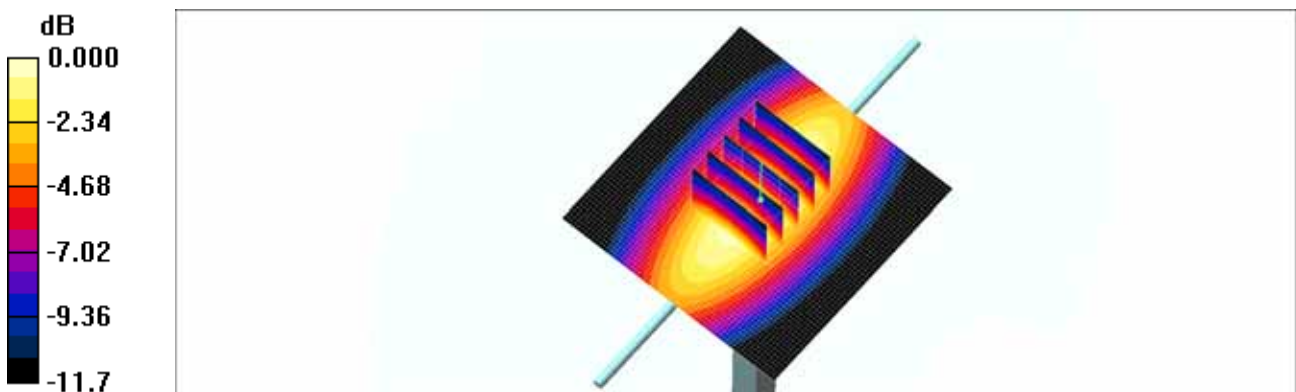

0 dB = 1.03mW/g

Verification Data (835 MHz Body)

Test Laboratory: HCT CO., LTD
 Input Power: 100 mW (20 dBm)
 Liquid Temp: 19.6 °C
 Test Date: Jun. 10, 2014

DUT: Dipole 835 MHz; Type: D835V2; Serial: D835V2 - SN:4d165

Communication System: CW; Frequency: 835 MHz; Duty Cycle: 1:1
 Medium parameters used: $f = 835 \text{ MHz}$; $\sigma = 0.98 \text{ mho/m}$; $\epsilon_r = 56.9$; $\rho = 1000 \text{ kg/m}^3$
 Phantom section: Center Section ; Measurement SW: DASy4, V4.7 Build 80; Postprocessing SW: SEMCAD, V1.8 Build 186

DASy4 Configuration:

- Probe: EX3DV4 - SN3903; ConvF(9.74, 9.74, 9.74); Calibrated: 2014-03-28
- Sensor-Surface: 2mm (Mechanical Surface Detection)
- Electronics: DAE3 Sn466; Calibrated: 2014-02-27
- Phantom: Triple Flat Phantom 5.1C; Type: QD 000 P51 CA

Verification 835 MHz/Area Scan (111x61x1): Measurement grid: dx=15mm, dy=15mm
 Maximum value of SAR (interpolated) = 1.08 mW/g

Verification 835 MHz/Zoom Scan (5x5x7)/Cube 0: Measurement grid: dx=8mm, dy=8mm, dz=5mm
 Reference Value = 33.2 V/m; Power Drift = -0.008 dB
 Peak SAR (extrapolated) = 1.48 W/kg
SAR(1 g) = 0.996 mW/g; SAR(10 g) = 0.649 mW/g
 Maximum value of SAR (measured) = 1.08 mW/g

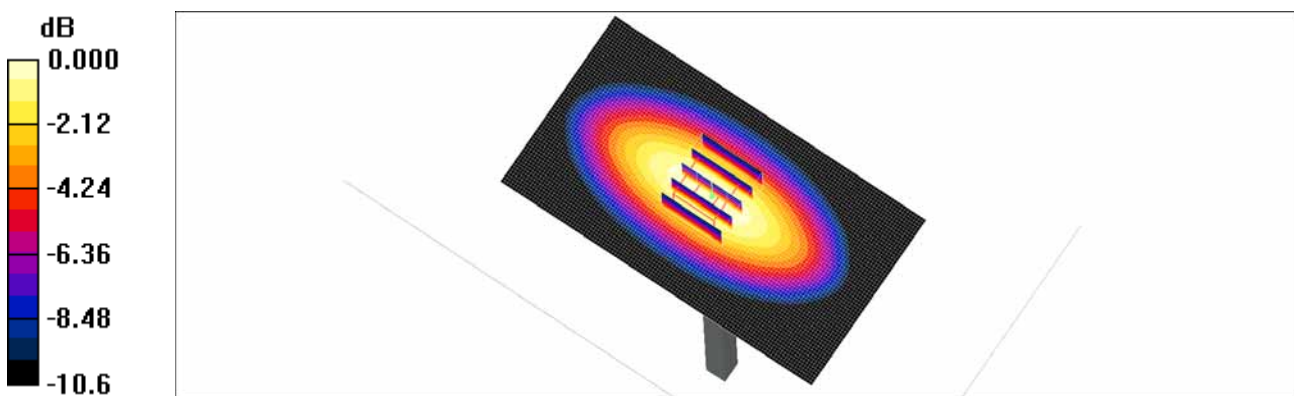

0 dB = 1.08mW/g

Verification Data (1 900 MHz Head)

Test Laboratory: HCT CO., LTD
Input Power 100 mW (20 dBm)
Liquid Temp: 19.8 °C
Test Date: Jun. 11, 2014

DUT: Dipole 1900 MHz; Type: D1900V2; Serial: D1900V2 - SN:5d032

Communication System: CW; Frequency: 1900 MHz; Duty Cycle: 1:1
Medium parameters used: $f = 1900 \text{ MHz}$; $\sigma = 1.44 \text{ mho/m}$; $\epsilon_r = 38.9$; $\rho = 1000 \text{ kg/m}^3$
Phantom section: Flat Section ; Measurement SW: DASY4, V4.7 Build 80; Postprocessing SW: SEMCAD, V1.8 Build 186

DASY4 Configuration:

- Probe: ET3DV6 - SN1609; ConvF(5.28, 5.28, 5.28); Calibrated: 2013-09-23
- Sensor-Surface: 4mm (Mechanical Surface Detection)
- Electronics: DAE4 Sn652; Calibrated: 2014-03-26
- Phantom: SAM 1800/1900 MHz; Type: SAM

Dipole 1900MHz Verification/Area Scan (61x61x1): Measurement grid: dx=15mm, dy=15mm
Maximum value of SAR (interpolated) = 4.49 mW/g

Dipole 1900MHz Verification/Zoom Scan (5x5x7)/Cube 0: Measurement grid: dx=8mm, dy=8mm, dz=5mm
Reference Value = 56.9 V/m; Power Drift = -0.062 dB
Peak SAR (extrapolated) = 6.47 W/kg
SAR(1 g) = 3.73 mW/g; SAR(10 g) = 1.94 mW/g
Maximum value of SAR (measured) = 4.14 mW/g

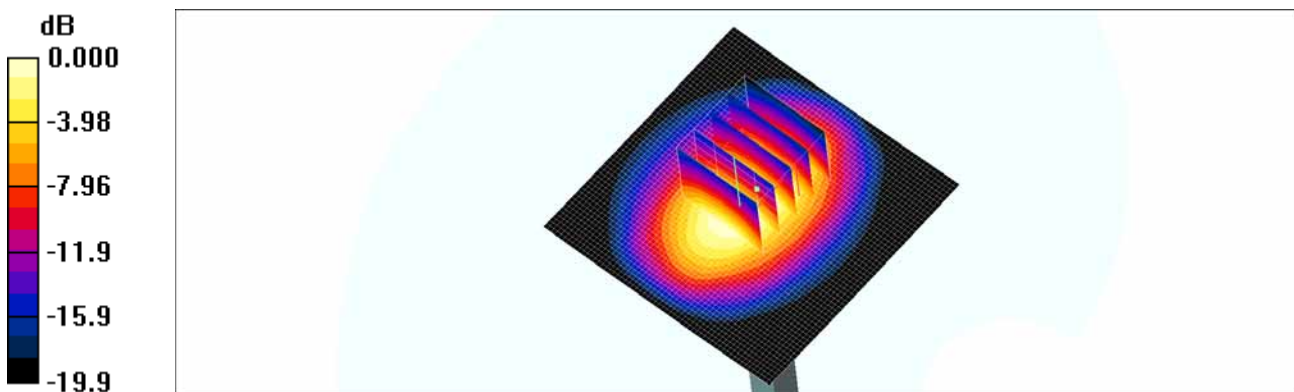

Verification Data (1 900 MHz Body)

Test Laboratory: HCT CO., LTD
 Input Power: 100 mW (20 dBm)
 Liquid Temp: 19.8 °C
 Test Date: Jun. 11, 2014

DUT: Dipole 1900 MHz; Type: D1900V2; Serial: D1900V2 - SN:5d032

Communication System: CW; Frequency: 1900 MHz; Duty Cycle: 1:1
 Medium parameters used: $f = 1900$ MHz; $\sigma = 1.5$ mho/m; $\epsilon_r = 52.3$; $\rho = 1000$ kg/m³
 Phantom section: Center Section ; Measurement SW: DASY4, V4.7 Build 80; Postprocessing SW: SEMCAD, V1.8 Build 186

DASY4 Configuration:

- Probe: ET3DV6 - SN1609; ConvF(4.69, 4.69, 4.69); Calibrated: 2013-09-23
- Sensor-Surface: 4mm (Mechanical Surface Detection)
- Electronics: DAE4 Sn652; Calibrated: 2014-03-26
- Phantom: Triple Flat Phantom 5.1C_20120905; Type: QD 000 P51 CA

Verification 1900 MHz/Area Scan (61x61x1): Measurement grid: dx=15mm, dy=15mm
 Maximum value of SAR (interpolated) = 4.52 mW/g

Verification 1900 MHz/Zoom Scan (5x5x7)/Cube 0: Measurement grid: dx=8mm, dy=8mm, dz=5mm
 Reference Value = 56.7 V/m; Power Drift = -0.029 dB
 Peak SAR (extrapolated) = 6.49 W/kg
SAR(1 g) = 3.87 mW/g; SAR(10 g) = 2.09 mW/g
 Maximum value of SAR (measured) = 4.34 mW/g

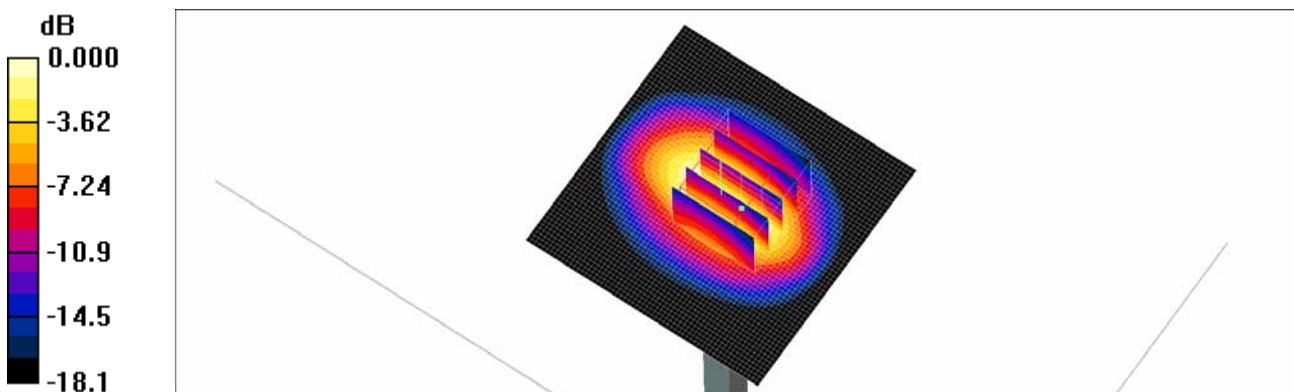

0 dB = 4.34mW/g

Verification Data (2 450 MHz Head)

Test Laboratory: HCT CO., LTD
Input Power 100 mW (20 dBm)
Liquid Temp: 20.1 °C
Test Date: Jun. 12, 2014

DUT: Dipole 2450 MHz; Type: D2450V2; Serial: D2450V2 - SN:743

Communication System: CW; Frequency: 2450 MHz; Duty Cycle: 1:1
Medium parameters used: $f = 2450$ MHz; $\sigma = 1.84$ mho/m; $\epsilon_r = 40.2$; $\rho = 1000$ kg/m³
Phantom section: Flat Section ; Measurement SW: DASY4, V4.7 Build 80; Postprocessing SW: SEMCAD, V1.8 Build 186

DASY4 Configuration:
- Probe: EX3DV4 - SN3903; ConvF(7.36, 7.36, 7.36); Calibrated: 2014-03-28
- Sensor-Surface: 2mm (Mechanical Surface Detection)
- Electronics: DAE3 Sn466; Calibrated: 2014-02-27
- Phantom: 835/900 Phantom ; Type: SAM

Verification 2450MHz/Area Scan (81x81x1): Measurement grid: dx=12mm, dy=12mm
Maximum value of SAR (interpolated) = 8.75 mW/g

Verification 2450MHz/Zoom Scan (7x7x7)/Cube 0: Measurement grid: dx=5mm, dy=5mm, dz=5mm
Reference Value = 59.0 V/m; Power Drift = -0.034 dB
Peak SAR (extrapolated) = 12.3 W/kg
SAR(1 g) = 5.53 mW/g; SAR(10 g) = 2.46 mW/g
Maximum value of SAR (measured) = 8.74 mW/g

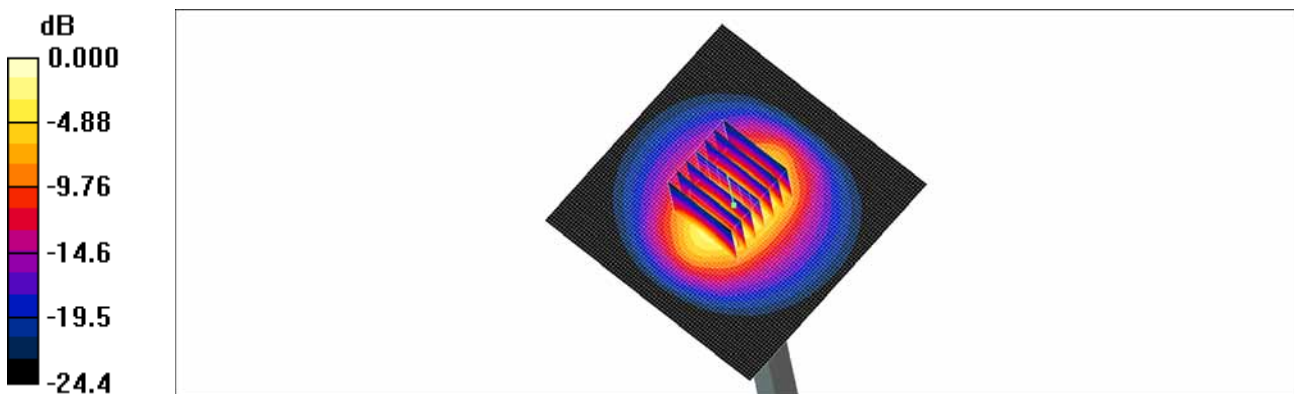

0 dB = 8.74mW/g

Verification Data (2 450 MHz Body)

Test Laboratory: HCT CO., LTD
 Input Power: 100 mW (20 dBm)
 Liquid Temp: 20.1 °C
 Test Date: Jun. 12, 2014

DUT: Dipole 2450 MHz; Type: D2450V2; Serial: D2450V2 - SN:743

Communication System: CW; Frequency: 2450 MHz; Duty Cycle: 1:1
 Medium parameters used: $f = 2450$ MHz; $\sigma = 1.96$ mho/m; $\epsilon_r = 52.3$; $\rho = 1000$ kg/m³
 Phantom section: Center Section ; Measurement SW: DASY4, V4.7 Build 80; Postprocessing SW: SEMCAD, V1.8 Build 186

DASY4 Configuration:

- Probe: EX3DV4 - SN3903; ConvF(7.2, 7.2, 7.2); Calibrated: 2014-03-28
- Sensor-Surface: 2mm (Mechanical Surface Detection)
- Electronics: DAE3 Sn466; Calibrated: 2014-02-27
- Phantom: Triple Flat Phantom 5.1C; Type: QD 000 P51 CA

Verification 2450MHz/Area Scan (81x81x1): Measurement grid: dx=12mm, dy=12mm
 Maximum value of SAR (interpolated) = 8.77 mW/g

Verification 2450MHz/Zoom Scan (7x7x7)/Cube 0: Measurement grid: dx=5mm, dy=5mm, dz=5mm

Reference Value = 51.3 V/m; Power Drift = 0.020 dB

Peak SAR (extrapolated) = 12.8 W/kg

SAR(1 g) = 5.46 mW/g; SAR(10 g) = 2.35 mW/g

Maximum value of SAR (measured) = 8.82 mW/g

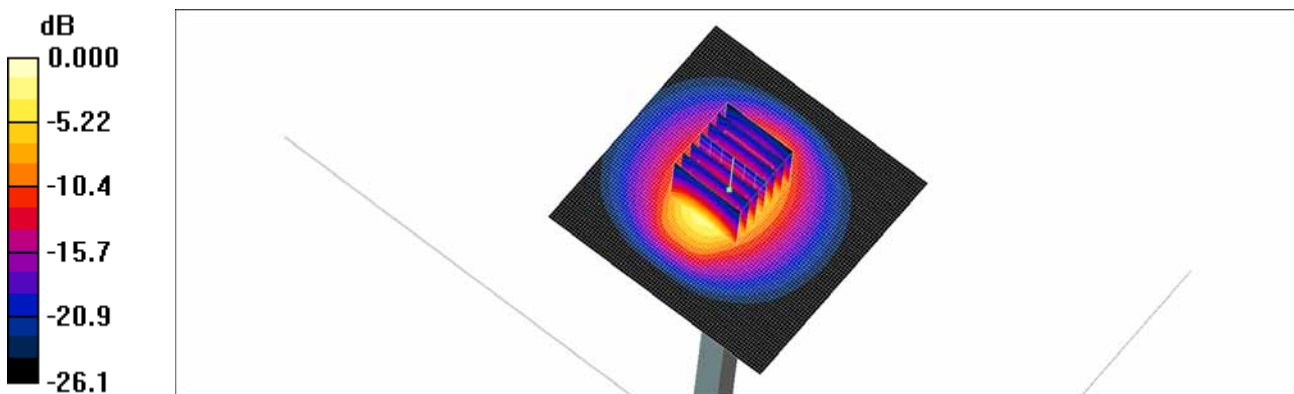

0 dB = 8.82mW/g

Attachment 3. – Probe Calibration Data

**Calibration Laboratory of
Schmid & Partner
Engineering AG**
Zeughausstrasse 43, 8004 Zurich, Switzerland



S Schweizerischer Kalibrierdienst
C Service suisse d'étalonnage
S Servizio svizzero di taratura
S Swiss Calibration Service

Accredited by the Swiss Accreditation Service (SAS)
The Swiss Accreditation Service is one of the signatories to the EA
Multilateral Agreement for the recognition of calibration certificates

Accreditation No.: **SCS 108**

Client **HCT (Dymstec)**

Certificate No: **EX3-3903_Mar14**

CALIBRATION CERTIFICATE

Object: **EX3DV4 - SN:3903**

Calibration procedure(s): **QA CAL-01.v9, QA CAL-14.v4, QA CAL-23.v5, QA CAL-25.v6
Calibration procedure for dosimetric E-field probes**

Calibration date: **March 28, 2014**

This calibration certificate documents the traceability to national standards, which realize the physical units of measurements (SI).
The measurements and the uncertainties with confidence probability are given on the following pages and are part of the certificate.

All calibrations have been conducted in the closed laboratory facility: environment temperature (22 ± 3)°C and humidity < 70%.

Calibration Equipment used (M&TE critical for calibration)

Primary Standards	ID	Cal Date (Certificate No.)	Scheduled Calibration
Power meter E4419B	GB41293874	04-Apr-13 (No. 217-01733)	Apr-14
Power sensor E4412A	MY41498087	04-Apr-13 (No. 217-01733)	Apr-14
Reference 3 dB Attenuator	SN: S5054 (3c)	04-Apr-13 (No. 217-01737)	Apr-14
Reference 20 dB Attenuator	SN: S5277 (20x)	04-Apr-13 (No. 217-01735)	Apr-14
Reference 30 dB Attenuator	SN: S5129 (30b)	04-Apr-13 (No. 217-01738)	Apr-14
Reference Probe ES3DV2	SN: 3013	30-Dec-13 (No. ES3-3013_Dec13)	Dec-14
DAE4	SN: 660	13-Dec-13 (No. DAE4-660_Dec13)	Dec-14
Secondary Standards	ID	Check Date (in house)	Scheduled Check
RF generator HP 8648C	US3642U01700	4-Aug-99 (in house check Apr-13)	In house check: Apr-16
Network Analyzer HP 8753E	US37390585	18-Oct-01 (in house check Oct-13)	In house check: Oct-14

	Name	Function	Signature
Calibrated by:	Jeton Kastrati	Laboratory Technician	
Approved by:	Katja Pokovic	Technical Manager	

Issued: March 29, 2014

This calibration certificate shall not be reproduced except in full without written approval of the laboratory.

**Calibration Laboratory of
Schmid & Partner
Engineering AG**
Zeughausstrasse 43, 8004 Zurich, Switzerland



S Schweizerischer Kalibrierdienst
S Service suisse d'étalonnage
S Servizio svizzero di taratura
S Swiss Calibration Service

Accredited by the Swiss Accreditation Service (SAS)
The Swiss Accreditation Service is one of the signatories to the EA
Multilateral Agreement for the recognition of calibration certificates

Accreditation No.: **SCS 108**

Glossary:

TSL	tissue simulating liquid
NORM _{x,y,z}	sensitivity in free space
ConvF	sensitivity in TSL / NORM _{x,y,z}
DCP	diode compression point
CF	crest factor (1/duty_cycle) of the RF signal
A, B, C, D	modulation dependent linearization parameters
Polarization φ	φ rotation around probe axis
Polarization ϑ	ϑ rotation around an axis that is in the plane normal to probe axis (at measurement center), i.e., $\vartheta = 0$ is normal to probe axis
Connector Angle	information used in DASY system to align probe sensor X to the robot coordinate system

Calibration is Performed According to the Following Standards:

- a) IEEE Std 1528-2013, "IEEE Recommended Practice for Determining the Peak Spatial-Averaged Specific Absorption Rate (SAR) in the Human Head from Wireless Communications Devices: Measurement Techniques", June 2013
- b) IEC 62209-1, "Procedure to measure the Specific Absorption Rate (SAR) for hand-held devices used in close proximity to the ear (frequency range of 300 MHz to 3 GHz)", February 2005

Methods Applied and Interpretation of Parameters:

- **NORM_{x,y,z}**: Assessed for E-field polarization $\vartheta = 0$ ($f \leq 900$ MHz in TEM-cell; $f > 1800$ MHz: R22 waveguide). NORM_{x,y,z} are only intermediate values, i.e., the uncertainties of NORM_{x,y,z} does not affect the E²-field uncertainty inside TSL (see below ConvF).
- **NORM(f)_{x,y,z}** = NORM_{x,y,z} * frequency_response (see Frequency Response Chart). This linearization is implemented in DASY4 software versions later than 4.2. The uncertainty of the frequency response is included in the stated uncertainty of ConvF.
- **DCP_{x,y,z}**: DCP are numerical linearization parameters assessed based on the data of power sweep with CW signal (no uncertainty required). DCP does not depend on frequency nor media.
- **PAR**: PAR is the Peak to Average Ratio that is not calibrated but determined based on the signal characteristics
- **A_{x,y,z}; B_{x,y,z}; C_{x,y,z}; D_{x,y,z}; VR_{x,y,z}**: A, B, C, D are numerical linearization parameters assessed based on the data of power sweep for specific modulation signal. The parameters do not depend on frequency nor media. VR is the maximum calibration range expressed in RMS voltage across the diode.
- **ConvF and Boundary Effect Parameters**: Assessed in flat phantom using E-field (or Temperature Transfer Standard for $f \leq 800$ MHz) and inside waveguide using analytical field distributions based on power measurements for $f > 800$ MHz. The same setups are used for assessment of the parameters applied for boundary compensation (alpha, depth) of which typical uncertainty values are given. These parameters are used in DASY4 software to improve probe accuracy close to the boundary. The sensitivity in TSL corresponds to NORM_{x,y,z} * ConvF whereby the uncertainty corresponds to that given for ConvF. A frequency dependent ConvF is used in DASY version 4.4 and higher which allows extending the validity from ± 50 MHz to ± 100 MHz.
- **Spherical isotropy (3D deviation from isotropy)**: in a field of low gradients realized using a flat phantom exposed by a patch antenna.
- **Sensor Offset**: The sensor offset corresponds to the offset of virtual measurement center from the probe tip (on probe axis). No tolerance required.
- **Connector Angle**: The angle is assessed using the information gained by determining the NORM_x (no uncertainty required).

EX3DV4 – SN:3903

March 28, 2014

Probe EX3DV4

SN:3903

Manufactured: September 4, 2012

Calibrated: March 28, 2014

Calibrated for DASY/EASY Systems

(Note: non-compatible with DASY2 system!)

EX3DV4- SN:3903

March 28, 2014

DASY/EASY - Parameters of Probe: EX3DV4 - SN:3903

Basic Calibration Parameters

	Sensor X	Sensor Y	Sensor Z	Unc (k=2)
Norm ($\mu\text{V}/(\text{V}/\text{m})^2$) ^A	0.53	0.48	0.52	± 10.1 %
DCP (mV) ^B	101.1	100.6	99.0	

Modulation Calibration Parameters

UID	Communication System Name		A dB	B dB√ μV	C	D dB	VR mV	Unc ^E (k=2)
0	CW	X	0.0	0.0	1.0	0.00	132.8	±3.3 %
		Y	0.0	0.0	1.0		145.6	
		Z	0.0	0.0	1.0		144.7	

The reported uncertainty of measurement is stated as the standard uncertainty of measurement multiplied by the coverage factor k=2, which for a normal distribution corresponds to a coverage probability of approximately 95%.

^A The uncertainties of NormX,Y,Z do not affect the E²-field uncertainty inside TSL (see Pages 5 and 6).

^B Numerical linearization parameter; uncertainty not required.

^E Uncertainty is determined using the max. deviation from linear response applying rectangular distribution and is expressed for the square of the field value.

EX3DV4- SN:3903

March 28, 2014

DASY/EASY - Parameters of Probe: EX3DV4 - SN:3903

Calibration Parameter Determined in Head Tissue Simulating Media

f (MHz) ^c	Relative Permittivity ^f	Conductivity (S/m) ^f	ConvF X	ConvF Y	ConvF Z	Alpha ^g	Depth ^g (mm)	Unct. (k=2)
835	41.5	0.90	9.85	9.85	9.85	0.34	0.94	± 12.0 %
900	41.5	0.97	9.67	9.67	9.67	0.51	0.72	± 12.0 %
1450	40.5	1.20	8.62	8.62	8.62	0.24	1.21	± 12.0 %
1750	40.1	1.37	8.56	8.56	8.56	0.80	0.60	± 12.0 %
1900	40.0	1.40	8.28	8.28	8.28	0.43	0.80	± 12.0 %
1950	40.0	1.40	7.94	7.94	7.94	0.80	0.60	± 12.0 %
2300	39.5	1.67	7.78	7.78	7.78	0.58	0.71	± 12.0 %
2450	39.2	1.80	7.36	7.36	7.36	0.40	0.86	± 12.0 %
2600	39.0	1.96	7.13	7.13	7.13	0.43	0.85	± 12.0 %
5200	36.0	4.66	4.96	4.96	4.96	0.30	1.80	± 13.1 %
5300	35.9	4.76	4.64	4.64	4.64	0.40	1.80	± 13.1 %
5500	35.6	4.96	4.65	4.65	4.65	0.40	1.80	± 13.1 %
5600	35.5	5.07	4.47	4.47	4.47	0.40	1.80	± 13.1 %
5800	35.3	5.27	4.36	4.36	4.36	0.40	1.80	± 13.1 %

^c Frequency validity of ± 100 MHz only applies for DASY v4.4 and higher (see Page 2), else it is restricted to ± 50 MHz. The uncertainty is the RSS of the ConvF uncertainty at calibration frequency and the uncertainty for the indicated frequency band.

^f At frequencies below 3 GHz, the validity of tissue parameters (ϵ and σ) can be relaxed to ± 10% if liquid compensation formula is applied to measured SAR values. At frequencies above 3 GHz, the validity of tissue parameters (ϵ and σ) is restricted to ± 5%. The uncertainty is the RSS of the ConvF uncertainty for indicated target tissue parameters.

^g Alpha/Depth are determined during calibration. SPEAG warrants that the remaining deviation due to the boundary effect after compensation is always less than ± 1% for frequencies below 3 GHz and below ± 2% for frequencies between 3-6 GHz at any distance larger than half the probe tip diameter from the boundary.

EX3DV4- SN:3903

March 28, 2014

DASY/EASY - Parameters of Probe: EX3DV4 - SN:3903

Calibration Parameter Determined in Body Tissue Simulating Media

f (MHz) ^c	Relative Permittivity ^f	Conductivity (S/m) ^f	ConvF X	ConvF Y	ConvF Z	Alpha ^g	Depth ^g (mm)	Unct. (k=2)
835	55.2	0.97	9.74	9.74	9.74	0.31	1.12	± 12.0 %
1750	53.4	1.49	7.93	7.93	7.93	0.37	0.88	± 12.0 %
1900	53.3	1.52	7.57	7.57	7.57	0.32	0.93	± 12.0 %
2300	52.9	1.81	7.32	7.32	7.32	0.50	0.75	± 12.0 %
2450	52.7	1.95	7.20	7.20	7.20	0.80	0.56	± 12.0 %
2600	52.5	2.16	7.03	7.03	7.03	0.80	0.50	± 12.0 %
5200	49.0	5.30	4.41	4.41	4.41	0.40	1.90	± 13.1 %
5300	48.9	5.42	4.15	4.15	4.15	0.45	1.90	± 13.1 %
5500	48.6	5.65	3.85	3.85	3.85	0.45	1.90	± 13.1 %
5600	48.5	5.77	3.59	3.59	3.59	0.50	1.90	± 13.1 %
5800	48.2	6.00	3.97	3.97	3.97	0.50	1.90	± 13.1 %

^c Frequency validity of ± 100 MHz only applies for DASY v4.4 and higher (see Page 2), else it is restricted to ± 50 MHz. The uncertainty is the RSS of the ConvF uncertainty at calibration frequency and the uncertainty for the indicated frequency band.

^f At frequencies below 3 GHz, the validity of tissue parameters (ϵ and σ) can be relaxed to ± 10% if liquid compensation formula is applied to measured SAR values. At frequencies above 3 GHz, the validity of tissue parameters (ϵ and σ) is restricted to ± 5%. The uncertainty is the RSS of the ConvF uncertainty for indicated target tissue parameters.

^g Alpha/Depth are determined during calibration. SPEAG warrants that the remaining deviation due to the boundary effect after compensation is always less than ± 1% for frequencies below 3 GHz and below ± 2% for frequencies between 3-6 GHz at any distance larger than half the probe tip diameter from the boundary.

EX3DV4- SN:3903

March 28, 2014

Frequency Response of E-Field (TEM-Cell:ifi110 EXX, Waveguide: R22)

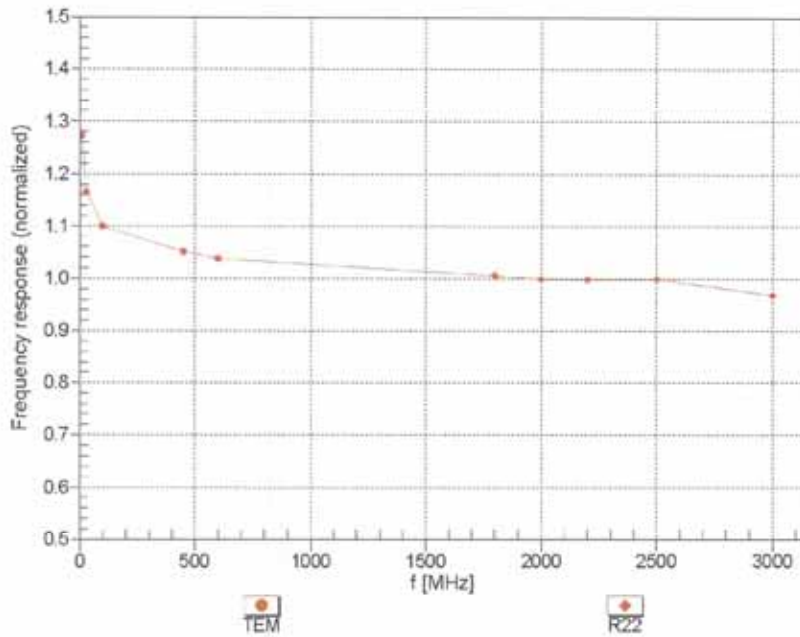

Uncertainty of Frequency Response of E-field: $\pm 6.3\%$ (k=2)

EX3DV4- SN:3903

March 28, 2014

Receiving Pattern (ϕ), $\theta = 0^\circ$

f=600 MHz, TEM

f=1800 MHz, R22

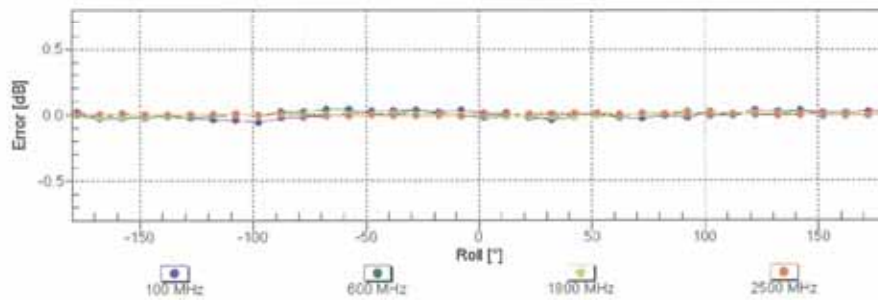
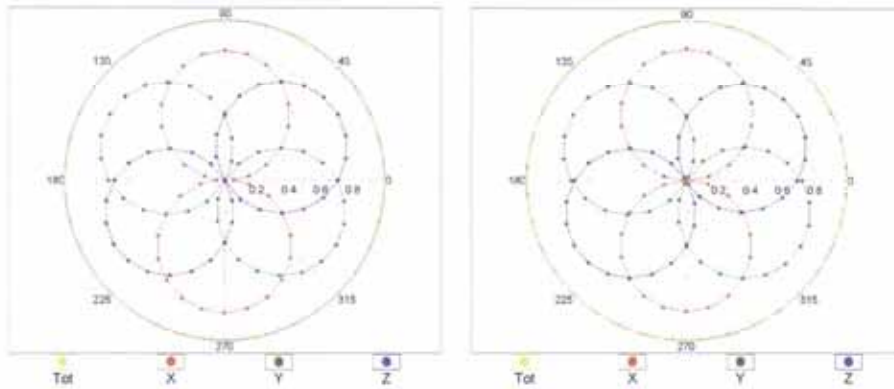

Uncertainty of Axial Isotropy Assessment: $\pm 0.5\%$ (k=2)

EX3DV4- SN:3903

March 28, 2014

Dynamic Range f(SAR_{head})
(TEM cell , f_{eval}= 1900 MHz)

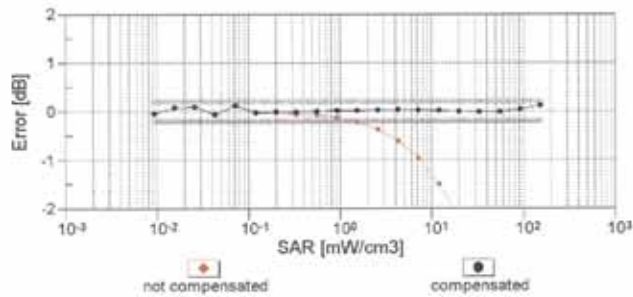
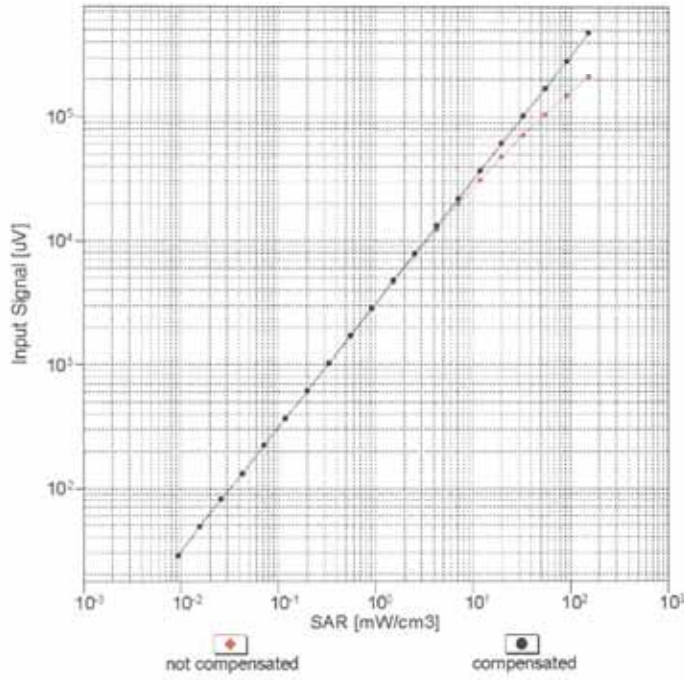

Uncertainty of Linearity Assessment: ± 0.6% (k=2)

EX3DV4- SN:3903

March 28, 2014

Conversion Factor Assessment

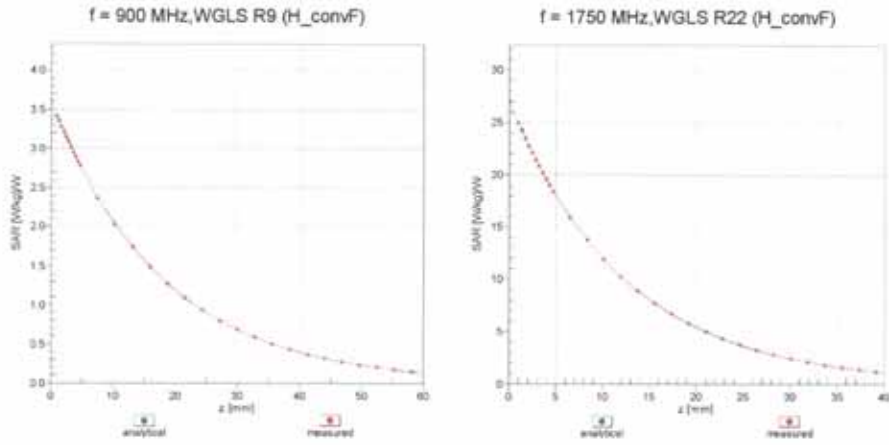

Deviation from Isotropy in Liquid Error (ϕ, θ), f = 900 MHz

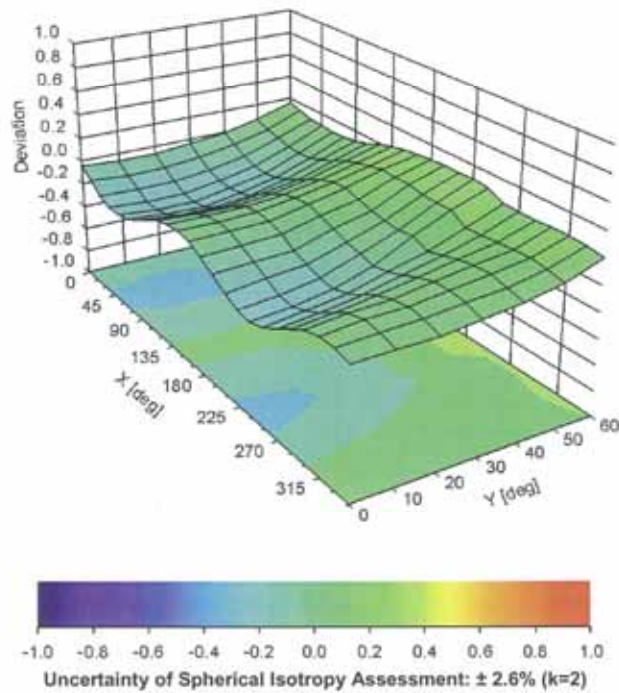

EX3DV4- SN:3903

March 28, 2014

DASY/EASY - Parameters of Probe: EX3DV4 - SN:3903

Other Probe Parameters

Sensor Arrangement	Triangular
Connector Angle (°)	-87.6
Mechanical Surface Detection Mode	enabled
Optical Surface Detection Mode	disabled
Probe Overall Length	337 mm
Probe Body Diameter	10 mm
Tip Length	9 mm
Tip Diameter	2.5 mm
Probe Tip to Sensor X Calibration Point	1 mm
Probe Tip to Sensor Y Calibration Point	1 mm
Probe Tip to Sensor Z Calibration Point	1 mm
Recommended Measurement Distance from Surface	2 mm

**Calibration Laboratory of
Schmid & Partner
Engineering AG**
Zeughausstrasse 43, 8004 Zurich, Switzerland



S Schweizerischer Kalibrierdienst
C Service suisse d'étalonnage
S Servizio svizzero di taratura
S Swiss Calibration Service

Accredited by the Swiss Accreditation Service (SAS)
The Swiss Accreditation Service is one of the signatories to the EA
Multilateral Agreement for the recognition of calibration certificates

Accreditation No.: **SCS 108**

Client **HCT (Dymstec)**

Certificate No: **ET3-1609_Sep13**

CALIBRATION CERTIFICATE

Object: **ET3DV6 - SN:1609**

Calibration procedure(s): **QA CAL-01.v9, QA CAL-23.v5, QA CAL-25.v6
Calibration procedure for dosimetric E-field probes**

Calibration date: **September 23, 2013**

This calibration certificate documents the traceability to national standards, which realize the physical units of measurements (SI).
The measurements and the uncertainties with confidence probability are given on the following pages and are part of the certificate.

All calibrations have been conducted in the closed laboratory facility; environment temperature (22 ± 3)°C and humidity < 70%.

Calibration Equipment used (M&TE critical for calibration)

Primary Standards	ID	Cal Date (Certificate No.)	Scheduled Calibration
Power meter E4419B	GB41293874	04-Apr-13 (No. 217-01733)	Apr-14
Power sensor E4412A	MY41498087	04-Apr-13 (No. 217-01733)	Apr-14
Reference 3 dB Attenuator	SN: S5054 (3c)	04-Apr-13 (No. 217-01737)	Apr-14
Reference 20 dB Attenuator	SN: S5277 (20x)	04-Apr-13 (No. 217-01735)	Apr-14
Reference 30 dB Attenuator	SN: S5129 (30b)	04-Apr-13 (No. 217-01738)	Apr-14
Reference Probe ES3DV2	SN: 3013	28-Dec-12 (No. ES3-3013_Dec12)	Dec-13
DAE4	SN: 660	4-Sep-13 (No. DAE4-660_Sep13)	Apr-14
Secondary Standards	ID	Check Date (in house)	Scheduled Check
RF generator HP 8648C	US3642U01700	4-Aug-99 (in house check Apr-13)	In house check: Apr-15
Network Analyzer HP 8753E	US37390585	18-Oct-01 (in house check Oct-12)	In house check: Oct-13

	Name	Function	Signature
Calibrated by:	Jeton Kastrati	Laboratory Technician	
Approved by:	Katja Pokovic	Technical Manager	

Issued: September 24, 2013

This calibration certificate shall not be reproduced except in full without written approval of the laboratory.

**Calibration Laboratory of
Schmid & Partner
Engineering AG**
Zeughausstrasse 43, 8004 Zurich, Switzerland



S Schweizerischer Kalibrierdienst
C Service suisse d'étalonnage
S Servizio svizzero di taratura
S Swiss Calibration Service

Accredited by the Swiss Accreditation Service (SAS)
The Swiss Accreditation Service is one of the signatories to the EA
Multilateral Agreement for the recognition of calibration certificates

Accreditation No.: **SCS 108**

Glossary:

TSL	tissue simulating liquid
NORM _{x,y,z}	sensitivity in free space
ConvF	sensitivity in TSL / NORM _{x,y,z}
DCP	diode compression point
CF	crest factor (1/duty_cycle) of the RF signal
A, B, C, D	modulation dependent linearization parameters
Polarization φ	φ rotation around probe axis
Polarization θ	θ rotation around an axis that is in the plane normal to probe axis (at measurement center), i.e., θ = 0 is normal to probe axis

Calibration is Performed According to the Following Standards:

- a) IEEE Std 1528-2003, "IEEE Recommended Practice for Determining the Peak Spatial-Averaged Specific Absorption Rate (SAR) in the Human Head from Wireless Communications Devices: Measurement Techniques", December 2003
- b) IEC 62209-1, "Procedure to measure the Specific Absorption Rate (SAR) for hand-held devices used in close proximity to the ear (frequency range of 300 MHz to 3 GHz)", February 2005

Methods Applied and Interpretation of Parameters:

- **NORM_{x,y,z}**: Assessed for E-field polarization θ = 0 (f ≤ 900 MHz in TEM-cell; f > 1800 MHz: R22 waveguide). NORM_{x,y,z} are only intermediate values, i.e., the uncertainties of NORM_{x,y,z} does not affect the E²-field uncertainty inside TSL (see below ConvF).
- **NORM(f)_{x,y,z} = NORM_{x,y,z} * frequency_response** (see Frequency Response Chart). This linearization is implemented in DASY4 software versions later than 4.2. The uncertainty of the frequency response is included in the stated uncertainty of ConvF.
- **DCP_{x,y,z}**: DCP are numerical linearization parameters assessed based on the data of power sweep with CW signal (no uncertainty required). DCP does not depend on frequency nor media.
- **PAR**: PAR is the Peak to Average Ratio that is not calibrated but determined based on the signal characteristics
- **A_{x,y,z}; B_{x,y,z}; C_{x,y,z}; D_{x,y,z}; VR_{x,y,z}**: A, B, C, D are numerical linearization parameters assessed based on the data of power sweep for specific modulation signal. The parameters do not depend on frequency nor media. VR is the maximum calibration range expressed in RMS voltage across the diode.
- **ConvF and Boundary Effect Parameters**: Assessed in flat phantom using E-field (or Temperature Transfer Standard for f ≤ 800 MHz) and inside waveguide using analytical field distributions based on power measurements for f > 800 MHz. The same setups are used for assessment of the parameters applied for boundary compensation (alpha, depth) of which typical uncertainty values are given. These parameters are used in DASY4 software to improve probe accuracy close to the boundary. The sensitivity in TSL corresponds to NORM_{x,y,z} * ConvF whereby the uncertainty corresponds to that given for ConvF. A frequency dependent ConvF is used in DASY version 4.4 and higher which allows extending the validity from ± 50 MHz to ± 100 MHz.
- **Spherical isotropy (3D deviation from isotropy)**: in a field of low gradients realized using a flat phantom exposed by a patch antenna.
- **Sensor Offset**: The sensor offset corresponds to the offset of virtual measurement center from the probe tip (on probe axis). No tolerance required.

ET3DV6 – SN:1609

September 23, 2013

Probe ET3DV6

SN:1609

Manufactured: July 27, 2001
Calibrated: September 23, 2013

Calibrated for DASY/EASY Systems
(Note: non-compatible with DASY2 system!)

ET3DV6- SN:1609

September 23, 2013

DASY/EASY - Parameters of Probe: ET3DV6 - SN:1609

Basic Calibration Parameters

	Sensor X	Sensor Y	Sensor Z	Unc (k=2)
Norm ($\mu\text{V}/(\text{V}/\text{m})^2$) ^a	1.99	1.79	1.80	$\pm 10.1 \%$
DCP (mV) ^b	98.3	98.3	98.4	

Modulation Calibration Parameters

UID	Communication System Name		A	B	C	D	VR	Unc ^c
			dB	dB $\sqrt{\mu\text{V}}$		dB	mV	(k=2)
0	CW	X	0.0	0.0	1.0	0.00	146.6	$\pm 2.5 \%$
		Y	0.0	0.0	1.0		151.1	
		Z	0.0	0.0	1.0		144.0	

The reported uncertainty of measurement is stated as the standard uncertainty of measurement multiplied by the coverage factor k=2, which for a normal distribution corresponds to a coverage probability of approximately 95%.

^a The uncertainties of NormX,Y,Z do not affect the E²-field uncertainty inside TSL (see Pages 5 and 6).

^b Numerical linearization parameter; uncertainty not required.

^c Uncertainty is determined using the max. deviation from linear response applying rectangular distribution and is expressed for the square of the field value.

ET3DV6- SN:1609

September 23, 2013

DASY/EASY - Parameters of Probe: ET3DV6 - SN:1609

Calibration Parameter Determined in Head Tissue Simulating Media

f (MHz) ^c	Relative Permittivity ^e	Conductivity (S/m) ^f	ConvF X	ConvF Y	ConvF Z	Alpha	Depth (mm)	Unct. (k=2)
750	41.9	0.89	6.69	6.69	6.69	0.36	2.56	± 12.0 %
835	41.5	0.90	6.43	6.43	6.43	0.26	3.00	± 12.0 %
900	41.5	0.97	6.28	6.28	6.28	0.31	2.78	± 12.0 %
1450	40.5	1.20	5.79	5.79	5.79	0.58	2.37	± 12.0 %
1750	40.1	1.37	5.50	5.50	5.50	0.80	2.02	± 12.0 %
1900	40.0	1.40	5.28	5.28	5.28	0.80	2.07	± 12.0 %
1950	40.0	1.40	5.15	5.15	5.15	0.80	1.99	± 12.0 %
2300	39.5	1.67	4.98	4.98	4.98	0.80	1.84	± 12.0 %
2450	39.2	1.80	4.64	4.64	4.64	0.80	1.70	± 12.0 %

^c Frequency validity of ± 100 MHz only applies for DASY v4.4 and higher (see Page 2), else it is restricted to ± 50 MHz. The uncertainty is the RSS of the ConvF uncertainty at calibration frequency and the uncertainty for the indicated frequency band.

^e At frequencies below 3 GHz, the validity of tissue parameters (ϵ and σ) can be relaxed to ± 10% if liquid compensation formula is applied to measured SAR values. At frequencies above 3 GHz, the validity of tissue parameters (ϵ and σ) is restricted to ± 5%. The uncertainty is the RSS of the ConvF uncertainty for indicated target tissue parameters.

ET3DV6- SN:1609

September 23, 2013

DASY/EASY - Parameters of Probe: ET3DV6 - SN:1609

Calibration Parameter Determined in Body Tissue Simulating Media

f (MHz) ^c	Relative Permittivity ^e	Conductivity (S/m) ^f	ConvF X	ConvF Y	ConvF Z	Alpha	Depth (mm)	Unct. (k=2)
750	55.5	0.96	6.25	6.25	6.25	0.31	2.76	± 12.0 %
835	55.2	0.97	6.22	6.22	6.22	0.42	2.34	± 12.0 %
1750	53.4	1.49	4.90	4.90	4.90	0.80	2.34	± 12.0 %
1900	53.3	1.52	4.69	4.69	4.69	0.80	2.27	± 12.0 %
2450	52.7	1.95	4.20	4.20	4.20	0.68	1.21	± 12.0 %

^c Frequency validity of ± 100 MHz only applies for DASY v4.4 and higher (see Page 2), else it is restricted to ± 50 MHz. The uncertainty is the RSS of the ConvF uncertainty at calibration frequency and the uncertainty for the indicated frequency band.

^e At frequencies below 3 GHz, the validity of tissue parameters (ϵ and σ) can be relaxed to ± 10% if liquid compensation formula is applied to measured SAR values. At frequencies above 3 GHz, the validity of tissue parameters (ϵ and σ) is restricted to ± 5%. The uncertainty is the RSS of the ConvF uncertainty for indicated target tissue parameters.

ET3DV6- SN:1609

September 23, 2013

Frequency Response of E-Field (TEM-Cell:ifi110 EXX, Waveguide: R22)

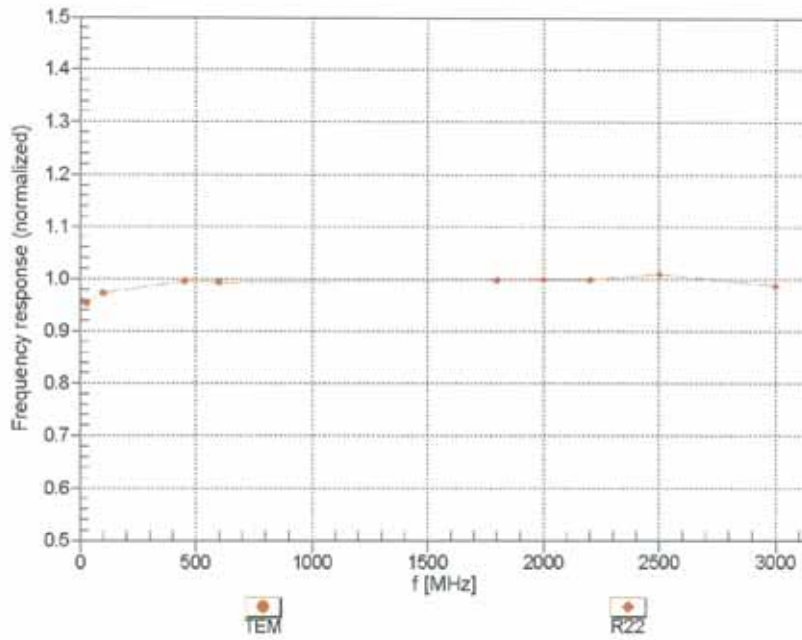

Uncertainty of Frequency Response of E-field: $\pm 6.3\%$ (k=2)

ET3DV6- SN:1609

September 23, 2013

Receiving Pattern (ϕ), $\theta = 0^\circ$

f=600 MHz, TEM

f=1800 MHz, R22

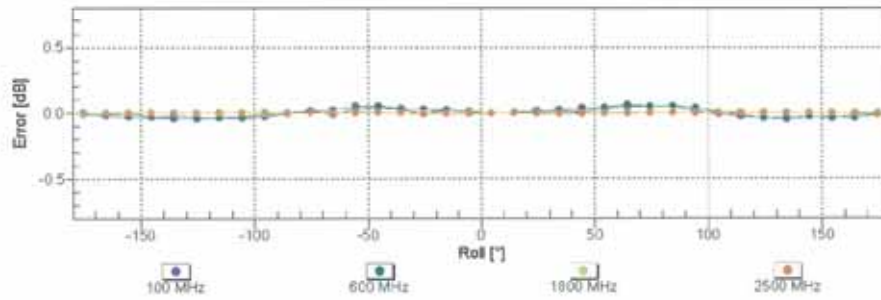
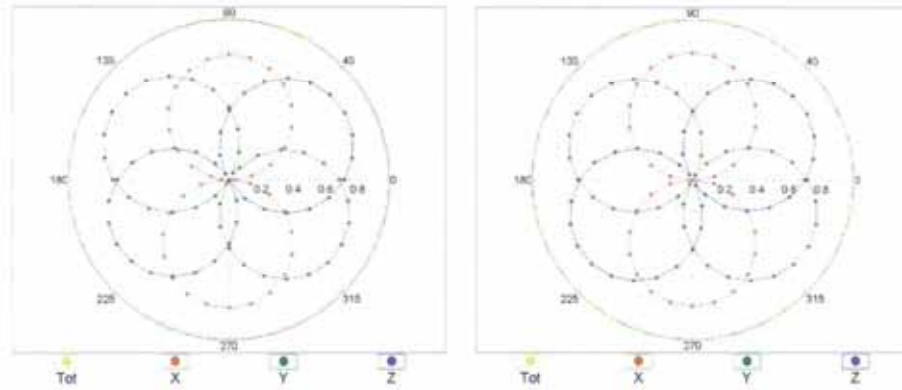

Uncertainty of Axial Isotropy Assessment: $\pm 0.5\%$ ($k=2$)

ET3DV6- SN:1609

September 23, 2013

Dynamic Range f(SAR_{head}) (TEM cell , f = 900 MHz)

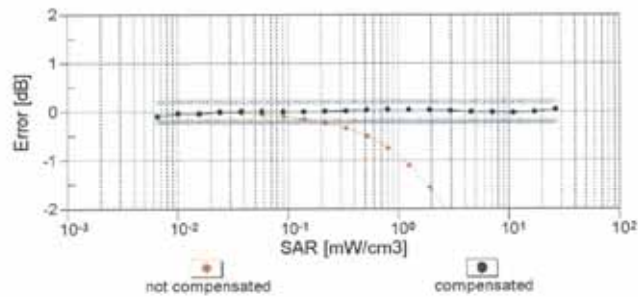
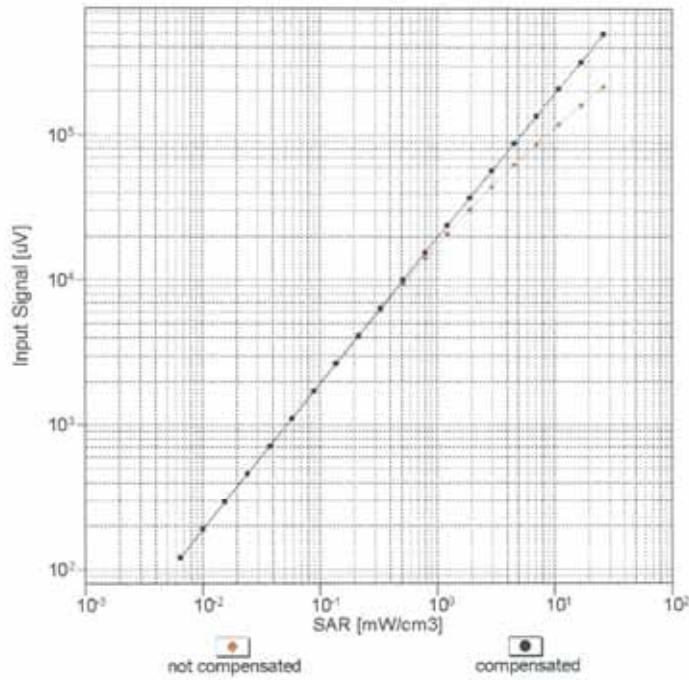

Uncertainty of Linearity Assessment: ± 0.6% (k=2)

ET3DV6-SN:1609

September 23, 2013

Conversion Factor Assessment

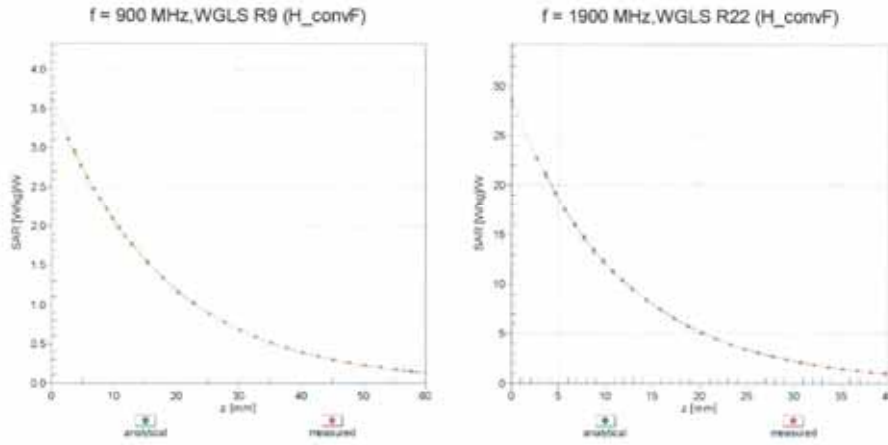

Deviation from Isotropy in Liquid Error (ϕ , θ), f = 900 MHz

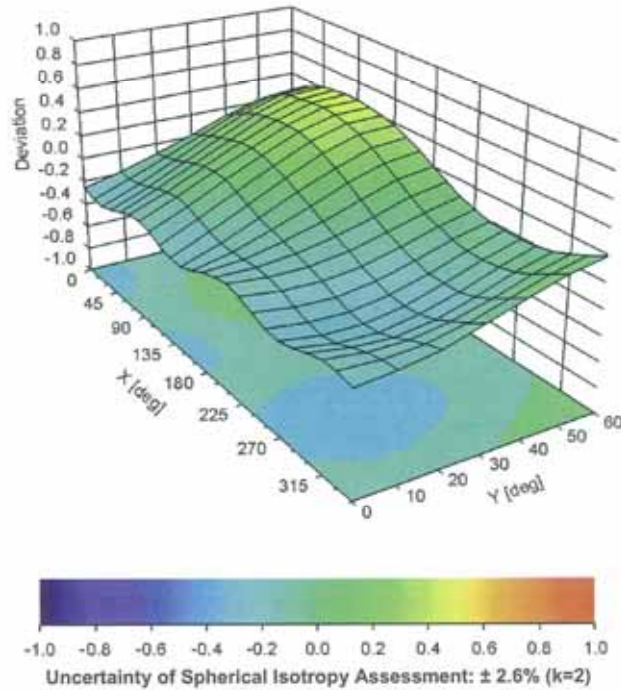

ET3DV6- SN:1609

September 23, 2013

DASY/EASY - Parameters of Probe: ET3DV6 - SN:1609**Other Probe Parameters**

Sensor Arrangement	Triangular
Connector Angle (°)	-105.5
Mechanical Surface Detection Mode	enabled
Optical Surface Detection Mode	disabled
Probe Overall Length	337 mm
Probe Body Diameter	10 mm
Tip Length	10 mm
Tip Diameter	6.8 mm
Probe Tip to Sensor X Calibration Point	2.7 mm
Probe Tip to Sensor Y Calibration Point	2.7 mm
Probe Tip to Sensor Z Calibration Point	2.7 mm
Recommended Measurement Distance from Surface	4 mm

Attachment 4. – Dipole Calibration Data

**Calibration Laboratory of
Schmid & Partner
Engineering AG**
Zeughausstrasse 43, 8004 Zurich, Switzerland



S Schweizerischer Kalibrierdienst
C Service suisse d'étalonnage
S Servizio svizzero di taratura
S Swiss Calibration Service

Accredited by the Swiss Accreditation Service (SAS)
The Swiss Accreditation Service is one of the signatories to the EA
Multilateral Agreement for the recognition of calibration certificates

Accreditation No.: **SCS 108**

Client **HCT (Dymstec)**

Certificate No: **D835V2-4d165_Jan14**

CALIBRATION CERTIFICATE

Object: **D835V2 - SN: 4d165**

Calibration procedure(s): **QA CAL-05.v9
Calibration procedure for dipole validation kits above 700 MHz**

Calibration date: **January 07, 2014**

This calibration certificate documents the traceability to national standards, which realize the physical units of measurements (SI).
The measurements and the uncertainties with confidence probability are given on the following pages and are part of the certificate.

All calibrations have been conducted in the closed laboratory facility: environment temperature (22 ± 3)°C and humidity < 70%.

Calibration Equipment used (M&TE critical for calibration)

Primary Standards	ID #	Cal Date (Certificate No.)	Scheduled Calibration
Power meter EPM-442A	GB37480704	09-Oct-13 (No. 217-01827)	Oct-14
Power sensor HP 8481A	US37292783	09-Oct-13 (No. 217-01827)	Oct-14
Power sensor HP 8481A	MY41092317	09-Oct-13 (No. 217-01828)	Oct-14
Reference 20 dB Attenuator	SN: 5058 (20k)	04-Apr-13 (No. 217-01736)	Apr-14
Type-N mismatch combination	SN: 5047.3 / 06327	04-Apr-13 (No. 217-01739)	Apr-14
Reference Probe ES3DV3	SN: 3205	30-Dec-13 (No. ES3-3205_Dec13)	Dec-14
DAE4	SN: 601	25-Apr-13 (No. DAE4-601_Apr13)	Apr-14
Secondary Standards	ID #	Check Date (in house)	Scheduled Check
RF generator R&S SMT-06	100005	04-Aug-99 (in house check Oct-13)	In house check: Oct-16
Network Analyzer HP 8753E	US37390585 S4206	18-Oct-01 (in house check Oct-13)	In house check: Oct-14

	Name	Function	Signature
Calibrated by:	Jeton Kastrati	Laboratory Technician	
Approved by:	Katja Pokovic	Technical Manager	

Issued: January 9, 2014

This calibration certificate shall not be reproduced except in full without written approval of the laboratory.

**Calibration Laboratory of
Schmid & Partner
Engineering AG**
Zeughausstrasse 43, 8004 Zurich, Switzerland



S Schweizerischer Kalibrierdienst
C Service suisse d'étalonnage
S Servizio svizzero di taratura
S Swiss Calibration Service

Accredited by the Swiss Accreditation Service (SAS)
The Swiss Accreditation Service is one of the signatories to the EA
Multilateral Agreement for the recognition of calibration certificates

Accreditation No.: **SCS 108**

Glossary:

TSL	tissue simulating liquid
ConvF	sensitivity in TSL / NORM x,y,z
N/A	not applicable or not measured

Calibration is Performed According to the Following Standards:

- a) IEEE Std 1528-2013, "IEEE Recommended Practice for Determining the Peak Spatial-Averaged Specific Absorption Rate (SAR) in the Human Head from Wireless Communications Devices: Measurement Techniques", June 2013
- b) IEC 62209-1, "Procedure to measure the Specific Absorption Rate (SAR) for hand-held devices used in close proximity to the ear (frequency range of 300 MHz to 3 GHz)", February 2005
- c) KDB 865664, "SAR Measurement Requirements for 100 MHz to 6 GHz"

Additional Documentation:

- d) DASY4/5 System Handbook

Methods Applied and Interpretation of Parameters:

- *Measurement Conditions:* Further details are available from the Validation Report at the end of the certificate. All figures stated in the certificate are valid at the frequency indicated.
- *Antenna Parameters with TSL:* The dipole is mounted with the spacer to position its feed point exactly below the center marking of the flat phantom section, with the arms oriented parallel to the body axis.
- *Feed Point Impedance and Return Loss:* These parameters are measured with the dipole positioned under the liquid filled phantom. The impedance stated is transformed from the measurement at the SMA connector to the feed point. The Return Loss ensures low reflected power. No uncertainty required.
- *Electrical Delay:* One-way delay between the SMA connector and the antenna feed point. No uncertainty required.
- *SAR measured:* SAR measured at the stated antenna input power.
- *SAR normalized:* SAR as measured, normalized to an input power of 1 W at the antenna connector.
- *SAR for nominal TSL parameters:* The measured TSL parameters are used to calculate the nominal SAR result.

The reported uncertainty of measurement is stated as the standard uncertainty of measurement multiplied by the coverage factor k=2, which for a normal distribution corresponds to a coverage probability of approximately 95%.

Measurement Conditions

DASY system configuration, as far as not given on page 1.

DASY Version	DASY5	V52.8.7
Extrapolation	Advanced Extrapolation	
Phantom	Modular Flat Phantom	
Distance Dipole Center - TSL	15 mm	with Spacer
Zoom Scan Resolution	dx, dy, dz = 5 mm	
Frequency	835 MHz ± 1 MHz	

Head TSL parameters

The following parameters and calculations were applied.

	Temperature	Permittivity	Conductivity
Nominal Head TSL parameters	22.0 °C	41.5	0.90 mho/m
Measured Head TSL parameters	(22.0 ± 0.2) °C	40.7 ± 6 %	0.91 mho/m ± 6 %
Head TSL temperature change during test	< 0.5 °C	----	----

SAR result with Head TSL

SAR averaged over 1 cm ³ (1 g) of Head TSL	Condition	
SAR measured	250 mW input power	2.34 W/kg
SAR for nominal Head TSL parameters	normalized to 1W	9.24 W/kg ± 17.0 % (k=2)

SAR averaged over 10 cm ³ (10 g) of Head TSL	condition	
SAR measured	250 mW input power	1.52 W/kg
SAR for nominal Head TSL parameters	normalized to 1W	6.02 W/kg ± 16.5 % (k=2)

Body TSL parameters

The following parameters and calculations were applied.

	Temperature	Permittivity	Conductivity
Nominal Body TSL parameters	22.0 °C	55.2	0.97 mho/m
Measured Body TSL parameters	(22.0 ± 0.2) °C	56.8 ± 6 %	1.01 mho/m ± 6 %
Body TSL temperature change during test	< 0.5 °C	----	----

SAR result with Body TSL

SAR averaged over 1 cm ³ (1 g) of Body TSL	Condition	
SAR measured	250 mW input power	2.46 W/kg
SAR for nominal Body TSL parameters	normalized to 1W	9.58 W/kg ± 17.0 % (k=2)

SAR averaged over 10 cm ³ (10 g) of Body TSL	condition	
SAR measured	250 mW input power	1.60 W/kg
SAR for nominal Body TSL parameters	normalized to 1W	6.26 W/kg ± 16.5 % (k=2)

Appendix

Antenna Parameters with Head TSL

Impedance, transformed to feed point	50.6 Ω - 3.8 $j\Omega$
Return Loss	- 28.4 dB

Antenna Parameters with Body TSL

Impedance, transformed to feed point	47.2 Ω - 5.7 $j\Omega$
Return Loss	- 23.7 dB

General Antenna Parameters and Design

Electrical Delay (one direction)	1.440 ns
----------------------------------	----------

After long term use with 100W radiated power, only a slight warming of the dipole near the feedpoint can be measured.

The dipole is made of standard semirigid coaxial cable. The center conductor of the feeding line is directly connected to the second arm of the dipole. The antenna is therefore short-circuited for DC-signals. On some of the dipoles, small end caps are added to the dipole arms in order to improve matching when loaded according to the position as explained in the "Measurement Conditions" paragraph. The SAR data are not affected by this change. The overall dipole length is still according to the Standard.

No excessive force must be applied to the dipole arms, because they might bend or the soldered connections near the feedpoint may be damaged.

Additional EUT Data

Manufactured by	SPEAG
Manufactured on	December 28, 2012

DASY5 Validation Report for Head TSL

Date: 07.01.2014

Test Laboratory: SPEAG, Zurich, Switzerland

DUT: Dipole 835 MHz; Type: D835V2; Serial: D835V2 - SN: 4d165

Communication System: UID 0 - CW; Frequency: 835 MHz

Medium parameters used: $f = 835$ MHz; $\sigma = 0.91$ S/m; $\epsilon_r = 40.7$; $\rho = 1000$ kg/m³

Phantom section: Flat Section

Measurement Standard: DASY5 (IEEE/IEC/ANSI C63.19-2007)

DASY52 Configuration:

- Probe: ES3DV3 - SN3205; ConvF(6.22, 6.22, 6.22); Calibrated: 30.12.2013;
- Sensor-Surface: 3mm (Mechanical Surface Detection)
- Electronics: DAE4 Sn601; Calibrated: 25.04.2013
- Phantom: Flat Phantom 4.9L; Type: QD000P49AA; Serial: 1001
- DASY52 52.8.7(1137); SEMCAD X 14.6.10(7164)

Dipole Calibration for Head Tissue/Pin=250 mW, d=15mm/Zoom Scan (7x7x7)/Cube 0:

Measurement grid: dx=5mm, dy=5mm, dz=5mm

Reference Value = 60.874 V/m; Power Drift = -0.00 dB

Peak SAR (extrapolated) = 3.54 W/kg

SAR(1 g) = 2.34 W/kg; SAR(10 g) = 1.52 W/kg

Maximum value of SAR (measured) = 2.73 W/kg

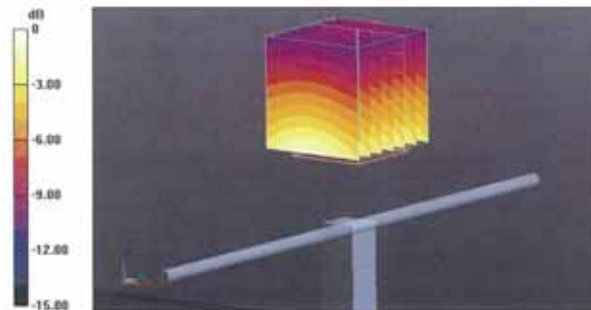

0 dB = 2.73 W/kg = 4.36 dBW/kg

Impedance Measurement Plot for Head TSL

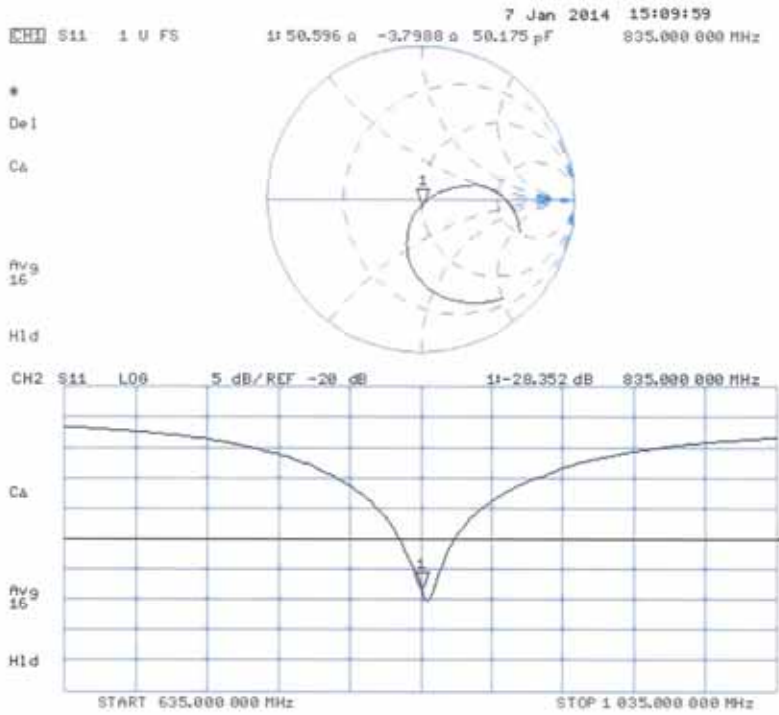

DASY5 Validation Report for Body TSL

Date: 07.01.2014

Test Laboratory: SPEAG, Zurich, Switzerland

DUT: Dipole 835 MHz; Type: D835V2; Serial: D835V2 - SN: 4d165

Communication System: UID 0 - CW; Frequency: 835 MHz

Medium parameters used: $f = 835$ MHz; $\sigma = 1.013$ S/m; $\epsilon_r = 56.8$; $\rho = 1000$ kg/m³

Phantom section: Flat Section

Measurement Standard: DASY5 (IEEE/IEC/ANSI C63.19-2007)

DASY52 Configuration:

- Probe: ES3DV3 - SN3205; ConvF(6.09, 6.09, 6.09); Calibrated: 30.12.2013;
- Sensor-Surface: 3mm (Mechanical Surface Detection)
- Electronics: DAE4 Sn601; Calibrated: 25.04.2013
- Phantom: Flat Phantom 4.9L; Type: QD000P49AA; Serial: 1001
- DASY52 52.8.7(1137); SEMCAD X 14.6.10(7164)

Dipole Calibration for Body Tissue/Pin=250 mW, d=15mm/Zoom Scan (7x7x7)/Cube 0:

Measurement grid: dx=5mm, dy=5mm, dz=5mm

Reference Value = 60.874 V/m; Power Drift = -0.00 dB

Peak SAR (extrapolated) = 3.66 W/kg

SAR(1 g) = 2.46 W/kg; SAR(10 g) = 1.6 W/kg

Maximum value of SAR (measured) = 2.86 W/kg

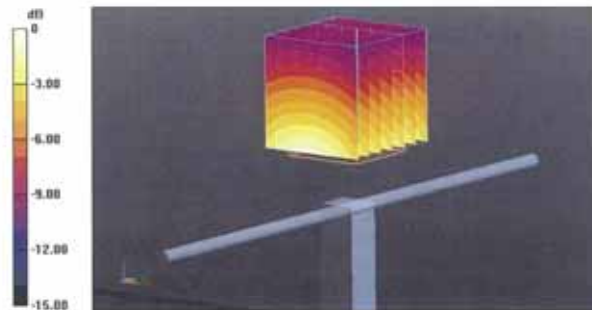

0 dB = 2.86 W/kg = 4.56 dBW/kg

Impedance Measurement Plot for Body TSL

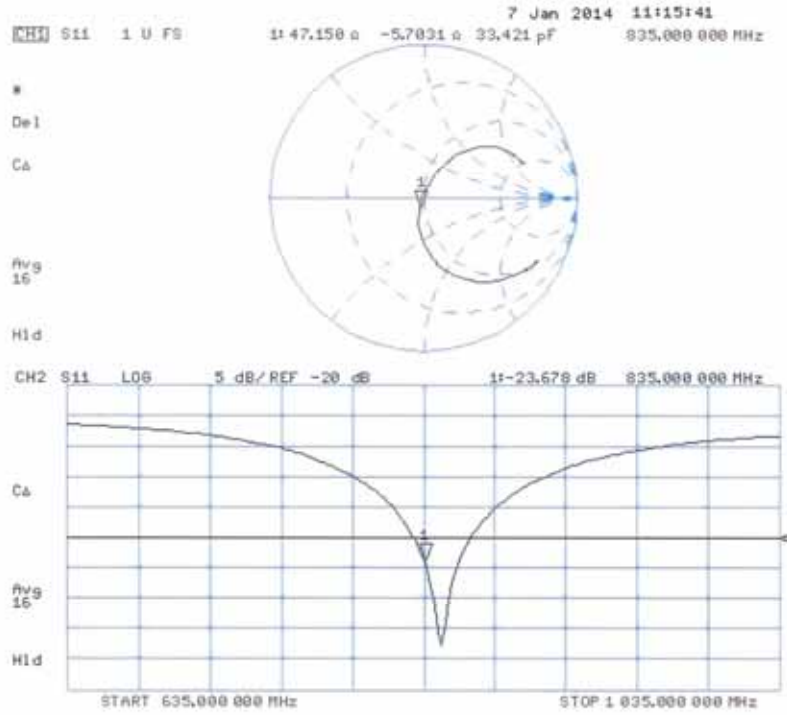

**Calibration Laboratory of
Schmid & Partner
Engineering AG**
Zeughausstrasse 43, 8004 Zurich, Switzerland



S Schweizerischer Kalibrierdienst
C Service suisse d'étalonnage
S Servizio svizzero di taratura
S Swiss Calibration Service

Accredited by the Swiss Accreditation Service (SAS)
The Swiss Accreditation Service is one of the signatories to the EA
Multilateral Agreement for the recognition of calibration certificates

Accreditation No.: **SCS 108**

Client **HCT (Dymstec)**

Certificate No: **D1900V2-5d032_Jul13**

CALIBRATION CERTIFICATE

Object **D1900V2 - SN: 5d032**

Calibration procedure(s) **QA CAL-05.v9
Calibration procedure for dipole validation kits above 700 MHz**

Calibration date: **July 29, 2013**

This calibration certificate documents the traceability to national standards, which realize the physical units of measurements (SI).
The measurements and the uncertainties with confidence probability are given on the following pages and are part of the certificate.

All calibrations have been conducted in the closed laboratory facility: environment temperature (22 ± 3)°C and humidity < 70%.

Calibration Equipment used (M&TE critical for calibration)

Primary Standards	ID #	Cal Date (Certificate No.)	Scheduled Calibration
Power meter EPM-442A	GB37480704	01-Nov-12 (No. 217-01640)	Oct-13
Power sensor HP 8481A	US37292783	01-Nov-12 (No. 217-01640)	Oct-13
Reference 20 dB Attenuator	SN: 5058 (20k)	04-Apr-13 (No. 217-01736)	Apr-14
Type-N mismatch combination	SN: 5047.3 / 06327	04-Apr-13 (No. 217-01739)	Apr-14
Reference Probe ES3DV3	SN: 3205	28-Dec-12 (No. ES3-3205_Dec12)	Dec-13
DAE4	SN: 601	25-Apr-13 (No. DAE4-601_Apr13)	Apr-14
Secondary Standards	ID #	Check Date (in house)	Scheduled Check
Power sensor HP 8481A	MY41092317	18-Oct-02 (in house check Oct-11)	In house check: Oct-13
RF generator R&S SMT-06	100005	04-Aug-99 (in house check Oct-11)	In house check: Oct-13
Network Analyzer HP 8753E	US37390585 S4206	18-Oct-01 (in house check Oct-12)	In house check: Oct-13

	Name	Function	Signature
Calibrated by:	Israe El-Naouq	Laboratory Technician	<i>Israe El-Naouq</i>
Approved by:	Katja Pokovic	Technical Manager	<i>Katja Pokovic</i>

Issued: July 30, 2013

This calibration certificate shall not be reproduced except in full without written approval of the laboratory.

**Calibration Laboratory of
Schmid & Partner
Engineering AG**
Zeughausstrasse 43, 8004 Zurich, Switzerland



S Schweizerischer Kalibrierdienst
S Service suisse d'étalonnage
C Servizio svizzero di taratura
S Swiss Calibration Service

Accredited by the Swiss Accreditation Service (SAS)
The Swiss Accreditation Service is one of the signatories to the EA
Multilateral Agreement for the recognition of calibration certificates

Accreditation No.: **SCS 108**

Glossary:

TSL tissue simulating liquid
ConvF sensitivity in TSL / NORM x,y,z
N/A not applicable or not measured

Calibration is Performed According to the Following Standards:

- a) IEEE Std 1528-2003, "IEEE Recommended Practice for Determining the Peak Spatial-Averaged Specific Absorption Rate (SAR) in the Human Head from Wireless Communications Devices: Measurement Techniques", December 2003
- b) IEC 62209-1, "Procedure to measure the Specific Absorption Rate (SAR) for hand-held devices used in close proximity to the ear (frequency range of 300 MHz to 3 GHz)", February 2005
- c) Federal Communications Commission Office of Engineering & Technology (FCC OET), "Evaluating Compliance with FCC Guidelines for Human Exposure to Radiofrequency Electromagnetic Fields; Additional Information for Evaluating Compliance of Mobile and Portable Devices with FCC Limits for Human Exposure to Radiofrequency Emissions", Supplement C (Edition 01-01) to Bulletin 65

Additional Documentation:

- d) DASY4/5 System Handbook

Methods Applied and Interpretation of Parameters:

- *Measurement Conditions:* Further details are available from the Validation Report at the end of the certificate. All figures stated in the certificate are valid at the frequency indicated.
- *Antenna Parameters with TSL:* The dipole is mounted with the spacer to position its feed point exactly below the center marking of the flat phantom section, with the arms oriented parallel to the body axis.
- *Feed Point Impedance and Return Loss:* These parameters are measured with the dipole positioned under the liquid filled phantom. The impedance stated is transformed from the measurement at the SMA connector to the feed point. The Return Loss ensures low reflected power. No uncertainty required.
- *Electrical Delay:* One-way delay between the SMA connector and the antenna feed point. No uncertainty required.
- *SAR measured:* SAR measured at the stated antenna input power.
- *SAR normalized:* SAR as measured, normalized to an input power of 1 W at the antenna connector.
- *SAR for nominal TSL parameters:* The measured TSL parameters are used to calculate the nominal SAR result.

The reported uncertainty of measurement is stated as the standard uncertainty of measurement multiplied by the coverage factor $k=2$, which for a normal distribution corresponds to a coverage probability of approximately 95%.

Measurement Conditions

DASY system configuration, as far as not given on page 1.

DASY Version	DASY5	V52.8.7
Extrapolation	Advanced Extrapolation	
Phantom	Modular Flat Phantom	
Distance Dipole Center - TSL	10 mm	with Spacer
Zoom Scan Resolution	dx, dy, dz = 5 mm	
Frequency	1900 MHz ± 1 MHz	

Head TSL parameters

The following parameters and calculations were applied.

	Temperature	Permittivity	Conductivity
Nominal Head TSL parameters	22.0 °C	40.0	1.40 mho/m
Measured Head TSL parameters	(22.0 ± 0.2) °C	38.9 ± 6 %	1.36 mho/m ± 6 %
Head TSL temperature change during test	< 0.5 °C	----	----

SAR result with Head TSL

SAR averaged over 1 cm ³ (1 g) of Head TSL	Condition	
SAR measured	250 mW input power	9.91 W/kg
SAR for nominal Head TSL parameters	normalized to 1W	40.1 W/kg ± 17.0 % (k=2)

SAR averaged over 10 cm ³ (10 g) of Head TSL	condition	
SAR measured	250 mW input power	5.21 W/kg
SAR for nominal Head TSL parameters	normalized to 1W	21.0 W/kg ± 16.5 % (k=2)

Body TSL parameters

The following parameters and calculations were applied.

	Temperature	Permittivity	Conductivity
Nominal Body TSL parameters	22.0 °C	53.3	1.52 mho/m
Measured Body TSL parameters	(22.0 ± 0.2) °C	53.4 ± 6 %	1.49 mho/m ± 6 %
Body TSL temperature change during test	< 0.5 °C	----	----

SAR result with Body TSL

SAR averaged over 1 cm ³ (1 g) of Body TSL	Condition	
SAR measured	250 mW input power	10.0 W/kg
SAR for nominal Body TSL parameters	normalized to 1W	40.5 W/kg ± 17.0 % (k=2)

SAR averaged over 10 cm ³ (10 g) of Body TSL	condition	
SAR measured	250 mW input power	5.34 W/kg
SAR for nominal Body TSL parameters	normalized to 1W	21.5 W/kg ± 16.5 % (k=2)

Appendix

Antenna Parameters with Head TSL

Impedance, transformed to feed point	51.1 Ω + 5.3 j Ω
Return Loss	- 25.5 dB

Antenna Parameters with Body TSL

Impedance, transformed to feed point	46.8 Ω + 5.4 j Ω
Return Loss	- 23.7 dB

General Antenna Parameters and Design

Electrical Delay (one direction)	1.193 ns
----------------------------------	----------

After long term use with 100W radiated power, only a slight warming of the dipole near the feedpoint can be measured.

The dipole is made of standard semirigid coaxial cable. The center conductor of the feeding line is directly connected to the second arm of the dipole. The antenna is therefore short-circuited for DC-signals. On some of the dipoles, small end caps are added to the dipole arms in order to improve matching when loaded according to the position as explained in the "Measurement Conditions" paragraph. The SAR data are not affected by this change. The overall dipole length is still according to the Standard.

No excessive force must be applied to the dipole arms, because they might bend or the soldered connections near the feedpoint may be damaged.

Additional EUT Data

Manufactured by	SPEAG
Manufactured on	March 17, 2003

DASY5 Validation Report for Head TSL

Date: 29.07.2013

Test Laboratory: SPEAG, Zurich, Switzerland

DUT: Dipole 1900 MHz; Type: D1900V2; Serial: D1900V2 - SN: 5d032

Communication System: UID 0 - CW; Frequency: 1900 MHz
 Medium parameters used: $f = 1900$ MHz; $\sigma = 1.36$ S/m; $\epsilon_r = 38.9$; $\rho = 1000$ kg/m³
 Phantom section: Flat Section
 Measurement Standard: DASY5 (IEEE/IEC/ANSI C63.19-2007)

DASY52 Configuration:

- Probe: ES3DV3 - SN3205; ConvF(4.98, 4.98, 4.98); Calibrated: 28.12.2012;
- Sensor-Surface: 3mm (Mechanical Surface Detection)
- Electronics: DAE4 Sn601; Calibrated: 25.04.2013
- Phantom: Flat Phantom 5.0 (front); Type: QD000P50AA; Serial: 1001
- DASY52 52.8.7(1137); SEMCAD X 14.6.10(7164)

Dipole Calibration for Head Tissue/Pin=250 mW, d=10mm/Zoom Scan (7x7x7)/Cube 0:

Measurement grid: dx=5mm, dy=5mm, dz=5mm
 Reference Value = 96.191 V/m; Power Drift = 0.04 dB
 Peak SAR (extrapolated) = 17.9 W/kg
SAR(1 g) = 9.91 W/kg; SAR(10 g) = 5.21 W/kg
 Maximum value of SAR (measured) = 12.3 W/kg

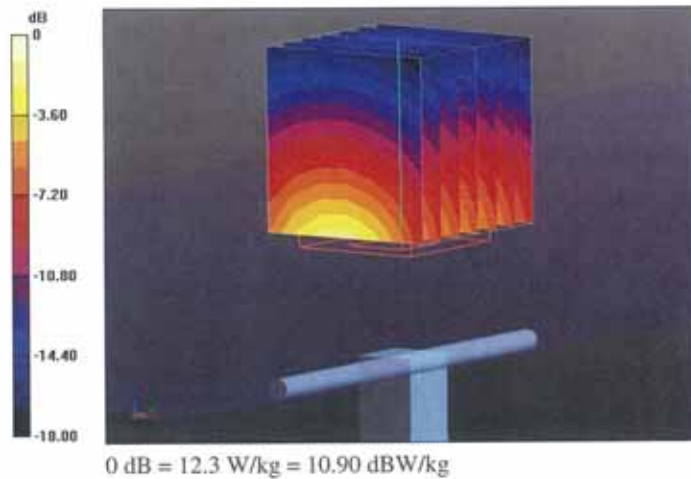

Impedance Measurement Plot for Head TSL

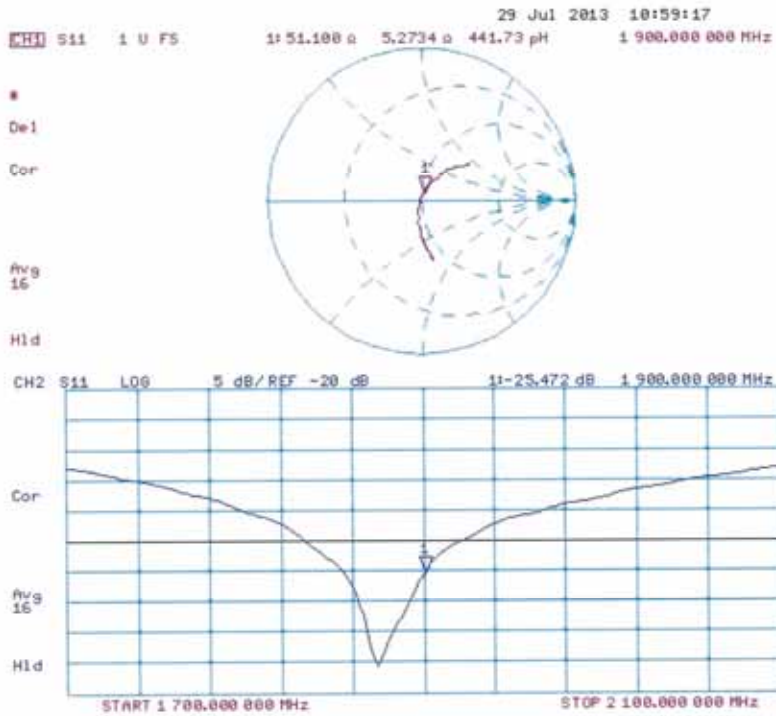

DASY5 Validation Report for Body TSL

Date: 29.07.2013

Test Laboratory: SPEAG, Zurich, Switzerland

DUT: Dipole 1900 MHz; Type: D1900V2; Serial: D1900V2 - SN: 5d032

Communication System: UID 0 - CW; Frequency: 1900 MHz

Medium parameters used: $f = 1900$ MHz; $\sigma = 1.49$ S/m; $\epsilon_r = 53.4$; $\rho = 1000$ kg/m³

Phantom section: Flat Section

Measurement Standard: DASY5 (IEEE/IEC/ANSI C63.19-2007)

DASY52 Configuration:

- Probe: ES3DV3 - SN3205; ConvF(4.6, 4.6, 4.6); Calibrated: 28.12.2012;
- Sensor-Surface: 3mm (Mechanical Surface Detection)
- Electronics: DAE4 Sn601; Calibrated: 25.04.2013
- Phantom: Flat Phantom 5.0 (back); Type: QD000P50AA; Serial: 1002
- DASY52 52.8.7(1137); SEMCAD X 14.6.10(7164)

Dipole Calibration for Body Tissue/Pin=250 mW, d=10mm/Zoom Scan (7x7x7)/Cube 0:

Measurement grid: dx=5mm, dy=5mm, dz=5mm

Reference Value = 96.191 V/m; Power Drift = 0.01 dB

Peak SAR (extrapolated) = 17.1 W/kg

SAR(1 g) = 10 W/kg; SAR(10 g) = 5.34 W/kg

Maximum value of SAR (measured) = 12.6 W/kg

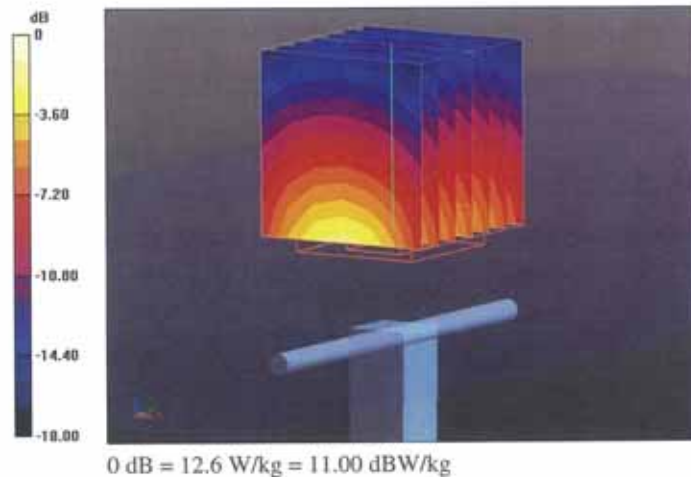

Impedance Measurement Plot for Body TSL

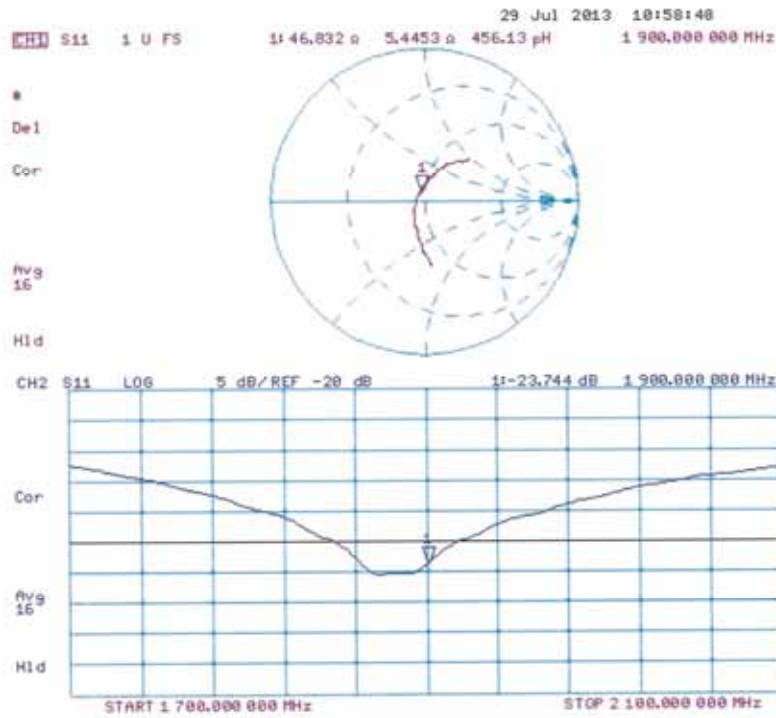

**Calibration Laboratory of
Schmid & Partner
Engineering AG**
Zeughausstrasse 43, 8004 Zurich, Switzerland



S Schweizerischer Kalibrierdienst
C Service suisse d'étalonnage
S Servizio svizzero di taratura
S Swiss Calibration Service

Accredited by the Swiss Accreditation Service (SAS)
The Swiss Accreditation Service is one of the signatories to the EA
Multilateral Agreement for the recognition of calibration certificates

Accreditation No.: **SCS 108**

Client **HCT (Dymstec)**

Certificate No: **D2450V2-743_Aug13**

CALIBRATION CERTIFICATE

Object: **D2450V2 - SN: 743**

Calibration procedure(s): **QA CAL-05.v9
Calibration procedure for dipole validation kits above 700 MHz**

Calibration date: **August 23, 2013**

This calibration certificate documents the traceability to national standards, which realize the physical units of measurements (SI).
The measurements and the uncertainties with confidence probability are given on the following pages and are part of the certificate.

All calibrations have been conducted in the closed laboratory facility; environment temperature (22 ± 3)°C and humidity < 70%.

Calibration Equipment used (M&TE critical for calibration)

Primary Standards	ID #	Cal Date (Certificate No.)	Scheduled Calibration
Power meter EPM-442A	GB37480704	01-Nov-12 (No. 217-01640)	Oct-13
Power sensor HP 8481A	US37292783	01-Nov-12 (No. 217-01640)	Oct-13
Reference 20 dB Attenuator	SN: 5058 (20k)	04-Apr-13 (No. 217-01736)	Apr-14
Type-N mismatch combination	SN: 5047.3 / 06327	04-Apr-13 (No. 217-01739)	Apr-14
Reference Probe ES3DV3	SN: 3205	28-Dec-12 (No. ES3-3205_Dec12)	Dec-13
DAE4	SN: 601	25-Apr-13 (No. DAE4-601_Apr13)	Apr-14
Secondary Standards	ID #	Check Date (in house)	Scheduled Check
Power sensor HP 8481A	MY41092317	18-Oct-02 (in house check Oct-11)	In house check: Oct-13
RF generator R&S SMT-06	100005	04-Aug-99 (in house check Oct-11)	In house check: Oct-13
Network Analyzer HP 8753E	US37390585 S4206	18-Oct-01 (in house check Oct-12)	In house check: Oct-13

	Name	Function	Signature
Calibrated by:	Jeton Kastrati	Laboratory Technician	
Approved by:	Katja Pokpovic	Technical Manager	

Issued: August 23, 2013

This calibration certificate shall not be reproduced except in full without written approval of the laboratory.

**Calibration Laboratory of
Schmid & Partner
Engineering AG**
Zeughausstrasse 43, 8004 Zurich, Switzerland



S Schweizerischer Kalibrierdienst
C Service suisse d'étalonnage
S Servizio svizzero di taratura
S Swiss Calibration Service

Accredited by the Swiss Accreditation Service (SAS)
The Swiss Accreditation Service is one of the signatories to the EA
Multilateral Agreement for the recognition of calibration certificates

Accreditation No.: **SCS 108**

Glossary:

TSL tissue simulating liquid
ConvF sensitivity in TSL / NORM x,y,z
N/A not applicable or not measured

Calibration is Performed According to the Following Standards:

- a) IEEE Std 1528-2003, "IEEE Recommended Practice for Determining the Peak Spatial-Averaged Specific Absorption Rate (SAR) in the Human Head from Wireless Communications Devices: Measurement Techniques", December 2003
- b) IEC 62209-1, "Procedure to measure the Specific Absorption Rate (SAR) for hand-held devices used in close proximity to the ear (frequency range of 300 MHz to 3 GHz)", February 2005
- c) KDB 865664, "SAR Measurement Requirements for 100 MHz to 6 GHz"

Additional Documentation:

- d) DASY4/5 System Handbook

Methods Applied and Interpretation of Parameters:

- *Measurement Conditions:* Further details are available from the Validation Report at the end of the certificate. All figures stated in the certificate are valid at the frequency indicated.
- *Antenna Parameters with TSL:* The dipole is mounted with the spacer to position its feed point exactly below the center marking of the flat phantom section, with the arms oriented parallel to the body axis.
- *Feed Point Impedance and Return Loss:* These parameters are measured with the dipole positioned under the liquid filled phantom. The impedance stated is transformed from the measurement at the SMA connector to the feed point. The Return Loss ensures low reflected power. No uncertainty required.
- *Electrical Delay:* One-way delay between the SMA connector and the antenna feed point. No uncertainty required.
- *SAR measured:* SAR measured at the stated antenna input power.
- *SAR normalized:* SAR as measured, normalized to an input power of 1 W at the antenna connector.
- *SAR for nominal TSL parameters:* The measured TSL parameters are used to calculate the nominal SAR result.

The reported uncertainty of measurement is stated as the standard uncertainty of measurement multiplied by the coverage factor k=2, which for a normal distribution corresponds to a coverage probability of approximately 95%.

Measurement Conditions

DASY system configuration, as far as not given on page 1.

DASY Version	DASY5	V52.8.7
Extrapolation	Advanced Extrapolation	
Phantom	Modular Flat Phantom	
Distance Dipole Center - TSL	10 mm	with Spacer
Zoom Scan Resolution	dx, dy, dz = 5 mm	
Frequency	2450 MHz ± 1 MHz	

Head TSL parameters

The following parameters and calculations were applied.

	Temperature	Permittivity	Conductivity
Nominal Head TSL parameters	22.0 °C	39.2	1.80 mho/m
Measured Head TSL parameters	(22.0 ± 0.2) °C	37.8 ± 6 %	1.80 mho/m ± 6 %
Head TSL temperature change during test	< 0.5 °C	----	----

SAR result with Head TSL

SAR averaged over 1 cm ³ (1 g) of Head TSL	Condition	
SAR measured	250 mW input power	13.3 W/kg
SAR for nominal Head TSL parameters	normalized to 1W	52.8 W/kg ± 17.0 % (k=2)

SAR averaged over 10 cm ³ (10 g) of Head TSL	condition	
SAR measured	250 mW input power	6.18 W/kg
SAR for nominal Head TSL parameters	normalized to 1W	24.6 W/kg ± 16.5 % (k=2)

Body TSL parameters

The following parameters and calculations were applied.

	Temperature	Permittivity	Conductivity
Nominal Body TSL parameters	22.0 °C	52.7	1.95 mho/m
Measured Body TSL parameters	(22.0 ± 0.2) °C	50.6 ± 6 %	2.03 mho/m ± 6 %
Body TSL temperature change during test	< 0.5 °C	----	----

SAR result with Body TSL

SAR averaged over 1 cm ³ (1 g) of Body TSL	Condition	
SAR measured	250 mW input power	13.0 W/kg
SAR for nominal Body TSL parameters	normalized to 1W	50.5 W/kg ± 17.0 % (k=2)

SAR averaged over 10 cm ³ (10 g) of Body TSL	condition	
SAR measured	250 mW input power	6.01 W/kg
SAR for nominal Body TSL parameters	normalized to 1W	23.6 W/kg ± 16.5 % (k=2)

Appendix

Antenna Parameters with Head TSL

Impedance, transformed to feed point	53.9 Ω + 4.2 j Ω
Return Loss	- 25.1 dB

Antenna Parameters with Body TSL

Impedance, transformed to feed point	50.0 Ω + 5.5 j Ω
Return Loss	- 25.2 dB

General Antenna Parameters and Design

Electrical Delay (one direction)	1.159 ns
----------------------------------	----------

After long term use with 100W radiated power, only a slight warming of the dipole near the feedpoint can be measured.

The dipole is made of standard semirigid coaxial cable. The center conductor of the feeding line is directly connected to the second arm of the dipole. The antenna is therefore short-circuited for DC-signals. On some of the dipoles, small end caps are added to the dipole arms in order to improve matching when loaded according to the position as explained in the "Measurement Conditions" paragraph. The SAR data are not affected by this change. The overall dipole length is still according to the Standard.

No excessive force must be applied to the dipole arms, because they might bend or the soldered connections near the feedpoint may be damaged.

Additional EUT Data

Manufactured by	SPEAG
Manufactured on	December 01, 2003

DASY5 Validation Report for Head TSL

Date: 22.08.2013

Test Laboratory: SPEAG, Zurich, Switzerland

DUT: Dipole 2450 MHz; Type: D2450V2; Serial: D2450V2 - SN: 743

Communication System: UID 0 - CW ; Frequency: 2450 MHz

Medium parameters used: $f = 2450$ MHz; $\sigma = 1.8$ S/m; $\epsilon_r = 37.8$; $\rho = 1000$ kg/m³

Phantom section: Flat Section

Measurement Standard: DASY5 (IEEE/IEC/ANSI C63.19-2007)

DASY52 Configuration:

- Probe: ES3DV3 - SN3205; ConvF(4.52, 4.52, 4.52); Calibrated: 28.12.2012;
- Sensor-Surface: 3mm (Mechanical Surface Detection)
- Electronics: DAE4 Sn601; Calibrated: 25.04.2013
- Phantom: Flat Phantom 5.0 (front); Type: QD000P50AA; Serial: 1001
- DASY52 52.8.7(1137); SEMCAD X 14.6.10(7164)

Dipole Calibration for Head Tissue/Pin=250 mW, d=10mm/Zoom Scan (7x7x7)/Cube 0:

Measurement grid: dx=5mm, dy=5mm, dz=5mm

Reference Value = 100.4 V/m; Power Drift = 0.06 dB

Peak SAR (extrapolated) = 27.8 W/kg

SAR(1 g) = 13.3 W/kg; SAR(10 g) = 6.18 W/kg

Maximum value of SAR (measured) = 16.9 W/kg

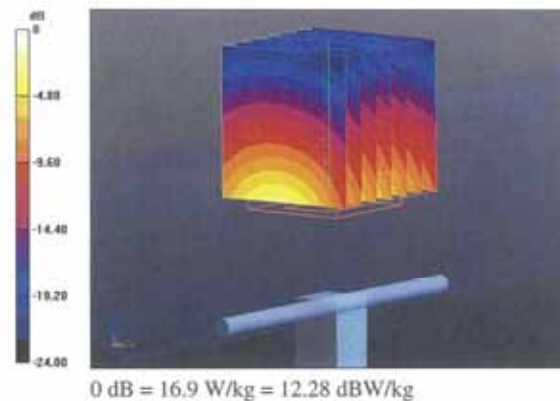

Impedance Measurement Plot for Head TSL

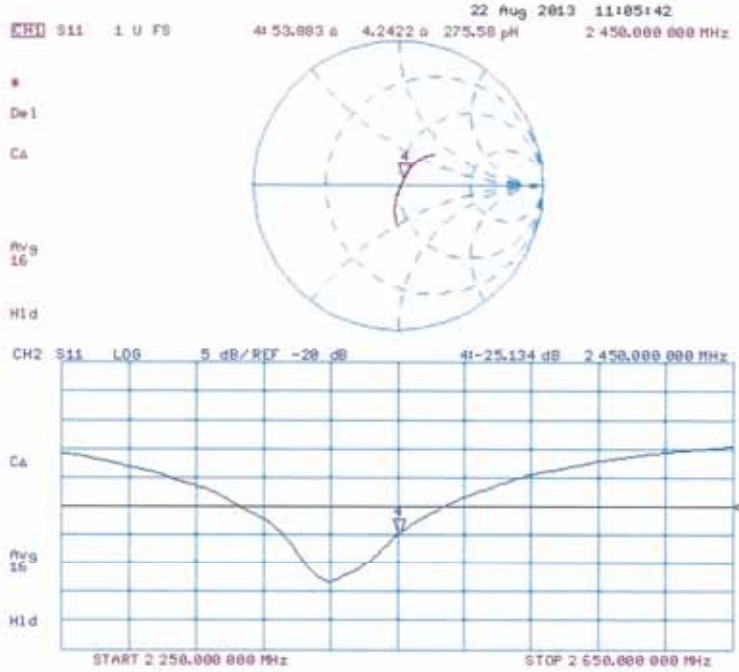

DASY5 Validation Report for Body TSL

Date: 23.08.2013

Test Laboratory: SPEAG, Zurich, Switzerland

DUT: Dipole 2450 MHz; Type: D2450V2; Serial: D2450V2 - SN: 743

Communication System: UID 0 - CW ; Frequency: 2450 MHz

Medium parameters used: $f = 2450$ MHz; $\sigma = 2.03$ S/m; $\epsilon_r = 50.6$; $\rho = 1000$ kg/m³

Phantom section: Flat Section

Measurement Standard: DASY5 (IEEE/IEC/ANSI C63.19-2007)

DASY52 Configuration:

- Probe: ES3DV3 - SN3205; ConvF(4.42, 4.42, 4.42); Calibrated: 28.12.2012;
- Sensor-Surface: 3mm (Mechanical Surface Detection)
- Electronics: DAE4 Sn601; Calibrated: 25.04.2013
- Phantom: Flat Phantom 5.0 (back); Type: QD000P50AA; Serial: 1002
- DASY52 52.8.7(1137); SEMCAD X 14.6.10(7164)

Dipole Calibration for Body Tissue/Pin=250 mW, d=10mm/Zoom Scan (7x7x7)/Cube 0:

Measurement grid: dx=5mm, dy=5mm, dz=5mm

Reference Value = 93.835 V/m; Power Drift = 0.06 dB

Peak SAR (extrapolated) = 27.3 W/kg

SAR(1 g) = 13 W/kg; SAR(10 g) = 6.01 W/kg

Maximum value of SAR (measured) = 16.8 W/kg

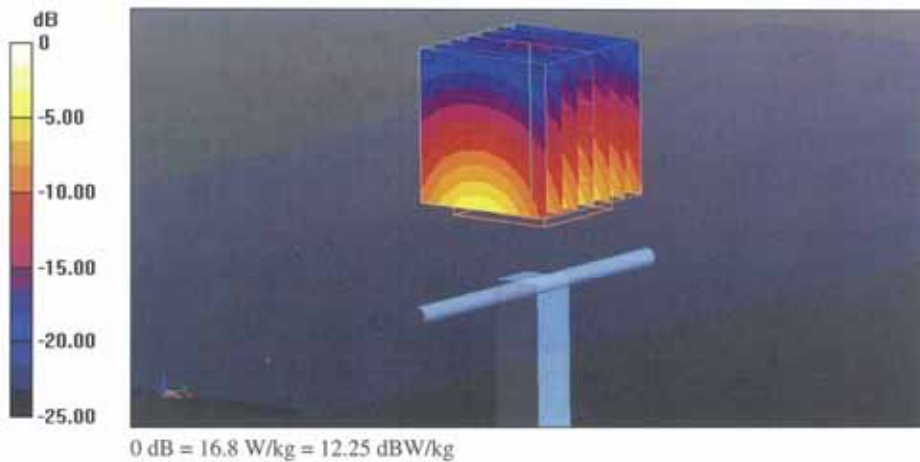

Impedance Measurement Plot for Body TSL

