

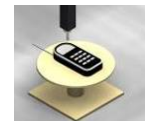

# PCTEST ENGINEERING LABORATORY, INC.

6660-B Dobbin Road, Columbia, MD 21045 USA  
Tel. 410.290.6652 / Fax 410.290.6554  
http://www.pctestlab.com



## HEARING AID COMPATIBILITY

**Applicant Name:**  
LG Electronics MobileComm U.S.A., Inc.  
10101 Old Grove Road,  
San Diego, CA 92131  
USA

**Date of Testing:**  
7/19/2011 - 7/20/2011  
**Test Site/Location:**  
PCTEST Lab, Columbia, MD, USA  
**Test Report Serial No.:**  
0Y1107081120.ZNF

**FCC ID:** ZNFAS680

**APPLICANT:** LG ELECTRONICS MOBILECOMM U.S.A., INC.

**Scope of Test:** Audio Band Magnetic Testing (T-Coil)  
**Application Type:** Certification  
**FCC Rule Part(s):** CFR § 20.19(b)  
**HAC Standard:** ANSI C63.19-2007 §6.3(v), §7.3(v)  
**EUT Type:** Cellular/PCS CDMA/EVDO Phone with BT and WLAN  
**Model(s):** AS680, LG-AS680  
**Tx Frequency:** 824.70 - 848.31 MHz (Cellular CDMA)  
1851.25 - 1908.75 MHz (PCS CDMA)  
**Test Device Serial No.:** Pre-Production Sample [S/N: T-Coil]

**C63.19-2007 HAC Category:** T3 (SIGNAL TO NOISE CATEGORY)

This wireless portable device has been shown to be hearing-aid compatible under the above rated category, specified in ANSI/IEEE Std. C63.19-2007 and had been tested in accordance with the specified measurement procedures. Hearing-Aid Compatibility is based on the assumption that all production units will be designed electrically identical to the device tested in this report. Test results reported herein relate only to the item(s) tested. For North American bands only.

I attest to the accuracy of data. All measurements reported herein were performed by me or were made under my supervision and are correct to the best of my knowledge and belief. I assume full responsibility for the completeness of these measurements and vouch for the qualifications of all persons taking them.

*PCTEST certifies that no party to this application has been subject to a denial of Federal benefits that includes FCC benefits pursuant to Section 5301 of the Anti-Drug Abuse Act of 1988, 21 U.S.C. 862.*

Randy Ortanez  
President





<b>FCC ID:</b> ZNFAS680		<b>HAC (T-COIL) TEST REPORT</b>		<b>Reviewed by:</b> Quality Manager
<b>Filename:</b> 0Y1107081120.ZNF	<b>Test Dates:</b> 7/19/2011 - 7/20/2011	<b>EUT Type:</b> Cellular/PCS CDMA/EVDO Phone with BT and WLAN		Page 1 of 37

# TABLE OF CONTENTS

---

1.	INTRODUCTION .....	3
2.	TEST SITE LOCATION .....	4
3.	EUT DESCRIPTION .....	5
4.	ANSI C63.19-2007 PERFORMANCE CATEGORIES .....	6
5.	METHOD OF MEASUREMENT .....	9
6.	TEST SUMMARY .....	19
7.	FCC 3G MEASUREMENTS .....	23
8.	MEASUREMENT UNCERTAINTY .....	24
9.	EQUIPMENT LIST .....	25
10.	CALIBRATION CERTIFICATES.....	26
11.	CONCLUSION.....	33
12.	REFERENCES .....	34
13.	TEST SETUP PHOTOGRAPHS .....	36

<b>FCC ID:</b> ZNFAS680		<b>HAC (T-COIL) TEST REPORT</b>		<b>Reviewed by:</b> Quality Manager
<b>Filename:</b> 0Y1107081120.ZNF	<b>Test Dates:</b> 7/19/2011 - 7/20/2011	<b>EUT Type:</b> Cellular/PCS CDMA/EVDO Phone with BT and WLAN		Page 2 of 37

# 1. INTRODUCTION

On July 10, 2003, the Federal Communications Commission (FCC) adopted new rules requiring wireless manufacturers and service providers to provide digital wireless phones that are compatible with hearing aids. The FCC has modified the exemption for wireless phones under the Hearing Aid Compatibility Act of 1998 (HAC Act) in WT Docket 01-309 RM-8658<sup>1</sup> to extend the benefits of wireless telecommunications to individuals with hearing disabilities. These benefits encompass business, social and emergency communications, which increase the value of the wireless network for everyone. Approximately 500 million people worldwide and 30 million people in the United States suffer from hearing loss.

## Compatibility Tests Involved:

The standard calls for wireless communications devices to be measured for:

- RF Electric-field emissions
- RF Magnetic-field emissions
- T-coil mode, magnetic-signal strength in the audio band
- T-coil mode, magnetic-signal frequency response through the audio band
- T-coil mode, magnetic-signal and noise articulation index

The hearing aid must be measured for:



- RF immunity in microphone mode
- RF immunity in T-coil mode

In the following tests and results, this report includes the evaluation for a wireless communications device.



Figure 1-1 Hearing Aid *in-vitu*

<sup>1</sup> FCC Rule & Order, WT Docket 01-309 RM-8658

FCC ID: ZNFAS680		HAC (T-COIL) TEST REPORT		Reviewed by: Quality Manager
Filename: 0Y1107081120.ZNF	Test Dates: 7/19/2011 - 7/20/2011	EUT Type: Cellular/PCS CDMA/EVDO Phone with BT and WLAN	Page 3 of 37	

## 2. TEST SITE LOCATION

### I. Introduction

The map at the right shows the location of the PCTEST LABORATORY in Columbia, Maryland. It is in proximity to the FCC Laboratory, the Baltimore-Washington International (BWI) airport, the city of Baltimore and Washington, DC (See Figure 2-1).

These measurement tests were conducted at the PCTEST Engineering Laboratory, Inc. facility in New Concept Business Park, Guilford Industrial Park, Columbia, Maryland. The site address is 6660-B Dobbin Road, Columbia, MD 21045. The test site is one of the highest points in the Columbia area with an elevation of 390 feet above mean sea level. The site coordinates are 39° 11'15" N latitude and 76° 49' 38" W longitude. The facility is 1.5 miles north of the FCC laboratory, and the ambient signal and ambient signal strength are approximately equal to those of the FCC laboratory. There are no FM or TV transmitters within 15 miles of the site. The detailed description of the measurement facility was found to be in compliance with the requirements of § 2.948 according to ANSI C63.4-2003 on January 27, 2006 and Industry Canada.

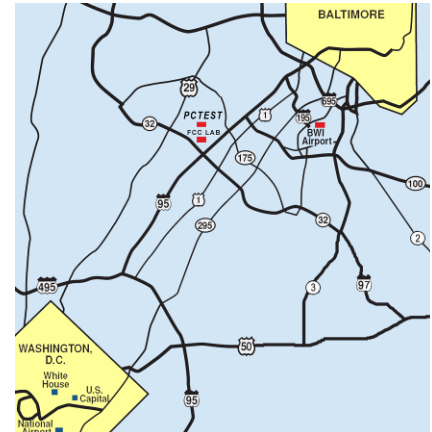



**Figure 2-1**  
**Map of the Greater Baltimore and Metropolitan Washington, D.C. Area**

### II. Test Facility / Accreditations:

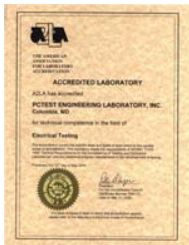
Measurements were performed at an independent accredited PCTEST Engineering Lab located in Columbia, MD 21045, U.S.A.



- PCTEST Lab is accredited to ISO 17025-2005 by the American Association for Laboratory Accreditation (A2LA) in Specific Absorption Rate (SAR) testing, Hearing-Aid Compatibility (HAC), CTIA Test Plans, and wireless testing for FCC and Industry Canada Rules.
- PCTEST Lab is accredited to ISO 17025 by U.S. National Institute of Standards and Technology (NIST) under the National Voluntary Laboratory Accreditation Program (NVLAP Lab code: 100431-0) in EMC, FCC and Telecommunications.
- PCTEST facility is an FCC registered (PCTEST Reg. No. 90864) test facility with the site description report on file and has met all the requirements specified in Section 2.948 of the FCC Rules and Industry Canada (IC-2451).
- PCTEST Lab is a recognized U.S. Conformity Assessment Body (CAB) in EMC and R&TTE (n.b. 0982) under the U.S.-EU Mutual Recognition Agreement (MRA).
- PCTEST TCB is a Telecommunication Certification Body (TCB) accredited to ISO/IEC Guide 65 by the American National Standards Institute (ANSI) in all scopes of FCC Rules and all Industry Canada Standards (RSS).
- PCTEST facility is an IC registered (IC-2451) test laboratory with the site description on file at Industry Canada.
- PCTEST is a CTIA Authorized Test Laboratory (CATL) for AMPS and CDMA, and EvDO mobile phones.
- PCTEST is a CTIA Authorized Test Laboratory (CATL) for Over-the-Air (OTA) Antenna Performance testing for AMPS, CDMA, GSM, GPRS, EGPRS, UMTS (W-CDMA), CDMA 1xEVDO Data, CDMA 1xRTT Data.

<b>FCC ID:</b> ZNFAS680		<b>HAC (T-COIL) TEST REPORT</b>		<b>Reviewed by:</b> Quality Manager
<b>Filename:</b> 0Y1107081120.ZNF	<b>Test Dates:</b> 7/19/2011 - 7/20/2011	<b>EUT Type:</b> Cellular/PCS CDMA/EVDO Phone with BT and WLAN	Page 4 of 37	

### 3. EUT DESCRIPTION



FCC ID: ZNFAS680  
 Applicant: LG Electronics MobileComm U.S.A., Inc.  
 10101 Old Grove Road,  
 San Diego, CA 92131  
 USA  
 Model(s): AS680, LG-AS680  
 Serial Number: T-Coil  
 Tx Frequencies: 824.70 - 848.31 MHz (Cellular CDMA)  
 1851.25 - 1908.75 MHz (PCS CDMA)  
 HW Version: GRI40  
 SW Version: AS680Z01  
 Maximum Conducted Power (EMC/SAR): 25.69 dBm (Cell. CDMA), 25.11 dBm (PCS CDMA)  
 Maximum Conducted Power (HAC): 25.64 dBm (Cell. CDMA), 25.08 dBm (PCS CDMA)  
 Antenna: Internal Antenna  
 HAC Test Configurations: Cell. CDMA, 1013, 384, 777, BT Off, WLAN Off  
 PCS CDMA, 25, 600, 1175, BT Off, WLAN Off  
 EUT Type: Cellular/PCS CDMA/EVDO Phone with BT and WLAN

Air-Interface	Band (MHz)	Type	C63.19/tested	Simultaneous Transmissions (Not to be tested)	Reduced power 20.19 (c)(1)	Voice Over Digital Transport (Data)
CDMA	850	Voice	Yes	Yes: BT or WIFI	N/A	N/A
	1900				N/A	N/A
	EVDO	Data	N/A		N/A	Yes
BT	2450	Data	N/A	Yes: CDMA	N/A	N/A
WIFI	2450	Data	N/A	Yes: CDMA	N/A	Yes

\* HAC Rating was not based on concurrent voice and data modes. Non current mode was found to represent worst case rating for both M and T rating.

**Table 3: ZNFAS680 Air Interfaces**

FCC ID: ZNFAS680	PCTEST	HAC (T-COIL) TEST REPORT	LG	Reviewed by: Quality Manager
Filename: 0Y1107081120.ZNF	Test Dates: 7/19/2011 - 7/20/2011	EUT Type: Cellular/PCS CDMA/EVDO Phone with BT and WLAN		Page 5 of 37

## 4. ANSI C63.19-2007 PERFORMANCE CATEGORIES



### I. RF EMISSIONS

The ANSI Standard presents performance requirements for acceptable interoperability of hearing aids with wireless communications devices. When these parameters are met, a hearing aid operates acceptably in close proximity to a wireless communications device.

Category	Telephone RF Parameters	
Near field Category	E-field emissions CW dB(V/m)	H-field emissions CW dB(A/m)
<b>f &lt; 960 MHz</b>		
<b>M1</b>	56 to 61 + 0.5 x AWF	5.6 to 10.6 +0.5 x AWF
<b>M2</b>	51 to 56 + 0.5 x AWF	0.6 to 5.6 +0.5 x AWF
<b>M3</b>	46 to 51 + 0.5 x AWF	-4.4 to 0.6 +0.5 x AWF
<b>M4</b>	< 46 + 0.5 x AWF	< -4.4 + 0.5 x AWF
<b>f &gt; 960 MHz</b>		
<b>M1</b>	46 to 51 + 0.5 x AWF	-4.4 to 0.6 +0.5 x AWF
<b>M2</b>	41 to 46 + 0.5 x AWF	-9.4 to -4.4 +0.5 x AWF
<b>M3</b>	36 to 41 + 0.5 x AWF	-14.4 to -9.4 +0.5 x AWF
<b>M4</b>	< 36 + 0.5 x AWF	< -14.4 + 0.5 x AWF
<b>Table 4-1</b> <b>Hearing aid and WD near-field categories</b> <b>as defined in ANSI C63.19-2007 [2]</b>		

### II. ARTICULATION WEIGHTING FACTOR (AWF)

Standard	Technology	Articulation Weighing Factor (AWF)
T1/T1P1/3GPP	UMTS (WCDMA)	0
TIA/EIA/IS-2000	CDMA	0
iDEN™	TDMA (22 and 11 Hz)	0
J-STD-007	GSM (217 Hz)	-5
<b>Table 4-2</b> <b>Articulation Weighting Factors</b>		

FCC ID: ZNFAS680		HAC (T-COIL) TEST REPORT		Reviewed by: Quality Manager
Filename: 0Y1107081120.ZNF	Test Dates: 7/19/2011 - 7/20/2011	EUT Type: Cellular/PCS CDMA/EVDO Phone with BT and WLAN		Page 6 of 37

### III. MAGNETIC COUPLING

#### Axial and Radial Field Intensity

All orientations of the magnetic field, in the axial, horizontal and vertical position along the measurement plane shall be  $\geq -18$  dB(A/m) at 1 kHz in a 1/3 octave band filter per 7.3.1.

#### Frequency Response

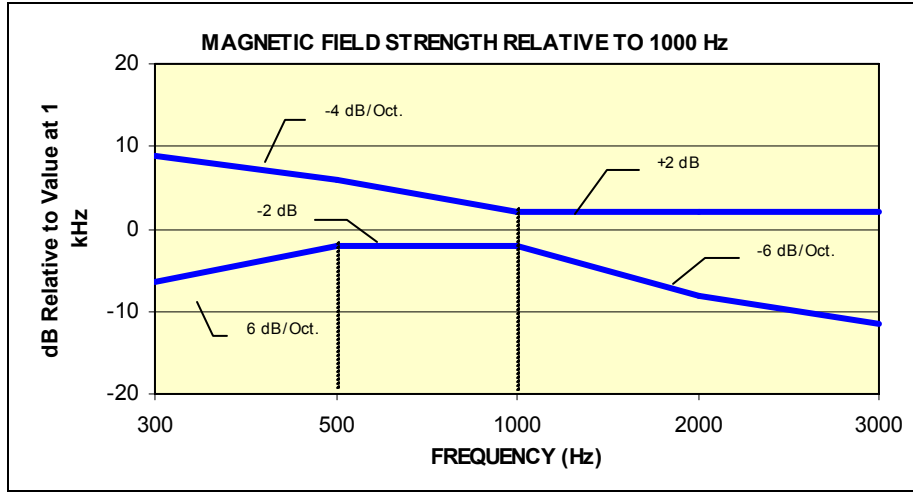

The frequency response of the axial component of the magnetic field shall follow the response curve specified in EIA RS-504-1983, over the frequency range 300 Hz – 3000 Hz per 7.3.2.

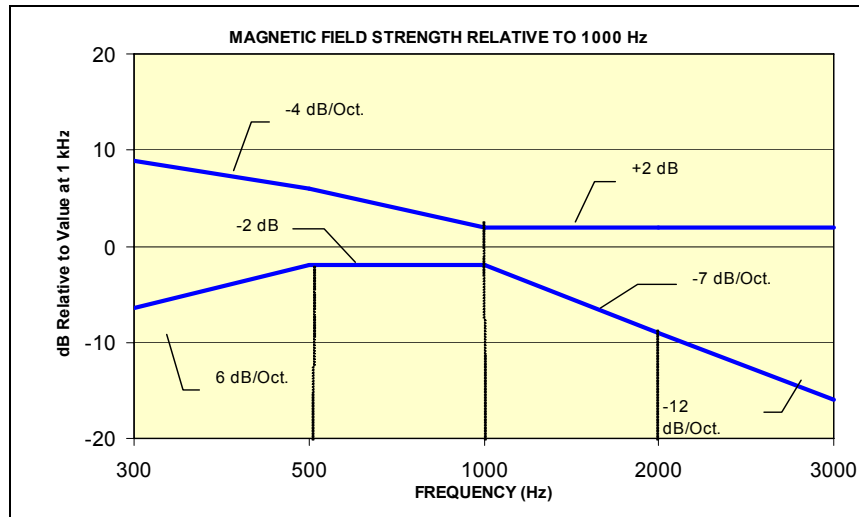

**Figure 4-1**  
Magnetic field frequency response for Wireless Devices with an axial field between  $\leq 15$  dB (A/m) at 1 kHz



**Figure 4-2**  
Magnetic Field frequency response for wireless devices with an axial field that exceeds  $-15$  dB(A/m) at 1 kHz

FCC ID: ZNFAS680		HAC (T-COIL) TEST REPORT		Reviewed by: Quality Manager
Filename: 0Y1107081120.ZNF	Test Dates: 7/19/2011 - 7/20/2011	EUT Type: Cellular/PCS CDMA/EVDO Phone with BT and WLAN		Page 7 of 37



## Signal Quality

The table below provides the signal quality requirement for the intended audio magnetic signal from a wireless device. Only the RF immunity of the hearing aid is measured in T-coil mode. It is assumed that a hearing aid can have no immunity to an interference signal in the audio band, which is the intended reception band for this mode. The only criterion that can be measured is the RF immunity in T-coil mode. This is measured using the same procedure as the audio coupling mode at the same levels.

The signal quality of the axial and radial components of the magnetic field was used to determine the T-coil mode category.

Category	Telephone RF Parameters
	Wireless Device Signal Quality (Signal + Noise-to-noise ratio in dB)
T1	0 to 10 dB
T2	10 to 20 dB
T3	20 to 30 dB
T4	> 30 dB

Table 4-3  
Magnetic Coupling Parameters

FCC ID: ZNFAS680	 PCTEST	HAC (T-COIL) TEST REPORT	 LG	Reviewed by: Quality Manager
Filename: 0Y1107081120.ZNF	Test Dates: 7/19/2011 - 7/20/2011	EUT Type: Cellular/PCS CDMA/EVDO Phone with BT and WLAN		Page 8 of 37



## 5. METHOD OF MEASUREMENT

### I. Test Setup

The equipment was connected as shown in an acoustic/RF hemi-anechoic chamber:

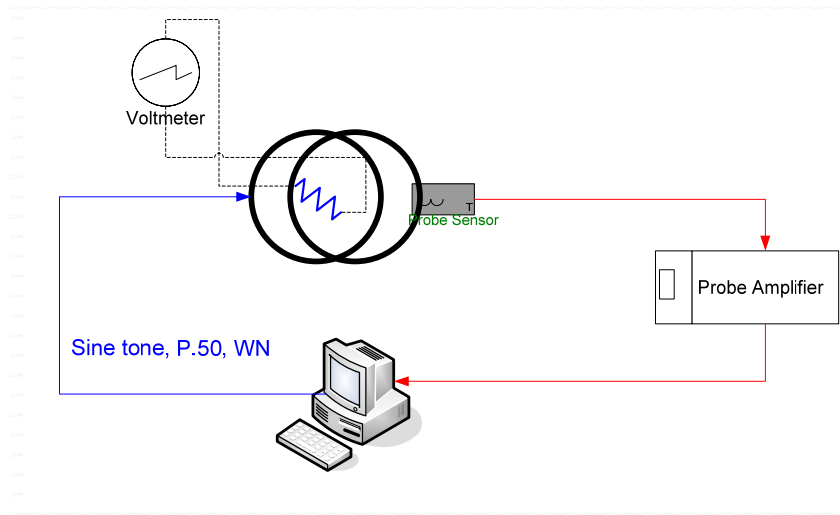

Figure 5-1 Validation Setup with Helmholtz Coil

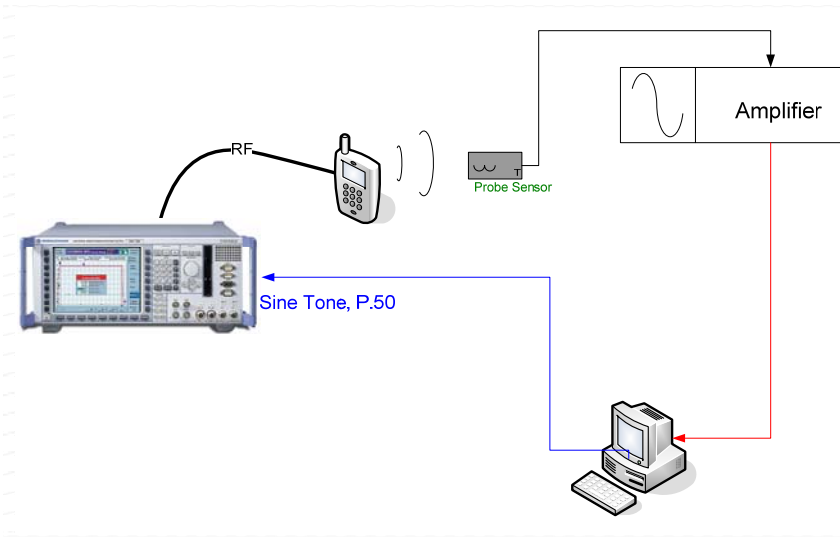

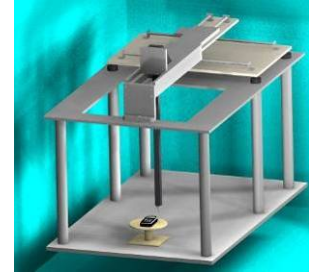

Figure 5-2 T-Coil Test Setup

FCC ID: ZNFAS680		HAC (T-COIL) TEST REPORT		Reviewed by: Quality Manager
Filename: 0Y1107081120.ZNF	Test Dates: 7/19/2011 - 7/20/2011	EUT Type: Cellular/PCS CDMA/EVDO Phone with BT and WLAN		Page 9 of 37

## II. Scanning Mechanism

Manufacturer: TEM  
 Accuracy:  $\pm 0.83$  cm/meter  
 Minimum Step Size: 0.1 mm  
 Maximum speed: 6.1 cm/sec  
 Line Voltage: 115 VAC  
 Line Frequency: 60 Hz  
 Material Composite: Delrin (Acetal)  
 Data Control: Parallel Port  
 Dynamic Range (X-Y-Z): 45 x 31.75 x 47 cm  
 Dimensions: 36" x 25" x 38"  
 Operating Area: 36" x 49" x 55"  
 Reflections: < -20 dB (in anechoic chamber)



**Figure 5-3**  
RF Near-Field Scanner

## III. ITU-T P.50 Artificial Voice

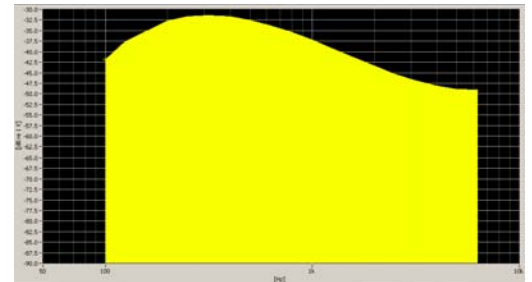

Manufacturer: ITU-T  
 Active Frequency Range: 100 Hz – 8 kHz  
 Stimulus Type: Male and Female, no spaces  
 Single Sample Duration: 20.96 seconds  
 Activity Level: 100%

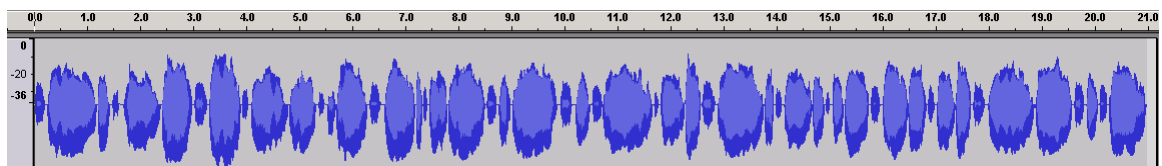

**Figure 5-4**  
Spectral Characteristic of full P.50



**Figure 5-5**  
Temporal Characteristic of full P.50

FCC ID: ZNFAS680	 PCTEST PCTEST ENGINEERING LABORATORY, INC.	HAC (T-COIL) TEST REPORT	 LG	Reviewed by: Quality Manager
Filename: 0Y1107081120.ZNF	Test Dates: 7/19/2011 - 7/20/2011	EUT Type: Cellular/PCS CDMA/EVDO Phone with BT and WLAN	Page 10 of 37	

ABM1 Measurement Block Diagram:

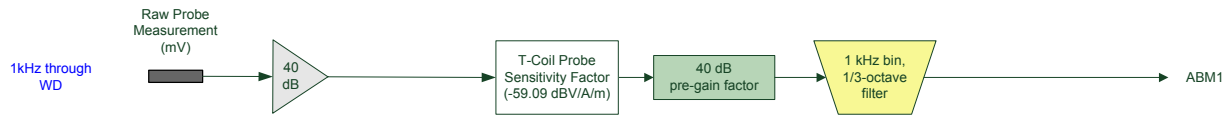

ABM2 Measurement Block Diagram:

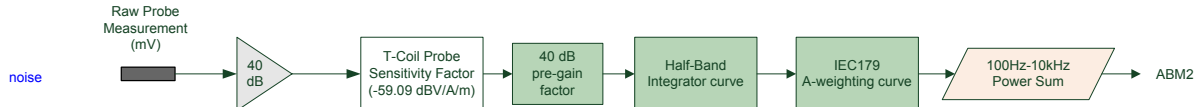

**Figure 5-6 Magnetic Measurement Processing Steps**

#### IV. Test Procedure

1. Ambient Noise Check per C63.19 §6.2.1
  - a. Ambient interference was monitored using a Real-Time Analyzer between 100-10,000 Hz with 1/3 octave filtering.
  - b. “A-weighting” and Half-Band Integration was applied to the measurements.
  - c. Since this measurement was measured in the same method as ABM2 measurements, this level was verified to be less than 10 dB below the lowest measurement signal (which is the highest ABM2 measurement for a T4 WD). Therefore the maximum noise level for a T4 WD with an ABM1 = -18 dBA/m is:  

$$-18 - 30 - 10 = -58 \text{ dBA/m}$$

2. Measurement System Validation (See Figure 5-1)
  - a. The measurement system including the probe, pre-amplifier and acquisition system were validated as an entire system to ensure the reliability of test measurements.
  - b. ABM1 Validation  
 The magnetic field at the center of the Helmholtz coil is given by the equation (per C63.19 Annex D.9.1):



$$H_c = \frac{NI}{r\sqrt{1.25^3}} = \frac{N\left(\frac{V}{R}\right)}{r\sqrt{1.25^3}}$$

Where  $H_c$  = magnetic field strength in amperes per meter  
 N = number of turns per coil

For the Helmholtz Coil,  $N=20$ ;  $r=0.08\text{m}$ ;  $R=10.193\Omega$  and using  $V=57\text{mV}$ :

$$H_c = \frac{20 \cdot \left(\frac{0.057}{10.193}\right)}{0.08 \cdot \sqrt{1.25^3}} = 1.0003 \text{ A/m}$$

Therefore a pure tone of 1kHz was applied into the coils such that 57 mV was observed across the 10 Ω resistor. The voltmeter used for measurement was verified to be capable of measurements in the audio band range. This theoretically generates an expected field of 1 A/m in the center of the Helmholtz coil which was used to validate the probe

FCC ID: ZNFAS680		HAC (T-COIL) TEST REPORT		Reviewed by: Quality Manager
Filename: 0Y1107081120.ZNF	Test Dates: 7/19/2011 - 7/20/2011	EUT Type: Cellular/PCS CDMA/EVDO Phone with BT and WLAN		Page 11 of 37

measurement at 1 A/m. This was verified to be within  $\pm 0.5$  dB of the 1 A/m value (see Page 20).

c. Frequency Response Validation

The frequency response through the Helmholtz Coil was verified to be within 0.5 dB relative to 1 kHz, between 300 – 3000 Hz using the ITU-P.50 artificial speech signal as shown below:

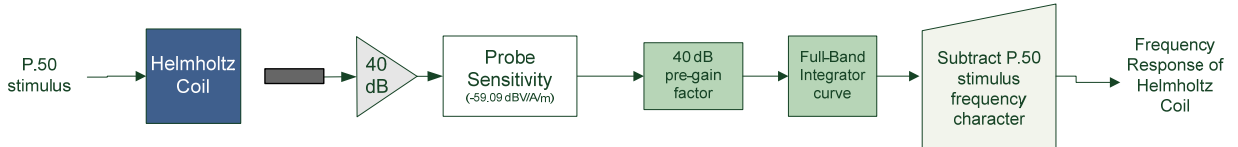

**Figure 5-7 Frequency Response Validation**

d. ABM2 Measurement Validation

WD noise measurements are filtered with A-weighting and Half-Band Integration over a frequency range of 100Hz – 10kHz to process ABM2 measurements. Below is the verification of the system processing A-weighting and Half-Band integration between system input to output within 0.5 dB of the theoretical result:

**Table 5-1  
ABM2 Frequency Response Validation**

f (Hz)	HBI, A - Measured (dB re 1kHz)	HBI, A - Theoretical (dB re 1kHz)	dB Var.
100	-16.180	-16.170	-0.010
125	-13.257	-13.250	-0.007
160	-10.347	-10.340	-0.007
200	-8.017	-8.010	-0.007
250	-5.925	-5.920	-0.005
315	-4.045	-4.040	-0.005
400	-2.405	-2.400	-0.005
500	-1.212	-1.210	-0.002
630	-0.349	-0.350	0.001
800	0.071	0.070	0.001
1000	0.000	0.000	0.000
1250	-0.503	-0.500	-0.003
1600	-1.513	-1.510	-0.003
2000	-2.778	-2.780	0.002
2500	-4.316	-4.320	0.004
3150	-6.166	-6.170	0.004
4000	-8.322	-8.330	0.008
5000	-10.573	-10.590	0.017
6300	-13.178	-13.200	0.022
8000	-16.241	-16.270	0.029
10000	-19.495	-19.520	0.025

FCC ID: ZNFAS680		HAC (T-COIL) TEST REPORT		Reviewed by: Quality Manager
Filename: 0Y1107081120.ZNF	Test Dates: 7/19/2011 - 7/20/2011	EUT Type: Cellular/PCS CDMA/EVDO Phone with BT and WLAN		Page 12 of 37

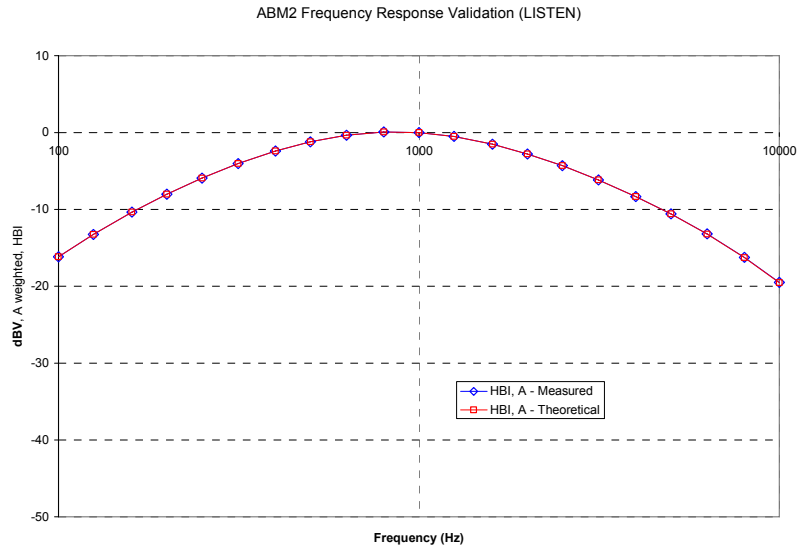

**Figure 5-8**  
**ABM2 Frequency Response Validation**

The ABM2 result is a power sum from 100 Hz to 10 kHz with half-band integration and A-weighting. To verify the power sum measurement, a power sum over the full band was measured and verified to track with the source level (See Figure 5-9). Therefore the setup in this step was used to verify the power sum post-processing for ABM2 measurements. See below block diagram:

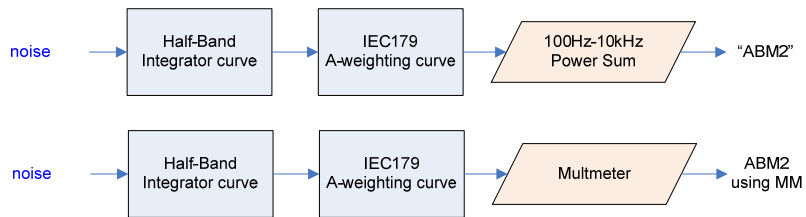

**Figure 5-9**  
**ABM2 Validation Block Diagram**

The power summed output results for a known input were compared to the multi-meter results to verify any deviation in the post-processing implemented with the power-sum.

**Table 5-2**  
**ABM2 Power Sum Validation**

WN Input (dBV)	Power Sum (dBV)	Multimeter-Full (dBV)	Dev (dB)
-60	-60.36	-60.2	0.16
-50	-50.19	-50.13	0.06
-40	-40.14	-40.03	0.11
-30	-30.13	-30.01	0.12
-20	-20.12	-20	0.12
-10	-10.14	-10	0.14

FCC ID: ZNFAS680		HAC (T-COIL) TEST REPORT		Reviewed by: Quality Manager
Filename: 0Y1107081120.ZNF	Test Dates: 7/19/2011 - 7/20/2011	EUT Type: Cellular/PCS CDMA/EVDO Phone with BT and WLAN		Page 13 of 37

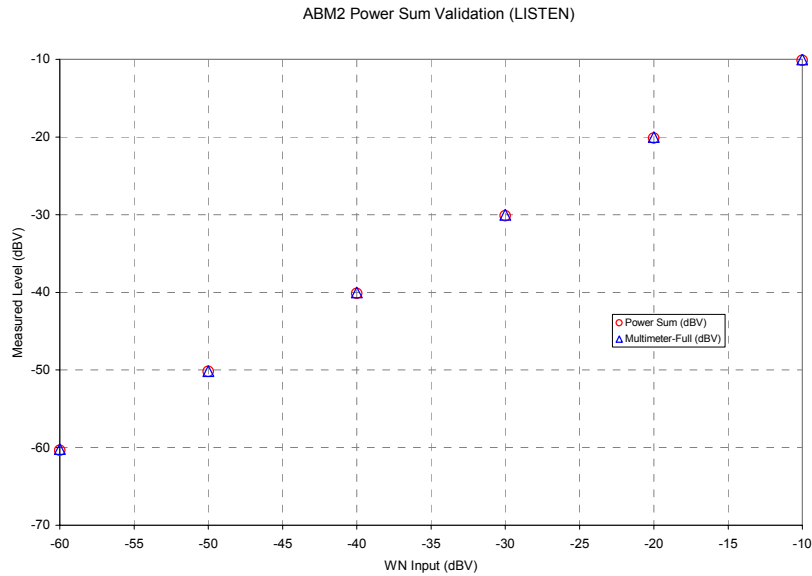
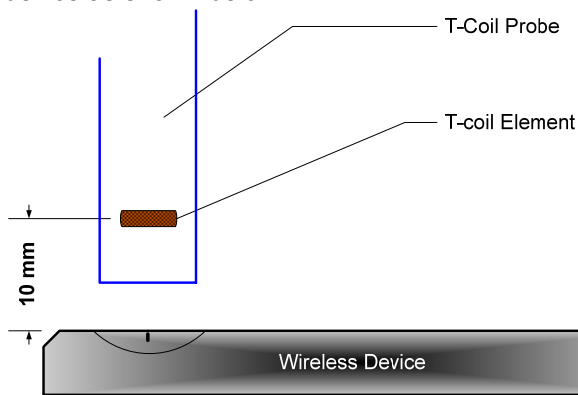

**Figure 5-10**  
**ABM2 Power Sum Validation**

3. Measurement Test Setup

a. Fine scan above the WD (TEM)

- i. A multitone signal was applied to the handset such that the phone acoustic output was stable within 1dB over the probe settling time and with the acoustic output level at the C63.19 specified levels (below). The measurement step size was in 2 mm increments at a distance of 10 mm between the surface of the wireless device as shown below:



**Figure 5-11**  
**Measurement Distance**

- ii. After scanning, the planar field maximum point was determined. The position of the probe was moved to this location to setup the test using the sound check system.
- iii. These steps were repeated for the other T-coil orientations (of axial, radial transverse, or radial longitudinal) per Figure 5-16 after a T-coil orientation was fully measured with the sound check system.

FCC ID: ZNFAS680		HAC (T-COIL) TEST REPORT		Reviewed by: Quality Manager
Filename: 0Y1107081120.ZNF	Test Dates: 7/19/2011 - 7/20/2011	EUT Type: Cellular/PCS CDMA/EVDO Phone with BT and WLAN	Page 14 of 37	

- b. Speech Signal Setup to Base Station Simulator
  - i. C63.19 Table 6-1 states audio reference input levels for various technologies:

Standard	Technology	Input Level (dBm0)
TIA/EIA/IS-2000	CDMA	-18
J-STD-007	GSM (217 Hz)	-16
T1/T1P1/3GPP	UMTS (WCDMA)	-16
iDEN™	TDMA (22 and 11 Hz)	-18

The CMU200 audio levels were determined using base station simulator manufacturer calibration procedures resulting in the below corresponding voltages relative to handset test point level (in dBm0):

**Table 5-3  
CMU200 Voltage Input Levels for Audio**

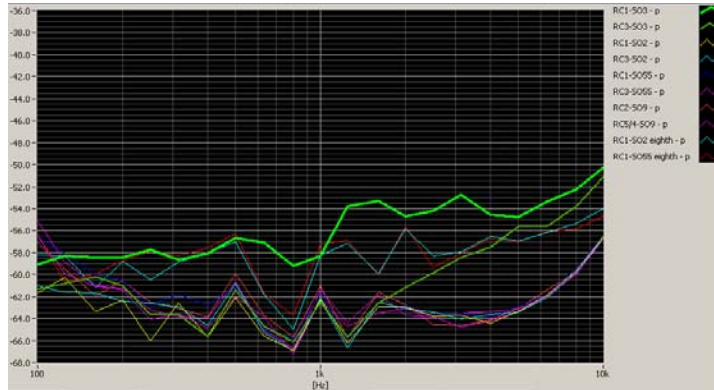

dBm0 Ref.	Input Voltage		Notes
3.14 dBm0	1052.0 mV	0.4 dBV	From CDMA2K "DECODER CAL". (What is needed through Encoder for FS)
-18 dBm0	92.260 mV	-20.7 dBV	For 8k Enhanced (Low)

- c. Real-Time Analyzer (RTA)
  - i. The Real-Time Analyzer was configured to analyze measurements using 1/3 Octave band weighted filtering.
- d. WD Radio Configuration Selection
  - i. The device was chosen to be tested in the worst-case ABM2 condition under RC1/SO3 (EVRC) (see below):



**Figure 5-12  
Vocoder Analysis for ABM Noise**

- 4. Signal Quality Data Analysis
  - a. Narrow-band Magnetic Intensity
    - i. The standard specifies a 1 kHz 1/3 octave band minimum field intensity for a sine tone. The ABM1 measurements were evaluated at 1kHz with 1/3 octave band filtering over an averaged period of 10 seconds.
  - b. Frequency Response
    - i. The appropriate frequency response curve was measured to curves in Figure 4-1 or Figure 4-2 between 300 – 3000 Hz using digital linear averaging (limit lines

FCC ID: ZNFAS680		HAC (T-COIL) TEST REPORT		Reviewed by: Quality Manager
Filename: 0Y1107081120.ZNF	Test Dates: 7/19/2011 - 7/20/2011	EUT Type: Cellular/PCS CDMA/EVDO Phone with BT and WLAN	Page 15 of 37	

chosen according to measurement found in step 4a.) A linear average over 3x the length of the artificial voice signal (3x sampling) was performed. A 10 second delay was configured in the measurement process of the stimulus to ensure handset vocoder latency effects and echo cancellation devices (if any) were appropriately stabilized during measurements.

- ii. The appropriate post-processing was applied according to the system processing chain illustrated in Figure 5-13. All R10 frequencies were plotted with respect to 0dB at 1 kHz value and aligned with respect to the EIA-504 mask.

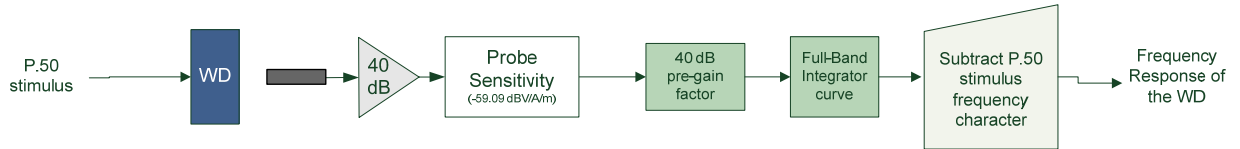

**Figure 5-13 Frequency Response Block Diagram**

- iii. The margin is represented by the closest measured data point on the curve to the EIA-504 limit lines, in dB.
- c. Signal Quality Index
- i. Ensuring the WD was at maximum RF power, maximum volume, backlight on, display on, maximum contrast setting, keypad lights on (when possible) with no audio signal through the vocoder, the WD was measured over at least 100 Hz – 10,000 Hz, maximized over 5 seconds with a 50ms sample time for the ABM2 measurement (5 second time period is used in noise measurements under standards such as IEEE 269, etc.)
  - ii. After applying half-band integration and A-weighting to the result, a power sum was applied over each 1/3 octave bandwidth frequency for an ABM2 value
  - iii. This result was subtracted from the ABM1 result in step a, to obtain the Signal Quality.

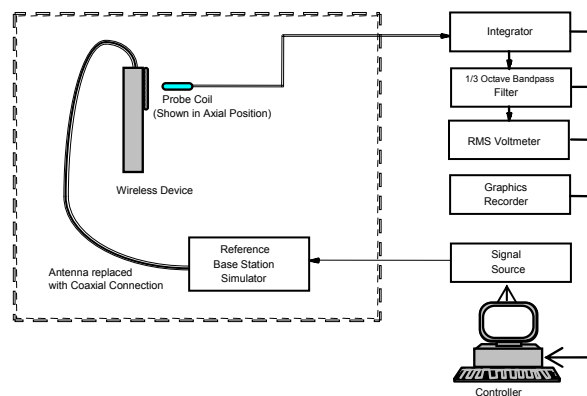

## V. Test Setup



**Figure 5-14 Audio Magnetic Field Test Setup**

## VI. Deviation from C63.19 Test Procedure

None.

FCC ID: ZNFAS680		HAC (T-COIL) TEST REPORT		Reviewed by: Quality Manager
Filename: 0Y1107081120.ZNF	Test Dates: 7/19/2011 - 7/20/2011	EUT Type: Cellular/PCS CDMA/EVDO Phone with BT and WLAN		Page 16 of 37



## VII. Wireless Device Channels and Frequencies

The frequencies listed in the table below are those that lie in the center of the bands used for cellular telephony. Low, middle and high channels were tested in each band for FCC compliance evaluation to ensure the maximum emission is captured across the entire band.

To facilitate setting of a base station simulator for ABM measurements, specific band plan channel numbers are listed that may be used in lieu of the band center frequencies.

**Table 5-4  
Center Channels and Frequencies**



Test frequencies & associated channels	
Channel	Frequency (MHz)
<b>Cellular 850</b>	
384 (CDMA)	836.52
4183(UMTS)	836.60
190 (GSM)	836.60
<b>PCS 1900</b>	
661 (GSM)	1880
600 (CDMA)	1880
9400 (UMTS)	1880
<b>AWS 1750</b>	
450 (CDMA)	1732.50
1412 (UMTS)	1730.40

## VIII. RF Emission Effect on T-coil Measurements



**Figure 5-15**

**High power RF Emissions Effect with HAC Dipole on the T-coil Probe System 10mm between dipole maximum and magnetic probe**



FCC ID: ZNFAS680	 PCTEST PCTEST ENGINEERING LABORATORY, INC.	HAC (T-COIL) TEST REPORT	 LG	Reviewed by: Quality Manager
Filename: 0Y1107081120.ZNF	Test Dates: 7/19/2011 - 7/20/2011	EUT Type: Cellular/PCS CDMA/EVDO Phone with BT and WLAN		Page 17 of 37

## IX. Test Flow

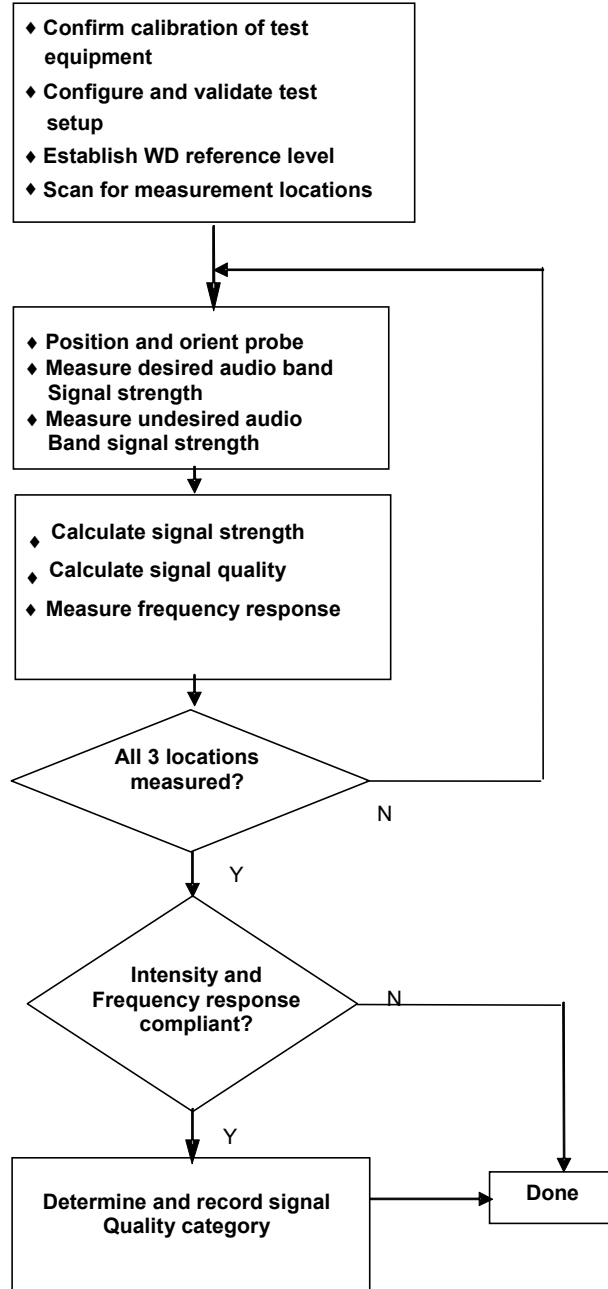
The flow diagram below was followed (From C63.19):



**Figure 5-16**  
**C63.19 T-Coil Signal Test Process**

FCC ID: ZNFAS680		HAC (T-COIL) TEST REPORT		Reviewed by: Quality Manager
Filename: 0Y1107081120.ZNF	Test Dates: 7/19/2011 - 7/20/2011	EUT Type: Cellular/PCS CDMA/EVDO Phone with BT and WLAN		Page 18 of 37

## 6. TEST SUMMARY

### I. T-Coil Test Summary

**Table 6-1  
Table of Results**



C63.19 Sec.	Mode	Band	Test Description	Minimum Limit*	Measured	Verdict
				<i>dBa/m</i>	<i>dBa/m</i>	<i>PASS/FAIL</i>
7.3.1.1	CDMA	Cellular	Intensity, Axial	-18	2.2	PASS
7.3.1.2			Intensity, RadialH	-18	-4.8	PASS
7.3.1.2			Intensity, RadialV	-18	-5.3	PASS
7.3.3			Signal-to-Noise/Noise, Axial	20	33.2	PASS
7.3.3			Signal-to-Noise/Noise, RadialH	20	36.6	PASS
7.3.3			Signal-to-Noise/Noise, RadialV	20	24.5	PASS
7.3.2			Frequency Response, Axial	0	0.8	PASS
7.3.1.1	CDMA	PCS	Intensity, Axial	-18	2.2	PASS
7.3.1.2			Intensity, RadialH	-18	-4.8	PASS
7.3.1.2			Intensity, RadialV	-18	-5.7	PASS
7.3.3			Signal-to-Noise/Noise, Axial	20	33.0	PASS
7.3.3			Signal-to-Noise/Noise, RadialH	20	37.2	PASS
7.3.3			Signal-to-Noise/Noise, RadialV	20	24.6	PASS
7.3.2			Frequency Response, Axial	0	0.9	PASS

Note: The above summary table represents the worst-case numerical values according to configurations in Table 6-3.

**Table 6-2  
Consolidated Tabled Results**

	Volume Setting	Cellular			PCS		
		Axial	RadialH	RadialV	Axial	RadialH	RadialV
Freq. Response Margin	Maximum	PASS	PASS	PASS	PASS	PASS	PASS
Magnetic Intensity Verdict		PASS	PASS	PASS	PASS	PASS	PASS
FCC SNR Verdict		PASS	PASS	PASS	PASS	PASS	PASS

Note: The above table represents the pass/fail verdict according to data in Table 6-3.

FCC ID: ZNFAS680	 PCTEST Engineering Laboratory, Inc.	HAC (T-COIL) TEST REPORT	 LG	Reviewed by: Quality Manager
Filename: 0Y1107081120.ZNF	Test Dates: 7/19/2011 - 7/20/2011	EUT Type: Cellular/PCS CDMA/EVDO Phone with BT and WLAN		Page 19 of 37

## II. Raw Handset Data



**Table 6-3  
Raw Data Results**

	Volume	Cellular Band								
		Axial			RadialH			RadialV		
		1013	384	777	1013	384	777	1013	384	777
ABM1, dBA/m	Maximum	2.17	2.18	2.28	-4.79	-4.79	-4.82	-5.23	-5.25	-5.24
ABM2, dBA/m		-31.68	-31.02	-31.47	-41.91	-41.36	-41.66	-29.87	-30.16	-29.68
Ambient Noise, dBA/m		-59.59	-59.59	-59.59	-60.21	-60.21	-60.21	-59.87	-59.87	-59.87
Freq. Response Margin (dB)		1.00	0.75	1.02	1.04	0.75	0.82	0.87	0.90	0.79
S+N/N (dB)		33.86	33.20	33.75	37.12	36.57	36.84	24.65	24.91	24.45
S+N/N per orientation (dB)		33.2			36.57			24.45		
	Volume	PCS Band								
		Axial			RadialH			RadialV		
		25	600	1175	25	600	1175	25	600	1175
ABM1, dBA/m	Maximum	2.19	2.18	2.15	-4.70	-4.81	-4.81	-5.35	-5.25	-5.68
ABM2, dBA/m		-30.80	-32.58	-31.38	-41.90	-42.36	-43.18	-29.92	-31.56	-31.11
Ambient Noise, dBA/m		-59.59	-59.59	-59.59	-60.21	-60.21	-60.21	-59.87	-59.87	-59.87
Freq. Response Margin (dB)		0.85	0.86	0.88	0.88	0.93	0.85	0.93	0.84	1.07
S+N/N (dB)		32.99	34.76	33.53	37.20	37.55	38.36	24.57	26.31	25.43
S+N/N per orientation (dB)		32.99			37.2			24.57		
T-coil Coordinates (cm)		[x,y] from bottom left	2.5,2.6			2.4, 3.5			3.4, 2.6	

Note: ABM1 >> Ambient noise

### WD Configuration

1. Radio Configuration: RC1/SO3 (EVRC)
2. Power Configuration: Power Control Bits = "All Up"
3. Phone Condition: Mute on; Backlight on; Max Volume, Max Contrast

FCC ID: ZNFAS680	 PCTEST Engineering Laboratory, Inc.	HAC (T-COIL) TEST REPORT	 LG	Reviewed by: Quality Manager
Filename: 0Y1107081120.ZNF	Test Dates: 7/19/2011 - 7/20/2011	EUT Type: Cellular/PCS CDMA/EVDO Phone with BT and WLAN	Page 20 of 37	

### III. Frequency Response Graph

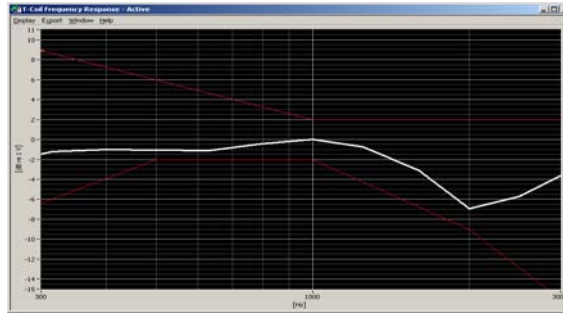

**Figure 6-1**  
**Axial Frequency Response**

Note: This frequency response represents the worst-case ABM2 test configuration according to Table 6-3.

### IV. 1 kHz Vocoder Application Check

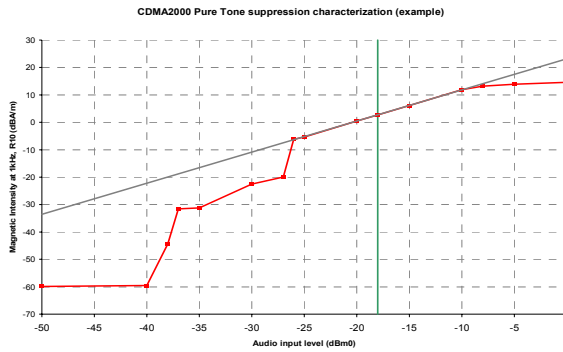

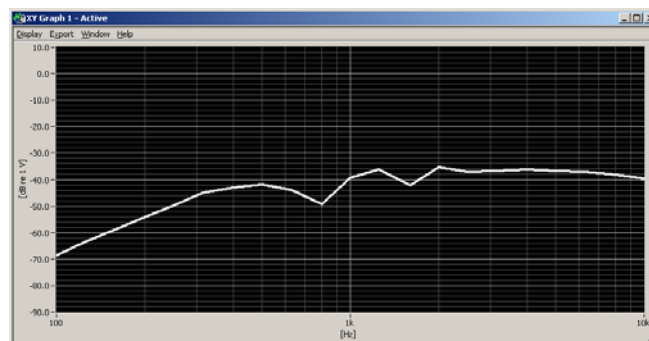

This model was verified to be within the linear region for ABM1 measurements. This measurement was taken in the axial configuration above the ABM1 maximum location/configuration derived from Table 6-3.

### V. Undesirable Audio Magnetic Band Plot (ABM2)

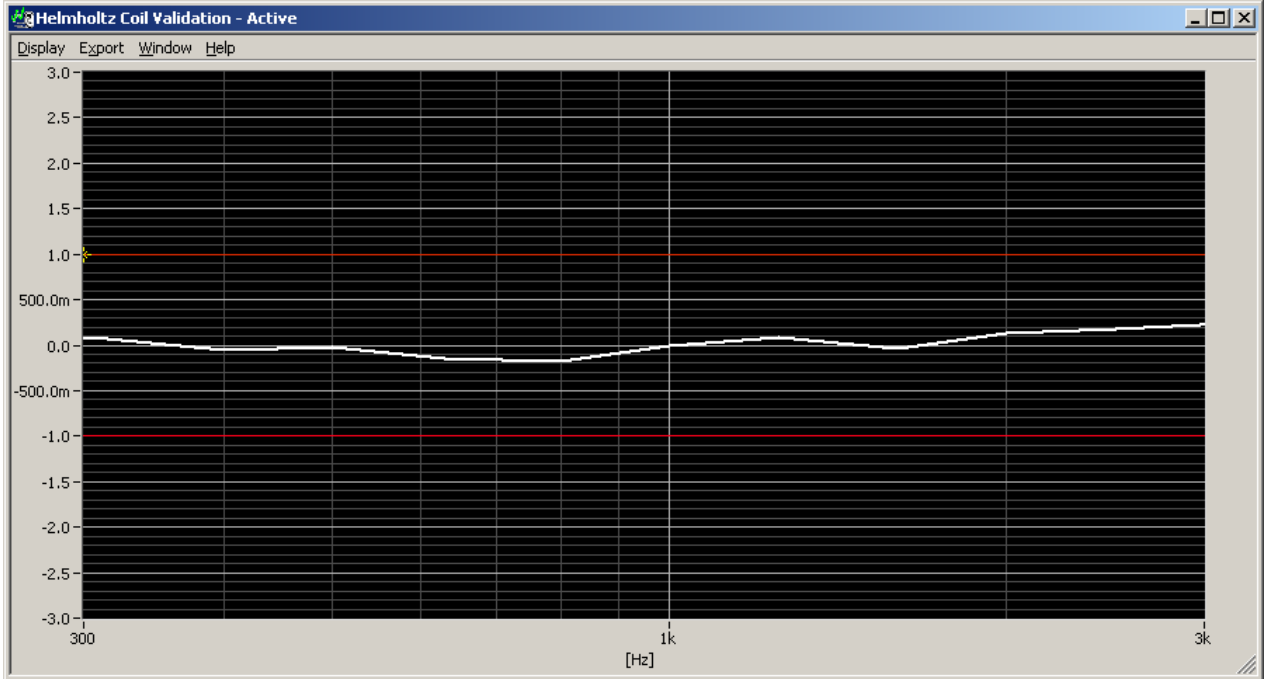

**Figure 6-2**  
**Worst-case ABM2 Plot for WD**

Note: This plot represents the data from the location/configuration resulting in the highest ABM2 result shown in Table 6-3.

FCC ID: ZNFAS680		HAC (T-COIL) TEST REPORT		Reviewed by: Quality Manager
Filename: 0Y1107081120.ZNF	Test Dates: 7/19/2011 - 7/20/2011	EUT Type: Cellular/PCS CDMA/EVDO Phone with BT and WLAN	Page 21 of 37	



## VI. T-Coil Validation Test Results



**Figure 6-3**  
Helmholtz Coil Validation for Frequency Response

**Table 6-4**  
Helmholtz Coil Validation Table of Results

Item	Target	Result	Verdict
Signal Validation			
Frequency Response, from limits	$0 \pm 0.5$ dB	0.23	PASS
Magnetic Intensity, -10 dBA/m	$-10 \pm 0.5$ dB	-9.884	PASS
Noise Validation			
Axial Environmental Noise	< - 58 dBA/m	-59.59	PASS
RadialH Environmental Noise	< - 58 dBA/m	-60.21	PASS
RadialV Environmental Noise	< - 58 dBA/m	-59.87	PASS

FCC ID: ZNFAS680		HAC (T-COIL) TEST REPORT		Reviewed by: Quality Manager
Filename: 0Y1107081120.ZNF	Test Dates: 7/19/2011 - 7/20/2011	EUT Type: Cellular/PCS CDMA/EVDO Phone with BT and WLAN		Page 22 of 37

## 7. FCC 3G MEASUREMENTS

Radio Configuration 1, Service Option 3 (thick, green data curve) was used for the testing as the worst-case configuration for the handset due to vocoder gating from the EVRC logic. See below plot for ABM noise comparison between operational field service options and radio configurations for a CDMA2000 handset:

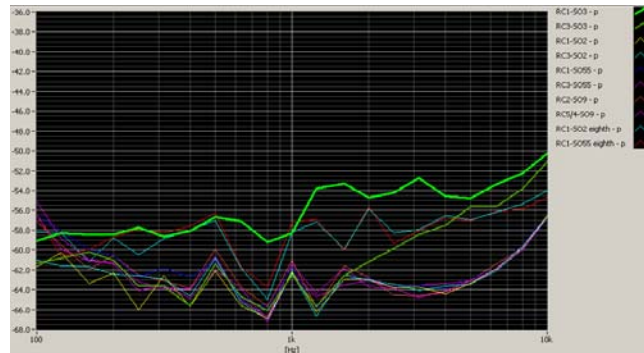

Figure 7-1  
CDMA2000 Audio Band Magnetic Noise

### I. ABM Measurements

#### ABM2 Pre-Test (dBA/m), A, HBI

RC1/SO3	RC3/SO3	RC4/SO3	Orientation	Channel
-30.09	-42.26	-42.28	RadialV	25

#### ABM1 Pre-Test (dBA/m)

RC1/SO3	RC3/SO3	RC4/SO3	Orientation	Channel
-5.260	-5.490	-5.420	RadialV	25

- Mute on; Backlight on; Max Volume, Max Contrast
- Power Control Bits = "All Up"



Figure 7-2  
Audio Band Magnetic Curve Measurement Block Diagram

FCC ID: ZNFAS680	PCTEST PCTEST ENGINEERING LABORATORY, INC.	HAC (T-COIL) TEST REPORT	LG	Reviewed by: Quality Manager
Filename: 0Y1107081120.ZNF	Test Dates: 7/19/2011 - 7/20/2011	EUT Type: Cellular/PCS CDMA/EVDO Phone with BT and WLAN		Page 23 of 37

## 8. MEASUREMENT UNCERTAINTY



**Table 8-1  
Uncertainty Estimation Table**

Contribution	Data +/- %	Data +/- dB	Data Type	Probability distribution	Divisor	Standard uncertainty	Standard Uncertainty (dB)
ABM Noise	7.0%	0.29	Std. Dev.	Normal k=1	1.00	7.0%	
RF Reflections	4.7%	0.20	Specification	Rectangular	1.73	2.7%	
Reference Signal Level	12.2%	0.50	Specification	Rectangular	1.73	7.0%	
Positioning Accuracy	10.0%	0.41	Uncertainty	Rectangular	1.73	5.8%	
Probe Coil Sensitivity	12.2%	0.50	Specification	Rectangular	1.73	7.0%	
Probe Linearity	2.4%	0.10	Std. Dev.	Normal k=1	1.00	2.4%	
Cable Loss	2.8%	0.12	Specification	Rectangular	1.73	1.6%	
Frequency Analyzer	5.0%	0.21	Specification	Rectangular	1.73	2.9%	
System Repeatability	5.0%	0.21	Std. Dev.	Normal k=1	1.00	5.0%	
WD Repeatability	9.0%	0.37	Std. Dev.	Normal k=1	1.00	9.0%	
Positioner Accuracy	1.0%	0.04	Specification	Rectangular	1.73	0.6%	
<b>Combined standard uncertainty, uc (k=1)</b>						<b>17.7%</b>	<b>0.71</b>
<b>Expanded uncertainty (k=2), 95% confidence level</b>						<b>35.3%</b>	<b>1.31</b>

**Notes:**

1. Test equipments are calibrated according to techniques outlined in NIS81, NIS3003 and NIST Tech Note 1297.
2. All equipments have traceability according to NIST. Measurement Uncertainties are defined in further detail in NIS 81 and NIST Tech Note 1297 and UKAS M3003.

Measurement uncertainty reflects the quality and accuracy of a measured result as compared to the true value. Such statements are generally required when stating results of measurements so that it is clear to the intended audience that the results may differ when reproduced by different facilities. Measurement results vary due to the measurement uncertainty of the instrumentation, measurement technique, and test engineer. Most uncertainties are calculated using the tolerances of the instrumentation used in the measurement, the measurement setup variability, and the technique used in performing the test. While not generally included, the variability of the equipment under test also figures into the overall measurement uncertainty. Another component of the overall uncertainty is based on the variability of repeated measurements (so-called Type A uncertainty). This may mean that the Hearing Aid compatibility tests may have to be repeated by taking down the test setup and resetting it up so that there are a statistically significant number of repeat measurements to identify the measurement uncertainty. By combining the repeat measurement results with that of the instrumentation chain using the technique contained in NIS 81 and NIS 3003, the overall measurement uncertainty was estimated.



<b>FCC ID:</b> ZNFAS680		<b>HAC (T-COIL) TEST REPORT</b>		<b>Reviewed by:</b> Quality Manager
<b>Filename:</b> 0Y1107081120.ZNF	<b>Test Dates:</b> 7/19/2011 - 7/20/2011	<b>EUT Type:</b> Cellular/PCS CDMA/EVDO Phone with BT and WLAN		Page 24 of 37





## 9. EQUIPMENT LIST

**Table 9-1  
Equipment List**

Manufacturer	Model	Description	Cal Date	Cal Interval	Cal Due	Serial Number
Agilent	E5515C	Wireless Communications Test Set	8/13/2010	Annual	8/13/2011	GB43304447
Agilent	E4407B	ESA Spectrum Analyzer	4/5/2011	Annual	4/5/2012	US39210313
Agilent	E5515C	Wireless Communications Tester	4/21/2011	Annual	4/21/2012	US41140256
Gigatronics	80701A	(0.05-18GHz) Power Sensor	10/11/2010	Annual	10/11/2011	1833460
Gigatronics	8651A	Universal Power Meter	10/11/2010	Annual	10/11/2011	8650319
NI	4474	Data Acquisition Card	N/A		N/A	N/A
Rohde & Schwarz	CMU200	Base Station Simulator	11/11/2010	Annual	11/11/2011	836371/0079
Rohde & Schwarz	CMW500	LTE Radio Communication Tester	3/11/2011	Annual	3/11/2012	103962
Rohde & Schwarz	CMU200	Base Station Simulator	4/19/2011	Annual	4/19/2012	107826
Rohde & Schwarz	CMU200	Base Station Simulator	6/1/2011	Annual	6/1/2012	833855/0010
TEM	Helmholtz Coil	Helmholtz Coil	9/11/2009	Biennial	9/11/2011	SBI 1050
TEM	Radial T-Coil Probe	Radial T-Coil Probe	1/14/2011	Annual	1/14/2012	TEM-1130
TEM	Axial T-Coil Probe	Axial T-Coil Probe	1/14/2011	Annual	1/14/2012	TEM-1122
TEM	Axial T-Coil Probe	Axial T-Coil Probe	1/14/2011	Annual	1/14/2012	TEM-1123
TEM	Axial T-Coil Probe	Axial T-Coil Probe	1/14/2011	Annual	1/14/2012	TEM-1124
TEM	Radial T-Coil Probe	Radial T-Coil Probe	1/14/2011	Annual	1/14/2012	TEM-1128
TEM	Axial T-coil Probe	Axial T-Coil Probe	6/15/2011	Annual	6/15/2012	TEM-1105
TEM	Radial T-Coil Probe	Radial T-Coil Probe	6/15/2011	Annual	6/15/2012	TEM-1121
TEM		HAC System Controller with Software	N/A		N/A	N/A
TEM		HAC Positioner	N/A		N/A	N/A

FCC ID: ZNFAS680	 PCTEST PCTEST ENGINEERING LABORATORY, INC.	HAC (T-COIL) TEST REPORT	 LG	Reviewed by: Quality Manager
Filename: 0Y1107081120.ZNF	Test Dates: 7/19/2011 - 7/20/2011	EUT Type: Cellular/PCS CDMA/EVDO Phone with BT and WLAN		Page 25 of 37

## 10. CALIBRATION CERTIFICATES

<b>FCC ID:</b> ZNFAS680	 <b>PCTEST</b> <small>Engineering Laboratory, Inc.</small>	<b>HAC (T-COIL) TEST REPORT</b>	 <b>LG</b>	<b>Reviewed by:</b> Quality Manager
<b>Filename:</b> 0Y1107081120.ZNF	<b>Test Dates:</b> 7/19/2011 - 7/20/2011	<b>EUT Type:</b> Cellular/PCS CDMA/EVDO Phone with BT and WLAN	Page 26 of 37	

West Caldwell Calibration Laboratories Inc.

# Certificate of Calibration

for

Axial T Coil Probe

Manufactured by: TEM CONSULTING, LP  
Model No: Axial T Coil Probe  
Serial No: TEM-1122  
Calibration Recall No: 20504

Submitted By:

Customer: STEVE LIU  
Company: PCTEST ENGINEERING LAB  
Address: 6660-B DOBBIN ROAD  
COLUMBIA MD 21045

OK  
✓ SL  
6/7/11

The subject instrument was calibrated to the indicated specification using standards traceable to the National Institute of Standards and Technology or to accepted values of natural physical constants. This document certifies that the instrument met the following specification upon its return to the submitter.

West Caldwell Calibration Laboratories Procedure No. Axial T Coi TEM

Upon receipt for Calibration, the instrument was found to be:

Within ( X ) see attached Report of Calibration.

the tolerance of the indicated specification.

West Caldwell Calibration Laboratories' calibration control system meets the requirements, ISO 10012-1 MIL-STD-45662A, ANSI/NCSL Z540-1, IEC Guide 25, ISO 9001:2008 and ISO 17025.

Note: With this Certificate, Report of Calibration is included.

Approved by:

Calibration Date: 14-Jan-11

FC

Certificate No: 20504 - 6

Felix Christopher  
Quality Manager

QA Doc. #1051 Rev. 2.0 10/1/01

Certificate Page 1 of 1

**West Caldwell Calibration Laboratories, Inc.**  
uncompromised calibration  
1575 State Route 96, Victor, NY 14564, U.S.A.

ISO 9001:2008  
Registered Company  
Calibration Traceable  
to N.I.S.T.



Phone: (585) 586-3900 Fax: (585) 586-4327

FCC ID: ZNFAS680		HAC (T-COIL) TEST REPORT		Reviewed by: Quality Manager
Filename: 0Y1107081120.ZNF	Test Dates: 7/19/2011 - 7/20/2011	EUT Type: Cellular/PCS CDMA/EVDO Phone with BT and WLAN		Page 27 of 37

**West Caldwell Calibration Laboratories, Inc.**  
 uncompromised calibration  
 1575 State Route 96, Victor NY 14564



## REPORT OF CALIBRATION

TEM Consulting LP Axial T Coil Probe

for  
 Model No.: Axial T Coil Probe

Serial No.: TEM-1122

Company : PC Test Inc.

I. D. No: XXXX

Calibration results:	Before data: .....	After data: .....
<b>Probe Sensitivity measured with Helmholtz Coil</b>		
<i>Helmholtz Coil;</i>		
the number of turns on each coil;	10	No.
the radius of each coil, in meters;	0.204	m
the current in the coils, in amperes.;	0.08	A
<i>Helmholtz Coil Constant;</i>		
	6.98	A/m/V
<i>Helmholtz Coil magnetic field;</i>		
	5.90	A/m
<b>Probe Sensitivity at</b>		
	1000	Hz.
was	-60.27	dBV/A/m
	0.970	mV/A/m
<b>Probe resistance</b>		
	895	Ohms
Before & after data same: ...X.....		
Laboratory Environment:		
Ambient Temperature:	24.4	°C
Ambient Humidity:	27.6	% RH
Ambient Pressure:	100.3	kPa
Calibration Date:	14-Jan-11	4:26 PM
Re-calibration Due:	14-Jan-12	
Report Number:	20504	-6
Control Number:	20504	
<b>The above listed instrument meets or exceeds the tested manufacturer's specifications.</b>		
This Calibration is traceable through NIST test numbers: ,205342		
The expanded uncertainty of calibration: 0.30dB at 95% confidence level with a coverage factor of k=2.		

Graph represents Probes Frequency Response.

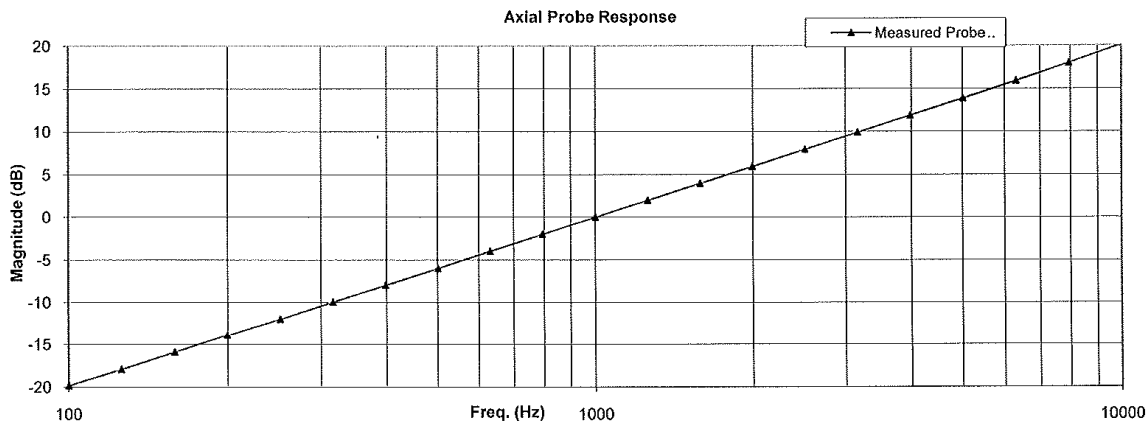

The above listed instrument was checked using calibration procedure documented in West Caldwell Calibration Laboratories Inc. procedure : **Rev. 5.0 Sept. 10, 2010 Doc. # 1038 HCATEMC**  
 Calibration was performed by West Caldwell Calibration Laboratories Inc. under Operating Procedures intended to implement the requirements of ISO10012-1, IEC Guide 25, ANSI/NCSL Z540-1, (MIL-STD-45662A) and ISO 9001:2008, ISO 17025

Cal. Date: 14-Jan-2011 4:26 PM

Measurements performed by: .....

Calibrated on WCCL system type 9700

**Felix Christopher**

This document shall not be reproduced, except in full, without the written approval from West Caldwell Cal. Labs. Inc.

Rev. 5.0 Sept. 10, 2010 Doc. # 1038 HCATEMC

FCC ID: ZNFAS680		HAC (T-COIL) TEST REPORT		Reviewed by: Quality Manager
Filename: 0Y1107081120.ZNF	Test Dates: 7/19/2011 - 7/20/2011	EUT Type: Cellular/PCS CDMA/EVDO Phone with BT and WLAN		Page 28 of 37

HCATEMC\_TEM-1122\_Jan-14-2011

West Caldwell Calibration Laboratories Inc.

1575 State Route 96, Victor NY 14564  
Tel. (585) 586-3900 FAX (585) 586-4327

**Calibration Data Record**

TEM Consulting LP Axial T Coil Probe      for      Model No.: Axial T Coil Probe      Serial No.: TEM-1122  
Company : PC Test Inc.

Test	Function	Tolerance	Measured values				
			Before	Out	Remarks		
1.0	Probe Sensitivity at	1000 Hz.      dBV/A/m	-60.27				
2.0	Probe Level Linearity						
			dB	6.03			
		Ref. (0 dB)	0	0.00			
			-6	-6.02			
		-12	-12.03				
3.0	Probe Frequency Response		Hz				
			100	-19.8			
			126	-17.9			
			158	-15.9			
			200	-13.9			
			251	-11.9			
			316	-9.9			
			398	-8.0			
			501	-6.0			
			631	-4.0			
			794	-2.0			
			Ref. (0 dB)	1000	0.0		
				1259	2.0		
				1585	4.0		
				1995	6.0		
				2512	7.9		
				3162	9.9		
		3981	11.9				
		5012	13.9				
		6310	15.9				
		7943	18.0				
		10000	20.1				

Instruments used for calibration:			Date of Cal.	Traceability No.	Due Date
HP	34401A	S/N US360641	8-Nov-2010	,205342	8-Nov-2011
HP	34401A	S/N US361024	8-Nov-2010	,205342	8-Nov-2011
HP	33120A	S/N S3604371	8-Nov-2010	,205342	8-Nov-2011
B&K	2133	S/N 1492410	1-Oct-2010	822/278767-10	1-Oct-2011



Cal. Date: 14-Jan-2011 4:26 PM

Tested by: Felix Christopher

Calibrated on WCCL system type 9700

This document shall not be reproduced, except in full, without the written approval from West Caldwell Cal. Labs. Inc.

Rev. 5.0 Sept. 10, 2010 Doc. # 1038 HCATEMC

FCC ID: ZNFAS680		HAC (T-COIL) TEST REPORT		Reviewed by: Quality Manager
Filename: 0Y1107081120.ZNF	Test Dates: 7/19/2011 - 7/20/2011	EUT Type: Cellular/PCS CDMA/EVDO Phone with BT and WLAN		Page 29 of 37

West Caldwell Calibration Laboratories Inc.

# Certificate of Calibration

for

Radial T Coil Probe

Manufactured by: TEM CONSULTING  
Model No: Radial T Coil Probe  
Serial No: TEM-1128  
Calibration Recall No: 20504

OK  
✓  
6/7/11

Submitted By:

Customer: STEVE LIU  
Company: PCTEST ENGINEERING LAB  
Address: 6660-B DOBBIN ROAD  
COLUMBIA MD 21045

The subject instrument was calibrated to the indicated specification using standards traceable to the National Institute of Standards and Technology or to accepted values of natural physical constants. This document certifies that the instrument met the following specification upon its return to the submitter.

West Caldwell Calibration Laboratories Procedure No. Radial T C TEM

Upon receipt for Calibration, the instrument was found to be:

Within ( X ) see attached Report of Calibration.

the tolerance of the indicated specification.

West Caldwell Calibration Laboratories' calibration control system meets the requirements, ISO 10012-1 MIL-STD-45662A, ANSI/NCSL Z540-1, IEC Guide 25, ISO 9001:2008 and ISO 17025.

Note: With this Certificate, Report of Calibration is included.

Approved by:

Calibration Date: 14-Jan-11

Certificate No: 20504 - 5

QA Doc. #1051 Rev. 2.0 10/1/01

Certificate Page 1 of 1

*FC*  
Felix Christopher  
Quality Manager

**West Caldwell Calibration Laboratories, Inc.**  
uncompromised calibration  
1575 State Route 96, Victor, NY 14564, U.S.A.

ISO 9001:2008  
Registered Company  
Calibration Traceable  
to N.I.S.T.



Phone: (585) 586-3900 Fax: (585) 586-4327

FCC ID: ZNFAS680		HAC (T-COIL) TEST REPORT		Reviewed by: Quality Manager
Filename: 0Y1107081120.ZNF	Test Dates: 7/19/2011 - 7/20/2011	EUT Type: Cellular/PCS CDMA/EVDO Phone with BT and WLAN		Page 30 of 37



## REPORT OF CALIBRATION

TEM Consulting LP Radial T Coil Probe

for  
Model No.: Radial T Coil Probe

Serial No.: TEM-1128

Company : PC Test Inc.

I. D. No: XXXX

Calibration results:		Before data: .....	After data: .....
Probe Sensitivity measured with Helmholtz Coil		Before & after data same: ...X.....	
<p><i>Helmholtz Coil;</i></p> <p>the number of turns on each coil;      10      No.</p> <p>the radius of each coil, in meters;      0.204      m</p> <p>the current in the coils, in amperes.;      0.08      A</p> <p><i>Helmholtz Coil Constant;</i>      6.99      A/m/V</p> <p><i>Helmholtz Coil magnetic field;</i>      5.90      A/m</p>			
Probe Sensitivity at		Laboratory Environment:	
was	1000 Hz.	Ambient Temperature:	24.4 °C
	-60.40 dBV/A/m	Ambient Humidity:	27.6 % RH
	0.955 mV/A/m	Ambient Pressure:	100.3 kPa
Probe resistance	897 Ohms	Calibration Date:	14-Jan-11 4:39 PM
		Re-calibration Due:	14-Jan-12
		Report Number:	20504 -5
		Control Number:	20504

The above listed instrument meets or exceeds the tested manufacturer's specifications.

This Calibration is traceable through NIST test numbers: ,205342

The expanded uncertainty of calibration: 0.28dB at 95% confidence level with a coverage factor of k=2.

Graph represents Probes Frequency Response.

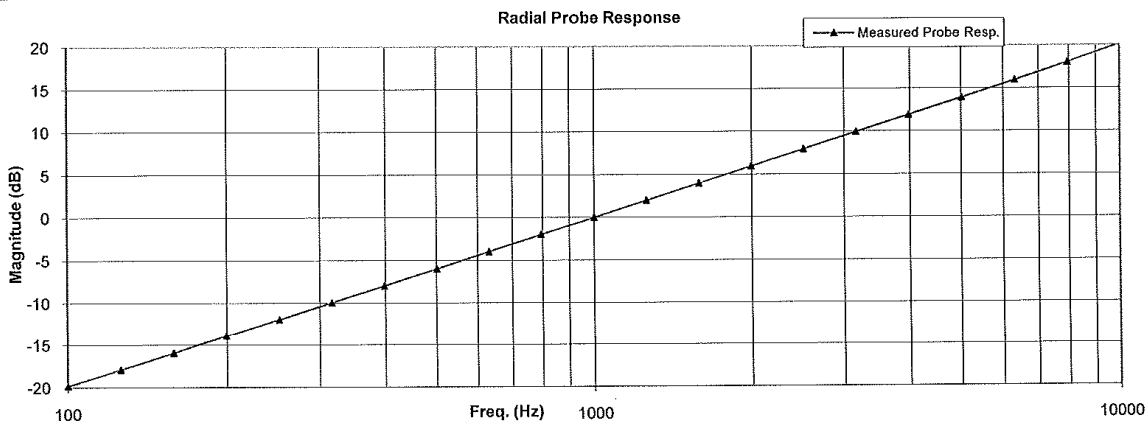

The above listed instrument was checked using calibration procedure documented in West Caldwell

Calibration Laboratories Inc. procedure :

Rev. 5.0 Sept. 10, 2010 Doc. # 1038 HCRTEMC

Calibration was performed by West Caldwell Calibration Laboratories Inc. under Operating Procedures

intended to implement the requirements of ISO10012-1, IEC Guide 25, ANSI/NCSL Z540-1, (MIL-STD-45662A) and ISO 9001:2008, ISO 17025

Cal. Date: 14-Jan-2011 4:39 PM

Measurements performed by: .....

Calibrated on WCCL system type 9700

Felix Christopher

This document shall not be reproduced, except in full, without the written approval from West Caldwell Cal. Labs. Inc.

Rev. 5.0 Sept. 10, 2010 Doc. # 1038 HCRTEMC

FCC ID: ZNFAS680		HAC (T-COIL) TEST REPORT		Reviewed by: Quality Manager
Filename: 0Y1107081120.ZNF	Test Dates: 7/19/2011 - 7/20/2011	EUT Type: Cellular/PCS CDMA/EVDO Phone with BT and WLAN		Page 31 of 37

HCRTEMC\_TEM-1128\_Jan-14-2011

West Caldwell Calibration Laboratories Inc.

1575 State Route 96, Victor NY 14564  
Tel. (585) 586-3900 FAX (585) 586-4327

*Calibration Data Record*

TEM Consulting LP Radial T Coil Probe      for      Model No.: Radial T Coil Probe      Serial No.: TEM-1128  
Company : PC Test Inc.

Test	Function	Tolerance	Measured values		
			Before	Out	Remarks
1.0	Probe Sensitivity at	1000 Hz.      dBV/A/m	-60.40		
2.0	Probe Level Linearity	Ref. (0 dB)	dB		
			6	6.03	
			0	0.00	
			-6	-6.02	
3.0	Probe Frequency Response	Ref. (0 dB)	Hz		
			100	-19.8	
			126	-17.9	
			158	-15.9	
			200	-13.9	
			251	-11.9	
			316	-9.9	
			398	-8.0	
			501	-6.0	
			631	-4.0	
			794	-2.0	
			1000	0.0	
			1259	2.0	
			1585	4.0	
			1995	6.0	
			2512	7.9	
			3162	9.9	
3981	11.9				
5012	13.9				
6310	15.9				
7943	18.0				
10000	20.2				

Instruments used for calibration:			Date of Cal.	Traceability No.	Due Date
HP	34401A	S/N US360641	8-Nov-2010	,205342	8-Nov-2011
HP	34401A	S/N US361024	8-Nov-2010	,205342	8-Nov-2011
HP	33120A	S/N S3604371	8-Nov-2010	,205342	8-Nov-2011
B&K	2133	S/N 1492410	1-Oct-2010	822/278767-10	1-Oct-2011



Cal. Date: 14-Jan-2011 4:39 PM

Tested by: Felix Christopher

Calibrated on WCCL system type 9700

This document shall not be reproduced, except in full, without the written approval from West Caldwell Cal. Labs. Inc.

Rev. 5.0 Sept. 10, 2010 Doc. # 1038 HCRTEMC



FCC ID: ZNFAS680		HAC (T-COIL) TEST REPORT		Reviewed by: Quality Manager
Filename: 0Y1107081120.ZNF	Test Dates: 7/19/2011 - 7/20/2011	EUT Type: Cellular/PCS CDMA/EVDO Phone with BT and WLAN		Page 32 of 37



## 11. CONCLUSION



The measurements indicate that the wireless communications device complies with the HAC limits specified in accordance with the ANSI C63.19 Standard and FCC WT Docket No. 01-309 RM-8658. Precise laboratory measures were taken to assure repeatability of the tests. The tested device complies with the requirements in respect to all parameters specific to the test. The test results and statements relate only to the item(s) tested.

The measurement system and techniques presented in this evaluation are proposed in the ANSI standard as a means of best approximating wireless device compatibility with a hearing-aid. The literature is under continual re-construction.



<b>FCC ID:</b> ZNFAS680		<b>HAC (T-COIL) TEST REPORT</b>		<b>Reviewed by:</b> Quality Manager
<b>Filename:</b> 0Y1107081120.ZNF	<b>Test Dates:</b> 7/19/2011 - 7/20/2011	<b>EUT Type:</b> Cellular/PCS CDMA/EVDO Phone with BT and WLAN		Page 33 of 37

## 12. REFERENCES

1. ANSI C63.19-2007, American National Standard for Methods of Measurement of Compatibility between Wireless communication devices and Hearing Aids.", New York, NY, IEEE, June 2007
2. FCC Public Notice DA 06-1215, *Wireless Telecommunications Bureau and Office of Engineering and Technology Clarify Use of Revised Wireless Phone Hearing Aid Compatibility Standard*, June 6, 2006
3. FCC 3G Review Guidance, Laboratory Division OET FCC, May/June 2006
4. Berger, H. S., "Compatibility Between Hearing Aids and Wireless Devices," Electronic Industries Forum, Boston, MA, May, 1997
5. Berger, H. S., "Hearing Aid and Cellular Phone Compatibility: Working Toward Solutions," *Wireless Telephones and Hearing Aids: New Challenges for Audiology*, Gallaudet University, Washington, D.C., May, 1997 (To be reprinted in the American Journal of Audiology).
6. Berger, H. S., "Hearing Aid Compatibility with Wireless Communications Devices," IEEE International Symposium on Electromagnetic Compatibility, Austin, TX, August, 1997.
7. Bronaugh, E. L., "Simplifying EMI Immunity (Susceptibility) Tests in TEM Cells," in the 1990 IEEE International Symposium on Electromagnetic Compatibility Symposium Record, Washington, D.C., August 1990, pp. 488-491
8. Byrne, D. and Dillon, H., The National Acoustics Laboratory (NAL) New Procedure for Selecting the Gain and Frequency Response of a Hearing Aid, Ear and Hearing 7:257-265, 1986.
9. Crawford, M. L., "Measurement of Electromagnetic Radiation from Electronic Equipment using TEM Transmission Cells," U.S. Department of Commerce, National Bureau of Standards, NBSIR 73-306, Feb. 1973.
10. Crawford, M. L., and Workman, J. L., "Using a TEM Cell for EMC Measurements of Electronic Equipment," U.S. Department of Commerce, National Bureau of Standards. Technical Note 1013, July 1981.
11. EHIMA GSM Project, Development phase, Project Report (1<sup>st</sup> part) Revision A. Technical-Audiological Laboratory and Telecom Denmark, October 1993.
12. EHIMA GSM Project, Development phase, Part II Project Report. Technical-Audiological Laboratory and Telecom Denmark, June 1994.
13. EHIMA GSM Project Final Report, Hearing Aids and GSM Mobile Telephones: Interference Problems, Methods of Measurement and Levels of Immunity. Technical-Audiological Laboratory and Telecom Denmark, 1995.
14. HAMPIS Report, Comparison of Mobile phone electromagnetic near field with an upscaled electromagnetic far field, using hearing aid as reference, 21 October 1999.
15. Hearing Aids/GSM, Report from OTWIDAM, Technical-Audiological Laboratory and Telecom Denmark, April 1993.

FCC ID: ZNFAS680		HAC (T-COIL) TEST REPORT		Reviewed by: Quality Manager
Filename: 0Y1107081120.ZNF	Test Dates: 7/19/2011 - 7/20/2011	EUT Type: Cellular/PCS CDMA/EVDO Phone with BT and WLAN		Page 34 of 37

16. IEEE 100, The Authoritative Dictionary of IEEE Standards Terms, Seventh Edition.
17. Joyner, K. H., et. al., Interference to Hearing Aids by the New Digital Mobile Telephone System, Global System for Mobile (GSM) Communication Standard, National Acoustic Laboratory, Australian Hearing Series, Sydney 1993.
18. Joyner, K. H., et. al., Interference to Hearing Aids by the Digital Mobile Telephone System, Global System for Mobile Communications (GSM), NAL Report #131, National Acoustic Laboratory, Australian Hearing Series, Sydney, 1995.
19. Kecker, W. T., Crawford, M. L., and Wilson, W. A., "Construction of a Transverse Electromagnetic Cell", U.S. Department of Commerce, National Bureau of Standards, Technical Note 1011, Nov. 1978.
20. Konigstein, D., and Hansen, D., "A New Family of TEM Cells with enlarged bandwidth and Optimized working Volume," in the Proceedings of the 7<sup>th</sup> International Symposium on EMC, Zurich, Switzerland, March 1987; 50:9, pp. 127-132.
21. Kuk, F., and Hjorstgaard, N. K., "Factors affecting interference from digital cellular telephones," Hearing Journal, 1997; 50:9, pp 32-34.
22. Ma, M. A., and Kanda, M., "Electromagnetic Compatibility and Interference Metrology," U.S. Department of Commerce, National Bureau of Standards, Technical Note 1099, July 1986, pp. 17-43.
23. Ma, M. A., Sreenivashiah, I. , and Chang, D. C., "A Method of Determining the Emission and Susceptibility Levels of Electrically Small Objects Using a TEM Cell," U.S. Department of Commerce, National Bureau of Standards, Technical Note 1040, July 1981.
24. McCandless, G. A., and Lyregaard, P. E., Prescription of Gain/Output (POGO) for Hearing Aids, Hearing Instruments 1:16-21, 1983
25. Skopec, M., "Hearing Aid Electromagnetic Interference from Digital Wireless Telephones, "IEEE Transactions on Rehabilitation Engineering, vol. 6, no. 2, pp. 235-239, June 1998.
26. Technical Report, GSM 05.90, GSM EMC Considerations, European Telecommunications Standards Institute, January 1993.
27. Victorian, T. A., "Digital Cellular Telephone Interference and Hearing Aid Compatibility—an Update," Hearing Journal 1998; 51:10, pp. 53-60
28. Wong, G. S. K., and Embleton, T. F. W., eds., AIP Handbook of Condenser Microphones: Theory, Calibration and Measurements, AIP Press.

<b>FCC ID:</b> ZNFAS680	 <b>PCTEST</b> <small>PROTECTING YOUR COMMUNICATIONS</small>	<b>HAC (T-COIL) TEST REPORT</b>	 <b>LG</b>	<b>Reviewed by:</b> Quality Manager
<b>Filename:</b> 0Y1107081120.ZNF	<b>Test Dates:</b> 7/19/2011 - 7/20/2011	<b>EUT Type:</b> Cellular/PCS CDMA/EVDO Phone with BT and WLAN	Page 35 of 37	