

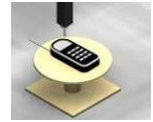

PCTEST ENGINEERING LABORATORY, INC.

6660-B Dobbin Road, Columbia, MD 21045 USA
Tel. 410.290.6652 / Fax 410.290.6554
http://www.pctestlab.com



HEARING AID COMPATIBILITY

Applicant Name:
LG Electronics MobileComm U.S.A., Inc.
10101 Old Grove Road,
San Diego, CA 92131
USA

Date of Testing:
1/6/2012
Test Site/Location:
PCTEST Lab, Columbia, MD, USA
Test Report Serial No.:
0Y1112192181.ZNF

FCC ID: ZNFA340

APPLICANT: LG ELECTRONICS MOBILECOMM U.S.A., INC.

Application Type: Certification
FCC Rule Part(s): § 20.19(b), §6.3(v), §7.3(v)
HAC Standard: ANSI C63.19-2007;
EUT Type: Portable Handset
Model(s): A340; LG-A340; LGA340
Test Device Serial No.: Pre-Production Sample [S/N: HAC RFE #1]

Band & Mode	Tx Frequency	C63.19-2007 HAC Category:
GSM/GPRS/EDGE 850	824.20 - 848.80 MHz	M3 (RF EMISSIONS CATEGORY)
WCDMA 850	826.40 - 846.60 MHz	
GSM/GPRS/EDGE 1900	1850.20 - 1909.80 MHz	
WCDMA 1900	1852.4 - 1907.6 MHz	
Bluetooth	2402 - 2480 MHz	

This wireless portable device has been shown to be hearing-aid compatible under the above rated category, specified in ANSI/IEEE Std. C63.19-2007 and had been tested in accordance with the specified measurement procedures. Hearing-Aid Compatibility is based on the assumption that all production units will be designed electrically identical to the device tested in this report. Test results reported herein relate only to the item(s) tested.

I attest to the accuracy of data. All measurements reported herein were performed by me or were made under my supervision and are correct to the best of my knowledge and belief. I assume full responsibility for the completeness of these measurements and vouch for the qualifications of all persons taking them.

PCTEST certifies that no party to this application has been subject to a denial of Federal benefits that includes FCC benefits pursuant to Section 5301 of the Anti-Drug Abuse Act of 1988, 21 U.S.C. 862.



Randy Ortañez
President



FCC ID: ZNFA340	PCTEST ENGINEERING LABORATORY, INC.	HAC (RF EMISSIONS) TEST REPORT	LG	Reviewed by: Quality Manager
Filename: 0Y1112192181.ZNF	Test Dates: 1/6/2012	EUT Type: Portable Handset	Page 1 of 80	

TABLE OF CONTENTS

1.	INTRODUCTION	3
2.	TEST SITE LOCATION	4
3.	EUT DESCRIPTION	5
4.	ANSI/IEEE C63.19 PERFORMANCE CATEGORIES.....	6
5.	SYSTEM SPECIFICATIONS.....	7
6.	TEST PROCEDURE	13
7.	SYSTEM CHECK	15
8.	MODULATION FACTOR.....	18
9.	FCC 3G MEASUREMENT PROCEDURES.....	20
10.	OVERALL MEASUREMENT SUMMARY	21
11.	EQUIPMENT LIST.....	24
12.	MEASUREMENT UNCERTAINTY	25
13.	TEST DATA.....	26
14.	CALIBRATION CERTIFICATES.....	39
15.	CONCLUSION.....	75
16.	REFERENCES	76
17.	TEST PHOTOGRAPHS	78

FCC ID: ZNFA340	 <small>ENGINEERING LABORATORY, INC.</small>	HAC (RF EMISSIONS) TEST REPORT	 LG	Reviewed by: Quality Manager
Filename: 0Y1112192181.ZNF	Test Dates: 1/6/2012	EUT Type: Portable Handset	Page 2 of 80	

1. INTRODUCTION

On July 10, 2003, the Federal Communications Commission (FCC) adopted new rules requiring wireless manufacturers and service providers to provide digital wireless phones that are compatible with hearing aids. The FCC has modified the exemption for wireless phones under the Hearing Aid Compatibility Act of 1998 (HAC Act) in WT Docket 01-309 RM-8658¹ to extend the benefits of wireless telecommunications to individuals with hearing disabilities. These benefits encompass business, social and emergency communications, which increase the value of the wireless network for everyone. An estimated more than 10% of the population in the United States show signs of hearing impairment and of that fraction, almost 80% use hearing aids. Approximately 500 million people worldwide suffer from hearing loss.

Compatibility Tests Involved:

The standard calls for wireless communications devices to be measured for:

- RF Electric-field emissions
- RF Magnetic-field emissions
- T-coil mode, magnetic-signal strength in the audio band
- T-coil mode, magnetic-signal frequency response through the audio band
- T-coil mode, magnetic-signal and noise articulation index

The hearing aid must be measured for:



- RF immunity in microphone mode
- RF immunity in T-coil mode

In the following tests and results, this report includes the evaluation for a wireless communications device.



Figure 1-1 Hearing Aid *in-vitu*

¹ FCC Rule & Order, WT Docket 01-309 RM-8658

FCC ID: ZNFA340	 PCTEST ENGINEERING LABORATORY, INC.	HAC (RF EMISSIONS) TEST REPORT	 LG	Reviewed by: Quality Manager
Filename: 0Y1112192181.ZNF	Test Dates: 1/6/2012	EUT Type: Portable Handset	Page 3 of 80	

2. TEST SITE LOCATION

2.1 INTRODUCTION

The map at the right shows the location of the PCTEST LABORATORY in Columbia, Maryland. It is in proximity to the FCC Laboratory, the Baltimore-Washington International (BWI) airport, the city of Baltimore and Washington, DC (See Figure 2).

These measurement tests were conducted at the PCTEST Engineering Laboratory, Inc. facility in New Concept Business Park, Guilford Industrial Park, Columbia, Maryland. The site address is 6660-B Dobbin Road, Columbia, MD 21045. The test site is one of the highest points in the Columbia area with an elevation of 390 feet above mean sea level. The site coordinates are 39° 11'15" N latitude and 76° 49' 38" W longitude. The facility is 1.5 miles North of the FCC laboratory, and the ambient signal and ambient signal strength are approximately equal to those of the FCC laboratory. There are no FM or TV transmitters within 15 miles of the site. The detailed description of the measurement facility was found to be in compliance with the requirements of § 2.948 according to ANSI C63.4 on January 27, 2006 and Industry Canada.



Figure 2-1
Map of the Greater Baltimore and Metropolitan Washington, D.C. area

2.2 Test Facility / Accreditations:

Measurements were performed at an independent accredited PCTEST Engineering Lab located in Columbia, MD 21045, U.S.A.

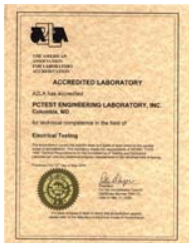

- PCTEST Lab is accredited to ISO 17025-2005 by the American Association for Laboratory Accreditation (A2LA) in Specific Absorption Rate (SAR) testing, Hearing-Aid Compatibility (HAC), CTIA Test Plans, and wireless testing for FCC and Industry Canada Rules.
- PCTEST Lab is accredited to ISO 17025 by U.S. National Institute of Standards and Technology (NIST) under the National Voluntary Laboratory Accreditation Program (NVLAP Lab code: 100431-0) in EMC, FCC and Telecommunications.
- PCTEST facility is an FCC registered (PCTEST Reg. No. 90864) test facility with the site description report on file and has met all the requirements specified in Section 2.948 of the FCC Rules and Industry Canada (IC-2451).
- PCTEST Lab is a recognized U.S. Conformity Assessment Body (CAB) in EMC and R&TTE (n.b. 0982) under the U.S.-EU Mutual Recognition Agreement (MRA).
- PCTEST TCB is a Telecommunication Certification Body (TCB) accredited to ISO/IEC Guide 65 by the American National Standards Institute (ANSI) in all scopes of FCC Rules and all Industry Canada Standards (RSS).
- PCTEST facility is an IC registered (IC-2451) test laboratory with the site description on file at Industry Canada.
- PCTEST is a CTIA Authorized Test Laboratory (CATL) for AMPS and CDMA, and EvDO mobile phones.
- PCTEST is a CTIA Authorized Test Laboratory (CATL) for Over-the-Air (OTA) Antenna Performance testing for AMPS, CDMA, GSM, GPRS, EGPRS, UMTS (W-CDMA), CDMA 1xEVDO Data, CDMA 1xRTT Data.

FCC ID: ZNFA340	PCTEST ENGINEERING LABORATORY, INC.	HAC (RF EMISSIONS) TEST REPORT	LG	Reviewed by: Quality Manager
Filename: 0Y1112192181.ZNF	Test Dates: 1/6/2012	EUT Type: Portable Handset	Page 4 of 80	

3. EUT DESCRIPTION



FCC ID: ZNFA340
 Manufacturer: LG Electronics MobileComm U.S.A., Inc.
 10101 Old Grove Road,
 San Diego, CA 92131
 USA
 Model(s): A340; LG-A340; LGA340
 Serial Number: HAC RFE #1
 Tx Frequencies: 824.20 - 848.80 MHz (GSM 850)
 1850.20 - 1909.80 MHz (GSM 1900)
 826.40 - 846.60 MHz (WCDMA 850)
 1852.4 - 1907.6 MHz (WCDMA 1900)
 Antenna Configurations: Internal Antenna
 Maximum Tested 32.56 dBm (GSM 850), 30.11 dBm (GSM 1900),
 Conducted Power (HAC): 23.65 dBm (WCDMA 850), 23.22 dBm (WCDMA 1900)
 HAC Test Configurations: GSM 850, 128, 190, 251, BT Off
 GSM 1900, 512, 661, 810, BT Off
 WCDMA 850, 4132, 4183, 4233, BT Off
 WCDMA 1900, 9262, 9400, 9538, BT Off
 EUT Type: Portable Handset

Air-Interface	Band (MHz)	Type	C63.19-2007 tested	Simultaneous Transmissions Scenarios in voice modes (Not to be tested)	Reduced power 20.19 (c)(1)	VOIP
GSM	850	Voice	Yes	Yes: BT	NA	N/A
	1900	Voice	Yes	Yes: BT	NA	N/A
	GPRS/EDGE	Data	NA	NA	NA	Yes
WCDMA	835	Voice	Yes	Yes: BT	NA	N/A
	1900	Voice				
	HSDPA	Data	NA	NA	NA	Yes
BT	2450	Data	NA	Yes: GSM or WCDMA	NA	NA

NOTE: HAC Rating was not based on concurrent voice and data modes. Standalone mode was found to represent worst case rating for both M and T rating.

Table 3: ZNFA340 Air Interfaces

FCC ID: ZNFA340	PCTEST ENGINEERING LABORATORY, INC.	HAC (RF EMISSIONS) TEST REPORT	LG	Reviewed by: Quality Manager
Filename: OY1112192181.ZNF	Test Dates: 1/6/2012	EUT Type: Portable Handset		Page 5 of 80

4. ANSI/IEEE C63.19 PERFORMANCE CATEGORIES



I. RF EMISSIONS

The ANSI Standard presents performance requirements for acceptable interoperability of hearing aids with wireless communications devices. When these parameters are met, a hearing aid operates acceptably in close proximity to a wireless communications device.

Category	Telephone RF Parameters	
Near field Category	E-field emissions CW dB(V/m)	H-field emissions CW dB(A/m)
f < 960 MHz		
M1	56 to 61 + 0.5 x AWF	5.6 to 10.6 +0.5 x AWF
M2	51 to 56 + 0.5 x AWF	0.6 to 5.6 +0.5 x AWF
M3	46 to 51 + 0.5 x AWF	-4.4 to 0.6 +0.5 x AWF
M4	< 46 + 0.5 x AWF	< -4.4 + 0.5 x AWF
f > 960 MHz		
M1	46 to 51 + 0.5 x AWF	-4.4 to 0.6 +0.5 x AWF
M2	41 to 46 + 0.5 x AWF	-9.4 to -4.4 +0.5 x AWF
M3	36 to 41 + 0.5 x AWF	-14.4 to -9.4 +0.5 x AWF
M4	< 36 + 0.5 x AWF	< -14.4 + 0.5 x AWF
Table 4-1 Hearing aid and WD near-field categories as defined in ANSI C63.19-2007 [2]		

II. ARTICULATION WEIGHTING FACTOR (AWF)

Standard	Technology	Articulation Weighing Factor (AWF)
T1/T1P1/3GPP	UMTS (WCDMA)	0
TIA/EIA/IS-2000	CDMA	0
iDEN™	TDMA (22 and 11 Hz)	0
J-STD-007	GSM (217 Hz)	-5
Table 4-2 Articulation Weighing Factors		

FCC ID: ZNFA340		HAC (RF EMISSIONS) TEST REPORT		Reviewed by: Quality Manager
Filename: OY1112192181.ZNF	Test Dates: 1/6/2012	EUT Type: Portable Handset	Page 6 of 80	

5. SYSTEM SPECIFICATIONS

ER3DV6 E-Field Probe Description

Construction:	One dipole parallel, two dipoles normal to probe axis Built-in shielding against static charges
Calibration:	In air from 100 MHz to 3.0 GHz (absolute accuracy $\pm 6.0\%$, $k=2$)
Frequency:	100 MHz to > 6 GHz; Linearity: ± 0.2 dB (100 MHz to 3 GHz)
Directivity	± 0.2 dB in air (rotation around probe axis) ± 0.4 dB in air (rotation normal to probe axis)
Dynamic Range	2 V/m to > 1000 V/m (M3 or better device readings fall well below diode compression point)
Linearity:	± 0.2 dB
Dimensions	Overall length: 330 mm (Tip: 16 mm) Tip diameter: 8 mm (Body: 12 mm) Distance from probe tip to dipole centers: 2.5 mm

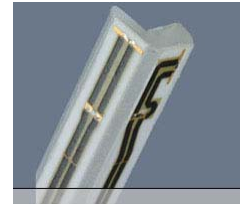

Figure 5-1
E-field Free-space Probe

H3DV6 H-Field Probe Description

Construction:	Three concentric loop sensors with 3.8 mm loop diameters Resistively loaded detector diodes for linear response Built-in shielding against static charges
Frequency:	200 MHz to 3 GHz (absolute accuracy $\pm 6.0\%$, $k=2$); Output linearized
Directivity:	± 0.25 dB (spherical isotropy error)
Dynamic Range:	10 mA/m to 2 A/m at 1 GHz (M3 or better device readings fall well below diode compression point)
Dimensions:	Overall length: 330 mm (Tip: 40 mm) Tip diameter: 6 mm (Body: 12 mm) Distance from probe tip to dipole centers: 3 mm
E-Field Interference:	< 10% at 3 GHz (for plane wave)





Figure 5-2
H-Field Free-space Probe

Probe Tip Description

HAC field measurements take place in the close near field with high gradients. Increasing the measuring distance from the source will generally decrease the measured field values (in case of the validation dipole approx. 10% per mm).

Magnetic field sensors are measuring the integral of the H-field across their sensor area surrounded by the loop. They are calibrated in a precise, homogeneous field. When measuring a gradient field, the result will be very close to the field in the center of the loop which is equivalent to the value of a homogeneous field equivalent to the center value. But it will be different from the field at the border of the loop.

FCC ID: ZNFA340	 PCTEST ENGINEERING LABORATORY, INC.	HAC (RF EMISSIONS) TEST REPORT	 LG	Reviewed by: Quality Manager
Filename: 0Y1112192181.ZNF	Test Dates: 1/6/2012	EUT Type: Portable Handset		Page 7 of 80

Consequently, two sensors with different loop diameters - both calibrated ideally - would give different results when measuring from the edge of the probe sensor elements. The behavior for electrically small E-field sensors is equivalent.

The magnetic field loops of the H3D probes are concentric, with the center 3mm from the tip for H3DV6. Their radius is 1.9mm.

The electric field probes have a more irregular internal geometry because it is physically not possible to have the 3 orthogonal sensors situated with the same center. The effect of the different sensor centers is accounted for in the HAC uncertainty budget ("sensor displacement"). Their geometric center is at 2.5mm from the tip, and the element ends are 1.1mm closer to the tip.

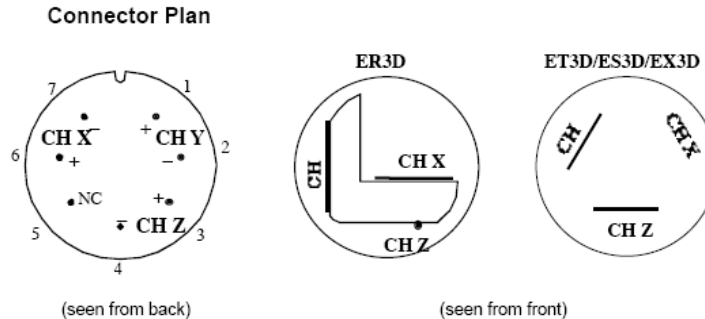

The antistatic shielding inside the probe is connected to the probe connector case.

Instrumentation Chain

Equation 1

Conversion of Connector Voltage u_i to E-Field E_i

$$E_i = \sqrt{\frac{u_i + (u_i^2 \cdot CF) / (DCP)}{Norm_i \cdot ConvF}}$$

whereby

- E_i : electric field in V/m
- u_i : voltage of channel i at the connector in μV
- $Norm_i$: sensitivity of channel i in $\mu V / (V/m)^2$
- $ConvF$: enhancement factor in liquid (ConvF=1 for Air)
- DCP : diode compression point in μV
- CF : signal crest factor (peak power/average power)

Conditions of Calibration

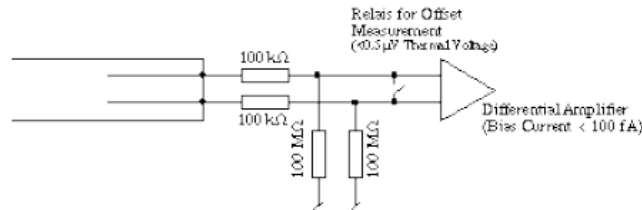

- Please note:
- a lower input impedance of the amplifier will result in different sensitivity factors $Norm_i$ and DCP
 - larger bias currents will cause higher offset

FCC ID: ZNFA340	PCTEST ENGINEERING LABORATORY, INC.	HAC (RF EMISSIONS) TEST REPORT	LG	Reviewed by: Quality Manager
Filename: 0Y1112192181.ZNF	Test Dates: 1/6/2012	EUT Type: Portable Handset		Page 8 of 80

Probe Response to Frequency

The E-field sensors have inherently a very flat frequency response. They are calibrated with a number of frequencies resulting in a common calibration factor, with the frequency behavior documented in the calibration certificate (See also below).

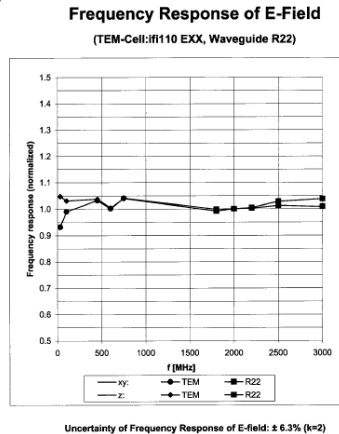

Figure 5-3 E-Field Probe Frequency Response

H-field sensors have a frequency dependent sensitivity which is evaluated for a series of frequencies also visible in the probe calibration certificate. The calibration factors result from a fitting algorithm. The proper conversion is calculated by the DASY4 software depending on the frequency setting in the procedure. See below for H-field frequency response:

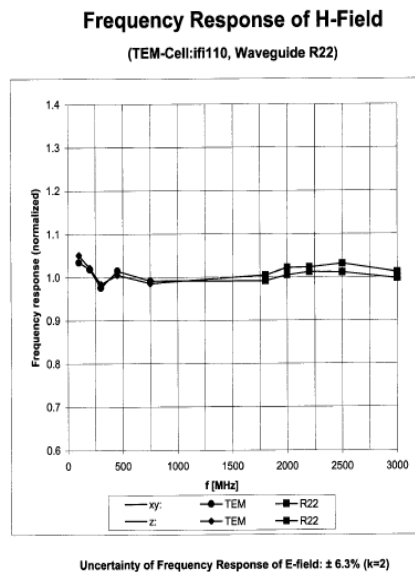



Figure 5-4 H-Field Probe Frequency Response

FCC ID: ZNFA340	 PCTEST ENGINEERING LABORATORY, INC.	HAC (RF EMISSIONS) TEST REPORT	 LG	Reviewed by: Quality Manager
Filename: 0Y1112192181.ZNF	Test Dates: 1/6/2012	EUT Type: Portable Handset	Page 9 of 80	

Conversion to Peak

Peak is defined as Peak Envelope Power. All raw measurements from the HAC measurement system are RMS values. The DASY4 system incorporates the crest factor of the signal in the computation of the RMS values (See Equation 1). Although the software also has capability to estimate the peak field by applying a square root of crest factor value to the readings, the probe modulation factor was applied manually instead per C63.19 in the measurement tables in this report. The equation to convert the raw measurements in the data tables are:

$$\text{Peak Field} = 20 \cdot \log(\text{Raw} \cdot \text{PMF})$$

Where:

Peak Field = Peak field (in dBV/m or dBA/m)

Raw = Raw field measurement from the measurement system (in V/m or A/m).

PMF = Probe Modulation Factor (in linear units).

SPEAG Robotic System



E-field and H-field measurements are performed using the DASY4 automated dosimetric assessment system. The DASY4 is made by Schmid & Partner Engineering AG (SPEAG) in Zurich, Switzerland and consists of high precision robotics system (Staubli), robot controller, Pentium 4 computer, near-field probe, probe alignment sensor, and the HAC phantom. The robot is a six-axis industrial robot performing precise movements to position the probe to the location (points) of maximum electromagnetic field (EMF).



Figure 5-5
SPEAG Robotic System

System Hardware

A cell controller system contains the power supply, robot controller, teach pendant (Joystick), and a remote control used to drive the robot motors. The PC consists of the Gateway Pentium 4 2.53 GHz computer with Windows XP system and RF Measurement Software DASY4 v4.5 (with HAC Extension), A/D interface card, monitor, mouse, and keyboard. The Staubli Robot is connected to the cell controller to allow software manipulation of the robot. A data acquisition electronic (DAE) circuit that performs the signal amplification, signal multiplexing, AD-conversion, offset measurements, mechanical surface detection, collision detection, etc. is connected to the Electro-optical coupler (EOC). The EOC performs the conversion from the optical into digital electric signal of the DAE and transfers data to the PC plug-in card.

FCC ID: ZNFA340	 PCTEST ENGINEERING LABORATORY, INC.	HAC (RF EMISSIONS) TEST REPORT	 LG	Reviewed by: Quality Manager
Filename: 0Y1112192181.ZNF	Test Dates: 1/6/2012	EUT Type: Portable Handset		Page 10 of 80

System Electronics

The DAE consists of a highly sensitive electrometer-grade preamplifier with auto-zeroing, a channel and gain-switching multiplexer, a fast 16 bit AD-converter and a command decoder and control logic unit. Transmission to the PC-card is accomplished through an optical downlink for data and status information and an optical uplink for commands and clock lines. The mechanical probe mounting device includes two different sensor systems for frontal and sidewise probe contacts. They are also used for mechanical surface detection and probe collision detection. The robot uses its own controller with a built in VME-bus computer.

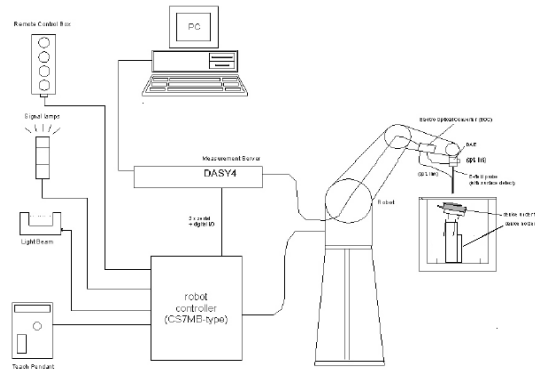



Figure 5-6
SPEAG Robotic System Diagram

DASY4 Instrumentation Chain

The first step of the evaluation is a linearization of the filtered input signal to account for the compression characteristics of the detector diode. The compensation depends on the input signal, the diode type and the DC-transmission factor from the diode to the evaluation electronics. If the exciting field is pulsed, the crest factor of the signal must be known to correctly compensate for peak power. The formula for each channel can be given as:

$$V_i = U_i + U_i^2 \cdot \frac{cf}{dcp_i}$$

with V_i	= compensated signal of channel i	(i = x, y, z)
U_i	= input signal of channel i	(i = x, y, z)
cf	= crest factor of exciting field	(DASY parameter)
dcp_i	= diode compression point	(DASY parameter)

FCC ID: ZNFA340	 PCTEST ENGINEERING LABORATORY, INC.	HAC (RF EMISSIONS) TEST REPORT	 LG	Reviewed by: Quality Manager
Filename: 0Y1112192181.ZNF	Test Dates: 1/6/2012	EUT Type: Portable Handset		Page 11 of 80

From the compensated input signals the primary field data for each channel can be evaluated:

$$\text{E - field probes : } E_i = \sqrt{\frac{V_i}{Norm_i \cdot ConvF}}$$

$$\text{H - field probes : } H_i = \sqrt{V_i} \cdot \frac{a_{i0} + a_{i1}f + a_{i2}f^2}{f}$$

- with V_i = compensated signal of channel i (i = x, y, z)
 $Norm_i$ = sensor sensitivity of channel i (i = x, y, z)
 $\mu\text{V}/(\text{V/m})^2$ for E-field Probes
 $ConvF$ = sensitivity enhancement in solution
 a_{ij} = sensor sensitivity factors for H-field probes
 f = carrier frequency [GHz]
 E_i = electric field strength of channel i in V/m
 H_i = magnetic field strength of channel i in A/m

The RSS value of the field components gives the total field strength (Hermitian magnitude):



$$E_{tot} = \sqrt{E_x^2 + E_y^2 + E_z^2}$$

The primary field data are used to calculate the derived field units.

The measurement/integration time per point, as specified by the system manufacturer is >500 ms.

The signal response time is evaluated as the time required by the system to reach 90% of the expected final value after an on/off switch of the power source with an integration time of 500 ms and a probe response time of <5 ms. In the current implementation, DASY4 waits longer than 100 ms after having reached the grid point before starting a measurement, i.e., the response time uncertainty is negligible.

If the device under test does not emit a CW signal, the integration time applied to measure the electric field at a specific point may introduce additional uncertainties due to the discretization. The tolerances for the different systems had the worst-case of 2.6%.

FCC ID: ZNFA340	 PCTEST ENGINEERING LABORATORY, INC.	HAC (RF EMISSIONS) TEST REPORT	 LG	Reviewed by: Quality Manager
Filename: 0Y1112192181.ZNF	Test Dates: 1/6/2012	EUT Type: Portable Handset	Page 12 of 80	

6. TEST PROCEDURE

I. RF EMISSIONS

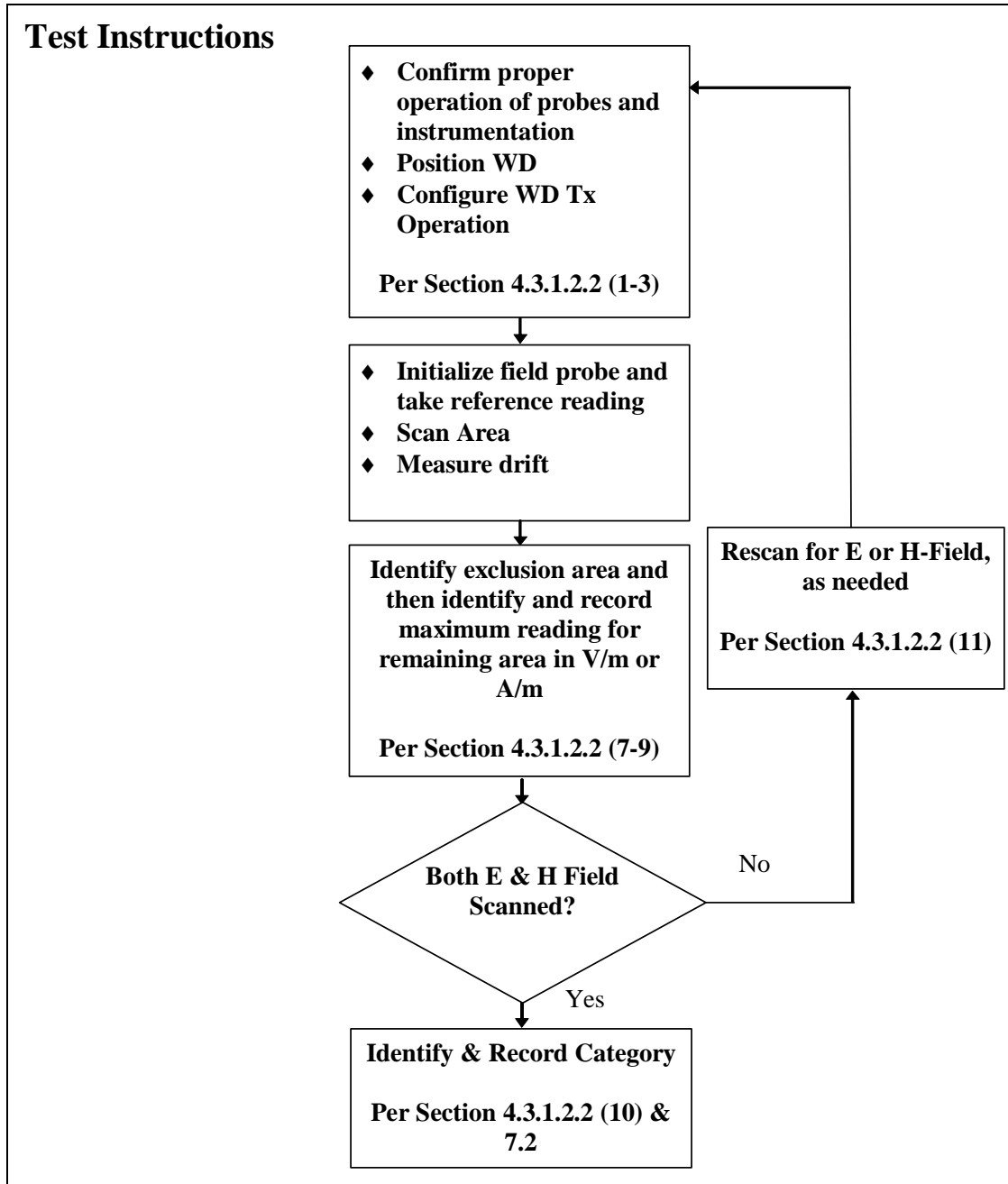



Figure 6-1 RF Emissions Flow Chart

FCC ID: ZNFA340	 PCTEST ENGINEERING LABORATORY, INC.	HAC (RF EMISSIONS) TEST REPORT	 LG	Reviewed by: Quality Manager
Filename: OY1112192181.ZNF	Test Dates: 1/6/2012	EUT Type: Portable Handset		Page 13 of 80

Test Setup

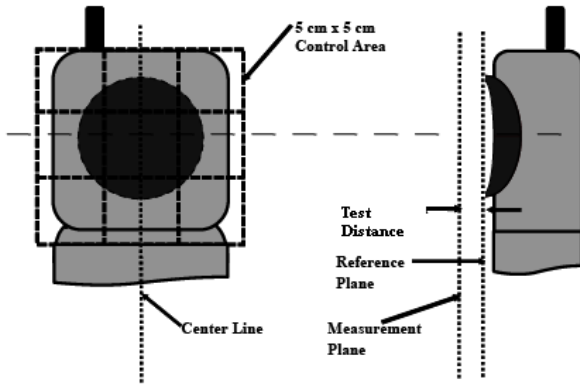

Figure 6-2

E/H-Field Emissions Test Setup Diagram (See Test Photographs for actual WD scan grid overlay)

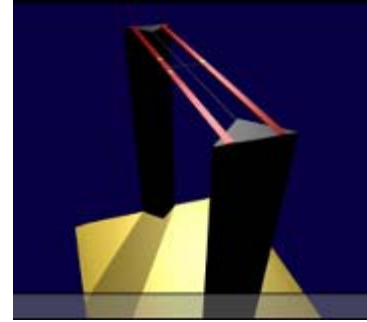



Figure 6-3
HAC Phantom

RF Emissions Test Procedure:

The following illustrate a typical RF emissions test scan over a wireless communications device:

1. Proper operation of the field probe, probe measurement system, other instrumentation, and the positioning system was confirmed.
2. WD is positioned in its intended test position, acoustic output point of the device perpendicular to the field probe.
3. The WD operation for maximum rated RF output power was configured and confirmed with the base station simulator, at the test channel and other normal operating parameters as intended for the test. The battery was ensured to be fully charged before each test.
4. The center sub-grid was centered over the center of the acoustic output (also audio band magnetic output, if applicable). The WD audio output was positioned tangent (as physically possible) to the measurement plane.
5. A surface calibration was performed before each setup change to ensure repeatable spacing and proper maintenance of the measurement plane using the HAC Phantom.
6. The measurement system measured the field strength at the reference location.
7. Measurements at 2mm or 5mm increments in the 5 x 5 cm region were performed at a distance 15 mm from the center point of the probe measurement element to the WD. A 360° rotation about the azimuth axis at the maximum interpolated position was measured. For the worst-case condition, the peak reading from this rotation was used in re-evaluating the HAC category.
8. The system performed a drift evaluation by measuring the field at the reference location.
9. Steps 1-8 were done for both the E and H-Field measurements.

FCC ID: ZNFA340	 PCTEST ENGINEERING LABORATORY, INC.	HAC (RF EMISSIONS) TEST REPORT	 LG	Reviewed by: Quality Manager
Filename: OY1112192181.ZNF	Test Dates: 1/6/2012	EUT Type: Portable Handset		Page 14 of 80

7. SYSTEM CHECK

I. System Check Parameters

The input signal was an un-modulated continuous wave. The following points were taken into consideration in performing this check:

- Average Input Power $P = 100\text{mW RMS}$ (20dBm RMS) after adjustment for return loss
- The test fixture must meet the 2 wavelength separation criterion
- The proper measurement of the 1 cm probe to dipole separation, which is measured from top surface of the dipole to the calibration reference point of the sensor, defined by the probe manufacturer is shown in the following diagram:

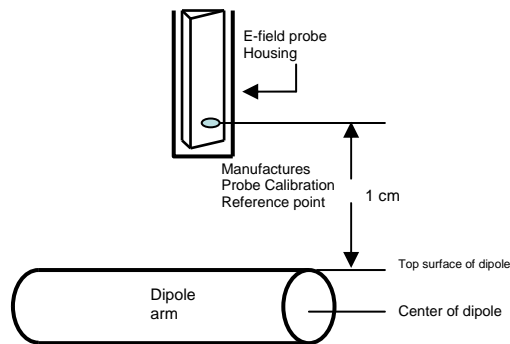

Figure 7-1

Separation Distance from Dipole to Field Probe

RF power was recorded using both an average reading meter and a peak reading meter. Readings of the probe are provided by the measurement system.

To assure proper operation of the near-field measurement probe the input power to the dipole shall be commensurate with the full rated output power of the wireless device (e.g. - for a cellular phone wireless device the average peak antenna input power will be on the order of 100mW (i.e. - 20dBm) RMS after adjustment for any mismatch.



II. Validation Procedure

A dipole antenna meeting the requirements given in C63.19 was placed in the position normally occupied by the WD.

The length of the dipole was scanned with both E-field and H-field probes and the maximum values for each were recorded.

Measurement of CW

Using the near-field measurement system, scan the antenna over the radiating dipole and record the greatest field reading observed. Due to the nature of E-fields about free-space dipoles, the two E-field peaks measured over the dipole are averaged to compensate for non-parallelity of the setup (

FCC ID: ZNFA340	 PCTEST ENGINEERING LABORATORY, INC.	HAC (RF EMISSIONS) TEST REPORT	 LG	Reviewed by: Quality Manager
Filename: 0Y1112192181.ZNF	Test Dates: 1/6/2012	EUT Type: Portable Handset		Page 15 of 80

see manufacturer method on dipole calibration certificates, page 2). Field strength measurements shall be made only when the probe is stationary.

RF power was recorded using both an average and a peak power reading meter.

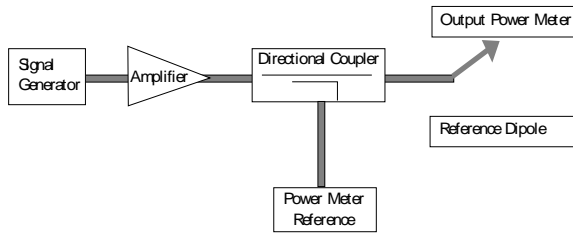

Figure 7-2

Setup for Desired Output Power to Dipole

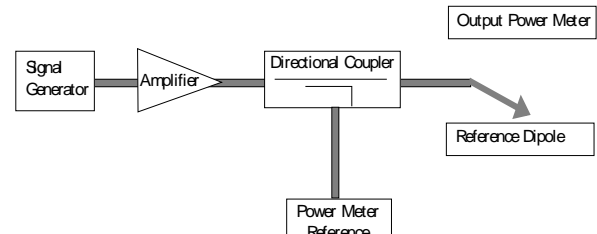

Figure 7-3

Setup to Dipole

Using this setup configuration, the signal generator was adjusted for the desired output power (100mW) at a specified frequency. The reference power from the coupled port of the directional coupler is recorded. Next, the output cable is connected to the reference dipole, as shown in Figure 7-3.

The input signal level was adjusted until the reference power from the coupled port of the directional coupler was the same as previously recorded, to compensate for the impedance mismatch between the output cable and the reference dipole. To assure proper operation of the near-field measurement probe the input power to the reference dipole was verified to the full rated output power of the wireless device. The dipole was secured in a holder in a manner to meet the 20 dB reflection. The near-field measurement probe was positioned over the dipole. The antenna was scanned over the appropriate sized area to cover the dipole from end to end. SPEAG uses 2D interpolation algorithms between the measured points. Please see below two dimensional plots showing that the interpolated values interpolate smoothly between 5mm steps for a free-space RF dipole:

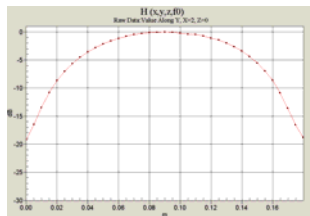

Figure 7-4

2-D Raw Data from scan along dipole axis

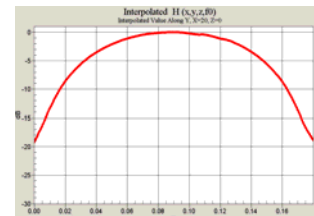

Figure 7-5

2-D Interpolated points from scan along dipole axis

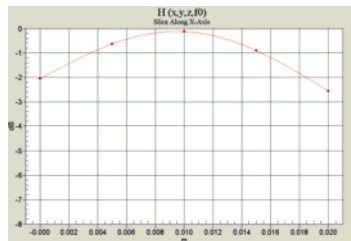

Figure 7-6

2-D Raw Data from scan along transverse axis

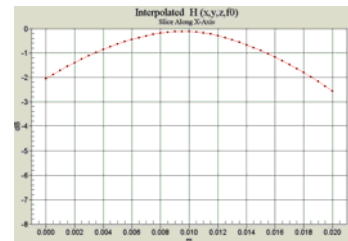



Figure 7-7

2-D Interpolated points from scan along transverse axis

FCC ID: ZNFA340	 PCTEST ENGINEERING LABORATORY, INC.	HAC (RF EMISSIONS) TEST REPORT	 LG	Reviewed by: Quality Manager
Filename: OY1112192181.ZNF	Test Dates: 1/6/2012	EUT Type: Portable Handset		Page 16 of 80

III. System Check Results

Validation Results

Frequency (MHz)	Input Power (dBm)	E-field Result (V/m)	Target Field (V/m)	% Deviation
835	20.0	157.8	166.0	-4.9%
1880	20.0	145.6	136.8	6.4%
Frequency (MHz)	Input Power (dBm)	H-field Result (A/m)	Target Field (A/m)	% Deviation
835	20.0	0.435	0.458	-5.0%
1880	20.0	0.460	0.460	0.0%

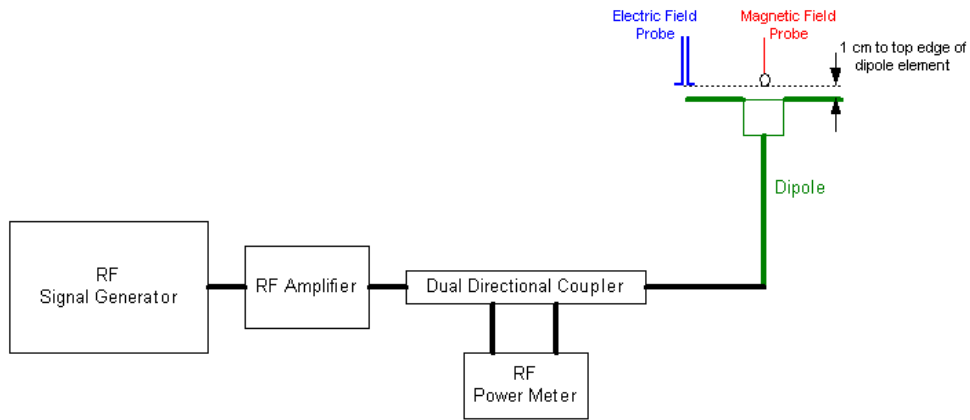



Figure 7-8
System Check Setup

FCC ID: ZNFA340	 PCTEST ENGINEERING LABORATORY, INC.	HAC (RF EMISSIONS) TEST REPORT	 LG	Reviewed by: Quality Manager
Filename: 0Y1112192181.ZNF	Test Dates: 1/6/2012	EUT Type: Portable Handset		Page 17 of 80

8. MODULATION FACTOR

A calibration was made of the modulation response of the probe and its instrumentation chain. This calibration was performed with the field probe, attached to its instrumentation. The response of the probe system to a CW field at the frequency of interest is compared to its response to a modulated signal with equal peak amplitude to that of a CW signal. The field level of the test signals are ensured to be more than 10 dB above the ambient level and the noise floor of the instrumentation being used. The ratio of the CW reading to that taken with a modulated reading was applied to the DUT measurements.

All voice modes for this device have been investigated in this section of the report. According to the FCC 3G Measurement Procedures, May 2006 for RF Emissions, variations in peak field and power readings.

This was done using the following procedure:

1. The probe was illuminated with a CW signal at the intended measurement frequency and wireless device power.
2. The probe was positioned at the field maxima over the dipole antenna (determined after an area scan over the dipole) illuminated with the CW signal.
3. The reading of the probe measurement system of the CW signal at the maximum point was recorded.
4. Using a Spectrum Analyzer, the modulated signal adjusted with the same peak level of the CW signal was determined.
5. The probe measurement system reading was recorded with the modulated signal. The appropriate system crest factors for the modulation type were configured in the software to the system measurements.
6. The ratio of the CW reading to modulated signal reading is the probe modulation factor (PMF) for the modulation and field probe combination. This was repeated for 80% AM.
7. Steps 1-6 were repeated at all frequency bands and for both E and H field probes.



The modulation factors obtained were applied to readings taken of the actual wireless device, in order to obtain an accurate peak field reading using the formula:

$$\text{Peak} = 20 \cdot \log (\text{Raw} \cdot \text{PMF})$$

Modulation Factors:

f (MHz)	Protocol	E-Field (V/m)	H-Field (A/m)	E-Field Modulation Factor	H-Field Modulation Factor	f (MHz)	Protocol	E-Field (V/m)	H-Field (A/m)	E-Field Modulation Factor	H-Field Modulation Factor
835	AM	629.3	2.212	1.290	0.910	835	AM	175.1	0.4947	1.385	1.313
835	GSM	287	1.033	2.829	1.948	835	WCDMA	252.3	0.703	0.961	0.924
835	CW	811.8	2.012			835	CW	242.5	0.6497		
1880	AM	390.8	1.215	1.319	1.115	1880	AM	129.2	0.5285	1.449	1.219
1880	GSM	184.8	0.5843	2.790	2.319	1880	WCDMA	192.5	0.6853	0.972	0.940
1880	CW	515.6	1.355			1880	CW	187.2	0.6442		

Figure 8-1
Modulation Factors

FCC ID: ZNFA340	 PCTEST ENGINEERING LABORATORY, INC.	HAC (RF EMISSIONS) TEST REPORT	 LG	Reviewed by: Quality Manager
Filename: 0Y1112192181.ZNF	Test Dates: 1/6/2012	EUT Type: Portable Handset	Page 18 of 80	

Spectrum Analyzer Plots of ESG-D Signal used for PMF measurements:

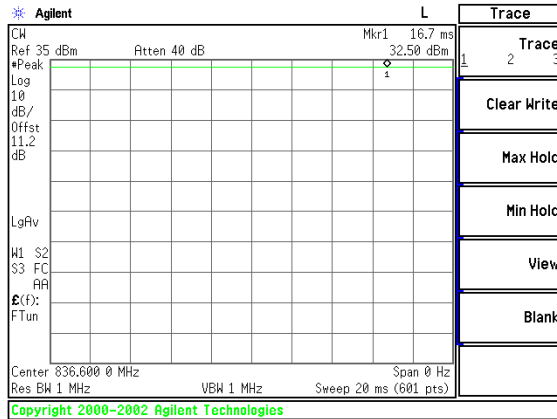

Figure 8-2 GSM850 CW Signal

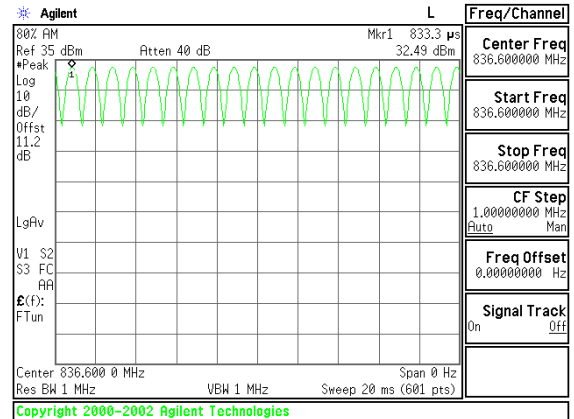

Figure 8-3 GSM850 80% AM Signal

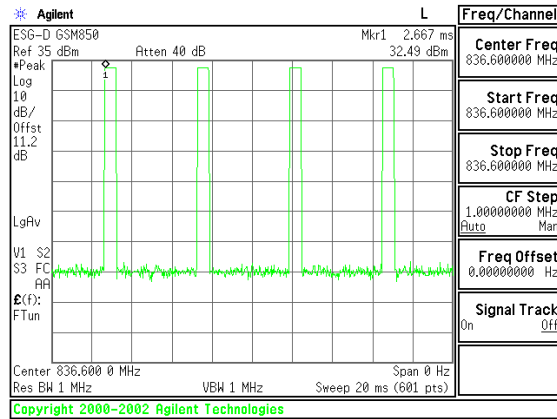

Figure 8-4 GSM850 Signal

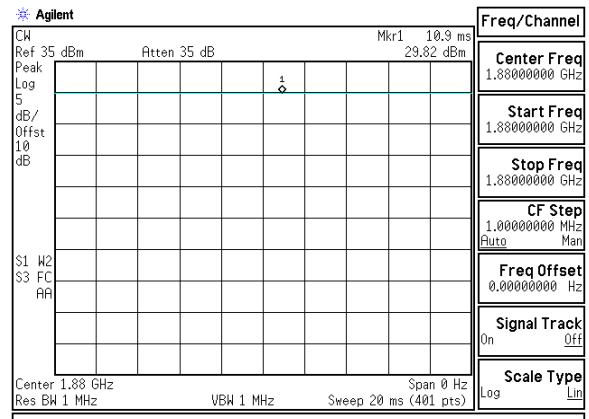

Figure 8-5 PCS CW Signal

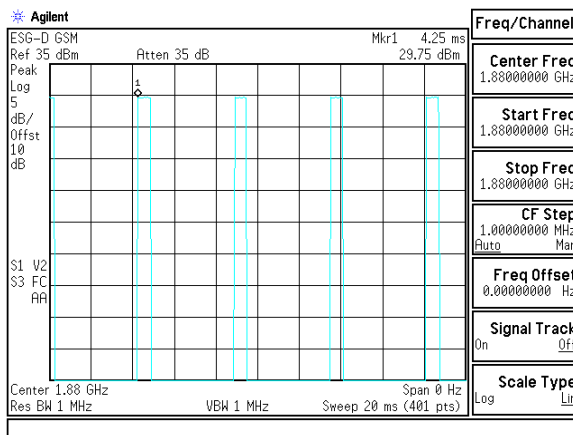

Figure 8-6 PCS GSM Signal

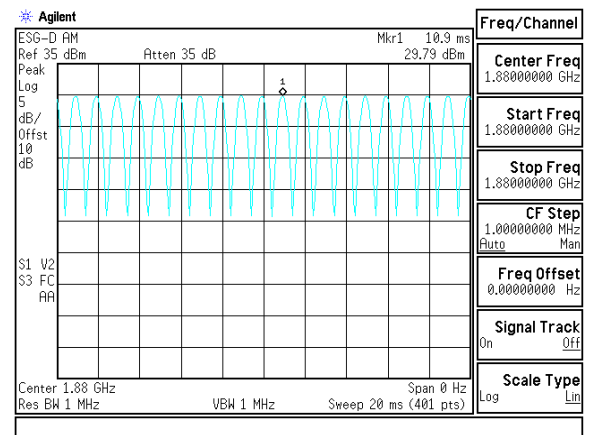

Figure 8-7 PCS 80% AM Signal

FCC ID: ZNFA340	PCTEST <small>ENGINEERING LABORATORY, INC.</small>	HAC (RF EMISSIONS) TEST REPORT	
Filename: OY1112192181.ZNF	Test Dates: 1/6/2012	EUT Type: Portable Handset	Reviewed by: Quality Manager
			Page 19 of 80

9. FCC 3G MEASUREMENT PROCEDURES

Power measurements were performed using a base station simulator under digital average power.

I. Procedures Used to Establish RF Signal for HAC Testing

The handset was placed into a simulated call using a base station simulator in a shielded chamber. Such test signals offer a consistent means for testing HAC and are recommended for evaluating HAC. Measurements were taken with a fully charged battery. In order to verify that the device was tested and maintained at full power, this was configured with the base station simulator. The HAC measurement software calculates a reference point at the start and end of the test to check for power drifts. If conducted power deviations of more than 5% occurred, the tests were repeated.

II. HAC Measurement Conditions for UMTS

Output Power Verification



Maximum output power is verified on the High, Middle and Low channels according to the general descriptions in section 5.2 of 3GPP TS 34.121, using the appropriate RMC or AMR with TPC (transmit power control) set to all "1s".

HAC Measurements

HAC is measured using the 12.2 kbps RMC with TPC bits configured to all "1s". HAC in AMR configurations is not required when the maximum average output of each RF channel for 12.2 kbps AMR is less than ¼ dB higher than that measured in 12.2 kbps RMC. Otherwise, HAC is measured on the maximum output channel in 12.2 AMR with a 3.4 kbps SRB (signaling radio bearer) using the configuration that results in the highest HAC for that RF channel in 12.2 RMC.

WCDMA RF Conducted Power Table						GSM RF Conducted Power Table		
Band	Channel	HSDPA Inactive		HSDPA Active		Band	Channel	Voice GSM [dBm] CS (1 Slot)
		12.2 kbps RMC [dBm]	12.2 kbps AMR [dBm]	12.2 kbps RMC [dBm]	12.2 kbps AMR [dBm]			
WCDMA 850	4132	23.64	23.60	23.85	23.84	GSM 850	128	32.56
	4183	23.65	23.59	23.87	23.85		190	32.48
	4233	23.62	23.57	23.85	23.78		251	32.44
WCDMA 1900	9262	23.31	23.28	22.35	23.36	GSM 1900	512	29.97
	9400	23.22	23.23	23.12	23.30		661	29.75
	9538	22.69	22.73	22.84	22.80		810	30.11

Figure 9-1
Conducted Power Measurements for A340; LG-A340; LGA340

FCC ID: ZNFA340	 PCTEST ENGINEERING LABORATORY, INC.	HAC (RF EMISSIONS) TEST REPORT	 LG	Reviewed by: Quality Manager
Filename: 0Y1112192181.ZNF	Test Dates: 1/6/2012	EUT Type: Portable Handset		Page 20 of 80

10. OVERALL MEASUREMENT SUMMARY

FCC ID:	ZNFA340
Model:	A340; LG-A340; LGA340
S/N:	HAC RFE #1

I. E-FIELD EMISSIONS:

**Table 10-1
HAC Data Summary for E-field**

Mode	Channel	Backlight	Scan Center	Conducted Power at BS (dBm)	Time Avg. Field (V/m)	Peak Field (V/m)	Peak Field (dBV/m)	FCC Limit (dBV/m)	FCC MARGIN (dB)	RESULT	Excl Blocks per 4.4
E-field Emissions											
GSM850	128	off	Acoustic	32.56	23.10	65.3	36.30	48.50	-12.20	M4	none
GSM850	190	off	Acoustic	32.48	28.50	80.6	38.13	48.50	-10.37	M4	none
GSM850	251	off	Acoustic	32.44	34.83	98.5	39.87	48.50	-8.63	M4	none
GSM1900	512	off	Acoustic	29.97	11.34	31.6	30.00	38.50	-8.50	M4	none
GSM1900	661	off	Acoustic	29.75	16.84	47.0	33.44	38.50	-5.06	M4	none
GSM1900	810	off	Acoustic	30.11	18.10	50.5	34.07	38.50	-4.43	M3	none
GSM1900	810	off	T-coil	30.11	18.10	50.5	34.07	38.50	-4.43	M3	none

Mode	Channel	Backlight	Scan Center	Conducted Power at BS (dBm)	Time Avg. Field (V/m)	Peak Field (V/m)	Peak Field (dBV/m)	FCC Limit (dBV/m)	FCC MARGIN (dB)	RESULT	Excl Blocks per 4.4
E-field Emissions											
WCDMA850	4132	off	Acoustic	23.64	30.24	29.1	29.3	51.0	-21.73	M4	none
WCDMA850	4183	off	Acoustic	23.65	33.93	32.6	30.3	51.0	-20.73	M4	none
WCDMA850	4233	off	Acoustic	23.62	33.22	31.9	30.1	51.0	-20.92	M4	none
WCDMA1900	9262	off	Acoustic	23.31	15.07	14.7	23.3	41.0	-17.68	M4	none
WCDMA1900	9400	off	Acoustic	23.22	14.63	14.2	23.1	41.0	-17.94	M4	none
WCDMA1900	9538	off	Acoustic	22.69	20.53	20.0	26.0	41.0	-14.99	M4	none

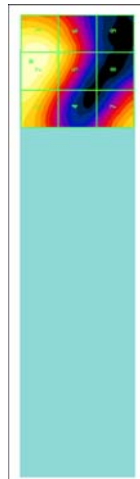



Figure 10-1
Sample E-field Scan Overlay
(See Test Setup Photographs for actual WD overlay)

FCC ID: ZNFA340	 PCTEST <small>ENGINEERING LABORATORY, INC.</small>	HAC (RF EMISSIONS) TEST REPORT	 LG	Reviewed by: Quality Manager
Filename: OY1112192181.ZNF	Test Dates: 1/6/2012	EUT Type: Portable Handset		Page 21 of 80

FCC ID:	ZNFA340
Model:	A340; LG-A340; LGA340
S/N:	HAC RFE #1

II. H-FIELD EMISSIONS:

**Table 10-2
HAC Data Summary for H-field**

Mode	Channel	Backlight	Scan Center	Conducted Power at BS (dBm)	Time Avg. Field (A/m)	Peak Field (V/m)	Peak Field (dBA/m)	FCC Limit (dBA/m)	FCC MARGIN (dB)	RESULT	Excl Blocks per 4.4
H-field Emissions											
GSM850	128	off	Acoustic	32.56	0.0434	0.085	-21.5	-1.9	-19.55	M4	none
GSM850	190	off	Acoustic	32.48	0.0638	0.124	-18.1	-1.9	-16.22	M4	none
GSM850	251	off	Acoustic	32.44	0.0723	0.141	-17.0	-1.9	-15.13	M4	none
GSM1900	512	off	Acoustic	29.97	0.0386	0.089	-21.0	-11.9	-9.06	M4	none
GSM1900	661	off	Acoustic	29.75	0.0577	0.134	-17.5	-11.9	-5.57	M4	none
GSM1900	810	off	Acoustic	30.11	0.0557	0.129	-17.8	-11.9	-5.88	M4	none

Mode	Channel	Backlight	Scan Center	Conducted Power at BS (dBm)	Time Avg. Field (A/m)	Peak Field (V/m)	Peak Field (dBA/m)	FCC Limit (dBA/m)	FCC MARGIN (dB)	RESULT	Excl Blocks per 4.4
H-field Emissions											
WCDMA850	4132	off	Acoustic	23.64	0.0668	0.062	-24.2	0.6	-24.79	M4	none
WCDMA850	4183	off	Acoustic	23.65	0.0766	0.071	-23.0	0.6	-23.60	M4	none
WCDMA850	4233	off	Acoustic	23.62	0.0792	0.073	-22.7	0.6	-23.31	M4	none
WCDMA1900	9262	off	Acoustic	23.31	0.0594	0.056	-25.1	-9.4	-15.66	M4	none
WCDMA1900	9400	off	Acoustic	23.22	0.0720	0.068	-23.4	-9.4	-14.00	M4	none
WCDMA1900	9538	off	Acoustic	22.69	0.0693	0.065	-23.7	-9.4	-14.32	M4	none

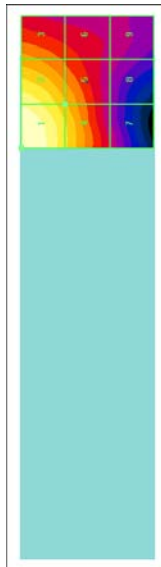



Figure 10-2
Sample H-field Scan Overlay
(See Test Setup Photographs for actual WD overlay)

FCC ID: ZNFA340	 PCTEST ENGINEERING LABORATORY, INC.	HAC (RF EMISSIONS) TEST REPORT	 LG	Reviewed by: Quality Manager
Filename: 0Y1112192181.ZNF	Test Dates: 1/6/2012	EUT Type: Portable Handset	Page 22 of 80	

FCC ID:	ZNFA340
Model:	A340; LG-A340; LGA340
S/N:	HAC RFE #1

III. Worst-case Configuration Evaluation

Table 10-3
Peak Reading 360° Probe Rotation at Azimuth axis

Mode	Channel	Backlight	Scan Center	Time Avg. Field (V/m)	Peak Field (V/m)	Peak Field (dBV/m)	FCC Limit (dBV/m)	FCC MARGIN (dB)	RESULT
Probe Rotation at Worst-Case									
GSM1900	810	off	Acoustic	18.94	52.8	34.46	38.50	-4.04	M3

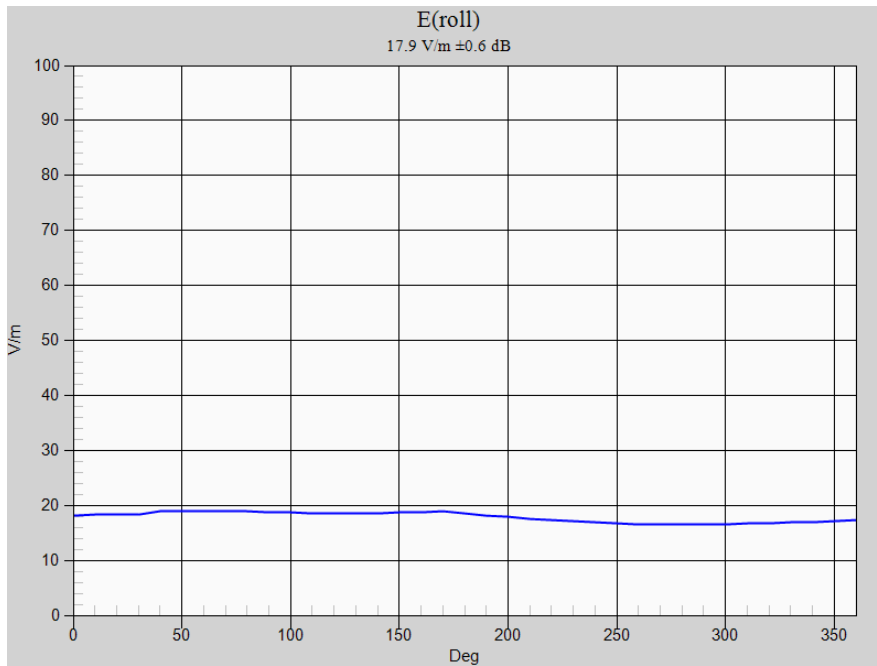

Figure 10-3
Worst-Case Probe Rotation about Azimuth axis

* Note: Location of probe rotation is shown in Figure 10-1 or Figure 10-2



FCC ID: ZNFA340	PCTEST ENGINEERING LABORATORY, INC.	HAC (RF EMISSIONS) TEST REPORT	LG	Reviewed by: Quality Manager
Filename: 0Y1112192181.ZNF	Test Dates: 1/6/2012	EUT Type: Portable Handset	Page 23 of 80	

11. EQUIPMENT LIST

Manufacturer	Model	Description	Cal Date	Cal Interval	Cal Due	Serial Number
Agilent	E5515C	Wireless Communications Test Set	2/8/2011	Annual	2/8/2012	GB45360985
Agilent	E4407B	ESA Spectrum Analyzer	4/5/2011	Annual	4/5/2012	US39210313
Agilent	E5515C	Wireless Communications Tester	4/21/2011	Annual	4/21/2012	US41140256
Agilent	E5515C	Wireless Communications Test Set	7/6/2011	Annual	7/6/2012	GB41450275
Agilent	E5515C	Wireless Communications Test Set	7/6/2011	Annual	7/6/2012	GB43304447
Agilent	E5515C	Wireless Communications Test Set	10/10/2011	Annual	10/10/2012	GB46110872
Anritsu	MA2481A	Power Sensor	2/7/2011	Annual	2/7/2012	3681
Mini-Circuits	NLP-2950+	Low Pass Filter DC to 2700 MHz	N/A		N/A	N/A
Mini-Circuits	NLP-1200+	Low Pass Filter DC to 1000 MHz	N/A		N/A	N/A
Pasternack	PE2208-6	Bidirectional Coupler	N/A		N/A	N/A
Pasternack	PE2209-10	Bidirectional Coupler	N/A		N/A	N/A
Rohde & Schwarz	CMU200	Base Station Simulator	4/19/2011	Annual	4/19/2012	107826
Rohde & Schwarz	CMU200	Base Station Simulator	6/1/2011	Annual	6/1/2012	833855/0010
Rohde & Schwarz	CMW500	LTE Radio Communication Tester	10/7/2011	Annual	10/7/2012	103962
Rohde & Schwarz	NRVD	Dual Channel Power Meter	4/8/2011	Biennial	4/8/2013	101695
SPEAG	ER3DV6	Freespace E-field Probe	2/7/2011	Annual	2/7/2012	2353
SPEAG	H3DV6	Freespace H-field Probe	2/11/2011	Annual	2/11/2012	6207
SPEAG	DAE4	Dasy Data Acquisition Electronics	2/21/2011	Annual	2/21/2012	649
SPEAG	DAE4	Dasy Data Acquisition Electronics	4/20/2011	Annual	4/20/2012	665
SPEAG	DAE4	Dasy Data Acquisition Electronics	5/19/2011	Annual	5/19/2012	859
SPEAG	CD1880V3	Freespace 1880 MHz Dipole	6/16/2010	Biennial	6/16/2012	1064
SPEAG	CD835V3	Freespace 835 MHz Dipole	7/13/2010	Biennial	7/13/2012	1082
SPEAG	CD700V3	Freespace 700MHz Dipole	7/13/2010	Biennial	7/13/2012	1003
SPEAG	ER3DV6	Freespace E-field Probe	8/22/2011	Annual	8/22/2012	2335
SPEAG	H3DV6	Freespace H-field Probe	8/22/2011	Annual	8/22/2012	6170
SPEAG	DAE4	Dasy Data Acquisition Electronics	9/16/2011	Annual	9/16/2012	704
SPEAG	DAE3	Dasy Data Acquisition Electronics	11/9/2011	Annual	11/9/2012	455
SPEAG	CD835V3	Freespace 835 MHz Dipole	2/8/2011	Biennial	2/8/2013	1003
SPEAG	CD1880V3	Freespace 1880 MHz Dipole	2/9/2011	Biennial	2/9/2013	1137
SPEAG	CD2450V3	Freespace 2450 MHz Dipole	11/8/2011	Biennial	11/8/2013	1062

Table 11-1
Equipment List

*Calibration traceable to the National Institute of Standards and Technology (NIST).

FCC ID: ZNFA340	 PCTEST ENGINEERING LABORATORY, INC.	HAC (RF EMISSIONS) TEST REPORT		Reviewed by: Quality Manager
Filename: 0Y1112192181.ZNF	Test Dates: 1/6/2012	EUT Type: Portable Handset	Page 24 of 80	

12. MEASUREMENT UNCERTAINTY



Wireless Communications Device Near-Field Measurement								
Uncertainty Estimation								
Uncertainty Component	Data (dB)	Data Type	Prob. Dist.	Divisor	Ci (E)	Ci (H)	Unc. (dB)	Notes/Comments
Measurement System								
RF System Reflections	0.50	Tolerance	N	1.00	1	1	0.50	Refl. < -20 dB
Field Probe Calibration	0.21	Tolerance	N	1.00	1	1	0.21	
Field Probe Isotropy	0.01	Tolerance	N	1.00	1	1	0.01	
Field Probe Frequency Response	0.135	Tolerance	N	1.00	1	1	0.14	
Field Probe Linearity	0.013	Tolerance	N	1.00	1	1	0.01	
Probe Modulation Factor	0.270	Accuracy	R	1.73	1	1	0.16	
Boundary Effects	0.105	Accuracy	R	1.73	1	1	0.06	*
Probe Positioning Accuracy	0.20	Accuracy	R	1.73	1	0.670	0.12	*
Probe Positioner	0.050	Accuracy	R	1.73	1	0.670	0.03	*
Extrapolation/Interpolation	0.045	Tolerance	R	1.73	1	1	0.03	*
Resolution to 2mm error	0.210	Tolerance	N	1.00	1	1	0.21	
System Detection Limit	0.05	Tolerance	R	1.73	1	1	0.03	*
Readout Electronics	0.015	Tolerance	N	1.00	1	1	0.02	*
Integration Time	0.11	Tolerance	R	1.73	1	1	0.06	*
Response Time	0.033	Tolerance	R	1.73	1	1	0.02	*
Phantom Thickness	0.10	Tolerance	R	1.73	1	1	0.06	*
System Repeatability (Field x 2=power)	0.17	Tolerance	N	1.00	1	1	0.17	
Test Sample Related								
Device Positioning Vertical	0.2	Tolerance	R	1.73	1	1	0.12	*
Device Positioning Lateral	0.045	Tolerance	R	1.73	1	1	0.03	*
Device Holder and Phantom	0.1	Tolerance	R	1.73	1	1	0.06	*
Power Drift	0.21	Tolerance	R	1.73	1	1	0.12	
<i>Combined Standard Uncertainty (k=1)</i>								
							0.66	16.5%
<i>Expanded Uncertainty [95% confidence] (k=2)</i>								
							1.33	32.3%
<i>Expanded Uncertainty [95% confidence] on Field</i>								
							0.66	16.2%

Table 12-1
Uncertainty Estimation Table

Notes:



1. Test equipments are calibrated according to techniques outlined in NIS81, NIS3003 and NIST Tech Note 1297. All equipments have traceability according to NIST. Measurement Uncertainties are defined in further detail in NIS 81 and NIST Tech Note 1297 and UKAS M3003.
2. * Uncertainty specifications from Schmidt & Partner Engineering AG (not site specific)

Measurement uncertainty reflects the quality and accuracy of a measured result as compared to the true value. Such statements are generally required when stating results of measurements so that it is clear to the intended audience that the results may differ when reproduced by different facilities. Measurement results vary due to the measurement uncertainty of the instrumentation, measurement technique, and test engineer. Most uncertainties are calculated using the tolerances of the instrumentation used in the measurement, the measurement setup variability, and the technique used in performing the test. While not generally included, the variability of the equipment under test also figures into the overall measurement uncertainty. Another component of the overall uncertainty is based on the variability of repeated measurements (so-called Type A uncertainty). This may mean that the Hearing Aid immunity tests may have to be repeated by taking down the test setup and resetting it up so that there are a statistically significant number of repeat measurements to identify the measurement uncertainty. By combining the repeat measurement results with that of the instrumentation chain using the technique contained in NIS 81 and NIS 3003, the overall measurement uncertainty was estimated.

FCC ID: ZNFA340	 PCTEST <small>ENGINEERING LABORATORY, INC.</small>	HAC (RF EMISSIONS) TEST REPORT	 LG	Reviewed by: Quality Manager
Filename: OY1112192181.ZNF	Test Dates: 1/6/2012	EUT Type: Portable Handset	Page 25 of 80	

13. TEST DATA

See following Attached Pages for Test Data.

FCC ID: ZNFA340	 PCTEST ENGINEERING LABORATORY, INC.	HAC (RF EMISSIONS) TEST REPORT	 LG	Reviewed by: Quality Manager
Filename: 0Y1112192181.ZNF	Test Dates: 1/6/2012	EUT Type: Portable Handset	Page 26 of 80	



PCTEST Hearing-Aid Compatibility Facility

DUT: CD835V3 - SN1003

Type: CD835V3
Serial: 1003

Communication System: CW; Frequency: 835 MHz;

Measurement Standard: DASYS (IEEE/IEC/ANSI C63.19-2007)

DASY5 Configuration:

- Probe: ER3DV6 - SN2335; Calibrated: 8/22/2011
- Sensor-Surface: 0mm (Fix Surface)
- Electronics: DAE4 Sn704; Calibrated: 9/16/2011
- Phantom: HAC Test Arch with AMCC; Type: SD HAC P01 BA;
- Measurement SW: DASY52, Version 52.6 (2);

835 MHz / 100mW HAC Dipole Validation at 10mm/Hearing Aid Compatibility Test (41x361x1):

Measurement grid: dx=5mm, dy=5mm
 Probe Modulation Factor = 1.000
 Device Reference Point: 0, 0, -6.3 mm
 Reference Value = 119.6 V/m; Power Drift = -0.05 dB
 Average value of Total (interpolated) = 157.8 V/m

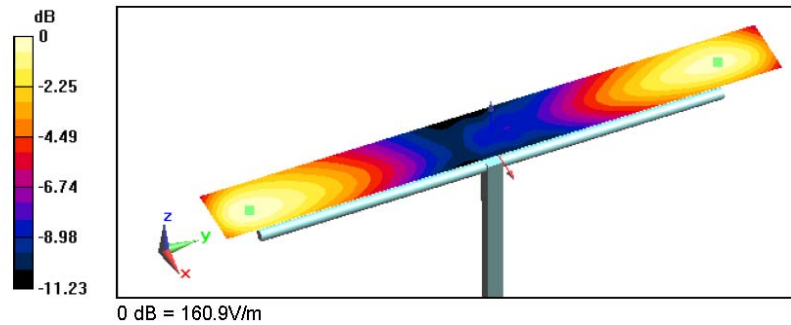

2011 PCTEST

FCC ID: ZNFA340		HAC (RF EMISSIONS) TEST REPORT		Reviewed by: Quality Manager
Filename: 0Y1112192181.ZNF	Test Dates: 1/6/2012	EUT Type: Portable Handset	Page 27 of 80	



PCTEST Hearing-Aid Compatibility Facility

DUT: CD835V3 - SN1003

Type: CD835V3
Serial: 1003

Communication System: CW; Frequency: 835 MHz;

Measurement Standard: DASy5 (IEEE/IEC/ANSI C63.19-2007)

DASy5 Configuration:

- Probe: H3DV6 - SN6170; Calibrated: 8/22/2011
- Sensor-Surface: 0mm (Fix Surface)
- Electronics: DAE4 Sn704; Calibrated: 9/16/2011
- Phantom: HAC Test Arch with AMCC; Type: SD HAC P01 BA;
- Measurement SW: DASy52, Version 52.6 (2);

835 MHz / 100 mW HAC Validation at 10 mm/Hearing Aid Compatibility Test (41x361x1):

Measurement grid: dx=5mm, dy=5mm
 Probe Modulation Factor = 1.000
 Device Reference Point: 0, 0, -6.3 mm
 Reference Value = 0.455 A/m; Power Drift = 0.0076 dB
 Maximum value of Total (interpolated) = 0.435 A/m

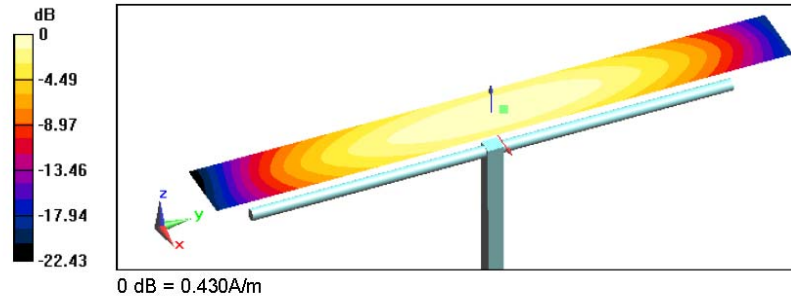

2011 PCTEST

FCC ID: ZNFA340	PCTEST ENGINEERING LABORATORY, INC.	HAC (RF EMISSIONS) TEST REPORT	LG	Reviewed by: Quality Manager
Filename: 0Y1112192181.ZNF	Test Dates: 1/6/2012	EUT Type: Portable Handset	Page 28 of 80	



PCTEST Hearing-Aid Compatibility Facility

DUT: CD1880V3 - SN1137

Type: CD1880V3
Serial: 1137

Communication System: CW; Frequency: 1880 MHz;

Measurement Standard: DASYS (IEEE/IEC/ANSI C63.19-2007)

DASY5 Configuration:

- Probe: ER3DV6 - SN2335; Calibrated: 8/22/2011
- Sensor-Surface: 0mm (Fix Surface)
- Electronics: DAE4 Sn704; Calibrated: 9/16/2011
- Phantom: HAC Test Arch with AMCC; Type: SD HAC P01 BA;
- Measurement SW: DASY52, Version 52.6 (2);

1880 MHz / 100mW HAC Dipole Validation at 10mm/Hearing Aid Compatibility Test (41x181x1):

Measurement grid: dx=5mm, dy=5mm
 Probe Modulation Factor = 1.000
 Device Reference Point: 0, 0, -6.3 mm
 Reference Value = 151.4 V/m; Power Drift = -0.07 dB
 Average value of Total (interpolated) = 145.6 V/m

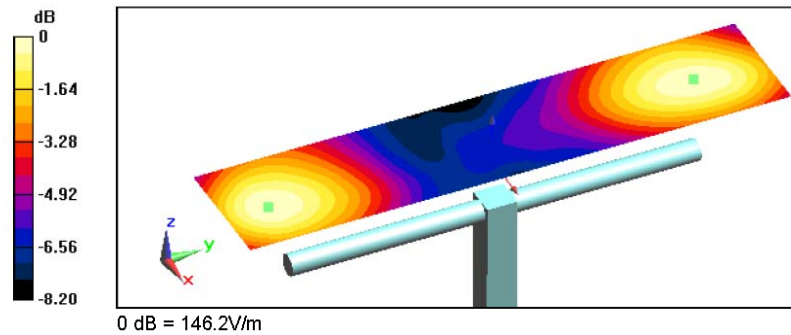

2011 PCTEST

FCC ID: ZNFA340		HAC (RF EMISSIONS) TEST REPORT		Reviewed by: Quality Manager
Filename: 0Y1112192181.ZNF	Test Dates: 1/6/2012	EUT Type: Portable Handset	Page 29 of 80	



PCTEST Hearing-Aid Compatibility Facility

DUT: CD1880V3 - SN1137

Type: CD1880V3
Serial: 1137

Communication System: CW; Frequency: 1880 MHz;

Measurement Standard: DASYS (IEEE/IEC/ANSI C63.19-2007)

DASY5 Configuration:

- Probe: H3DV6 - SN6170; Calibrated: 8/22/2011
- Sensor-Surface: 0mm (Fix Surface)
- Electronics: DAE4 Sn704; Calibrated: 9/16/2011
- Phantom: HAC Test Arch with AMCC; Type: SD HAC P01 BA;
- Measurement SW: DASY52, Version 52.6 (2);

1880 MHz / 100 mW HAC Validation at 10 mm/Hearing Aid Compatibility Test (41x181x1):

Measurement grid: dx=5mm, dy=5mm
 Probe Modulation Factor = 1.000
 Device Reference Point: 0, 0, -6.3 mm
 Reference Value = 0.485 A/m; Power Drift = 0.05 dB
 Maximum value of Total (interpolated) = 0.460 A/m

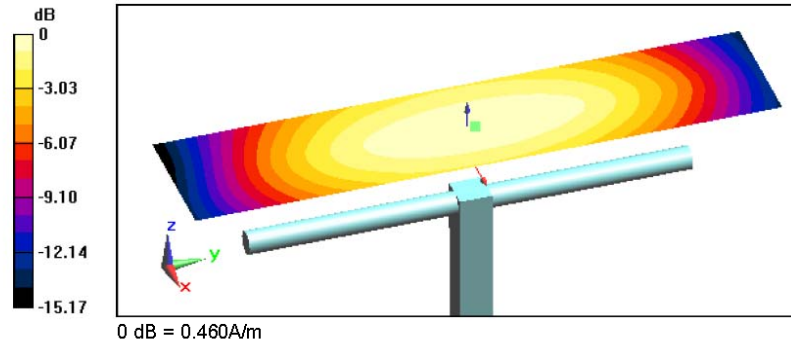

2011 PCTEST

FCC ID: ZNFA340	PCTEST ENGINEERING LABORATORY, INC.	HAC (RF EMISSIONS) TEST REPORT	LG	Reviewed by: Quality Manager
Filename: 0Y1112192181.ZNF	Test Dates: 1/6/2012	EUT Type: Portable Handset	Page 30 of 80	



DUT: ZNFA340

Type: Portable Handset
 Serial: HAC RFE #1
 Backlight off
 Duty Cycle: 1:8.3

Communication System: GSM850; Frequency: 848.8 MHz;

Measurement Standard: DASYS (IEEE/EC/ANSI C63.19-2007)

DASY5 Configuration:

- Probe: ER3DV6 - SN2335; Calibrated: 8/22/2011
- Sensor-Surface: (Fix Surface)
- Electronics: DAE4 Sn704; Calibrated: 9/16/2011
- Phantom: HAC Test Arch with AMCC; Type: SD HAC P01 BA;
- Measurement SW: DASY52, Version 52.6 (2);

GSM850 High Channel/Hearing Aid Compatibility Test (101x101x1):

Measurement grid: dx=5mm, dy=5mm
 Maximum value of peak Total field = 98.546 V/m
 Probe Modulation Factor = 2.829
 Device Reference Point: 0, 0, -6.3 mm
 Reference Value = 42.425 V/m; Power Drift = -0.12 dB
Hearing Aid Near-Field Category: M4 (AWF -5 dB)

Peak E-field in V/m

Grid 1	Grid 2	Grid 3
94.564 M4	98.546 M4	96.573 M4
Grid 4	Grid 5	Grid 6
89.688 M4	97.040 M4	96.290 M4
Grid 7	Grid 8	Grid 9
76.459 M4	83.508 M4	82.376 M4



2011 PCTEST

FCC ID: ZNFA340	PCTEST ENGINEERING LABORATORY, INC.	HAC (RF EMISSIONS) TEST REPORT	LG	Reviewed by: Quality Manager
Filename: 0Y1112192181.ZNF	Test Dates: 1/6/2012	EUT Type: Portable Handset	Page 31 of 80	

PCTEST Hearing-Aid Compatibility Facility

DUT: ZNFA340

Type: Portable Handset
 Serial: HAC RFE #1
 Backlight off
 Duty Cycle: 1:8.3

Communication System: GSM850; Frequency: 848.8 MHz;

Measurement Standard: DASYS (IEEE/EC/ANSI C63.19-2007)

DASY5 Configuration:

- Probe: H3DV6 - SN6170; Calibrated: 8/22/2011
- Sensor-Surface: (Fix Surface)
- Electronics: DAE4 Sn704; Calibrated: 9/16/2011
- Phantom: HAC Test Arch with AMCC; Type: SD HAC P01 BA;
- Measurement SW: DASY52, Version 52.6 (2);

GSM850 High Channel/Hearing Aid Compatibility Test (101x101x1):



Measurement grid: dx=5mm, dy=5mm
 Maximum value of peak Total field = 0.141 A/m
 Probe Modulation Factor = 1.948
 Device Reference Point: 0, 0, -6.3 mm
 Reference Value = 0.049 A/m; Power Drift = -0.15 dB
Hearing Aid Near-Field Category: M4 (AWF -5 dB)

Peak H-field in A/m

Grid 1	Grid 2	Grid 3
0.141 M4	0.110 M4	0.074 M4
Grid 4	Grid 5	Grid 6
0.134 M4	0.108 M4	0.072 M4
Grid 7	Grid 8	Grid 9
0.134 M4	0.105 M4	0.072 M4



2011 PCTEST

FCC ID: ZNFA340	 <small>ENGINEERING LABORATORY, INC.</small>	HAC (RF EMISSIONS) TEST REPORT		Reviewed by: Quality Manager
Filename: 0Y1112192181.ZNF	Test Dates: 1/6/2012	EUT Type: Portable Handset	Page 32 of 80	



DUT: ZNFA340

Type: Portable Handset
 Serial: HAC RFE #1
 Backlight off
 Duty Cycle: 1:8.3

Communication System: GSM1900; Frequency: 1909.8 MHz;

Measurement Standard: DASYS5 (IEEE/EC/ANSI C63.19-2007)

DASY5 Configuration:

- Probe: ER3DV6 - SN2335; Calibrated: 8/22/2011
- Sensor-Surface: (Fix Surface)
- Electronics: DAE4 Sn704; Calibrated: 9/16/2011
- Phantom: HAC Test Arch with AMCC; Type: SD HAC P01 BA;
- Measurement SW: DASY52, Version 52.6 (2);

GSM1900 High Channel/Hearing Aid Compatibility Test (101x101x1):

Measurement grid: dx=5mm, dy=5mm
 Maximum value of peak Total field = 50.503 V/m
 Probe Modulation Factor = 2.790
 Device Reference Point: 0, 0, -6.3 mm
 Reference Value = 11.771 V/m; Power Drift = 0.10 dB
Hearing Aid Near-Field Category: M3 (AWF -5 dB)

Peak E-field in V/m

Grid 1	Grid 2	Grid 3
46.670 M4	50.503 M3	50.213 M3
Grid 4	Grid 5	Grid 6
32.256 M4	43.294 M4	43.294 M4
Grid 7	Grid 8	Grid 9
41.453 M4	29.615 M4	22.484 M4



2011 PCTEST

FCC ID: ZNFA340	PCTEST ENGINEERING LABORATORY, INC.	HAC (RF EMISSIONS) TEST REPORT	LG	Reviewed by: Quality Manager
Filename: 0Y1112192181.ZNF	Test Dates: 1/6/2012	EUT Type: Portable Handset	Page 33 of 80	

PCTEST Hearing-Aid Compatibility Facility

DUT: ZNFA340

Type: Portable Handset
 Serial: HAC RFE #1
 Backlight off
 Duty Cycle: 1:8.3

Communication System: GSM1900; Frequency: 1880 MHz;

Measurement Standard: DASYS (IEEE/EC/ANSI C63.19-2007)

DASY5 Configuration:

- Probe: H3DV6 - SN6170; Calibrated: 8/22/2011
- Sensor-Surface: (Fix Surface)
- Electronics: DAE4 Sn704; Calibrated: 9/16/2011
- Phantom: HAC Test Arch with AMCC; Type: SD HAC P01 BA;
- Measurement SW: DASY52, Version 52.6 (2);

GSM1900 Mid Channel/Hearing Aid Compatibility Test (101x101x1):



Measurement grid: dx=5mm, dy=5mm
 Maximum value of peak Total field = 0.134 A/m
 Probe Modulation Factor = 2.319
 Device Reference Point: 0, 0, -6.3 mm
 Reference Value = 0.036 A/m; Power Drift = -0.13 dB
Hearing Aid Near-Field Category: M4 (AWF -5 dB)

Peak H-field in A/m

Grid 1	Grid 2	Grid 3
0.134 M4	0.119 M4	0.090 M4
Grid 4	Grid 5	Grid 6
0.104 M4	0.096 M4	0.079 M4
Grid 7	Grid 8	Grid 9
0.068 M4	0.066 M4	0.067 M4



2011 PCTEST

FCC ID: ZNFA340	 <small>ENGINEERING LABORATORY, INC.</small>	HAC (RF EMISSIONS) TEST REPORT		Reviewed by: Quality Manager
Filename: 0Y1112192181.ZNF	Test Dates: 1/6/2012	EUT Type: Portable Handset	Page 34 of 80	



DUT: ZNFA340

Type: Portable Handset
 Serial: HAC RFE #1
 Backlight off
 Duty Cycle: 1:1

Communication System: WCDMA850; Frequency: 836.6 MHz;

Measurement Standard: DASYS5 (IEEE/EC/ANSI C63.19-2007)

DASY5 Configuration:

- Probe: ER3DV6 - SN2335; Calibrated: 8/22/2011
- Sensor-Surface: (Fix Surface)
- Electronics: DAE4 Sn704; Calibrated: 9/16/2011
- Phantom: HAC Test Arch with AMCC; Type: SD HAC P01 BA;
- Measurement SW: DASY52, Version 52.6 (2);

WCDMA850 Mid Channel/Hearing Aid Compatibility Test (101x101x1):

Measurement grid: dx=5mm, dy=5mm
 Maximum value of peak Total field = 32.604 V/m
 Probe Modulation Factor = 0.961
 Device Reference Point: 0, 0, -6.3 mm
 Reference Value = 40.646 V/m; Power Drift = -0.08 dB
Hearing Aid Near-Field Category: M4 (AWF 0 dB)

Peak E-field in V/m

Grid 1	Grid 2	Grid 3
30.391 M4	32.604 M4	32.233 M4
Grid 4	Grid 5	Grid 6
28.349 M4	32.582 M4	32.233 M4
Grid 7	Grid 8	Grid 9
25.620 M4	29.421 M4	29.301 M4



2011 PCTEST

FCC ID: ZNFA340	PCTEST ENGINEERING LABORATORY, INC.	HAC (RF EMISSIONS) TEST REPORT	LG	Reviewed by: Quality Manager
Filename: 0Y1112192181.ZNF	Test Dates: 1/6/2012	EUT Type: Portable Handset	Page 35 of 80	



DUT: ZNFA340

Type: Portable Handset
 Serial: HAC RFE #1
 Backlight off
 Duty Cycle: 1:1

Communication System: WCDMA850; Frequency: 846.6 MHz;

Measurement Standard: DASYS5 (IEEE/EC/ANSI C63.19-2007)

DASY5 Configuration:

- Probe: H3DV6 - SN6170; Calibrated: 8/22/2011
- Sensor-Surface: (Fix Surface)
- Electronics: DAE4 Sn704; Calibrated: 9/16/2011
- Phantom: HAC Test Arch with AMCC; Type: SD HAC P01 BA;
- Measurement SW: DASYS2, Version 52.6 (2);

WCDMA850 High Channel/Hearing Aid Compatibility Test (101x101x1):

Measurement grid: dx=5mm, dy=5mm
 Maximum value of peak Total field = 0.073 A/m
 Probe Modulation Factor = 0.924
 Device Reference Point: 0, 0, -6.3 mm
 Reference Value = 0.054 A/m; Power Drift = 0.12 dB
Hearing Aid Near-Field Category: M4 (AWF 0 dB)

Peak H-field in A/m

Grid 1	Grid 2	Grid 3
0.073 M4	0.058 M4	0.041 M4
Grid 4	Grid 5	Grid 6
0.072 M4	0.057 M4	0.040 M4
Grid 7	Grid 8	Grid 9
0.070 M4	0.055 M4	0.038 M4



2011 PCTEST

FCC ID: ZNFA340	PCTEST ENGINEERING LABORATORY, INC.	HAC (RF EMISSIONS) TEST REPORT	LG	Reviewed by: Quality Manager
Filename: 0Y1112192181.ZNF	Test Dates: 1/6/2012	EUT Type: Portable Handset	Page 36 of 80	



DUT: ZNFA340

Type: Portable Handset
 Serial: HAC RFE #1
 Backlight off
 Duty Cycle: 1:1

Communication System: WCDMA1900; Frequency: 1907.6 MHz;

Measurement Standard: DASYS (IEEE/EC/ANSI C63.19-2007)

DASY5 Configuration:

- Probe: ER3DV6 - SN2335; Calibrated: 8/22/2011
- Sensor-Surface: (Fix Surface)
- Electronics: DAE4 Sn704; Calibrated: 9/16/2011
- Phantom: HAC Test Arch with AMCC; Type: SD HAC P01 BA;
- Measurement SW: DASY52, Version 52.6 (2);

WCDMA1900 High Channel/Hearing Aid Compatibility Test (101x101x1):

Measurement grid: dx=5mm, dy=5mm
 Maximum value of peak Total field = 19.954 V/m
 Probe Modulation Factor = 0.972
 Device Reference Point: 0, 0, -6.3 mm
 Reference Value = 12.354 V/m; Power Drift = -0.08 dB
Hearing Aid Near-Field Category: M4 (AWF 0 dB)

Peak E-field in V/m

Grid 1	Grid 2	Grid 3
19.954 M4	19.395 M4	16.972 M4
Grid 4	Grid 5	Grid 6
13.345 M4	13.715 M4	13.366 M4
Grid 7	Grid 8	Grid 9
17.578 M4	15.139 M4	11.032 M4



2011 PCTEST

FCC ID: ZNFA340	PCTEST ENGINEERING LABORATORY, INC.	HAC (RF EMISSIONS) TEST REPORT	LG	Reviewed by: Quality Manager
Filename: 0Y1112192181.ZNF	Test Dates: 1/6/2012	EUT Type: Portable Handset	Page 37 of 80	

PCTEST Hearing-Aid Compatibility Facility

DUT: ZNFA340

Type: Portable Handset
 Serial: HAC RFE #1
 Backlight off
 Duty Cycle: 1:1

Communication System: WCDMA1900; Frequency: 1880 MHz;

Measurement Standard: DASYS5 (IEEE/EC/ANSI C63.19-2007)

DASY5 Configuration:

- Probe: H3DV6 - SN6170; Calibrated: 8/22/2011
- Sensor-Surface: (Fix Surface)
- Electronics: DAE4 Sn704; Calibrated: 9/16/2011
- Phantom: HAC Test Arch with AMCC; Type: SD HAC P01 BA;
- Measurement SW: DASY52, Version 52.6 (2);

WCDMA1900 Mid Channel/Hearing Aid Compatibility Test (101x101x1):



Measurement grid: dx=5mm, dy=5mm
 Maximum value of peak Total field = 0.068 A/m
 Probe Modulation Factor = 0.940
 Device Reference Point: 0, 0, -6.3 mm
 Reference Value = 0.047 A/m; Power Drift = 0.0032 dB
Hearing Aid Near-Field Category: M4 (AWF 0 dB)

Peak H-field in A/m

Grid 1	Grid 2	Grid 3
0.068 M4	0.061 M4	0.043 M4
Grid 4	Grid 5	Grid 6
0.058 M4	0.056 M4	0.039 M4
Grid 7	Grid 8	Grid 9
0.047 M4	0.045 M4	0.036 M4





2011 PCTEST

FCC ID: ZNFA340		HAC (RF EMISSIONS) TEST REPORT		Reviewed by: Quality Manager
Filename: 0Y1112192181.ZNF	Test Dates: 1/6/2012	EUT Type: Portable Handset	Page 38 of 80	

14. CALIBRATION CERTIFICATES

The following pages include the probe calibration used to evaluate HAC for the DUT.

FCC ID: ZNFA340	 PCTEST ENGINEERING LABORATORY, INC.	HAC (RF EMISSIONS) TEST REPORT	 LG	Reviewed by: Quality Manager
Filename: 0Y1112192181.ZNF	Test Dates: 1/6/2012	EUT Type: Portable Handset	Page 39 of 80	

**Calibration Laboratory of
Schmid & Partner
Engineering AG**
Zeughausstrasse 43, 8004 Zurich, Switzerland



S Schweizerischer Kalibrierdienst
C Service suisse d'étalonnage
S Servizio svizzero di taratura
S Swiss Calibration Service

Accredited by the Swiss Accreditation Service (SAS)
The Swiss Accreditation Service is one of the signatories to the EA
Multilateral Agreement for the recognition of calibration certificates

Accreditation No.: **SCS 108**

Client **PC Test**

Certificate No: **ER3-2353 Feb11**

CALIBRATION CERTIFICATE

Object: **ER3DV6 - SN:2353**

Calibration procedure(s): **QA CAL-02.v6, QA CAL-25.v3
Calibration procedure for E-field probes optimized for close near field
evaluations in air**

Calibration date: **February 7, 2011**

This calibration certificate documents the traceability to national standards, which realize the physical units of measurements (SI).
The measurements and the uncertainties with confidence probability are given on the following pages and are part of the certificate.

All calibrations have been conducted in the closed laboratory facility: environment temperature (22 ± 3)°C and humidity < 70%.

Calibration Equipment used (M&TE critical for calibration)

✓
KOK
2/22/11

Primary Standards	ID	Cal Date (Certificate No.)	Scheduled Calibration
Power meter E4419B	GB41293874	01-Apr-10 (No. 217-01136)	Apr-11
Power sensor E4412A	MY41495277	01-Apr-10 (No. 217-01136)	Apr-11
Power sensor E4412A	MY41498087	01-Apr-10 (No. 217-01136)	Apr-11
Reference 3 dB Attenuator	SN: S5054 (3c)	30-Mar-10 (No. 217-01159)	Mar-11
Reference 20 dB Attenuator	SN: S5086 (20b)	30-Mar-10 (No. 217-01161)	Mar-11
Reference 30 dB Attenuator	SN: S5129 (30b)	30-Mar-10 (No. 217-01160)	Mar-11
Reference Probe ER3DV6	SN: 2328	4-Oct-10 (No. ER3-2328_Oct10)	Oct-11
DAE4	SN: 789	31-Aug-10 (No. DAE4-789_Aug10)	Aug-11
Secondary Standards	ID	Check Date (in house)	Scheduled Check
RF generator HP 8648C	US3642U01700	4-Aug-99 (in house check Oct-09)	In house check: Oct-11
Network Analyzer HP 8753E	US37390585	18-Oct-01 (in house check Oct-10)	In house check: Oct-11

Calibrated by: **Jeton Kastrali** (Name), **Laboratory Technician** (Function), [Signature]

Approved by: **Katja Pokovic** (Name), **Technical Manager** (Function), [Signature]

Issued: February 9, 2011

This calibration certificate shall not be reproduced except in full without written approval of the laboratory.

FCC ID: ZNFA340	PCTEST ENGINEERING LABORATORY, INC.	HAC (RF EMISSIONS) TEST REPORT		Reviewed by: Quality Manager
Filename: OY1112192181.ZNF	Test Dates: 1/6/2012	EUT Type: Portable Handset		Page 40 of 80

Calibration Laboratory of
Schmid & Partner
Engineering AG
Zeughausstrasse 43, 8004 Zurich, Switzerland



S Schweizerischer Kalibrierdienst
C Service suisse d'étalonnage
S Servizio svizzero di taratura
S Swiss Calibration Service

Accredited by the Swiss Accreditation Service (SAS)
The Swiss Accreditation Service is one of the signatories to the EA
Multilateral Agreement for the recognition of calibration certificates

Accreditation No.: **SCS 108**

Glossary:

NORM_{x,y,z} sensitivity in free space
DCP diode compression point
CF crest factor (1/duty_cycle) of the RF signal
A, B, C modulation dependent linearization parameters
Polarization α α rotation around probe axis
Polarization ϑ ϑ rotation around an axis that is in the plane normal to probe axis (at measurement center),
i.e., $\vartheta = 0$ is normal to probe axis
Connector Angle information used in DASY system to align probe sensor X to the robot coordinate system

Calibration is Performed According to the Following Standards:

- a) IEEE Std 1309-2005, "IEEE Standard for calibration of electromagnetic field sensors and probes, excluding antennas, from 9 kHz to 40 GHz", December 2005.

Methods Applied and Interpretation of Parameters:

- NORM_{x,y,z}: Assessed for E-field polarization $\vartheta = 0$ for XY sensors and $\vartheta = 90$ for Z sensor ($f \leq 900$ MHz in TEM-cell; $f > 1800$ MHz: R22 waveguide).
- NORM(f)_{x,y,z} = NORM_{x,y,z} * frequency_response (see Frequency Response Chart).
- DCP_{x,y,z}: DCP are numerical linearization parameters assessed based on the data of power sweep with CW signal (no uncertainty required). DCP does not depend on frequency nor media.
- Ax,y,z; Bx,y,z; Cx,y,z, VRx,y,z: A, B, C are numerical linearization parameters assessed based on the data of power sweep for specific modulation signal. The parameters do not depend on frequency nor media. VR is the maximum calibration range expressed in RMS voltage across the diode.
- Spherical Isotropy (3D deviation from isotropy): in a locally homogeneous field realized using an open waveguide setup.
- Sensor Offset: The sensor offset corresponds to the offset of virtual measurement center from the probe tip (on probe axis). No tolerance required.
- Connector Angle: The angle is assessed using the information gained by determining the NORM_x (no uncertainty required).



FCC ID: ZNFA340	PCTEST INDUSTRIAL LABORATORY, INC.	HAC (RF EMISSIONS) TEST REPORT	LG	Reviewed by: Quality Manager
Filename: 0Y1112192181.ZNF	Test Dates: 1/6/2012	EUT Type: Portable Handset	Page 41 of 80	

Probe ER3DV6

SN:2353

Manufactured: March 8, 2005
 Calibrated: February 7, 2011

Calibrated for DASY/EASY Systems
 (Note: non-compatible with DASY2 system!)

FCC ID: ZNFA340		HAC (RF EMISSIONS) TEST REPORT		Reviewed by: Quality Manager
Filename: 0Y1112192181.ZNF	Test Dates: 1/6/2012	EUT Type: Portable Handset	Page 42 of 80	

DASY/EASY - Parameters of Probe: ER3DV6 - SN:2353**Basic Calibration Parameters**

	Sensor X	Sensor Y	Sensor Z	Unc (k=2)
Norm ($\mu\text{V}/(\text{V}/\text{m})^2$)	1.55	1.76	1.85	$\pm 10.1\%$
DCP (mV) ^B	98.7	97.2	99.8	



Modulation Calibration Parameters

UID	Communication System Name	PAR		A dB	B dB	C dB	VR mV	Unc ^E (k=2)
10000	CW	0.00	X	0.00	0.00	1.00	157.2	$\pm 2.7\%$
			Y	0.00	0.00	1.00	157.4	
			Z	0.00	0.00	1.00	153.6	

The reported uncertainty of measurement is stated as the standard uncertainty of measurement multiplied by the coverage factor $k=2$, which for a normal distribution corresponds to a coverage probability of approximately 95%.

^B Numerical linearization parameter: uncertainty not required.

^E Uncertainty is determined using the max. deviation from linear response applying rectangular distribution and is expressed for the square of the field value.

FCC ID: ZNFA340	 PCTEST ENGINEERING LABORATORY, INC.	HAC (RF EMISSIONS) TEST REPORT		Reviewed by: Quality Manager
Filename: 0Y1112192181.ZNF	Test Dates: 1/6/2012	EUT Type: Portable Handset		Page 43 of 80

Frequency Response of E-Field (TEM-Cell:ifi110 EXX, Waveguide: R22)

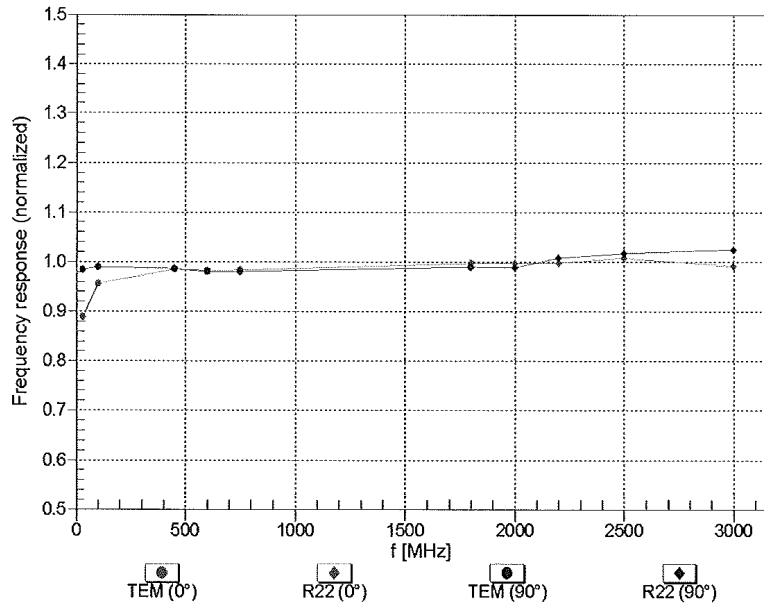

Uncertainty of Frequency Response of E-field: ± 6.3% (k=2)

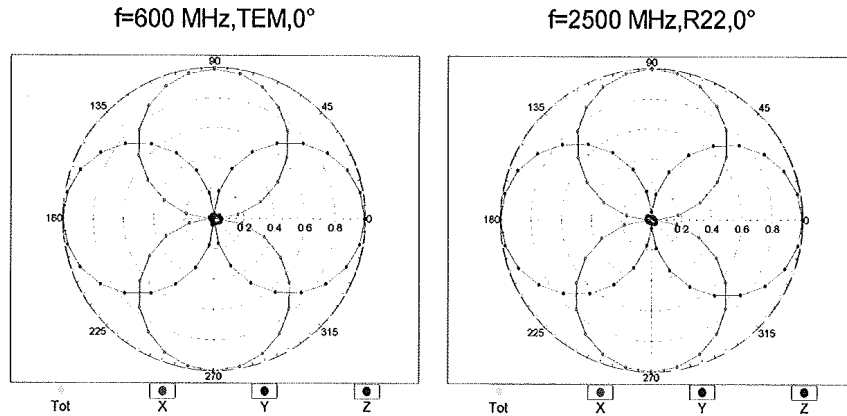

FCC ID: ZNFA340	PCTEST ENGINEERING LABORATORY, INC.	HAC (RF EMISSIONS) TEST REPORT	LG	Reviewed by: Quality Manager
Filename: 0Y1112192181.ZNF	Test Dates: 1/6/2012	EUT Type: Portable Handset	Page 44 of 80	

Receiving Pattern (ϕ), $\vartheta = 0^\circ$

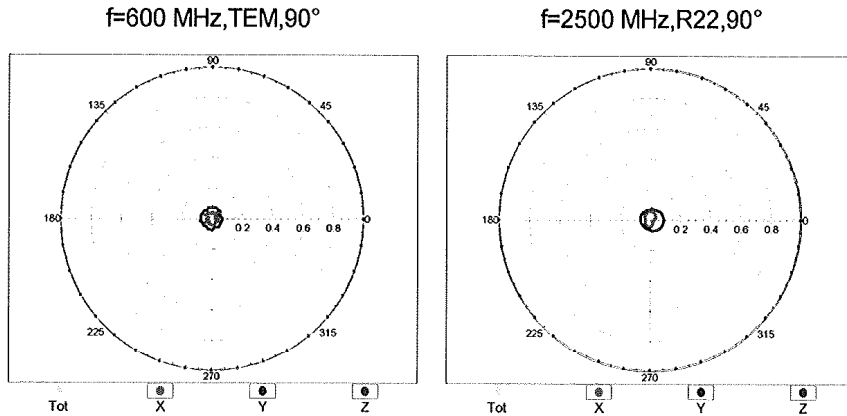

Receiving Pattern (ϕ), $\vartheta = 90^\circ$



FCC ID: ZNFA340	 PCTEST ENGINEERING LABORATORY, INC.	HAC (RF EMISSIONS) TEST REPORT	 LG	Reviewed by: Quality Manager
Filename: 0Y1112192181.ZNF	Test Dates: 1/6/2012	EUT Type: Portable Handset		Page 45 of 80

Receiving Pattern (ϕ), $\theta = 0^\circ$

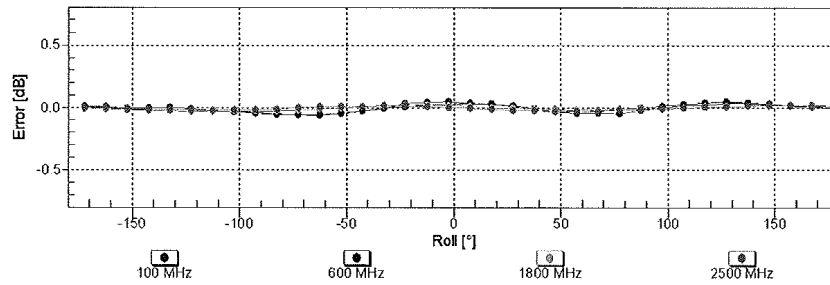

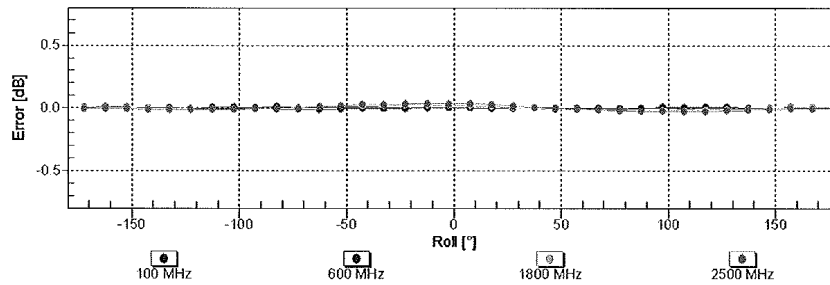

Uncertainty of Axial Isotropy Assessment: $\pm 0.5\%$ (k=2)

Receiving Pattern (ϕ), $\theta = 90^\circ$



Uncertainty of Axial Isotropy Assessment: $\pm 0.5\%$ (k=2)

<p>FCC ID: ZNFA340</p>		<p>HAC (RF EMISSIONS) TEST REPORT</p>	 <p>Reviewed by: Quality Manager</p>
<p>Filename: 0Y1112192181.ZNF</p>	<p>Test Dates: 1/6/2012</p>	<p>EUT Type: Portable Handset</p>	<p>Page 46 of 80</p>

Dynamic Range f(E-field) (TEM cell , f = 900 MHz)

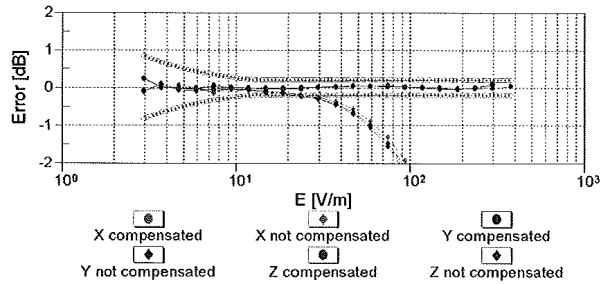
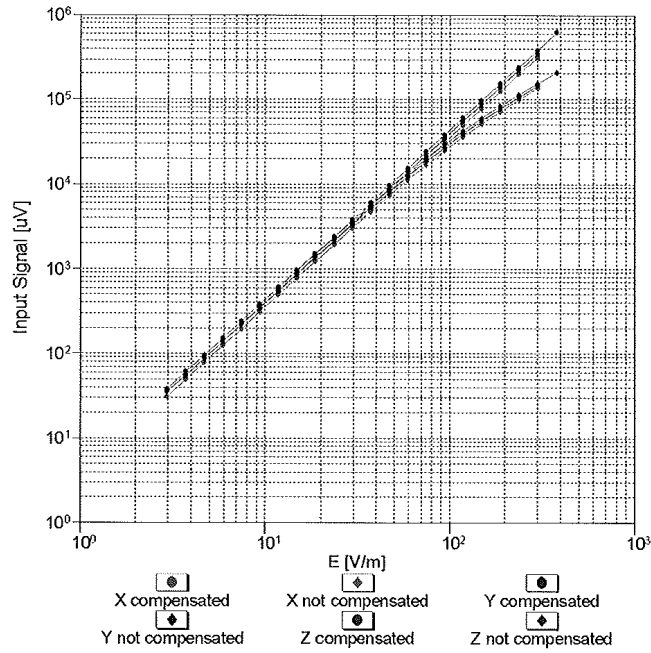



Uncertainty of Linearity Assessment: ± 0.6% (k=2)

FCC ID: ZNFA340	PCTEST ENGINEERING LABORATORY, INC.	HAC (RF EMISSIONS) TEST REPORT	LG	Reviewed by: Quality Manager
Filename: 0Y1112192181.ZNF	Test Dates: 1/6/2012	EUT Type: Portable Handset		Page 47 of 80

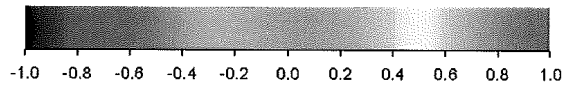
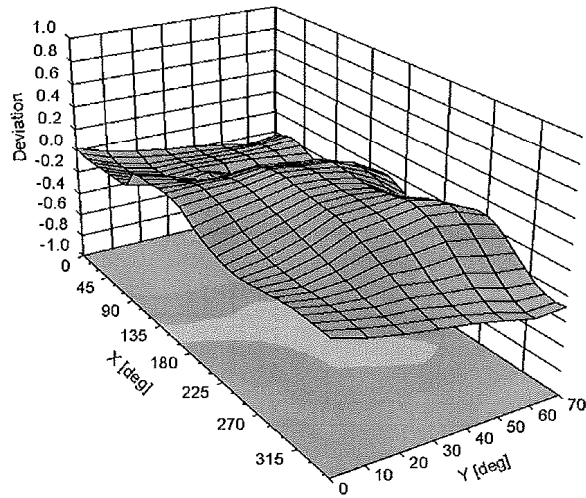
Deviation from Isotropy in Air Error (ϕ , θ), $f = 900$ MHz





Uncertainty of Spherical Isotropy Assessment: $\pm 2.6\%$ ($k=2$)

FCC ID: ZNFA340	 PCTEST <small>ENGINEERING LABORATORY, INC.</small>	HAC (RF EMISSIONS) TEST REPORT	 Reviewed by: Quality Manager
Filename: OY1112192181.ZNF	Test Dates: 1/6/2012	EUT Type: Portable Handset	Page 48 of 80

DASY/EASY - Parameters of Probe: ER3DV6 - SN:2353**Other Probe Parameters**

Sensor Arrangement	Rectangular
Connector Angle (°)	-152.4
Mechanical Surface Detection Mode	enabled
Optical Surface Detection Mode	disabled
Probe Overall Length	337 mm
Probe Body Diameter	10 mm
Tip Length	10 mm
Tip Diameter	8 mm
Probe Tip to Sensor X Calibration Point	2.5 mm
Probe Tip to Sensor Y Calibration Point	2.5 mm
Probe Tip to Sensor Z Calibration Point	2.5 mm

FCC ID: ZNFA340	 PCTEST ENGINEERING LABORATORY, INC.	HAC (RF EMISSIONS) TEST REPORT	 LG	Reviewed by: Quality Manager
Filename: 0Y1112192181.ZNF	Test Dates: 1/6/2012	EUT Type: Portable Handset	Page 49 of 80	

**Calibration Laboratory of
Schmid & Partner
Engineering AG**
Zeughausstrasse 43, 8004 Zurich, Switzerland



S Schweizerischer Kalibrierdienst
S Service suisse d'étalonnage
S Servizio svizzero di taratura
S Swiss Calibration Service

Accredited by the Swiss Accreditation Service (SAS)
The Swiss Accreditation Service is one of the signatories to the EA
Multilateral Agreement for the recognition of calibration certificates

Accreditation No.: **SCS 108**

Client **PC Test**

Certificate No: **H3-6207_Feb11**

CALIBRATION CERTIFICATE

Object: **H3DV6 - SN:6207**

Calibration procedure(s): **QA CAL-03.v6, QA CAL-25.v3
Calibration procedure for H-field probes optimized for close near field
evaluations in air**

Calibration date: **February 11, 2011**

This calibration certificate documents the traceability to national standards, which realize the physical units of measurements (SI).
The measurements and the uncertainties with confidence probability are given on the following pages and are part of the certificate.

All calibrations have been conducted in the closed laboratory facility: environment temperature (22 ± 3)°C and humidity < 70%.

Calibration Equipment used (M&TE critical for calibration)

✓
KOK
2/22/11

Primary Standards	ID	Cal Date (Certificate No.)	Scheduled Calibration
Power meter E4419B	GB41293874	01-Apr-10 (No. 217-01136)	Apr-11
Power sensor E4412A	MY41495277	01-Apr-10 (No. 217-01136)	Apr-11
Power sensor E4412A	MY41498087	01-Apr-10 (No. 217-01136)	Apr-11
Reference 3 dB Attenuator	SN: S5054 (3c)	30-Mar-10 (No. 217-01159)	Mar-11
Reference 20 dB Attenuator	SN: S5086 (20b)	30-Mar-10 (No. 217-01161)	Mar-11
Reference 30 dB Attenuator	SN: S5129 (30b)	30-Mar-10 (No. 217-01160)	Mar-11
Reference Probe H3DV6	SN: 6182	4-Oct-10 (No. H3-6182_Oct10)	Oct-11
DAE4	SN: 660	20-Apr-10 (No. DAE4-660_Apr10)	Apr-11
Secondary Standards	ID	Check Date (in house)	Scheduled Check
RF generator HP 8648C	US3642U01700	4-Aug-99 (in house check Oct-09)	In house check: Oct-11
Network Analyzer HP 8753E	US37390585	18-Oct-01 (in house check Oct-10)	In house check: Oct-11

Calibrated by:	Name Claudio Leubler	Function Laboratory Technician	Signature
Approved by:	Name Katja Pokovic	Function Technical Manager	Signature

Issued: February 15, 2011

This calibration certificate shall not be reproduced except in full without written approval of the laboratory.

FCC ID: ZNFA340	PCTEST ENGINEERING LABORATORY, INC.	HAC (RF EMISSIONS) TEST REPORT		Reviewed by: Quality Manager
Filename: 0Y1112192181.ZNF	Test Dates: 1/6/2012	EUT Type: Portable Handset		Page 50 of 80

**Calibration Laboratory of
Schmid & Partner
Engineering AG**
Zeughausstrasse 43, 8004 Zurich, Switzerland



S Schweizerischer Kalibrierdienst
C Service suisse d'étalonnage
S Servizio svizzero di taratura
Swiss Calibration Service

Accredited by the Swiss Accreditation Service (SAS)
The Swiss Accreditation Service is one of the signatories to the EA
Multilateral Agreement for the recognition of calibration certificates

Accreditation No.: **SCS 108**

Glossary:

NORM_{x,y,z} sensitivity in free space
DCP diode compression point
CF crest factor (1/duty_cycle) of the RF signal
A, B, C modulation dependent linearization parameters
Polarization α α rotation around probe axis
Polarization ϑ ϑ rotation around an axis that is in the plane normal to probe axis (at measurement center),
i.e., $\vartheta = 0$ is normal to probe axis
Connector Angle information used in DASY system to align probe sensor X to the robot coordinate system

Calibration is Performed According to the Following Standards:

- a) IEEE Std 1309-2005, "IEEE Standard for calibration of electromagnetic field sensors and probes, excluding antennas, from 9 kHz to 40 GHz", December 2005.

Methods Applied and Interpretation of Parameters:

- **NORM_{x,y,z}**: Assessed for E-field polarization $\vartheta = 0$ for XY sensors and $\vartheta = 90$ for Z sensor ($f \leq 900$ MHz in TEM-cell; $f > 1800$ MHz: R22 waveguide).
- **X,Y,Z(f)_a0a1a2**= X,Y,Z_a0a1a2* *frequency_response* (see Frequency Response Chart).
- **DCP_{x,y,z}**: DCP are numerical linearization parameters assessed based on the data of power sweep with CW signal (no uncertainty required). DCP does not depend on frequency nor media.
- **A_{x,y,z}; B_{x,y,z}; C_{x,y,z}; VR_{x,y,z}**: A, B, C are numerical linearization parameters assessed based on the data of power sweep for specific modulation signal. The parameters do not depend on frequency nor media. VR is the maximum calibration range expressed in RMS voltage across the diode.
- **Spherical isotropy (3D deviation from isotropy)**: in a locally homogeneous field realized using an open waveguide setup.
- **Sensor Offset**: The sensor offset corresponds to the offset of virtual measurement center from the probe tip (on probe axis). No tolerance required.
- **Connector Angle**: The angle is assessed using the information gained by determining the X_a0a1a2 (no uncertainty required).



FCC ID: ZNFA340	PCTEST INDUSTRIAL LABORATORY, INC.	HAC (RF EMISSIONS) TEST REPORT	LG	Reviewed by: Quality Manager
Filename: 0Y1112192181.ZNF	Test Dates: 1/6/2012	EUT Type: Portable Handset	Page 51 of 80	

Probe H3DV6

SN:6207

Manufactured: June 12, 2006
Calibrated: February 11, 2011

Calibrated for DASY/EASY Systems
(Note: non-compatible with DASY2 system!)

FCC ID: ZNFA340	 PCTEST <small>ENGINEERING LABORATORY, INC.</small>	HAC (RF EMISSIONS) TEST REPORT	 LG	Reviewed by: Quality Manager
Filename: 0Y1112192181.ZNF	Test Dates: 1/6/2012	EUT Type: Portable Handset	Page 52 of 80	

DASY/EASY - Parameters of Probe: H3DV6 - SN:6207**Basic Calibration Parameters**

		Sensor X	Sensor Y	Sensor Z	Unc (k=2)
Norm (A/m / $\sqrt{\text{mV}}$)	a0	2.42E-003	2.42E-003	2.93E-003	$\pm 5.1 \%$
Norm (A/m / $\sqrt{\text{mV}}$)	a1	1.92E-004	5.11E-004	1.84E-004	$\pm 5.1 \%$
Norm (A/m / $\sqrt{\text{mV}}$)	a2	1.48E-004	2.76E-004	1.41E-004	$\pm 5.1 \%$
DCP (mV) ^B		92.7	88.7	90.5	



Modulation Calibration Parameters

UID	Communication System Name	PAR		A dB	B dB	C dB	VR mV	Unc ^E (k=2)
10000	CW	0.00	X	0.00	0.00	1.00	228.9	$\pm 2.7 \%$
			Y	0.00	0.00	1.00	196.3	
			Z	0.00	0.00	1.00	215.6	

The reported uncertainty of measurement is stated as the standard uncertainty of measurement multiplied by the coverage factor $k=2$, which for a normal distribution corresponds to a coverage probability of approximately 95%.

^B Numerical linearization parameter: uncertainty not required.

^E Uncertainty is determined using the max. deviation from linear response applying rectangular distribution and is expressed for the square of the field value.

FCC ID: ZNFA340	 PCTEST ENGINEERING LABORATORY, INC.	HAC (RF EMISSIONS) TEST REPORT	 LG	Reviewed by: Quality Manager
Filename: 0Y1112192181.ZNF	Test Dates: 1/6/2012	EUT Type: Portable Handset	Page 53 of 80	

Frequency Response of H-Field (TEM-Cell:ifi110 EXX, Waveguide: R22)

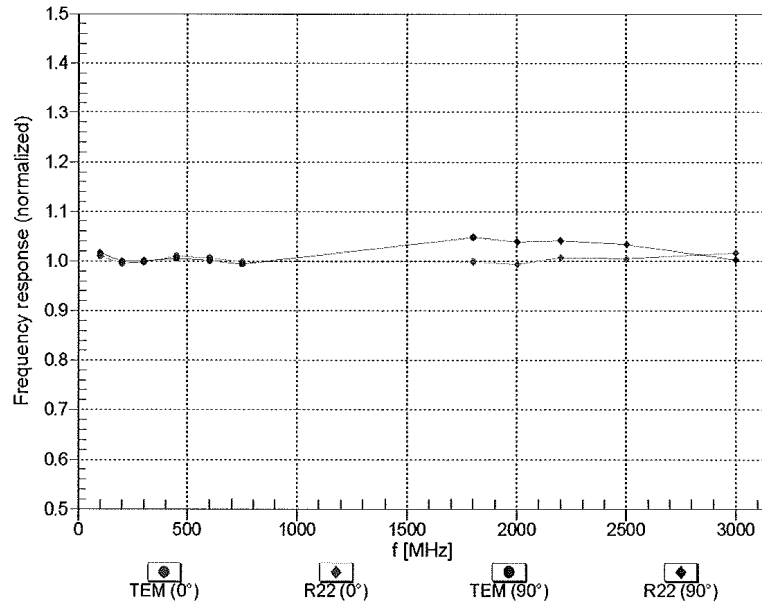

Uncertainty of Frequency Response of H-field: $\pm 6.3\%$ ($k=2$)

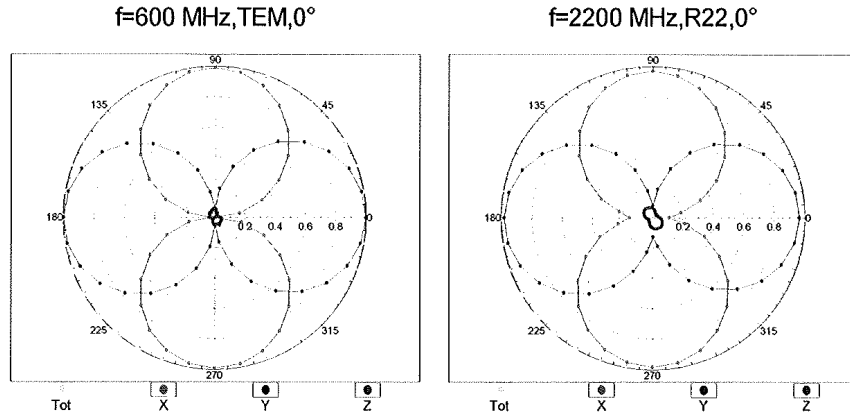

FCC ID: ZNFA340	PCTEST ENGINEERING LABORATORY, INC.	HAC (RF EMISSIONS) TEST REPORT	LG	Reviewed by: Quality Manager
Filename: 0Y1112192181.ZNF	Test Dates: 1/6/2012	EUT Type: Portable Handset		Page 54 of 80

Receiving Pattern (ϕ), $\theta = 0^\circ$

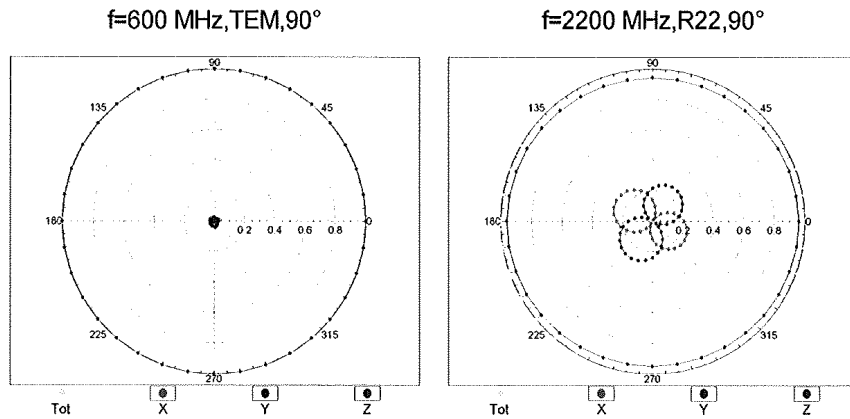

Receiving Pattern (ϕ), $\theta = 90^\circ$



<p>FCC ID: ZNFA340</p>		<p>HAC (RF EMISSIONS) TEST REPORT</p>	 <p>Reviewed by: Quality Manager</p>
<p>Filename: 0Y1112192181.ZNF</p>	<p>Test Dates: 1/6/2012</p>	<p>EUT Type: Portable Handset</p>	<p>Page 55 of 80</p>

Receiving Pattern (ϕ), $\vartheta = 0^\circ$

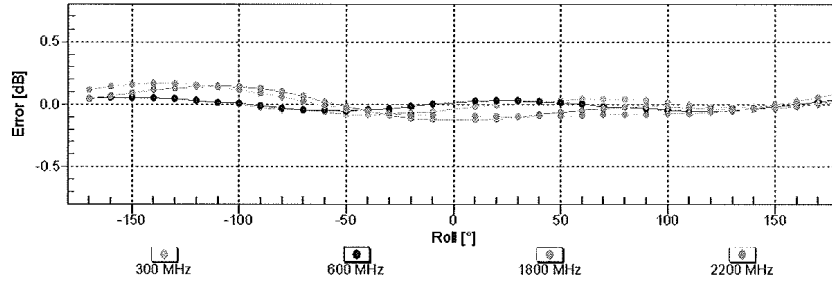

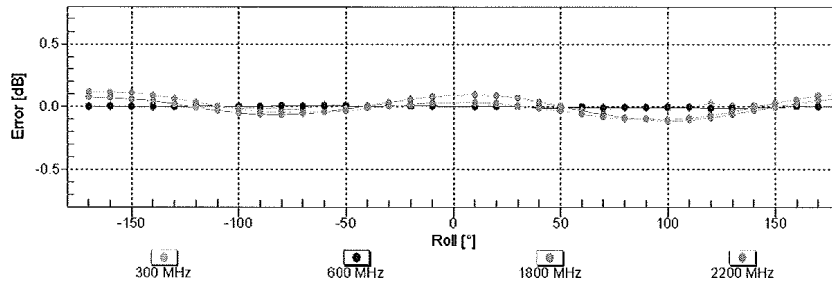

Uncertainty of Axial Isotropy Assessment: $\pm 0.5\%$ (k=2)

Receiving Pattern (ϕ), $\vartheta = 90^\circ$



Uncertainty of Axial Isotropy Assessment: $\pm 0.5\%$ (k=2)

<p>FCC ID: ZNFA340</p>		<p>HAC (RF EMISSIONS) TEST REPORT</p>	 <p>Reviewed by: Quality Manager</p>
<p>Filename: 0Y1112192181.ZNF</p>	<p>Test Dates: 1/6/2012</p>	<p>EUT Type: Portable Handset</p>	<p>Page 56 of 80</p>

Dynamic Range f(H-field) (TEM cell, f = 900 MHz)

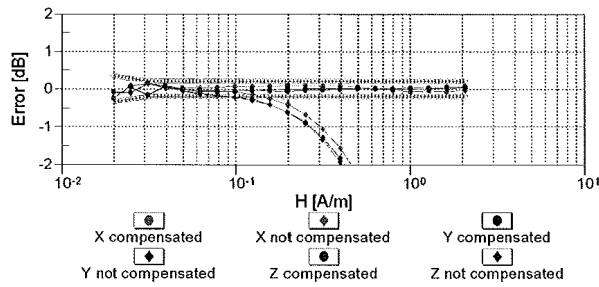
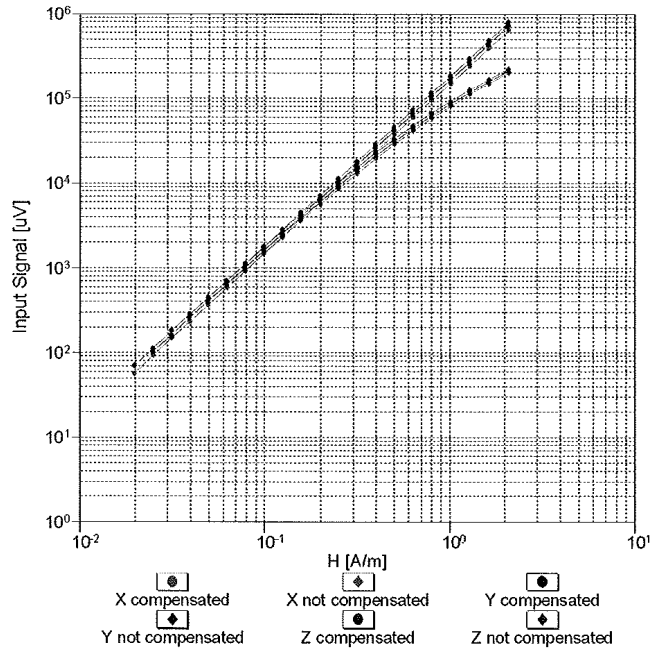

Uncertainty of Linearity Assessment: ± 0.6% (k=2)



FCC ID: ZNFA340	PCTEST ENGINEERING LABORATORY, INC.	HAC (RF EMISSIONS) TEST REPORT	LG	Reviewed by: Quality Manager
Filename: 0Y1112192181.ZNF	Test Dates: 1/6/2012	EUT Type: Portable Handset		Page 57 of 80

Deviation from Isotropy in Air

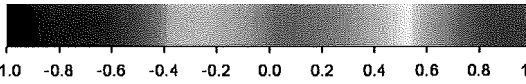
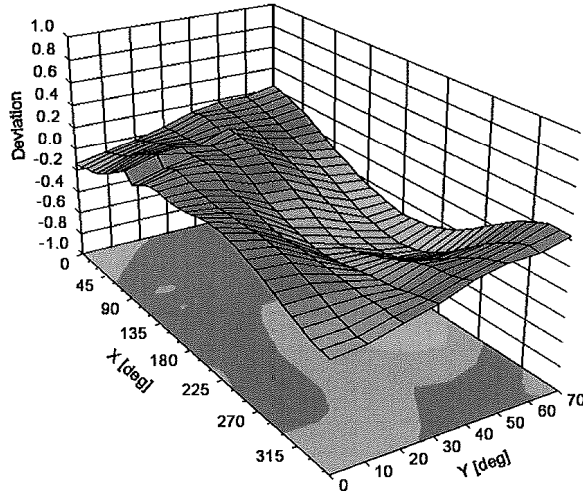
Error (ϕ , θ), $f = 900$ MHz





Uncertainty of Spherical Isotropy Assessment: $\pm 2.6\%$ ($k=2$)

<p>FCC ID: ZNFA340</p>		<p>HAC (RF EMISSIONS) TEST REPORT</p>	 <p>Reviewed by: Quality Manager</p>
<p>Filename: 0Y1112192181.ZNF</p>	<p>Test Dates: 1/6/2012</p>	<p>EUT Type: Portable Handset</p>	<p>Page 58 of 80</p>

DASY/EASY - Parameters of Probe: H3DV6 - SN:6207**Other Probe Parameters**

Sensor Arrangement	Rectangular
Connector Angle (°)	0
Mechanical Surface Detection Mode	enabled
Optical Surface Detection Mode	disabled
Probe Overall Length	337 mm
Probe Body Diameter	10 mm
Tip Length	20 mm
Tip Diameter	6 mm
Probe Tip to Sensor X Calibration Point	3 mm
Probe Tip to Sensor Y Calibration Point	3 mm
Probe Tip to Sensor Z Calibration Point	3 mm

FCC ID: ZNFA340	 PCTEST ENGINEERING LABORATORY, INC.	HAC (RF EMISSIONS) TEST REPORT	 LG	Reviewed by: Quality Manager
Filename: 0Y1112192181.ZNF	Test Dates: 1/6/2012	EUT Type: Portable Handset	Page 59 of 80	

**Calibration Laboratory of
Schmid & Partner
Engineering AG**
Zeughausstrasse 43, 8004 Zurich, Switzerland



S Schweizerischer Kalibrierdienst
S Service suisse d'étalonnage
S Servizio svizzero di taratura
S Swiss Calibration Service

Accredited by the Swiss Accreditation Service (SAS)
The Swiss Accreditation Service is one of the signatories to the EA
Multilateral Agreement for the recognition of calibration certificates

Accreditation No.: **SCS 108**

Client **PC Test**

Certificate No: **CD835V3-1003_Feb11**

CALIBRATION CERTIFICATE

Object **CD835V3 - SN: 1003**

Calibration procedure(s) **QA CAL-20.v5
Calibration procedure for dipoles in air**

Calibration date: **February 08, 2011**

*KoLC
2/22/11*

This calibration certificate documents the traceability to national standards, which realize the physical units of measurements (SI).
All calibrations have been conducted in the closed laboratory facility: environment temperature (22 ± 3)°C and humidity < 70%.

Calibration Equipment used (M&TE critical for calibration)

Primary Standards	ID #	Cal Date (Certificate No.)	Scheduled Calibration
Power meter EPM-442A	GB37480704	06-Oct-10 (No. 217-01266)	Oct-11
Power sensor HP 8481A	US37292783	06-Oct-10 (No. 217-01266)	Oct-11
Probe ER3DV6	SN: 2336	29-Dec-10 (No. ER3-2336_Dec10)	Dec-11
Probe H3DV6	SN: 6065	29-Dec-10 (No. H3-6065_Dec10)	Dec-11
DAE4	SN: 781	20-Oct-10 (No. DAE4-781_Oct10)	Oct-11
Secondary Standards	ID #	Check Date (in house)	Scheduled Check
Power meter Agilent 4419B	SN: GB42420191	09-Oct-09 (in house check Oct-10)	In house check: Oct-11
Power sensor HP 8482H	SN: 3318A09450	09-Oct-09 (in house check Oct-10)	In house check: Oct-11
Power sensor HP 8482A	SN: US37295597	09-Oct-09 (in house check Oct-10)	In house check: Oct-11
Network Analyzer HP 8753E	US37390585	18-Oct-01 (in house check Oct-10)	In house check: Oct-11
RF generator E4433B	MY 41000675	03-Nov-04 (in house check Oct-09)	In house check: Oct-11

Calibrated by:	Name	Function	Signature
	Claudio Leubler	Laboratory Technician	
Approved by:	Katja Pokovic	Technical Manager	

Issued: February 10, 2011

This calibration certificate shall not be reproduced except in full without written approval of the laboratory.

Certificate No: CD835V3-1003_Feb11

Page 1 of 6

FCC ID: ZNFA340	PCTEST ENGINEERING LABORATORY, INC.	HAC (RF EMISSIONS) TEST REPORT		Reviewed by: Quality Manager
Filename: 0Y1112192181.ZNF	Test Dates: 1/6/2012	EUT Type: Portable Handset		Page 60 of 80

**Calibration Laboratory of
Schmid & Partner
Engineering AG**
Zeughausstrasse 43, 8004 Zurich, Switzerland



S Schweizerischer Kalibrierdienst
C Service suisse d'étalonnage
S Servizio svizzero di taratura
S Swiss Calibration Service

Accredited by the Swiss Accreditation Service (SAS)
The Swiss Accreditation Service is one of the signatories to the EA
Multilateral Agreement for the recognition of calibration certificates

Accreditation No.: **SCS 108**

References

- [1] ANSI-C63.19-2006
American National Standard for Methods of Measurement of Compatibility between Wireless Communications Devices and Hearing Aids.
- [2] ANSI-C63.19-2007
American National Standard for Methods of Measurement of Compatibility between Wireless Communications Devices and Hearing Aids.

Methods Applied and Interpretation of Parameters:

- *Coordinate System:* y-axis is in the direction of the dipole arms. z-axis is from the basis of the antenna (mounted on the table) towards its feed point between the two dipole arms. x-axis is normal to the other axes. In coincidence with the standards [1, 2], the measurement planes (probe sensor center) are selected to be at a distance of 10 mm above the top edge of the dipole arms.
- *Measurement Conditions:* Further details are available from the hardcopies at the end of the certificate. All figures stated in the certificate are valid at the frequency indicated. The forward power to the dipole connector is set with a calibrated power meter connected and monitored with an auxiliary power meter connected to a directional coupler. While the dipole under test is connected, the forward power is adjusted to the same level.
- *Antenna Positioning:* The dipole is mounted on a HAC Test Arch phantom using the matching dipole positioner with the arms horizontal and the feeding cable coming from the floor. The measurements are performed in a shielded room with absorbers around the setup to reduce the reflections. It is verified before the mounting of the dipole under the Test Arch phantom, that its arms are perfectly in a line. It is installed on the HAC dipole positioner with its arms parallel below the dielectric reference wire and able to move elastically in vertical direction without changing its relative position to the top center of the Test Arch phantom. The vertical distance to the probe is adjusted after dipole mounting with a DASYS Surface Check job. Before the measurement, the distance between phantom surface and probe tip is verified. The proper measurement distance is selected by choosing the matching section of the HAC Test Arch phantom with the proper device reference point (upper surface of the dipole) and the matching grid reference point (tip of the probe) considering the probe sensor offset. The vertical distance to the probe is essential for the accuracy.
- *Feed Point Impedance and Return Loss:* These parameters are measured using a HP 8753E Vector Network Analyzer. The impedance is specified at the SMA connector of the dipole. The influence of reflections was eliminating by applying the averaging function while moving the dipole in the air, at least 70cm away from any obstacles.
- *E-field distribution:* E field is measured in the x-y-plane with an isotropic ER3D-field probe with 100 mW forward power to the antenna feed point. In accordance with [1, 2], the scan area is 20mm wide, its length exceeds the dipole arm length (180 or 90mm). The sensor center is 10 mm (in z) above the top of the dipole arms. Two 3D maxima are available near the end of the dipole arms. Assuming the dipole arms are perfectly in one line, the average of these two maxima (in subgrid 2 and subgrid 8) is determined to compensate for any non-parallelity to the measurement plane as well as the sensor displacement. The E-field value stated as calibration value represents the maximum of the interpolated 3D-E-field, 10mm above the dipole surface.
- *H-field distribution:* H-field is measured with an isotropic H-field probe with 100mW forward power to the antenna feed point, in the x-y-plane. The scan area and sensor distance is equivalent to the E-field scan. The maximum of the field is available at the center (subgrid 5) above the feed point. The H-field value stated as calibration value represents the maximum of the interpolated H-field, 10mm above the dipole surface at the feed point.

FCC ID: ZNFA340	PCTEST ENGINEERING LABORATORY, INC.	HAC (RF EMISSIONS) TEST REPORT	LG	Reviewed by: Quality Manager
Filename: OY1112192181.ZNF	Test Dates: 1/6/2012	EUT Type: Portable Handset		Page 61 of 80

1 Measurement Conditions

DASY system configuration, as far as not given on page 1.

DASY Version	DASY5	V52.6.1 (408)
DASY PP Version	SEMCAD X	V14.4.2 (2595)
Phantom	HAC Test Arch	SD HAC P01 BA, #1070
Distance Dipole Top - Probe Center	10 mm	
Scan resolution	dx, dy = 5 mm	area = 20 x 180 mm
Frequency	835 MHz ± 1 MHz	
Forward power at dipole connector	20.0 dBm = 100mW	
Input power drift	< 0.05 dB	

2 Maximum Field values

H-field 10 mm above dipole surface	condition	interpolated maximum
Maximum measured	100 mW forward power	0.458 A/m

Uncertainty for H-field measurement: 8.2% (k=2)

E-field 10 mm above dipole surface	condition	Interpolated maximum
Maximum measured above high end-	100 mW forward power	170.7 V/m
Maximum measured above low end	100 mW forward power	161.3 V/m
Averaged maximum above arm	100 mW forward power	166.0 V/m

Uncertainty for E-field measurement: 12.8% (k=2)

3 Appendix

3.1 Antenna Parameters

Frequency	Return Loss	Impedance
800 MHz	16.6 dB	(41.9 – j11.1) Ohm
835 MHz	24.1 dB	(48.2 + j5.9) Ohm
900 MHz	16.5 dB	(58.5 – j14.0) Ohm
950 MHz	17.9 dB	(49.3 + j12.8) Ohm
960 MHz	12.9 dB	(62.2 + j22.8) Ohm



3.2 Antenna Design and Handling

The calibration dipole has a symmetric geometry with a built-in two stub matching network, which leads to the enhanced bandwidth.

The dipole is built of standard semirigid coaxial cable. The internal matching line is open ended. The antenna is therefore open for DC signals.

Do not apply force to dipole arms, as they are liable to bend. The soldered connections near the feedpoint may be damaged. After excessive mechanical stress or overheating, check the impedance characteristics to ensure that the internal matching network is not affected.

After long term use with 40W radiated power, only a slight warming of the dipole near the feedpoint can be measured.

FCC ID: ZNFA340	 PCTEST ENGINEERING LABORATORY, INC.	HAC (RF EMISSIONS) TEST REPORT	 LG	Reviewed by: Quality Manager
Filename: 0Y1112192181.ZNF	Test Dates: 1/6/2012	EUT Type: Portable Handset	Page 62 of 80	

3.3 Measurement Sheets

3.3.1 Return Loss and Smith Chart

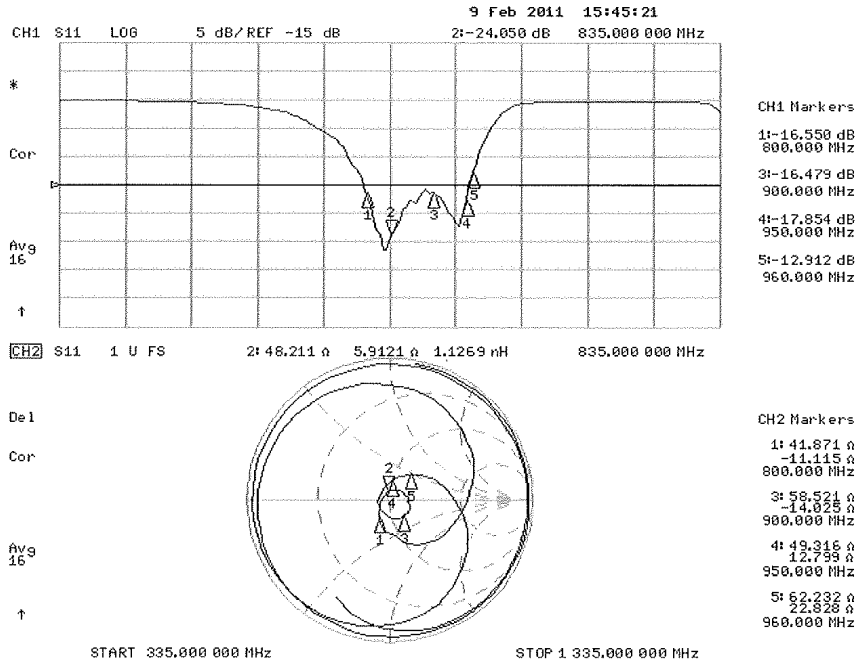

FCC ID: ZNFA340	PCTEST ENGINEERING LABORATORY, INC.	HAC (RF EMISSIONS) TEST REPORT	LG	Reviewed by: Quality Manager
Filename: 0Y1112192181.ZNF	Test Dates: 1/6/2012	EUT Type: Portable Handset	Page 63 of 80	

3.3.3 DASY4 H-field Result

Date/Time: 08.02.2011 13:00:11

Test Laboratory: SPEAG Lab2

HAC RF_CD835_1003_H_110208_CL

DUT: HAC-Dipole 835 MHz; Type: CD835V3; Serial: 1003

Communication System: CW; Frequency: 835 MHz
 Medium parameters used: $\sigma = 0$ mho/m, $\epsilon_r = 1$; $\rho = 1$ kg/m³
 Phantom section: RF Section
 Measurement Standard: DASY5 (IEEE/IEC/ANSI C63.19-2007)

DASY5 Configuration:

- Probe: H3DV6 - SN6065; ; Calibrated: 29.12.2010
- Sensor-Surface: (Fix Surface)
- Electronics: DAE4 Sn781; Calibrated: 20.10.2010
- Phantom: HAC Test Arch with AMCC; Type: SD HAC P01 BA; Serial: 1070
- Measurement SW: DASY52, V52.6.1 Build (408)
- Postprocessing SW: SEMCAD X, V14.4.2 Build (2595)

Dipole H-Field measurement @ 835MHz/H Scan - measurement distance from the probe sensor center to CD835

Dipole = 10mm/Hearing Aid Compatibility Test (41x361x1):

Measurement grid: dx=5mm, dy=5mm

Maximum value of peak Total field = 0.458 A/m

Probe Modulation Factor = 1.000

Device Reference Point: 0, 0, -6.3 mm



Reference Value = 0.488 A/m; Power Drift = -0.0088 dB

Hearing Aid Near-Field Category: M4 (AWF 0 dB)

Peak H-field in A/m

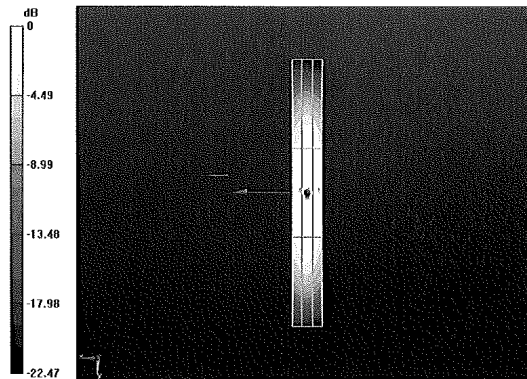
Grid 1 0.376 M4	Grid 2 0.398 M4	Grid 3 0.379 M4
Grid 4 0.435 M4	Grid 5 0.458 M4	Grid 6 0.434 M4
Grid 7 0.388 M4	Grid 8 0.407 M4	Grid 9 0.381 M4



FCC ID: ZNFA340	 PCTEST ENGINEERING LABORATORY, INC.	HAC (RF EMISSIONS) TEST REPORT	 LG	Reviewed by: Quality Manager
Filename: 0Y1112192181.ZNF	Test Dates: 1/6/2012	EUT Type: Portable Handset	Page 64 of 80	

3.3.2 DASY4 E-field Result

Date/Time: 08.02.2011 13:58:56

Test Laboratory: SPEAG Lab2

HAC RF_CD835_1003_E_110208_CL

DUT: HAC-Dipole 835 MHz; Type: CD835V3; Serial: 1003

Communication System: CW; Frequency: 835 MHz

Medium parameters used: $\sigma = 0$ mho/m, $\epsilon_r = 1$; $\rho = 1000$ kg/m³

Phantom section: RF Section

Measurement Standard: DASY5 (IEEE/IEC/ANSI C63.19-2007)

DASY5 Configuration:

- Probe: ER3DV6 - SN2336; ConvF(1, 1, 1); Calibrated: 29.12.2010
- Sensor-Surface: (Fix Surface)
- Electronics: DAE4 Sn781; Calibrated: 20.10.2010
- Phantom: HAC Test Arch with AMCC; Type: SD HAC P01 BA; Serial: 1070
- Measurement SW: DASY52, V52.6.1 Build (408)
- Postprocessing SW: SEMCAD X, V14.4.2 Build (2595)

Dipole E-Field measurement @ 835MHz/E Scan - measurement distance from the probe sensor center to CD835

Dipole = 10mm/Hearing Aid Compatibility Test (41x361x1):

Measurement grid: dx=5mm, dy=5mm

Maximum value of peak Total field = 170.7 V/m

Probe Modulation Factor = 1.000

Device Reference Point: 0, 0, -6.3 mm

Reference Value = 123.4 V/m; Power Drift = 0.02 dB



Hearing Aid Near-Field Category: M4 (AWF 0 dB)

Peak E-field in V/m

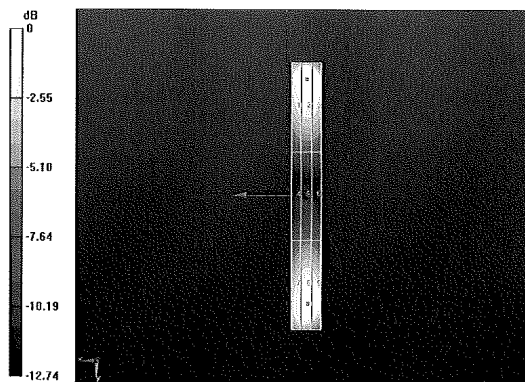
Grid 1 164.3 M4	Grid 2 170.7 M4	Grid 3 164.5 M4
Grid 4 85.8 M4	Grid 5 90.5 M4	Grid 6 88.8 M4
Grid 7 152.9 M4	Grid 8 161.3 M4	Grid 9 158.3 M4



0 dB = 170.7V/m

FCC ID: ZNFA340	 PCTEST ENGINEERING LABORATORY, INC.	HAC (RF EMISSIONS) TEST REPORT		Reviewed by: Quality Manager
Filename: 0Y1112192181.ZNF	Test Dates: 1/6/2012	EUT Type: Portable Handset		Page 65 of 80

**Calibration Laboratory of
Schmid & Partner
Engineering AG**
Zeughausstrasse 43, 8004 Zurich, Switzerland



S Schweizerischer Kalibrierdienst
C Service suisse d'étalonnage
S Servizio svizzero di taratura
S Swiss Calibration Service

Accredited by the Swiss Accreditation Service (SAS)
The Swiss Accreditation Service is one of the signatories to the EA
Multilateral Agreement for the recognition of calibration certificates

Accreditation No.: **SCS 108**

Client **PC Test**

Certificate No: **CD1880V3-1137_Feb11/2**

CALIBRATION CERTIFICATE (Replacement of No: CD1880V3-1137_Feb11)

Object **CD1880V3 - SN: 1137**

Calibration procedure(s) **QA CAL-20.v5
Calibration procedure for dipoles in air**

Calibration date: **February 09, 2011**

*✓
Kok
2/24/11*

This calibration certificate documents the traceability to national standards, which realize the physical units of measurements (SI).
All calibrations have been conducted in the closed laboratory facility: environment temperature (22 ± 3)°C and humidity < 70%.

Calibration Equipment used (M&TE critical for calibration)

Primary Standards	ID #	Cal Date (Certificate No.)	Scheduled Calibration
Power meter EPM-442A	GB37480704	06-Oct-10 (No. 217-01266)	Oct-11
Power sensor HP 8481A	US37292783	06-Oct-10 (No. 217-01266)	Oct-11
Probe ER3DV6	SN: 2336	29-Dec-10 (No. ER3-2336_Dec10)	Dec-11
Probe H3DV6	SN: 6065	29-Dec-10 (No. H3-6065_Dec10)	Dec-11
DAE4	SN: 781	20-Oct-10 (No. DAE4-781_Oct10)	Oct-11
Secondary Standards	ID #	Check Date (in house)	Scheduled Check
Power meter Agilent 4419B	SN: GB42420191	09-Oct-09 (in house check Oct-10)	In house check: Oct-11
Power sensor HP 8482H	SN: 3318A09450	09-Oct-09 (in house check Oct-10)	In house check: Oct-11
Power sensor HP 8482A	SN: US37295597	09-Oct-09 (in house check Oct-10)	In house check: Oct-11
Network Analyzer HP 8753E	US37390585	18-Oct-01 (in house check Oct-10)	In house check: Oct-11
RF generator E4433B	MY 41000675	03-Nov-04 (in house check Oct-09)	In house check: Oct-11

Calibrated by: **Name: Claudio Leubler, Function: Laboratory Technician**

Signature

Approved by: **Name: Katja Pokovic, Function: Technical Manager**

Signature

Issued: February 23, 2011

This calibration certificate shall not be reproduced except in full without written approval of the laboratory.

FCC ID: ZNFA340	PCTEST ENGINEERING LABORATORY, INC.	HAC (RF EMISSIONS) TEST REPORT		Reviewed by: Quality Manager
Filename: 0Y1112192181.ZNF	Test Dates: 1/6/2012	EUT Type: Portable Handset		Page 66 of 80

**Calibration Laboratory of
Schmid & Partner
Engineering AG**
Zeughausstrasse 43, 8004 Zurich, Switzerland



S Schweizerischer Kalibrierdienst
C Service suisse d'étalonnage
S Servizio svizzero di taratura
S Swiss Calibration Service

Accredited by the Swiss Accreditation Service (SAS)
The Swiss Accreditation Service is one of the signatories to the EA
Multilateral Agreement for the recognition of calibration certificates

Accreditation No.: **SCS 108**

References

- [1] ANSI-C63.19-2007
American National Standard for Methods of Measurement of Compatibility between Wireless Communications Devices and Hearing Aids.

Methods Applied and Interpretation of Parameters:

- *Coordinate System:* y-axis is in the direction of the dipole arms. z-axis is from the basis of the antenna (mounted on the table) towards its feed point between the two dipole arms. x-axis is normal to the other axes. In coincidence with the standards [1], the measurement planes (probe sensor center) are selected to be at a distance of 10 mm above the top edge of the dipole arms.
- *Measurement Conditions:* Further details are available from the hardcopies at the end of the certificate. All figures stated in the certificate are valid at the frequency indicated. The forward power to the dipole connector is set with a calibrated power meter connected and monitored with an auxiliary power meter connected to a directional coupler. While the dipole under test is connected, the forward power is adjusted to the same level.
- *Antenna Positioning:* The dipole is mounted on a HAC Test Arch phantom using the matching dipole positioner with the arms horizontal and the feeding cable coming from the floor. The measurements are performed in a shielded room with absorbers around the setup to reduce the reflections. It is verified before the mounting of the dipole under the Test Arch phantom, that its arms are perfectly in a line. It is installed on the HAC dipole positioner with its arms parallel below the dielectric reference wire and able to move elastically in vertical direction without changing its relative position to the top center of the Test Arch phantom. The vertical distance to the probe is adjusted after dipole mounting with a DASY5 Surface Check job. Before the measurement, the distance between phantom surface and probe tip is verified. The proper measurement distance is selected by choosing the matching section of the HAC Test Arch phantom with the proper device reference point (upper surface of the dipole) and the matching grid reference point (tip of the probe) considering the probe sensor offset. The vertical distance to the probe is essential for the accuracy.
- *Feed Point Impedance and Return Loss:* These parameters are measured using a HP 8753E Vector Network Analyzer. The impedance is specified at the SMA connector of the dipole. The influence of reflections was eliminated by applying the averaging function while moving the dipole in the air, at least 70cm away from any obstacles.
- *E-field distribution:* E field is measured in the x-y-plane with an isotropic ER3D-field probe with 100 mW forward power to the antenna feed point. In accordance with [1], the scan area is 20mm wide, its length exceeds the dipole arm length (180 or 90mm). The sensor center is 10 mm (in z) above the top of the dipole arms. Two 3D maxima are available near the end of the dipole arms. Assuming the dipole arms are perfectly in one line, the average of these two maxima (in subgrid 2 and subgrid 8) is determined to compensate for any non-parallelity to the measurement plane as well as the sensor displacement. The E-field value stated as calibration value represents the maximum of the interpolated 3D-E-field, 10mm above the dipole surface.
- *H-field distribution:* H-field is measured with an isotropic H-field probe with 100mW forward power to the antenna feed point, in the x-y-plane. The scan area and sensor distance is equivalent to the E-field scan. The maximum of the field is available at the center (subgrid 5) above the feed point. The H-field value stated as calibration value represents the maximum of the interpolated H-field, 10mm above the dipole surface at the feed point.

FCC ID: ZNFA340	PCTEST ENGINEERING LABORATORY, INC.	HAC (RF EMISSIONS) TEST REPORT	LG	Reviewed by: Quality Manager
Filename: 0Y1112192181.ZNF	Test Dates: 1/6/2012	EUT Type: Portable Handset	Page 67 of 80	

1. Measurement Conditions

DASY system configuration, as far as not given on page 1.

DASY Version	DASY5	V52.6.1 (408)
DASY PP Version	SEMCAD X	V14.4.2 (2595)
Phantom	HAC Test Arch	SD HAC P01 BA, #1070
Distance Dipole Top - Probe Center	10 mm	
Scan resolution	dx, dy = 5 mm	area = 20 x 90 mm
Frequency	1880 MHz ± 1 MHz	
Forward power at dipole connector	20.0 dBm = 100mW	
Input power drift	< 0.05 dB	

2. Maximum Field values

H-field 10 mm above dipole surface	condition	Interpolated maximum
Maximum measured	100 mW forward power	0.460 A/m

Uncertainty for H-field measurement: 8.2% (k=2)

E-field 10 mm above dipole surface	condition	Interpolated maximum
Maximum measured above high end	100 mW forward power	139.0 V/m
Maximum measured above low end	100 mW forward power	134.5 V/m
Averaged maximum above arm	100 mW forward power	136.8 V/m

Uncertainty for E-field measurement: 12.8% (k=2)

3. Appendix

3.1 Antenna Parameters

Frequency	Return Loss	Impedance
1730 MHz	23.0 dB	(49.6 + j7.1) Ohm
1880 MHz	21.2 dB	(51.1 + j8.7) Ohm
1900 MHz	21.8 dB	(53.3 + j7.7) Ohm
1950 MHz	28.1 dB	(54.1 – j0.2) Ohm
2000 MHz	20.5 dB	(41.4 – j0.8) Ohm



3.2 Antenna Design and Handling

The calibration dipole has a symmetric geometry with a built-in two stub matching network, which leads to the enhanced bandwidth.

The dipole is built of standard semirigid coaxial cable. The internal matching line is open ended. The antenna is therefore open for DC signals.

Do not apply force to dipole arms, as they are liable to bend. The soldered connections near the feedpoint may be damaged. After excessive mechanical stress or overheating, check the impedance characteristics to ensure that the internal matching network is not affected.

After long term use with 40W radiated power, only a slight warming of the dipole near the feedpoint can be measured.

FCC ID: ZNFA340	 PCTEST ENGINEERING LABORATORY, INC.	HAC (RF EMISSIONS) TEST REPORT	 LG	Reviewed by: Quality Manager
Filename: 0Y1112192181.ZNF	Test Dates: 1/6/2012	EUT Type: Portable Handset	Page 68 of 80	

3.3 Measurement Sheets

3.3.1 Return Loss and Smith Chart

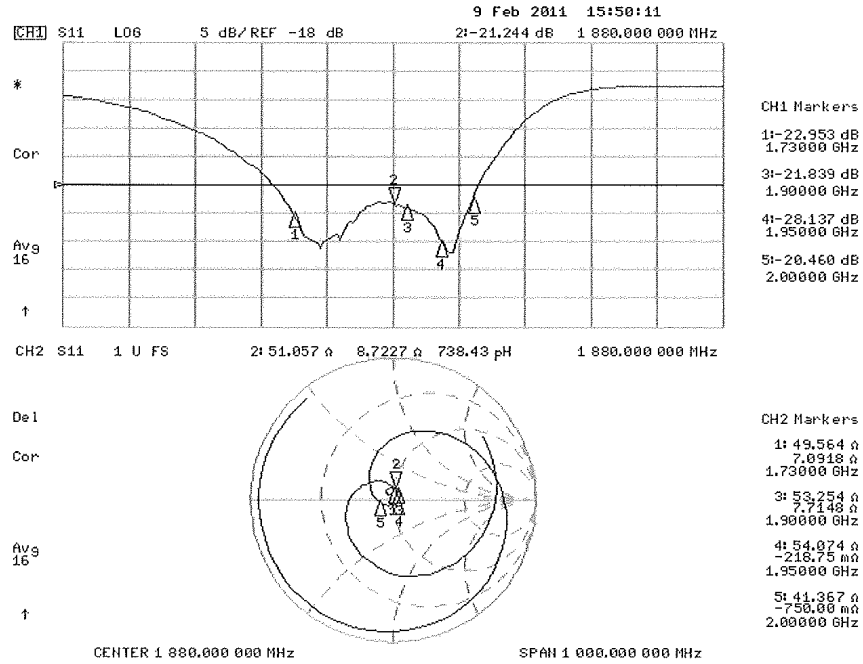

FCC ID: ZNFA340	PCTEST ENGINEERING LABORATORY, INC.	HAC (RF EMISSIONS) TEST REPORT	LG	Reviewed by: Quality Manager
Filename: 0Y1112192181.ZNF	Test Dates: 1/6/2012	EUT Type: Portable Handset	Page 69 of 80	

3.3.2 DASY4 H-Field Result

Date/Time: 09.02.2011 11:34:28

Test Laboratory: SPEAG Lab2

HAC_RF_CD1880_1137_H_110208_CL

DUT: HAC Dipole 1880 MHz; Type: CD1880V3; Serial: 1137

Communication System: CW; Frequency: 1880 MHz

Medium parameters used: $\sigma = 0$ mho/m, $\epsilon_r = 1$; $\rho = 1$ kg/m³

Phantom section: RF Section

Measurement Standard: DASY5 (IEEE/IEC/ANSI C63.19-2007)

DASY5 Configuration:

- Probe: H3DV6 - SN6065; ; Calibrated: 29.12.2010
- Sensor-Surface: (Fix Surface)
- Electronics: DAE4 Sn781; Calibrated: 20.10.2010
- Phantom: HAC Test Arch with AMCC; Type: SD HAC P01 BA; Serial: 1070
- Measurement SW: DASY52, V52.6.1 Build (408)
- Postprocessing SW: SEMCAD X, V14.4.2 Build (2595)

Dipole H-Field measurement @ 1880MHz/H Scan - measurement distance from the probe sensor center to CD1880

Dipole = 10mm/Hearing Aid Compatibility Test (41x181x1):

Measurement grid: dx=5mm, dy=5mm

Maximum value of peak Total field = 0.460 A/m

Probe Modulation Factor = 1.000

Device Reference Point: 0, 0, -6.3 mm

Reference Value = 0.487 A/m; Power Drift = 0.0057 dB



Hearing Aid Near-Field Category: M2 (AWF 0 dB)

Peak H-field in A/m

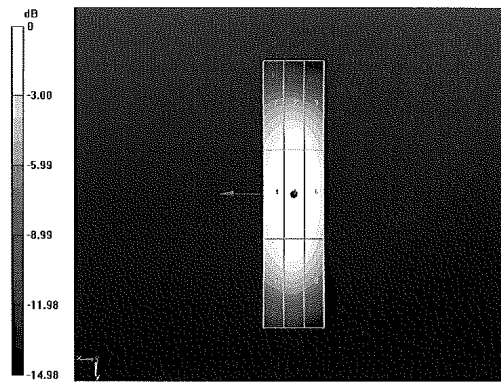
Grid 1 0.401 M2	Grid 2 0.418 M2	Grid 3 0.396 M2
Grid 4 0.443 M2	Grid 5 0.460 M2	Grid 6 0.435 M2
Grid 7 0.409 M2	Grid 8 0.426 M2	Grid 9 0.399 M2



0 dB = 0.460A/m

FCC ID: ZNFA340	 PCTEST ENGINEERING LABORATORY, INC.	HAC (RF EMISSIONS) TEST REPORT	 LG	Reviewed by: Quality Manager
Filename: 0Y1112192181.ZNF	Test Dates: 1/6/2012	EUT Type: Portable Handset	Page 70 of 80	

3.3.3 DASY4 E-Field Result

Date/Time: 08.02.2011 16:54:42

Test Laboratory: SPEAG Lab2

HAC_RF_CD1880_1137_E_110208_CL

DUT: HAC Dipole 1880 MHz; Type: CD1880V3; Serial: 1137

Communication System: CW; Frequency: 1880 MHz

Medium parameters used: $\sigma = 0$ mho/m, $\epsilon_r = 1$; $\rho = 1000$ kg/m³

Phantom section: RF Section

Measurement Standard: DASY5 (IEEE/IEC/ANSI C63.19-2007)

DASY5 Configuration:

- Probe: ER3DV6 - SN2336; ConvF(1, 1, 1); Calibrated: 29.12.2010
- Sensor-Surface: (Fix Surface)
- Electronics: DAE4 Sn781; Calibrated: 20.10.2010
- Phantom: HAC Test Arch with AMCC; Type: SD HAC P01 BA; Serial: 1070
- Measurement SW: DASY52, V52.6.1 Build (408)
- Postprocessing SW: SEMCAD X, V14.4.2 Build (2595)

Dipole E-Field measurement @ 1880MHz/E Scan - measurement distance from the probe sensor center to CD1880

Dipole = 10mm/Hearing Aid Compatibility Test (41x181x1):

Measurement grid: dx=5mm, dy=5mm

Maximum value of peak Total field = 139.0 V/m

Probe Modulation Factor = 1.000

Device Reference Point: 0, 0, -6.3 mm

Reference Value = 138.8 V/m; Power Drift = -0.05 dB



Hearing Aid Near-Field Category: M2 (AWF 0 dB)

Peak E-field in V/m

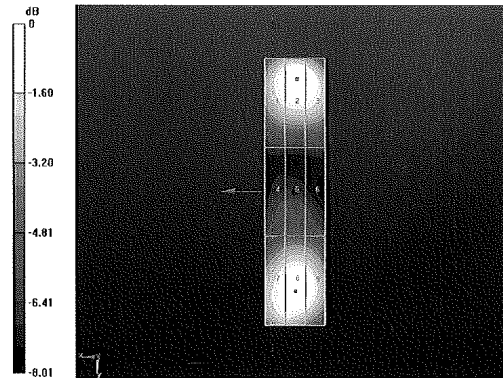
Grid 1 131.8 M2	Grid 2 139.0 M2	Grid 3 135.0 M2
Grid 4 84.076 M3	Grid 5 87.648 M3	Grid 6 85.767 M3
Grid 7 131.1 M2	Grid 8 134.5 M2	Grid 9 130.5 M2



0 dB = 139.0V/m

FCC ID: ZNFA340	 PCTEST ENGINEERING LABORATORY, INC.	HAC (RF EMISSIONS) TEST REPORT	 LG	Reviewed by: Quality Manager
Filename: 0Y1112192181.ZNF	Test Dates: 1/6/2012	EUT Type: Portable Handset	Page 71 of 80	

4. Additional Measurements

4.1 Measurement Conditions

DASY system configuration, as far as not given on page 1.

DASY Version	DASY5	V52.6.1 (408)
DASY PP Version	SEMCAD X	V14.4.2 (2595)
Phantom	HAC Test Arch	SD HAC P01 BA, #1070
Distance Dipole Top - Probe Center	10 mm	
Scan resolution	dx, dy = 5 mm	area = 20 x 90 mm
Frequency	1730 MHz ± 1 MHz	
Forward power at dipole connector	20.0 dBm = 100mW	
Input power drift	< 0.05 dB	



4.1.1 Maximum Field values

H-field 10 mm above dipole surface	condition	interpolated maximum
Maximum measured	100 mW forward power	0.489 A/m

Uncertainty for H-field measurement: 8.2% (k=2)

E-field 10 mm above dipole surface	condition	Interpolated maximum
Maximum measured above high end	100 mW forward power	152.7 V/m
Maximum measured above low end	100 mW forward power	150.2 V/m
Averaged maximum above arm	100 mW forward power	151.5 V/m

Uncertainty for E-field measurement: 12.8% (k=2)

FCC ID: ZNFA340	 PCTEST ENGINEERING LABORATORY, INC.	HAC (RF EMISSIONS) TEST REPORT	 LG	Reviewed by: Quality Manager
Filename: 0Y1112192181.ZNF	Test Dates: 1/6/2012	EUT Type: Portable Handset	Page 72 of 80	

4.1.2 DASY4 H-field result

Date/Time: 09.02.2011 11:27:03

Test Laboratory: SPEAG Lab2

HAC_RF_CD1880_1137_H_1730_110208_CL

DUT: HAC Dipole 1880 MHz; Type: CD1880V3; Serial: 1137

Communication System: CW; Frequency: 1730 MHz

Medium parameters used: $\sigma = 0$ mho/m, $\epsilon_r = 1$; $\rho = 1$ kg/m³

Phantom section: RF Section

Measurement Standard: DASY5 (IEE/IEC/ANSI C63.19-2007)

DASY5 Configuration:

- Probe: H3DV6 - SN6065; ; Calibrated: 29.12.2010
- Sensor-Surface: (Fix Surface)
- Electronics: DAE4 Sn781; Calibrated: 20.10.2010
- Phantom: HAC Test Arch with AMCC; Type: SD HAC P01 BA; Serial: 1070
- Measurement SW: DASY52, V52.6.1 Build (408)
- Postprocessing SW: SEMCAD X, V14.4.2 Build (2595)

Dipole H-Field measurement @ 1880MHz/H Scan - measurement distance from the probe sensor center to CD1880

Dipole = 10mm @ 1730 MHz/Hearing Aid Compatibility Test (41x181x1):

Measurement grid: dx=5mm, dy=5mm

Maximum value of peak Total field = 0.489 A/m

Probe Modulation Factor = 1.000

Device Reference Point: 0, 0, -6.3 mm

Reference Value = 0.519 A/m; Power Drift = 0.02 dB



Hearing Aid Near-Field Category: M2 (AWF 0 dB)

Peak H-field in A/m

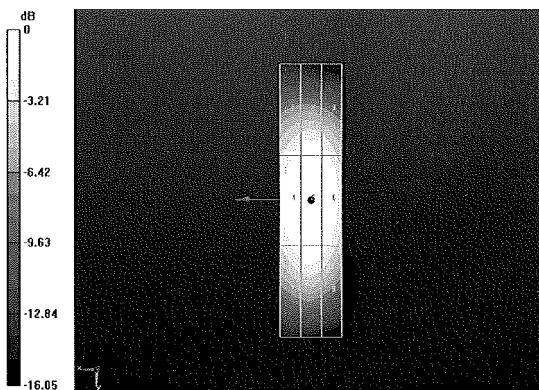
Grid 1 0.407 M2	Grid 2 0.424 M2	Grid 3 0.403 M2
Grid 4 0.467 M2	Grid 5 0.489 M2	Grid 6 0.462 M2
Grid 7 0.418 M2	Grid 8 0.437 M2	Grid 9 0.409 M2



0 dB = 0.490A/m

FCC ID: ZNFA340	 PCTEST ENGINEERING LABORATORY, INC.	HAC (RF EMISSIONS) TEST REPORT	 LG	Reviewed by: Quality Manager
Filename: 0Y1112192181.ZNF	Test Dates: 1/6/2012	EUT Type: Portable Handset	Page 73 of 80	

4.1.3 DASYS4 E-field result

Date/Time: 08.02.2011 16:26:13

Test Laboratory: SPEAG Lab2

HAC_RF_CD1880_1137_E_1730_110208_CL

DUT: HAC Dipole 1880 MHz; Type: CD1880V3; Serial: 1137

Communication System: CW; Frequency: 1730 MHz

Medium parameters used: $\sigma = 0$ mho/m, $\epsilon_r = 1$; $\rho = 1000$ kg/m³

Phantom section: RF Section

Measurement Standard: DASYS5 (IEEE/IEC/ANSI C63.19-2007)

DASYS5 Configuration:

- Probe: ER3DV6 - SN2336; ConvF(1, 1, 1); Calibrated: 29.12.2010
- Sensor-Surface: (Fix Surface)
- Electronics: DAE4 Sn781; Calibrated: 20.10.2010
- Phantom: HAC Test Arch with AMCC; Type: SD HAC P01 BA; Serial: 1070
- Measurement SW: DASYS2, V52.6.1 Build (408)
- Postprocessing SW: SEMCAD X, V14.4.2 Build (2595)

Dipole E-Field measurement @ 1880MHz/E Scan - measurement distance from the probe sensor center to CD1880

Dipole = 10mm @ 1730 MHz/Hearing Aid Compatibility Test (41x181x1):

Measurement grid: dx=5mm, dy=5mm

Maximum value of peak Total field = 152.7 V/m

Probe Modulation Factor = 1.000

Device Reference Point: 0, 0, -6.3 mm

Reference Value = 156.8 V/m; Power Drift = 0.0092 dB

Hearing Aid Near-Field Category: M2 (AWF 0 dB)

Peak E-field in V/m

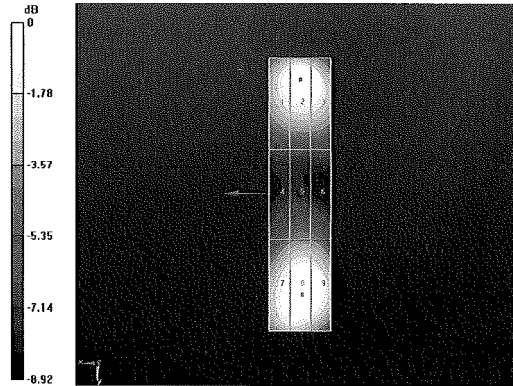

Grid 1 143.8 M2	Grid 2 150.2 M2	Grid 3 144.8 M2
Grid 4 97.621 M3	Grid 5 103.8 M3	Grid 6 102.2 M3
Grid 7 145.9 M2	Grid 8 152.7 M2	Grid 9 149.2 M2



0 dB = 152.7V/m

Certificate No: CD1880V3-1137_Feb11/2



Page 9 of 9

FCC ID: ZNFA340	 PCTEST ENGINEERING LABORATORY, INC.	HAC (RF EMISSIONS) TEST REPORT		Reviewed by: Quality Manager
Filename: 0Y1112192181.ZNF	Test Dates: 1/6/2012	EUT Type: Portable Handset	Page 74 of 80	

15. CONCLUSION



The measurements indicate that the wireless communications device complies with the HAC limits specified in accordance with the ANSI C63.19 Standard and FCC WT Docket No. 01-309 RM-8658. Precise laboratory measures were taken to assure repeatability of the tests. The tested device complies with the requirements in respect to all parameters specific to the test. The test results and statements relate only to the item(s) tested.

Please note that the M-rating for this equipment only represents the field interference possible against a hypothetical and typical hearing aid. The measurement system and techniques presented in this evaluation are proposed in the ANSI standard as a means of best approximating wireless device compatibility with a hearing-aid. The literature is under continual re-construction.



FCC ID: ZNFA340	 PCTEST ENGINEERING LABORATORY, INC.	HAC (RF EMISSIONS) TEST REPORT	 LG	Reviewed by: Quality Manager
Filename: 0Y1112192181.ZNF	Test Dates: 1/6/2012	EUT Type: Portable Handset	Page 75 of 80	

16. REFERENCES

1. ANSI/IEEE C63.19-2007, American National Standard for Methods of Measurement of Compatibility between Wireless Communication Devices and Hearing Aids.", New York, NY, IEEE, June 2007
2. FCC Public Notice DA 06-1215, *Wireless Telecommunications Bureau and Office of Engineering and Technology Clarify Use of Revised Wireless Phone Hearing Aid Compatibility Standard*, June 6, 2006
3. Berger, H. S., "Compatibility Between Hearing Aids and Wireless Devices," Electronic Industries Forum, Boston, MA, May, 1997
4. Berger, H. S., "Hearing Aid and Cellular Phone Compatibility: Working Toward Solutions," *Wireless Telephones and Hearing Aids: New Challenges for Audiology*, Gallaudet University, Washington, D.C., May, 1997 (To be reprinted in the American Journal of Audiology).
5. Berger, H. S., "Hearing Aid Compatibility with Wireless Communications Devices," IEEE International Symposium on Electromagnetic Compatibility, Austin, TX, August, 1997.
6. Bronaugh, E. L., "Simplifying EMI Immunity (Susceptibility) Tests in TEM Cells," in the 1990 IEEE International Symposium on Electromagnetic Compatibility Symposium Record, Washington, D.C., August 1990, pp. 488-491
7. Byrne, D. and Dillon, H., The National Acoustics Laboratory (NAL) New Procedure for Selecting the Gain and Frequency Response of a Hearing Aid, *Ear and Hearing* 7:257-265, 1986.
8. Crawford, M. L., "Measurement of Electromagnetic Radiation from Electronic Equipment using TEM Transmission Cells," U.S. Department of Commerce, National Bureau of Standards, NBSIR 73-306, Feb. 1973.
9. Crawford, M. L., and Workman, J. L., "Using a TEM Cell for EMC Measurements of Electronic Equipment," U.S. Department of Commerce, National Bureau of Standards. Technical Note 1013, July 1981.
10. EHIMA GSM Project, Development phase, Project Report (1st part) Revision A. Technical-Audiological Laboratory and Telecom Denmark, October 1993.
11. EHIMA GSM Project, Development phase, Part II Project Report. Technical-Audiological Laboratory and Telecom Denmark, June 1994.
12. EHIMA GSM Project Final Report, Hearing Aids and GSM Mobile Telephones: Interference Problems, Methods of Measurement and Levels of Immunity. Technical-Audiological Laboratory and Telecom Denmark, 1995.
13. HAMPIS Report, Comparison of Mobile phone electromagnetic near field with an upscaled electromagnetic far field, using hearing aid as reference, 21 October 1999.
14. Hearing Aids/GSM, Report from OTWIDAM, Technical-Audiological Laboratory and Telecom Denmark, April 1993.

FCC ID: ZNFA340	 PCTEST ENGINEERING LABORATORY, INC.	HAC (RF EMISSIONS) TEST REPORT	 LG	Reviewed by: Quality Manager
Filename: OY1112192181.ZNF	Test Dates: 1/6/2012	EUT Type: Portable Handset		Page 76 of 80

15. IEEE 100, The Authoritative Dictionary of IEEE Standards Terms, Seventh Edition.
16. Joyner, K. H., et. al., Interference to Hearing Aids by the New Digital Mobile Telephone System, Global System for Mobile (GSM) Communication Standard, National Acoustic Laboratory, Australian Hearing Series, Sydney 1993.
17. Joyner, K. H., et. al., Interference to Hearing Aids by the Digital Mobile Telephone System, Global System for Mobile Communications (GSM), NAL Report #131, National Acoustic Laboratory, Australian Hearing Series, Sydney, 1995.
18. Kecker, W. T., Crawford, M. L., and Wilson, W. A., "Construction of a Transverse Electromagnetic Cell", U.S. Department of Commerce, National Bureau of Standards, Technical Note 1011, Nov. 1978.
19. Konigstein, D., and Hansen, D., "A New Family of TEM Cells with enlarged bandwidth and Optimized working Volume," in the Proceedings of the 7th International Symposium on EMC, Zurich, Switzerland, March 1987; 50:9, pp. 127-132.
20. Kuk, F., and Hjordstgaard, N. K., "Factors affecting interference from digital cellular telephones," Hearing Journal, 1997; 50:9, pp 32-34.
21. Ma, M. A., and Kanda, M., "Electromagnetic Compatibility and Interference Metrology," U.S. Department of Commerce, National Bureau of Standards, Technical Note 1099, July 1986, pp. 17-43.
22. Ma, M. A., Sreenivashiah, I. , and Chang, D. C., "A Method of Determining the Emission and Susceptibility Levels of Electrically Small Objects Using a TEM Cell," U.S. Department of Commerce, National Bureau of Standards, Technial Note 1040, July 1981.
23. McCandless, G. A., and Lyregaard, P. E., Prescription of Gain/Output (POGO) for Hearing Aids, Hearing Instruments 1:16-21, 1983
24. Skopec, M., "Hearing Aid Electromagnetic Interference from Digital Wireless Telephones, "IEEE Transactions on Rehabilitation Engineering, vol. 6, no. 2, pp. 235-239, June 1998.
25. Technical Report, GSM 05.90, GSM EMC Considerations, European Telecommunications Standards Institute, January 1993.
26. Victorian, T. A., "Digital Cellular Telephone Interference and Hearing Aid Compatibility—an Update," Hearing Journal 1998; 51:10, pp. 53-60
27. Wong, G. S. K., and Embleton, T. F. W., eds., AIP Handbook of Condenser Microphones: Theory, Calibration and Measurements, AIP Press.

FCC ID: ZNFA340	 PCTEST ENGINEERING LABORATORY, INC.	HAC (RF EMISSIONS) TEST REPORT	 LG	Reviewed by: Quality Manager
Filename: 0Y1112192181.ZNF	Test Dates: 1/6/2012	EUT Type: Portable Handset	Page 77 of 80	